

Mainboard User's Manual

This publication, including all photographs, illustrations and software, is protected under international copyright laws, with all rights reserved. Neither this manual, nor any of the material contained herein, may be reproduced without the express written consent of the manufacturer.

The information in this document is subject to change without notice. The manufacturer makes no representations or warranties with respect to the contents hereof and specifically disclaims any implied warranties of merchantability or fitness for any particular purpose. Further, the manufacturer reserves the right to revise this publication and to make changes from time to time in the content hereof without obligation of the manufacturer to notify any person of such revision or changes.

Trademarks

IBM, VGA, and PS/2 are registered trademarks of International Business Machines.

Intel, Pentium/II/III, MMX, and Celeron are registered trademarks of Intel Corporation.

Microsoft, MS-DOS and Windows 95/98/NT/2000/XP are registered trademarks of Microsoft Corporation.

PC-cillin is a trademark of Trend Micro Inc.

Award is a trademark of Award Software Inc.

Other names used in this publication may be trademarks and are acknowledged.

**Copyright © 2003
All Rights Reserved
8601a Series, V1.3
V133X/August 2003**

Mainboard User's Manual

Notice:

Owing to Microsoft's certifying schedule is various to every supplier, we might have some drivers not certified yet by Microsoft. Therefore, it might happen under Windows XP that a dialogue box (shown as below) pop out warning you this software has not passed Windows Logo testing to verify its compatibility with Windows XP. Please rest assured that our RD department has already tested and verified these drivers. Just click the "Continue Anyway" button and go ahead the installation.



Mainboard User's Manual

Table of Contents

Trademarks	I
Chapter 1: Introduction.....	1
Key Features	2
Package Contents.....	5
Static Electricity Precautions.....	6
Pre-Installation Inspection.....	6
Chapter 2: Mainboard Installation.....	7
Mainboard Components	8
I/O Ports.....	8
Install Memory	8
Setting Jumper Switches.....	10
Install the Mainboard.....	12
Optional Extension Brackets	13
Install Other Devices	14
Expansion Slots	17
Chapter 3: BIOS Setup Utility.....	19
Introduction	19
Running the Setup Utility	20
Standard CMOS Features Page	21
Advanced BIOS Features Page.....	22
Advanced Chipset Features Page	24
Integrated Peripherals Page	26
Power Management Setup Page	29
PnP/PCI Configurations Page.....	31
Hardware Monitor Page.....	32
Frequency/Voltage Control Page.....	33
Load BestPerf. Defaults.....	33
Load Optimized Defaults.....	34
Set Password.....	34
Save & Exit Setup	34
Exit Without Saving	34
Chapter 4: Software & Applications	35
Introduction	35
Installing Support Software	36
Bundled Software Installation	38

Mainboard User's Manual

Chapter 1

Introduction

This mainboard has onboard VIA Samuel2 **1.2Giga Pro** processor with front-side bus speeds of **133MHz**.

This mainboard uses the **VIA VT133** chipset, and integrates a **3D Graphics Accelerator** and **Ultra DMA 33/66/100** (VT82C686B chip only) function. The mainboard has a built-in **AC97 Codec**, provides an **AMR** (Audio Modem Riser) slot to support Audio and Modem application, and has a built-in **10BaseT/100BaseTX Network Interface**. In addition, the mainboard has an extended set of **ATX I/O Ports** including PS/2 keyboard and mouse ports, two USB ports, a parallel port, a VGA port, a serial port, a game port and audio ports. An extra USB header gives you the option of connecting two more USB ports.

This mainboard has all the features you need to develop a powerful multimedia workstation. The board is **Micro ATX** size and has a power connector for an **ATX** power supply.

Mainboard User's Manual

Key Features

The key features of this mainboard include:

C3 Pro Processor

- ◆ Built-in VIA C3 Samuel2 **1.2Giga Pro** CPU
- ◆ Supports up to 133MHz Front-Side Bus

Memory Support

- ◆ Two DIMM slots for 168-pin SDRAM memory modules
- ◆ Support for 100/133 MHz memory bus
- ◆ Maximum installed memory is 2 x 512MB = 1GB

Expansion Slots

- ◆ One AMR slot for a special audio/modem riser card
- ◆ Three 32-bit PCI slots for PCI 2.2-compliant bus interface.
- ◆ One 8/16-bit ISA slot.

Onboard IDE channels

- ◆ Primary and Secondary PCI IDE channels
- ◆ Support for PIO modes, Bus Mastering and Ultra DMA 33/66/100 (optional VT82C686B) modes

Power Supply and Power Management

- ◆ ATX power supply connector
- ◆ ACPI and previous PMU support, suspend switch
- ◆ Supports Wake on LAN and Wake on Alarm

Built-in Graphics System

- ◆ Onboard **64-bit 2D/3D** graphic engine and Video Accelerator with advanced DVD video
- ◆ 2 to 8 MB frame buffer use system memory
- ◆ Supports high resolutions up to 1600x1200

1: Introduction

AC97 Codec

- ◆ Compliant AC97 2.1 specification
- ◆ Supports 18-bit ADC (Analog Digital Converter) and DAC (Digital Analog Converter) as well as 18-bit stereo full-duplex codec

Built-in Ethernet LAN (optional)

- ◆ **10BaseT/100BaseTX Ethernet LAN**
- ◆ LAN controller integrates Fast Ethernet MAC and PHY compliant with IEEE802.3u 100BASE-TX, 10BASE-T and ANSI X3.263 TP-PMD standards
- ◆ Compliant with ACPI 1.0 and the Network Device Class Power Management 1.0
- ◆ High Performance provided by 100Mbps clock generator and data recovery circuit for 100Mbps receiver

Onboard I/O Ports

- ◆ Provides PC99 Color Connectors for easy peripheral device connections
- ◆ Floppy disk drive connector with 1Mb/s transfer rate
- ◆ One serial ports with 16550-compatible fast UART
- ◆ One parallel port with ECP and EPP support
- ◆ Two USB ports, and optional two USB ports module
- ◆ Two PS/2 ports for keyboard and mouse
- ◆ One infrared port connector for optional module

Hardware Monitoring

- ◆ Built-in hardware monitoring for CPU & System temperatures, fan speeds and mainboard voltages

Onboard Flash ROM

- ◆ Automatic board configuration support Plug and Play of peripheral devices and expansion cards

Mainboard User's Manual

Bundled Software

- ◆ **PC-Cillin2002** provides automatic virus protection under Windows 98/ME/NT/2000/XP
- ◆ **Adobe Acrobat Reader V5.0** is the software to help users read .PDF files.

Dimensions

- ◆ Micro ATX form factor (24.4cm x 19cm)

1: Introduction

Package Contents

Your mainboard package ships with the following items:

- The mainboard
- This User's Guide
- 1 UDMA/66 IDE cable
- 1 Floppy disk drive cable
- Support software on CD-ROM disk

Optional Accessories

You can purchase the following optional accessories for this mainboard.

- Extended USB module
- AMR Fax/Modem card

Mainboard User's Manual

Static Electricity Precautions

Components on this mainboard can be damaged by static electricity. Take the following precautions when unpacking the mainboard and installing it in a system.

1. Keep the mainboard and other components in their original static-proof packaging until you are ready to install them.
2. During installation, wear a grounded wrist strap if possible. If you don't have a wrist strap, discharge static electricity by touching the bare metal of the system chassis.
3. Handle the mainboard carefully by the edges. Avoid touching the components unless it is absolutely necessary. During installation put the mainboard on top of the static-protection packaging it came in with the component side facing up.

Pre-Installation Inspection

1. Inspect the mainboard for damage to the components and connectors on the board.
2. If you suspect that the mainboard has been damaged, do not connect power to the system. Contact your mainboard vendor and report the damage.

Chapter 2

Mainboard Installation

To install this mainboard in a system, follow the procedures in this chapter:

Identify the mainboard components
Install one or more system memory modules
Verify that any jumpers or switches are set correctly
Install the mainboard in a system chassis (case)
Connect any extension brackets or cables to the mainboard connector headers
Install any peripheral devices and make the appropriate connections to connectors on the mainboard

Note:

1. Before installing this mainboard, make sure the jumper JBAT1 is set to Normal setting. See this chapter for information on locating JBAT1 and the setting options.
2. Never connect power to the system during installation. Doing so may damage the mainboard.

Mainboard User's Manual

Mainboard Components

Use the diagram below to identify the major components on the mainboard.

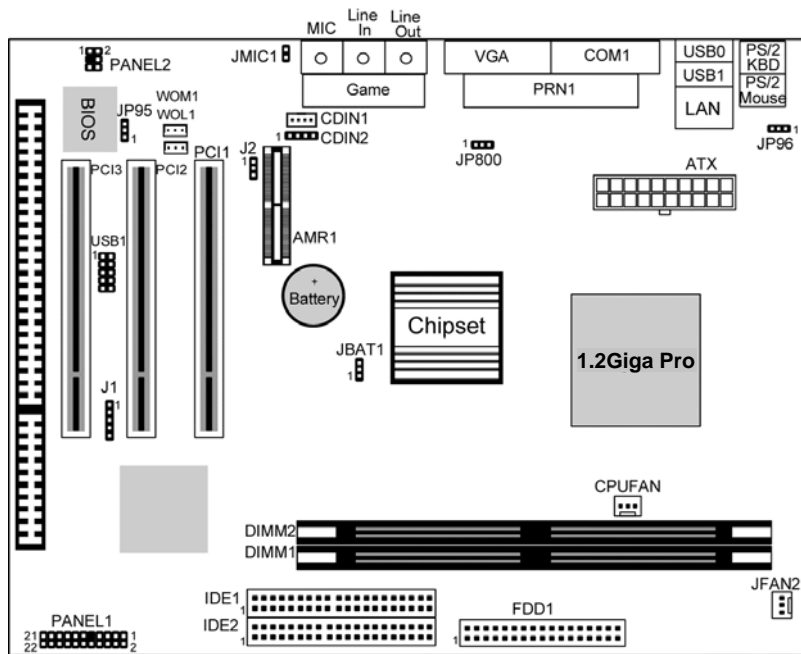

Install Memory

The mainboard has two DIMM sockets for system memory modules. You must install at least one memory module in order to use the mainboard.

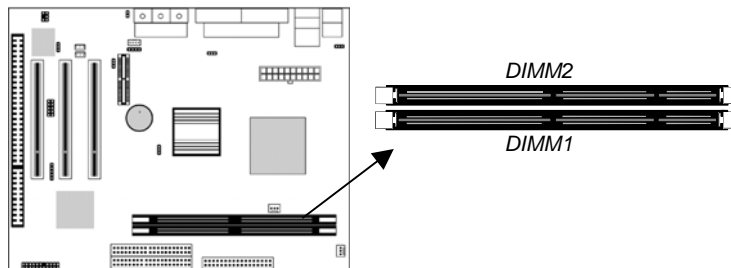

2: Mainboard Installation

For this mainboard, you must use 168-pin, 3.3V unbuffered PC100 or PC133 SDRAM memory modules. You can install any size memory module from 32 MB to 512 MB, so the maximum memory size is $2 \times 512 \text{ MB} = 1 \text{ GB}$.

The edge connectors on the memory modules have cut outs, which coincide with spacers in the DIMM sockets so that memory modules can only be installed in the correct orientation.

To install a module, push the retaining latches at either end of the socket outwards. Position the memory module correctly and insert it into the DIMM socket. Press the module down into the socket so that the retaining latches rotate up and secure the module in place by fitting into notches on the edge of the module.

Mainboard User's Manual

Setting Jumper Switches

Jumpers are sets of pins which can be connected together with jumper caps. The jumper caps change the way the mainboard operates by changing the electronic circuits on the mainboard. If a jumper cap connects two pins, we say the pins are **SHORT**. If a jumper cap is removed from two pins, the pins are **OPEN**.

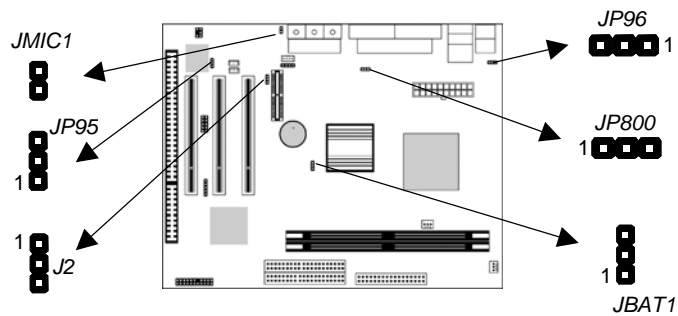

Jumper JBAT1: Clear CMOS Memory

Use this jumper to clear the contents of the CMOS memory. You may need to clear the CMOS memory if the settings in the Setup Utility are incorrect and prevent your mainboard from operating. To clear the CMOS memory, disconnect all the power cables from the mainboard and then move the jumper cap into the **CLEAR** setting for a few seconds.

Function	Jumper Setting
Normal Operation	Short Pins 1-2
Clear CMOS Memory	Short Pins 2-3

Jumper J2: Codec Selector

Use this jumper to select the onboard audio codec or Audio Modem Riser (AMR) slot.

Function	Jumper Setting
Primary codec onboard	Short Pins 1-2
Primary Codec on AMR slot	Short Pins 2-3

2: Mainboard Installation

Jumper JP95: BIOS Write Protect Selector

Use this jumper to make the BIOS read-only.

Function	Jumper Setting
Enable (read only)	Short Pins 1-2
Disable	Short Pins 2-3

Jumper JP96: Keyboard Power On Selector

If you enable the keyboard power on feature, you can use hot keys on your keyboard as a power on/off switch for the system.

Note: The system must provide 1A on the +5VSB (+5V Standby) signal before using the Keyboard Power On function.

Function	Jumper Setting
Disable Keyboard Power On	Short Pins 1-2
Enable Keyboard Power On	Short Pins 2-3

Jumper JP800: Enable/Disable Onboard LAN

The mainboard has a built-in 10BaseT/100BaseTX network adapter. If you plan on using an alternative network adapter, you must use this 3-pin jumper to disable the onboard network adapter.

Function	Jumper Setting
Disable Onboard LAN	Short Pins 1-2
Enable Onboard LAN	Short Pins 2-3

Jumper JM1C1: Microphone Type Selector

Use this jumper to select the microphone type that passive one or the active one input audio to the sound system.

Function	Jumper Setting
Passive Microphone	Short Pins 1-2
Active Microphone	Open Pins 1-2

Mainboard User's Manual

Install the Mainboard

Install the mainboard in a system chassis (case). The board is a micro ATX size mainboard with a twin-tier of I/O ports. Ensure that your case has an I/O cover plate that matches the ports on this mainboard.

Install the mainboard in a case. Follow the instructions provided by the case manufacturer using the hardware and internal mounting points on the chassis.

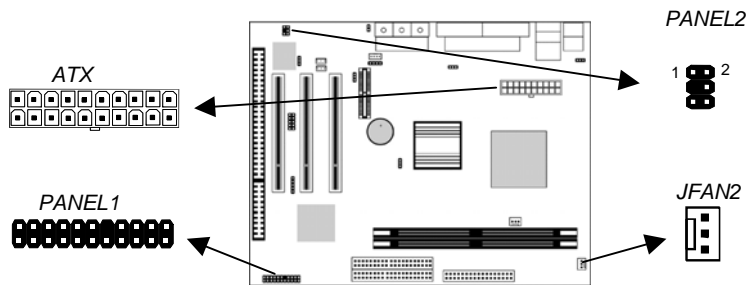

Connect the power connector from the power supply to the **ATX** connector on the mainboard.

If there is a cooling fan installed in the system chassis, connect the cable from the cooling fan to the **JFAN2** fan power connector on the mainboard.

If there are a microphone-in jack and/or a speaker-out jack on the front panel, connect the cables from the microphone-in and speaker-out jacks to the **PANEL2** header on the mainboard. Then set the jumper **JMIC1** to *open* setting.

Pin	Signal	Pin	Signal
1	LINEOUT-L	2	MICIN
3	KEY	4	GND
5	LINEOUT-R	6	MICP

2: Mainboard Installation

Connect the case switches and indicator LEDs to the **PANEL1** switch and LED connector header. See the illustration below for a guide to the header pin assignments.

Pin	Signal	Pin	Signal
1	SPEAKER	2	POWER LED
3	SPEAKER	4	POWER LED
5	SPEAKER	6	POWER LED
7	SPEAKER	8	KEYLOCK
9	KEY	10	KEYLOCK
11	KEY	12	KEY
13	KEY	14	KEY
15	HDD LED	16	HDD LED
17	RESET	18	RESET
19	SUSPEND LED	20	SUSPEND LED
21	POWER BUTTON	22	POWER BUTTON

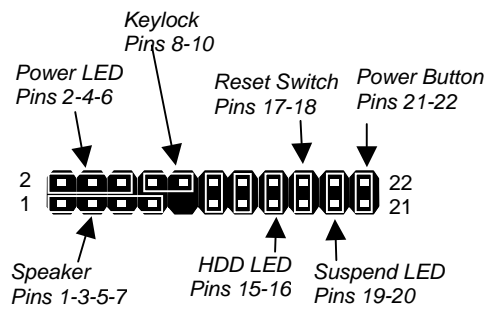

Optional Extension Brackets

For this mainboard, you can also obtain a USB module extension bracket. Install them by following the steps below.

Extended USB Module

This module bracket has two USB ports for more USB devices (USB port 3-4).

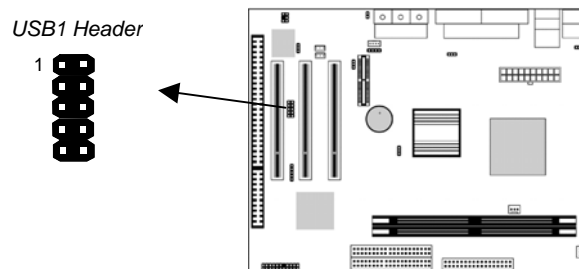

Mainboard User's Manual

USB1

Pin	Signal	Pin	Signal
1	VCC	2	GND
3	NC	4	UV+
5	UV-	6	UV-
7	UV+	8	NC
9	GND	10	VCC

1. Locate the USB1 header on the mainboard.
2. Plug the bracket cable onto the header.
3. In the system chassis, remove a slot cover from one of the expansion slots and install the extension bracket in the opening. Use the screw that held the slot cover in place to secure the extension bracket to the chassis.

Install Other Devices

Install and connect any other devices in the system following the steps below.

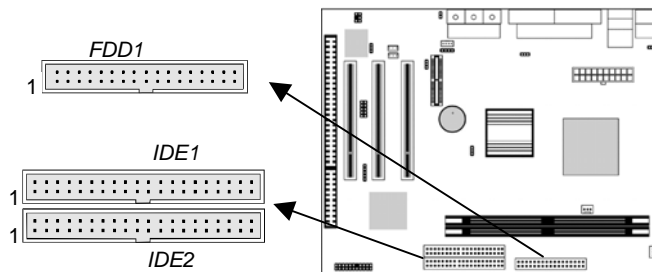

Floppy Disk Drive

The mainboard ships with a floppy disk drive cable that can support one or two drives. Drives can be 3.5" or 5.25" wide, with capacities of 360K, 720K, 1.2MB, 1.44MB, or 2.88MB.

Install your drives and connect power from the system power supply. Use the cable provided to connect the drives to the floppy disk drive header **FDD1**.

2: Mainboard Installation

IDE Devices

IDE devices include hard disk drives, high-density diskette drives, and CD-ROM or DVD-ROM drives, among others.

The mainboard ships with an IDE cable that can support one or two IDE devices. If you connect two devices to a single cable, you must configure one of the drives as Master and one of the drives as Slave. The documentation of the IDE device will tell you how to configure the device as a Master or Slave device. The Master device connects to the end of the cable.

Install the device(s) and connect power from the system power supply. Use the cable provided to connect the device(s) to the Primary IDE channel connector **IDE1** on the mainboard.

If you want to install more IDE devices, you can purchase a second IDE cable and connect one or two devices to the Secondary IDE channel connector **IDE2** on the mainboard. If you have two devices on the cable, one must be Master and one must be Slave.

Internal Sound Connections

If you have installed a CD-ROM drive or DVD-ROM drive, you can connect the drive audio cable to the onboard sound system.

On the mainboard, locate the two 4-pin connectors CDIN1 and CDIN2. There are two kinds of connector because different brands of CD-ROM drive have different kinds of audio cable connectors.

Connect the cable to the appropriate connector.

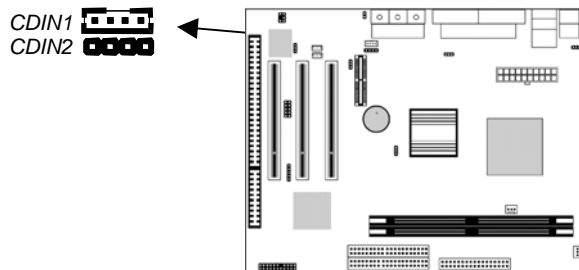

Mainboard User's Manual

CDIN1

Pin	Signal
1	CD IN L
2	GND
3	GND
4	CD IN R

CDIN2

Pin	Signal
1	GND
2	CD IN R
3	GND
4	CD IN L

Infrared Port

You can connect an infrared port to the mainboard. You can purchase this option from third-party vendors.

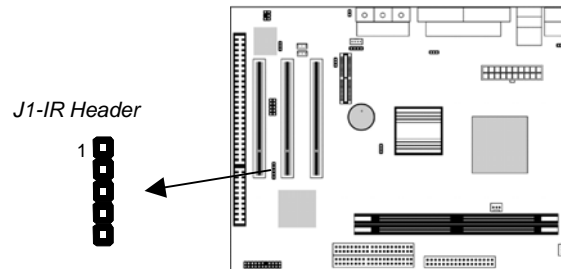

Pin	Signal	Pin	Signal
1	VCC	2	NC
3	IRRX	4	GND
5	IRTX		

1. Locate the infrared port IR header on the mainboard.
2. If you are adding an infrared port, connect the ribbon cable from the port to the header and then secure the port to an appropriate place in your system chassis.

2: Mainboard Installation

Expansion Slots

This mainboard has three 32-bit PCI expansion slots, one AMR slot and one 8/16-bit ISA slot.

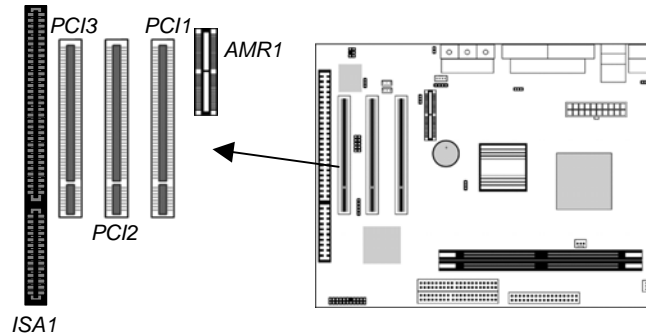

Follow the steps below to install a PCI/AMR/ISA expansion card.

1. Locate the AMR, PCI or ISA slots on the mainboard.
2. Remove the slot cover for this slot from the system chassis.
3. Insert the expansion card edge connector into the slot and press it firmly down into it so that it is fully inserted.
4. Secure the expansion card bracket to the system chassis using the screw that held the slot cover in place.

AMR Slot

The AMR (Audio Modem Riser) slot is an industry standard slot that allows for the installation of a special audio/modem riser card. Different territories have different regulations regarding the specifications of a modem card. You can purchase an AMR card that is approved in your area and install it directly into the AMR slot.

Wake On Modem (WOM)

You can configure your system so that it powers down by software and can be resumed by alarms. If you have installed a fax/modem card, connect the fax/modem to the Wake On Modem header **WOM1**. You can then use the setup utility to program your computer to resume from a power saving mode whenever there is an incoming call to the fax/modem.

Mainboard User's Manual

Wake On LAN (WOL)

If you have installed a LAN adapter expansion card, connect the card to the Wake On LAN connector **WOL1**. This allows incoming traffic to resume the system from a software power down. You need to enable this feature in the system setup utility.

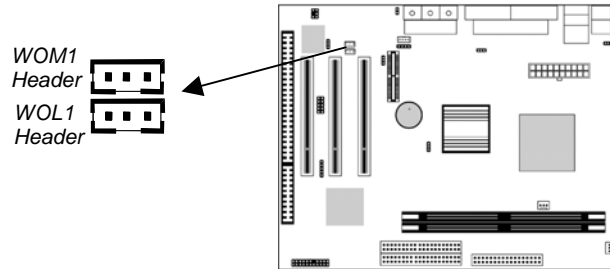

Pin	Signal
1	5VSB
2	GND
3	-RING

Chapter 3

BIOS Setup Utility

Introduction

The BIOS Setup Utility records settings and information about your computer such as the date and time, the kind of hardware installed, and various configuration settings. Your computer uses this information to initialize all the components when booting up and functions as the basis for coordination between system components.

If the Setup Utility configuration is incorrect, it may cause the system to malfunction. It can even stop your computer from booting properly. If this happens, you can use the clear CMOS jumper to clear the CMOS memory used to store the configuration information, or you can hold down the **Page Up** key while you reboot your computer. Holding down the **Page Up** key also clears the setup information.

You can run the setup utility and manually make changes to the configuration. You might need to do this to configure some of the hardware that you install on or connect to the mainboard, such as the CPU, system memory, disk drives, etc.

Mainboard User's Manual

Running the Setup Utility

Each time your computer starts, before the operating system loads, a message appears on the screen that prompts you to “*Press to enter SETUP*”. When you see this message, press the **Delete** key and the Main menu page of the Setup Utility appears on your monitor.

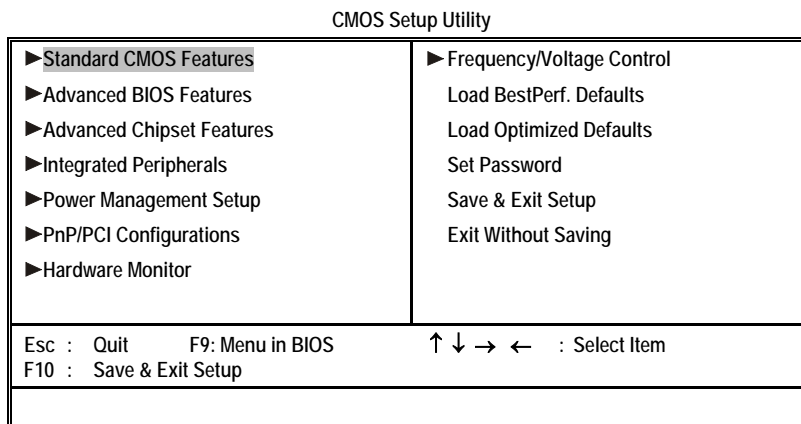

Listed below are explanations of the keys displayed at the bottom of the screens:

Key	Function
Esc	Escape key: Exits the current menu
← ↓ ↑ →	Cursor keys: Scroll through the items on a menu
+/-/PU/P	Plus, minus, Page Up and Page Down keys:
D	Modify the selected field's values
F10	F10 key: Saves the current configuration and exits setup
F1	F1 key: Displays a screen that explains all key functions
F5	F5 key: Loads previously saved values to CMOS
F6	F6 key: Loads a best performance configuration for the normal system.
F7	F7 key: Loads an optimum set of values for peak performance

3: BIOS Setup Utility

Standard CMOS Features Page

Use this page to set basic information such as the date and time, the IDE devices, and the diskette drives.

Standard CMOS Features

Date (mm:dd:yy)	Tue, Jun 12 2001	Item Help
Time (hh:mm:ss)	12 : 8 : 59	
▶ IDE Primary Master	Press Enter 4303 MB	Menu Level ▶ Change the day, month, year and century.
▶ IDE Primary Slave	Press Enter None	
▶ IDE Secondary Master	Press Enter None	
▶ IDE Secondary Slave	Press Enter None	
Drive A	1.44M, 3.5 in.	
Drive B	None	
Video	EGA/VGA	
Halt On	All , But Keyboard	

Date & Time	Use these items to set the system date and time
IDE Devices	Your computer has two IDE channels (Primary and Secondary) and each channel can be installed with one or two devices (Master and Slave). Use these items to configure each device on the IDE channel. Press Enter to display the IDE sub-menu. Press Esc to close the IDE device sub-menu and return to the Standard CMOS Features page.
Floppy Drive A Floppy Drive B	Use these items to set the size and capacity of the floppy diskette drive(s) installed in the system.
Video	This item defines the video mode of the system. This mainboard has a built-in VGA graphics system; you must leave this item at the default value.
Halt On	This item defines the operation of the system POST (Power On Self Test) routine. You can use this item to select which types of errors in the POST are sufficient to halt the system.

Mainboard User's Manual

Advanced BIOS Features Page

Use this page to set more advanced information about your system. Take some care with this page. Making changes can affect the operation of your computer.

Advanced BIOS Features

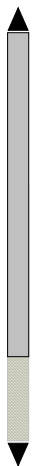
Virus Warning	Disabled		Item Help
Quick Power On Self Test	Enabled		Menu Level ▶
First Boot Device	HDD-0		Allows the system to skip certain tests while booting. This will decrease the time needed to boot the system.
Second Boot Device	Floppy		
Third Boot Device	CDROM		
Boot Other Device	Enabled		
Swap Floppy Drive	Disabled		
Boot Up Floppy Seek	Disabled		
Boot Up NumLock Status	On		
Gate A20 Option	Normal		
Typematic Rate Setting	Disabled		
x Typematic Rate (Chars/Sec)	6		
x Typematic Delay (Msec)	250		
Security Option	Setup		
OS Select For DRAM > 64MB	Non-OS2		
Video BIOS Shadow	Enabled		
C8000-CBFFF Shadow	Disabled		
CC000-CFFFF Shadow	Disabled		
D0000-D3FFF Shadow	Disabled		

Virus Warning	This mainboard has built-in virus protection in the firmware. Use this item to enable or disable the built-in virus protection.
Quick Power On Self Test	You can enable this item to shorten the power on testing (POST) and have your system start up a little faster. You might like to enable this item after you are confident that your system hardware is operating smoothly.
1st/2nd/3rd Boot Device	Use these three items to select the priority and order of the devices that your system searches for an operating system at start-up time.
Boot Other Device	If you enable this item, the system will search all other possible locations for an operating system if it fails to find one in the devices specified under the first, second, and third boot devices.

3: BIOS Setup Utility

Swap Floppy Drive	If you have two floppy diskette drives in your system, this item allows you to swap the assigned drive letters so that drive A becomes drive B, and drive B becomes drive A.
Boot Up Floppy Seek	If this item is enabled, it checks the geometry of the floppy disk drives at start-up time. You don't need to enable this item unless you have an old diskette drive with 360K capacity.
Boot Up NumLock Status	This item defines if the keyboard Num Lock key is active when your system is started.
Gate A20 Option	This item defines how the system handles legacy software that was written for an earlier generation of processors. Leave this item at the default value.
Typematic Rate Setting	If this item is enabled, you can use the following two items to set the typematic rate and the typematic delay settings for your keyboard.
Typematic Rate (Chars/Sec)/ Delay (Msec)	If the item Typematic Rate Setting is enabled, you can use these items to define how many characters per second are generated by a held-down key and how many milliseconds must elapse before a held-down key begins generating repeat characters.
Security Option	If you have installed password protection, this item defines if the password is required at system start up, or if it is only required when a user tries to enter the Setup Utility.
OS Select For DRAM > 64 MB	This item is only required if you have installed more than 64 MB of memory and you are running the OS/2 operating system. Otherwise, leave this item at the default Non-OS2.
Video BIOS Shadow	When enabled this item copies the VGA BIOS into system DRAM.
C8000-CBFFF to D0000-D3FFF Shadow	When enabled, the ROM with the specified address is copied into system DRAM. It will also reduce the size of memory available to the system.

Mainboard User's Manual

Advanced Chipset Features Page

This page sets some of the parameters of the mainboard components including the memory, and the system logic.

Advanced Chipset Features		Item Help
DRAM Timing By SPD	Disabled	Menu Level ▶
SDRAM Cycle Length	3	
Bank Interleave	Disabled	
DRAM Clock	By Auto	
DRAM Drive Strength	High	
System BIOS Cacheable	Enabled	
Video RAM Cacheable	Enabled	
Frame Buffer Size	8M	
AGP Aperture Size	64M	
OnChip USB	Enabled	
OnChip USB 2	Disabled	
USB Keyboard Support	Disabled	
OnChip Sound	Auto	
OnChip Modem	Auto	
PCI Master 0 WS Write	Enabled	
PCI#2 Access #1 Retry	Enabled	
AGP Master 1 WS Write	Disabled	
AGP Master 1 WS Read	Disabled	
Memory Parity/ECC Check	Disabled	

DRAM Timing By SPD	This item allows you to enable or disable the DRAM timing defined by the Serial Presence Detect electrical.
SDRAM Cycle Length	This field enables you to set the CAS latency time in HCLKs of 2/2 or 3/3. The system board designer should have set the values in this field, depending on the DRAM installed. Do not change the values in this field unless you change specifications of the installed DRAM or the installed CPU.
Bank Interleave	This item allows you to enable or disable the Bank Interleave function with 2 banks or 4 banks.
DRAM Clock	Enables the user to select the DRAM Clock.
DRAM Drive Strength	This option determines the signal strength from the mainboard for the installed DRAM.
System BIOS Cacheable	When enabled, the System BIOS will be cached for faster execution.

3: BIOS Setup Utility

Video RAM Cacheable	When enabled, the graphics card's local memory will be cached for faster execution. However, if any program writes to this memory area, a system error may result.
Frame Buffer Size	This option determines the frame buffer size shared from the main memory for use by the onboard VGA display.
AGP Aperture Size	This option determines the effective size of the AGP Graphic <i>Aperture</i> , where memory-mapped graphic data structures are located.
OnChip USB	This item allows you to enable the USB port, if you have installed a USB device on the system board.
OnChip USB 2	This item allows you to enable the USB 2 port, if you have installed more USB device on the system board.
USB Keyboard Support	Enables function when the USB keyboard is being used. Disabled (default) when an AT keyboard is used.
OnChip Sound	Disabling this function turns off the onboard audio chip.
OnChip Modem	This should be enabled if your system has a modem installed on the system board and you wish to use it.
PCI Master 0 WS Write	When enabled, writes to the PCI bus are executed with zero wait states.
PCI#2 Access #1 Retry	When enabled, the AGP Bus (PCI#1) access to PCI Bus (PCI#2) is executed with the error retry feature.
AGP Master 1 WS Write	This implements a single delay when writing to the AGP Bus. By default, two-wait states are used by the system, allowing for greater stability.
AGP Master 1 WS Read	This implements a single delay when reading to the AGP Bus. By default, two-wait states are used by the system, allowing for greater stability.
Memory Parity/ECC Check	If this item is enabled it allows the system to use parity checking and ECC (Error Correcting Code) to catch errors in the system memory. Enabling this item might have an impact on overall system performance.

Mainboard User's Manual

Integrated Peripherals Page

This page sets some of the parameters for peripheral devices connected to the system.

Integrated Peripherals			Item Help
On-Chip IDE Channel0		Enabled	Menu Level ►
On-Chip IDE Channel1		Enabled	
IDE Prefetch Mode		Disabled	
Primary Master	PIO	Auto	
Primary Slave	PIO	Auto	
Secondary Master	PIO	Auto	
Secondary Slave	PIO	Auto	
Primary Master	UDMA	Auto	
Primary Slave	UDMA	Auto	
Secondary Master	UDMA	Auto	
Secondary Slave	UDMA	Auto	
Init Display First		PCI Slot	
Onboard FDD Controller		Enabled	
Onboard Serial Port 1		3F8/IRQ4	
Onboard IR Port		Disabled	
x UART 2 Mode		Standard	
x IR Function Duplex		Half	
x TX,RX inverting enable		No, Yes	
Onboard Parallel Port		378/IRQ7	

On-Chip IDE Channel 0,1	Use these items to enable or disable the PCI IDE channels that are integrated on the mainboard.
Primary/Secondary Master/Slave PIO	Each channel supports a master device and a slave device. These four items let you assign which kind of PIO (Programmed Input/Output) is used by IDE devices. You can choose Auto, to let the system auto detect which PIO mode is best, or you can install a PIO mode from 0-4.
Primary/Secondary Master/Slave UDMA	Each channel supports a master device and a slave device. This motherboard supports UltraDMA and provides faster access to IDE devices. If you install a device that supports UltraDMA, change the appropriate item on this list to Auto. You may have to install the UltraDMA driver.

3: BIOS Setup Utility

Init Display First	Use this item to define if your graphics adapter is installed in one of the PCI slots or select Onboard if you have a graphics system integrated on the mainboard.
Onboard FDD Controller	This option enables the onboard floppy disk drive controller.
Onboard Serial Port 1	This option is used to assign the I/O address for the onboard serial port.
Onboard IR Port	This option is used to assign the I/O address for the onboard IR port or disabled.
UART2 Mode	This field is available if the Onboard Serial Port 2 field is set to any option but "Disabled." UART Mode enables you to select the infrared communication protocol—Standard (default), HPSIR or ASKIR. HPSIR is Hewlett Packard's infrared communication protocol with a maximum baud rate up to 115.2 Kbps. ASKIR is Sharp's infrared communication protocol with a maximum baud rate up to 57.6 Kbps.
IR Function Duplex	This field is available when UART 2 Mode is set to either ASKIR or HPSIR. This item determines the infrared (IR) function of the onboard infrared chip. Full-duplex means that you can transmit and send information simultaneously. Half duplex is the transmission of data in both directions, but only one direction at a time.
TX, RX inverting enable	Defines the voltage level for Infrared module RxD (receive) mode and TxD (transmit) mode. This setting has to match the requirements of the infrared module used in the system.
Onboard Parallel Port	This option is used to assign the I/O address for the onboard parallel port.
Onboard Parallel Mode	This feature enables you to set the data transfer protocol for your parallel port. Normal allows data output only. Extended Capabilities Port (ECP) and Enhanced Parallel Port (EPP) are bi-directional modes, allowing both data input and output. ECP and EPP modes are only supported with EPP and ECP aware peripherals.
ECP Mode Use DMA	When the onboard parallel port is set to ECP mode, the parallel port has the option to use DMA "3" or DMA "1."
Parallel Port EPP Type	This option sets the Enhanced Parallel Port (EPP) specification.

Mainboard User's Manual

Onboard Legacy Audio	This option enables the onboard legacy audio function. When enabled the following items become available.
Sound Blaster	This feature is used to enable or disable a Sound Blaster card if installed.
SB I/O Base Address	This item lets you set the I/O base address for the Sound Blaster card.
SB IRQ Select	This item lets you set the Interrupt Request (IRQ) for the Sound Blaster card.
SB DMA Select	This item lets you select the Direct Memory Access (DMA) for the Sound Blaster card.
MPU-401, MPU-401 I/O Address	Use the two items to enable the MPU-401 function and set the I/O address for the game port.
Game Port (200-207H)	This item shows the I/O address for the game port.

3: BIOS Setup Utility

Power Management Setup Page

This page sets some of the parameters for system power management operation.

Power Management Setup		
ACPI Function	Disabled	Item Help
▶ Power Management	Press Enter	
PM Control by APM	Yes	Menu Level ▶
Video Off Option	Suspend --> Off	
Video Off Method	Bland Screen	
MODEM Use IRQ	3	
Soft-Off by PWRBTN	Delay 4 Sec	
State After Power Failure	Off	
Keyboard Power On	Disabled	
▶ Wake Up Events	Press Enter	

ACPI Function	Use this item to enable or disable the ACPI function.
Power Management	This item acts like a master switch for the power-saving modes and hard disk timeouts. If this item is set to Max Saving, power-saving modes occur after a short timeout. If this item is set to Min Saving, power-saving modes occur after a longer timeout. If the item is set to User Define, you can insert your own timeouts for the power-saving modes.
PM Control by APM	This field allows you to control the PC Monitor's power management features via Intel-Microsoft Advanced Power Management software. Once you have enabled the APM interface, some settings made in the BIOS Setup program may be overridden by APM.
Video Off Option	This option defines if the video is powered down when the system is put into suspend mode.
Video Off Method	This item defines how the video is powered down to save power.

Mainboard User's Manual

MODEM Use IRQ	If you want an incoming call on a modem to automatically resume the system from a power-saving mode, use this item to specify the interrupt request line (IRQ) that is used by the modem. You might have to connect the fax/modem to the mainboard Wake On Modem connector for this feature to work.
Soft-Off by PWRBTN	Under ACPI (Advanced Configuration and Power management Interface) you can create a software power down. In a software power down, the system can be resumed by Wake Up Alarms. This item lets you install a software power down that is controlled by the normal power button on your system. If the item is set to Instant-Off, then the power button causes a software power down. If the item is set to "Delay 4 Sec." then you have to hold the power button down for four seconds to cause a software power down.
State After Power Failure	Use this item to set a system power state when power restores after sudden AC power loss.
Keyboard Power On	Use this item to enable or disable the keyboard power on function.
Wake Up Events	This item opens a submenu that enables you to set events that will resume the system from a power saving mode. Select Wake Up Events and press Enter to display the following items: VGA, LPT & COM, HDD & FDD, PCI Master, PowerOn by PCI Card, Wake Up On LAN/Ring, RTC Alarm Resume, Primary INTR, and IRQs Activity Monitoring.

3: BIOS Setup Utility

PnP/PCI Configurations Page

This page sets some of the parameters for devices installed on the PCI bus and devices that use the system plug and play capability.

PnP/PCI Configurations

		Item Help
PNP OS Installed	Yes	
Reset Configuration Data	Disabled	
Resources Controlled by	Auto(ESCD)	Menu Level ►
x IRQ Resources	Press Enter	Default is Disabled. Select Enabled to reset Extended System Configuration Data (ESCD) when you exit Setup if you have installed a new add-on and the system reconfiguration has caused such a serious conflict that the OS cannot boot.
x DMA Resources	Press Enter	
PCI/VGA Palette Snoop	Disabled	

PNP OS Installed	Setting this option to "Yes" allows the PnP OS (instead of BIOS) to assign the system resources such as IRQ and I/O address to the ISA PnP device.
Reset Configuration Data	If you enable this item and restart the system, any PnP configuration data stored in the BIOS setup is cleared from memory. New updated data is created.
Resources Controlled By	<p>You should leave this item at the default Auto (ESCD). Under this setting, the system dynamically allocates resources to plug and play devices as they are required. If you cannot get a legacy ISA (Industry Standard Architecture) expansion card to work properly, you might be able to solve the problem by changing this item to Manual, and then opening up the <i>IRQ Resources</i> and <i>Memory Resources</i> sub-menus.</p> <p>In the <i>IRQ Resources</i> sub-menu, if you change any of the IRQ assignments to Legacy ISA, then that Interrupt Request Line is reserved for a legacy ISA expansion card. Press Esc to close the IRQ Resources sub-menu.</p>

Mainboard User's Manual

PCI/VGA Palette Snoop	This item is designed to overcome some problems that can be caused by some non-standard VGA cards. This board includes a built-in VGA system that does not require palette snooping so you must leave this item disabled.
-----------------------	---

Hardware Monitor Page

This page sets some of the parameters for the hardware monitoring function of this mainboard.

CMOS Setup Utility – Copyright (C) 1984 – 2001 Award Software
Hardware Monitor

Current CPU Temp. Current System Temp. Current CPUFAN1 speed Current CPUFAN2 speed Vcore 2.5V 3.3V 5V 12V	Item Help Menu Level ▶
---	---------------------------

↑↓→←: Move Enter: Select +/-/PU/PD: Value: F10: Save
ESC: Exit F1: General Help F5: Previous Values F6: Fail-Safe
Defaults F7: Optimized Defaults

System Component Characteristics	<p>These fields provide you with information about the systems current operating status. You cannot make changes to these fields. The following information is displayed:</p> <ul style="list-style-type: none"> CPU Temperature System Temperature CPU FAN (in RPMs) System FAN (in RPMs) Vcore (CPU Core voltage) 2.5V (onboard 2.5 volt) 3.3V (onboard 3.3 volt) 5V (power supply's 5 volt) 12V (power supply's 12 volt).
----------------------------------	---

3: BIOS Setup Utility

Frequency/Voltage Control Page

This page sets some of the parameters for frequency and voltage control.

Frequency/Voltage Control		Item Help
Auto Detect DIMM/PCI Clk	Enabled	Menu Level ▶
Spread Spectrum	Disabled	

Auto Detect DIMM/PCI Clk	When this item is enabled, BIOS will disabled the clock signal of free DIMM and PCI slots.
Spread Spectrum	Use this item to set the system bus spread spectrum for the installed processor.

Load BestPerf. Defaults

If you select this item and press **Enter** a dialog box appears. If you press **Y**, and then **Enter**, the Setup Utility loads a set of best-performance default values. These defaults are quite demanding and your system might not function properly if you are using slower memory chips or other low-performance components.

Mainboard User's Manual

Load Optimized Defaults

If you select this item and press **Enter**, a dialog box appears. If you press **Y**, and then **Enter**, the Setup Utility loads a set of fail-safe default values. These default values are not very demanding and they should allow your system to function with most kinds of hardware and memory chips.

Set Password

If you highlight this item and press **Enter**, a dialog box appears which lets you enter a password. You can enter no more than eight letters or numbers. Press **Enter** after you have typed in the password. A second dialog box asks you to retype the password for confirmation. Press **Enter** after you have retyped it correctly. The password is then required to access the Setup Utility or for that and at start-up, depending on the setting of the Password Check item in Advanced Setup.

Change or Remove the Password

Highlight this item, press **Enter** and type in the current password. At the next dialog box, type in the new password, or just press **Enter** to disable password protection.

Save & Exit Setup

Highlight this item and press **Enter** to save the changes that you have made in the Setup Utility configuration and exit the program. When the Save and Exit dialog box appears, press **Y** to save and exit, or press **N** to exit without saving.

Exit Without Saving

Highlight this item and press **Enter** to discard any changes that you have made in the Setup Utility and exit the setup program. When the Exit Without Saving dialog box appears, press **Y** to discard changes and exit, or press **N** to return to the setup main menu.

Chapter 4

Software & Applications

Introduction

This chapter describes the contents of the support CD-ROM that comes with the mainboard package.

The support CD-ROM contains all useful software, necessary drivers and utility programs to properly run our products. More program information is available in a README file, located in the same directory as the software.

To run the support CD, simply insert the CD into your CD-ROM drive. An Auto Setup screen automatically pops out, and then you can go on the auto-installing or manual installation depending on your operating system.

If your operating system is Windows 98/ME/2000/XP, it will automatically install all the drivers and utilities for your mainboard; if Windows NT or manual installation, please follow the instructions described as the Installing under Windows NT or Manual Installation section.

Mainboard User's Manual

Installing Support Software

1. Insert the support CD-ROM disc in the CD-ROM drive.
2. When you insert the CD-ROM disc in the system CD-ROM drive, the CD automatically displays an Auto Setup screen.
3. The screen displays three buttons of **Setup**, **Browse CD** and **Exit** on the right side, and three others **Setup**, **Application** and **ReadMe** at the bottom. Please see the following illustration.



The **Setup** button runs the software auto-installing program as explained in next section.

The **Browse CD** button is a standard Windows command that you can check the contents of the disc with the Windows 98 file browsing interface.

The **Exit** button closes the Auto Setup window. To run the program again, reinsert the CD-ROM disc in the drive; or click the CD-ROM driver from the Windows Explorer, and click the Setup icon.

The **Application** button brings up a software menu. It shows the bundled software that this mainboard supports.

The **ReadMe** brings you to the Install Path where you can find out path names of software driver.

4: Software & Applications

Auto-Installing under Windows 98/ME/2000/XP

If you are under Windows 98/ME/2000/XP, please click the **Setup** button to run the software auto-installing program while the Auto Setup screen pops out after inserting the support CD-ROM:

1. The installation program loads and displays the following screen. Click the **Next** button.



2. Select the items that you want to setup by clicking on it (the default options are recommended). Click the **Next** button to proceed.

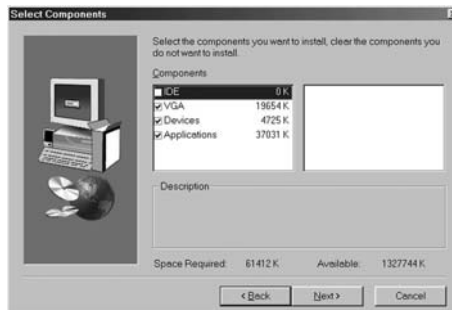

3. The support software will automatically install.

Once any of the installation procedures start, software is automatically installed in sequence. You need to follow the onscreen instructions, confirm commands and allow the computer to restart as few times as needed to complete installing whatever software you selected. When the process is finished, all the support software will be installed and start working.

Mainboard User's Manual

Installing under Windows NT or Manual Installation

If you are under Windows NT, the auto-installing program doesn't work out; or you have to do the manual installation, please follow this procedure while the Auto Setup screen pops out after inserting the support CD-ROM:

1. Click the **ReadMe** to bring up a screen, and then click the Install Path at the bottom of the screen.
2. Find out your mainboard model name and click on it to obtain its correct driver directory.
3. Install each software in accordance with the corresponding driver path.

Bundled Software Information

All bundled software available on the CD-ROM is for users' convenience. You can install bundled software as follows:

1. Click the **Application** button while the Auto Setup screen pops out after inserting the support CD-ROM.
2. A software menu appears. Click the software you want to install.
3. Follow onscreen instructions to install the software program step by step until finished.