

ASUS[®] SP98AGP-X
Pentium[®] ATX Motherboard

USER'S MANUAL

USER'S NOTICE

No part of this manual, including the products and software described in it, may be reproduced, transmitted, transcribed, stored in a retrieval system, or translated into any language in any form or by any means, except documentation kept by the purchaser for backup purposes, without the express written permission of ASUSTeK COMPUTER INC. ("ASUS").

ASUS PROVIDES THIS MANUAL "AS IS" WITHOUT WARRANTY OF ANY KIND, EITHER EXPRESS OR IMPLIED, INCLUDING BUT NOT LIMITED TO THE IMPLIED WARRANTIES OR CONDITIONS OF MERCHANTABILITY OR FITNESS FOR A PARTICULAR PURPOSE. IN NO EVENT SHALL ASUS, ITS DIRECTORS, OFFICERS, EMPLOYEES OR AGENTS BE LIABLE FOR ANY INDIRECT, SPECIAL, INCIDENTAL, OR CONSEQUENTIAL DAMAGES (INCLUDING DAMAGES FOR LOSS OF PROFITS, LOSS OF BUSINESS, LOSS OF USE OR DATA, INTERRUPTION OF BUSINESS AND THE LIKE), EVEN IF ASUS HAS BEEN ADVISED OF THE POSSIBILITY OF SUCH DAMAGES ARISING FROM ANY DEFECT OR ERROR IN THIS MANUAL OR PRODUCT.

Product warranty or service will not be extended if: (1) the product is repaired, modified or altered, unless such repair, modification or alteration is authorized in writing by ASUS; or (2) the serial number of the product is defaced or missing.

Products and corporate names appearing in this manual may or may not be registered trademarks or copyrights of their respective companies, and are used only for identification or explanation and to the owners' benefit, without intent to infringe.

- Intel, LANDesk, and Pentium are registered trademarks of Intel Corporation.
- IBM and OS/2 are registered trademarks of International Business Machines.
- Symbios is a registered trademark of Symbios Logic Corporation.
- Windows and MS-DOS are registered trademarks of Microsoft Corporation.
- Sound Blaster AWE32 and SB16 are trademarks of Creative Technology Ltd.
- Adobe and Acrobat are registered trademarks of Adobe Systems Incorporated.

The product name and revision number are both printed on the product itself. Manual revisions are released for each product design represented by the digit before and after the period of the manual revision number. Manual updates are represented by the third digit in the manual revision number.

For previous or updated manuals, BIOS, drivers, or product release information, contact ASUS at <http://www.asus.com.tw> or through any of the means indicated on the following page.

SPECIFICATIONS AND INFORMATION CONTAINED IN THIS MANUAL ARE FURNISHED FOR INFORMATIONAL USE ONLY, AND ARE SUBJECT TO CHANGE AT ANY TIME WITHOUT NOTICE, AND SHOULD NOT BE CONSTRUED AS A COMMITMENT BY ASUS. ASUS ASSUMES NO RESPONSIBILITY OR LIABILITY FOR ANY ERRORS OR INACCURACIES THAT MAY APPEAR IN THIS MANUAL, INCLUDING THE PRODUCTS AND SOFTWARE DESCRIBED IN IT.

Copyright © 1998 ASUSTeK COMPUTER INC. All Rights Reserved.

Product Name:	ASUS SP98AGP-X
Manual Revision:	1.03
Release Date:	March 1998

ASUS CONTACT INFORMATION

ASUSTeK COMPUTER INC.

Marketing

Address: 150 Li-Te Road, Peitou, Taipei, Taiwan 112
Telephone: +886-2-2894-3447
Fax: +886-2-2894-3449
Email: info@asus.com.tw

Technical Support

Fax: +886-2-2895-9254
BBS: +886-2-2896-4667
Email: tsd@asus.com.tw
WWW: www.asus.com.tw
FTP: ftp.asus.com.tw/pub/ASUS

ASUS COMPUTER INTERNATIONAL

Marketing

Address: 6737 Mowry Ave, Mowry Business Center, Building 2,
Newark, CA 94560, USA
Fax: +1-510-608-4555
Email: info-usa@asus.com.tw

Technical Support

Fax: +1-510-608-4555
BBS: +1-510-739-3774
Email: tsd-usa@asus.com.tw
WWW: www.asus.com
FTP: ftp.asus.com.tw/pub/ASUS

ASUS COMPUTER GmbH

Marketing

Address: Harkort Str. 25, 40880 Ratingen, BRD, Germany
Telephone: 49-2102-445011
Fax: 49-2102-442066
Email: info-ger@asus.com.tw

Technical Support

Hotline: 49-2102-499712
BBS: 49-2102-448690
Email: tsd-ger@asus.com.tw
WWW: www.asuscom.de
FTP: ftp.asuscom.de/pub/ASUSCOM

CONTENTS

I. INTRODUCTION	7
How this Manual is Organized	7
Item Checklist	7
II. FEATURES	8
Features of the ASUS SP98AGP-X Motherboard	8
ASUS Smart Series of Motherboards	9
The ASUS SP98AGP-X Motherboard	11
III. INSTALLATION	12
ASUS SP98AGP-X Motherboard Layout	12
Installation Steps	14
1. Jumpers	14
Jumper Settings	15
2. System Memory (DIMM)	19
DIMM Memory Installation Procedures:	20
3. Central Processing Unit (CPU)	22
4. Expansion Cards	23
Expansion Card Installation Procedure:	23
Assigning IRQs for Expansion Cards.....	23
Assigning DMA Channels for ISA Cards.....	24
ISA Cards and Hardware Monitor	24
Accelerated Graphics Port	24
5. External Connectors	25
Power Connection Procedures	33
IV. BIOS SOFTWARE	34
Support Software	34
Flash Memory Writer Utility	34
Main Menu	34
Advanced Features Menu	35
Managing and Updating Your Motherboard's BIOS	36
6. BIOS Setup	37
Load Defaults	38
Standard CMOS Setup	38
Details of Standard CMOS Setup:	38
BIOS Features Setup	41
Details of BIOS Features Setup	41
Chipset Features Setup	44
Details of Chipset Features Setup.....	44
Power Management Setup.....	47
Details of Power Management Setup	47

CONTENTS

PNP and PCI Setup	49
Details of PNP and PCI Setup	49
Load BIOS Defaults	51
Load Setup Defaults	51
Supervisor Password and User Password	52
IDE HDD Auto Detection	53
Save & Exit Setup	54
Exit Without Saving	54
V. SUPPORT SOFTWARE	55
ASUS Smart Motherboard Support CD 3.10	55
Desktop Management Interface (DMI)	56
Introducing the ASUS DMI Configuration Utility	56
System Requirements	56
Using the ASUS DMI Configuration Utility	57
VI. ASUS PCI SCSI Cards	59
Symbios SCSI BIOS and Drivers	59
ASUS PCI-SC200 & PCI-SC860 SCSI Cards	59
Setting Up the ASUS PCI-SC200 & PCI-SC860	60
Setting the INT Assignment for the ASUS PCI-SC200	60
Terminator Requirements for SCSI Devices	60
Terminator Settings for the ASUS PCI-SC860	61
Terminator Settings for the ASUS PCI-SC200	61
SCSI ID Numbers for SCSI Devices	62
SCSI ID Priority	62
VII. ASUS LAN Card	63
ASUS PCI-L101 Fast Ethernet Card	63
Features	64
Software Driver Support	64
Question and Answer	64

FCC & DOC COMPLIANCE

Federal Communications Commission Statement

This device complies with FCC Rules Part 15. Operation is subject to the following two conditions:

- This device may not cause harmful interference, and
- This device must accept any interference received, including interference that may cause undesired operation.

This equipment has been tested and found to comply with the limits for a Class B digital device, pursuant to Part 15 of the FCC Rules. These limits are designed to provide reasonable protection against harmful interference in a residential installation. This equipment generates, uses and can radiate radio frequency energy and, if not installed and used in accordance with manufacturer's instructions, may cause harmful interference to radio communications. However, there is no guarantee that interference will not occur in a particular installation. If this equipment does cause harmful interference to radio or television reception, which can be determined by turning the equipment off and on, the user is encouraged to try to correct the interference by one or more of the following measures:

- Re-orient or relocate the receiving antenna.
- Increase the separation between the equipment and receiver.
- Connect the equipment to an outlet on a circuit different from that to which the receiver is connected.
- Consult the dealer or an experienced radio/TV technician for help.

WARNING! The use of shielded cables for connection of the monitor to the graphics card is required to assure compliance with FCC regulations. Changes or modifications to this unit not expressly approved by the party responsible for compliance could void the user's authority to operate this equipment.

Canadian Department of Communications Statement

This digital apparatus does not exceed the Class B limits for radio noise emissions from digital apparatus set out in the Radio Interference Regulations of the Canadian Department of Communications.

I. INTRODUCTION

How this Manual is Organized

This manual is divided into the following sections:

I. Introduction	Manual information and checklist
II. Features	Information and specifications concerning this product
III. Installation	Instructions on setting up the motherboard.
IV. BIOS Software	Instructions on setting up the BIOS software
V. Support Software	Information on the included support software
VI. ASUS SCSI Cards	Installation of ASUS SCSI cards (optional)
VII. ASUS PCI-L101	Installation of ASUS PCI-L101 Fast Ethernet PCI Card

Item Checklist

Check that your package is complete. If you discover damaged or missing items, contact your retailer.

- ASUS SP98AGP-X motherboard
- 1 IDE ribbon cable
- 1 floppy ribbon cable
- Support Drivers & Utilities
 - Crystal Audio Driver
 - SiS 5591 AGP VxD and IDE driver
 - ASUS PC Probe Hardware Monitor
 - Desktop Management Interface (DMI) utility
 - Flash Memory Writer utility to update the FLASH BIOS
 - Readme files for descriptions and use of the files
 - Technical Support Form
- This user's manual
- Onboard audio chipset and audio driver (optional)
- Infrared module (optional)
- ASUS PCI-SC200 Fast-SCSI or PCI-SC860 Ultra-Fast SCSI card (optional)
- ASUS PCI-L101 10/100 Fast Ethernet PCI Card (optional)

II. FEATURES

Features of the ASUS SP98AGP-X Motherboard

The ASUS SP98AGP-X is carefully designed for the demanding PC user who wants many features in a small package. This motherboard:

- **AGP Chipset:** SiS5591 chipset with built-in AGP support for high performance, component level interconnection targeted at 3D graphical display applications.
- **Versatile Processor Support:** Intel Pentium® 75-233MHz (P55C-MMX™, P54C/P54CS), IBM®/Cyrix® 6x86-PR166+ (Rev 2.7 or later), IBM®/Cyrix® 6x86MX™ (PR166 & faster), AMD-K5™ (PR75-PR133), AMD-K6™ (PR166 & faster).
- **Versatile Memory Support:** Three DIMM sockets to support (8, 16, 32, 64, 128, or 256MB) 168-pin SDRAM/Extended Data Out (EDO) memory modules up to 768MB.
- **Easy Installation:** BIOS supports autodetection of hard drives, PS/2 mouse, and Plug and Play devices to make setup of hard drives, expansion cards, and other devices virtually automatic.
- **ISA & PCI Expansion Slots:** Three 16-bit ISA and three 32-bit PCI slots.
- **Super Multi-I/O:** Two high-speed UART-compatible serial ports and one parallel port with EPP and ECP capabilities.
- **Desktop Management Interface (DMI):** Supports DMI through BIOS, which allows hardware to communicate within a standard protocol creating a higher level of compatibility. (Requires DMI-enabled components.) (See section V)
- **PCI Bus Master IDE Controller:** Onboard PCI Bus Master IDE controller with two connectors that supports four IDE devices in two channels, supports PIO Modes 3 and 4 and Bus Master IDE DMA Mode 2, and supports Enhanced IDE devices such as Tape Backup and CD-ROM drives. Supports two drives of either 5.25-inch (360KB or 1.2MB) or 3.5-inch (720KB, 1.44MB, or 2.88MB) disk drives. Supports Japanese “Floppy 3 mode” (3.5-inch disk drive: 1.2MB) and LS-120 floppy disk drives (3.5-inch disk drive: 120 MB, 1.44MB, 720K). BIOS supports IDE CD-ROM or SCSI device boot-up.
- **Level 2 Cache:** 512KB (1MB option) Pipelined Burst SRAM onboard.
- **Optional IrDA Module:** Supports optional IrDA receiver/transmitter device.
- **Symbios SCSI BIOS:** Onboard firmware to support optional ASUS SCSI controller cards.
- **Optional Integrated Audio:** Optional onboard audio with 3D sound.
- **Compliance:** ACPI ready for advanced power management features and PC97 compliant for greater support.

II. FEATURES

ASUS Smart Series of Motherboards

Performance

- **SDRAM Optimized Performance** — ASUS Smart series of motherboards support the new generation memory, Synchronous Dynamic Random Access Memory (SDRAM).
- **Double the IDE Transfer Speed** — ASUS Smart series of motherboards with SiS5591 chipset improves IDE transfer rate using Bus Master UltraDMA/33 IDE which can handle data transfer up to 33MB/s. This technology is also compatible with existing ATA-2 IDE specs so there is no need to upgrade current hard drives or cables.
- **Concurrent PCI** — Concurrent PCI allows multiple PCI transfers from PCI master busses to memory to CPU.
- **ACPI Ready** — ACPI (Advanced Configuration and Power Interface) is also implemented on all ASUS Smart series of motherboards. ACPI provide more Energy Saving Features for the future operating systems (OS) supporting OS Direct Power Management (OSPM) functionality. With these features implemented in the OS, PCs can be ready around the clock everyday, yet satisfy all the energy saving standards. To fully utilize the benefits of ACPI, an ACPI-supported OS such as in the next release of Windows 95 must be used.
- **PC97 Compliant** — Both the BIOS and hardware levels of ASUS Smart series of motherboards meet PC97 compliancy. The new PC 97 requirements for systems and components are based on the following high-level goals: Support for Plug and Play compatibility and power management for configuring and managing all system components, and 32-bit device drivers and installation procedures for both Windows 95 (and its successors) and Windows NT.

Intelligence:

- **Fan Status Monitoring and Alarm** — To prevent system overheat and system damage, the CPU and chassis fans are monitored for RPM and failure. The normal RPM range and alarm thresholds of these fans can be set through hardware monitoring software.
- **Temperature Monitoring and Alert** — To prevent system overheat and system damage, there is a heat sensor under the CPU and on the motherboard itself to monitor CPU and system temperature to make sure the system is operating at a safe heat level to avoid any failures triggered by extremely high temperature.

II. FEATURES

- **Voltage Monitoring and Alert** — System voltage levels are monitored to ensure stable current to critical motherboard components. Voltage specifications are more critical for future processors, so monitoring is necessary to ensure proper system configuration and management.
- **System Resources Alert** — Today's operating systems such as Windows 95, Windows NT, and OS/2, require much more memory and hard drive space to present enormous user interfaces and run large applications. The system resource monitor will warn the user before the system resources are used up to prevent possible application crashes. Suggestions will give the user information on managing their limited resources more efficiently.
- **CPU Slow Down** — If the CPU fan malfunctions, the system will deactivate the CPU Clock line to decrease CPU utilization to the speed upon detection of system overheat. This will prevent CPU damage from system overheat. The CPU utilization will restore normal operations when temperature falls below a safe level.
- **Auto Fan Off** — The system fans will power off automatically **even in sleep mode**. This function reduces both energy consumption *and* **system noise**, and is an important feature to implement silent PC systems.
- **Remote Ring On (requires ATX power supply)** — This allows a computer to be turned on remotely through a modem. With this benefit on-hand, any user can access vital information from their computer from anywhere in the world!
- **Message LED** — Chassis LEDs now act as information providers. Through the way a particular LED illuminates, the user can determine the stage the computer is in. A simple glimpse provides useful information to the user.

II. FEATURES

The ASUS SP98AGP-X Motherboard

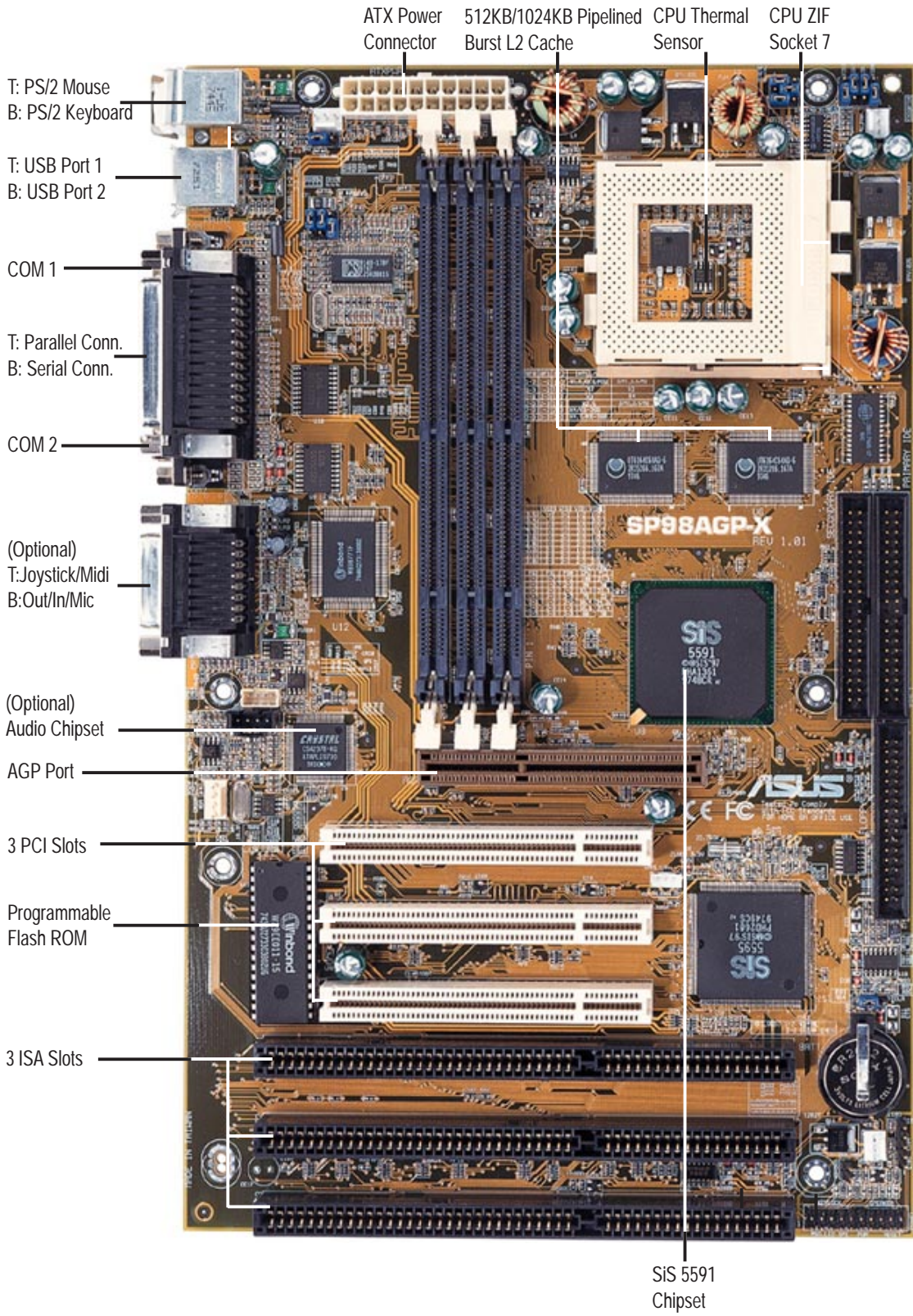

II. FEATURES
Motherboard Parts

III. INSTALLATION

ASUS SP98AGP-X Motherboard Layout

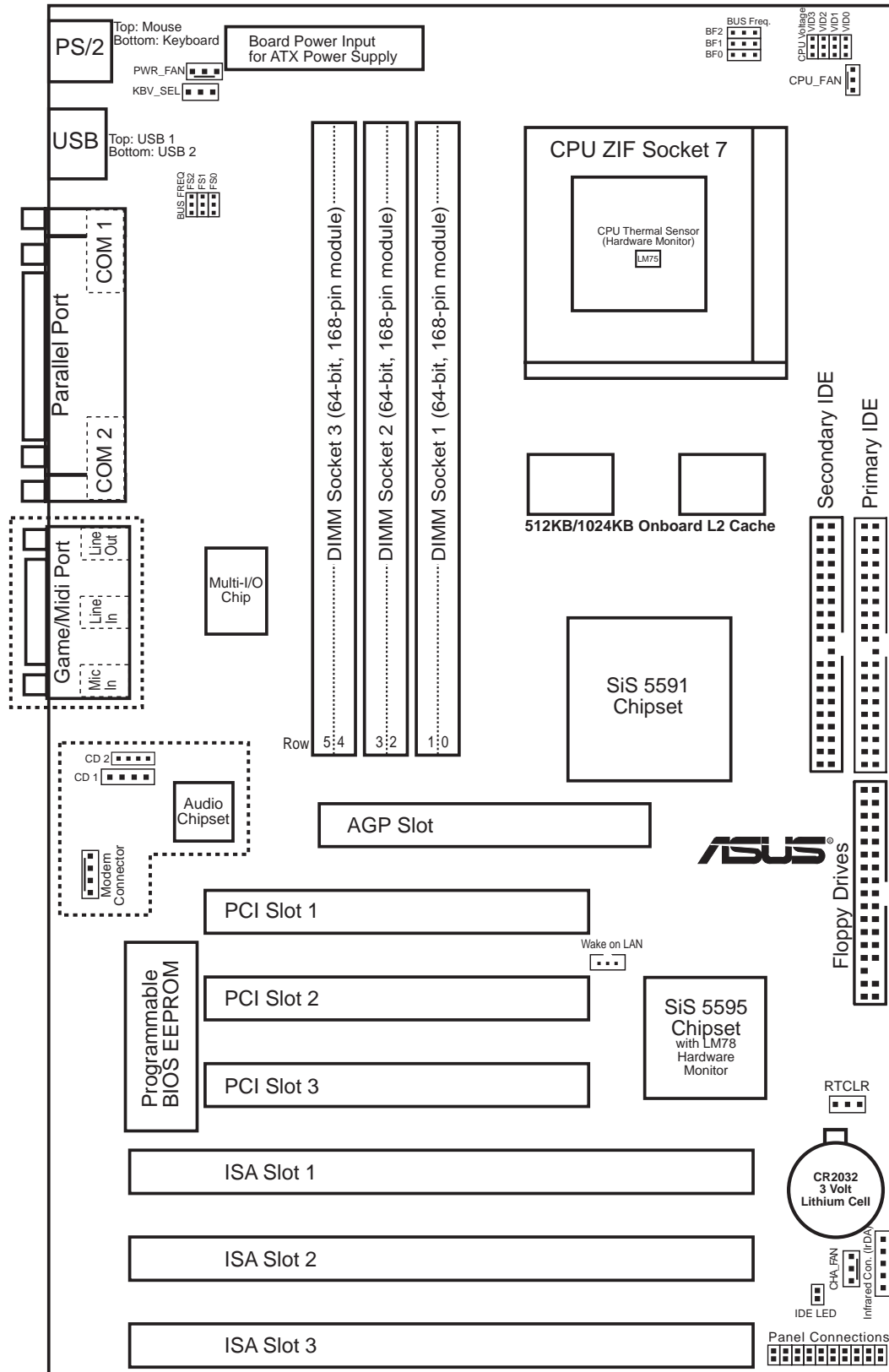

NOTE: Outlined items (thick dashes) are optional and may not be present.

III. INSTALLATION
Motherboard Layout

III. INSTALLATION

Jumpers

- | | | |
|------------------|-------|--|
| 1) RTCLR | p. 15 | Real Time Clock RAM (Operation/Clear Data) |
| 2) KBV_SEL | p. 18 | Keyboard Voltage Selection |
| 3) FS0, FS1, FS2 | p. 16 | CPU External Clock (BUS) Frequency Selection |
| 4) BF0, BF1, BF2 | p. 16 | CPU:BUS Frequency Ratio |
| 5) VID0, 1, 2, 3 | p. 18 | CPU Voltage Regulator Output Selection |

Expansion Slots

- | | | |
|---------------------|-------|--------------------------------------|
| 1) System Memory | p. 19 | System Memory Upgrade |
| 2) CPU ZIF Socket 7 | p. 22 | Central Processing Unit (CPU) Socket |
| 3) SLOT 1, 2, 3 | p. 23 | 16-bit ISA Bus Expansion Slots* |
| 4) PCI 1, 2, 3 | p. 23 | 32-bit PCI Bus Expansion Slots |

Connectors

- | | | |
|------------------------|-------|---|
| 1) PS2KEYBOARD | p. 25 | PS/2 Keyboard Connector (6-pin Female) |
| 2) PS2MOUSE | p. 25 | PS/2 Mouse Connector (6-pin Female) |
| 3) PRINT | p. 26 | Parallel (Printer) Port Connector (25-pin Female) |
| 4) COM1, COM2 | p. 26 | Serial Port COM1 & COM2 (Two 9-pin Male) |
| 5) FLOPPY | p. 26 | Floppy Drive Connector (34-pin Block) |
| 6) AUDIO (optional) | p. 27 | Audio Port -Line Out, Line In, Mic (Three 1/8" Female) |
| 7) GAME (optional) | p. 27 | Joystick/Midi Connector (15-pin Female) |
| 8) USB | p. 27 | Universal Serial BUS Ports 1 & 2 (Two 4-pin Female) |
| 9) Primary/Second. IDE | p. 28 | Primary / Secondary IDE Connector (40-pin Blocks) |
| 10) IDELED | p. 28 | IDE LED Activity Light |
| 11) CHA_CPU_PWR_FAN | p. 29 | Chassis, CPU, Power Supply Fan Power Lead (3-pin Block) |
| 12) MDM (optional) | p. 29 | Modem connector (4 pins) |
| 13) IR | p. 30 | Infrared Port Module Connector |
| 14) ATXPWR | p. 30 | ATX Motherboard Power Connector (20-pin Block) |
| 15) WOL | p. 31 | Wake on LAN (3 pins) |
| 16) CD1 (optional) | p. 31 | Stereo audio in connector (4-pin Block) |
| 17) CD2 (optional) | p. 31 | Stereo audio in connector (4-pin Block) |
| 18) MSG.LED (PANEL) | p. 32 | System Message LED (2 pins) |
| 19) SMI (PANEL) | p. 32 | SMI Switch Lead (2 pins) |
| 20) PWR (PANEL) | p. 32 | ATX Power & Soft-Off Switch Lead (2 pins) |
| 21) RESET (PANEL) | p. 32 | Reset Switch Lead (2 pins) |
| 22) KEYLOCK (PANEL) | p. 32 | System Power LED Lead (3 pins) |
| 23) KEYLOCK (PANEL) | p. 32 | Keyboard Lock Switch Lead (2 pins) |
| 24) SPEAKER (PANEL) | p. 32 | Speaker Output Connector (4 pins) |

*The onboard hardware monitor uses the address 290H-297H so legacy ISA cards must not use this address, otherwise conflicts will occur.







III. INSTALLATION

Installation Steps

Before using your computer, you must complete the following steps:

1. Set Jumpers on the Motherboard
2. Install System Memory
3. Install the Central Processing Unit (CPU)
4. Install Expansion Cards
5. Connect Ribbon Cables, Cabinet Wires, and Power Supply
6. Setup the BIOS Software

1. Jumpers

Several hardware settings are made through the use of jumper caps to connect jumper pins (JP) on the motherboard. See “Motherboard Layout” for locations of jumpers. The jumper settings will be described numerically such as [----], [1-2], [2-3] for no connection, connect pins 1&2, and connect pins 2&3 respectively. Pin 1 for our motherboards is always on top  or on the left  when holding the motherboard with the keyboard connector away from yourself. A “1” is written besides pin 1 on jumpers with three pins. The jumpers will also be shown graphically such as  to connect pins 1&2 and  to connect pins 2&3. Jumpers with two pins will be shown as  for Short (On) and  for Open (Off). For manufacturing simplicity, the jumpers may be sharing pins from other groups. Use the diagrams in this manual instead of following the pin layout on the board. Settings with two jumper numbers require that both jumpers be moved together. To connect the pins, simply place a plastic jumper cap over the two pins as diagramed.

WARNING! Computer motherboards, baseboards and components, such as SCSI cards, contain very delicate Integrated Circuit (IC) chips. To protect them against damage from static electricity, you should follow some precautions whenever you work on your computer.

1. Unplug your computer when working on the inside.
2. Use a grounded wrist strap before handling computer components. If you do not have one, touch both of your hands to a safely grounded object or to a metal object, such as the power supply case.
3. Hold components by the edges and try not to touch the IC chips, leads or connectors, or other components.
4. Place components on a grounded antistatic pad or on the bag that came with the component whenever the components are separated from the system.

III. INSTALLATION

Jumper Settings

1. Real Time Clock (RTC) RAM (RTCLR)

The CMOS RAM is powered by the onboard button cell battery. To clear the RTC data: (1) Turn off your computer and remove the AC power, (2) Move this jumper to “Clear CMOS,” (3) Move the jumper back to “Normal,” (4) Turn on your computer, (5) Hold down <Delete> during bootup and enter BIOS setup to re-enter user preferences.

Battery Test Jumper (RTCLR)

You can test the battery’s current by removing this jumper and attaching a current meter to pins 1&2.

WARNING! You must unplug the power cord to your power supply to ensure that there is no power to your motherboard. The CMOS RAM containing BIOS setup information *may* be cleared by this action. You *must* enter BIOS to “Load Setup Defaults” and re-enter any user information after removing and reapplying this jumper.

RTC RAM

Normal

Clear CMOS

RTCLR

[1-2] (Default)

[2-3] (momentarily)

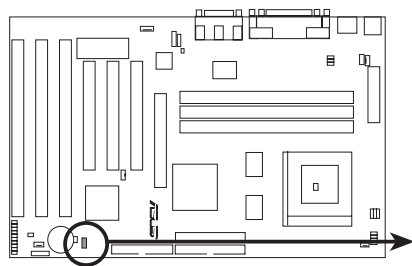

RTC_VDD (Normal/Clear CMOS)

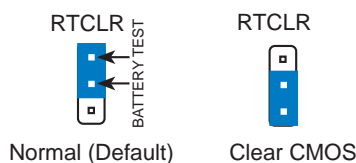

III. INSTALLATION

2. Keyboard Power Selection (KBV_SEL)

This jumper allows you to select the power current for your keyboard. Make sure that your power supply can support at least 300mA +5VSB before selecting +5VSB.

Multi-I/O	KBV_SEL
+5V	[1-2] (Default)
+5VSB	[2-3]

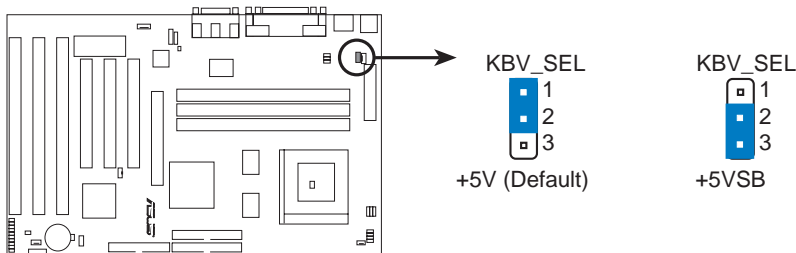

Keyboard Voltage Selection

3. CPU External (BUS) Frequency Selection (FS0, FS1, FS2)

These jumpers tell the clock generator what frequency to send to the CPU. These allow the selection of the CPU's *External* frequency (or *BUS Clock*). The *BUS Clock* times the *BUS Ratio* equals the CPU's *Internal* frequency (the advertised CPU speed).

4. CPU to BUS Frequency Ratio (BF0, BF1, BF2)

These jumpers set the frequency ratio between the *Internal* frequency of the CPU and the *External* frequency (called the *BUS Clock*) within the CPU. These must be set together with the *CPU External (BUS) Frequency Selection* jumpers.

CPU External Clock (BUS) Frequency Selection

Frequency	FS2	FS1	FS0
60MHz	[1-2]	[1-2]	[1-2]
66.8MHz	[1-2]	[2-3]	[1-2]
68.5MHz	[1-2]	[1-2]	[2-3]
75MHz	[1-2]	[2-3]	[2-3]
83.3MHz	[1-2]	[1-2]	[2-3]
90MHz	[1-2]	[2-3]	[1-2]
100MHz	[1-2]	[1-2]	[2-3]

CPU Types

CPU Type	BF0	BF1	BF2
CPU A	[1-2]	[1-2]	[1-2]
CPU B	[1-2]	[2-3]	[1-2]
CPU C	[1-2]	[1-2]	[2-3]
CPU D	[1-2]	[2-3]	[2-3]
CPU E	[1-2]	[1-2]	[2-3]

CPU : BUS Frequency Ratio

Ratio	CPU A	CPU B	CPU C	CPU D	CPU E
1.5x(3/2)	[1-2]	[1-2]	[1-2]	[1-2]	[1-2]
2.0x(2/1)	[1-2]	[2-3]	[1-2]	[1-2]	[1-2]
3.0x(3/1)	[1-2]	[1-2]	[2-3]	[1-2]	[1-2]
2.5x(5/2)	[1-2]	[2-3]	[1-2]	[2-3]	[1-2]
4.0x(4/1)	[1-2]	[2-3]	[2-3]	[2-3]	[1-2]
4.5x(9/2)	[1-2]	[1-2]	[2-3]	[2-3]	[2-3]

Match the "Ratio" column of the table on the opposite page to these CPU types:

III. INSTALLATION

Set the jumpers by the Internal speed of the Intel, AMD, IBM, or Cyrix CPU as follows:

CPU Model	Freq.	Ratio	(BUS Freq.)			(Freq. Ratio)			
			BUS Freq.	FS2	FS1	FS0	BF0	BF1	BF2
Intel Pentium P54C	166MHz	A-2.5x	66MHz	[2-3]	[2-3]	[1-2]	[2-3]	[2-3]	[1-2]
Intel Pentium P54C	150MHz	A-2.5x	60MHz	[2-3]	[2-3]	[2-3]	[2-3]	[2-3]	[1-2]
Intel Pentium P54C	133MHz	A-2.0x	66MHz	[2-3]	[2-3]	[1-2]	[2-3]	[1-2]	[1-2]
Intel Pentium P54C	120MHz	A-2.0x	60MHz	[2-3]	[2-3]	[2-3]	[2-3]	[1-2]	[1-2]
Intel Pentium P54C	100MHz	A-1.5x	66MHz	[2-3]	[2-3]	[1-2]	[1-2]	[1-2]	[1-2]
Intel Pentium P54C	90MHz	A-1.5x	60MHz	[2-3]	[2-3]	[2-3]	[1-2]	[1-2]	[1-2]
AMD-K5-PR13	100MHz	A-1.5x	66MHz	[2-3]	[2-3]	[1-2]	[1-2]	[1-2]	[1-2]
AMD-K5-PR120	90MHz	A-1.5x	60MHz	[2-3]	[2-3]	[2-3]	[1-2]	[1-2]	[1-2]
AMD-K5-PR100	100MHz	A-1.5x	66MHz	[2-3]	[2-3]	[1-2]	[1-2]	[1-2]	[1-2]
AMD-K5-PR90	90MHz	A-1.5x	60MHz	[2-3]	[2-3]	[2-3]	[1-2]	[1-2]	[1-2]
Intel Pentium P55C	233MHz	B-3.5x	66MHz	[2-3]	[2-3]	[1-2]	[1-2]	[1-2]	[1-2]
Intel Pentium P55C	200MHz	B-3.0x	66MHz	[2-3]	[2-3]	[1-2]	[1-2]	[2-3]	[1-2]
Intel Pentium P55C	166MHz	B-2.5x	66MHz	[2-3]	[2-3]	[1-2]	[2-3]	[2-3]	[1-2]
IBM/Cyrix 6x86MX-PR233	200MHz	B-3.0x	66MHz	[2-3]	[2-3]	[1-2]	[1-2]	[2-3]	[1-2]
IBM/Cyrix 6x86MX-PR233	166MHz	B-2.0x	83MHz	[1-2]	[2-3]	[1-2]	[2-3]	[1-2]	[1-2]
IBM/Cyrix 6x86MX-PR200	166MHz	B-2.5x	66MHz	[2-3]	[2-3]	[1-2]	[2-3]	[2-3]	[1-2]
IBM/Cyrix 6x86MX-PR200	150MHz	B-2.0x	75MHz	[1-2]	[2-3]	[2-3]	[2-3]	[1-2]	[1-2]
IBM/Cyrix 6x86MX-PR166	150MHz	B-2.5x	60MHz	[2-3]	[2-3]	[2-3]	[2-3]	[2-3]	[1-2]
*IBM/Cyrix 6x86-PR166+	133MHz	C-2.0x	66MHz	[2-3]	[2-3]	[1-2]	[2-3]	[1-2]	[1-2]
*IBM/Cyrix 6x86L-PR166+	133MHz	D-2.0x	66MHz	[2-3]	[2-3]	[1-2]	[2-3]	[1-2]	[1-2]
AMD-K6-PR300	300MHz	E-4.5x	66MHz	[2-3]	[2-3]	[1-2]	[2-3]	[2-3]	[2-3]
AMD-K6-PR266	266MHz	E-4.0x	66MHz	[2-3]	[2-3]	[1-2]	[2-3]	[1-2]	[2-3]
AMD-K6-PR233	233MHz	E-3.5x	66MHz	[2-3]	[2-3]	[1-2]	[1-2]	[1-2]	[1-2]
AMD-K6-PR200	200MHz	E-3.0x	66MHz	[2-3]	[2-3]	[1-2]	[1-2]	[2-3]	[1-2]
AMD-K6-PR166	166MHz	E-2.5x	66MHz	[2-3]	[2-3]	[1-2]	[2-3]	[2-3]	[1-2]

***NOTE:** The only IBM or Cyrix 6x86(L or M1) that is supported on this motherboard is Rev 2.7 or later. Look on the underside of the CPU for the serial number. The number should read G8DC6620A or later.

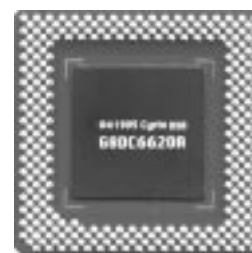

III. INSTALLATION

5. Voltage Regulator Output Selection (VID0, 1, 2, 3)

These jumpers set the voltage supplied to the CPU.

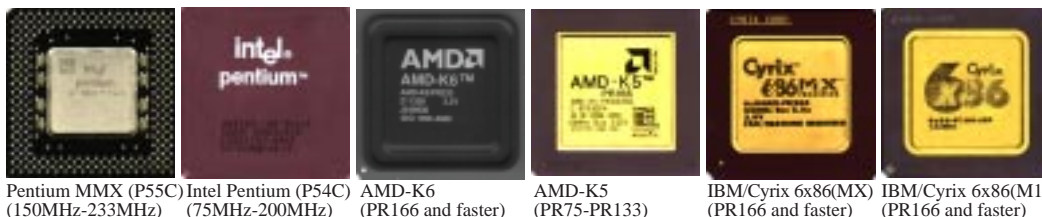

WARNING! Because CPU designs change rapidly, the following chart is only intended as a simple guideline and is not intended to be true for your CPU. Look for the CPU voltage included with your CPU and follow the Voltage setting diagrammed below the chart.

Manufacturer	CPU Type	Single Plane	Dual Plane	VID3	VID2	VID1	VID0
Intel	P54C/P54CS	3.5V(VRE)	----	[1-2]	[1-2]	[1-2]	[1-2]
AMD	K5	3.5V(VRE)	----	[1-2]	[1-2]	[1-2]	[1-2]
IBM/Cyrix	6x86	3.5V(VRE)	----	[1-2]	[1-2]	[1-2]	[1-2]
Intel	P54C/P54CS	3.4V(STD)	----	[1-2]	[1-2]	[1-2]	[2-3]
AMD	K5	3.4V(STD)	----	[1-2]	[1-2]	[1-2]	[2-3]
AMD(.35 micron)	K6-PR233	----	3.2V(Dual)	[1-2]	[1-2]	[2-3]	[2-3]
AMD(.35 micron)	K6-166,200	----	2.9V(Dual)	[1-2]	[2-3]	[2-3]	[1-2]
IBM/Cyrix	6x86MX	----	2.9V(Dual)	[1-2]	[2-3]	[2-3]	[1-2]
Intel	P55C-MMX	----	2.8V(Dual)	[1-2]	[2-3]	[2-3]	[2-3]
AMD (.25micron)	K6-233,266,300	----	2.2V(Dual)	[2-3]	[2-3]	[1-2]	[2-3]

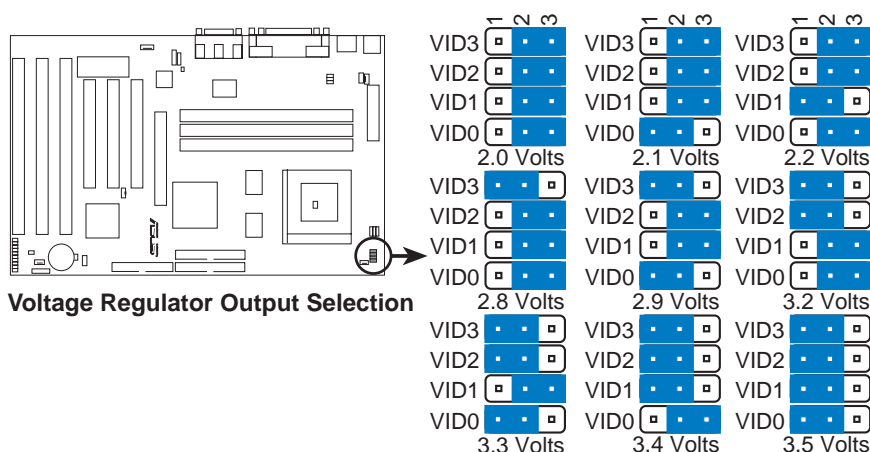

III. INSTALLATION

2. System Memory (DIMM)

Only Dual Inline Memory Modules (DIMMs) can be used with this motherboard. Three sockets are available for **3.3Volt** (power level) Unbuffered Synchronous DRAMs (SDRAMs; 8, 16, 32, 64, or 128MB) or EDO DRAM (8, 16, 32, 64, 128, or 256MB) to form a memory size between 8MB to 768MB. One side (with memory chips) of the DIMM module takes up one Row on the motherboard. If ECC-supported DIMM is used, you can enable the ECC function through BIOS setup – CHIPSET FEATURES SETUP “Data Integrity Mode.”

IMPORTANT: You must first set the memory speed through the “EDO/FPM Configuration” under the BIOS Chipset Setup of the BIOS SOFTWARE.

Install memory in any combination as follows:

DIMM	Type	168-pin DIMM Memory Modules		Total Memory
Socket 1 (Rows 0&1)	SDRAM	8, 16, 32, 64, 128MB	x1	
	EDO	8, 16, 32, 64, 128, 256MB		
Socket 2 (Rows 2&3)	SDRAM	8, 16, 32, 64, 128MB	x1	
	EDO	8, 16, 32, 64, 128, 256MB		
Socket 3 (Rows 4&5)	SDRAM	8, 16, 32, 64, 128MB	x1	
	EDO	8, 16, 32, 64, 128, 256MB		
Total System Memory (Max 768MB)			=	

WARNING: Memory modules must have 18 chips or less. Memory modules with more than 18 chips will cause unstable operation.

ASUS DIMM Module Examples:



ECC EDO DIMM (9 chips)

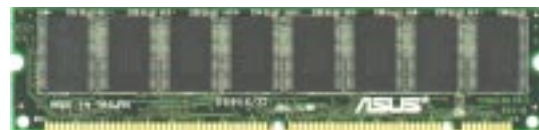

Non-ECC SDRAM DIMM (8 chips)

General DIMM Notes: (not true for all memory modules)

- Four possible memory chips are supported: EDO or SDRAM with and without parity.
- SDRAM chips are generally thinner with higher pin density than EDO chips.
- BIOS shows EDO or SDRAM memory on bootup screen.
- 8 chip/side modules do not support parity, only 9 chip/side modules support parity.
- Single sided modules are usually 16 or 64 MB, double sided are usually 8, 32, or 128MB.

III. INSTALLATION

DIMM Memory Installation Procedures:

Insert the module(s) as shown. Because the number of pins are different on either side of the breaks, the module will only fit in the orientation as shown. DRAM SIMM modules have the same pin contact on both sides. SDRAM DIMM modules have different pin contact on each side and therefore have a higher pin density.

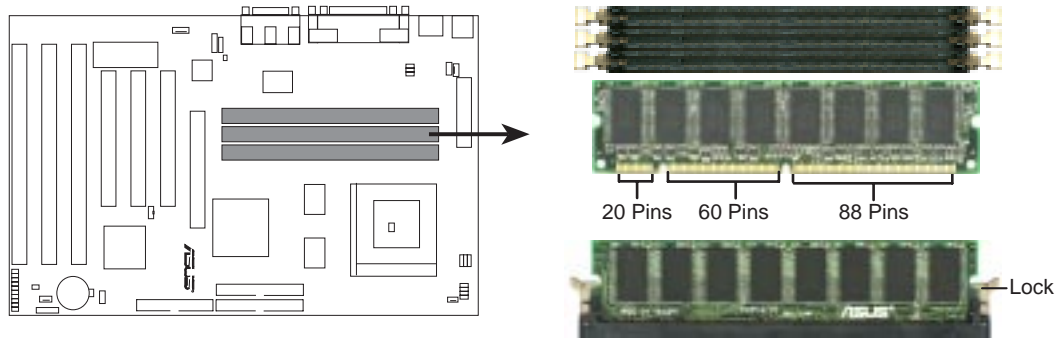

168 Pin DIMM Memory Sockets

The Dual Inline Memory Module (DIMM) memory modules must be 3.3Volt Unbuffered Synchronous DRAM (SDRAM) or Extended Data Output (EDO) . You can identify the type of DIMM module by the illustration below:

168-Pin DIMM Notch Key Definitions (3.3V)

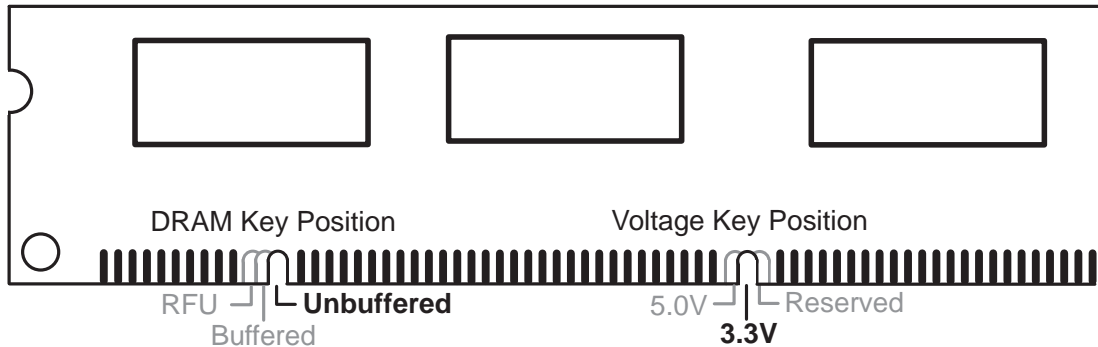

The notch on the DIMM module will shift between left, center, or right to identify the type and also to prevent the wrong type to be inserted into the DIMM slot on the motherboard. You must ask your retailer for the specifications before purchasing. Four clock signals are supported on this motherboard.

III. INSTALLATION

(This page was intentionally left blank)

III. INSTALLATION

3. Central Processing Unit (CPU)

The motherboard provides a 321-pin ZIF Socket 7 that is backwards compatible with ZIF Socket 5 processors. The CPU that came with the motherboard should have a fan attached to it to prevent overheating. If this is not the case then purchase a fan before you turn on your system. Apply thermal jelly to the CPU top and then install the fan onto the CPU.

WARNING! Without a fan circulating air on the CPU and heat sinks, the CPU and/or heat sinks can overheat and cause damage to both the CPU and the motherboard. (See “CPU Cooling Fan Connector” at the end of this section.)

To install a CPU, first turn off your system and remove its cover. Locate the ZIF socket and open it by first pulling the lever sideways away from the socket then upwards to a 90-degree right angle. Insert the CPU with the correct orientation as shown. Use the notched corner of the CPU as your guide. The white dot should point towards the end the of the lever. Notice that there is a blank area where one hole is missing from that corner of the square array of pin holes and a “1” printed on the motherboard next to that corner. Because the CPU has a corner pin for three of the four corners, the CPU will only fit in the one orientation as shown. The picture is for reference only; you should have a CPU fan that will cover the face of the CPU. With the added weight of the CPU fan, no force is required to insert the CPU. Once completely inserted, hold down on the fan and close the socket’s lever.

IMPORTANT: You must set jumpers for “CPU to BUS Frequency Ratio” and jumpers for “BUS Frequency Selection” depending on the CPU that you install.

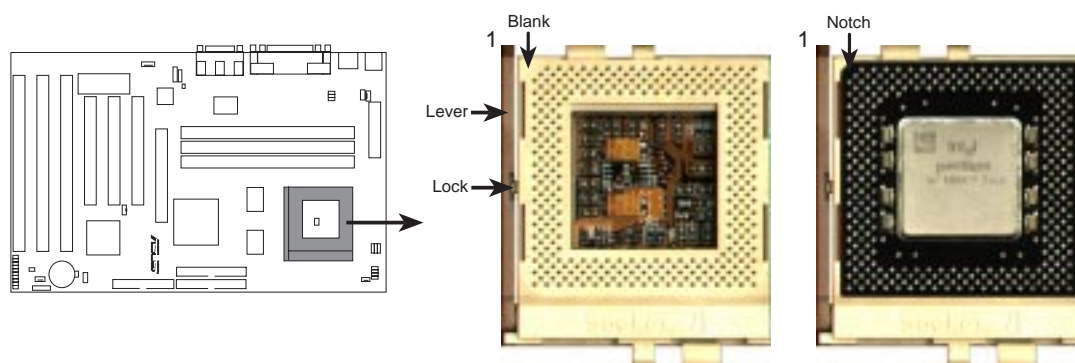

ZIF Socket 7 with Pentium MMX Processor

III. INSTALLATION

4. Expansion Cards

WARNING! Make sure that you unplug your power supply when adding or removing expansion cards or other system components. Failure to do so may cause severe damage to both your motherboard and expansion cards.

Expansion Card Installation Procedure:

1. Read your expansion card documentation on any hardware and software settings that may be required to setup your specific card.
2. Set any necessary jumpers on your expansion card.
3. Remove your computer system's cover.
4. Remove the bracket on the slot you intend to use.
Keep the bracket for possible future use.
5. Carefully align the card's connectors and press firmly.
6. Secure the card on the slot with the screw you removed in step 4.
7. Replace the computer system's cover.
8. Edit the BIOS settings if necessary.
(such as "IRQ xx Used By ISA: Yes" in PNP AND PCI SETUP)
9. Install the necessary software drivers for your expansion card.

Assigning IRQs for Expansion Cards

Some expansion cards need to use an IRQ to operate. Generally an IRQ must be exclusively assigned to one use. In a standard design there are 16 IRQs available but most of them are already in use by parts of the system which leaves 6 free for expansion cards.

Both ISA and PCI expansion cards may need to use IRQs. System IRQs are available to cards installed in the ISA expansion bus first, and any remaining IRQs are then used by PCI cards. Currently, there are two types of ISA cards. The original ISA expansion card design, now referred to as "Legacy" ISA cards, requires that you configure the card's jumpers manually and then install it in any available slot on the ISA bus. You may use Microsoft's Diagnostic (MSD.EXE) utility included in the Windows directory to see a map of your used and free IRQs. For Windows 95 users, the "Control Panel" icon in "My Computer," contains a "System" icon which gives you a "Device Manager" tab. Double clicking on a specific device gives you the "Resources" tab, which shows the Interrupt number and address. Make sure that no two devices use the same IRQs or your computer will experience problems when those two devices are in use at the same time.

III. INSTALLATION

To simplify this process this motherboard has complied with the Plug and Play (PNP) specification which was developed to allow automatic system configuration whenever a PNP-compliant card is added to the system. For PNP cards, IRQs are assigned automatically from those available.

If the system has both Legacy and PNP ISA cards installed, IRQs are assigned to PNP cards from those not used by Legacy cards. The PCI and PNP configuration of the BIOS setup utility can be used to indicate which IRQs are being used by Legacy cards. For older Legacy cards that does not work with the BIOS, you can contact your vendor for an ISA Configuration Utility.

An IRQ number is automatically assigned to PCI expansion cards after those used by Legacy and PNP ISA cards. In the PCI bus design, the BIOS automatically assigns an IRQ to a PCI slot that has a card in it that requires an IRQ. To install a PCI card, you need to set the INT (interrupt) assignment. Since all the PCI slots on this motherboard use an INTA #, set the jumpers on your PCI cards to INT A.

Assigning DMA Channels for ISA Cards

Some ISA cards, both legacy and PnP, may also need to use a DMA (Direct Memory Access) channel. DMA assignments for this motherboard are handled the same way as the IRQ assignment process described earlier. You can select a DMA channel in the PCI and PnP configuration section of the BIOS Setup utility.

IMPORTANT: To avoid conflicts, reserve the necessary IRQs and DMAs for legacy ISA cards (under PNP AND PCI SETUP of the BIOS SOFTWARE, choose *Yes* in *IRQ xx Used By ISA* and *DMA x Used By ISA* for those IRQs and DMAs you want to reserve).

ISA Cards and Hardware Monitor

The onboard hardware monitor uses the address 290H-297H so legacy ISA cards must not use this address or else conflicts will occur.

Accelerated Graphics Port

This motherboard provides an accelerated graphics port (AGP) slot to support a new generation of graphics cards with ultra-high memory bandwidth, such as the ASUS AGP-V264GT3 and ASUS AGP-V3000.

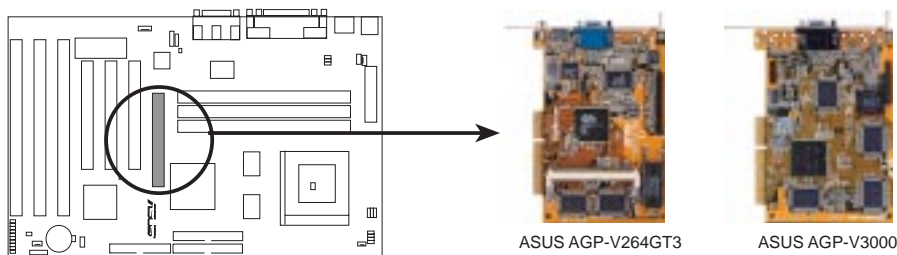

Accelerated Graphics Port (AGP)

III. INSTALLATION

5. External Connectors

WARNING! Some pins are used for connectors or power sources. These are clearly distinguished from jumpers in the Motherboard Layout. Placing jumper caps over these connector pins will cause damage to your motherboard.

IMPORTANT: Ribbon cables should always be connected with the red stripe on the Pin 1 side of the connector. The four corners of the connectors are labeled on the motherboard. Pin 1 is the side closest to the power connector on hard drives and floppy drives. IDE ribbon cable must be less than 46cm(18in.), with the second drive connector no more than 15cm (6in.) from the first connector.

1. PS/2 Keyboard Connector (6-pin Female)

This connection is for a standard keyboard using an PS/2 plug (mini DIN). **This connector will not allow standard AT size (large DIN) keyboard plugs. You may use a DIN to mini DIN adapter on standard AT keyboards.**

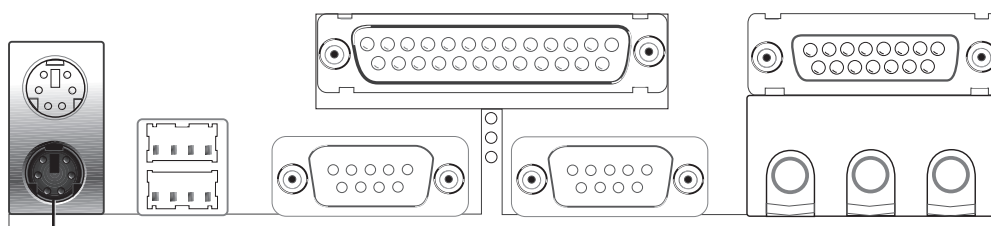

PS/2 Keyboard (6-pin Female)

2. PS/2 Mouse Connector (6-pin Female)

The system will direct IRQ12 to the PS/2 mouse if one is detected. If not detected, expansion cards can use IRQ12. See “PS/2 Mouse Control” in BIOS Features Setup of the BIOS SOFTWARE.

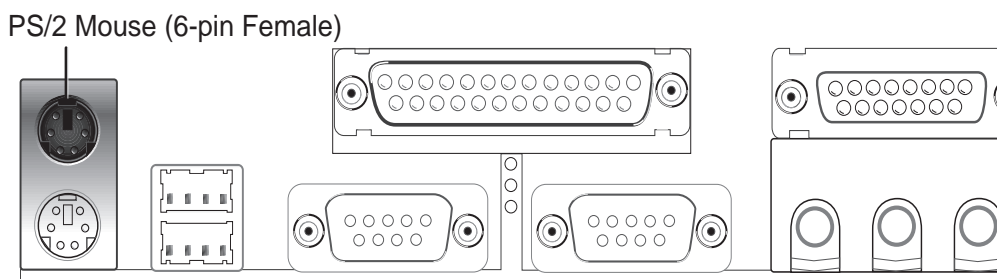

PS/2 Mouse (6-pin Female)

III. INSTALLATION

3. Parallel Port Connector (25-pin Female)

You can enable the parallel port and choose the IRQ through “Onboard Parallel Port” in Chipset Features Setup of the BIOS SOFTWARE.

NOTE: Serial printers must be connected to the serial port.

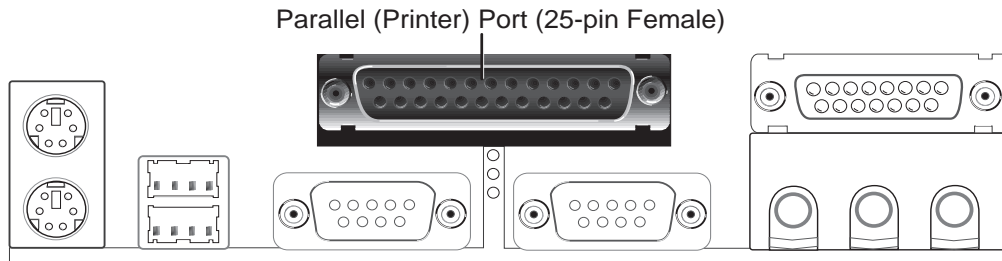

4. Serial Port COM1 and COM2 Connectors (Two 9-pin Male)

The two serial ports can be used for pointing devices or other serial devices. See “Onboard Serial Port” in Chipset Features Setup of the BIOS SOFTWARE.

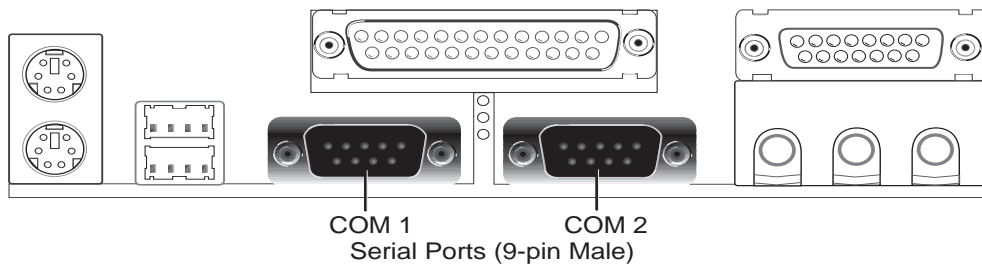

5. Floppy Disk Drive Connector (34-1pin FLOPPY)

This connector supports the provided floppy drive ribbon cable. After connecting the single end to the board, connect the two plugs on the other end to the floppy drives. **(Pin 5 is removed to prevent inserting in the wrong orientation when using ribbon cables with pin 5 plugged).**

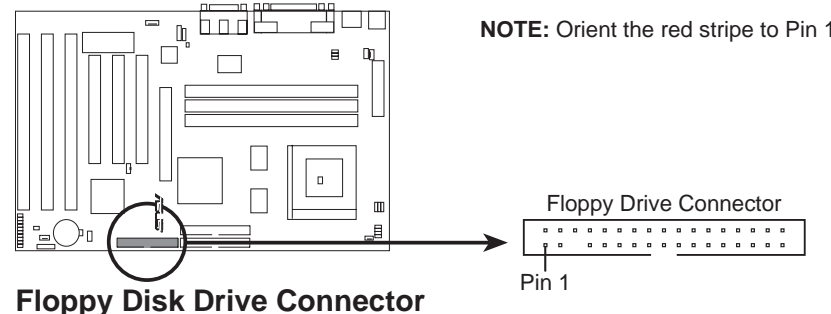

III. INSTALLATION

6. **Audio Port Connectors (Three 1/8" Female)** (with optional onboard audio)
Line Out can be connected to headphones or preferably powered speakers. **Line In** allows tape players or other audio sources to be recorded by your computer or played through the **Line Out**. **Mic** allows microphones to be connected for inputting voice.

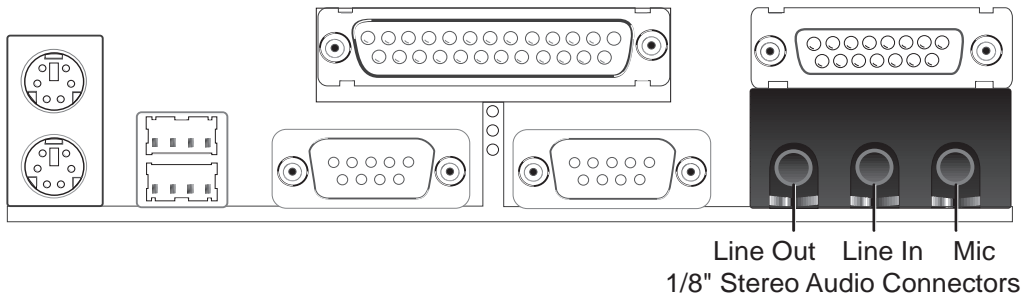

7. **Joystick/Midi Connector (15-pin Female)** (with optional onboard audio)
You may connect game joysticks or game pads to this connector for playing games. Connect Midi devices for playing or editing audio.

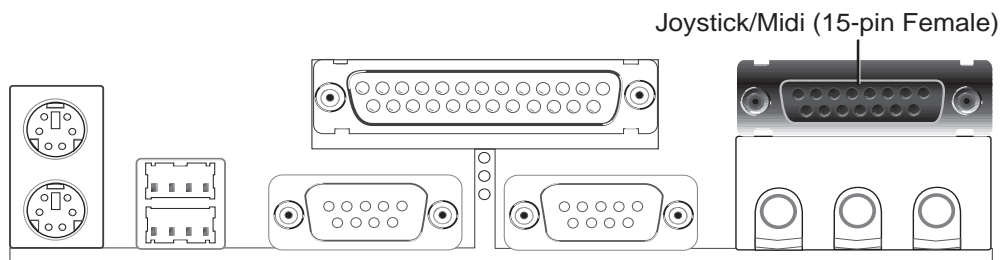

8. **Universal Serial BUS Ports 1 & 2 (Two 4-pin Female Sockets)**
Two USB ports are available for connecting USB devices.

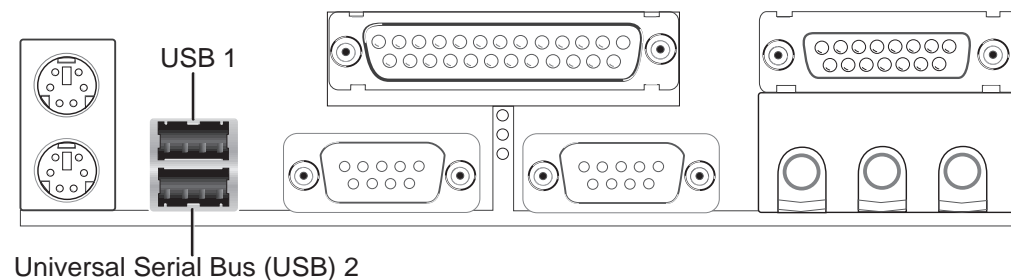

III. INSTALLATION

9. Primary / Secondary IDE connectors (Two 40-1pin IDE)

These connectors support the provided IDE hard disk ribbon cable. After connecting the single end to the board, connect the two plugs at the other end to your hard disk(s). If you install two hard disks, you must configure the second drive to Slave mode by setting its jumper accordingly. Please refer to the documentation of your hard disk for the jumper settings. BIOS now supports SCSI device or IDE CD-ROM bootup (see “HDD Sequence SCSI/IDE First” & “Boot Sequence” in the **BIOS Features Setup** of the BIOS SOFTWARE) (**Pin 20 is removed to prevent inserting in the wrong orientation when using ribbon cables with pin 20 plugged**).

TIP: You may configure two hard disks to be both Masters using one ribbon cable on the primary IDE connector and another ribbon cable on the secondary IDE connector. You may install one operating system on an IDE drive and another on a SCSI drive and select the boot disk through BIOS Features Setup.

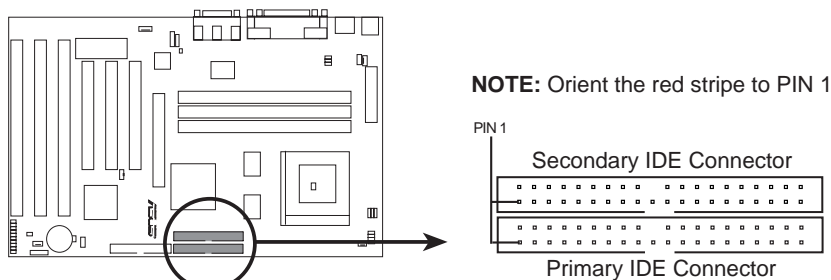

IDE Connectors

10. IDE activity LED (2-pin IDELED)

This connector supplies power to the cabinet’s IDE activity LED. Read and write activity by devices connected to the Primary or Secondary IDE connectors will cause the LED to light up.

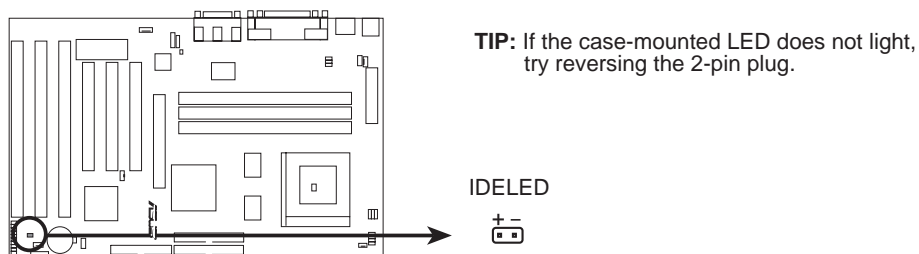

IDE Activity LED

III. INSTALLATION

11. Chassis, CPU, & Power Supply Fan Connectors (3-pin CHA_, CPU_, PWR_FAN)

These connectors support cooling fans of 500mAMP (6 Watts) or less. Orientate the fans so that the heat sink fins allow airflow to go across the onboard heat sink(s) instead of the expansion slots. Depending on the fan manufacturer, the wiring and plug may be different. The red wire should be positive, while the black should be ground. Connect the fan's plug to the board taking into consideration the polarity of the this connector. **NOTE: The "Rotation" signal is to be used only by a specially designed fan with rotation signal.**

WARNING! The CPU and/or motherboard will overheat if there is no airflow across the CPU and onboard heatsinks. Damage may occur to the motherboard and/or the CPU fan if these pins are incorrectly used. **These are not jumpers, do not place jumper caps over these pins.**

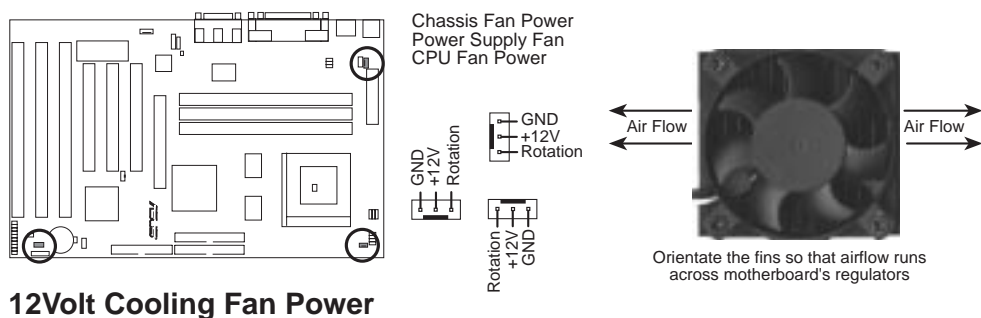

12Volt Cooling Fan Power

12. Modem Connector (4-pin MDM) (with optional onboard audio)

This connector connects to a compatible modem.

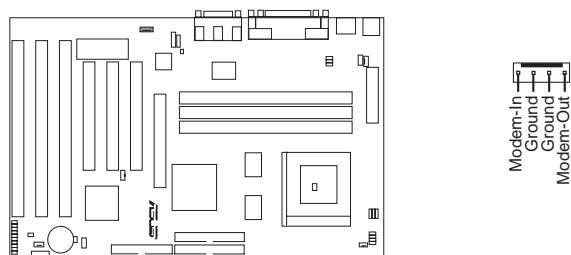

Onboard Modem Connector

III. INSTALLATION

13. IrDA / Fast IR-Compliant infrared module connector (5-pin IR)

This connector supports the optional wireless transmitting and receiving infrared module. This module mounts to a small opening on system cases that support this feature. You must also configure the setting through “UART2 Use Infrared” in **Chipset Features Setup** to select whether UART2 is directed for use with COM2 or IrDA. Use the five pins as shown on the Back View and connect a ribbon cable from the module to the motherboard according to the pin definitions.

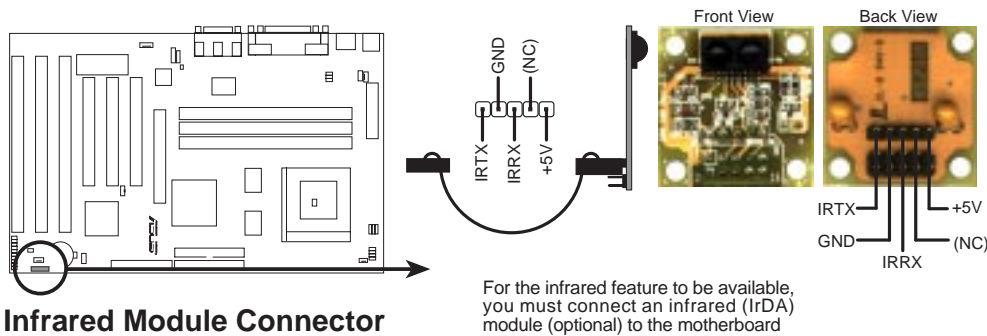

14. ATX Power Supply Connector (20-pin block ATXPWR)

This connector connects to a ATX power supply. The plug from the power supply will only insert in one orientation because of the different hole sizes. Find the proper orientation and push down firmly making sure that the pins are aligned.

IMPORTANT: Make sure that your ATX power supply can supply at least 10mA on the 5-volt standby lead (5VSB). You may experience difficulty in powering on your system if your power supply cannot support the load. For Wake on LAN support, your ATX power supply must supply at least 720mA.

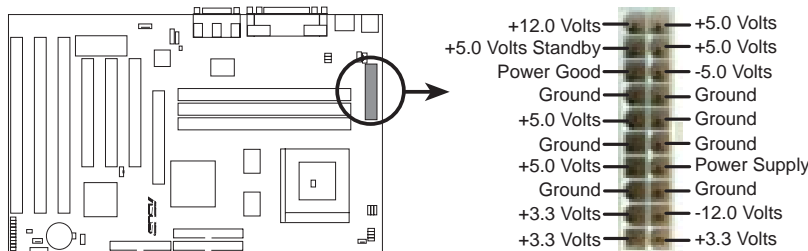

ATX Power Connector

III. INSTALLATION

15. Wake on LAN (3-pin WOL)

The WAKE_LAN connector allows the system to power up when there is a wakeup package (signal) received from the network through the ASUS PCI-L101 LAN card. Requires the ASUS PCI-L101 and an ATX power supply with at least 720mA +5VSB.

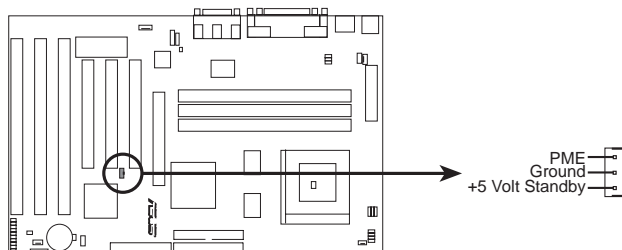

Wake On LAN Connector

16. Stereo audio in connector (4-pin CD1) (with optional onboard audio)

This connector allows you to receive stereo audio input from a such sound sources as TV tuner or MPEG card.

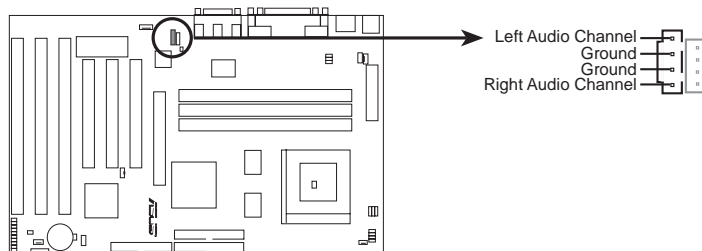

Analog Audio Line Out Connector

17. Stereo audio in connector (4-pin CD2) (with optional onboard audio)

This connector allows you attach the audio cable from your CD-ROM drive for stereo audio input.

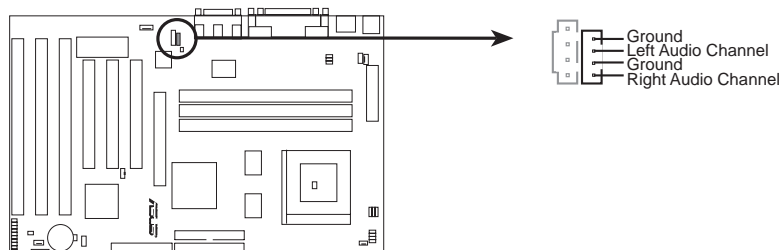

CD In Connector

III. INSTALLATION

18. Message LED Lead (MSG.LED, 2 pins)

This indicates whether a message has been received from a fax/modem. The LED will remain lit when there is no signal and blink when data are being transfer or messages are waiting in the inbox. This function requires ACPI OS support.

19. SMI Suspend Switch Lead (SMI, 2 pins)

This allows the user to manually place the system into a suspend mode or “Green” mode where system activity will be instantly decreased to save electricity and expand the life of certain components when the system is not in use. This 2-pin connector (see the figure below) connects to the case-mounted suspend switch. If you do not have a switch for the connector, you may use the “Turbo Switch” since it does not have a function. SMI is activated when it detects a *short to open* moment and therefore leaving it shorted will not cause any problems. May require one or two pushes depending on the position of the switch. Wake-up can be controlled by settings in the BIOS but the keyboard will always allow wake-up (the SMI lead cannot wake-up the system). If you want to use this connector, “Suspend Switch” in the **Power Management Setup** of the BIOS SOFTWARE section should be on the default setting of *Enable*.

20. ATX Power Switch / Soft Power Switch (PWR, 2 pins)

The system power is controlled by a momentary switch connected to this lead. Pushing the button once will switch the system between ON and SLEEP. Pushing the switch while in the ON mode for more than 4 seconds will turn the system off. The system power LED shows the status of the system’s power.

21. Reset Switch Lead (RESET, 2 pins)

This 2-pin connector connects to the case-mounted reset switch for rebooting your computer without having to turn off your power switch. This is a preferred method of rebooting in order to prolong the life of the system’s power supply.

22. System Power LED (KEYLOCK, 3 pins)

This 3-pin connector connects the system power LED, which lights when the system is powered on and blinks when it is in sleep mode.

23. Keyboard Lock Switch Lead (KEYLOCK, 2 pins)

This 2-pin connector connects to the case-mounted key switch to allow keyboard locking.

24. Speaker Connector (SPEAKER, 4 pins)

This 4-pin connector connects to the case-mounted speaker.

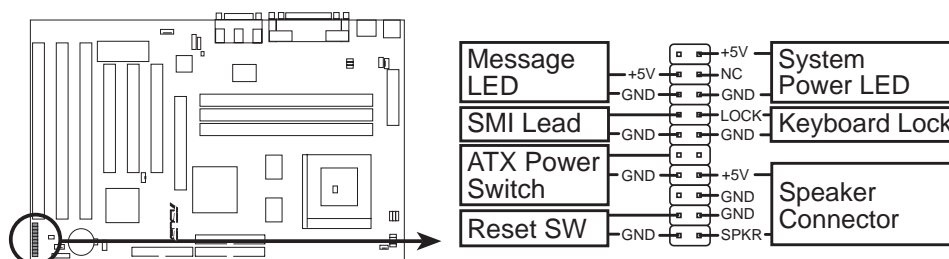

System Panel Connectors

III. INSTALLATION

Power Connection Procedures

1. After all jumpers and connections are made, close the system case cover.
 2. Be sure that all switches are off (in some systems, marked with ○).
 3. Connect the power supply cord into the power supply located on the back of your system case according to your system user's manual.
 4. Connect the power cord into a power outlet that is equipped with a surge protector.
 5. You may then turn on your devices in the following order:
 - a. Your monitor
 - b. External SCSI devices (starting with the last device on the chain)
 - c. Your system power. For ATX power supplies, you need to switch on the power supply as well as press the ATX power switch on the front of the case.
 6. The power LED on the front panel of the system case will light. For ATX power supplies, the system LED will light when the ATX power switch is pressed. The monitor LED may light up after the system's if it complies with "green" standards or if it has a power standby feature. The system will then run power-on tests. While the tests are running, additional messages will appear on the screen. If you do not see anything within 30 seconds from the time you turn on the power, the system may have failed a power-on test. Recheck your jumper settings and connections or call your retailer for assistance.
 7. During power-on, hold down <Delete> to enter BIOS setup. Follow the instructions in the next section, BIOS SOFTWARE.
- * **Powering Off your computer:** You must first exit or shut down your operating system before switching off the power switch. For ATX power supplies, you can press the ATX power switch after exiting or shutting down your operating system. If you use Windows 95, click the **Start** button, click **Shut Down**, and then click **Shut down the computer?**. The system will give three quick beeps after about 30 seconds and then power off after Windows shuts down.

NOTE: The message "You can now safely turn off your computer" will not appear when shutting down with ATX power supplies.

IV. BIOS SOFTWARE

Support Software

FILELIST.TXT - View this file to see the files included in the support software.

PFLASH.EXE - This is the Flash Memory Writer utility that updates the BIOS by uploading a new BIOS file to the programmable flash ROM chip on the motherboard. To determine the BIOS version, check the last four numbers of the code displayed on the upper left-hand corner of your screen during bootup. Larger numbers represent a newer BIOS file.

NOTE: A binary BIOS file is no longer included with the support software. Save the motherboard's BIOS file to a floppy disk as soon as your system is operational. See "Flash Memory Writer Utility" in this section to "Save Current BIOS to File."

Flash Memory Writer Utility

The flash memory writer utility must be run while the system is in **real mode**. In particular, the "Update BIOS Main Block From File" and "Update BIOS Including Boot Block and ESCD" options require real mode. To run this utility, boot from a system floppy disk without the AUTOEXEC.BAT and CONFIG.SYS files.

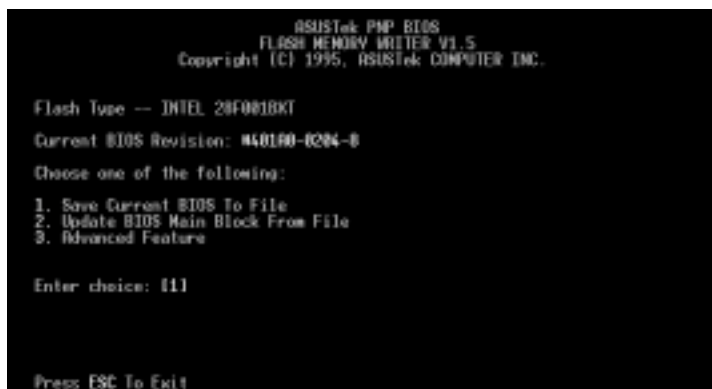

```
ASUStek PnP BIOS
FLASH MEMORY WRITER V1.5
Copyright (C) 1995, ASUStek COMPUTER INC.

Flash Type -- INTEL 28F010KT
Current BIOS Revision: #40160-1004-0
Choose one of the following:
1. Save Current BIOS To File
2. Update BIOS Main Block From File
3. Advanced Feature

Enter choice: 111

Press ESC To Exit
```

IMPORTANT: If "unknown" is displayed after **Flash Type --**, the memory chip is not programmable or is not supported with the PnP BIOS and therefore cannot be programmed by the Flash Memory Writer utility.

Main Menu

1. Save Current BIOS To File

This option allows you to copy the contents of the flash memory onto a floppy disk. This gives you a backup copy of the original motherboard BIOS in case you need to reinstall it. Create a bootable DOS diskette without AUTOEXEC.BAT and CONFIG.SYS and save both PFLASH.EXE and the BIOS file(s) to it. **Note:** BIOS FEATURES SETUP Boot Sequence needs to be set to A first in order to boot from your disk drive A.

IV. BIOS SOFTWARE

```
Update BIOS Main Block from File

Flash Type -- INTEL 28F001BKT
Current BIOS Revision: 040100-0204-B
Please Enter File Name for NEW BIOS: a:\0205.000
Are you Sure (Y/N) ? [Y]

Boot Block of New BIOS is different from old one !!!
Please Use 'Advanced Feature' to flash whole bios !!!

Press ESC To Return to Main Menu
```

3. Advanced Features

This option displays the Advanced Features screen for clearing the PnP configuration record and updating the motherboard BIOS.

Advanced Features Menu

```
Advanced Feature

Flash Type -- INTEL 28F001BKT
Current BIOS Revision: 040100-0204-B
Choose one of the following:
1. Clear PNP ESCD Parameter Block
2. Update BIOS Including Boot Block and ESCD

Enter choice: [2]

Press ESC To Return to Main Menu
```

1. Clear PNP ESCD Parameter Block

This option erases the Plug-and-Play (PnP) configuration record.

2. Update BIOS Including Boot Block and ESCD

This option updates the boot block, the baseboard BIOS, and the PnP extended system configuration data- (ESCD) parameter block from a new BIOS file.

```
Update BIOS Including Boot Block and ESCD

Flash Type -- INTEL 28F001BKT
Current BIOS Revision: 040100-0204-B
Please Enter File Name for NEW BIOS: 0205.000
Are you Sure (Y/N) ? [Y]

Block Erasing -- Done
Programming -- 1FFF
Block Erasing -- Done
Programming -- 10FF

Flashed Successfully

Press ESC To Continue
```

IV. BIOS SOFTWARE

Managing and Updating Your Motherboard's BIOS

Upon First Use of the Computer System

1. Create a bootable system floppy diskette by typing [FORMAT A:/S] from the DOS prompt without creating "AUTOEXEC.BAT" and "CONFIG.SYS" files.
2. Copy PFLASH.EXE to your new diskette.
3. Run PFLASH.EXE from your new diskette and select option 1 "Save Current BIOS to File." Enter the "Current BIOS Revision:" for the file name.

Updating BIOS (only when necessary)

IMPORTANT: If "unknown" is displayed after **Flash Type --**, the memory chip is not programmable or is not supported with the PnP BIOS and therefore cannot be programmed by the Flash Memory Writer utility.

1. Download an updated ASUS BIOS file from the Internet (WWW or FTP) or a BBS (Bulletin Board Service) (see ASUS CONTACT INFORMATION on page 3 for details) and save to the disk you created earlier.
2. Turn off your computer.
3. Boot from the disk you created earlier.
4. At the "A:\\" prompt, type PFLASH and then press <Enter>.
5. Enter 2 "Update BIOS Main Block From File" from the Main Menu or option 2 "Update BIOS Including Boot Block and ESCD" from the Advanced Features Menu if prompted by option 2 of the Main Menu.
6. The program displays a second screen prompting you for the name of the BIOS file. Type in the complete file name and extension of the new BIOS, and then press <Enter>. The utility then updates the BIOS file from disk.

WARNING! If you encounter problems while updating the new BIOS, DO NOT turn off your system since this might prevent your system from booting up. Just repeat the process, and if the problem still persists, update the original BIOS file you saved to disk above. If the Flash Memory Writer utility was not able to successfully update a complete BIOS file, your system may not be able to boot up. If this happens, your system will need service.

7. After successfully updating the new BIOS file, exit the Flash Memory Writer utility and then turn off your system.
8. Turn on your computer and press <Delete> to enter BIOS setup. You must select "Setup Default" to effect the new BIOS, after which you may set the other items from the Main Menu.

IV. BIOS SOFTWARE

6. BIOS Setup

The motherboard supports two programmable Flash ROM chips: 5 Volt and 12 Volt. Either of these memory chips can be updated when BIOS upgrades are released. Use the Flash Memory Writer utility to download the new BIOS file into the ROM chip as described in detail in this section.

All computer motherboards provide a Setup utility program for specifying the system configuration and settings. If your motherboard came in a computer system, the proper configuration entries may have already been made. If so, invoke the Setup utility, as described later, and take note of the configuration settings for future reference; in particular, the hard disk specifications.

If you are installing the motherboard, reconfiguring your system or you receive a Run Setup message, you will need to enter new setup information. This section describes how to configure your system using this utility.

The BIOS ROM of the system stores the Setup utility. When you turn on the computer, the system provides you with the opportunity to run this program. This appears during the Power-On Self Test (POST). Press <Delete> to call up the Setup utility. If you are a little bit late pressing the mentioned key(s), POST will continue with its test routines, thus preventing you from calling up Setup. If you still need to call Setup, reset the system by pressing <Ctrl> + <Alt> + <Delete>, or by pressing the Reset button on the system case. You can also restart by turning the system off and then back on again. But do so only if the first two methods fail.

When you invoke Setup, the CMOS SETUP UTILITY main program screen will appear with the following options:



IV. BIOS SOFTWARE

Load Defaults

The **Load BIOS Defaults** option loads the minimum settings for troubleshooting. **Load Setup Defaults**, on the other hand, is for loading optimized defaults for regular use. Choosing defaults at this level will modify all applicable settings.

A section at the bottom of the preceding screen displays the control keys for this screen. Take note of these keys and their respective uses.

Standard CMOS Setup

Standard CMOS Setup allows you to record some basic system hardware configuration and set the system clock and error handling. If the motherboard is already installed in a working system, you will not need to select this option anymore. However, if the configuration stored in the CMOS memory on the board gets lost or damaged, or if you change your system hardware configuration, you will need to respecify the configuration values. The configuration values usually get lost or corrupted when the power of the onboard CMOS battery weakens.



The preceding screen provides you with a list of options. At the bottom of this screen are the control keys. Take note of these keys and their respective uses.

User-configurable fields appear in a different color. If you need information on the selected field, press <F1>. The help menu will then appear to provide you with the information you need. The memory display at the lower right of the screen is read-only and automatically adjusts accordingly.

Details of Standard CMOS Setup:

Date

To set the date, highlight the “Date” field and then press either <Page Up>/<Page Down> or <+>/<-> to set the current date. Follow the month, day and year format. Valid values for month, day and year are: **Month: (1 to 12), Day: (1 to 31), Year: (up to 2079)**

IV. BIOS SOFTWARE

Time

To set the time, highlight the “Time” field and then press either <Page Up>/<Page Down> or <+>/<-> to set the current time. Follow the hour, minute and second format. Valid values for hour, minute and second are: **(Hour: (00 to 23), Minute: (00 to 59), Second: (00 to 59)**. If you do not want to modify the current time, press <Enter> three times to go to **Hard Disks**.

NOTE: You can bypass the date and time prompts by creating an AUTOEXEC.BAT file. For information on how to create this file, refer to the MS-DOS manual.

Hard Disk Drives

This field records the specifications for all non-SCSI hard disk drives installed in your system. The onboard PCI IDE connectors provide Primary and Secondary channels for connecting up to four IDE hard disks or other IDE devices. Each channel can support up to two hard disks; the first of which is the “master” and the second is the “slave”.

Specifications for SCSI hard disks need not to be entered here since they operate using device drivers and are not supported by any the BIOS. If you install either the optional PCI-SC200 or PCI-SC860 SCSI controller card into the motherboard, see section VI for instructions. If you install other vendor’s SCSI controller card, refer to their respective documentations on how to install the required SCSI drivers.

For IDE hard disk drive setup, you can:

- Use the *Auto* setting for detection during bootup.
- Use the IDE HDD AUTO DETECTION in the main menu to automatically enter the drive specifications.
- Enter the specifications yourself manually by using the “User” option.

The entries for specifying the hard disk type include **CYLS** (number of cylinders), **HEAD** (number of read/write heads), **PRECOMP** (write precompensation), **LANDZ** (landing zone), **SECTOR** (number of sectors) and **MODE**. The **SIZE** field automatically adjusts according to the configuration you specify. The documentation that comes with your hard disk should provide you with the information regarding the drive specifications.

The **MODE** entry is for IDE hard disks only, and can be ignored for MFM and ESDI drives. This entry provides three options: *Normal*, *Large*, *LBA*, or *Auto* (see below). Set **MODE** to the *Normal* for IDE hard disk drives smaller than 528MB; set it to *LBA* for drives over 528MB that support Logical Block Addressing (LBA) to allow larger IDE hard disks; set it to *Large* for drives over 528MB that do not support LBA. *Large* type of drive can only be used with MS-DOS and is very uncommon. Most IDE drives over 528MB support the *LBA* mode.

IV. BIOS SOFTWARE

Auto detection of hard disks on bootup

For each field: Primary Master, Primary Slave, Secondary Master, and Secondary Slave, you can select *Auto* under the TYPE and MODE fields. This will enable auto detection of your IDE hard disk during bootup. This will allow you to change your hard disks (with the power off) and then power on without having to reconfigure your hard disk type. If you use older hard disks that do not support this feature, then you must configure the hard disk in the standard method as described earlier by the “User” option.

NOTE: After the IDE hard disk drive information has been entered into BIOS, new IDE hard disk drives must be partitioned (such as with FDISK) and then formatted before data can be read from and write on. Primary IDE hard disk drives must have its partition set to *active* (also possible with FDISK).

NOTE: SETUP Defaults are noted in parenthesis next to each function heading.

Drive A / Drive B (None)

These fields record the types of floppy disk drives installed in your system. The available options for drives A and B are: *360KB, 5.25 in.; 1.2MB, 5.25 in.; 720KB, 3.5 in.; 1.44MB, 3.5 in.; 2.88MB, 3.5 in.; None*

To enter the configuration value for a particular drive, highlight its corresponding field and then select the drive type using the left- or right-arrow keys.

Floppy 3 Mode Support (Disabled)

This is the Japanese standard floppy drive. The standard stores 1.2MB in a 3.5inch diskette. This is normally disabled but you may choose from either: *Drive A, Drive B, Both, and Disabled*

Video (EGA/VGA)

Set this field to the type of video display card installed in your system. The options are *EGA/VGA, CGA 40, CGA 80, and Mono* (for Hercules or MDA).

If you are using a VGA or any higher resolution card, choose *EGA/VGA*.

Halt On (All Errors)

This field determines which types of errors will cause the system to halt. Choose from *All Errors; No Errors; All,But Keyboard; All,But Diskette; and All,But Disk/Key*.

IV. BIOS SOFTWARE

BIOS Features Setup

BIOS Features Setup consists of configuration entries that allow you to improve your system performance, or let you set up some system features according to your preference. Some entries are required by the motherboard's design to remain in their default settings.



A section at the lower right of the screen displays the control keys you can use. Take note of these keys and their respective uses. If you need information on a particular entry, highlight it and then press <F1>. A pop-up help menu will appear to provide you with the information you need. <F5> loads the last set values, <F6> and <F7> loads the BIOS default values and Setup default values, respectively.

NOTE: SETUP Defaults are noted in parenthesis next to each function heading.

Details of BIOS Features Setup

Virus Warning (Disabled)

This field protects the boot sector and partition table of your hard disk against accidental modifications. Any attempt to write to them will cause the system to halt and display a warning message. If this occurs, you can either allow the operation to continue or use a bootable virus-free floppy disk to reboot and investigate your system. This setting is recommended because of conflicts with new operating systems or some programs. Installation of these programs requires that you disable *Virus Warning* to prevent write errors.

CPU Internal Cache (Enabled)

Choose *Disable* to turn off the CPU's built-in level 1 cache.

External Cache (Enabled)

Choose *Disable* to turn off the CPU's external level 2 cache.

Quick Power On Self Test (Enabled)

This field speeds up the Power-On Self Test (POST) routine by skipping retesting a second, third, and fourth time. Setup default setting for this field is *Enabled*. A complete test of the system is done on each test.

IV. BIOS SOFTWARE

HDD Sequence SCSI/IDE First (IDE)

When using both SCSI and IDE hard disk drives, IDE is always the boot disk using drive letter C (default setting of *IDE*). This new feature allows a SCSI hard disk drive to be the boot disk when set to *SCSI*. This allows multiple operating systems to be used on both IDE and SCSI drives or the primary operating system to boot using a SCSI hard disk drive.

Boot Sequence (C,A)

This field determines where the system looks first for an operating system. Options are *C,A*; *A,CDROM,C*; *CDROM,C,A*; *D,A*; *E,A*; *F,A*; *C only*; *LS/ZIP, C*; and *A,C*. The setup default setting is to check first the hard disk and then the floppy disk drive; that is, *C, A*.

Boot Up Floppy Seek (Disabled)

When enabled, the BIOS will seek drive A one time.

Floppy Disk Access Control (R/W)

This allows protection of files from the computer system to be copied to floppy disk drives by allowing the setting of *Read Only* to only allow reads from the floppy disk drive but not writes. The setup default *R/W* allows both reads and writes.

IDE HDD Block Mode Sectors (HDD MAX)

This field enhances hard disk performance by making multi-sector transfers instead of one sector per transfer. Most IDE drives, except older versions, can utilize this feature. Selections are *HDD MAX*, *Disabled*, *2*, *4*, *8*, *16*, and *32*.

Security Option (System)

This field determines when the system prompts for the password. The default setting is *System*, where the system prompts for the User Password every time you boot up. The other option is *Setup*, where the system always boots up, and prompts for the Supervisor Password only when the Setup utility is called up. You can specify a password by using the *Supervisor Password* or *User Password* option from the main screen as explained later in this section.

PS/2 Mouse Function Control (Auto)

The default of *Auto* allows the system to detect a PS/2 mouse on bootup. If detected, IRQ12 will be used for the PS/2 mouse. IRQ12 will be reserved for expansion cards if a PS/2 mouse is not detected. *Enabled* will reserve IRQ12 for the PS/2 mouse, and thus other devices will not be able to use IRQ12.

PCI/VGA Palette Snoop (Disabled)

Some display cards that are nonstandard VGA such as graphics accelerators or MPEG Video Cards may not show colors properly. The setting *Enabled* should correct this problem. Otherwise leave this on the setup default setting of *Disabled*.

OS/2 Onboard Memory > 64M (Disabled)

When using OS/2 operating systems with installed DRAM of greater than 64MB, you need to *Enable* this option otherwise leave this on the setup default of *Disabled*.

.....

IV. BIOS SOFTWARE

Video ROM BIOS Shadow (Enabled)

This field allows you to change the video BIOS location from ROM to RAM. Relocating to RAM enhances system performance, as information access is faster than the ROM.

C8000 - CBFFF Shadow to DC000 - DFFFF Shadow (Disabled)

These fields are used for shadowing other expansion card ROMs. If you install other expansion cards with ROMs on them, you will need to know which addresses the ROMs use to shadow them specifically. Shadowing a ROM reduces the memory available between 640KB and 1024KB by the amount used for this purpose.

.....

Boot Up NumLock Status (On)

This field enables users to activate the Number Lock function upon system boot.

Typematic Rate Setting (Disabled)

When enabled, you can set the two typematic controls listed next. Setup default setting is *Disabled*.

Typematic Rate (Chars/Sec) (6)

This field controls the speed at which the system registers repeated keystrokes. Options range from 6 to 30 characters per second. Setup default setting is **6**; other settings are **8, 10, 12, 15, 20, 24, and 30**.

Typematic Delay (Msec) (250)

This field sets the time interval for displaying the first and second characters. Four delay rate options are available: 250, 500, 750, and 1000.

IV. BIOS SOFTWARE

Chipset Features Setup

This “Chipset Features Setup” option controls the configuration of the board’s chipset. Control keys for this screen are the same as in the **BIOS Features Setup** screen.



NOTE: SETUP Defaults are noted in parenthesis next to each function heading.

Details of Chipset Features Setup

EDO/FPM Configuration (60ns DRAM)

The default setting of *60ns DRAM* automatically sets the optimal timings for items 2–7 for 60ns DRAM modules. If you are using 70ns DRAM modules, change this item to *70ns DRAM*. See section III for DRAM installation information. *Disabled* allows you to configure RAS Precharge Time, RAS to CAS Delay, CAS Precharge Time, CAS Pulse Width (Read and Write), and Refresh RAS Assertion.

SDRAM Configuration (12ns SDRAM)

If you use ASUS SDRAM DIMM modules, you can set this to *10ns SDRAM* for better performance, otherwise leave on default or check with your vendor for DIMM specifications.

Linear Mode SRAM Support (Disabled)

For a slightly better performance on IBM/Cyrix CPUs, this function can be *Enabled* to switch from Toggle mode SRAM to Linear mode SRAM support.

WARNING: Intel CPUs currently only support the Toggle mode so leave this function *Disabled* when using Intel CPUs.

ROM Cycle Wait States (1 Wait)

Timing for 16-bit ISA cards. Leave on default setting of *1 Wait*.

16-bit I/O Recovery Time (5 BUSCLK)

Timing for 16-bit ISA cards. Leave on default setting of *5 BUSCLK*.

8-bit I/O Recovery Time (8 BUSCLK)

Timing for 8-bit ISA cards. Leave on default setting of *8 BUSCLK*.

ISA Bus Clock (PCICLK/4)

Timing for the ISA bus clock. Leave on default setting of *PCICLK/4*.

IV. BIOS SOFTWARE

Graphics Aperture Size (64MB) (Leave on default setting of 64MB)

Memory-mapped, graphics data structures can reside in a Graphics Aperture.

Memory Hole at Address (None)

This feature reserves either 12MB-16MB, 14MB-16MB, or 15MB-16MB memory address space to ISA expansion cards that specifically require this setting. Memory from either 12MB and up, 14MB and up, or 15MB and up will be unavailable to the system because expansion cards can only access memory up to 16MB.

Refresh Queue Depth (12)

This function sets the DRAM refresh rate. A slow refresh cycle time increases the bandwidth available for data transfers. **NOTE:** Some DRAMs are known to lose data without frequent refreshing so the default is set at 0.

Delayed Transaction (Enabled)

The default setting of *Enabled* frees the PCI Bus during CPU accessing of 8-bit ISA cards, which normally consume about 50–60 PCI clocks without PCI delayed transaction. For PCI bus masters that cannot use the PCI Bus and some ISA cards that are not PCI 2.1 compliant, set this to *Disabled*.

DRAM are 64 (Not 72) bits wide

This motherboard does not have parity support, thus DRAM modules are always 64 bits wide.

Data Integrity Mode (None)

The setting *None* has byte-wise write capability but no provision for protecting data integrity in the DRAM array. You can enable the ECC function if ECC-supported DIMM is used. (See section III for more information on memory modules.)

.....

Onboard FDC Controller (Enabled)

When enabled, this field allows you to connect your floppy disk drives to the on-board floppy drive connector instead of a separate controller card. If you want to use a different controller card to connect the floppy drives, set this field to *Disabled*.

Onboard FDC Swap A & B (No Swap)

This field allows you to reverse the hardware drive letter assignments of your floppy disk drives through the onboard chipset. If you want to switch drive letter assignments, set this field to *Swap AB*. Default setting is *No Swap*.

Onboard Serial Port 1 (3F8H/IRQ4) and Onboard Serial Port 2 (2F8H/IRQ3)

Settings are 3F8H/IRQ4, 2F8H/IRQ3, 3E8H/IRQ4, 2E8H/IRQ10, and *Disabled* for the onboard serial connectors. Default setting for Serial Port 1 is 3F8H/IRQ4, while for Serial Port 2 is 2F8H/IRQ3.

IV. BIOS SOFTWARE

Onboard Parallel Port (378H/IRQ7)

This field sets the address of the onboard parallel port connector. You can select either *3BCH/IRQ 7*, *378H/IRQ 7*, *278H/IRQ 5*, or *Disabled*. If you install an I/O card with a parallel port, ensure that there is no conflict in the address assignments. The PC can support up to three parallel ports as long as there are no conflicts for each port.

Parallel Port Mode (ECP+EPP)

This field allows you to set the operation mode of the parallel port. The setting *Normal*, allows normal-speed operation but in one direction only; *EPP* allows bidirectional parallel port operation at maximum speed; *ECP* allows the parallel port to operate in bidirectional mode and at a speed faster than the maximum data transfer rate; *ECP+EPP* allows normal speed operation in a two-way mode.

ECP DMA Select (3)

This selection is available only if you select *ECP* or *ECP+EPP* in the **Parallel Port Mode**. Select either DMA Channel *1*, *3*, or *Disabled*.

UART2 Use Infrared (Disabled)

When enabled, this field activates the onboard infrared feature and sets the second serial UART to support the infrared module connector on the motherboard. If your system already has a second serial port connected to the onboard COM2 connector, it will no longer work if you enable the infrared feature. By default, this field is set to *Disabled*, which leaves the second serial port UART to support the COM2 serial port connector.

Onboard PCI IDE Enable (Both)

You can select to enable the *Primary* IDE channel, *Secondary* IDE channel, *Both*, or *Disable* both channels (for systems with only SCSI drives).

IDE Ultra DMA Mode (Auto)

This sets the IDE UltraDMA to be active when using UltraDMA-capable IDE devices. The BIOS will automatically adjust or disable this setting for slower IDE devices so that Auto or high settings will not cause problems for older IDE devices. Choose *Disable* if you do not want this feature for all devices.

IDE 0 Master/Slave PIO/DMA Mode, IDE 1 Master/Slave PIO/DMA Mode (Auto)

Each channel (0 and 1) has both a master and a slave making four IDE devices possible. Because each IDE device may have a different Mode timing (0, 1, 2, 3, 4), it is necessary for these to be independent. PIO and DMA timings can be independently set. The default setting of *Auto* will allow autodetection to ensure optimal performance.

IV. BIOS SOFTWARE

Power Management Setup

This “Power Management Setup” option allows you to reduce power consumption. This feature turns off the video display and shuts down the hard disk after a period of inactivity.



NOTE: SETUP Defaults are noted in parenthesis next to each function heading.

Details of Power Management Setup

Power Management (User Define)

This field acts as the master control for the power management modes. *User Define* allows you to set power saving options according to your preference; *Disable* disables the power saving features; *Min Saving* puts the system into power saving mode after 40 min of system inactivity; *Max Saving* puts the system into power saving mode after 30 sec of system inactivity.

IMPORTANT: Advanced Power Management (APM) must be installed to keep the system time updated when the computer enters suspend mode activated by the BIOS Power Management. For DOS, you must add `DEVICE=C:\DOS\POWER.EXE` in your `CONFIG.SYS`. For Windows 3.x and Windows 95, you must install with the APM feature enabled. A “Power” icon will appear in the “Control Panel.” Choose “Advanced” in the Power Management Field.

Video Off Option (Susp,Stby -> Off)

This field determines when to activate the video off feature for monitor power management. The settings are *Susp,Stby -> Off* (default); *All Modes -> Off*; *Always On*; and *Suspend -> Off*.

IV. BIOS SOFTWARE

Video Off Method (DPMS OFF)

This field defines the video off features. These options are available: *DPMS OFF*, *DPMS Reduce ON*, *Blank Screen*, *V/H SYNC+Blank*, *DPMS Standby*, and *DPMS Suspend*. The DPMS (Display Power Management System) features allow the BIOS to control the video display card if it supports the DPMS feature. *Blank Screen* only blanks the screen (or monitors without power management or “green” features). If set up in your system, your screen saver will not display with *Blank Screen* selected. *V/H SYNC+Blank* blanks the screen and turns off vertical and horizontal scanning.

.....

PM Timers

This section controls the time-out settings for the Power Management scheme. The system automatically “wakes up” from any power saving mode when there is system activity, such as when a key is pressed from the keyboard, or when there is activity detected from the enabled IRQ channels.

HDD Power Down (Disable)

This feature shuts down any IDE hard disk drives in the system after a period of inactivity. This time period is user-configurable to *1-15 Mins* or *Disable*. This feature does not affect SCSI hard disks.

Doze Mode, Standby Mode, Suspend Mode (Disable)

These fields set the period of time after which each of these modes activate: *30 Sec*, *1 Min*, *2 Min*, *4 Min*, *8 Min*, *20 Min*, *30 Min*, *40 Min*, *1 Hour*, and *Disable*.

.....

Power Up Control

This section determines the ways the system can be controlled when it is started or restarted, when modem activity is detected, or when power to the computer is interrupted and reapplied. The Soft-Off mode refers to powering off the system through a momentary button switch (ATX switch) or through the software as opposed to disconnecting the AC power by way of a rocker switch or other means.

Ring Power Up (Enable)

This field allows either settings of *Enable* (default) or *Disable* for powering up the computer (turns the ATX power supply on) when the modem begins receiving or transmitting data while the computer is off.

Automatic Power Up (Disable)

This field allows you to have an unattended or automatic power up of your system. You may configure your system to power up at a certain time of the day by selecting *Enable*, which will allow you to set the days (*SUN-SAT*) and time (hh:mm:ss) when you want this function to activate.

.....

Fan Monitor (xxxxRPM)

The onboard hardware monitor can detect the Chassis Fan Speed and CPU Fan Speed. These values refresh upon any key entries in the BIOS setup screen. Set to *Ignore* if one of these are not used so that error messages will not be given.

IV. BIOS SOFTWARE

Thermal Monitor (xxx°C/xxx°F)

The onboard hardware monitor can detect the CPU and MB (motherboard) temperatures. These values refresh upon key entries. Set to *Ignore* only if necessary.

Voltage Monitor (xx.xV)

The onboard hardware monitor can detect the voltages put out by the voltage regulators. These values refresh upon key entries. Set to *Ignore* only if necessary.

NOTE: If any of the monitored items are out of range, you will get an error message. Follow the onscreen instructions to troubleshoot.

PNP and PCI Setup

This “PNP and PCI Setup” option configures the PCI bus slots. All PCI bus slots on the system use INTA#, thus all installed PCI cards must be set to this value.

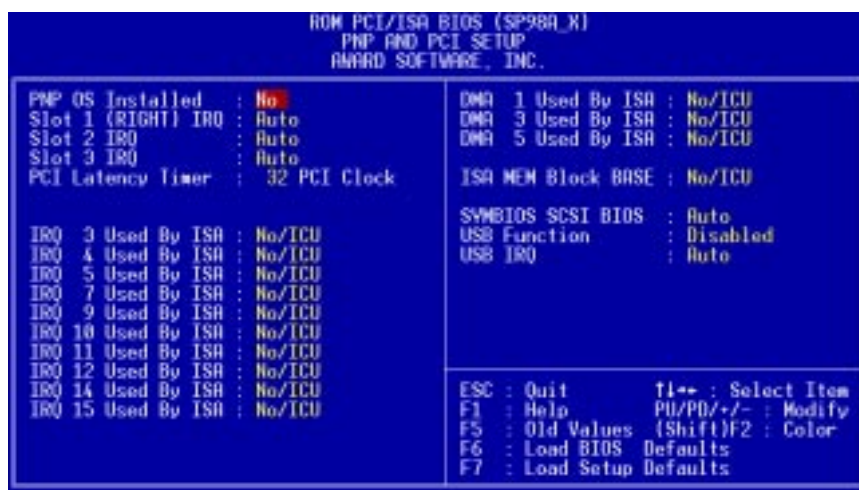

NOTE: SETUP Defaults are noted in parenthesis next to each function heading.

Details of PNP and PCI Setup

PNP OS Installed (No)

This field allows you to use a Plug-and-Play (PnP) operating system to configure the PCI bus slots instead of using the BIOS. Thus interrupts may be reassigned by the OS when *Yes* is selected. When a non-PnP OS is installed or to prevent reassigning of interrupt settings, select the default setting of *No*.

Slot 1 (RIGHT) IRQ to Slot 4 (LEFT) IRQ (Auto)

These fields set how IRQ use is determined for each PCI slot. The default setting for each field is *Auto*, which uses auto-routing to determine IRQ use. The other options are manual settings of *NA*, *5*, *7*, *9*, *10*, *11*, *12*, *14* or *15* for each slot.

PCI Latency Timer (32 PCI Clock)

The default setting of *32 PCI Clock* enables maximum PCI performance.

IV. BIOS SOFTWARE

IRQ xx Used By ISA (No/ICU)

These fields indicate whether or not the displayed IRQ for each field is being used by a legacy (non-PnP) ISA card. Two options are available: *No/ICU* and *Yes*. The first option, the default value, indicates either that the displayed IRQ is not used or an ISA Configuration Utility (ICU) is being used to determine if an ISA card is using that IRQ. If you install a legacy ISA card that requires a unique IRQ, and you are not using an ICU, you must set the field for that IRQ to *Yes*. For example: If you install a legacy ISA card that requires IRQ 10, then set **IRQ10 Used By ISA** to *Yes*.

.....

DMA x Used By ISA (No/ICU)

These fields indicate whether or not the displayed DMA channel for each field is being used by a legacy (non-PnP) ISA card. Available options include: *No/ICU* and *Yes*. The first option, the default setting, indicates either that the displayed DMA channel is not used or an ICU is being used to determine if an ISA card is using that channel. If you install a legacy ISA card that requires a unique DMA channel, and you are not using an ICU, you must set the field for that channel to *Yes*.

ISA MEM Block BASE (No/ICU)

This field allows you to set the base address and block size of a legacy ISA card that uses any memory segment within the C800H and DFFFH address range. If you have such a card, and you are not using an ICU to specify its address range, select a base address from the six available options; the **ISA MEM Block SIZE** field will then appear for selecting the block size. If you have more than one legacy ISA card in your system that requires to use this address range, you can increase the block size to either 8K, 16K, 36K, or 64K. If you are using an ICU to accomplish this task, leave **ISA MEM Block BASE** to its default setting of *No/ICU*.

SYMBIOS SCSI BIOS (Auto)

The default uses *Auto* settings for the onboard SCSI BIOS. If you do not want to use the onboard SCSI BIOS, choose *Disabled*.

USB Function (Disabled)

The motherboard supports Universal Serial Bus (USB) devices but current operating systems do not. The default is set to *Disabled*. If you have the necessary support disks and USB devices, set this function to *Enabled* to use the onboard USB connector.

USB IRQ (Auto)

When USB devices are connected to the onboard USB connector, the resource settings or IRQs for these devices are, by default, automatically assigned by the BIOS. You may manually select the settings: 5, 7, 9, 10, 11, 12, 14, and 15. If you are not using any USB devices, you may set this field to *NA*.

IV. BIOS SOFTWARE

Load BIOS Defaults

This “Load BIOS Defaults” option allows you to load the troubleshooting default values permanently stored in the BIOS ROM. These default settings are non-optimal and disable all high performance features. To load these default settings, highlight “Load BIOS Defaults” on the main screen and then press <Enter>. The system displays a confirmation message on the screen. Press <Y> and then <Enter> to confirm. Press <N> and then <Enter> to abort. This feature does not affect the fields on the Standard CMOS Setup screen.

Load Setup Defaults

This “Load Setup Defaults” option allows you to load the default values to the system configuration fields. These default values are the optimized configuration settings for the system. To load these default values, highlight “Load Setup Defaults” on the main screen and then press <Enter>. The system displays a confirmation message on the screen. Press <Y> and then <Enter> to confirm. Press <N> and then <Enter> to abort. This feature does not affect the fields on the Standard CMOS Setup screen.

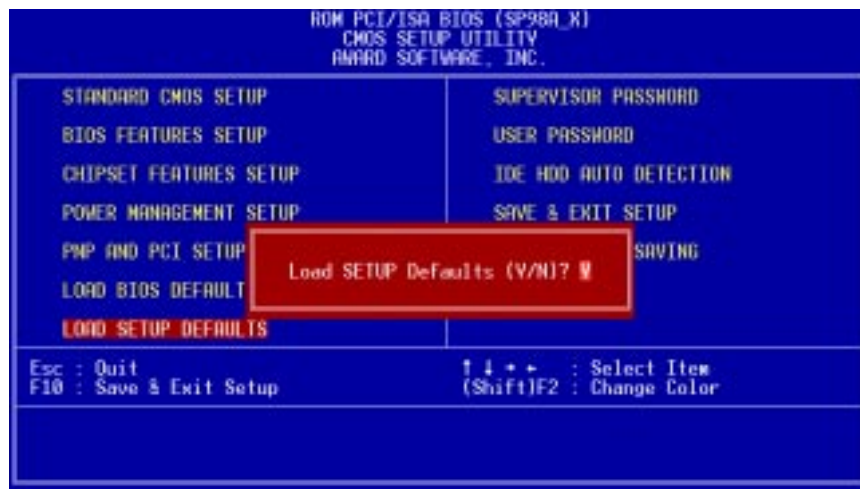

IV. BIOS
Load Defaults

IV. BIOS SOFTWARE

Supervisor Password and User Password

These two options set the system passwords. “Supervisor Password” sets a password that will be used to protect the system and the Setup utility; “User Password” sets a password that will be used exclusively on the system. By default, the system comes without any passwords. To specify a password, highlight the type you want and then press <Enter>. A password prompt appears on the screen. Taking note that the password is case sensitive, and can be up to 8 alphanumeric characters long, type in your password and then press <Enter>. The system confirms your password by asking you to type it again. After setting a password, the screen automatically reverts to the main screen.



To implement password protection, specify in the “Security Option” field of the BIOS Features Setup screen when the system will prompt for the password. If you want to disable either password, press <Enter> instead of entering a new password when the “Enter Password” prompt appears. A message confirms the password has been disabled.

NOTE: If you forget the password, see CMOS RAM in section III for procedures on clearing the CMOS.

IV. BIOS SOFTWARE

IDE HDD Auto Detection

This “IDE HDD Auto Detection” option detects the parameters of an IDE hard disk drive, and automatically enters them into the Standard CMOS Setup screen.

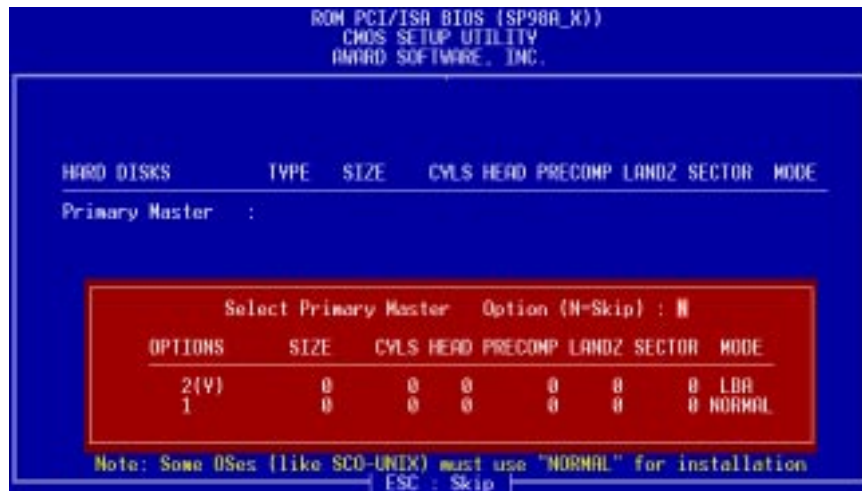

Up to four IDE drives can be detected, with parameters for each listed inside the box. To accept the optimal entries, press <Y> or else select from the numbers displayed under the OPTIONS field (2, 1, 3 in this case); to skip to the next drive, press <N>. If you accept the values, the parameters will appear listed beside the drive letter on the screen. The process then proceeds to the next drive letter. Pressing <N> to skip rather than to accept a set of parameters causes the program to enter zeros after that drive letter.

Remember that if you are using another IDE controller that does not feature Enhanced IDE support for four devices, you can only install two IDE hard disk drives. Your IDE controller must support the Enhanced IDE features to use Drive E and Drive F. The onboard PCI IDE controller supports Enhanced IDE, with two connectors for connecting up to four IDE devices. If you want to use another controller that supports four drives, you must disable the onboard IDE controller in the Chipset Features Setup screen.

When auto-detection is completed, the program automatically enters all entries you accepted on the field for that drive in the Standard CMOS Setup screen. Skipped entries are ignored and are not entered in the screen.

If you are auto-detecting a hard disk that supports the LBA mode, three lines will appear in the parameter box. Choose the line that lists LBA for an LBA drive. Do not select Large or Normal.

The auto-detection feature can only detect one set of parameters for a particular IDE hard drive. Some IDE drives can use more than one set. This is not a problem if the drive is new and empty.

IV. BIOS SOFTWARE

IMPORTANT: If your hard disk was already formatted on an older previous system, incorrect parameters may be detected. You will need to enter the correct parameters manually or use low-level format if you do not need the data stored on the hard disk.

If the parameters listed differ from the ones used when the disk was formatted, the disk will not be readable. If the auto-detected parameters do not match the ones that should be used for your disk, do not accept them. Press <N> to reject the presented settings and enter the correct ones manually from the Standard CMOS Setup screen.

Save & Exit Setup

Select this option to save into the CMOS memory all modifications you specified during the current session. To save the configuration changes, highlight the “Save & Exit Setup” option on the main screen, type “Y”, and then press <Enter>.



Exit Without Saving

Select this option to exit the Setup utility without saving the modifications you specify during the current session. To exit without saving, highlight the “Exit Without Saving” option on the main screen and then press <Enter>.

V. SUPPORT SOFTWARE

ASUS Smart Motherboard Support CD

Inserting the support CD brings up a selection menu described as follows:

(NOTE: CD version and contents are constantly modified without notice.)

- **Install ASUS PC Probe:** Installs the ASUS PC Probe utility to monitor fan, temperature, and voltage statuses in your computer.
- **Install AGP VxD Driver:** Installs the SiS 5591 AGP VxD driver.
- **Install Sound Card & Joystick Driver:** Installs the Crystal audio drivers.
- **Install IDE Driver:** Installs the SiS 5591 IDE driver.
- **Browse this CD:** Allows you to see the contents of the ASUS support CD.
- **Technical Support Form:** View the Technical Support Form with Notepad.
- **Read Me:** View additional notes with Notepad.
- **Exit:** Exit the selection menu.

V. SUPPORT SOFTWARE

Desktop Management Interface (DMI)

Introducing the ASUS DMI Configuration Utility

This motherboard supports DMI within the BIOS level and provides a DMI Configuration Utility to maintain the Management Information Format Database (MIFD). DMI is able to auto-detect and record information pertinent to a computer's system such as the CPU type, CPU speed, and internal/external frequencies, and memory size. The onboard BIOS will detect as many system information as possible and store those collected information in a 4KB block in the motherboard's Flash EPROM and allow the DMI to retrieve data from this database. Unlike other BIOS software, the BIOS on this motherboard uses the same technology implemented for Plug and Play to allow dynamic real-time updating of DMI information versus creating a new BIOS image file and requiring the user to update the whole BIOS. This DMI Configuration Utility also allows the system integrator or end user to add additional information into the MIFD such as serial numbers, housing configurations, and vendor information. Those information not detected by the motherboard BIOS and has to be manually entered through the DMI Configuration Utility and updated into the MIFD. This DMI Configuration Utility provides the same reliability as PnP updating and will prevent the refreshing failures associated with updating the entire BIOS.

System Requirements

The DMI Configuration Utility (DMICFG.EXE) must be used in real mode in order for the program to run, the base memory must be at least 180K. Memory managers like HIMEM.SYS (required by windows) must not be installed. You can boot up from a system diskette without AUTOEXEC.BAT and CONFIG.SYS files, "REM" HIMEM.SYS in the CONFIG.SYS, or press <F5> during bootup to bypass your AUTOEXEC.BAT and CONFIG.SYS files.

V. SUPPORT SOFTWARE

Using the ASUS DMI Configuration Utility

Edit DMI (or delete)

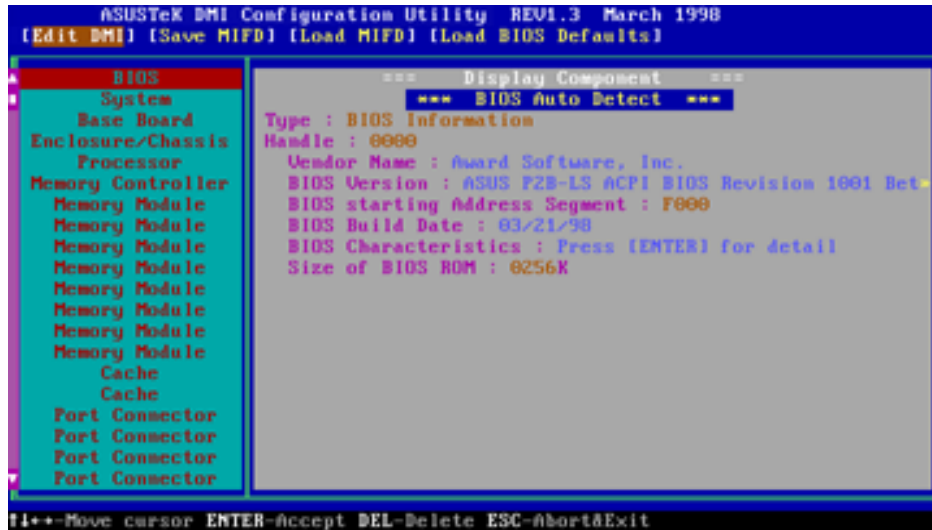

Use the ←→ (left-right) cursors to move the top menu items and the ↑↓ (up-down) cursor to move between the left hand menu items. The bottom of the screen will show the available keys for each screen. Press enter at the menu item to enter the right hand screen for editing. “Edit component” appears on top. The reversed color field is the current cursor position and the blue text are available for editing. The orange text shows auto-detected information and are not available for editing. The blue text “Press [ENTER] for detail” contains a second pop-up menu is available, use the + - (plus-minus) keys to change the settings. Enter to exit *and save*, ESC to exit *and not save*.

If the user has made changes, ESC will prompt you to answer Y or N. Enter Y to go back to the left-hand screen *and save*, enter N to go back to left-hand screen and *not save*. If editing has not been made, ESC will send you back to the left hand menu without any messages.

Notes

A heading, *** BIOS Auto Detect ***, appears on the right for each menu item on the left side that has been auto detected by the system BIOS.

A heading, *** User Modified ***, will appear on the right for menu items that have been modified by the user.



V. SUPPORT SOFTWARE

Save MIFD

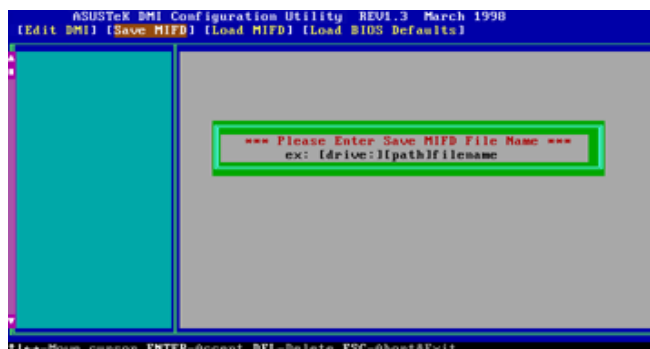

You can save the MIFD (normally only saved to flash ROM) to a file by entering the drive and path here. If you want to cancel save, you may press ESC and a message “Bad File Name” appears here to show it was not saved.

Load MIFD

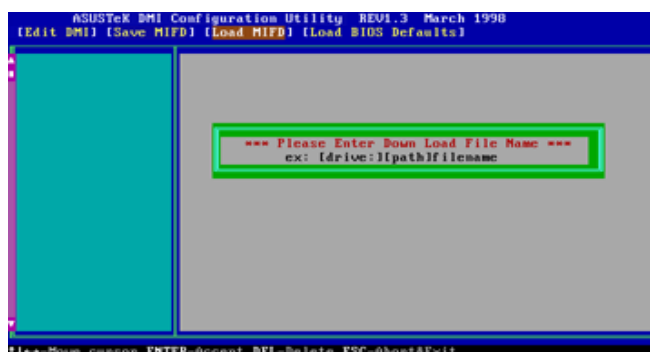

You can load the disk file to memory by entering a drive and path and file name here.

Load BIOS Defaults

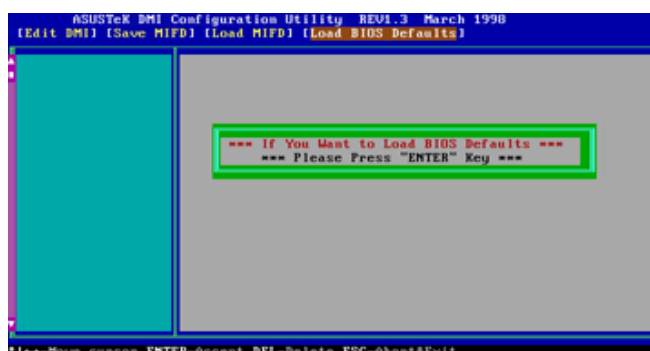

VI. ASUS PCI SCSI Cards

Symbios SCSI BIOS and Drivers

Aside from the system BIOS, the Flash memory chip on the motherboard also contains the Symbios SCSI BIOS. This Symbios SCSI BIOS works in conjunction with the optional ASUS PCI-SC200 controller card to provide Fast SCSI-2 interface when using compatible SCSI devices or the ASUS PCI-SC860 SCSI controller cards to provide Ultra-Fast SCSI-2 interface when using Ultra-Fast SCSI-2 devices.

All SCSI devices you install on your system require driver software to function. The Symbios SCSI BIOS directly supports SCSI hard disks under the DOS, Windows and OS/2 environments. It also uses device drivers from the DOS floppy disk included in the ASUS PCI-SC200 and ASUS PCI-SC860 controller card packages to support hard disks and other SCSI devices working under DOS, Microsoft Windows, Microsoft Windows NT, Novell NetWare and IBM OS/2. These drivers provide higher performance than the direct BIOS support. To use these drivers, you must install them into your system and add them to your system configuration files. Driver support for SCSI devices used with SCO UNIX is also provided. These drivers are included in the second SCO UNIX floppy disk. Windows 95 support is also available using the device drivers included within the Windows software. The ASUS PCI-SC200 and ASUS PCI-SC860 are Plug and Play adapters that are auto detected by BIOS and current operating systems that support Plug and Play features.

For information about these drivers and their usage, view the Readme files included in the driver packages.

ASUS PCI-SC200 & PCI-SC860 SCSI Cards

The ASUS PCI-SC200 or the ASUS PCI-SC860 may be bundled with your motherboard or purchased separately. Both cards provide the option of connecting internal or external SCSI devices for a total of 7 devices on each SCSI card.

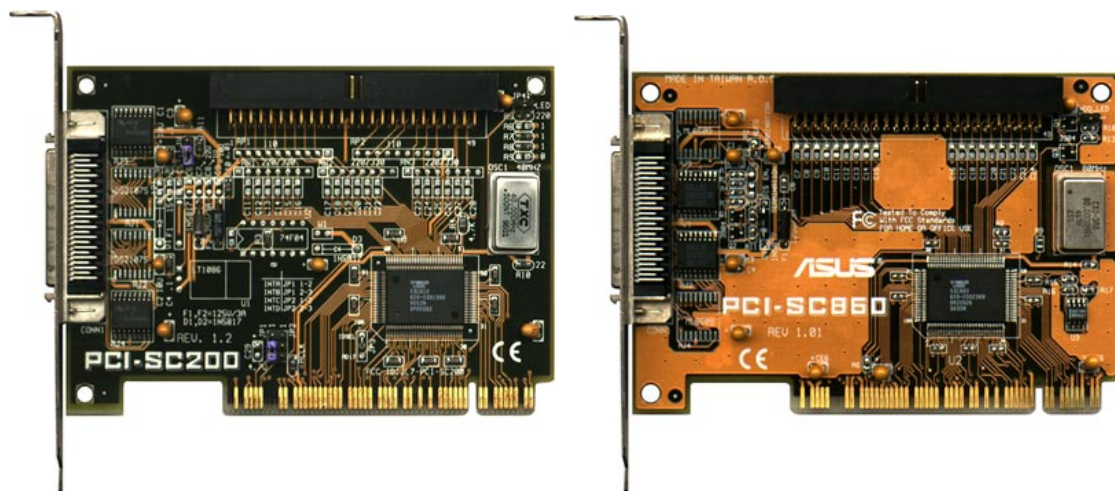

VI. ASUS PCI SCSI Cards

Setting Up the ASUS PCI-SC200 & PCI-SC860

There are two jumper settings you may need to make on the ASUS PCI-SC200 to set it up. One setting assigns the PCI INT interrupt, the other sets the card's termination. The ASUS PCI-SC860 has no jumper settings but you should read the "Terminator Requirements."

Setting the INT Assignment for the ASUS PCI-SC200

You must use PCI INT A setting in order to properly assign the ASUS PCI-SC200's interrupt. On the ASUS PCI-SC200, you assign the INT by setting jumper JP1 or JP2. The default setting for the card already is INT A, so you do not need to change the setting to use the ASUS PCI-SC200 with this motherboard.

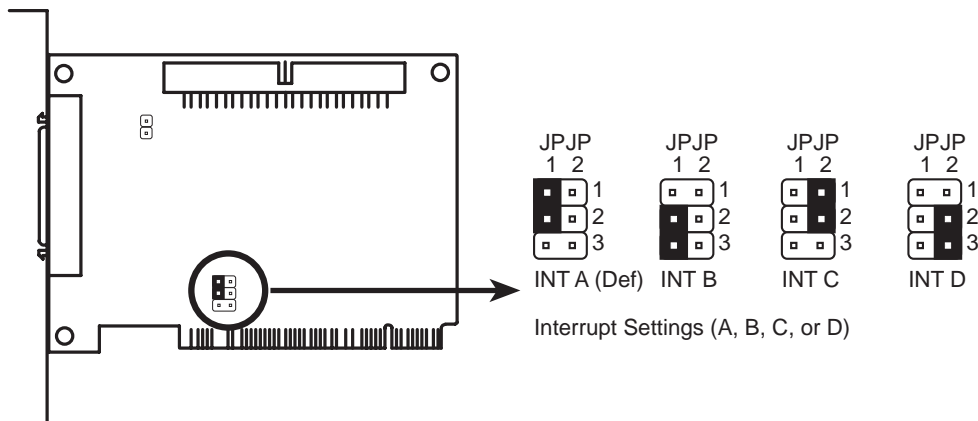

Terminator Requirements for SCSI Devices

SCSI devices are connected together in a "chain" by cables. Internal devices connect to the ASUS PCI-SC200 or ASUS PCI-SC860 with a fifty-pin flat ribbon cable. External devices connect to the external port with a SCSI-2 cable. If there are more than one internal or external devices, additional devices are connected with cables to form a "daisy chain." Terminating the devices on the ends of the SCSI Bus "chain" is necessary for SCSI devices to work properly. Termination of the devices between the ends must be *Disabled*.

VI. ASUS PCI SCSI Cards

Terminator Settings for the ASUS PCI-SC860

Many SCSI devices including the ASUS PCI-SC860 use a set of onboard active resistors to terminate the devices at the ends automatically. Automatic termination requires that the SCSI devices be connected in a straight linear connection or “chain.” Connect SCSI devices to one or two of the SCSI connectors in a linear “chain” for auto termination of the ASUS PCI-SC860 to be effective. Other formations will cause your SCSI devices to not mount properly. You must use the **end** of the ribbon cable when using the internal connector(s) to keep a linear path.

Additional Note: The Symbios Logic SCSI Configuration Utility is a powerful tool. If, while using it, you somehow disable all your controllers or cannot enter the configuration utility, pressing “Ctrl-A” after memory count during reboot allows you to recover and reconfigure.

Terminator Settings for the ASUS PCI-SC200

The ASUS PCI-SC200, on the other hand, has “active” termination that you must set using jumper JP5. There are two settings, “terminated” and “not terminated,” as shown below.

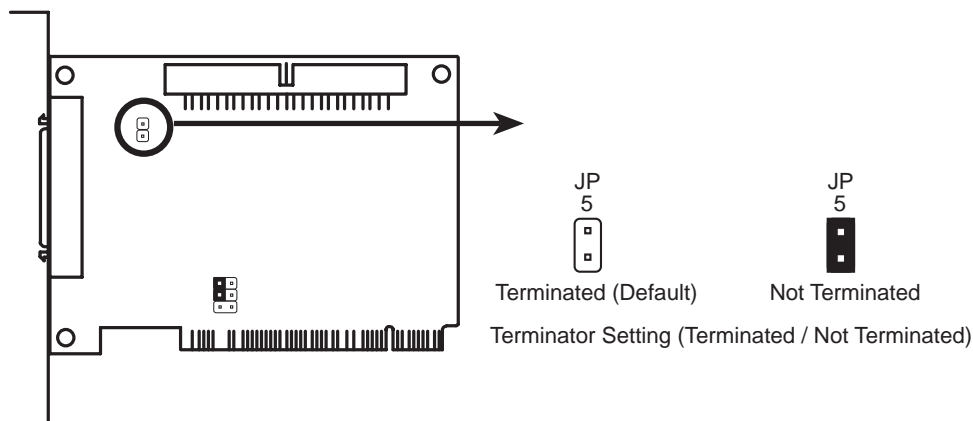

Decide whether or not you need to terminate the ASUS PCI-SC200 based on its position in the SCSI chain. Only the devices at each end of the chain need to be terminated. If you have **only** internal or **only** external devices connected to the ASUS PCI-SC200, then you **must** terminate the ASUS PCI-SC200. If you have **both** internal and external devices connected, you **must not** terminate the card. See the following example which illustrates this concept.

VI. ASUS PCI SCSI Cards

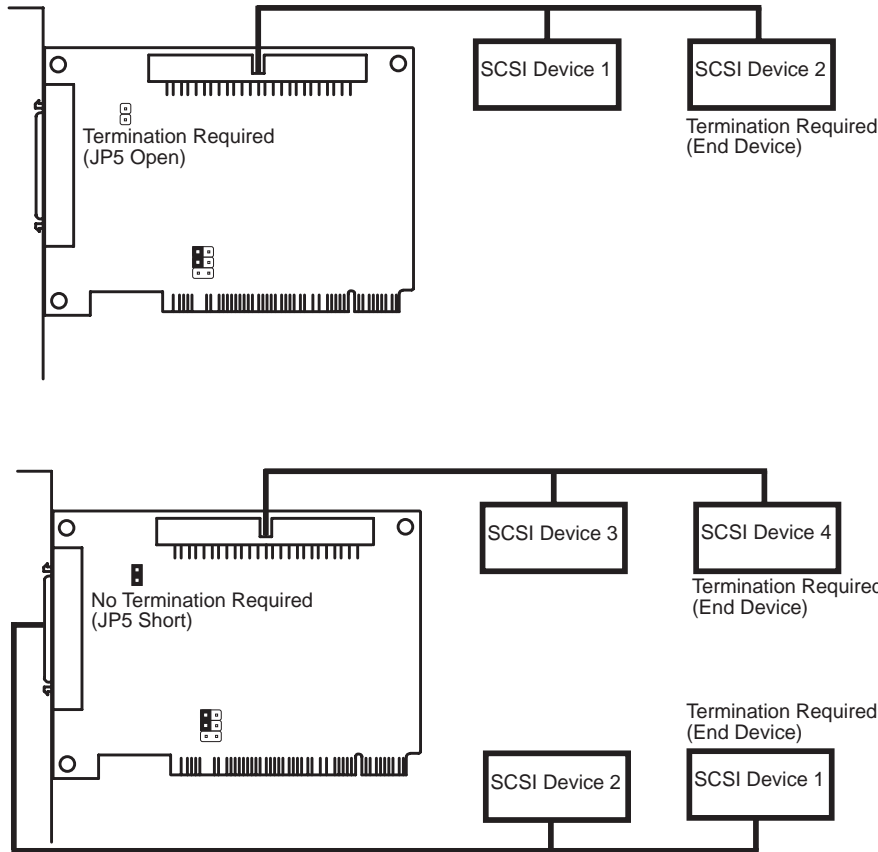

SCSI ID Numbers for SCSI Devices

All SCSI devices, including the ASUS PCI-SC200 and ASUS PCI-SC860 interface card must have a SCSI identification number that is not in use by any other SCSI device. There are eight possible ID numbers, 0 through 7. The ASUS PCI-SC200 and ASUS PCI-SC860 cards have fixed SCSI IDs of 7. The SCSI ID serves two purposes:

- It uniquely defines each SCSI device on the bus.
- It determines which device controls the bus when two or more devices try to use it at the same time.

SCSI IDs on one channel do not interfere with the IDs on another channel. This applies to two SCSI host adapters that implement different buses as well as dual channels on a single host adapter. You can connect up to seven SCSI devices to the interface card. You must set a SCSI ID number (ID 0 to ID 6) for each device. SCSI devices vary in how they set the ID number. Some use jumpers, others have some kind of selector switch. Refer to the manual for any device you install for details on how to set its ID number.

SCSI ID Priority

The ASUS PCI-SC200 and ASUS PCI-SC860 are 8bit single-channel SCSI cards. SCSI ID 7 has the highest priority, and SCSI ID 0 has the lowest priority.

VII. ASUS LAN Card

ASUS PCI-L101 Fast Ethernet Card

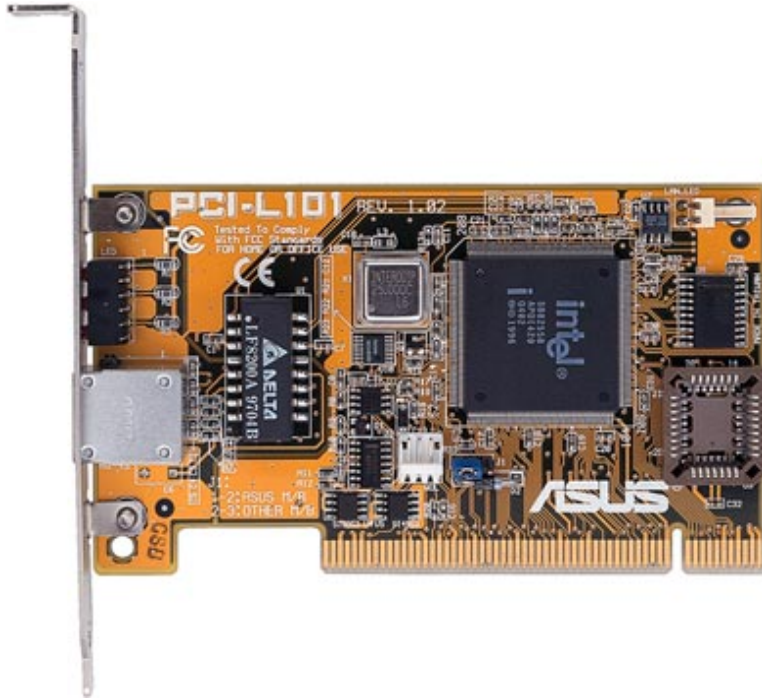

VII. ASUS LAN Card
PCI-L101 LAN Card

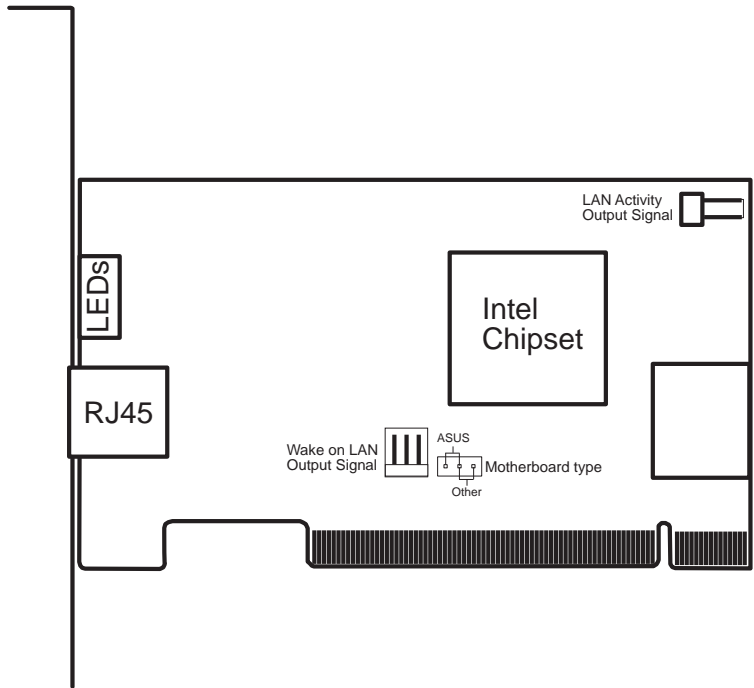

If you are using the ASUS PCI-L101 on an ASUS motherboard, leave the jumper on its default setting of “ASUS.” If you are using another brand of motherboard, set the jumper to “Other.” Connect the Wake on LAN (WOL) output signal to the motherboard’s WOL_CON in order to utilize the wake on LAN feature of the motherboard. Connect the LAN activity output signal (LAN_LED) to the system cabinet’s front panel LAN_LED in order to display the LAN data activity.

VII. ASUS LAN Card

Features

- Intel 82558 Ethernet LAN Controller (Fully integrated 10BASE-T/100BASE-TX)
- Wake-On-LAN Remote Control Function Supported
- PCI Bus Master Complies to PCI Local Bus Rev. 2.1 specifications
- Consists of MAC & PHY (10/100Mbps) interfaces
- Complies to IEEE 802.3 10BASE-T and IEEE 802.3u 100BASE-TX interfaces
- Fully supports 10BASE-T & 100BASE-TX operations through a single RJ45 port
- Supports 32-bit Bus Master Technology / PCI Rev. 2.1
- Enhancements on ACPI & APM
- Adheres to PCI Bus Power Management Interface Rev. 1.0, ACPI Rev. 1.0, and Device Class Power Management Rev. 1.0
- IEEE 802.3u auto-negotiation for 10Mbps/100Mbps Network Data Transfer Rates.
- Provides LED indicators for monitoring network conditions
- Plug and Play

Software Driver Support

- **NetWare ODI Drivers** - Novell Netware 3.x, 4.x, DOS, OS/2 Client
- **NDIS 2.01 Drivers** - Microsoft LAN Manager, Microsoft Windows 3.11, IBM LAN Server
- **NDIS 3.0 Drivers** - Microsoft Windows NT, Microsoft Windows 95, Microsoft Windows 3.11

Question and Answer

Q: What is Wake-On-LAN ?

A: The Wake-On-LAN feature provides the capability to remotely power on systems supporting Wake-On-LAN by simply sending a wake-up frame. With this feature, remotely uploading/downloading data to/from systems during off-peak hours will be feasible.

Q: What can Wake-On-LAN do for you ?

A: Wake-On-LAN is a remote management tool with advantages that can reduce system management workload, provide flexibility to the system administrator's job, and then of course save you time-consuming efforts and costs.

Q: What components does Wake-On-LAN require to be enable?

A: To enable Wake-On-LAN function, your system requires Ethernet LAN adapter card that can activate Wake-On-LAN function, a client with Wake-On-LAN capability, and software such as LDCM Rev. 3.10 or up that can trigger wake-up frame.