

Raptor ATX

**Motherboard
Installation Guide**

Table of Contents

Notice.....IV

Introduction..... V

Chapter 1 Pre-Configuration..... 1

Step 1 Setting the Jumpers 3

Jumper Locations 4

CMOS Reset..... 5

Disk-on-Chip Selection..... 5

Flash BIOS Write Protect 5

Clock Speed Selection 6

Watchdog Timer Selection..... 6

On-board Ethernet 7

ATX Power Supply Enhancements 7

Step 2 DRAM, CPU, Disk-on-Chip and Cables Installation 8

Raptor ATX Memory Configuration..... 8

CPU Installation 8

Disk-on-Chip installation..... 10

Installing Cables 10

Power and Control Panel Cables 10

Installing Peripheral Cables..... 10

Index of Connectors 13

Chapter 2 HIFLEX BIOS Setup..... 15

Standard Setup 16

Advanced CMOS Setup..... 17

Advanced Chipset Setup..... 21

Power Management Setup 26

PCI/Plug and Play Setup 29

Peripheral Setup 32

Auto Detect Hard Disk 35

Change User Password.....	35
Change Supervisor Password.....	36
Change Language Settings.....	36
Auto Configuration with Optimal Settings.....	36
Auto Configuration with Fail-Safe Settings.....	36
Save Settings and Exit	37
Exit without Saving.....	37

Chapter 3 Upgrading..... 39

Upgrading the System Memory.....	39
Upgrading the Microprocessor.....	39

Appendix A Technical Specifications..... 41

Chipsets	41
System Memory	41
Bios	41
Embedded I/O	42
Industrial Devices	43
Miscellaneous	43
Memory Map	45
DMA Channels.....	45
I/O Map	46
On-board Devices	47
PCI Configuration Space Map.....	47
Interrupts	48
PCI Interrupt Routing Map	48
SMBUS	49
Connectors Pin-out.....	49

Appendix B Flash BIOS programming 55

Appendix C Disk-On-Chip..... 57

**Appendix D On-Board Industrial
Devices..... 59**

Watchdog Timer 59
Post Code Display 60

**Appendix E On-Board
Ethernet..... 71**

Notice

The company reserves the right to revise this publication or to change its contents without notice. Information contained herein is for reference only and does not constitute a commitment on the part of the manufacturer or any subsequent vendor. They are in no way responsible for any loss or damage resulting from the use (or misuse) of this publication.

This publication and any accompanying software may not, in whole or in part, be copied, photocopied, translated or reduced to any machine readable form without prior consent from the vendor, manufacturer or creators of this publication, except for copies kept by the user for backup purposes.

Brand and product names mentioned in this publication may or may not be copyrights and/or registered trademarks of their respective companies. They are mentioned for identification purposes only and are not intended as an endorsement of that product or its manufacturer.

Fourth Edition.

©August, 2001

Introduction

Thank you for your purchase of the Raptor ATX industrial embedded motherboard. The Raptor ATX design was based on the Intel 440BX chipset providing the ideal platform to industrial applications. The Raptor ATX design is based on the Intel Celeron and PIII processor.

With proper installation and maintenance, your Raptor ATX will provide years of high performance and trouble free operation.

This manual provides a detailed explanation into the installation and use of the Raptor ATX industrial embedded motherboard. This manual is written for the novice PC user/installer. However, as with any major computer component installation, previous experience is helpful and should you not have prior experience, it would be prudent to have someone assist you in the installation. This manual is broken down into 3 chapters and 5 appendixes.

Chapter 1 - System Board Pre-Configuration

This chapter provides all the necessary information for installing the Raptor ATX. Topics discussed include: installing the CPU (if necessary), DRAM installation, jumper settings for CPU and standard I/O. Connecting all the cables from the system board to the chassis and peripherals.

Chapter 2 - BIOS Configuration

This chapter shows the final step in getting your system firmware setup.

Chapter 3 - Upgrading

The Raptor ATX provides a number of expansion options including memory. All aspects of the upgrade possibilities are covered.

Appendix A - Technical Specifications

A complete listing of all the major technical specifications of the Raptor ATX is provided.

Appendix B - Flash BIOS Programming (optional)

Provides all the information necessary to program your optional AMIBIOS Flash BIOS.

Appendix C - Disk-on-Chip

Two on-board sockets for a solid state flash disk device.

Appendix D - Industrial Devices

Watchdog Timer and On-Board POST (Power On Self Testing) code display.

Appendix E - Ethernet

On-board 10/100 Ethernet.

Static Electricity Warning!

The Raptor ATX has been designed as rugged as possible but can still be damaged if jarred sharply or struck. Handle the motherboard with care.

The Raptor ATX also contains delicate electronic circuits that can be damaged or weakened by static electricity. Before removing the Raptor ATX from its protective packaging, it is strongly recommended that you use a grounding wrist strap. The grounding strap will safely discharge any static electricity build up in your body and will avoid damaging the motherboard. Do not walk across a carpet or linoleum floor with the bare board in hand.

Warranty

This product is warranted against material and manufacturing defects for two years from the date of delivery. Buyer agrees that if this product proves defective the manufacturer is only obligated to repair, replace or refund the purchase price of this product at manufacturer's discretion. The warranty is void if the product has been subjected to alteration, misuse or abuse; if any repairs have been attempted by anyone other than the manufacturer; or if failure is caused by accident, acts of God, or other causes beyond the manufacturer's control.

Raptor ATX - An Overview

The Raptor ATX represents the ultimate in industrial embedded motherboard technology. No other system board available today provides such impressive list of features:

CPU Support

- Supports full series of Intel Celeron and PIII PGA370 processors (up to 100MHz FSB).

Supported Bus Clocks

- 66 and 100MHz.

Memory

- Three DIMM sockets up to 384MB or 768MB(registered) SDRAM, PC100 recommended (required for PIII or 100MHz).

On-Board I/O

- 2 Floppies up to 2.88 MB.
- Dual channel PCI 32-bit EIDE controller.
- Two high speed RS-232 serial ports 16 Bytes FIFO (16550).
- One Centronics™ compatible bidirectional parallel port. EPP/ECP mode compatible.

- One PS/2 mouse and one PS/2 keyboard connectors.
- Two Universal Serial Bus connectors.
- Two Disk-on-Chip on-board sockets up to 288MB each with FFS for diskless applications.
- Software and hardware programmable Watchdog Timer & on-board POST Display Diagnostics.
- Three 16-bit ISA slots, four 32-bit PCI slots and one AGP slot.
- RJ45 Ethernet connector.
- Power Button – advanced management support.
- Automatic CPU voltage & temperature monitoring device (optional).

ROM BIOS

- AMI BIOS™ BIOS HIFLEX with optional FLASH ROM

On-Board Ethernet

- On-board 10/100 Ethernet.

Conventions Used in this Manual



Notes - Such as a brief discussion of memory types.



Important Information - such as static warnings, or very important instructions.



When instructed to enter keyboard keystrokes, the text will be noted by this graphic.

Chapter 1 Pre-Configuration

This chapter provides all the necessary information for installing the Raptor ATX into a standard PC chassis. Topics discussed include: installing the CPU (if necessary), DRAM installation, jumper settings for CPU and standard I/O.

Handling Precautions

The Raptor ATX has been designed to be as rugged as possible but it can be damaged if dropped, jarred sharply or struck. Damage may also occur by using excessive force in performing certain installation procedures such as forcing the system board into the chassis or placing too much torque on a mounting screw.

Take special care when installing or removing the system memory DIMMs. Never force a DIMM into a socket. Screwdrivers slipping off a screw and scraping the board can break a trace or component leads, rendering the board unusable. Always handle the Raptor ATX with care.



Special Warranty Note:

Products returned for warranty repair will be inspected for damage caused by improper installation and misuse as described in the previous section and the static warning below. Should the board show signs of abuse, the warranty will become void and the customer will be billed for all repairs and shipping and handling costs.

Static Warning

The Raptor ATX contains delicate electronic semiconductors that are highly sensitive to static electricity. These components, if subjected to a static electricity discharge, can be weakened thereby reducing the serviceable life of the system board. BEFORE THE BOARD IS

REMOVED FROM ITS PROTECTIVE ANTISTATIC PACKAGING, TAKE PROPER PRECAUTIONS! Work on a conductive surface that is connected to the ground. Before touching any electronic device, ground yourself by touching an unpainted metal object or, and highly recommended, use a grounding strap.

Step 1 **Setting the Jumpers**

Your Raptor ATX is equipped with a large number of peripherals and has the ability to run at a variety of speeds without the need to change any crystals or oscillators. As such, there are a large number of configuration jumpers on the board. Taken step by step, setting these jumpers is easy. We suggest you review each section and follow the instructions.



Jumper Types

Jumpers are small copper pins attached to the system board. Covering two pins with a shunt closes the connection between them. The Raptor ATX examines these jumpers to determine specific configuration information. There are three different categories of jumpers on the Raptor ATX.

A. Two pin jumpers are used for binary selections such as enable, disable. Instructions for this type of jumper are open, for no shunt over the pins or closed, when the shunt covers the pins.

B. Three or four pin jumpers are used for multiple selections. Instructions for these jumpers will indicate which two pins to cover. For example: for JPx 2-3 the shunt will be covering pins 2 and 3 leaving pins 1 and 4 exposed.

C. Grouped jumpers are used when a certain function has multiple selections. There are two grouped jumpers on the board and careful attention should be given when setting these jumpers. Instructions for grouped jumpers are similar to those above.

How to identify pin number 1 on *Figure 1-1*: Looking to the solder side (The board side without components) of the PCB (Printed Circuit Board), pin number 1 will have a squared pad . Other pins will have a circular pad . They are numbered sequentially.

Jumper Locations

Use the diagram below and the tables on the following pages to locate and set the on-board configuration jumpers.

Figure 1-1 Jumper Locations

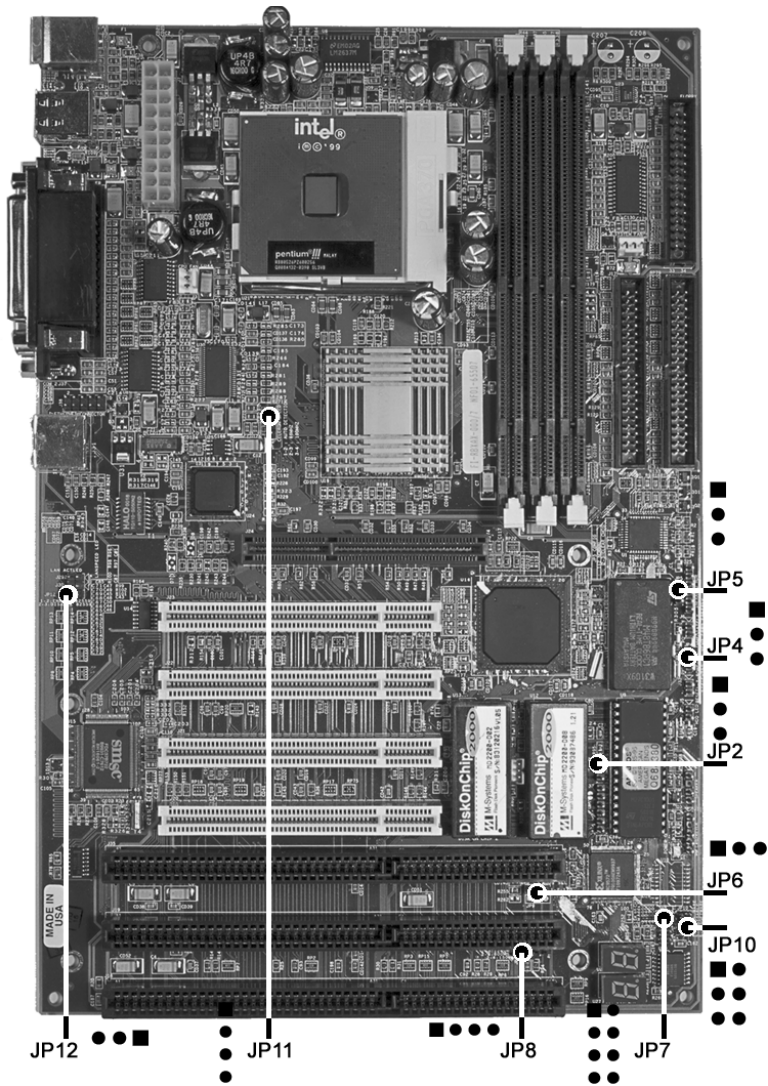

CMOS Reset

This option is provided as a convenience for those who need to reset the CMOS registers. It should always be set to "Normal" for standard operation. If the CMOS needs to be reset, turn off the system, move JP5 to 2-3, turn the system on, move jumper to 1-2 and press reset.

Table 1-1 CMOS Reset

Reset CMOS	Normal	Clear CMOS
JP5	1-2*	2-3

* *Manufacturer's Settings.*

Disk-on-Chip Selection

The jumper JP7 allows selection for the addresses on Disk-on-Chip devices.

Table 1-2 Disk-on-Chip Selection

Addresses	JP7 1-2	JP7 3-4	JP7 5-6	JP7 7-8
D000h/D400h*	Closed	Open	Open	Open
D400h/D800h	Open	Closed	Open	Open
D800h/DC00h	Open	Open	Closed	Open
DC00h/D000h	Open	Open	Open	Closed

* *Manufacturer's Settings.*

Flash BIOS Write Protect

To program the optional flash BIOS (Location U9 – *Figure 1-3*) use JP2 to disable write protection. For regular standard BIOS use default settings.

Table 1-3 Flash BIOS Programming Selection

Flash Write-protect	Enabled	Disabled
JP2	1-2*	2-3

* *Manufacturer's Settings.*

Clock Speed Selection

The Raptor ATX has a CPU automatic speed selector device. The jumper JP11 allows selection for this option.

Table 1-4 Clock Frequency Selection

Clock Frequency	JP11 1-2	JP11 2-3	JP11 3-4
AUTODETECT*	Closed	Open	Open
66MHz	Open	Closed	Open
100MHz	Open	Open	Closed

* *Manufacturer's Settings.*

Watchdog Timer Selection

The watchdog timer can be set as hardware, software or disabled through JP10. JP8 sets the time-out and JP6 sets the addresses. Please refer to appendix D for more details.

Table 1-5 Watchdog Timer Selection

Watchdog Type	JP10 1-2	JP10 3-4	JP10 5-6
Hardware	Closed	Open	Open
Disabled*	Open	Closed	Open
Software	Open	Open	Closed

* *Manufacturer's Settings.*

Table 1-6 Watchdog Time-out Selection

Watchdog Timeout	JP8 1-2	JP8 2-3	JP8 3-4
1200 ms*	Closed	Open	Open
600 ms	Open	Closed	Open
150 ms	Open	Open	Closed

* *Manufacturer's Settings.*

Table 1-7 Watchdog Address Selection

Watchdog Address	JP6 1-2	JP6 2-3
110h*	Closed	Open
310h	Open	Closed

* *Manufacturer's Settings.*

On-board Ethernet

The Raptor ATX has a built-in 10/100 Ethernet. The jumper JP12 either disables (2-3) or enables (1-2) this feature. For more information please refer to Appendix E.

Table 1-8 Ethernet Selection

Ethernet Selection	Enabled	Disabled
JP12	1-2*	2-3

* *Manufacturer's Settings.*

ATX Power Supply Enhancements

The Raptor ATX has a Power on mode selection. The jumper JP4 selects the power on mode.

Table 1-9 POWER ON Mode Select

Power on mode	Power on immediately	Power on upon PWR_SW signal (Button press)
JP4	1-2*	2-3

* *Manufacturer's Settings.*

Step 2 DRAM, CPU, Disk-on-Chip and Cables Installation

Depending upon how your Raptor ATX is configured you may need to install the following:

- DRAM (DIMMs)
- CPU
- Disk-on-chip

Raptor ATX Memory Configuration

The Raptor ATX offers 3 DIMM memory sockets (Locations J28, J27 and J26 – *Figure 1-3*). They can be configured with 3.3V unbuffered SDRAM modules. It is very important that the quality of the DIMMs is good. Unreliable operation of the system may result if poor quality DIMMs are used. Always purchase your memory from a reliable source. We strongly recommend using PC100 memory module (REQUIRED when using PIII or 100MHz operation). The Raptor ATX also supports ECC memories.



The Raptor ATX uses standard DIMMs. To determine the actual capacity of a 1 by 64 DIMM, simply multiply the 1MB by 8.

CPU Installation

The Raptor ATX currently supports the following CPUs:

- Full series of Intel Celeron and PIII processors (PGA 370).



- 1. Improper installation of the CPU may cause permanent damage to both the system board and the CPU. -- Void of warranty*
- 2. Always handle the CPU by the edges, never touch the pins.*
- 3. Always use a heatsink and a CPU fan.*

Locate the CPU socket on your Raptor ATX system board (PGA Socket – Location U21 – *Figure 1-3*). To install the processor, lift the lever of the ZIF socket and gently insert the CPU. The CPU will fit only in the right alignment. Make sure the CPU is inserted all the way. Lower the lever. Install the CPU fan. Make sure it is locked and connected to J3 (see pin-out in Appendix A).

The continued push of technology to increase performance levels (higher operating speeds) and packaging density (more transistors) is aggravating the thermal management of the CPU. As operating frequencies increase and packaging sizes decrease, the power density increases and the thermal cooling solution space and airflow become more constrained. The result is an increased importance on system design to ensure that thermal design requirements are met for the CPU.

The objective of thermal management is to ensure that the temperature of the processor is maintained within functional limits. The functional temperature limit is the range within which the electrical circuits can be expected to meet their specified performance requirements. Operation outside the functional limit can degrade system performance, cause logic errors or cause component and/or system damage. Temperatures exceeding the maximum operating limits may result in irreversible changes in the operating characteristics of the component.

If the Raptor ATX industrial embedded motherboard is acquired without the CPU and the thermal solution, extremely care must be taken to avoid improper thermal management. All Intel thermal solution specifications, design guidelines and suggestions to the CPU being used must be followed. The Raptor ATX warranty is void if the thermal management does not comply with Intel requirements.

Designing for thermal performance

In designing for thermal performance, the goal is to keep the processor within the operational thermal specifications. The inability to do so will shorten the life of the processor.

Fan Heatsink

An active fan heatsink can be employed as a mechanism for cooling the Intel processors. This is the acceptable solution for most chassis. Adequate clearance must be provided around the fan heatsink to ensure unimpeded air flow for proper cooling.

Airflow management

It is important to manage the velocity, quantity and direction of air that flows within the system (and how it flows) to maximize the volume of air that flows over the processor.

Thermal interface management

To optimize the heatsink design for the Celeron/Pentium III processor, it is important to understand the impact of factors related to the interface between the processor and the heatsink base. Specifically, the bond line thickness, interface material area, and interface material thermal conductivity should be managed to realize the most effective thermal solution.

This completes the installation of the CPU. Now is it a good time to double check both the CPU and DIMM installation to make sure that these devices have been properly installed.

Disk-on-Chip installation

The Raptor ATX supports Two Disk-on-Chip on-board up to 288 MB each with FFS for diskless applications.

Locate the Disk-on-Chip socket on your Raptor ATX system board (Locations U12 and U13 - *Figure 1-3*). Locate pin 1 (*Figure 1-3*). To install the Disk-on-Chip gently insert the chip. Make sure the Disk-on-Chip is inserted all the way.

Installing Cables

Power and Control Panel Cables

The Raptor ATX gets power from the power connector J7.

Installing Peripheral Cables

Now it is a good time to install the internal peripherals such as floppy and hard disk drives. Do not connect the power cable to these peripherals, as it is easier to attach the bulky ribbon cables before the smaller power connectors. If you are installing more than one IDE drive double check your master/slave jumpers on the drives. Review

the information supplied with your drive for more information on this subject.

Connect the floppy cable (not included) to the system board. Then connect remaining ends of the ribbon cable to the appropriate peripherals. Connect the Ethernet cable (not included). Finally, connect the IDE cable (not included) to the system. Then connect remaining ends of the ribbon cable to the appropriate peripherals. This concludes the hardware installation of your Raptor ATX system. Now it is a good time to re-check all of the cable connections to make sure they are correct.

The connector hole layouts on the Raptor ATX I/O Gasket (included) are designed according to Intel ATX specifications.

Figure 1-2 ATX I/O Gasket

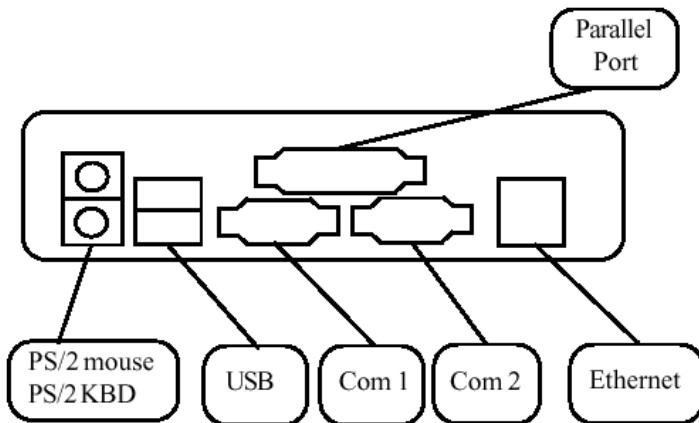
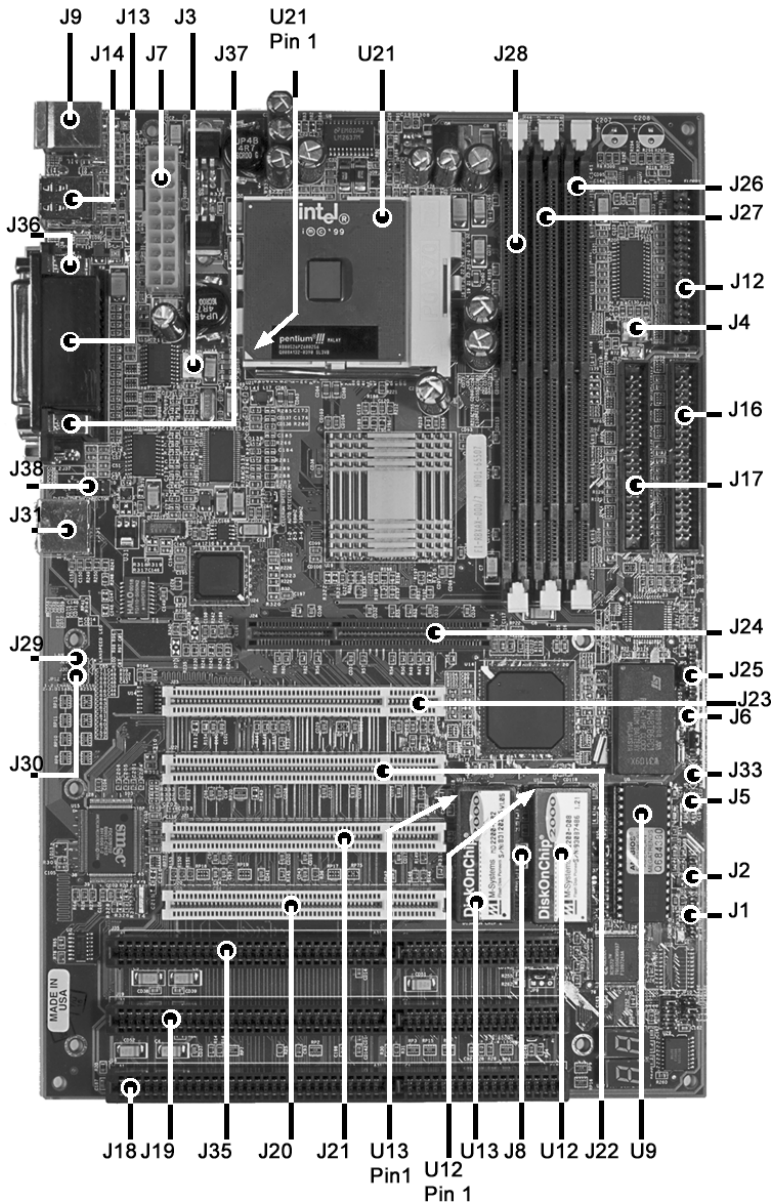

Figure 1-3 Location of Components and Connectors



Index of Connectors

Please refer to Appendix A for pin-out descriptions.

Table 1-10 Connectors descriptions

Connector	Description
J1	Power LED/Keylock
J2	Speaker
J3	CPU Fan
J4	Sys. Fan
J5	HDD LED
J6	Power Switch
J7	ATX Power
J8	Wake On LAN
J9	(Bottom)Keyboard – PS/2 (Top)Mouse – PS/2
J12	FDD
J13	LPT - Parallel
J14	USB (2x)
J16	Primary IDE
J17	Secondary IDE
J18	ISA Slot 1
J19	ISA Slot 2
J20	PCI Connector 1
J21	PCI Connector 2
J22	PCI Connector 3
J23	PCI Connector 4
J24	AGP Connector
J25	Infra Red
J29	LAN ACT LED
J30	LAN Speed LED
J31	Ethernet RJ45
J33	RESET
J35	ISA Slot 3
J36	COM 1
J37	COM 2
J38	Ethernet Header

User's Notes:

Chapter 2

HIFLEX BIOS Setup

Your Raptor ATX features AMI BIOS. The system configuration parameters are set via the HIFLEX AMIBIOS setup. Since HIFLEX BIOS Setup resides in the ROM BIOS, it is available each time the computer is turned on.

Starting BIOS Setup

As POST executes, the following appears:

Hit if you want to run SETUP

Using the Keyboard with BIOS Setup

The BIOS Setup has a built-in keyboard driver that uses simple keystroke combinations:

Keystroke Function	
<Tab>	Move to the next window or field.
, , ,	Move to the next field to the right, left, above, or below.
<Enter>	Select in the current field.
+	Increments a value.
-	Decrements a value.
<Esc>	Closes the current operation and return to previous level.
<PgUp>	Returns to the previous page.
<PgDn>	Advances to the next page.
<Home>	Returns to the beginning of the text.
<End>	Advances to the end of the text.
<Alt> <H>	Access a help window.
<Alt> <Spacebar>	Exit WINBIOS Setup.
Alphabetic keys	A to Z are used in the Virtual Keyboard, and are not case-sensitive.
Numeric keys	0 to 9 are used in the Virtual Keyboard and Numeric Keypad.

BIOS Setup Main Menu

The BIOS Setup main menu is organized into 14 windows. Each window is discussed in this chapter.

Each window contains several options. Clicking on each option activates a specific function. The BIOS Setup options and

functions are described in this chapter. Some options may not be available in your BIOS. The windows are:

- Standard CMOS Setup
- Advanced CMOS Setup
- Advanced Chipset Setting
- Power Management Setup
- PCI/Plug and Play Setup
- Peripheral Setup
- Auto-Detect Hard Drive
- Change User Password
- Change Supervisor Password
- Change Language Settings
- Auto Configuration with Optimal Settings
- Auto Configuration with Fail Safe Settings
- Save Settings and Exit
- Exit Without Saving

Standard Setup

Standard Setup options are displayed by choosing Standard option from the HIFLEX BIOS Setup menu. All Standard Setup options are described below.

Date/Time

Select the Date/Time option to change the date or time. The current date and time are displayed. Enter new values through the displayed window.

Floppy Drive A, B

Choose either Floppy Drive A or B to specify the floppy drive type. The settings are *360 KB 5¼"*, *1.2 MB 5¼"*, *720 KB 3½"*, *1.44 MB 3½"* and *2.88 MB 3½"*.

Pri Master *Pri Slave*
Sec Master *Sec Slave*

Select one of these options to configure the hard disk drive. Select Auto from the drive parameters screen to let AMIBIOS automatically configure the drive. Choose the desired option to configure the drive. Auto will automatically detect your hard drive every time the computer boots. If required, a specific Hard Drive type may be selected.

Boot Sector Virus Protection

The options are either Enabled or Disabled.

Advanced CMOS Setup

Advanced CMOS Setup options are displayed by choosing the Advanced CMOS Setup option from the AMIBIOS Setup main menu. All Advanced CMOS Setup options are described in this section.

Quick Boot

Set this option to Enabled to instruct AMIBIOS to boot quickly when the computer is powered on. This option replaces the old **Above 1 MB Memory Test** Advanced Setup option. The settings are: Enabled and Disabled.

Pri Master ARMD Emulated as
Pri Slave ARMD Emulated as
Sec Master ARMD Emulated as
Sec Slave ARMD Emulated as

If set to Auto, the default emulation depends on ARMD drive. The default emulation type is floppy for LS120, hard drive for MO and hard drive for ZIP drives.

1st Boot Device

2nd Boot Device

3rd Boot Device

4th Boot Device

These options set the drive boot sequence that Raptor ATX attempts to boot from after AMIBIOS POST completes. The settings are Disabled, 1st IDE, 2nd IDE, 3rd IDE, 4th IDE, Floppy, ARMD-FDD, ARMD-HDD, ATAPI-CDROM, SCSI, Network and I2O. The default is:

1st Boot Device - Floppy
2nd Boot Device - 1st IDE-HDD
3rd Boot Device - ATAPI-CDROM
4th Boot Device - Disabled

Try Other Boot Devices

Set this option to Yes (*default*) to instruct AMIBIOS to attempt to boot from any other drive in the system if it cannot find a boot drive among the drives specified in the 1st, 2nd, 3rd and 4th Boot Device options.

Initial Display Mode

Set this option to BIOS (*default*) to obtain the normal boot-up screen. Set to Silent to obtain the customized graphic boot-up screen.

Floppy Access Control

This option selects usage right from the floppy drive. The setting is either Read/Write (*default*) or Read-Only.

Hard Disk Access Control

This option selects usage right from the hard disk. The setting is either Read/Write (*default*) or Read-Only.

S.M.A.R.T. for Hard Disks

Set this option to Enabled to permit AMIBIOS to use the SMART (System Management and Reporting Technologies). The setting is either Enabled or Disabled (*default*).

Boot Up Num Lock

Set this option to Off to turn the Num Lock key off when the computer is booted so you can use the arrow keys on both the numeric keypad and the keyboard.

Floppy Drive Swap

Set this option to Enabled to permit drives A: and B: to be swapped. The setting is either Enabled or Disabled (*default*).

Floppy Drive Seek

Set this option to Enabled to specify that floppy drive A: will perform a Seek operation at system boot. The setting is either Disabled (*default*) or Enabled.

PS/2 Mouse Support

Set this option to Enabled (*default*) to enable AMIBIOS support for a PS/2-type mouse. Disabling mouse will also free up IRQ12.

Typematic Rate

The setting is either Fast (*default*) or Slow.

System Keyboard

This option does not specify if a keyboard is attached to the computer. Rather, it specifies if an error message is displayed when a keyboard is not attached. This option permits you to configure workstations with no keyboards.

Primary Display

This option configures the type of video card attached to the computer. The settings are Mono, CGA40x25, CGA80x25, VGA/EGA (*default*) and Absent. Use Absent for systems without video cards.

Password Check

This option enables password checking every time the system boots or when you run AMIBIOS Setup. If Always is chosen, a user password prompt appears every time the computer is turned on. If Setup is chosen, the password prompt appears if AMIBIOS is executed. See the Advanced Setup chapter for instructions on changing a password. The Optimal and Fail-Safe default is Setup.

BOOT to OS/2

Set this option to Enabled if running OS/2 operating system and using more than 64 MB of system memory on the motherboard. The setting is either Yes or No (*default*).

Wait for <F1> If Error

If this option is set to Enabled, AMIBIOS waits for the user to press <F1> before continuing. If this option is set to Disabled, AMIBIOS continues the boot process without waiting for <F1> to be pressed.

Hit Del Message Display

Set this option to Disabled to prevent the message

Hit if you want to run Setup

from appearing on the first AMIBIOS screen when the computer boots. The setting is either Disabled or Enabled. The Optimal and Fail-Safe default setting is Enabled.

Internal Cache

This option enables or disables the L1 internal Cache.

System BIOS Cacheable

When set to Enabled, the contents of the F0000h system memory segment can be read from or written to cache memory. The content of this memory segment is always copied from the BIOS ROM to system RAM for faster execution. The setting is either Enabled or Disabled.

C000,16K Shadow

C400,16K Shadow

These options specify how the 32 KB of video ROM at C0000h is treated. The settings are: Enabled (*default*), Disabled and Cached.

C800,16K Shadow

CC00,16K Shadow

D000,16K Shadow

D400,16K Shadow

D800, 16K Shadow

DC00,16K Shadow

These options enable shadowing of the contents of the ROM area named in the option. The ROM area not used by ISA adapter cards is allocated to PCI adapter cards. The settings are: Disabled (*default*), Cached and Enabled.

Advanced Chipset Setup

USB Function

Set this option to Enabled to enable USB (Universal Serial Bus) support. The setting is either Enabled or Disabled (*default*).

USB KB/Mouse Legacy Support

The settings for this option are: Disabled (*default*), Keyboard, Auto and Keyboard+Mouse.

Port 64/60 Emulation

The setting for this option is either Enabled or Disabled (*default*).

SERR#

The options are Enabled and Disabled (*default*).

PERR#

The options are Enabled and Disabled (*default*).

WSC# Handshake

The options are Enabled (*default*) and Disabled.

USWC WRITE POST

The options are Enabled (*default*) and Disabled

BX/GX Master Latency Timer (CLKS)

The options are Disabled, 32, 64 (*default*), 96, 128, 160, 192 and 224.

Multi-Trans Timer (CLKS)

The options are Disabled, 32 (*default*), 64, 96, 128, 160, 192 and 224.

PCI 1 TO PCI 0 Access

The options are Enabled and Disabled (*default*).

Aperture Access Global Enable

The options are Enabled and Disabled (*default*).

PCI 0 Agent to Aperture Access

N/A.

Memory Autosizing Support

The settings for the option are: Auto (*default*) (uses SPD) and Enabled (BIOS test).

DRAM Integrity Mode

The options are None (*default*), EC and ECC Hardware.

DRAM Refresh Rate

The settings for the option are: 15.6 (*default*), 31.2, 62.4, 124.8, 7.8 and External.

Memory Hole

The settings for the option are: Disable (*default*), 512K-640K and 15M-16M.

SDRAM CAS# Latency

The options are Auto (*default*), 3 DCKLs and 2 DCKLs.

SDRAM RAS# to CAS# Delay

The options are Auto (*default*), 3 SCKLs and 2 SCKLs.

SDRAM RAS# Precharge

The options are Auto (*default*), 3 SCKLs and 2 SCKLs.

SDRAM Precharge Control

The settings for this option are: All, Miss (*default*) and Miss/All.

Power Down SDRAM

The settings for this option are: Enabled and Disabled (*default*).

ACPI Control Register

The settings for this option are: Enabled and Disabled (*default*).

Gated Clock

The settings for this option are: Enabled (*default*) and Disabled.

Graphics Aperture Size

The settings for this option are: 4, 8, 16, 32, 64 (*default*), 128 and 256.

Search for MDA Resources

The options are Yes (*default*) and No.

AGP Read Sync

The settings for this option are: Enabled and Disabled (*default*).

AGP Snoopable Write

The settings for this option are: Enabled (*default*) and Disabled.

AGP Mlti-Trans Timer (AGP Clks)

The settings for this option are: 32 (*default*), 64, 96, 128, 160, 192 and 224.

AGP Low-Priority Timer (AGP Clks)

The settings for this option are: 16 (*default*), 32, 48, 64, 80, 96, 112, 128, 144, 176, 192, 208, 224 and 240.

AGP SERR

The settings for this option are: Enabled and Disabled (*default*).

AGP Parity Error Response

The settings for this option are: Enabled and Disabled (*default*).

8 bit I/O Recovery Time

The settings are Disabled (*default*), 1, 2, 3, 4, 5, 6 and 8 Sysclk.

16bit I/O Recovery Time

The settings are Disabled (*default*), 4, 1, 2 and 3 Sysclk.

PIIX4 SERR#

The settings for this option are: Enabled and Disabled (*default*).

USB Passive Release

The settings for this option are: Enabled (*default*) and Disabled.

PIIX4 Passive Release

The settings for this option are: Enabled (*default*) and Disabled.

PIIX4 Delayed Transaction

The settings for this option are: Enabled (*default*) and Disabled.

Type F DMA Buffer Control 1

Type F DMA Buffer Control 2

The settings for these options are: Enabled and Disabled (*default*).

DMA-0 Type Thru DMA-7 Type

The settings for these options are: Normal ISA (*default*), PC/PCI and distributed.

Memory Buffer Strength

The settings for this option are: Strong (*default*), Medium and Auto.

Manufacture Setting

The settings for this option are: Mode 0 (*default*), Mode 1, Mode 2, Mode 3 and Mode 4.

Power Management Setup

All Power Management Setup options are described in this section.

Power Management/APM

Set this option to APM to enable the power management and APM (Advanced Power Management) features. The settings for this option are: APM (*default*) and Disabled.

Power button Function

This option specifies how the power button mounted externally on the computer chassis is used. The settings are: On/Off and suspend. The default setting is On/Off.

Green PC Monitor Power State

This option specifies the power state that the green PC-compliant video monitor enters when AMIBIOS places it in a power saving state after the specified period of display inactivity has expired. The settings are Off, Standby and Suspend. The default setting is Suspend.

Video Power Down Mode

This option specifies the power management state that the video subsystem enters after the specified period of display inactivity has expired. The settings are Disabled, Standby and Suspend. The default setting is Suspend.

Hard Disk Power Down Mode

This option specifies the power management state that the hard disk drive enters after the specified period of display inactivity has expired. The settings are Disabled, Standby and Suspend. The default setting is Suspend.

Hard Disk Timeout (Minute)

This option specifies the length of a period of hard disk inactivity. When this period expires, the hard disk drive enters the power-conserving mode specified in the ***Hard Disk Power Down Mode*** option described on the previous page. The settings are Disabled, 1 Min (minutes) and all one-minute intervals up to and including 15 Min. The default setting is Disabled.

Power Saving Type

The settings for this option are: Sleep, Stop Clock and Deep Sleep. The default setting is Sleep.

Standby / Suspend Timer Unit

This option allows a timer to be set for stand by and suspend modes. The options are: 32 seconds, 4 miliseconds, 4 minutes (*default*) and 4 seconds.

Standby Timeout

This option specifies the length of the period of system inactivity when the computer is in Full-On mode before the computer is placed in Standby mode. In Standby mode, some power use is curtailed. The settings are multiples of the standby suspend timer unit. The default setting is Disabled.

Suspend Timeout

This option specifies the length of the period of system inactivity when the computer is already in Standby mode before the computer is placed in Suspend mode. In Suspend mode, nearly all power use is curtailed. The settings are multiples of the standby suspend timer unit. The default setting is Disabled.

Slow Clock Ratio

This option specifies the speed at which the system clock runs in the Standby Mode power saving state. The settings are expressed as a percentage between the normal CPU clock speed and the CPU clock speed when the computer is in the power-conserving state. The settings are 0-12.5%, 12.5-25%, 25-37.5%, 37.5-50%, 50-62.5%, 62.5-75% and 75-87.5%. The Optimal and Fail-Safe default setting is 50-62.5%.

Display Activity

Device 6 (Serial 1)

Device 7 (Serial2)

Device 8 (Parallel)

Device 5 (Floppy)

Device 0 (Primary Master IDE)

Device 1 (Primary Slave IDE)

Device 2 (Secondary Master IDE)

Device 3 (Secondary Slave IDE)

When set to Monitor, this option enables event monitoring on the device. If set to Monitor and the computer is in a power saving state, AMIBIOS watches for activity. The computer enters the Full On state if any activity occurs. AMIBIOS reloads the Standby and Suspend timeout timers if device activity occurs. The settings are either Monitor or Ignore.

LAN Wake-Up

The settings for this option are: Disabled (*default*) and Enabled.

PCI/Plug and Play Setup

PCI/PnP Setup options are displayed by choosing the PCI/PnP Setup from the AMIBIOS Setup main menu. All PCI/PnP Setup options are described in this section.

Plug and Play Aware OS

Set this option to Yes if the operating system installed in the computer is Plug and Play-aware. AMIBIOS only detects and enables PnP ISA adapter cards that are required for system boot. The Windows 95 and 98 operating systems detect and enable all other PnP-aware adapter cards. Windows 95 is PnP-aware. Set this option to No if the operating system (such as DOS, OS/2, Windows 3.x) does not use PnP. **You must set this option correctly or PnP-aware adapter cards installed in your computer will not be configured properly.** The setting is either No or Yes. The Optimal and Fail-Safe default setting is No.

PCI Latency Timer (PCI Clocks)

This option sets latency of all PCI devices on the PCI bus. The settings are in units equal to PCI clocks. The settings are 32, 64, 96, 128, 160, 192, 224 and 248. The Optimal and Fail-Safe default setting is 64.

PCI VGA Palette Snoop

This option must be set to Enabled if any ISA adapter card installed in the computer requires VGA palette snooping. The setting is either Disabled or Enabled. The default setting is Disabled.

Allocate IRQ to PCI VGA

This option determines if the BIOS should assign an IRQ to the VGA card. The settings are either Yes or No. The default setting is No.

PCI IDE Bus Master

Set this option to Enabled to specify that the IDE controller on the PCI local bus has bus mastering capability. The setting is either Disabled or Enabled. The default setting is Disabled.

Off-board PCI IDE Card

This option specifies if an off-board PCI IDE controller adapter card is used in the computer. You must also specify the PCI expansion slot on the motherboard where the off-board PCI IDE controller card is installed. If an off-board PCI IDE controller is used, the onboard IDE controller on the CPU board is automatically disabled. The settings are Auto (*default*), Slot1, Slot2, Slot3, Slot4, Slot5 and Slot6. If Auto is selected, AMIBIOS automatically determines the correct setting for this option.

Off-board PCI IDE Primary IRQ

This option specifies the PCI interrupt used by the primary IDE channel on the off-board PCI IDE controller. The settings are: Disabled, INTA, INTB, INTC, INTD and Hardwired. The Optimal and Fail-Safe default setting is Disabled.

Off-board PCI IDE Secondary IRQ

This option specifies the PCI interrupt used by the secondary IDE channel on the off-board PCI IDE controller. The settings are Disabled, INTA, INTB, INTC, INTD and Hardwired. The Optimal and Fail-Safe default setting is Disabled.

PCI Slot1 IRQ Priority

PCI Slot2 IRQ Priority

PCI Slot3 IRQ Priority

PCI Slot4 IRQ Priority

These options specify the IRQ priority for PCI devices installed in the PCI expansion slots. The settings are Auto, (IRQ) 3, 4, 5, 7, 9, 10, 11, 12 and 14. The Optimal and Fail-Safe default setting is Auto.

DMA Channel 0

DMA Channel 1

DMA Channel 3

DMA Channel 5

DMA Channel 6

DMA Channel 7

These options allow you to specify the bus type used by each DMA channel. The setting is either PNP or ISA/EISA. The optimal and fail-safe default setting is PNP.

IRQ3

IRQ4

IRQ5

IRQ7

IRQ9

IRQ10

IRQ11

IRQ12

IRQ14

IRQ15

These options specify the bus that the specified IRQ line is used on. These options allow you to reserve IRQs for legacy ISA adapter cards. These options determine if AMIBIOS should remove an IRQ from the pool of available IRQs passed to devices that are configurable by the system BIOS. If more IRQs must be removed from the pool, the end user can use these options to reserve the IRQ by assigning an ISA/EISA setting to it. Onboard I/O is configured as PCI/PNP. IRQ12 only appears if the mouse support option in advanced setup is set to disabled. IRQ14 and 15 will not be available if the onboard PCI IDEs are enabled. The optimal and fail-safe default setting is PCI/PNP.

Reserved Memory Size

This option specifies the size of the memory area reserved for legacy ISA adapter cards. The settings are Disabled, 16K, 32K and 64K. The Optimal and Fail-Safe default setting is Disabled.

Reserved Memory Address

This option specifies the beginning address (in hex) of the reserved memory area. The specified ROM memory area is reserved for use by legacy ISA adapter cards. The settings are C8000, CC000, D0000, D4000, D8000 and DC000. The Optimal and Fail-Safe default setting is CC000.

PCI Device Search Order

This option determines which order the PCI slots will be scanned. The setting is either First-Last (*default*) or Last-First.

Peripheral Setup

Peripheral Setup options are displayed by choosing Peripheral Setup from the AMIBIOS Setup main menu. All Peripheral Setup options are described here.

Onboard FDC

Set this option to Enabled to enable the floppy drive controller on the motherboard. The settings are Auto (AMIBIOS automatically determines if the floppy controller should be enabled), Enabled and Disabled. The default setting is Auto.

Onboard Serial Port1

This option specifies the base I/O port address of serial port 1. The settings are Auto (AMIBIOS automatically determines the correct base I/O port address), Disabled, 3F8h, 2F8h, 3E8h and 2E8h. The Optimal and Fail-Safe default setting is Auto.

Onboard Serial Port2

This option specifies the base I/O port address of serial port 2. The settings are Auto (AMIBIOS automatically determines the correct base I/O port address), Disabled, 3F8h, 2F8h, 3E8h and 2E8h. The Optimal and Fail-Safe default setting is Auto.

Serial Port2 Mode

This option allows installation of a Infra-red device by the Serial Port. The settings are Normal (*default*), IRDA and ASK IR.

Infra-Red Transmission Mode

The settings are Full Duplex (*default*) or Half Duplex.

Receiver/Transmitter Polarity

Sets polarity for IR modes.

Onboard Parallel Port

This option specifies the base I/O port address of the parallel port on the motherboard. The settings are Auto, Disabled, 378h, 278h and 3BCh. The Optimal default setting is Auto.

Parallel Port Mode

This option specifies the parallel port mode. The settings are: normal, ECP (*default*) and EPP.

EPP Version

1.7 and 1.9 (*default*) (available only for EPP mode).

Parallel Port IRQ

This option specifies the IRQ always used by the parallel port. When the port is set to a fixed address the settings are (IRQ) 5 and (IRQ) 7 (*default*), otherwise it is set to Auto.

Parallel Port DMA Channel

This option is only available if the setting for the Parallel Port Mode option is ECP. This option sets the DMA channel used by the parallel port. When the port is set to a fixed address the settings are DMA Channel 0, 1 and 3 (*default*), otherwise it is set to Auto.

CPU Current Temperature

The current CPU temperature is shown (only available with the optional hardware monitor).

CPU Overheat Warning

The setting is either Enabled or Disabled (*default*) (only available with the optional hardware monitor).

CPU Overheat Warning Temperature

Sets the CPU Overheat Warning Temperature set point (only available with the optional hardware monitor).

HW Monitor IN0 (CPU)

HW Monitor IN2 (+3.3V)

HW Monitor IN3 (+5V)

HW Monitor IN4 (+12V)

HW Monitor IN5 (-12V)

HW Monitor IN6 (-5V)

The current voltage is shown (only available with the optional hardware monitor).

CPU Fan

Secondary Fan

The current fan speed is shown (only available with the optional hardware monitor).

Onboard IDE

This option specifies the IDE channel used by the onboard IDE controller. The settings are Disabled, Primary, Secondary and Both (*default*).

Auto Detect Hard Disk

Choose this option to let AMIBIOS find the IDE hard disk drive parameters for all IDE drives connected to the primary and secondary IDE channels installed in the system. AMIBIOS automatically configures the drive parameters after it has detected these parameters.

Change User Password

Select the Change User Password from the Security section of the AMIBIOS Setup main menu. Enter the password and press <Enter>. The screen does not display the characters entered. After the new password is entered, retype the new password as prompted and press <Enter>. This option will be available only if Supervisor Passwords exists.

Change Supervisor Password

Select the Change Supervisor Password from the Security section of the AMIBIOS Setup main menu. Enter the password and press <Enter>. The screen does not display the characters entered. After the new password is entered, retype the new password as prompted and press <Enter>.



***Remember the Password** Keep a record of the new password when the password is changed. If you forget the password, you must erase the system configuration information in NVRAM (Non-Volatile Random Access Memory).*

Change Language Settings

N/A.

Auto Configuration with Optimal Settings

You can load the optimal default settings for the AMIBIOS by selecting the Optimal option. The Optimal default settings are best-case values that should optimize system performance. If CMOS is corrupted, the Optimal settings are loaded automatically.

Auto Configuration with Fail-Safe Settings

You can load the Fail-Safe AMIBIOS Setup option settings by selecting the Fail-Safe option from the Default section of the AMIBIOS Setup main menu. The Fail-Safe settings provide far from optimal system performance, but are the most stable settings. Use this option as a diagnostic aid if the system is behaving erratically.

Save Settings and Exit

Exit AMIBIOS saving the changes.

Exit without Saving

Allows to exit AMIBIOS setup without saving.

User's Notes:

Chapter 3

Upgrading

Upgrading the System Memory

The Raptor ATX allows an upgrade of the system memory with up to 384MB unbuffered SDRAM and up to 768MB registered SDRAM DIMM modules. ECC and non-ECC modules are supported. PC100 memory modules are recommended, but required for PIII or 100MHz FSB operation. The Raptor ATX offers 3 DIMM memory sockets. It is very important that the quality of the DIMM is good. Undesirable operation of the system may result if poor quality DIMMs are used. Always purchase your memory from a reliable source.

Upgrading the Microprocessor

The latest revision of the Raptor ATX currently supports socket PGA370 architecture Intel Celeron Processors and PIII PGA processors. Please, check the manufacturer's web site for details and revisions regarding CPU speed.

Since the Raptor ATX features CPU auto-sensing device there is only one jumper to be set when changing the CPU, JP11, if it's no set to auto. This jumper is the Clock Speed selector.

User's Notes:

Appendix A

Technical Specifications

Chipsets

Core Logic

Intel 440BX Chipset.

Peripheral I/O

Standard Microsystems (SMSC) FDC37B722.

Micro Processor Support

Celeron and PIII PGA processors up to 100MHz FSB.

System Memory

Memory Capacity

Up to 768MB registered SDRAM or up to 384MB unbuffered SDRAM DIMM Modules.

Memory Type

Three sockets for JEDEC standard (168 pins) DIMMs. The memory configuration is set automatically through BIOS via SPD. Supports SDRAM 3.3V SDRAM PC66 and PC100 memory modules. ECC and non-ECC, registered and unbuffered modules are supported.

Bios

System BIOS

AMI Hiflex BIOS with Flash BIOS option.

Flash BIOS

Optional feature for System BIOS. Flash programming built into the BIOS. BIOS to be flashed is read from a floppy.

Embedded I/O

IDE

Two PCI EIDE controllers. Supports up to 4 devices. Ultra DMA up to 33MB/sec. supported. ATAPI compatible. 34 pin headers on-board.

Floppy

Up to two floppy disk drives. Sizes supported are: 5.25" 360K and 1.2MB; 3.5" 720K, 1.44MB and 2.88MB.

Serial Ports

Two high speed 16550 compatible UARTS. BIOS configurable as COM1 - 4.

USB Interfaces

On-board dual USB.

Parallel Port

One Centronics compatible, bi-directional (PS/2 compatible). Microsoft/HP EPC/EPP high speed.

Mouse Port

One PS/2 compatible mouse controller.

Disk-On-Chip - Solid State Flash Disk

On-board support for two Disk-on-Chip devices, currently up to 288MB each. Addresses selectable through jumper JP7.

On-board Ethernet

On-board auto-sensing, bus mastering 10/100 Ethernet (Intel 82559ER).

Industrial Devices

Watchdog Timer

On-board 150, 600 and 1200ns hardware and software watchdog timer with VCC monitor.

POST Code

On-board POST code display for self-diagnostics and custom applications (refer to Appendix D).

Temperature and Voltage Device

On-board voltage, CPU fan speed and CPU temperature monitoring devices (optional).

Power Management

Power button function: advanced power management support.

Miscellaneous

CMOS/Battery

RTC with lithium battery. No external battery is required.

Control Panel Connections

Reset, Keylock, Speaker, Soft Power. LEDs for power and IDE.

CPU Socket

Standard ZIF (Zero Insertion Force), PGA 370.

Form Factor

ATX form factor (8" x 12").

PCB Construction

Four Layers, dry film mask.

Manufacturing Process

Automated surface mount.

Reliability

MTBF: 52,300 hours.

Table A-1 Environmental

Environmental	Operating	Non-operating
Temperature	0° to +55° C	-40° to +65° C
Humidity	5 to 95% @ 40° C non-condensing	5 to 95% @ 40° C non-condensing
Shock	2.5G @ 10ms	10G @ 10ms
Vibration	0.25 @ 5-100Hz	5 @ 5-100Hz

Memory Map

Address Range Decimal	Address Range Hexadecimal	Size	Description
960K-1M	0F0000-0FFFFFFF	64 KB	Upper BIOS
896K-960K	0E0000-0EFFFFF	64 KB	Lower BIOS
768K-896K	0C0000-0DFFFFF	128 KB	Expansion Card BIOS and Buffer
640K-768K	0A0000-0BFFFFF	128 KB	Standard PCI/ISA Video Memory
512K-640K	080000-09FFFFF	128 KB	Ext. Conventional memory
0K- 512K	000000-07FFFFF	512 KB	Conventional memory

DMA Channels

DMA #	Data Width	System Resource
0	8- or 16-bits	
1	8- or 16-bits	Parallel port (for ECP)
2	8- or 16-bits	Floppy Drive
3	8- or 16-bits	Parallel port (for ECP)
4	Reserved-	cascade channel
5	16-bits	Open
6	16-bits	Open
7	16-bits	Open

I/O Map

Address (hex)	Description
0000-000F	DMA 1
0020-0021	Interrupt Controller 1
0040	Timer/Counter 0
0041	Timer/Counter 1
0042	Timer/Counter 2
0043	Timer Control Word
0060	Keyboard Controller Byte _ Reset IRQ
0061	NMI Status and Control
0070, bit 7	NMI enable
0070, bits 6:0	RTC Index
0071	RTC Data
0072	RTC Extended Index
0073	RTC Extended Data
0080-008F	DMA page registers / POST code display also located at 0080h
0092	Port 92
00A0-00A1	Interrupt Controller 2
00B2-00B3	APM control
00C0-00DE	DMA 2
00F0	Coprocessor Error
0110	Watch-Dog Timer (default)
0170 _ 0177	Secondary IDE channel
01F0 _ 01F7	Primary IDE channel
029x	LM79
0278-027F	LPT2 (if selected)
02E8-02EF	COM4 (if selected)
02F8-02FF	COM2 (default)
0310	Watch-Dog Timer (if selected)
0376	Secondary IDE channel command port
0377	Floppy channel 2 command
0377, bit 7	Floppy disk change, channel 2
0377, bits 6:0	Secondary IDE channel status port
0378-037F	LPT1 (default)
03B4-03B5	Video (VGA)
03BA	Video (VGA)
03BC-03CD	LPT3 (if selected)
03C0-03CA	Video (VGA)
03CC	Video (VGA)
03CE-03CF	Video (VGA)

Address (hex)	Description
03D4-03D5	Video (VGA)
03DA	Video (VGA)
03E8-03EF	COM3 (if selected)
03F0-03F5	Floppy Channel 1
03F6	Primary IDE channel command port
03F7	Floppy Channel 1 command
03F7, bit 7	Floppy disk change channel 1
03F7, bits 6:0	Primary IDE channel status report
03F8-03FF	COM1 (default)
04D0-04D1	INTC-1 Edge/Level Control
0CF8-0CFB - 4 bytes	PCI configuration address register
0CF9	Reset control register
0CFC-0CFF - 4 bytes	PCI configuration data register

On-board Devices

DISK ON CHIP 1

Memory address selectable between:
D000(default), D400, D800, DC00.

DISK ON CHIP 2

Memory address selectable between:
D000, D400(default), D800, DC00.

PCI Configuration Space Map

Bus #	Device #	Function #	Description
00	00	00	440BX (Host Bridge)
00	01	00	440BX A.G.P. bus
00	07	00	PIIX4 PCI/ISA bridge
00	07	01	PIIX4 IDE bus master
00	07	02	PIIX4 USB
00	07	03	PIIX4 Power Management
00	0F	00	PCI expansion slot 1
00	10	00	PCI expansion slot 2

Bus #	Device #	Function #	Description
00	12	00	PCI expansion slot 3
00	14	00	PCI expansion slot 3
00	0E	00	82559ER Ethernet

Interrupts

IRQ	System Resource
NMI	I/O channel check
0	Reserved, interval timer
1	Reserved (keyboard)
2	Reserved (cascade)
3	COM2*
4	COM1*
5	User Available
6	Floppy Drive
7	LPT1*
8	Real time clock
9	User Available
10	User Available
11	User Available
12	PS/2 mouse port (if present, else user available)
13	Reserved (math coprocessor)
14	Primary IDE (if present, else user available)
15	Secondary IDE (if present, else user available)

**Default, but can be changed to another IRQ*

PCI Interrupt Routing Map

PIIX4 Signal	IDSEL	PIRQA	PIRQB	PIRQC	PIRQD
PCI Slot 1	AD26	INTC	INTD	INTA	INTB
PCI Slot 2	AD27	INTB	INTC	INTD	INTA
PCI Slot 3	AD29	INTA	INTB	INTC	INTD
PCI Slot 4	AD31	INTD	INTA	INTB	INTC
Ethernet	AD25	INTA			
USB	-				INTD
AGP	-	INTA	INTB		

SMBUS

Device	Slave Address
MAX1617	0011000b
LM79	0101101b
DIMM0	1010000b
DIMM1	1010001b
DIMM2	1010010b
SDRAM Clock	1101001b

Connectors Pin-out

How to identify pin number 1: Looking to the solder side (The board side without components) of the PCB (Printed Circuit Board), pin number 1 will have a squared pad ■. Other pins will have a circular pad ●.

How to identify other pins: Connectors type DB, PS/2, RJ45, Power ATX and USB are industry standards. DB connectors, for instance, are numbered sequentially. The first row is numbered in sequence (be aware that male and female connectors are mirrored – male connectors are numbered from left to right when viewed from front and female connectors are numbered from right to left when viewed from front). The following rows resume the counting on the same side of pin number 1. The counting is NOT circular like Integrated Circuits (legacy from electronic tubes).

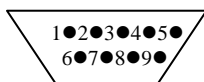

DB9 Male
Front view

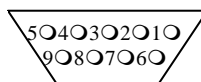

DB9 Female
Front view

Header connectors are numbered alternately, i.e. pin number 2 is in the other row, but in the same column of pin number 1. Pin number 3 is in the same row of pin 1, but in the next column and so forth.

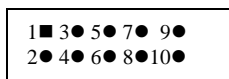

Header 10 pin connector
View from solder side of the PCB

Table A-9 Serial Ports COM 1 and COM 2 Connectors

Pin#	Serial Ports DB9M – J36 and J37
1	DCD
2	RX
3	TX
4	DTR
5	GND
6	DSR
7	RTS
8	CTS
9	RI

Table A-10 J1 Power LED/Keylock Header Connector Pin-out

Pin#	PWR LED/KBD Lock Header – J1
1	Power LED Anode
2	NC
3	Cathode
4	KEYLOCK#
5	Cathode

Table A-11 Ethernet RJ45

Pin#	Ethernet RJ45 – J31
1	TX+
2	TX-
3	RX+
4	Shorted to 5
5	Shorted to 4
6	RX-
7	Shorted to 8
8	Shorted to 7

Table A-12 Parallel DB25 Connector

Pin#	Parallel DB25F – J13
1	-STROBE
2	+DATA BIT 0
3	+DATA BIT 1
4	+DATA BIT 2
5	+DATA BIT 3
6	+DATA BIT 4
7	+DATA BIT 5
8	+DATA BIT 6
9	+DATA BIT 7
10	ACK1
11	BUSY
12	PAPER EMPTY
13	SLCT
14	AUTOFEED
15	ERROR
16	INIT
17	SLCT IN
18-25	GND

Table A-13 USB Connector Pin-out

Pin#	USB Connector – J14
1	+5V – USB1
2	-D – USB1
3	+D – USB1
4	GROUND – USB1
5	+5V – USB2
6	-D – USB2
7	+D – USB2
8	GROUND – USB2

Table A-14 Infra Red, HDD LED, CPU Fan, SYS FAN, LAN ACT LED, LAN Speed LED, Speaker and Wake On LAN.

Connector	Description					
J25	Infra Red					
	1)Rx	2)Tx	3)GND	4)NC	5)Key	6)Vcc
J5	HDD LED					
	1)Anode			2)Cathode		
J3	CPU FAN					
	1)Sense		2)+12V		3)GND	
J4	SYS FAN					
	1)Sense		2)+12V		3)GND	
J29	LAN ACT LED					
	1)Anode			2)Cathode		
J30	LAN Speed LED					
	1)Anode			2)Cathode		
J2	Speaker					
	1)+5V	2)NC	3)NC	4)Signal		
J8	Wake On LAN					
	1)5V Standby		2)GND		3)WOL Signal	

Table A-15 J38 Ethernet Header Connector Pin-out

Pin#	Ethernet Header – J38
1	Connected to pin 4 & 5 of RJ45
2	Connected to pin 7 & 8 of RJ45
3	RX+
4	RX-
5	Speed LED Cathode
6	Speed LED Anode
7	ACT LED Cathode
8	ACT LED Anode
9	TX+
10	TX-

User's Notes:

Appendix B Flash BIOS programming

The Raptor ATX offers the optional FLASH BIOS. When installed, you will be able to update your BIOS without having to replace the EPROM. The AMIBIOS will read the new BIOS file from a floppy disk, replace the old BIOS and reboot your computer.

When updating your BIOS, make sure you have a disk with the correct BIOS file (its size should be 256K).

Rename the file to "AMIBOOT.ROM". Turn your computer off. Move Jumper JP2 to 2-3. Insert the disk in Drive A:, Turn the computer on while pressing <CTRL><HOME>. Your computer will show no screen, but will beep to indicate what is being done.

If the programming is successful, you should hear 4 beeps and your computer will reboot with the new BIOS.

Please never turn the power off while reprogramming a FLASH BIOS.

Do not forget to move Jumper JP2 back to 1-2 after turning off.

Refer to the table on the next page for beep errors.

Table B-1 Flash BIOS Programming Selection

Flash Write-protect	Enabled	Disabled
JP2	1-2*	2-3

**Manufacturer's Settings.*

Table B-2 Flash BIOS Beep Errors

Beeps	Description
1	Insert diskette in floppy A:
2	The AMIBOOT.ROM file was not found in the root directory of floppy drive A:
3	Base memory error
4	Flash program successful
5	Floppy read error
6	Keyboard controller BAT command failed
7	No FLASH EPROM detected
8	Floppy controller failure
9	Boot Block BIOS checksum error
10	Flash erase error
11	Flash program error
12	AMIBOOT.ROM file size error

Appendix C Disk-On-Chip

The Raptor ATX offers two on-board flash disks as optional devices. The Disk-On-Chip is a single chip flash disk device in a standard 32-pin DIP socket.

It features up to 288MB (each) of storage capacity with high-speed boot-up capabilities, including the Flash File System (FFS) for easy storage.

This feature of the Raptor ATX is a perfect replacement for conventional hard-drives in the harsh industrial environment where shock and vibration is a burden for standard hard drives.

Jumper JP7 selects the memory addresses to be used for the Disk-On-Chip. Possible addresses are listed below.

Table C-1 Disk-on-Chip Selection

Addresses	JP7 1-2	JP7 3-4	JP7 5-6	JP7 7-8
D000h/D400h*	Closed	Open	Open	Open
D400h/D800h	Open	Closed	Open	Open
D800h/DC00h	Open	Open	Closed	Open
DC00h/D000h	Open	Open	Open	Closed

* *Manufacturer's Settings.*

For upgrade and technical specifications about Disk-on-Chip, please contact the manufacturer M-Systems at www.m-sys.com.

User's Notes:

Appendix D

On-Board Industrial Devices

The Raptor ATX features two industrial devices: A watchdog timer that will reset the system in case of failure according to a pre-set time-out, and a Post Code display that will help you on troubleshooting.

Watchdog Timer

This device can be set as hardware, software or disabled (*Table D-1*). The watchdog timer will monitor your motherboard and reset if any problem occurs. The time-out ranges from 1200, 600 and 150 milliseconds (*Table D-2*). The Watchdog timer can work in two ways:

Hardware Reset

The watchdog timer monitors the BALE signal. If BALE stops oscillating for the time set at JP8, the watchdog will reset the board.

Software Reset

The software has to access the watchdog timer at least every time-out to prevent the board from resetting. This allows a very tight control of the motherboards operation, but involves writing software for the time-out control. For using software control, you need to know the watchdog address, the enable bit and the strobe bit. For example, if you set the watchdog timer to address 310h, you have to output a 0 at bit 1 of 310h to enable the watchdog, and then toggle bit 0 of 310h to strobe it. If the strobe signal takes longer than the time-out the board will reset.

Table D-1 Watchdog Timer Selection

Watchdog Type	JP10 1-2	JP10 3-4	JP10 5-6
Hardware	Closed	Open	Open
Disabled*	Open	Closed	Open
Software	Open	Open	Closed

* *Manufacturer's Settings.*

Table D-2 Watchdog Time-out Selection

Watchdog Timeout	JP8 1-2	JP8 2-3	JP8 3-4
1200 ms*	Closed	Open	Open
600 ms	Open	Closed	Open
150 ms	Open	Open	Closed

* *Manufacturer's Settings.*

Table D-3 Watchdog Address Selection

Watchdog Address	JP6 1-2	JP6 2-3
110h*	Closed	Open
310h	Open	Closed

* *Manufacturer's Settings.*

Post Code Display

The POST code display is a device implemented on the Raptor ATX to help on failure diagnostics. A POST code is transmitted by the BIOS during the POST (Power On Self Test). It is a number that refers to the state or test condition of a circuit or group of circuits. Knowing the results of these tests (hence the POST code) can be very important in debugging a system.

POST Checkpoint Codes

When AMIBIOS performs the Power On Self Test, it writes diagnostic codes checkpoint codes to I/O port 0080h where the POST code display is connected.

Table D-4 Uncompressed Initialization Codes

The uncompressed initialization checkpoint codes are listed in order of execution:

Checkpoint Code	Description
D0h	The NMI is disabled. Power on delay is starting. Next, the initialization code checksum will be verified.
D1h	Initializing the DMA controller, performing the keyboard controller BAT test, starting memory refresh, and entering 4 GB flat mode next.
D3h	Starting memory sizing next.
D4h	Returning to real mode. Executing any OEM patches and setting the stack next.
D5h	Passing control to the uncompressed code in shadow RAM at E000:0000h. The initialization code is copied to segment 0 and control will be transferred to segment 0.
D6h	Control is in segment 0. Next, checking if <Ctrl> <Home> was pressed and verifying the system BIOS checksum. If either <Ctrl> <Home> was pressed or the system BIOS checksum is bad, next will go to checkpoint code E0h. Otherwise, going to checkpoint code D7h.
D7h	Main BIOS runtime code is to be decompressed and control to be passed to main BIOS in shadow RAM.

Table D-5 Bootblock Recovery Codes

The bootblock recovery checkpoint codes are listed in order of execution:

Checkpoint Code	Description
E0h	The onboard floppy controller if available is initialized. Next, beginning the base 512 KB memory test.
E1h	Initializing the interrupt vector table next.
E2h	Initializing the DMA and Interrupt controllers next.
E6h	Enabling the floppy drive controller and Timer IRQs. Enabling internal cache memory.
EDh	Initializing the floppy drive.
EEh	Looking for a floppy diskette in drive A:. Reading the first sector of the diskette.
EFh	A read error occurred while reading the floppy drive in drive A:.
F0h	Next, searching for the AMIBOOT.ROM file in the root directory.
F1h	The AMIBOOT.ROM file is not in the root directory.
F2h	Next, reading and analyzing the floppy diskette FAT to find the clusters occupied by the AMIBOOT.ROM file.
F3h	Next, reading the AMIBOOT.ROM file, cluster by cluster.
F4h	The AMIBOOT.ROM file is not the correct size.
F5h	Next, disabling internal cache memory.
FBh	Next, detecting the type of flash ROM.
FCh	Next, erasing the flash ROM.
FDh	Next, programming the flash ROM.
FFh	Flash ROM programming was successful. Next, restarting the system BIOS.

Table D-6 Uncompressed Initialization Codes

The following runtime checkpoint codes are listed in order of execution. These codes are uncompressed in F0000h shadow RAM.

Checkpoint Code	Description
03h	The NMI is disabled. Next, checking for a soft reset or a power on condition.
05h	The BIOS stack has been built. Next, disabling cache memory.
06h	Uncompressing the POST code next.
07h	Next, initializing the CPU and the CPU data area.
08h	The CMOS checksum calculation is done next.
0Ah	The CMOS checksum calculation is done. Initializing the CMOS status register for date and time next.
0Bh	The CMOS status register is initialized. Next, performing any required initialization before the keyboard BAT command is issued.
0Ch	The keyboard controller input buffer is free. Next, issuing the BAT command to the keyboard controller.
0Eh	The keyboard controller BAT command result has been verified. Next, performing any necessary initialization after the keyboard controller BAT command test.
0Fh	The initialization after the keyboard controller BAT command test is done. The keyboard command byte is written next.
10h	The keyboard controller command byte is written. Next, issuing the Pin 23 and 24 blocking and unblocking command.
11h	Next, checking if <End or <Ins> keys were pressed during power on. Initializing CMOS RAM if the <i>Initialize CMOS RAM in every boot</i> AMIBIOS POST option was set in AMIBCP or the <End> key was pressed.
12h	Next, disabling DMA controllers 1 and 2 and interrupt controllers 1 and 2.
13h	The video display has been disabled. Port B has been initialized. Next, initializing the chipset.
14h	The 8254 timer test will begin next.
19h	The 8254 timer test is over. Starting the memory refresh test next.

Checkpoint Code	Description
1Ah	The memory refresh line is toggling. Checking the 15 second on/off time next.
23h	Reading the 8042 input port and disabling the MEGAKEY Green PC feature next. Making the BIOS code segment writable and performing any necessary configuration before initializing the interrupt vectors.
24h	The configuration required before interrupt vector initialization has completed. Interrupt vector initialization is about to begin.
25h	Interrupt vector initialization is done. Clearing the password if the POST DIAG switch is on.
27h	Any initialization before setting video mode will be done next.
28h	Initialization before setting the video mode is complete. Configuring the monochrome mode and color mode settings next.
2Ah	Bus initialization system, static, output devices will be done next, if present. See <i>Table D-7</i> for additional information.
2Bh	Passing control to the video ROM to perform any required configuration before the video ROM test.
2Ch	All necessary processing before passing control to the video ROM is done. Looking for the video ROM next and passing control to it.
2Dh	The video ROM has returned control to BIOS POST. Performing any required processing after the video ROM had control.
2Eh	Completed post-video ROM test processing. If the EGA/VGA controller is not found, performing the display memory read/write test next.
2Fh	The EGA/VGA controller was not found. The display memory read/write test is about to begin.
30h	The display memory read/write test passed. Look for retrace checking next.
31h	The display memory read/write test or retrace checking failed. Performing the alternate display memory read/write test next.
32h	The alternate display memory read/write test passed. Looking for alternate display retrace checking next.
34h	Video display checking is over. Setting the display mode next.

Checkpoint Code	Description
37h	The display mode is set. Displaying the power on message next.
38h	Initializing the bus input, IPL, general devices next, if present. See <i>Table D-7</i> for additional information.
39h	Displaying bus initialization error messages. See <i>Table D-7</i> for additional information.
3Ah	The new cursor position has been read and saved. Displaying the <i>Hit </i> message next.
3Bh	The <i>Hit </i> message is displayed. The protected mode memory test is about to start.
40h	Preparing the descriptor tables next.
42h	The descriptor tables are prepared. Entering protected mode for the memory test next.
43h	Entered protected mode. Enabling interrupts for diagnostics mode next.
44h	Interrupts enabled if the diagnostics switch is on. Initializing data to check memory wraparound at 0:0 next.
45h	Data initialized. Checking for memory wraparound at 0:0 and finding the total system memory size next.
46h	The memory wraparound test is done. Memory size calculation has been done. Writing patterns to test memory next.
47h	The memory pattern has been written to extended memory. Writing patterns to the base 640 KB memory next.
48h	Patterns written in base memory. Determining the amount of memory below 1 MB next.
49h	The amount of memory below 1 MB has been found and verified. Determining the amount of memory above 1 MB memory next.
4Bh	The amount of memory above 1 MB has been found and verified. Checking for a soft reset and clearing the memory below 1 MB for the soft reset next. If this is a power on situation, going to checkpoint 4Eh next.
4Ch	The memory below 1 MB has been cleared via a soft reset. Clearing the memory above 1 MB next.
4Dh	The memory above 1 MB has been cleared via a soft reset. Saving the memory size next. Going to checkpoint 52h next.

Checkpoint Code	Description
4Eh	The memory test started, but not as the result of a soft reset. Displaying the first 64 KB memory size next.
4Fh	The memory size display has started. The display is updated during the memory test. Performing the sequential and random memory test next.
50h	The memory below 1 MB has been tested and initialized. Adjusting the displayed memory size for relocation and shadowing next.
51h	The memory size display was adjusted for relocation and shadowing. Testing the memory above 1 MB next.
52h	The memory above 1 MB has been tested and initialized. Saving the memory size information next.
53h	The memory size information and the CPU registers are saved. Entering real mode next.
54h	Shutdown was successful. The CPU is in real mode. Disabling the Gate A20 line, parity, and the NMI next.
57h	The A20 address line, parity, and the NMI are disabled. Adjusting the memory size depending on relocation and shadowing next.
58h	The memory size was adjusted for relocation and shadowing. Clearing the <i>Hit </i> message next.
59h	The <i>Hit </i> message is cleared. The <i><WAIT...></i> message is displayed. Starting the DMA and interrupt controller test next.
60h	The DMA page register test passed. Performing the DMA Controller 1 base register test next.
62h	The DMA controller 1 base register test passed. Performing the DMA controller 2 base register test next.
65h	The DMA controller 2 base register test passed. Programming DMA controllers 1 and 2 next.
66h	Completed programming DMA controllers 1 and 2. Initializing the 8259 interrupt controller next.
67h	Completed 8259 interrupt controller initialization.
7Fh	Extended NMI source enabling is in progress.
80h	The keyboard test has started. Clearing the output buffer and checking for stuck keys. Issuing the keyboard reset command next.
81h	A keyboard reset error or stuck key was found. Issuing the keyboard controller interface test command next.

Checkpoint Code	Description
82h	The keyboard controller interface test completed. Writing the command byte and initializing the circular buffer next.
83h	The command byte was written and global data initialization has completed. Checking for a locked key next.
84h	Locked key checking is over. Checking for a memory size mismatch with CMOS RAM data next.
85h	The memory size check is done. Displaying a soft error and checking for a password or bypassing WINBIOS Setup next.
86h	The password was checked. Performing any required programming before WINBIOS Setup next.
87h	The programming before WINBIOS Setup has completed. Uncompressing the WINBIOS Setup code and executing the AMIBIOS Setup or WINBIOS Setup utility next.
88h	Returned from WINBIOS Setup and cleared the screen. Performing any necessary programming after WINBIOS Setup next.
89h	The programming after WINBIOS Setup has completed. Displaying the power on screen message next.
8Bh	The first screen message has been displayed. The <WAIT...> message is displayed. Performing the PS/2 mouse check and extended BIOS data area allocation check next.
8Ch	Programming the WINBIOS Setup options next.
8Dh	The WINBIOS Setup options are programmed. Resetting the hard diskcontroller next.
8Fh	The hard disk controller has been reset. Configuring the floppy drivecontroller next.
91h	The floppy drive controller has been configured. Configuring the hard disk drive controller next.
95h	Initializing the bus option ROMs from C800 next. See <i>Table D-7</i> for additional information.
96h	Initializing before passing control to the adaptor ROM at C800.
97h	Initialization before the C800 adaptor ROM gains control has completed. The adaptor ROM check is next.

Checkpoint Code	Description
98h	The adaptor ROM had control and has now returned control to BIOS POST. Performing any required processing after the option ROM returned control.
99h	Any initialization required after the option ROM test has completed. Configuring the timer data area and printer base address next.
9Ah	Set the timer and printer base addresses. Setting the RS-232 base address next.
9Bh	Returned after setting the RS-232 base address. Performing any required initialization before the Coprocessor test next.
9Ch	Required initialization before the Coprocessor test is over. Initializing the Coprocessor next.
9Dh	Coprocessor initialized. Performing any required initialization after the Coprocessor test next.
9Eh	Initialization after the Coprocessor test is complete. Checking the extended keyboard, keyboard ID, and Num Lock key next. Issuing the keyboard ID command next.
A2h	Displaying any soft errors next.
A3h	The soft error display has completed. Setting the keyboard typematic rate next.
A4h	The keyboard typematic rate is set. Programming the memory wait states next.
A5h	Memory wait state programming is over. Clearing the screen and enabling parity and the NMI next.
A7h	NMI and parity enabled. Performing any initialization required before passing control to the adaptor ROM at E000 next.
A8h	Initialization before passing control to the adaptor ROM at E000h completed. Passing control to the adaptor ROM at E000h next.
A9h	Returned from adaptor ROM at E000h control. Performing any initialization required after the E000 option ROM had control next.
AAh	Initialization after E000 option ROM control has completed. Displaying the system configuration next.
ABh	Uncompressing the DMI data and executing DMI POST initialization next.
B0h	The system configuration is displayed.
B1h	Copying any code to specific areas.

Checkpoint Code	Description
00h	Code copying to specific areas is done. Passing control to INT 19h boot loader next.

Table D-7 Bus Checkpoint Codes

The system BIOS passes control to different buses at the following checkpoints:

Checkpoint Code	Description
2Ah	Initializing the different bus system, static, and output devices, if present.
38h	Initialized bus input, IPL, and general devices, if present.
39h	Displaying bus initialization error messages, if any.
95h	Initializing bus adaptor ROMs from C8000h through D8000h.

Table D-8 Additional Bus Checkpoints

While control is inside the different bus routines, additional checkpoints are output to I/O port address 0080h as word to identify the routines being executed.

These are word checkpoints. The low byte of checkpoint is the system BIOS checkpoint where control is passed to the different bus routines.

The high byte of checkpoint indicates that the routine is being executed in different buses. This information will not be shown on POST code display because this device is 8-bit only. However, it can be seen in any equipment connected to I/O port address 0080h.

The system BIOS passes control to different buses at the following checkpoints:

High Byte The high byte of these checkpoints includes the following information:

Bits	Description
Bits 7-4	0000 Function 0. Disable all devices on the bus. 0001 Function 1. Initialize static devices on the bus. 0010 Function 2. Initialize output devices on the bus. 0011 Function 3. Initialize input devices on the bus. 0100 Function 4. Initialize IPL devices on the bus. 0101 Function 5. Initiate general devices on the bus. 0110 Function 6. Initialize error reporting on the bus. 0111 Function 7. Initialize add-on ROMs for all buses.
Bits 3-0	Specify the bus 0 Generic DIM Device Initialization Manager. 1 Onboard System devices. 2 ISA devices. 3 EISA devices. 4 ISA PnP devices. 5 PCI devices.

Table D-9 AMIBIOS Beep Codes

Except for beep code #8, these codes are always fatal.

1 beep	Refresh failure.
2 beeps	Parity error.
3 beeps	Base 64K memory failure.
4 beeps	Timer not operational.
5 beeps	Processor error.
6 beeps	8042 - gate A20 failure.
7 beeps	Processor exception interrupt error.
8 beeps	Display memory read/write failure.
9 beeps	ROM checksum error.
10 beeps	CMOS shutdown register read/write error.
11 beeps	Cache memory bad.

Appendix E On-Board Ethernet

The Raptor ATX features a built-in 10/100 Ethernet controller (82559ER).

The 89559ER is a 32-bit PCI controller that features enhanced scatter-gather bus mastering capabilities which enable the 82559ER to perform high-speed data transfers over the PCI bus. The 82559ER bus master capabilities enable the component to process high-level commands and to perform multiple operations, thereby off-loading communication tasks from the system CPU.

It can operate in either full duplex or half duplex mode. In full duplex mode it adheres to the IEEE 802.3x Flow Control specification. Half duplex performance is enhanced by a proprietary collision reduction mechanism.

It can be enabled or disabled through jumper JP12.

The RJ45 Ethernet Connector pin-out can be seen on *Table A-11*, the Ethernet Header connector pin-out can be seen on *Table A-15* and the LEDs Connectors pin-out can be seen on *Table A-14*.

Table E-1 Ethernet Selection

Ethernet Selection	Enabled	Disabled
JP12	1-2*	2-3

**Manufacturer's Settings.*

User's Notes:

MN-RBXAX-04