

MAINBOARD

Installation Guide

Rev: 1.01H

Date: April - 99

- * All other product names are trademarks or copyrights of their respective owners.
- * Specifications and information contained in this manual are subject to change without notice.

Table of Contents

INTRODUCTION	3
Product Description	3
Features & Specifications	4
Package Checklist	5
Board Level Feature	6
Comprehensive Mainboard View	8
INSTALLATION.....	9
Installing the CPU.....	9
Setting the Jumpers.....	10
Connections	14
Installing the Memory Modules (DIMM)	25
Installing the Support Drivers and Utilities	26
SOFTWARE SUPPORT	29
Mainboard BIOS	29
Flash BIOS Programming Utility.....	30
Symbios SCSI Configuration Utility.....	31
DMI Utility	31

INTRODUCTION

Product Description

Designed as a flexible, high-performance and cost-effective solution for System Integrators and End Users alike, this mainboard provides the power and expandability to meet the requirements of the most advanced operating systems and software applications.

This mainboard is designed to provide Pentium ®-based (FSB 100MHz) system by utilizing the VIA Apollo MVP4 AGPset on Micro-ATX Platform. By incorporating such advanced features as Super I/O, AC97 audio, Ultra DMA/66 Bus Mastering IDE, Universal Serial Bus (USB) and Hardware Monitoring onto the mainboard, optimum system performance is assured and system design and implementation is simplified.

Fully “Plug & Play” compatible via an Award BIOS, this mainboard facilitates easy system configuration and peripheral setup. Also, the Award BIOS supports ACPI Readiness and is compatible with the PC’98 specification. This mainboard is the ideal foundation for high-end computer systems.

Remark:

The **XStore Pro IDE Driver** enhances memory management by working with the Windows 95/98 operating system, resulting in higher system performance by implementing "read-ahead caching after seeking". This is especially effective with the large block sizes of modern hard disks.

PC-cillin anti-virus software provides a powerful defense against viruses to protect data integration.

Package Checklist

Your mainboard package should include the items listed below. Damaged or missing items should be reported to your vendor.

- The mainboard
- Floppy disk ribbon cable
- IDE ribbon cable
- This Installation Guide
- BIOS, Driver & Utility Guide
- CD-ROM containing the following support software:
(The latest drivers can always be found at their respective web sites.)
 - VIA® PCI Bridge driver,
 - VIA VxD driver,
 - VIA PCI Mini-port driver
<http://www.via.com.tw/drivers>
 - Support software for updating the FLASH BIOS
 - HighPoint® XStore Pro IDE Bus Master
<http://www.highpoint-tech.com>
 - Trend ® PC-cillin Anti-Virus software
<http://www.antivirus.com>

Board Level Feature

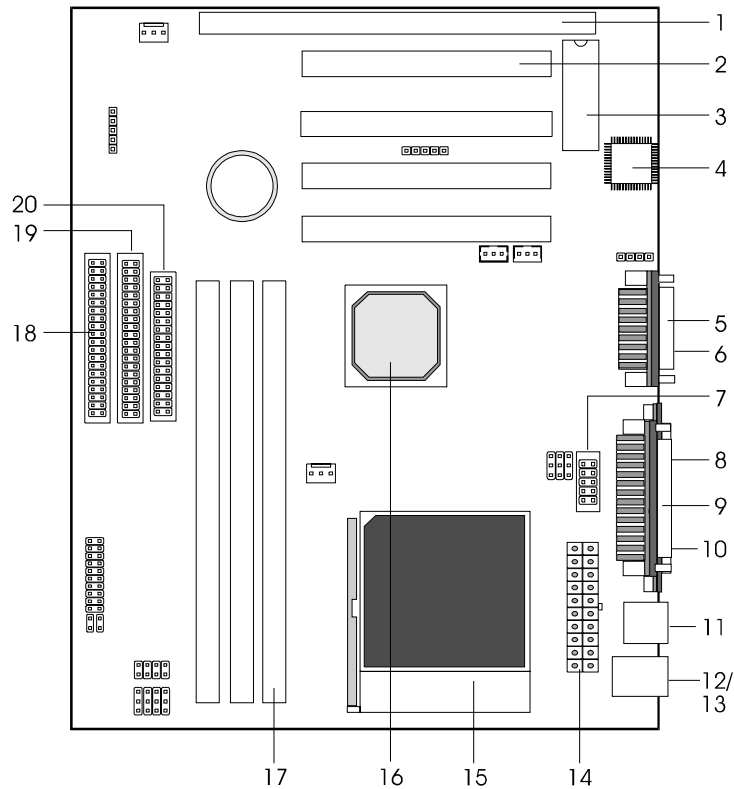

- | | |
|---------------------------|--------------------------------------|
| 1. ISA slot | 11. USB connectors |
| 2. PCI slots | 12. PS/2 mouse connector (top) |
| 3. Mainboard BIOS | 13. PS/2 keyboard connector (bottom) |
| 4. AC97 codec chip | 14. Power connector |
| 5. MIDI/Game port | 15. CPU socket (Socket 7) |
| 6. Audio port | 16. VIA® Apollo MVP4 AGPset |
| 7. COM2 connector | 17. DIMM sockets |
| 8. VGA connector | 18. Primary IDE connector |
| 9. Printer port connector | 19. Secondary IDE connector |
| 10. COM1 connector | 20. Floppy connector |

* Board Size: Micro-ATX 245 mm x 200 mm (9.6" x 7.7")

1. **ISA Slot:** (1) 16-bit ISA slot.
2. **PCI Slots:** (4) 32-bit PCI slots are provided.
3. **Mainboard BIOS:** Award BIOS supporting “Plug and Play”, DMI, Green PC specification, on screen setup for Enhanced IDE and Multi-I/O. The BIOS is FLASH Upgradeable via the AWDFLASH Utility.
4. **AC97 Codec Chip:** AC97 audio codec chip.
5. **MIDI/Game Port:** 15-pin female MIDI/Joystick connector.
6. **Audio Port:** Three 1/8” female jacks for Line Out, Line In and MIC.
7. **COM2 Connector:** Connects to High-speed UART compatible serial port bracket. COM2 can be directed to the Infrared Module for wireless connection capability.
8. **VGA Connector:** 9-pin VGA connector.
9. **Printer Port Connector:** EPP and ECP compatible 25-pin D-Sub parallel port.
10. **COM1 Connector:** High-speed UART compatible serial port.
11. **USB Connectors:** These connectors permit the connection of two USB peripheral devices directly to the port without an external hub. USB is a new technology supporting printers, fax modems and other telephony device.
12. **PS/2 Mouse Connector:** Supports PS/2 style mice.
13. **PS/2 Keyboard Connector:** Supports PS/2 style keyboards.
14. **Power Connector:** 20-Pin ATX Power Connector.
15. **CPU Socket:** ZIF Socket 7 for AMD® K6-2 / K6-3 up to 450 MHz, Cyrix® up to MII-500, Intel® Pentium MMX up to 233 MHz.
16. **VIA® Apollo MVP4 AGPset:** Supports Socket 7 CPUs, UDMA66 and AGP 2x.
17. **DIMM Sockets:** (3) 168-pin DIMM sockets are provided to support a maximum RAM memory capacity of 768 MB. DIMM types of 3.3 Volt true SDRAM is supported and automatically detected by the BIOS.
18. **Primary IDE Connector:** Connector for first IDE channel. The on-board PCI Bus Mastering IDE controller features support for DMA Mode 2 and PIO Modes 3 and 4 for faster data transfer rates. (2) Connectors are provided for support of up to (4) IDE devices on two channels. ATAPI Tape Drives and CD-ROMs are also supported.
19. **Secondary IDE Connector:** Connector for second IDE channel.
20. **Floppy Connector:** Built-in floppy controller supports (2) 5.25" or 3.5" (1.44MB or 2.88MB) floppy drives.

Comprehensive Mainboard View

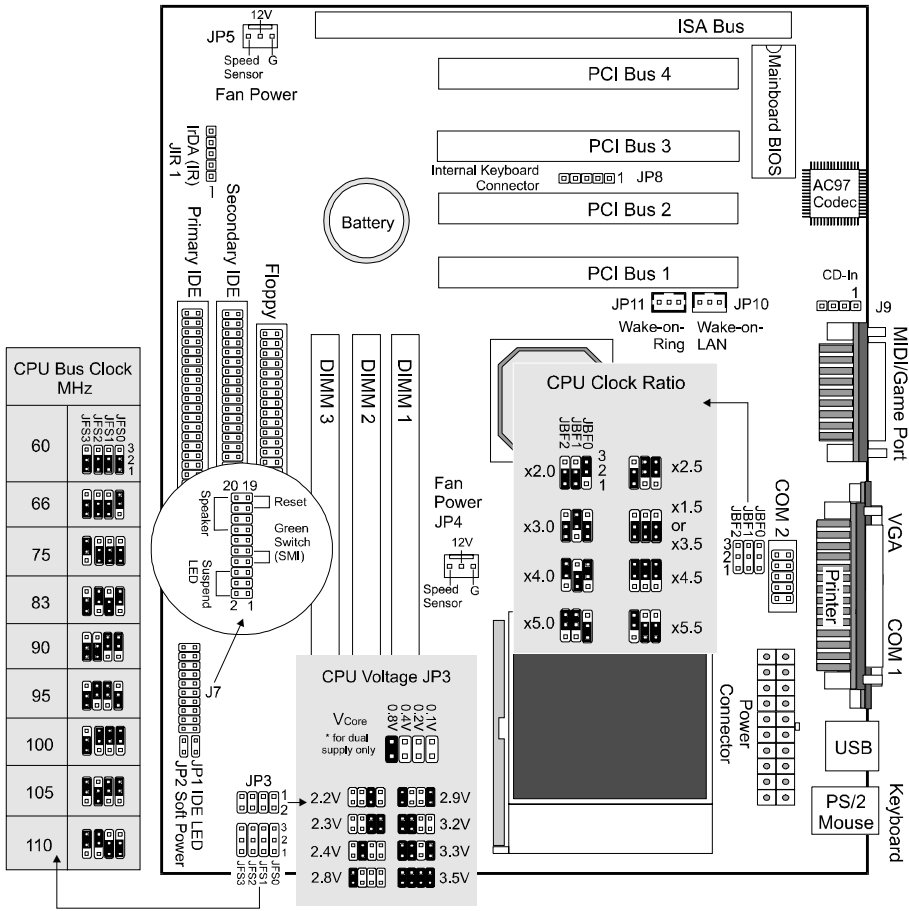

INSTALLATION

Static Precautions

Static electricity can be a serious danger to the electronic components on this mainboard. To avoid damage caused by electrostatic discharge, observe the following precautions:

- ✓ Don't remove the mainboard from its anti-static packaging until you are ready to install it into a computer case. Also, handle add-in cards and modules by the edges or mounting bracket.
- ✓ Before you handle the mainboard in any way, touch a grounded, anti-static surface, such as an unpainted portion of the system chassis, for a few seconds to discharge any built-up static electricity.

Installing the CPU

- ✓ **WARNING:** Use of a CPU Cooling Fan is required to prevent CPU from overheating. The Fan should be installed first before inserting the CPU into its socket.
1. Locate the ZIF (Zero Insertion Force) Socket 7.
 2. First open the socket by pulling the lever sideways, then upwards. Notice how the lever locks in place when pressed all the way down.
 3. The CPU must be inserted with the correct orientation. One corner of the CPU has a "Notch" and looks different than the other three. This corner is also missing a pin unlike the other three and is marked with a white dot on top of the CPU. Align this corner towards the end of the lever as shown in the figure here. Insert the CPU, press it down, and close the lever until it locks into place.

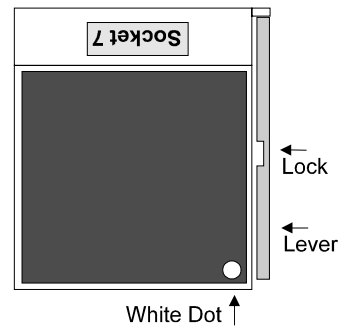

Setting the Jumpers

Jumpers are used on this mainboard to select various settings and features. A 2-pin jumper has two settings: Open and Short (or Closed). The jumper is closed by placing the Jumper Cap across the two pins, thereby connecting them. 3-pin jumpers can be set to pins 1-2 or 2-3 connected. Pin-1 is labeled on the circuit board.

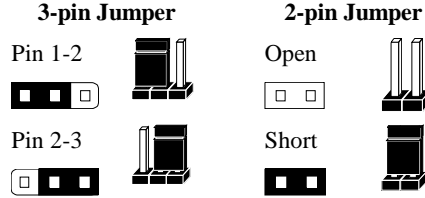

CPU Clock Selection Jumper (JBF0-2 and JFS0-3)

After installing the CPU, you must set the clock selection jumpers to match the frequency of the CPU. Find the Jumper Blocks labeled JBF0-2 and JFS0-3. Set the jumpers according to your particular CPU type (a list of current available CPU settings is provided on the following page).

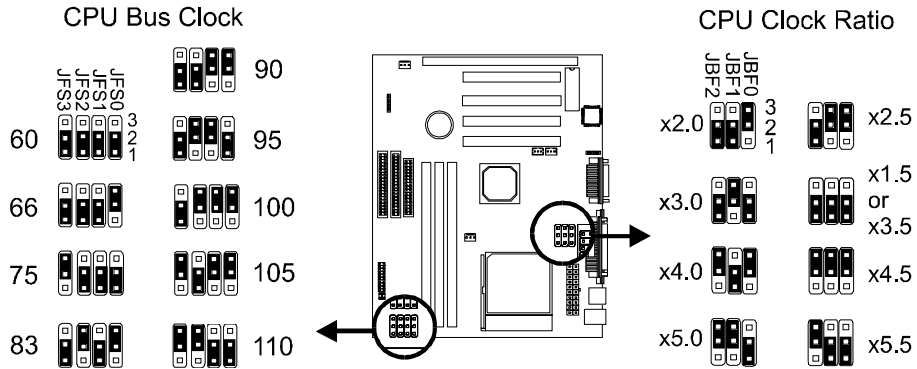

Jumper setting for CPU:			
<u>CPU Model</u>	<u>CPU Clock</u>	<u>Bus Clock (JFS0-3)</u>	<u>Ratio (JBF0-2)</u>
AMD-K6-III-450MHz	450MHz	100MHz	×4.5
AMD-K6-III-400MHz	400MHz	100MHz	×4.0
AMD-K6-2-450MHz	450MHz	100MHz	×4.5
AMD-K6-2-400MHz	400MHz	100MHz	×4.0
AMD-K6-2-350MHz	350MHz	100MHz	×3.5
AMD-K6-2-300MHz	300MHz	100MHz	×3.0
AMD-K6-2-266MHz	250MHz	100MHz	×2.5
AMD-K6-2-380MHz	380MHz	95MHz	×4.0
AMD-K6-2-333MHz	333MHz	95MHz	×3.5
AMD-K6-300MHz	300MHz	66MHz	×4.5
AMD-K6-266MHz	266MHz	66MHz	×4.0
AMD-K6-233MHz	233MHz	66MHz	×3.5
AMD-K6-200MHz	200MHz	66MHz	×3.0
AMD-K6-166MHz	166MHz	66MHz	×2.5
AMD-K5-PR200		66MHz	×3.0
AMD-K5-PR166		66MHz	×2.5
AMD-K5-PR133		66MHz	×1.5
Intel Pentium MMX-233	233MHz	66MHz	×3.5
Intel Pentium MMX-200	200MHz	66MHz	×3.0
Intel Pentium MMX-166	166MHz	66MHz	×2.5
Intel Pentium MMX-150	150MHz	60MHz	×2.5
Intel Pentium -200	200MHz	66MHz	×3.0
Intel Pentium -166	166MHz	66MHz	×2.5
Intel Pentium -150	150MHz	60MHz	×2.5
Intel Pentium -133	133MHz	66MHz	×2.0
Intel Pentium -120	120MHz	60MHz	×2.5
IDT WinChip 2-300		100MHz	×2.5
IDT WinChip 2-266		100MHz	×5.0
IDT WinChip 2-233	233MHz	66MHz	×3.5
IDT WinChip 2-200	200MHz	60MHz	×3.0
IDT C6-240	240MHz	60MHz	×4.0
IDT C6-225	225MHz	75MHz	×3.0
IDT C6-200	200MHz	66MHz	×3.0
IDT C6-180	180MHz	60MHz	×3.0
IDT C6-150	150MHz	75MHz	×2.0

INSTALLATION

RIS Ξ MP6 (PR266)	200MHz	100MHz	$\times 2.0$
RIS Ξ MP6 (PR233)	190MHz	95MHz	$\times 2.0$
RIS Ξ MP6 (PR166)	166MHz	83MHz	$\times 2.0$

- The Internal (Core) frequency corresponds to the number marked on the CPU. The External Frequency when multiplied with the Ratio gives the CPU's internal frequency.
- This table lists the current CPU available. New settings may be available for new CPU products. Refer to your CPU specifications for more information.

Setting the CPU Voltage Selection Jumper (JP3)

Locate Jumper JP3 on the mainboard. Set this jumper in accordance with your specific CPU type.

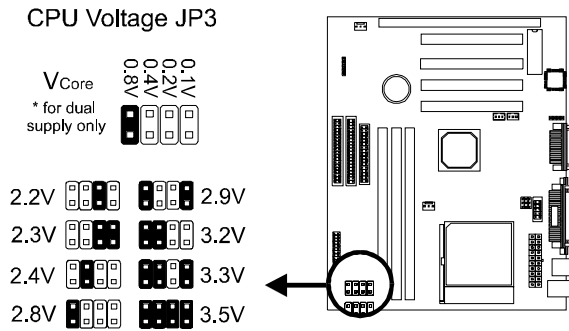

- * The Intel MMX CPU is an example of a dual supply chip (2.8V & 3.3V). When single supply CPUs are used, this setting is not relevant and should be left on the default (Refer to the CPU documentation).

The following diagram illustrates all possible CPU Vcore Voltage Selection jumper settings:

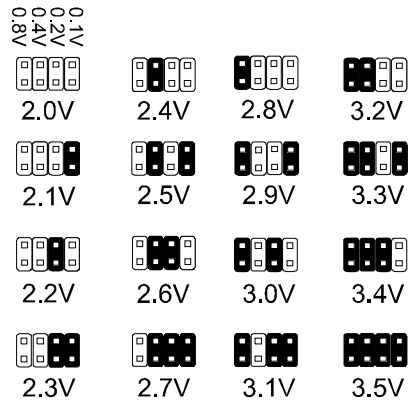

- If you are uncertain about the speed or voltage requirements of your particular CPU, you should obtain Technical Documentation from the manufacturer. Such information is available via the Intel and AMD WWW sites.

Connections

Cooling Fan (JP4 and JP5)

These connectors are small 3-pin Header Connectors that provide 12-Volt power for CPU and chassis cooling fans. Plug in the fan cable to the connector. Pin-2 corresponds to the RED power lead as shown:

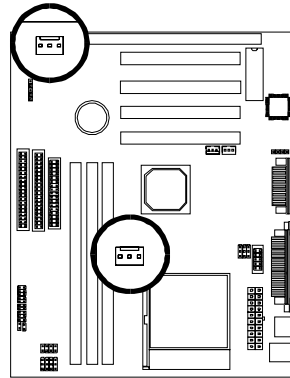
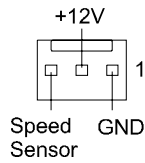

Power Supply Connector

This mainboard features an ATX-style Power Supply Connector. This connector is keyed to prevent connection in the wrong direction. Line up the locking mechanism on the connector from the Power Supply with the tab on the mainboard connector. Press down until the two connectors are locked.

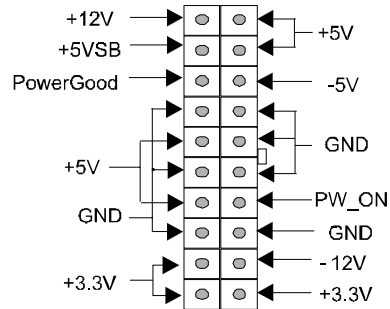
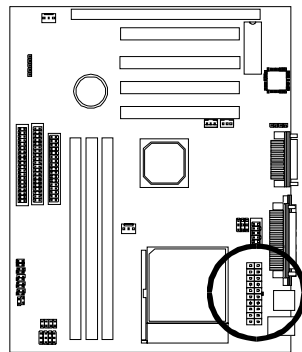

System Function Connector Block (J7)

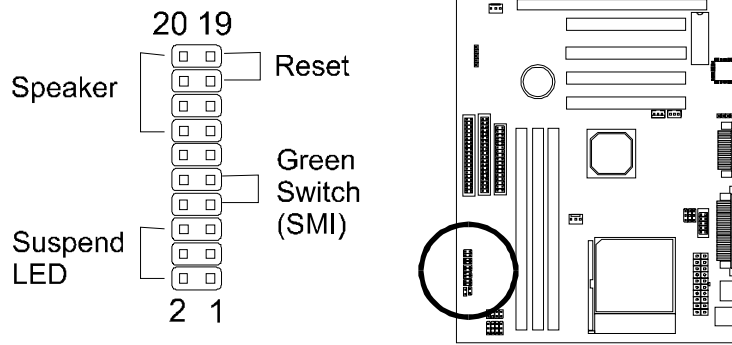

Pins [7 & 9] SMI suspend switch lead - If your system's case has a suspend switch, hook the lead from the switch to pins 7 & 9. A suspend switch is used to save electricity by putting the system into a suspend mode when the computer is not being used. For this switch to be functional, "*Suspend Mode*" must first be enabled in the **Power Management Setup** in the BIOS Setup utility.

Pins [17 & 19] Reset switch lead - Connects to the Reset Switch lead from the system's case. The reset switch is used to "cold-boot" the system without actually turning off the power, reducing wear and tear on the power supply.

Pins [2 & 6] Suspend LED lead - Pins 2 & 6 connect to the case-mounted Suspend LED switch.

Pins [14 & 20] Speaker connector - Connects to the Speaker lead from the system's case.

INSTALLATION

IDE Activity LED (JP1)

Hook the IDE LED lead to this connector, with the RED lead corresponding to Pin-1.

Soft Power Switch (JP2)

Connects to the Power Switch featured on ATX case designs. This switch must be hooked up before the system can be powered on, unlike traditional “Baby-AT” designs where the power switch is located on the Power Supply itself.

Note: Under the following two conditions, you have to press and hold the switch for more than 4 seconds to power off your system, regardless of *the “Soft-Off by PWRBTN”* setting in the **Power Management Setup** of the BIOS.

- *Shortly after the system is powered on, when the BIOS message is not yet appear.*
- *When CPU hangs.*

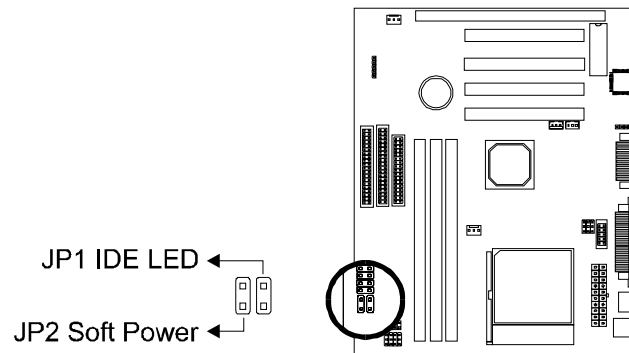

IrDA-Compliant Infrared Module Connector (JIR1)

The IrDA connector bracket hooks directly to this connector on the mainboard. This connector provides support for the optional wireless transmitting and receiving infrared module. You must first configure through the BIOS setup where UART2 is directed, COM2 or IrDA.

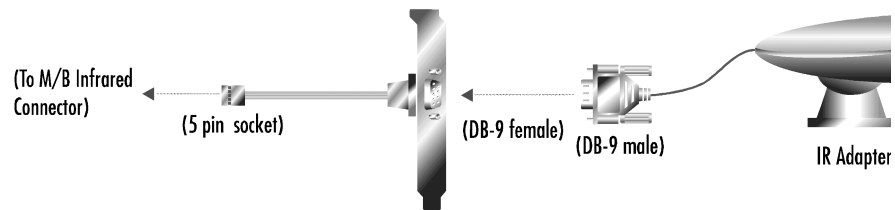
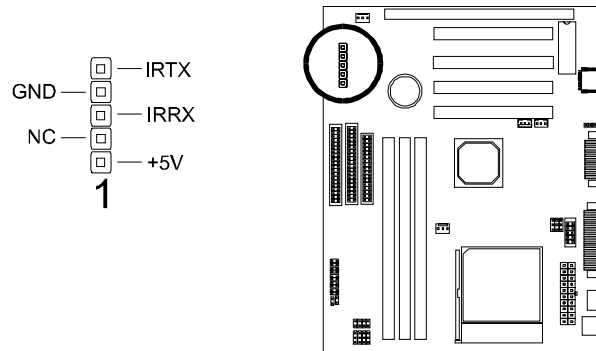

INSTALLATION

Wake-up On LAN Connector (JP10)

The Wake-up On LAN function will allow the network to wake up a Soft Power Down (Soft-Off) PC. However, if your system is in the Suspend mode, you can wake-up the system only through an IRQ or DMA interrupt. To use the Wake-up On LAN function, you must enable the “***Power On By Ring/LAN***” field in the **Power Management Setup** of the Award BIOS. Connect the cable that comes with your LAN card to this connector on the system board. Refer to the add-in card’s manual for details.

Note: Your LAN card must support Magic Packet in order to use the Wake-up On LAN function.

Wake-on-Ring Function (JP11)

The Wake-on-Ring function allows the modem to remotely power on the system. Install an external modem (normally to COM2) and enable “***Power On by Ring/LAN***” function in the **Power Management Setup** from the BIOS.

For the function to work for an ***internal modem card***, you must also connect the Wake-on-Ring cable on the modem card to the *Wake-on-Ring function connector* on the mainboard.

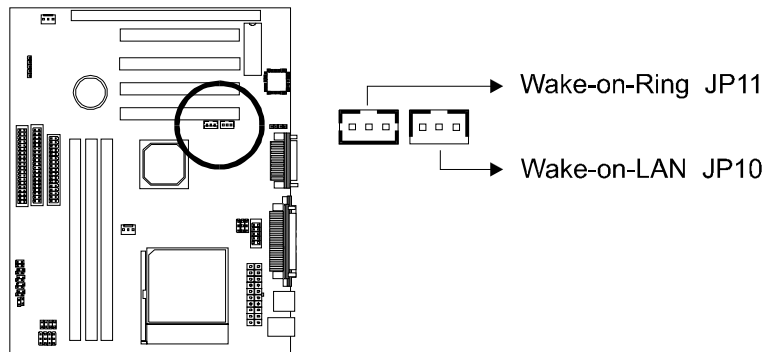

Serial and Parallel Ports

A 25-pin D-Sub header is provided on the back panel for a multi-mode bi-directional parallel port.

One 9-pin D-Sub headers are also provided on the back panel for Serial ports.

For the second serial port, plug the 10-pin cable of the serial port bracket to the COM2 connector on the mainboard.

VGA Connector

This mainboard has built-in VGA features. A 9-pin connector is provided on the back panel for connecting to the VGA connector from the monitor.

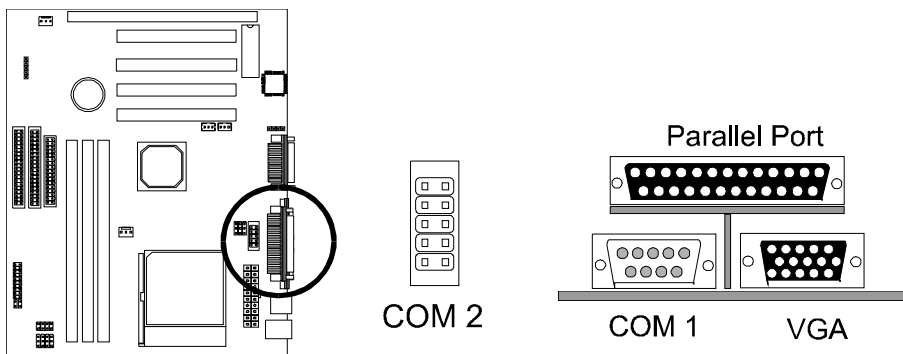

INSTALLATION

USB Connectors

These two connectors permit connection of two USB peripheral devices directly to the system without an external hub.

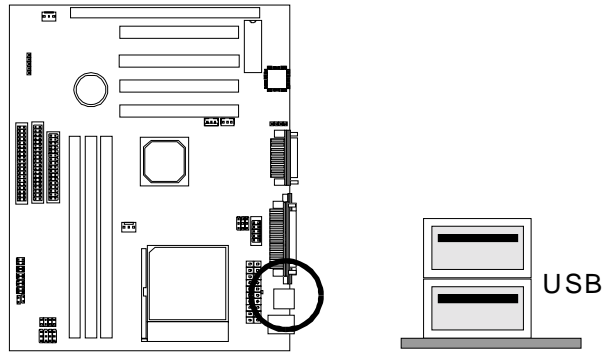

PS/2 Keyboard and Mouse Connectors

These two connectors are located on the back panel of the mainboard.

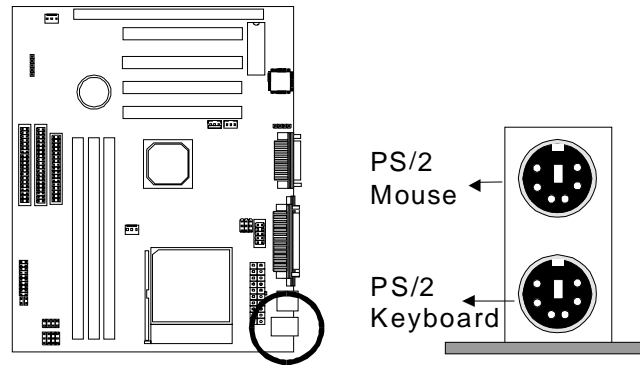

Internal Keyboard Connector

The front panel keyboard connector bracket hooks directly to this 5-pin connector on the mainboard. Make sure the red lead is oriented toward pin 1.

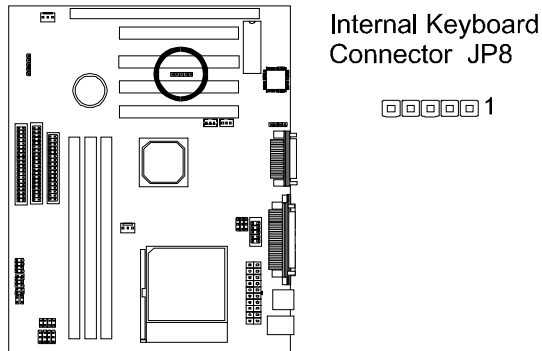

Floppy Drives

The on-board floppy controller supports (2) floppy disk drives with the floppy ribbon cable provided. Make sure the RED stripe on the ribbon cable is oriented towards Pin-1. Notice the “twist” between the sets of connectors on the floppy cable. The floppy drive “A” position is at the END of the cable, whereas floppy drive “B” is hooked to one of the connectors on the other side of the twist. The cable provides both “Edge” and “Pin” connectors for both the A and B positions to match the connector on your floppy drives.

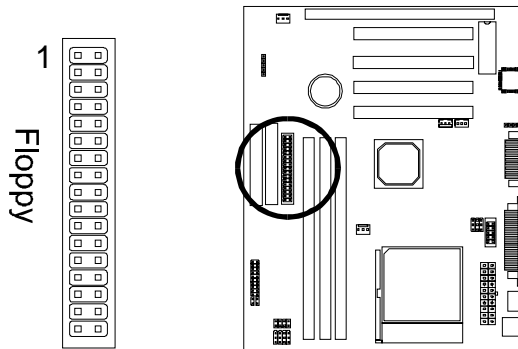

INSTALLATION

IDE Hard Drives and CD-ROMs

The on-board Enhanced IDE controller can support up to (4) IDE hard drives or other ATAPI devices, such as CD-ROMs. This controller, as with all Enhanced IDE controllers, consists of both Primary and Secondary ports. Each port has an associated connector and cable which can support up to (2) ATAPI devices each.

All IDE devices have jumpers which allow the user to configure the device as either “Master” or “Slave”. A Master device is one that is ALONE on the IDE cable, whereas a Slave device is installed as a SECOND device on the same cable. Keep in mind that the Master device will appear before the Slave device in the CMOS Setup, as well as the Operating System software. *Refer to the device documentation for jumper settings.

The Secondary IDE port can be used for up to (2) additional ATAPI devices. Normally it's recommended that you connect your first hard drive to the Primary port, and the first CD-ROM to the Secondary.

Make sure to align the RED stripe on the ribbon cable with Pin-1 on the mainboard IDE connector. On most hard drives and CD-ROMs, the RED stripe should be oriented towards the power connector of the device.

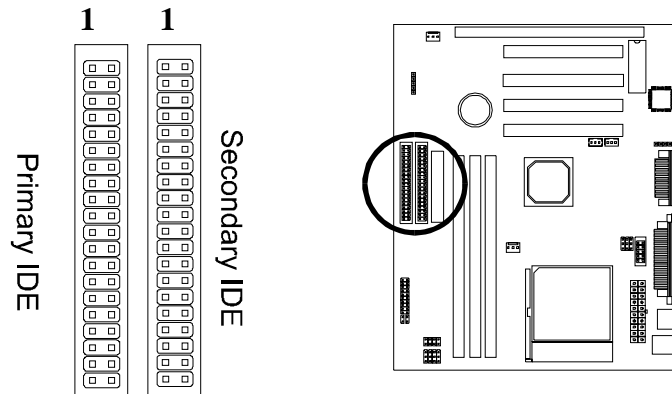

MIDI/Game Port

You may plug a joystick or game pad to this 15-pin female connector for game playing, or connect a MIDI device for playing or editing audio.

Audio Port

You can connect powered speakers or headphones to Line Out jack. Cassette players or other external audio sources can be connected to Line In jack. Plug in your microphones to MIC jack.

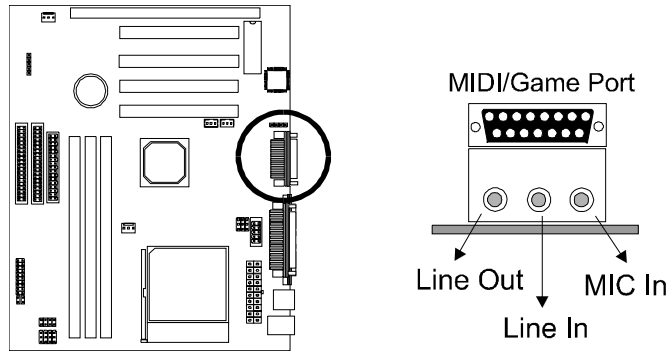

Note:

To use the on-chip direct sound AC97 audio support, make sure that the “***OnChip Sound***” option in **Chipset Features Setup** of the BIOS is enabled (default).

To use the on-chip legacy SoundBlaster-compatible audio support, make sure that the “***Onboard Legacy Audio***” options in **Integrated Peripherals Setup** of the BIOS is set according to your system configuration *before driver installation*.

INSTALLATION

Audio Connectors (J9)

A CD Audio connector is available for connecting the CD-ROM drive using CD audio cables. Make sure red lead is oriented toward pin 1.

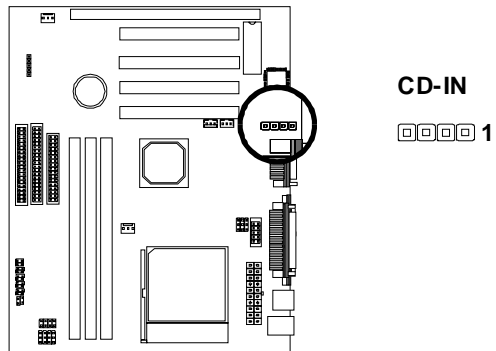

Installing the Memory Modules (DIMM)

- This mainboard has three sockets available for **168-pin DIMMs**. They can be 3.3 volt Unbuffered Synchronous DRAMs (SDRAM), 3.3 volt FPG or EDO DRAMs.
 - *To ensure reliability, it is recommended to use **PC100 SDRAM** for your 100MHz clocked SDRAM performance requirement.*
 - *Via Apollo MVP4 chipset does not support Register DIMMs.*
- DIMM Sizes supported: **8MB, 16MB, 32MB, 64MB, 128MB** and **256MB**
- A total of **(3)** DIMMs can be installed for a maximum RAM capacity of **768MB**.

To insert the DIMMs, the modules must be oriented in the correct way. Notice the notches of the DIMM. Align these notches as shown in the diagram below. Gently push the DIMM until the retainers on both sides of the socket lock the module in place. To remove a DIMM, push the retainers outwards to release the module then pull the module out of the socket.

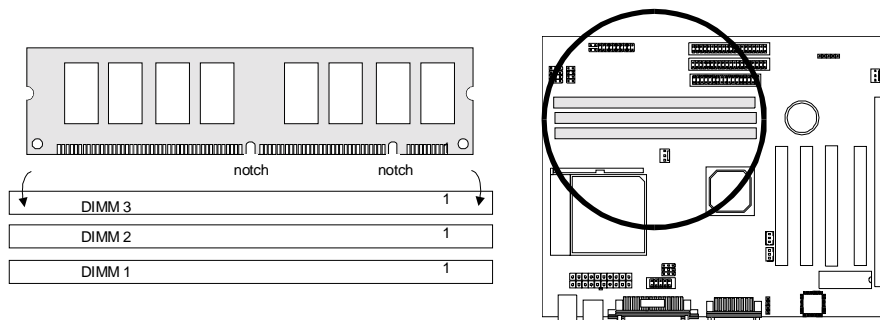

Installing the Support Drivers and Utilities

Included in your mainboard package you can find a CD-ROM containing support drivers and utilities. Just insert the CD-ROM, and from the Autorun screen, click the driver/utility that you want to install. Follow the on-screen instructions to complete the installation.



* The screen may look different under different color mode.

More utilities can be found under the "Utilities" folder of the CD-ROM.

Special Note on the Onboard Audio Features

Using the Onboard Audio Features

To use the on-chip direct sound AC97 audio support, make sure that the “*OnChip Sound*” option in **Chipset Features Setup** of the BIOS is enabled (default).

To use the on-chip legacy SoundBlaster-compatible audio support, make sure that the “*Onboard Legacy Audio*” options in **Integrated Peripherals Setup** of the BIOS is set according to your system configuration *before driver installation*.

For Windows NT 4.0

Ensure Windows NT4.0 is up and running properly. Install the audio drivers *before Service Pack 4*. If Service Pack 4 is installed before the audio drivers, you may not see peripheral devices including the CD-ROM drive due to Service Pack 4 problem.

INSTALLATION

Special Note on VIA MVP4 and VGA Drivers

Before installing the AGP VGA drivers under Windows 95/98, specific software support must be included in your system first:

Windows 95

- A. Though Windows 95 OSR2.0 supports AGP, it is necessary that you first *upgrade OSR2.0 to OSR2.1 with a USB upgrade* to take full advantage of the AGP features.
- B. To access the advanced 3D features in Windows 95, you also need to first *install the Microsoft DirectX 5.0*.
- C. Then install the following VIA drivers found in the supplied CD-ROM:
 - 1) VIA PCI Bridge driver.
 - 2) VIA Bus Master driver.
 - 3) VIA VxD driver.

Make sure all the above are included in your system before you install the display driver.

Windows 98

Install VIA VxD driver found in the supplied CD-ROM before you install the display driver.

SOFTWARE SUPPORT

For detailed information, please refer to the **BIOS, Driver & Utility Guide** included in your mainboard package.

Mainboard BIOS

Shortly after the system is powered on, provided that the system is properly setup, you will see the message:

Press DEL to enter SETUP

- Press the **DEL** key to enter the Award BIOS Setup program.

The Main Menu will appear on the screen. Use the **arrow keys** to select among the items and press **<Enter>** to accept and enter the sub-menu.

ROM PCI/ISA BIOS (xxxxxxxx)
CMOS SETUP UTILITY
AWARD SOFTWARE, INC.

STANDARD CMOS SETUP	INTEGRATED PERIPHERALS
BIOS FEATURES SETUP	SUPERVISOR PASSWORD
CHIPSET FEATURES SETUP	USER PASSWORD
POWER MANAGEMENT SETUP	IDE HDD AUTO DETECTION
PNP / PCI CONFIGURATION	SAVE & EXIT SETUP
LOAD BIOS DEFAULTS	EXIT WITHOUT SAVING
LOAD SETUP DEFAULTS	
Esc : Quit	↑ ↓ → ← : Select Item
F10 : Save & Exit Setup	(Shift) F2 : Change Color

Select **LOAD SETUP DEFAULTS** for optimum system performance.

Flash BIOS Programming Utility

Since this mainboard features FLASH BIOS, the user can simply re-program the old BIOS using the AWDFLASH Utility (found under “Utilities” folder of the supplied CD-ROM) as follows:

1. First, boot the system with DOS or to “Safe Mode” under Windows 95. *This is the only correct way to run the AWDFLASH Utility program.*
2. Make sure the files “AWDFLASH.EXE” and the updated “BIN” file (which contains the actual BIOS code) are in the same directory.
3. Changing to the directory where the two required files exist, type: AWDFLASH and press [ENTER]. The AWDFLASH Utility Screen appears:

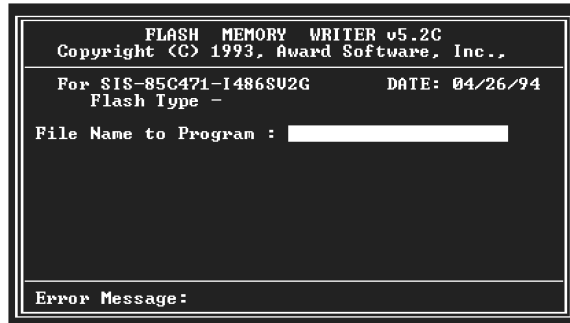

4. Type in the name of the new BIOS (.bin) file and hit [ENTER].
5. Backup the old BIOS by entering the name of the new backup file (such as “backup.bin”) and press [ENTER].
6. To begin programming, hit “y”. The Utility can be aborted at this time by hitting “n”.
7. A bar indicator will show the progress of the programming operation. After successful completion, hit the reset button or power off the computer.

Be sure to perform “**LOAD SETUP DEFAULTS**” for your new BIOS to synchronize the previous BIOS with the updated BIOS.

Symbios SCSI Configuration Utility

This mainboard features built-in Symbios SCSI BIOS. The **Symbios SCSI Configuration Utility** is a menu driven utility that allows you to view and change the default configuration settings for host adapters using Symbios 53C8XX chips.

In most cases you should not need to change the default configuration of your host adapter. You may decide to alter these default values if there is a conflict between device settings, or if you need to optimize system performance. A message appears on your computer monitor (for about 5 seconds) during boot that looks like this:

Press Ctrl-C to start Symbios Configuration Utility

If you decide to press Ctrl-C during boot, the following message appears:

Please wait, invoking Symbios Configuration Utility ...

After a brief pause, your computer will display the Main Menu of the utility.

Note: Pressing **Ctrl-A** after memory count during re-boot allows you to recover the default settings and reconfigure.

DMI Utility

This mainboard supports the **Desktop Management Interface (DMI)**, which is a new method of providing enterprise management for personal computers. The main component of DMI is the Management Information Format Database (MIF), which contains information about the computer system and its components, such as BIOS version/vendor, CPU speed/type, memory size/type, L1/L2 cache, port connectors (IDE, floppy, 2S/1P, USB, keyboard, mouse,), slots ... etc. Using DMI, remote PC management software is able to obtain various information about the system, including hardware profiles, capabilities, operational status, installation dates, and other information about the system and its components.

This DMI utility, DMICFG.EXE (found under "Utilities" folder of the supplied CD-ROM), allows you to add additional information, such as serial numbers, vendor information, and enclosure/chassis configurations, into the MIF.

FCC & DoC Compliance Statement

This device complies with Part 15 of the FCC rules, operation is subject to the following two conditions.

1. This device may not cause harmful interference and,
2. This device must accept any interference received, including interference that may cause undesired operation.

This equipment has been tested and found to comply with limits for a Class B digital device, pursuant to Part 15 of the FCC rules. These limits are designed to provide reasonable protection against harmful interference in residential installations. This equipment generates, uses, and can radiate radio frequency energy, and if not installed and used in accordance with the instructions, may cause harmful interface to radio communications. However, there is no guarantee that interference will not occur in a particular installation. If this equipment does cause interference to radio or television equipment reception, which can be determined by turning the equipment off and on, the user is encouraged to try to correct the interference by one or more of the following measures:

- Reorient or relocate the receiving antenna.
- Move the equipment away from the receiver.
- Plug the equipment into an outlet on a circuit different from that to which the receiver is connected.
- Consult the dealer or an experienced radio/television technician for additional suggestions.

The FCC requires the user to be notified that any change or modifications to the equipment by the user not expressly approved by the grantee or manufacturer could void the user's authority to operate such equipment. The use of shielded cables for connection of the monitor to the graphics card is required to assure compliance with FCC regulations.



27-0M0586-42

MAINBOARD

BIOS, Driver & Utility Guide

Rev: 1.00S

Date: March - 99

- * All other product names are trademarks or copyrights of their respective owners.
- * Specifications and information contained in this manual are subject to change without notice.

Table of Contents

MAINBOARD BIOS SETUP	3
About the BIOS	3
Main Menu	5
Standard CMOS Setup.....	6
BIOS Features Setup.....	10
Chipset Features Setup.....	14
Power Management Setup	17
PNP/PCI Configuration Setup	20
Load BIOS Defaults	22
Load Setup Defaults	22
Integrated Peripherals Setup	23
Supervisor Password and User Password Setting	26
IDE HDD Auto Detection.....	27
Save & Exit Setup / Exit Without Saving	27
PCI Device Listing	28
BUILT-IN SYMBIOS SCSI BIOS.....	29
FLASH BIOS PROGRAMMING UTILITY	36
DMI UTILITY.....	38

MAINBOARD BIOS SETUP

About the BIOS

The Mainboard BIOS (Basic Input/Output System) acts as the bridge between your Hardware (CPU, Disk Drives, Video, etc.) and Operating System Software (Windows 95, OS/2 and so on...) The BIOS Setup (also called CMOS Setup) is where many hardware configuration options are set and stored. This configuration information will remain in the BIOS until it is changed, or cleared by removing the battery for a while then reinstalling it back.

CMOS (Complementary Metal Oxide Semiconductor) refers to the chip in which the BIOS information is stored.

This mainboard features Award BIOS, which provides an easy to use Setup program to aid in hardware configuration. In this section we will look at the various menus and options contained in the Award BIOS Setup Program. This mainboard also features a "Flash" BIOS. A Flash BIOS can be upgraded via software, thereby eliminating the need to actually replace the "BIOS Chip" on the mainboard. Procedures for updating the BIOS follow this section.

The Award BIOS installed in your computer system's ROM (Read Only Memory) is a custom version of an industry standard BIOS. This means that it supports Intel processor in a standard IBM-AT compatible input/output system.

Using Setup

In general, you use the arrow keys to highlight items, press <Enter> to select, use the PageUp and PageDown keys to change entries, press <F1> for help and press <Esc> to quit.

Getting Help

Pressing F1 will display a small help window that describes the appropriate keys to use and the possible selections for the highlighted item. To exit the Help Window press <Esc>.

A Final Note about Setup

Not all systems have the same Setup. While the basic look and function of the Setup program remains the same for all systems, individual motherboard and chipset combinations require custom configurations. For example, you may find that your Setup main menu has a different number of entries from the main menu displayed in this manual. These are simply features not supported (or not user configurable) on your system.

The final appearance of the Setup program also depends on the Original Equipment Manufacturer (OEM) who built your system. If your OEM has decided that certain items should only be available to their technicians, those items may very well be removed from the Setup program.

Main Menu

Shortly after the system is powered on, provided a CPU and sufficient RAM are installed, you will see the message:

Press DEL to enter SETUP

- Press the **DEL** key to enter the Award BIOS Setup program.

Once you enter the Award BIOS CMOS Setup Utility, the Main Menu will appear on the screen. The Main Menu allows you to select from several setup functions and two exit choices. Use the arrow keys to select among the items and press <Enter> to accept and enter the sub-menu.

ROM PCI/ISA BIOS (xxxxxxxx)
CMOS SETUP UTILITY
AWARD SOFTWARE, INC.

STANDARD CMOS SETUP	INTEGRATED PERIPHERALS
BIOS FEATURES SETUP	SUPERVISOR PASSWORD
CHIPSET FEATURES SETUP	USER PASSWORD
POWER MANAGEMENT SETUP	IDE HDD AUTO DETECTION
PNP / PCI CONFIGURATION	SAVE & EXIT SETUP
LOAD BIOS DEFAULTS	EXIT WITHOUT SAVING
LOAD SETUP DEFAULTS	
Esc : Quit	↑ ↓ → ← : Select Item
F10 : Save & Exit Setup	(Shift) F2 : Change Color

Note that a brief description of each highlighted selection appears at the bottom of the screen.

Standard CMOS Setup

This first menu is where the most basic hardware options are set. Information regarding the system clock, IDE hard disks and floppy drives is stored and configured in this section. To enter the Standard CMOS Setup, press the [ENTER] key with this menu highlighted.

Upon entering the Standard CMOS Setup screen, you will see a screen like that below:

Date (mm:dd:yy) : Sat, Dec 18 1999									
Time (hh:mm:ss) : 00:00:00									
HARD DISKS	TYPE	SIZE	CYLS	HEAD	PRECOMP	LANDZ	SECTOR	MODE	
Primary Master	: Auto	0	0	0	0	0	0	Auto	
Primary Slave	: Auto	0	0	0	0	0	0	Auto	
Secondary Master	: Auto	0	0	0	0	0	0	Auto	
Secondary Slave	: Auto	0	0	0	0	0	0	Auto	
Drive A : 1.44M , 3.5in.									
Drive B : None									
Floppy 3 Mode Support: Disabled									
Video : EGA / VGA					Base Memory : 640K				
Halt On : All Errors					Extended Memory : 15360K				
					Other Memory : 384K				
					Total Memory : 16384K				
ESC : Quit			↑ ↓ → ← : Select Item			PU / PD / + / - : Modify			
F1 : Help			(Shift) F2 : Change Color						

First, let's set the system **Date**. Use the arrow keys to move to and highlight the "Date" option. Select the Month by using the PgDn and PgUp keys. This is how most settings will be configured. Then, move to the day, year and time via the arrow keys to finish setting the system date and time.

Keep in mind that the system time is set in 24-hour time. With this method, 1PM is represented as 13:00, 2PM as 14:00 and so on, with 00:00 corresponding to Midnight.

Pri Master, Pri Slave, Sec Master, Sec Slave - These four options relate to the (4) IDE hard drives, CD-ROMs or other ATAPI devices that can be controlled via the on-board IDE controller (review IDE Hard Drives and CD-ROMs in the Installation Guide). The "Pri Master" setting specifies the first device on the primary IDE

channel, "Pri Slave" - the second. Sec Master and Sec Slave specify the devices on the secondary channel.

The first option available is the most important: **Type**. This is where you will specify the type of device and how it is represented in the BIOS Setup. If the device is a hard disk or CD-ROM, generally the Auto option is the best choice for fast and easy setup of the hard disk parameters. Let's take a look at the difference between the Auto, User and Types (1-45) options:

- **Auto** - This option instructs the BIOS to automatically configure the hard disk by reading the parameters (cylinders, sectors, etc.) directly from the hard disk's firmware. Use this option if you are configuring a new hard drive, or one that has already been formatted using the *Auto* option. Keep in mind that a hard drive is configured using a certain set of parameters, those same parameters must be used for the life of the drive, unless the drive is re-FDISKed using a different parameter set. (This procedure deletes the old partition(s) on the drive and creates a new one, using the new parameters).
- **User** - This option allows you to manually enter in the parameters of the hard drive. Generally, this option would be used only if the hard drive has already been formatted with a certain set of parameters, and assured consistency between the old and new parameters is desired.

TYPE	drive type
CYLS.	number of cylinders
HEADS	number of heads
PRECOMP	write precom
LANDZONE	landing zone
SECTORS	number of sectors
MODE	mode type
- **Types 1-45** - Similar to the *User* option, these types should only be used if the exact parameters for the hard drive are already entered as a specific type stored in the Setup Program. Again, this would only be needed to assure that the parameters the drive was formatted with and those it is using now, are identical. For new hard drives, the *Auto* option is the preferred choice.

Mode - One of Enhanced IDE's most important features is LBA (Logical Block Addressing) Mode. This feature allows the use of larger hard drives by providing a way to bypass the cylinder limitations imposed by many Operating Systems. LBA Mode is used to extend a hard drive's useable capacity by "remapping" the cylinders in a way that is acceptable to these operating systems. For instance, a hard drive with the parameters of 2100 Cylinders, 16 Heads and 63 Sectors would be represented by LBA Mode as 525 Cylinders, 64 Heads and 63 Sectors. (Notice that the Cylinders have been divided, and the Heads have been multiplied, by a factor of 4.)

MAINBOARD BIOS SETUP

On hard drives smaller in capacity than 528MB, LBA support is not needed. The option on these devices is ignored, even if enabled. For hard drives greater than 528MB, LBA mode should be enabled. The following rules apply:

- Operating Systems that do not use the FAT file system do not need LBA Mode, and can use the Normal or Large Modes. Examples would be NetWare and Unix.
- When configuring a new hard drive greater than 528MB in capacity, always make sure LBA mode is enabled.
- If you are using a hard drive that is over 528MB in capacity, but was already formatted without using LBA mode, LBA support will be ignored even if it is enabled. This assures correct access to the drive's data.
- **SCSI Hard Drives** are NOT entered into the Mainboard BIOS Setup in any way. The hard drive settings in the Standard CMOS Setup are only for drives connected to the IDE Controller. So, if only SCSI drives were installed, all these settings would be set to **Type: None**. SCSI Devices are configured via the SCSI controller's BIOS.

Floppy Drives A: and B: - Select the Type for the A: and/or B: floppy drives. Remember, floppy drive A: is the first drive, hooked to the END of the floppy ribbon cable. Floppy drive B: is hooked up after the twist. Available settings are listed below:

None	No floppy drive installed
360K, 5.25 in	5-1/4 inch PC-type standard drive; 360 kilobyte capacity
1.2M, 5.25 in	5-1/4 inch AT-type high-density drive; 1.2 megabyte capacity
720K, 3.5 in	3-1/2 inch double-sided drive; 720 kilobyte capacity
1.44M, 3.5 in	3-1/2 inch double-sided drive; 1.44 megabyte capacity
2.88M, 3.5 in	3-1/2 inch double-sided drive; 2.88 megabyte capacity

Floppy 3 Mode Support: - Enable this option **ONLY** for floppy drive(s) that support the Japanese standard (1.2MB on 3.5" Diskette). Options: Disabled (Default), Both, Drive A / B.

Video - This category selects the type of video adapter used for the primary system monitor. Although secondary monitors are supported, you do not have to select their type in Setup.

EGA/VGA	Enhanced Graphics Adapter/Video Graphics Array. For EGA, VGA, SEGA, SVGA or PGA monitor adapters.
CGA 40	Color Graphics Adapter, power up in 40 column mode
CGA 80	Color Graphics Adapter, power up in 80 column mode
MONO	Monochrome adapter, includes high resolution monochrome adapters

Halt On - Determines whether or not the system will prompt you if an error is detected during POST.

All Errors	Whenever the BIOS detects a non-fatal error the system will be stopped and you will be prompted.
No Errors	The system boot will not be stopped for any error that may be detected.
All, But Keyboard	The system boot will not stop for a keyboard error; it will stop for all other errors.
All, But Diskette	The system boot will not stop for a disk error; it will stop for all other errors.
All, But Disk/Key	The system boot will not stop for a keyboard or disk error; it will stop for all other errors.

Memory - This category is display-only. All memory detected by the POST (Power On Self Test) of the BIOS is shown as the following types:

Base Memory is the amount of conventional memory installed in the system. This value is typically 640K for systems with 640K or more memory installed on the motherboard. The **Extended Memory** is the amount of memory located above 1MB in the CPU's memory address map. **Other Memory** refers to the memory located in the region between 640K and 1MB. This region can be used for *shadowing* as well as *expanded memory* in DOS.

BIOS Features Setup

This menu provides access to more advanced BIOS configuration settings that deal with overall performance of the system and peripheral setup. This section allows you to configure your system for basic operation. You have the opportunity to select the system's default speed, boot-up sequence, keyboard operation, shadowing and security.

Anti-Virus Protection	: Enabled	Video BIOS Shadow	: Enabled
CPU Internal Cache	: Enabled	C8000-CBFFF Shadow	: Disabled
External Cache	: Enabled	CC000-CFFFF Shadow	: Disabled
Quick Power On Self Test	: Disabled	D0000-D3FFF Shadow	: Disabled
Hard Disk Boot From	: Pri-IDE-M	D4000-D7FFF Shadow	: Disabled
Boot Sequence	: C, A	D8000-DBFFF Shadow	: Disabled
Swap Floppy Drive	: Disabled	DC000-DFFFF Shadow	: Disabled
Boot Up Floppy Seek	: Enabled		
Boot Up NumLock Status	: On		
Gate A20 Option	: Fast		
Memory Parity/ECC Check	: Disabled		
Typematic Rate Setting	: Disabled		
Typematic Rate (Chars/Sec)	: 6		
Typematic Delay (Msec)	: 250		
Security Option	: System		
PCI / VGA Palette Snoop	: Disabled	ESC : Quit	↑ ↓ → ← : Select Item
OS Select For DRAM > 64MB	: Non-OS2	F1 : Help	PU/PD/+/- : Modify
HDD S.M.A.R.T. Capability	: Disabled	F5 : Old Values	(Shift) F2 : Color
Report No FDD For WIN 95	: No	F6 : Load BIOS Defaults	
		F7 : Load Setup Defaults	

Anti-Virus Protection – Enables/Disables the built-in anti-virus for protection against **boot virus** infection. Unlike traditional BIOS protection which generally consists of simply write protecting the hard disk partition table, this Anti-Virus protection provides more complete virus protection by taking control early in the boot process, detecting boot viruses before they have a chance to load.

CPU Internal Cache - Enables or Disables the Level-1 Internal Cache memory. Generally, this would only be *Disabled* for troubleshooting purposes.

External Cache - Enables or Disables the Level-2 External Cache memory. Generally, this would only be *Disabled* for troubleshooting purposes.

Quick Power on Self Test - Speeds up Power On Self Test (POST) after the computer is powered on. When set to Enabled, the BIOS will shorten or skip some checks during POST.

Hard Disk Boot From - This option lets you choose to boot from Primary IDE Master (*Pri-IDE-M*), Primary IDE Slave (*Pri-IDE-S*), Secondary IDE Master (*Sec-IDE-M*), Secondary IDE Slave (*Sec-IDE-S*), or *SCSI* hard disk. Same as IDE options, the Boot Sequence in the next field is set to C, A when the *SCSI* is chosen.

Boot Sequence - When your system is powered on, the BIOS performs a variety of operations, then attempts to boot an Operating System from either a hard drive, floppy drive, CD-ROM or LS-120/ZIP. This setting determines the sequence that the BIOS will follow when searching devices for a bootable disk. Most users find the C, A setting to be most beneficial, since it takes the least amount of time to boot the system. If however, you want the ability to boot from a Floppy or CD-ROM drive, you would need to choose either the A, C or CDROM, C, A setting. For instance, if your boot sequence was set to C, A and for some reason you wanted to boot to your Floppy A: Drive, it would not be possible, since the BIOS would always boot from the C: drive first. In this case, this setting would need to be changed to A, C so that the system would first check the floppy drive for a bootable disk. This would slow bootup speed, however, since the floppy would be checked on every boot.

A,C	System will first search for boot sector on floppy disk, then hard disk.
C, A	System will first search hard disk drive then floppy disk drive for boot sector.
C, CDROM, A	System will first search for boot sector on hard disk drive , then CDROM drive, and then floppy disk drive.
CDROM, C, A	System will first search the CDROM drive, then hard disk drive and then floppy disk drive for boot sector.
C only	System will search for boot sector on hard disk drive only.
LS/ZIP, C	System will first search for boot sector on LS-120 IDE floppy drive or ZIP ATAPI drive, then hard disk.

Swap Floppy Drive - The hardware connections determine which floppy is configured as drive A: and drive B: “Swapping” the floppy drives can be useful if your system has two floppy drives, and you want the ability to boot from both. For example: Since a PC cannot boot from the B: Floppy, you would need to “Swap” floppy drives A: and B: in order to set the second floppy drive to drive A:, thereby making it bootable.

Boot Up Floppy Seek - When enabled, BIOS will attempt to move the head of the floppy disk drive forth and back once during POST to see if the drive is working properly.

MAINBOARD BIOS SETUP

Boot Up NumLock Status - When *On*, the NumLock key will be automatically enabled when the system boots.

Gate A20 Option - This entry allows you to select how the gate A20 is handled. The gate A20 is a device used to address memory above 1 Mbytes. Initially, the gate A20 was handled via a pin on the keyboard (Normal). Today, while keyboards still provide this support, it is more common, and much faster, for the system chipset (Fast; default) to provide support for gate A20.

Memory Parity/ECC Check - When *Disabled*, there will be no memory errors shown on the monitor for **Memory parity SERR# (NMI)**. When parity DRAM modules are used, select *Enabled* for Parity or ECC (Error Checking and Correcting) checking to correct 1 bit memory errors in the memory.

Typematic Rate Setting - Determines if the typematic rate is to be used. When disabled, continually holding down a key on your keyboard will generate only one instance. In other words, the BIOS will only report that the key is down. When the typematic rate is enabled, the BIOS will report as before, but it will then wait a moment, and, if the key is still down, it will begin to report that the key has been depressed repeatedly. This feature is used to accelerate cursor movements with the arrow keys.

Typematic Rate (Chars/Sec) - When the typematic rate is enabled, this selection allows you to select the rate at which the keys are accelerated: Options are 6 (default), 8, 10, 12, 15, 20, 24 and 30.

Typematic Delay (Msec) - When the typematic rate is enabled, this selection allows you to select the delay (in msec) between when the key was first depressed and when the acceleration begins. Options are 250 (default), 500, 750 and 1000.

Security Option - This option enables password checking every time the computer is powered on or every time BIOS Setup is executed. If *System* is chosen, a user password prompt appears every time the computer is turned on. If *Setup* is chosen, the password prompt appears only when the BIOS Setup program is executed. Refer to the section Supervisor Password for more information.

PCI / VGA Palette Snoop - This option must be set to *Enabled* if any ISA MPEG card installed requires VGA palette snooping.

OS Select For DRAM > 64MB - This should be set to *OS2* if you are running IBM OS/2 with more than 64MB of RAM in the system. Otherwise, the setting should be *Non-OS2*.

HDD S.M.A.R.T. Capability - The default is *Disabled*. If you are using hard drives that support S.M.A.R.T., set this field to *Enabled*. SMART (Self-Monitoring, Analysis and Reporting Technology) is a reliability prediction technology for ATA/IDE and SCSI drives. The drive will provide sufficient notice to the system or user to backup data prior to the drive's failure. SMART is supported in ATA-3 or later hard drives.

Report No FDD For WIN95 – When no floppy disk drive is installed, set this option to No to release IRQ6 for passing Win95 logo. This option is irrelevant under normal operation.

Video BIOS Shadow - This option controls the location of the contents of the 32KB of Video ROM beginning at the C0000h memory location. The settings are:

Enabled	The contents of C0000h-C7FFFh are written to the same address in system memory (RAM) for faster execution.
Disabled	The video ROM is not copied to RAM. The contents of the video ROM cannot be read from or written to cache memory.

C8000-DFFFF Shadow - These options control the location of the contents of the 16KB expansion card ROMs beginning at the specified memory location. If no adapter ROM is using the named ROM area, this area is made available to the local bus. Shadowing a ROM reduces the memory available between 640KB and 1024KB by the amount used for this purpose.

Chipset Features Setup

This setup menu contains advanced configuration options relating to the mainboard chipset. These options are rarely changed by the user.

Bank 0/1 DRAM Timing	: SDRAM 10ns	Auto Detect DIMM/PCI Clk	: Enabled
Bank 2/3 DRAM Timing	: SDRAM 10ns	Spread Spectrum	: Disabled
Bank 4/5 DRAM Timing	: SDRAM 10ns		
SDRAM Cycle Length	: 3	Current CPU Temp.	: 47°C/116°F
DRAM Read Pipeline	: Disabled	Current System Temp.	: 47°C/116°F
Sustained 3T Write	: Enabled	Current CPUFAN1 Speed	: 5400 RPM
Cache R/CPU W Pipeline	: Enabled	Current CPUFAN2 Speed	: 0 RPM
Cache Timing	: Fast	Vcore	: 2.81V 2.5V : 2.81V
Video BIOS Cacheable	: Enabled	3.3V	: 3.36V 5V : 5.14V
System BIOS Cacheable	: Enabled	12V	: 12.16V
Memory Hole	: Disabled		
Init Display First	: PCI Slot		
Frame Buffer Size	: 8M		
AGP Aperture Size	: 64M		
AGP-2X Mode	: Disabled		
OnChip USB	: Enabled	ESC : Quit	↑ ↓ → ← : Select Item
USB Keyboard Support	: Disabled	F1 : Help	PU/PD/+/- : Modify
OnChip Sound	: Enabled	F5 : Old Values	(Shift) F2 : Color
		F6 : Load BIOS Defaults	
		F7 : Load Setup Defaults	

Bank 0/1, 2/3, 4/5 DRAM Timing – DRAM timing is controlled by the DRAM timing registers. The timings programmed into this register are dependent on the system design. The slower timing may be required in certain system designs to support loose layouts or slower memory.

SDRAM Cycle Length - When synchronous DRAM is installed, the number of clock cycles of CAS latency depends on the DRAM timing. Do not reset this field from the default value specified by the system designer.

Options are 2, 3 (default).

DRAM Read Pipeline - This item allows you to enable/disable the DRAM read pipeline. Pipelining improves system performance.

Sustained 3T Write – This item allows you to enable or disable direct map write back / write through secondary cache.

Cache R/CPU W Pipeline - This item allows you to enable/disable the cache read and CPU write pipeline.

Cache Timing - This item determines the cache timing. Options are Fast (default) and Fastest.

Video BIOS Cacheable - When *Enabled*, the Video BIOS cacheable will cause access to the video BIOS addressed at C0000H to C7FFFH to be cached. **Enabled* is the default.

System BIOS Cacheable - When enabled, accesses to the system BIOS ROM addressed at F0000H-FFFFFH are cached, provided that the cache controller is enabled.

Memory Hole - In order to improve compatibility, certain space in memory can be reserved for old style ISA cards that map memory between 15M-16M. Do not select the *15M-16M* option unless you use the old style ISA card, otherwise the memory size may be reduced to 15 MB for some O.S.

Init Display First - If you have a PCI display adapter installed, this item allows you to decide whether to activate the PCI first or the on-chip AGP graphics support.

Frame Buffer Size - Determines the size of the frame buffer in the system memory. A frame buffer is used to hold a frame of data for screen display and is the size of the maximum image area on screen.

AGP Aperture Size (MB) - Select the size of the Accelerated Graphics Port (AGP) aperture. The aperture is a portion of the PCI memory address range dedicated for graphics memory address space. Host cycles that hit the aperture range are forwarded to the AGP without any translation. See www.agpforum.org for AGP information.

AGP-2X Mode - Set to *Enabled* if your AGP card supports the 2X mode, which uses a double-clocked data technique to transfer twice the data per each AGP clock.

OnChip USB - If your system contains a Universal Serial Bus peripheral, select *Enabled*. The next option will become available:

USB Keyboard Support - Select *Enabled* if your system contains a Universal Serial Bus (USB) controller and you have a USB keyboard.

OnChip Sound - Enabling this option allows the system to use the on-chip AC97 audio support. If you want to use the Sound Blaster compatible mode or an add-on audio card instead, set this option to *Disabled* to avoid possible conflict.

Auto Detect DIMM/PCI Clk - When *enabled*, any DIMM/PCI clock not in use will be disabled to reduce EMI radiation.

MAINBOARD BIOS SETUP

Spread Spectrum – The default is the optimal value determined by the system designer to reduce EMI radiation peak. Users should not attempt to change it.

Hardware Monitoring -

The on-chip hardware monitoring functions allow you to observe the current temperatures of the CPU and the system, current speeds (in RPM, rotation per minute) of the system and CPU fans, as well as the various operating voltages. (If the fan is not installed, 0 RPM will be shown.)

Power Management Setup

This menu contains configuration options that reduce power consumption when the system is not in use. Other “Green-PC” compliant peripherals are also supported. Power Management allows you to configure you system to use energy most efficiently, and still in a manner consistent with your own style of computer use.

ACPI function	: Enabled	Primary INTR	: ON
Power Management	: User Define	IRQ3 (COM 2)	: Primary
PM Control by APM	: Yes	IRQ4 (COM 1)	: Primary
Video Off Method	: DPMS Support	IRQ5 (LPT 2)	: Primary
Video Off After	: Suspend	IRQ6 (FDD)	: Primary
MODEM Use IRQ	: 3	IRQ7 (LPT 1)	: Primary
Doze Mode	: Disabled	IRQ8 (Alarm)	: Disabled
Suspend Mode	: Disabled	IRQ9 (RSV)	: Secondary
HDD Power Down	: Disabled	IRQ10 (RSV)	: Secondary
Soft-Off by PWRBTN	: Instant-Off	IRQ11 (RSV)	: Secondary
PWRON After PW-Fail	: Off	IRQ12 (PS/2)	: Primary
** PM Events **		IRQ13 (Copro)	: Primary
VGA	: OFF	IRQ14 (HDD)	: Primary
LPT & COM	: LPT/COM	IRQ15 (RSV)	: Disabled
HDD & FDD	: ON	ESC : Quit ↑ ↓ → ← : Select Item	
DMA/master	: OFF	F1 : Help	PU/PD/+/- : Modify
Power On by RTC Alarm	: Disabled	F5 : Old Values (Shift)	F2 : Color
		F6 : Load BIOS Defaults	
Power On by Ring/LAN	: Disabled	F7 : Load Setup Defaults	

ACPI Function – This option allows you to enable/disable the Advanced Configuration and Power Interface which offers improved power management.

Power Management – This category allows you to select the type (or degree) of power saving and is directly related to the following modes: Doze Mode, Suspend Mode and HDD Power Down:

Min Saving	Minimum power management. Doze Mode = 1 hr., Suspend Mode = 1 hr.
Max Saving	Maximum power management – ONLY AVAILABLE FOR SL CPUs. Doze Mode = 1 min., Suspend Mode = 1 min.
User Define	Set each mode individually. When selected, each range is from 1 min. to 1 hr., except for HDD Power Down which ranges from 1 min. to 15 min.

MAINBOARD BIOS SETUP

PM Control by APM – When set to *Yes*, an **Advanced Power Management** device will be activated to enhance the Max. Power Saving mode and stop the CPU internal clock.

Video Off Method – This determines the manner in which the monitor is blanked.

V/H SYNC+Blank	This selection will cause the system to turn off the vertical and horizontal synchronization ports, writing blanks to the video buffer.
Blank Screen	This option only writes blanks to the video buffer.
DPMS Support	Initial display power management signaling.

Video Off After – This option determines how the monitor operates in a power saving mode.

NA	Monitor will remain on during power saving modes.
Suspend	Monitor blanked when the systems enters the Suspend mode.
Doze	Monitor blanked when the system enters the Dose mode.

MODEM Use IRQ – This option forces the installed MODEM to use the specified IRQ so that the Power Management BIOS can use this information. Options are NA, 3, 4, 5, 7, 9, 10, and 11.

The following three modes are Green PC power saving functions. **Doze Mode** and **Suspend Mode** are only user configurable when *User Define* Power Management has been selected. See below for available selections:

Doze Mode	When enabled and after the set time of system inactivity, the CPU clock will run at slower speed while all other devices still operate at full speed.
Suspend Mode	When enabled and after the set time of system inactivity, all devices except the CPU will be shut off.
HDD Power Down	When enabled and after the set time of system inactivity, the hard disk drive will be powered down while all other devices remain active.

Soft-Off by PWRBTN – With *Instant-Off* selected, the ATX switch functions like a normal system power off button. With *Delay 4 Sec.* selected, you must hold down the ATX switch for more than 4 seconds to power off the system.

PWRON After PW-Fail – This feature can power on the PC when power returns after a power failure. The table below lists the options available and the corresponding “System State” when power returns after a power failure.

Options Available	System State When Power Failure Occurred	System State When Power Returns
Former-State	On	On
	Off	Off
Off	On	Off
	Off	Off
On	On	On
	Off	On

****PM Events****

VGA - When set to *On*, any event occurring at a VGA port will awaken a system which has been powered down.

LPT & COM - Any event occurring at the specified port(s) will awaken a system which has been powered down.

HDD & FDD - When set to *On*, any event occurring at a hard or floppy drive port will awaken a system which has been powered down

DMA/master - When set to *On*, any event occurring to the DMA controller will awaken a system which has been powered down.

Power on by RTC Alarm - When *enabled*, the system will automatically power on or returns to full power out of suspend mode at the time and date of the month (0 for daily) specified.

Power on by Ring/LAN – An input signal on the serial Ring Indicator (RI) line in other words, an incoming call on the modem (either external modem or internal modem card) power on the system. Refer to “Wake-on-Ring Function” in the Installation Guide for more information. With a LAN card installed, the Wake-up On LAN function allows the network to wake up a Soft Power Down (Soft-Off) PC. Refer to “Wake-up On LAN Connector” in the Installation Guide for more information.

Primary INTR - When set to *On* (default), any primary interrupt request (see below) will awake the system which has been powered down.

Following this option is a list of IRQs (Interrupt **Re**quests). You can set each IRQ to be *Primary*, *Secondary* or *Disabled*. When set to *Secondary*, the interrupt request will neither prevent the system from going into a power management mode nor awaken it.

PNP/PCI Configuration Setup

The PCI **P**ersonal **C**omponent **I**nterconnect **B**us was developed to address two important issues: a) How to allow peripheral devices to take the fullest advantage of the power of Pentium and Pentium Pro chip technology, and b) Provide a simpler installation process for peripheral devices, such as Network cards, EIDE or SCSI controllers.

PCI accomplishes these goals with its 32-bit Data path Local Bus design, and support for Plug & Play. Unlike older expansion bus architectures, PCI provides peripherals with a direct connection to the CPU and memory. The PCI bus runs at 33Mhz and has a maximum transfer capability of 132MBps. With Plug & Play, the system BIOS automatically determines hardware resources for new peripherals, simplifying installation of multiple interface cards.

This Setup Menu provides configuration options for the PCI Bus and its assigned resources.

PNP OS Installed	:	No	CPU to PCI Write Buffer	:	Enabled
Resources Controlled by	:	Manual	PCI Dynamic Bursting	:	Enabled
Reset Configuration Data	:	Enabled	PCI Master 0 WS Write	:	Enabled
IRQ-3 assigned to	:	PCI/ISA PnP	PCI Delay Transaction	:	Enabled
IRQ-4 assigned to	:	PCI/ISA PnP	PCI#2 Access #1 Retry	:	Disabled
IRQ-5 assigned to	:	PCI/ISA PnP	AGP Master 1 WS Write	:	Enabled
IRQ-7 assigned to	:	PCI/ISA PnP	AGP Master 1 WS Read	:	Disabled
IRQ-9 assigned to	:	PCI/ISA PnP	SYMBIOS SCSI BIOS	:	Auto
IRQ-10 assigned to	:	PCI/ISA PnP	Assign IRQ For USB	:	Enabled
IRQ-11 assigned to	:	PCI/ISA PnP	Assign IRQ For VGA	:	Enabled
IRQ-12 assigned to	:	PCI/ISA PnP			
IRQ-14 assigned to	:	PCI/ISA PnP			
IRQ-15 assigned to	:	PCI/ISA PnP			
DMA-0 assigned to	:	PCI/ISA PnP			
DMA-1 assigned to	:	PCI/ISA PnP	ESC : Quit	↑ ↓ → ← :	Select Item
DMA-3 assigned to	:	PCI/ISA PnP	F1 : Help	PU/PD/+/- :	Modify
DMA-5 assigned to	:	PCI/ISA PnP	F5 : Old Values (Shift)	F2 :	Color
DMA-6 assigned to	:	PCI/ISA PnP	F6 : Load BIOS Defaults		
DMA-7 assigned to	:	PCI/ISA PnP	F7 : Load Setup Defaults		

PNP OS Installed - Set to Yes if your operating system supports Plug & Play, such as Windows® 95.

Resources Controlled By - The Award Plug and Play BIOS has the capacity to automatically configure all of the boot and Plug and Play compatible devices. This

capability is specifically designed for a Plug and Play operating system such as Windows® 95. Choices are *Auto* and *Manual*.

Reset Configuration Data - Reset Configuration Data: When set to Enabled, ESCD (Extended System Configuration Data) is cleared. This setting will automatically be set back to Disabled when the system reboots.

IRQ3/4/5/7/9/10/11/12/14/15, DMA0/1/3/5/6/7 assigned to – These options are available when the above **Resources Controlled by** option is set to *Manual*. By default, all resources are assigned to the PCI Bus. If an ISA card requires a particular IRQ or DMA channel, that resource should be set to Legacy ISA so that the PCI Bus will not try to use them.

CPU to PCI Write Buffer - When this field is *Enabled*, writes from the CPU to the PCI bus are buffered to compensate for the speed differences between the CPU and the PCI bus. When *Disabled*, the writes are not buffered and the CPU must wait until the write is complete before starting another write cycle.

PCI Dynamic Bursting - When Enabled, data transfers on the PCI bus, where possible, make use of the high-performance PCI burst protocol, in which greater amounts of data are transferred at a single command.

PCI Master 0 WS Write - When *Enabled*, writes to the PCI bus are executed with zero wait states.

PCI Delay Transaction - The chipset has an embedded 32-bit posted write buffer to support delay transactions cycles. Select *Enabled* to support compliance with PCI specification version 2.1.

PCI#2 Access #1 Retry - This item allows you enable/disable the PCI #2 Access #1 Retry when PCI#2 (AGP bus) access to PCI#1 (PCI bus) has a error occurred.

AGP Master 1 WS Write - When *Enabled*, writes to the AGP (Accelerated Graphics Port) are executed with one wait state. When *Disabled*, two wait states are used by the system, allows for greater stability.

AGP Master 1 WS Read - When *Enabled*, reads to the AGP (Accelerated Graphics Port) are executed with one wait state. When *Disabled*, two wait states are used by the system, allows for greater stability.

SYMBIOS SCSI BIOS - When set to *Auto*, the system will automatically sense the presence of any SCSI adapter that uses a Symbios SYM53C8XX SCSI chip:

MAINBOARD BIOS SETUP

If the SCSI adapter installed has its own BIOS on board:	The on-board SCSI BIOS will not be loaded. The adapter's own SCSI BIOS will be used.
If the SCSI adapter installed doesn't have its own BIOS and the card uses or is compatible with the SYM53C8XX chip:	The on-board SCSI BIOS will load and control the SCSI adapter.

* Disabling the onboard SCSI BIOS prevents it from being active in any way.

Assign IRQ For USB - When *Enabled*, the system automatically assigns an IRQ for the USB device connected to your system. However, if no USB devices are used and an ISA slot requires an IRQ address, set this function to *Disabled*. The IRQ address previously occupied by the USB device will be available for the ISA slot.

Assign IRQ For VGA - The *Enabled* option allows the BIOS to auto-route an IRQ for use by a VGA card. While most of the VGA cards do not need the IRQ assignment, certain VGA cards may need it.

Load BIOS Defaults

Loads "Fail Safe" settings into the BIOS Setup program. These options are designed to slow the system down for troubleshooting purposes. To load the default values, highlight this option and press [ENTER]. Enter "Y" in the confirmation screen and press [ENTER] again. User-defined options in the **Standard CMOS Setup** are not affected.

Load Setup Defaults

Loads the default values for best system performance into the BIOS Setup program. To load the default values, highlight this option and press [ENTER]. Enter "Y" in the confirmation screen and press [ENTER] again. User-defined options in the **Standard CMOS Setup** are not affected.

Integrated Peripherals Setup

This menu is used to configure the integrated IDE subsystem and other peripherals.

OnChip IDE Channel 0	: Enabled	Onboard Parallel Port	: 378/IRQ7
OnChip IDE Channel 1	: Enabled	Onboard Parallel Mode	: ECP/EPP
IDE Prefetch Mode	: Enabled	ECP Mode Use DMA	: 3
IDE HDD Block Mode	: Enabled	Parallel Port EPP Type	: EPP 1.9
Primary Master PIO	: Auto	Onboard Legacy Audio	: Enabled
Primary Slave PIO	: Auto	Sound Blaster	: Enabled
Secondary Master PIO	: Auto	SB I/O Base Address	: 220H
Secondary Slave PIO	: Auto	SB IRQ Select	: IRQ 5
Primary Master UDMA	: Auto	SB DMA Select	: DMA 1
Primary Slave UDMA	: Auto	MPU-401	: Enabled
Secondary Master UDMA	: Auto	MPU-401 I/O Base Address	: 330 -333H
Secondary Slave UDMA	: Auto	FM Port (388-38BH)	: Enabled
Onboard FDD Controller	: Enabled	Game Port (200-207H)	: Enabled
Onboard Serial Port 1	: Auto		
Onboard Serial Port 2	: Auto	ESC: Quit	↑ ↓ → ←: Select Item
IR/COM2 Mode Select	: UART COM2	F1 : Help	PU/PD/+/- : Modify
		F5 : Old Values	(Shift) F2: Color
		F6 : Load BIOS Defaults	
		F7 : Load Setup Defaults	

On-Chip IDE Channel 0 - Enables or Disables the primary controller. Situations where this controller would be disabled are: *a) You are not using any IDE Drives* or *b) You are using an add-on IDE controller in a PCI Slot.*

On-Chip IDE Channel 1 - Enables or Disables the secondary controller. Situations where this controller would be disabled are: *a) You are not using any IDE Drives* or *b) You are using IDE Drives ONLY on the primary controller* or *c) You are using an add-on IDE controller in a PCI Slot.*

IDE Prefetch Mode - Enable prefetching for IDE drive interfaces that support its faster drive accesses. If you are getting disk drive errors, change the setting to omit the drive interface where the errors occur. Depending on the configuration of your IDE subsystem, this field may not appear, and it does not appear when the Internal PCI/IDE field, above, is Disabled.

IDE HDD Block Mode - This allows your hard disk controller to use fast block mode to transfer multisector data to and from your hard disk drive (HDD).

MAINBOARD BIOS SETUP

- **IDE PIO Mode** - IDE Programmed I/O Mode - This setting relates to the speed at which the hard drive is able to transfer data, up to 16.6MB/second for Mode 4 drives. Available settings are *Auto*, 0, 1, 2, 3, or 4. As with the **Type** setting, *Auto* is the preferred choice, in that the supported PIO Mode is read directly from the hard drive. Be sure not to use a PIO Mode higher than what the drive actually supports. This could result in loss of data.

PIO Mode	Timing
0	600 ns
1	383 ns
2	240 ns
3	180 ns
4	120 ns

- **IDE UDMA (Ultra DMA) Mode** - The chipset used for this mainboard improves the IDE performance by implementing UltraDMA/33 Bus Mastering IDE which can handle data transfer up to 33 Mbyte/sec. This UDMA technology is downward compatible with existing ATA-2 IDE. So there is no upgrade required for current hard drives and cabling. **Auto* is default.

Onboard FDD Controller - Set to *Enabled* if you have a floppy disk drive installed on the system board and you wish to use it. Even when so equipped, if you add a higher performance controller, you will need to disable this feature.

Onboard Serial Port 1 - With this option, the on-board Serial Port 1 can be Disabled, or set to Auto, 3F8/IRQ4, 2F8/IRQ3, 3E8/IRQ4 or 2E8/IRQ3.

Onboard Serial Port 2 - With this option, the on-board Serial Port 2 can be Disabled, or set to Auto, 3F8/IRQ4, 2F8/IRQ3, 3E8/IRQ4 or 2E8/IRQ3.

IR/COM2 Mode Select - By default, this field is set to *UART COM2*, which directs the second serial port UART to support the COM2 serial port. Choosing *SHARP IR* (ASKIR) or *IrDA SIR* (HPSIR) will activate the on-board infrared feature and redirect the second serial port UART to support the infrared module connector on the mainboard.

Onboard Parallel Port - With this option, the on-board Parallel Port can be Disabled, or set to 378/IRQ7 (*Default), 3BC/IRQ7 or 278/IRQ5.

Onboard Parallel Mode - Sets the operating mode of the parallel port. Options are: *Normal*, *EPP* (Enhanced Parallel Port), *ECP* (Extended Capability Port), and *ECP/EPP* (default).

ECP Mode Use DMA - Options are 1 and 3. This field is available only when one of the two following options in **Onboard Parallel Mode** is selected: ECP or ECP/EPP.

Parallel Port EPP Type - Options are EPP1.7 and EPP1.9 (default ; IEEE 1284 compliant). This field is available only when one of the two following options in **Onboard Parallel Mode** is selected: EPP or ECP/EPP.

Onboard Legacy Audio – Enabling this option allows the system to use the on-chip legacy SoundBlaster-compatible audio support. If you want to use the on-chip AC97 audio support or an add-on audio card instead, set this option to *Disabled* to avoid possible conflict.

*** The following fields are available only when the **Onboard Legacy Audio** is *Enabled*.

Sound Blaster – Enables/Disables the Sound Blaster compatible mode.

SB I/O Base Address – This option allows the user to select the audio I/O base address in Sound Blaster compatible mode.

SB IRQ Select – This option allows the user to select the IRQ for audio in Sound Blaster compatible mode.

SB DMA Select – This option allows the user to select the DMA for audio in Sound Blaster compatible mode.

MPU-401 – Enables/Disables the MPU-401 MIDI interface standard.

MPU-401 I/O Base Address – This option allows the user to select the I/O base address for the use of MPU-401 MIDI device.

FM Port (388-38BH) – Enable this option to use the FM port, which occupies 388-38BH address.

Game Port (200-207H) – Enable this option to use the game port, which occupies 200-207H address.

Supervisor Password and User Password Setting

Passwords can be set to provide protection for the BIOS configuration options, or to restrict access to the computer itself.

When enabled, User Password will require all users to enter a password in order to use the system, and/or enter the BIOS setup (but can't change its contents). A Supervisor Password is used to protect the stored CMOS options from being changed by unauthorized users.

Keep in mind that when set, a password is required only when booting the system. It will not provide protection to a system that is already booted.

The password check option is set in **BIOS FEATURES SETUP** by choosing either System (the password prompt appears every time the system is powered on) or Setup (the password prompt appears only when the user enters the BIOS Setup). The password is stored in CMOS RAM, and can be cleared by removing the battery for a while and then re-installing it back.

To set a password:

1. You must first set the *Supervisor* password by choosing *Supervisor Password* and pressing [ENTER]. Setup prompts for a password.
2. Enter a 1-8 character password using letters, numbers, or a combination of both. The specific characters are not shown as you enter them. Press [ENTER].
3. A confirmation box appears asking you to re-enter the password. Enter the password again. Press [ENTER]. Follow the same procedure to set the *User Password*.

Changing a Password:

Select the appropriate password option (Supervisor or User) from the main menu and press [ENTER]. Enter the current password and press [Enter]. The screen does not display the characters entered. Enter in the new password, then the confirmation. You cannot change the current password unless you know it.

Erasing a Password:

1. If you know the current password, but want to disable password checking, follow the procedure for changing the password. When Setup prompts for the new password, simply press [ENTER]. You will see a message indicating that the password is disabled.
2. If you do not know the current password, the CMOS must be cleared by removing the battery for a while and then re-installing it back. *This will clear all user-defined BIOS Setup options.

IDE HDD Auto Detection

Automatically detect and configure hard disk parameters. The Award BIOS includes this ability in the event you are uncertain of your hard disk's parameters. See also "Standard CMOS Setup".

Save & Exit Setup / Exit Without Saving

Select *Save & Exit Setup* to save into the CMOS memory all modifications specified during the current session. To save the configuration changes, highlight this option in the main menu and press [ENTER]. The system displays a confirmation message on the screen. Press the "Y" key and then [Enter]. Press the "N" key and then the [Enter] key to abort. The *Exit Without Saving* option allows the user to exit the BIOS Setup without updating any changes made during the current session.

PCI Device Listing

This list of installed PCI devices appears after the **System Configuration** screen:

PCI device listing						
Bus No.	Device No.	Func No.	Vendor ID	Device ID	Device Class	IRQ
0	7	1	1106	0571	IDE Controller	14/15
0	7	2	8086	8829	Serial bus controller	11
0	9	0	1013	7333	Display controller	11

Bus No. Encoded value indicating 1 of 256 possible buses in a system.

Device No. Encoded value indicating 1 of 32 possible devices on a given bus.

Func No. Encoded value indicating 1 of 8 possible functions on a multifunction device.

Vendor ID Identifies the manufacturer of the device. Valid vendor identifiers are allocated by the PCI SIG (Special Interest Group) to ensure uniqueness.

Device ID Identifies the particular device. This identifier is allocated by the vendor.

Device Class Specifies one of the following device classes: Mass storage controller, Network controller, Display controller, Multimedia device, Bridge device, Simple communication controller, Base system peripherals, Input device, Docking station, Processor and Serial bus controller.

The PCI device listing is useful for troubleshooting purposes. More detailed information for each field may be obtained through the PCI specification documentation.

BUILT-IN SYMBIOS SCSI BIOS

To provide easy to use and cost effective support for adapters using or compatible with the Symbios Logic 53C8XX SCSI chips, this mainboard features built-in Symbios SCSI BIOS.

In most cases you should not need to change the default configuration of your host adapter. You may decide to alter these default values if there is a conflict between device settings, or if you need to optimize system performance. A message appears on your computer monitor (for about 5 seconds) during boot that looks like this:

Press Ctrl-C to start Symbios Configuration Utility

If you decide to press Ctrl-C during boot, the following message appears:

Please wait, invoking Symbios Configuration Utility ...

After a brief pause, your computer will display the Main Menu of the utility.

The Symbios SCSI Configuration Utility

This menu driven utility allows you to view and change the default configuration settings for host adapters using Symbios 53C8XX chips.

Note: Pressing **Ctrl-A** after memory count during re-boot allows you to recover the default settings and reconfigure.

The following tables list the configuration settings you can change:

- Global: Affects both the adapter and all SCSI devices
- Device: Affects only the individual SCSI devices

BUILT-IN SYMBIOS SCSI BIOS

Global Default Settings	
Settings	Default
SCAM Support	On
Parity Checking	Enabled
Host Adapter SCSI ID	7
Scan Order	Low to High (0-Max)

Device Default Settings	
Settings	Default
Synchronous Transfer Rate (MB/sec)	20
Data Width	8
Disconnect	On
Read Write I/O Timeout (secs)	10
Scan for Devices at Boot Time	Yes
Scan for SCSI LUNs	Yes
Queue Tags	Enabled

Main Menu

MAIN MENU					
	Port Num	Irq Level	-----Status-----		NvRAM Found
			Current	Next-Boot	
SYM53C860	FC00	9	On	On	Yes
SYM53C820	0	0	Off	Off	?
SYM53C825	FD00	9	On	On	Yes
SYM53C815	FE00	10	On	On	No
Change Adapter Status					
Adapter Boot Order					
Additional Adapter Configuration					
Display Mode = Verbose					
Mono/Color					
Language					
Help					
Quit					

You can select an adapter only if the current status is "On". **Changes are only possible with SCSI adapters that support NVRAM (non-volatile memory).** Check the "NvRAM Found" column to see if NVRAM is present on your adapter. If you choose to alter any of these settings, exit via the **Quit** option and the system will reboot.

Change Adapter Status - Allows you to activate or deactivate a host adapter and all SCSI devices attached to it. The change takes place after a reboot, which is automatic upon exit from the utility when this option is changed.

Adapter Boot Order - Allows you to set the order in which host adapters will boot when more than one Symbios host adapter is present in the system. To change an adapter's boot order, select it and press <Enter>. You are then prompted to enter the new boot sequence number. When the adapters are ordered properly, press the <Esc> key to exit this menu.

	Port Num	Irq Level	-----Status-----		NvRAM Found
			Current	Next-Boot	
SYM53C860	FC00	9	On	On	Yes
SYM53C820	0	0	Off	Off	?
SYM53C825	FD00	9	On	On	Yes
SYM53C815	FE00	10	On	On	No

Display Mode - Determines how much information about your host adapters and SCSI devices is displayed on your computer monitor during boot:

- *verbose*: for more complete information
- *terse*: for a faster boot

Mono/Color - Allows you to choose between a black and white or color display for the SCSI Configuration utility.

Language - English mode only.

Help - Brings up a help screen with information about the Main menu.

Quit - Exits the SCSI Configuration utility.

Adapter Utilities Menu

When you select a host adapter from the main menu, the following screen is displayed:

SYM53C860
Adapter Setup
Device Selections
Help
Exit this menu

- **Adapter Setup:** Adapter settings are viewed and changed.

SYM53C860 Adapter Setup	
SCAM Support	Off
Parity	On
Host SCSI ID	7
Scan Order	Low to High (0..Max)
Removable Media Support	None
CHS Mapping	SCSI Plug and Play Mapping
Spinup Delay (Secs)	2
Help	
Restore Default Setup	
Exit this menu	

SCAM Support - SCAM (SCSI Configured AutoMatically) is the SCSI Plug and Play protocol supported by Symbios BIOS version 4.X.

Parity - The Symbios host adapters always generate parity, but some SCSI devices do not. Therefore, you are offered the option of disabling parity checking.

Note: When disabling parity checking, it is also necessary to disable disconnect for all devices, as parity checking for the reselection phase will not be disabled. If a device does not supporting parity disconnects, the I/O will never complete because the reselection phase will halt.

Host SCSI ID - The host adapter SCSI ID should remain on 7 (default), as this setting gives the adapter the highest priority on the SCSI bus. However, if you have two adapters on the same SCSI bus, you should give one of them an unassigned ID to avoid duplication of SCSI IDs.

Scan Order - This option allows you to tell the host adapter BIOS and your device drivers to scan the SCSI bus from low to high (0 to max) SCSI IDs, or from high to low (max to 0) SCSI IDs. If you have more than one device on the SCSI bus, changing the scan order changes the order in which drive letters are assigned by the system.

Removable Media Support - Determine if the removable media will be used as BIOS device. A BIOS device here is a device that can be controlled via BIOS INT 13H, i.e. it does not need a device driver and can be bootable. However, when used as a BIOS device, the full removability of removable media devices is not preserved. The following constraints apply:

- a) The device can only work as a fixed disk, i.e. media change is not allowed.

- b) The media must be inserted before the system boot-up.
- c) Only media with 512Bytes/sector is supported.

None	The removable media devices will not be used as BIOS devices.
Boot Drive Only	Allows only the removable media installed as Drive C: to work as a BIOS device.
With Media Installed	Enables all removable disk drives to work as BIOS devices.

CHS Mapping – Cylinder, Head, Sector mapping. Options are “SCSI Plug and Play Mapping” (default) and “Alternate CHS Mapping”.

Spinup Delay – 1-10 seconds. The default is a 2-second delay before the BIOS starts to scan for SCSI devices during initialization. This amount of time is enough for most devices to get ready for proper operation. Since some older hard drives may need more time to spin up, you may need to extend the delay for those devices.

- **Device Selections:** Settings for the devices attached to the selected adapter are viewed and changed.

SYM53C860 Devices 0 to 7								
	Sync Rate	Data Width	Disc	Time Out	Scan Bus	LUNS	Queue Tags	Init Boot
Dev0 N/A	20	8	On	10	Yes	Yes	On	No
Dev1 N/A	20	8	On	10	Yes	Yes	On	No
Dev2 N/A	20	8	On	10	Yes	Yes	On	No
Dev3 N/A	20	8	On	10	Yes	Yes	On	No
Dev4 N/A	20	8	On	10	Yes	Yes	On	No
Dev5 N/A	20	8	On	10	Yes	Yes	On	No
Dev6 N/A	20	8	On	10	Yes	Yes	On	No
SYM53C860	20	8	On	10	Yes	Yes	On	No
Devices 8 to15								
Help								
Exit this menu								

The above menu provides information about individual SCSI devices attached to the selected host adapter, as well as the adapter itself. To make changes to these settings select a device from this display and press <Enter> to bring up the individual **Device Setup** menu.

Device Setup Menu

When you select a specific device from the Device Selection menu, your computer displays the following Device Setup menu. The settings in this menu effect individual SCSI devices attached to the selected host adapter. Changes made from this menu will require a system reboot upon exit from the SCSI Configuration utility.

SYM53C860 Setup for All devices on this adapter	
Sync Rate (MBytes/sec)	20
Width (bits)	8
Disconnect	On
Read Write I/O Timeout (secs)	10
Scan for Device at Boot Time	Yes
Scan for SCSI LUNS	Yes
Queue Tags	On
Initial Boot Device	No
Format	
Verify	
Help	
Restore Default Setup	
Exit this menu	

Sync Rate (Mega Bytes/sec) - Defines the maximum transfer rate the host adapter attempts to negotiate. The host adapter and a SCSI device must agree to a rate they can both handle.

Width (bits) - Sets the maximum data width the host adapter will attempt to negotiate. The host adapter and a SCSI device must agree to a width they can both handle. Only those host adapters that support 16 bit data transfers will show this option as enabled.

Disconnect - SCSI devices have the ability to disconnect from the bus during an I/O transfer. This option tells the host adapter whether or not to allow a device to disconnect. Some devices run faster with disconnect enabled (mostly newer devices), while some run faster with disconnect disabled (mostly older devices).

Read Write I/O Timeout (secs) - This option sets the time the host adapter waits for a read, write, verify, or seek command to complete before trying the I/O transfer again. Since this provides a safeguard allowing the system to recover if an I/O operation fails, it is recommended that you always set the time-out to a value greater than zero (no time-out).

Scan for Device at Boot Time - When there is a device you do not wish to make available to the system, set this option to No for that device. Also, on a bus with

only a few devices attached, you can speed up boot time by changing this setting to No for unused SCSI IDs.

Scan for SCSI LUNs - You can set this option to No if you have problems with a device that responds to all LUNs whether they are occupied or not.

Queue Tags - If your device driver can issue queue tags, this option allows you to enable or disable the issuing of queue tags during I/O requests.

Format - Low level format the selected device. All information on the drive will be erased.

Verify - This command is used to detect bad blocks on the chosen disk. With your confirmation, the bad blocks detected can be reassigned for future operations. This command is non-destructive, and therefore won't destroy the data on the drive.

Since some changes only take effect after your system reboots, it is important that you quit this Configuration utility properly. You should return to the Main Menu and exit via the **Quit** option. If you reboot the system without properly exiting the utility, some changes may not be saved.

Device Drivers

To function properly with different SCSI devices under different operating systems you'll need to install **device drivers**. The device driver information should be available in your SCSI adapter's package.

FLASH BIOS PROGRAMMING UTILITY

Updating the Award BIOS Code is made easy with the AWDFLASH Utility found under the “Utilities” folder of the supplied CD-ROM. Since this mainboard features FLASH BIOS, it is not necessary to change the actual BIOS chip in order to upgrade the System BIOS. The user can simply re-program the old BIOS using the AWDFLASH Utility as follows:

1. First, boot the system with DOS or to “Safe Mode” under Windows 95. If you are booting DOS from a hard drive or floppy disk, press [F5] when the message “Starting MS-DOS...” appears on the screen. If you are booting Windows 95, press the [F8] key, and select the “Safe mode command prompt” option. This will assure that the system is running in “*real mode*” with **no device drivers loaded**. *This is the only correct way to run the AWDFLASH Utility program.*
2. There are (2) important files needed to re-program the BIOS. The first is “AWDFLASH.EXE” which is the FLASH BIOS Programming Utility. The second file needed is the updated “BIN” file which contains the actual BIOS code. This file will have the extension [.bin], such as “P598GH.BIN”. Make sure these files are on the diskette or hard drive in the same directory.
3. Start the AWDFLASH Utility by changing to the directory where the two required files exist and typing: AWDFLASH and pressing [ENTER].

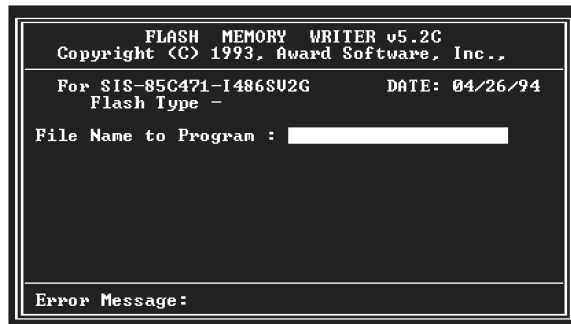

4. The AWDFLASH Utility Screen appears. You will be asked for the file name to program. Type in the name of the new BIOS (.bin) file and hit [ENTER].

FLASH BIOS PROGRAMMING UTILITY

5. The program will then ask if you want to backup the old BIOS. This is recommended in case there are any problems with the new “.bin” file. Enter the name of the new backup file (such as “backup.bin”) and press [ENTER].
6. At this time the system will prompt you for final confirmation before beginning programming. The Utility can be aborted at this time by hitting “n”. To begin programming, hit “y”...
7. When the Flash programming starts, a bar indicator will show the progress of the programming operation. After successful completion, hit the reset button or power off the computer.

Be sure to perform “**LOAD SETUP DEFAULTS**” for your new BIOS to synchronize the previous BIOS with the updated BIOS.

DMI UTILITY

This mainboard supports the **Desktop Management Interface (DMI)**, which is a new method of providing enterprise management for personal computers. The main component of DMI is the Management Information Format Database (MIF), which contains information about the computer system and its components, such as BIOS version/vendor, CPU speed/type, memory size/type, L1/L2 cache, port connectors (IDE, floppy, 2S/1P, USB, keyboard, mouse,), slots ... etc. Using DMI, remote PC management software is able to obtain various information about the system, including hardware profiles, capabilities, operational status, installation dates, and other information about the system and its components.

This DMI utility, DMICFG.EXE found under the "Utilities" folder of the supplied CD-ROM, allows you to add additional information, such as serial numbers, vendor information, and enclosure/chassis configurations, into the MIF.

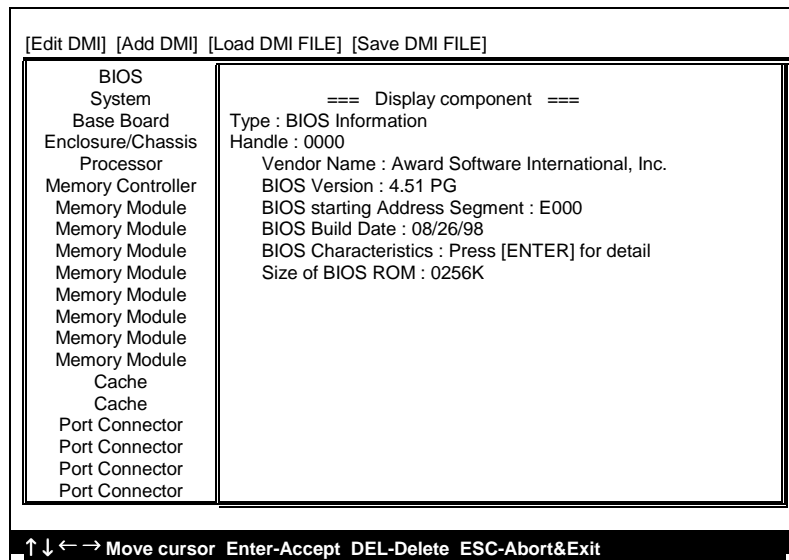

Note: The DMI utility must be run in real mode without the EMM386 memory manager loaded.

27-0M0586-37
