

10. Did the following appear on your screen?

The IBM Personal Computer **DIAGNOSTICS**
Version XXX (C) Copyright IBM Corp XXXX
SELECT AN OPTION
0 - RUN DIAGNOSTIC ROUTINES
1 - FORMAT DISKETTE
2 - COPY DISKETTE
3 - PREPARE FIXED DISK FOR RELOCATION
9 - EXIT TO SYSTEM DISKETTE
ENTER THE ACTION DESIRED

YES - Go to Step 11.

NO - Remove the diskette and verify that it:

- Was the Diagnostics diskette.
- Was inserted correctly.

Correct any mistakes. If the Diagnostics diskette was inserted correctly, the system unit is probably at fault.

Note: If you are using your home television or non-IBM display, you could experience data errors while using your diskette drive. This interference is easily corrected by moving your television or display 12 inches away from your IBM Personal Computer.

11. Press  to select **FORMAT DISKETTE** then

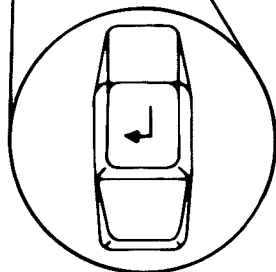
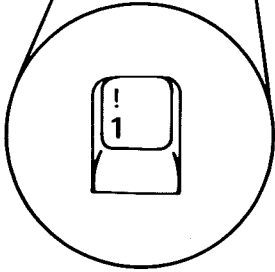
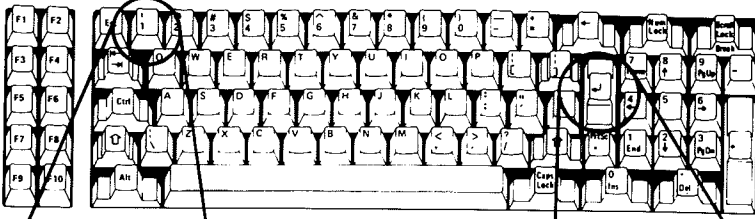

12. Did the following appear on your screen?



The IBM Personal Computer DIAGNOSTICS
Version XXX (C) Copyright IBM Corp XXXX
SELECT AN OPTION
0 - RUN DIAGNOSTIC ROUTINES
1 - FORMAT DISKETTE
2 - COPY DISKETTE
3 - PREPARE FIXED DISK FOR RELOCATION
9 - EXIT TO SYSTEM DISKETTE
ENTER THE ACTION DESIRED
? 1
WHICH DRIVE CONTAINS DISKETTE
TO BE FORMATTED?

YES - Go to Step 13.

NO - Have your keyboard serviced.

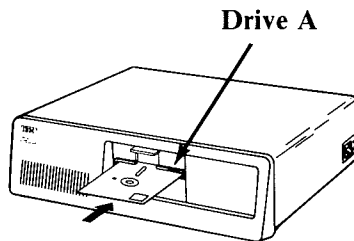
13. Remove the Diagnostics diskette from drive A and insert a blank diskette.



14. Press  then  .

The blank diskette will be formatted, and the in-use light will be on during formatting.

When the in-use light goes out, remove the formatted (scratch) diskette.

Note: A formatted diskette that has no data stored on it is called a *scratch* diskette.

15. Reinsert the Diagnostics diskette into drive A.

Did the following appear on your screen?

SELECT AN OPTION

0 - RUN DIAGNOSTIC ROUTINES



1 - FORMAT DISKETTE

2 - COPY DISKETTE

3 - PREPARE FIXED DISK FOR RELOCATION

9 - EXIT TO SYSTEM DISKETTE

ENTER THE ACTION DESIRED

YES - Press  then .

If you have one display option installed in your system go to Step 17. If you have an IBM Monochrome Display and Printer Adapter and a Color/Graphics Monitor Adapter installed in your system, go to Step 16.

NO - Remove the diskette and verify the following:

- It was a blank diskette.
- The diskettes were inserted in the correct order (blank diskette then Diagnostics diskette).

Try another blank diskette. If the problem still exists, have the system unit serviced.





16. Do you have a display attached to each display adapter installed in your system?

IS A MONITOR ATTACHED TO EVERY DISPLAY ADAPTER (Y/N)?

YES - Press  then  and go to Step 17.

NO - Press  then  and go to Step 17.

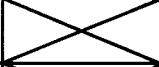
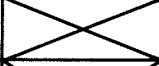
- 17.** Complete the list of installed devices and options and indicate their location with a check mark. Enter the amount of memory installed in your system.

System Unit	Expansion Unit	Installed Device/Option
		System Board
		Expansion Option
		XXX K of Memory
		Keyboard
		Monochrome and Printer Adapter
		X Diskette Drive(s) and Adapter
		Printer Adapter
		Async Communications Adapter
		Matrix Printer
		X Fixed Disk Drive(s) and Adapter
		Game Control Adapter
		Color/Graphics Monitor Adapter
		SDLC Adapter

Installed Devices, Options, and Memory

Note: The IBM Communications Adapter Cable and Printer Adapter Cable will not appear on the list.



In the following sample "S" means the device is installed in the system unit, and "E" means the expansion unit.

- 18.** Does your screen correctly list all your installed devices and options.

THE INSTALLED DEVICES ARE

S SYSTEM BOARD
S EXPANSION OPTION
S 256KB MEMORY
S KEYBOARD
S MONOCHROME & PRINTER ADAPTER
S COLOR/GRAPHICS MONITOR ADAPTER
S 2 DISKETTE DRIVE(S) AND ADAPTER
S GAME CONTROL ADAPTER
E 1 FIXED DISK DRIVE(S) & ADAPTER
S MATRIX PRINTER

IS THE LIST CORRECT (Y/N) ?

YES - Press  then  and go to Step 19.

NO - If the matrix printer was not listed, go to "Printer Problem Determination Procedures." For all other devices or options incorrectly listed, if the option is installed in the system unit, have the system unit serviced. If the option is installed in the expansion unit, have the expansion unit serviced.

19. Press  to select **RUN TESTS ONE TIME**, then



SYSTEM CHECKOUT

0 - RUN TESTS ONE TIME

1 - RUN TESTS MULTIPLE TIMES

2 - LOG UTILITIES

9 - EXIT DIAGNOSTIC ROUTINES

ENTER THE ACTION DESIRED

?

Is an expansion unit attached?

YES - Go to Step 20.

NO - Go to Step 27.

20. Did you receive an expansion unit error message (18XX)?

SYSTEM CHECKOUT

- 0 - RUN TESTS ONE TIME**
- 1 - RUN TEST MULTIPLE TIMES**
- 2 - LOG UTILITIES**
- 9 - EXIT DIAGNOSTIC ROUTINES**

ENTER THE ACTION DESIRED

? 0

SYSTEM UNIT 100

EXPANSION UNIT 1800

THIS TEST TAKES UP TO TWO MINUTES

PLEASE STAND BY

YES - Go to Step 21.

NO - Go to Step 27.

21. Did you receive an 1819 error message (see the following)?

SYSTEM UNIT 100
XX:XX:XX
ERROR EXPANSION UNIT 1819
PRESS ENTER TO CONTINUE

YES - Have the expansion unit serviced.

NO - Go to Step 22.

22. Did you receive an 1820 or 1821 error message?

SYSTEM UNIT 100

XX:XX:XX

ERROR EXPANSION UNIT 182X

PRESS ENTER TO CONTINUE

?

YES - Have the expansion unit and expansion unit cable serviced.

- NO** - a. Set the Power switches on the system unit and expansion unit to Off.
b. Set all external power switches Off (printer, TV, etc.).
c. Disconnect the expansion unit cable from the system unit.
d. Set the system unit's Power switch to On.
e. Go to Step 23.

23. Press  to select **RUN DIAGNOSTIC ROUTINES**,

then  .

**THE IBM PERSONAL COMPUTER DIAGNOSTICS
VERSION XXX (C) COPYRIGHT IBM CORP XXXX**

SELECT AN OPTION

0 - RUN DIAGNOSTIC ROUTINES

1 - FORMAT DISKETTE

2 - COPY DISKETTE

3 - PREPARE FIXED DISK FOR RELOCATION

9 - EXIT TO SYSTEM DISKETTE



ENTER THE ACTION DESIRED

If you have one display option installed in your system, go to Step 25. If you have an IBM Monochrome Display and Printer Adapter and a Color/Graphics Monitor Adapter installed in your system, go to Step 24.

24. Do you have a display attached to each display adapter installed in your system?

IS A MONITOR ATTACHED TO EVERY DISPLAY ADAPTER (Y/N)?

YES - Press  then  and go to Step 25.

NO - Press  then  and go to Step 25.

- 25.** Are any of the options or devices installed in your expansion unit missing from the list?

THE INSTALLED DEVICES ARE

- S SYSTEM BOARD**
- S EXPANSION OPTION**
- S 256KB MEMORY**
- S KEYBOARD**
- S MONOCHROME & PRINTER ADAPTER**
- S COLOR/GRAPHICS MONITOR ADAPTER**
- S 2 DISKETTE DRIVE(S) AND ADAPTER**
- S GAME CONTROL ADAPTER**
- E 1 FIXED DISK DRIVE(S) & ADAPTER**
- S MATRIX PRINTER**

IS THE LIST CORRECT (Y/N) ?

YES - Press  then  and go to Step 26.

NO - Have the system unit serviced.

26. Press  to select **RUN TESTS ONE TIME** then



SYSTEM CHECKOUT

0 - RUN TESTS ONE TIME

1 - RUN TESTS MULTIPLE TIMES

2 - LOG UTILITIES

9 - EXIT DIAGNOSTIC ROUTINES

ENTER THE ACTION DESIRED

?

Did you get an 1820 error message?

YES - Have the expansion unit and expansion unit cable serviced.

NO - Have the system unit serviced.

27. Did the following appear on your screen?

SYSTEM UNIT 100
THIS TEST TAKES UP TO TWO MINUTES
PLEASE STAND BY

YES - Go to Step 28.



NO - Have the system unit serviced.

28. Did the following appear on your screen?



**PRESS EACH KEY, HOLD FOR TYPEMATIC TEST
IF OK PRESS "Y ENTER"
IF NOT OK PRESS "N ENTER"**

YES - Press each key once, then go to Step 29.

NO - Press  then . Record the error message. Have the system unit serviced.



29. Did the following appear on your screen?



```
1 2 < 1 2 3 4 5 6 7 8 9 0 - = ↔ N S
3 4 L Q W E R T Y U I O P [ ] 7 8 9
5 6 C A S D F G H J K L ; ' ' R 4 5 6
7 8 S \ Z X C V B N M , . / S * 1 2 3 +
9 0 A S C 0 .
```

**PRESS EACH KEY HOLD FOR TYPEMATIC TEST
IF OK PRESS "Y ENTER"
IF NOT OK PRESS "N ENTER"**

YES - Press and hold any key. The corresponding character on the screen will flash. This is the typematic test.

If the typematic test works correctly, press

 then  and go to Step 30. If the

typematic test failed, press  then .

Record the error message. Have the keyboard serviced.

NO - If any block did not change to a character, have the keyboard serviced.

30. Do you have an IBM Monochrome Display attached to your system?

NO - Go to Step 33.

YES - Did the following appear on your screen?

DISPLAY ATTRIBUTES

THIS LINE IS AT NORMAL INTENSITY.

THIS LINE IS INTENSIFIED.

THIS LINE IS IN REVERSE VIDEO.

THIS LINE IS BLINKING

THIS LINE IS UNDERLINED

IS THE SCREEN CORRECT? (Y/N)

YES - Press  then  and go to Step 31.

NO - Press  then  . Record the error message.

If the following error message appears, the system unit is at fault. Have the system unit serviced.

XX:XX:XX

ERROR - SYSTEM UNIT XXXX

(X can be any character)

If the following error message appears, the expansion unit is at fault. Have the expansion unit serviced.

XX:XX:XX

ERROR - EXPANSION UNIT XXXX

(X can be any character)

31. Did the following appear on your screen?

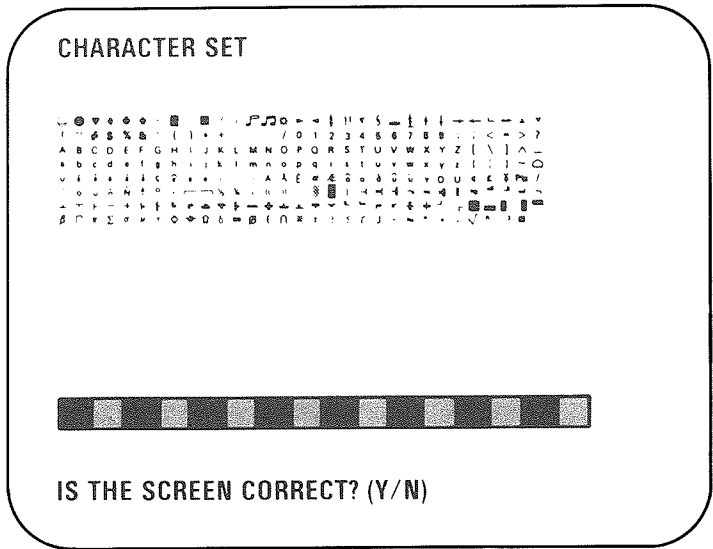

YES - Press  then  and go to Step 32.

NO - Press  then  . Record the error message.

If the following error message appears, the system unit is at fault. Have the system unit serviced.

XX:XX:XX
ERROR - SYSTEM UNIT XXXX
(X can be any character)



If the following error message appears, the expansion unit is at fault. Have the expansion unit serviced.

XX:XX:XX
ERROR - EXPANSION UNIT XXXX
(X can be any character)

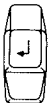
32. Did the following appear on your screen?

NO - Press  then  and go to Step 43.



YES - Press  then  and go to Step 33.

NO - Press  then  . Record the error message.

IS THE SCREEN CORRECT ? (Y/N)

YES - Do you have a Color/Graphics Monitor Adapter installed in your system with a display attached to it?

NO - Press  **then**  **and go to Step 43.**

YES - Press  **then**  **and go to Step 33.**

NO - Press  **then**  **. Record the error message.**

If the error message is 432, go to "Printer Problem Determination Procedures."

If the following error message appears, the system unit is at fault. Have the system unit serviced.

XX:XX:XX

ERROR - SYSTEM UNIT XXXX

(X can be any character)

If the following error message appears, the expansion unit is at fault. Have the expansion unit serviced.

XX:XX:XX

ERROR - EXPANSION UNIT XXXX

(X can be any character)

33. Did the following appear on your color display?

DISPLAY ATTRIBUTES

THIS LINE IS AT NORMAL INTENSITY.

THIS LINE IS INTENSIFIED.

THIS LINE IS IN REVERSE VIDEO.

THIS LINE IS BLINKING.

 BLUE

 GREEN

 CYAN

 RED

 MAGENTA

YELLOW

 WHITE

IS THE SCREEN CORRECT ? (Y/N)

YES - Press  then  and go to Step 34.

NO - Press  then  . Record the error message.

If the following error message appears, the system unit is at fault. Have the system unit serviced.





XX:XX:XX
ERROR - SYSTEM UNIT XXXX
(X can be any character)

If the following error message appears, the expansion unit is at fault. Have the expansion unit serviced.

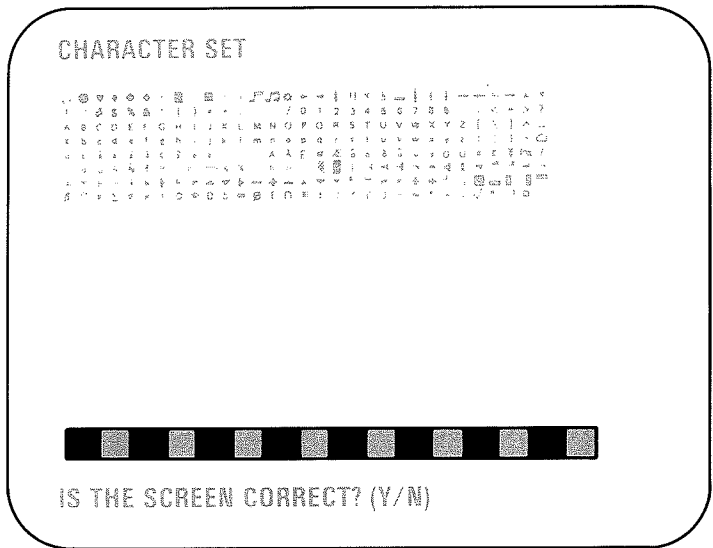
XX:XX:XX
ERROR - EXPANSION UNIT XXXX
(X can be any character)

34. Did the following appear on your screen?



- YES** - Press  then  and go to Step 35.
- NO** - Press  then  . Record the error message.

If the following error message appears, the system unit is at fault. Have the system unit serviced.

XX:XX:XX
ERROR - SYSTEM UNIT XXXX
(X can be any character)

If the following error message appears, the expansion unit is at fault. Have the expansion unit serviced.





XX:XX:XX
ERROR - EXPANSION UNIT XXXX
(X can be any character)

36. Did the following appear on your screen?

40X25 DISPLAY

```
) * + , - . / 0 1 2 3 4 5 6 7 8 9 : ; < = > ? @ A B C D E F G H I J K L M N O  
* + , - . / 0 1 2 3 4 5 6 7 8 9 : ; < = > ? @ A B C D E F G H I J K L M N O P  
+ , - . / 0 1 2 3 4 5 6 7 8 9 : ; < = > ? @ A B C D E F G H I J K L M N O P Q  
, - . / 0 1 2 3 4 5 6 7 8 9 : ; < = > ? @ A B C D E F G H I J K L M N O P Q R  
- . / 0 1 2 3 4 5 6 7 8 9 : ; < = > ? @ A B C D E F G H I J K L M N O P Q R S  
./ 0 1 2 3 4 5 6 7 8 9 : ; < = > ? @ A B C D E F G H I J K L M N O P Q R S T  
/ 0 1 2 3 4 5 6 7 8 9 : ; < = > ? @ A B C D E F G H I J K L M N O P Q R S T U  
0 1 2 3 4 5 6 7 8 9 : ; < = > ? @ A B C D E F G H I J K L M N O P Q R S T U V  
1 2 3 4 5 6 7 8 9 : ; < = > ? @ A B C D E F G H I J K L M N O P Q R S T U V W
```

IS THE SCREEN CORRECT? (Y/N)

- YES** - Press  then  and go to Step 37.
- NO** - Press  then  . Record the error message.

If the following error message appears, the system unit is at fault. Have the system unit serviced.

```
XX:XX:XX  
ERROR - SYSTEM UNIT      XXXX  
(X can be any character)
```



If the following error message appears, the expansion unit is at fault. Have the expansion unit serviced.

```
XX:XX:XX  
ERROR - EXPANSION UNIT      XXXX  
(X can be any character)
```

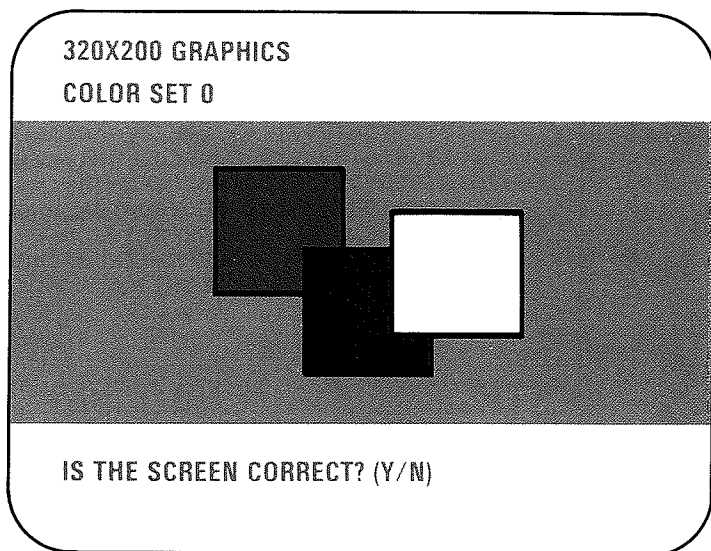
37. Did the following appear on your screen?



YES - Press  then  and go to Step 38.

NO - Press  then  . Record the error message.

If the following error message appears, the system unit is at fault. Have the system unit serviced.





XX:XX:XX
ERROR - SYSTEM UNIT XXXX
(X can be any character)

If the following error message appears, the expansion unit is at fault. Have the expansion unit serviced.

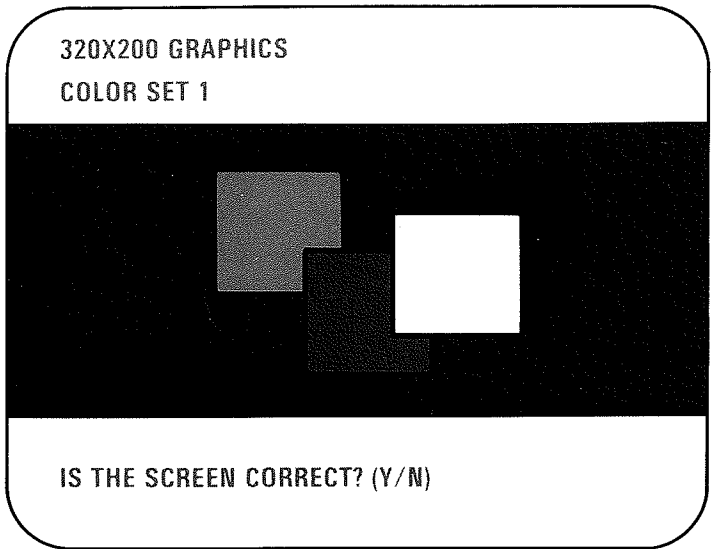
XX:XX:XX
ERROR - EXPANSION UNIT XXXX
(X can be any character)

38. Did the following appear on your screen?



- YES** - Press  then  and go to Step 39.
- NO** - Press  then  . Record the error message.

If the following error message appears, the system unit is at fault. Have the system unit serviced.

XX:XX:XX
ERROR - SYSTEM UNIT XXXX
(X can be any character)

If the following error message appears, the expansion unit is at fault. Have the expansion unit serviced.

XX:XX:XX
ERROR - EXPANSION UNIT XXXX
(X can be any character)

39. Did the following appear on your screen?

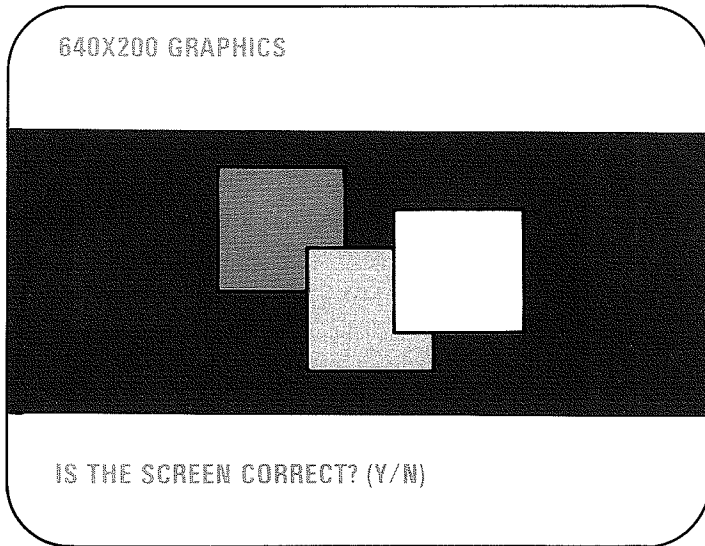

YES - Press  then  and go to Step 40.

NO - Press  then  . Record the error message.

If the following error message appears, the system unit is at fault. Have the system unit serviced.

XX:XX:XX
ERROR - SYSTEM UNIT XXXX
(X can be any character)

If the following error message appears, the expansion unit is at fault. Have the expansion unit serviced.

XX:XX:XX
ERROR - EXPANSION UNIT XXXX
(X can be any character)

43. Remove the Diagnostics diskette.

Your screen will match the figure below.

XXX will be either 400 or 500.

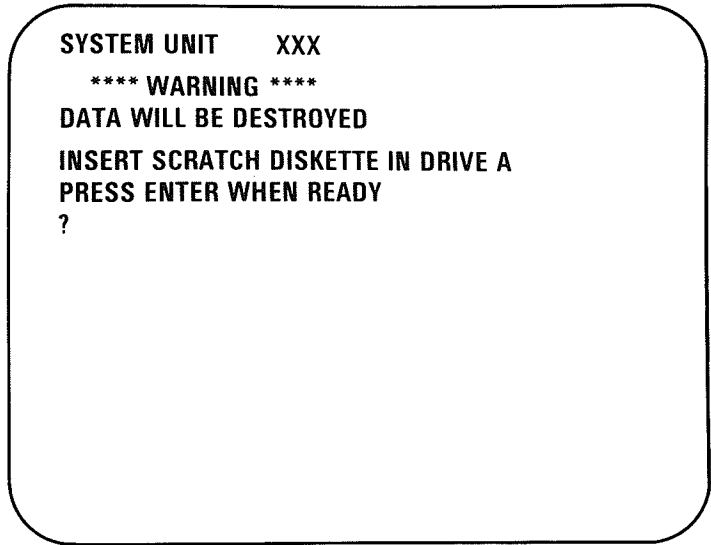

YES - Go to Step 44.

NO - Record the error message.

If the following error message appears, the system unit is at fault. Have the system unit serviced.

```
XX:XX:XX
ERROR - SYSTEM UNIT   XXXX
(X can be any character)
```

If the following error message appears, the expansion unit is at fault. Have the expansion unit serviced.

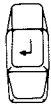

```
XX:XX:XX
ERROR - EXPANSION UNIT   XXXX
(X can be any character)
```

- 44.** Insert a scratch diskette in drive A and press  .
Did the following appear on your screen?

**DISKETTE A IS A XXX K DRIVE
IS THE DRIVE SIZE CORRECT Y/N ?**

If your diskette drive is a 160K drive, XXX will be 160.

If your diskette drive is a 320K drive, XXX will be 320.

YES - Press  then  . If you don't have two diskette drives installed in your system, go to Step 47.

NO - Have the system unit serviced.

45. Did the following appear on your screen?

***** WARNING ***
DATA WILL BE DESTROYED
INSERT SCRATCH DISKETTE IN DRIVE B
PRESS ENTER WHEN READY
?**

Remove the scratch diskette from drive A, place it in
drive B, and press



46. Did the following appear on your screen?

**DISKETTE B IS A XXX K DRIVE
IS THE DRIVE SIZE CORRECT Y/N ?**

If your diskette drive is a 160K drive, XXX will be 160.

If your diskette drive is a 320K drive, XXX will be 320.

YES - Press  then  and go to Step 47.

NO - Have the system unit serviced.

47. Did any of the following errors appear on your screen (X can be any character).

XX:XX:XX
ERROR - SYSTEM UNIT 9XX

XX:XX:XX
ERROR - SYSTEM UNIT 11XX

XX:XX:XX
ERROR - SYSTEM UNIT 12XX

NO - Go to Step 48.

YES - Record the error message.

If the following error message appears, the system unit is at fault. Have the system unit serviced.

XX:XX:XX
ERROR - SYSTEM UNIT XXXX
(X can be any character)

If the following error message appears, the expansion unit is at fault. Have the expansion unit serviced.

XX:XX:XX
ERROR - EXPANSION UNIT XXXX
(X can be any character)

48. Did the following appear on your screen?



**DO YOU HAVE JOY STICKS, PADDLES,
OR NOTHING ATTACHED (J P N)?**

YES - For joy sticks press  and go to Step 49.

For paddles press  and go to Step 52.

For nothing press  and go to Step 56.

NO - Go to Step 56.

49. Press  then .

50. Correct operation of your joy sticks is checked in the following manner:
- Press each button and watch the word **RELEASED** change to **PRESSED**.
 - Move each joy stick and watch the character, A or B, move inside the box.

51. Did all buttons and joy sticks operate correctly?

HOW MANY BUTTONS DO YOU HAVE (2/4)? 2

BUTTON A

BUTTON B

RELEASED

RELEASED

* *

* *

* *

* *

* **A** *

* **B** *

* *

* *

* *

* *

**PRESS AND RELEASE ALL BUTTONS,
EXERCISE ALL JOY STICKS/PADDLES
AND PRESS ANY KEY WHEN DONE**

YES - Press any key and go to Step 56.

NO - If the game control adapter is installed in the system unit, have the joy sticks and the system unit serviced. If the game control adapter is installed in the expansion unit, have the joy sticks and the expansion unit serviced.

52. Enter the number of paddles attached to your game control adapter (2/4) and press .

53. Enter the same number for the number of buttons and press .

54. Correct operation of your paddles is checked in the following manner:

- Press each button and watch the word **RELEASED** change to **PRESSED**.
- Turn each paddle control and watch the character, A, B, C, or D move inside the box.

55. Did all buttons and paddle controls operate correctly?

HOW MANY BUTTONS DO YOU HAVE (2/4)?

BUTTON A	BUTTON B	BUTTON C	BUTTON D
RELEASED	RELEASED	RELEASED	RELEASED
*****		*****	
* A *		* B *	
*****		*****	
*****		*****	
* C *		* D *	
*****		*****	

**PRESS AND RELEASE ALL BUTTONS,
EXERCISE ALL JOY STICKS/PADDLES
AND PRESS ANY KEY WHEN DONE**

YES - Press any key and go to Step 56.

NO - If the game control adapter is installed in the system unit, have the paddles and the system unit serviced. If the game control adapter is installed in the expansion unit, have the paddles and the expansion unit serviced.

56. Did an error appear on your screen?

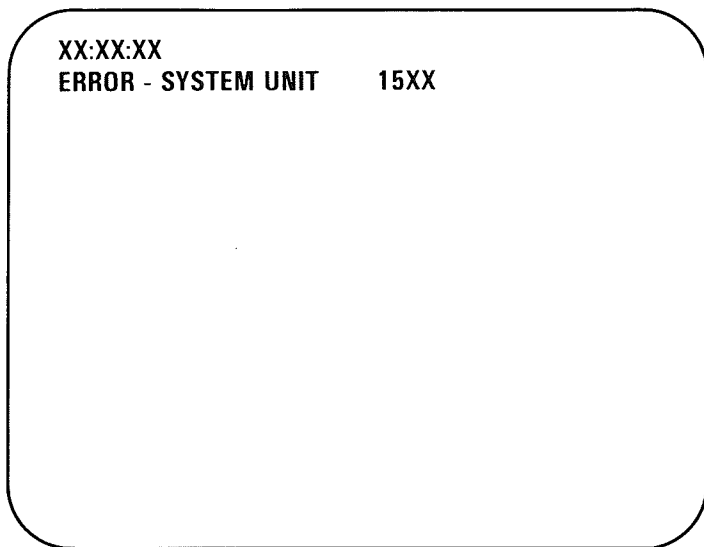

NO - Go to Step 57.

YES - Record the error message.

If the following error message appears, the system unit is at fault. Have the system unit serviced.

XX:XX:XX
ERROR - SYSTEM UNIT XXXX
(X can be any character)

If the following error message appears, the expansion unit is at fault. Have the expansion unit serviced.

XX:XX:XX
ERROR - EXPANSION UNIT XXXX
(X can be any character)

57. Do you have a fixed disk drive installed in your system?

NO - Go to Step 61.

YES - The following will appear on your screen.

***** WARNING *****
DATA ON CYLINDER 305 WILL BE
OVERWRITTEN BY FIXED DISK WRITE TESTS
DO YOU WANT TO INCLUDE FIXED DISK
WRITE TESTS ON DRIVE C: (Y/N) ?

Press  then  and go to Step 58.

58. Did the following appear on your screen?

```
*** WARNING ***  
DATA ON CYLINDER 305 WILL BE  
OVERWRITTEN BY FIXED DISK WRITE TESTS  
DO YOU WANT TO INCLUDE FIXED DISK  
WRITE TESTS ON DRIVE C: (Y/N) ? y  
PERFORMING SEEK TEST  
PERFORMING WRITE TEST  
PERFORMING TRACK ZERO TEST  
PERFORMING SURFACE SCAN  
PLEASE STAND BY
```

YES - For one fixed disk drive installed in your system, go to Step 61. If you have a second fixed disk drive installed in your system, go to Step 59.

NO - Record the error message.

If the following error message appears, the system unit is at fault. Have the system unit serviced.

```
XX:XX:XX  
ERROR - SYSTEM UNIT      XXXX  
(X can be any character)
```

If the following error message appears, the expansion unit is at fault. Have the expansion unit serviced.

```
XX:XX:XX  
ERROR - EXPANSION UNIT   XXXX  
(X can be any character)
```

59. Did the following appear on your screen?

***** WARNING ***
DATA ON CYLINDER 305 WILL BE
OVERWRITTEN BY FIXED DISK WRITE TESTS
DO YOU WANT TO INCLUDE FIXED DISK
WRITE TESTS ON DRIVE D: (Y/N) ?**

YES - Press  then  and go to Step 60.

NO - Record the error message.

If the following error message appears, the system unit is at fault. Have the system unit serviced.

XX:XX:XX

ERROR - SYSTEM UNIT XXXX

(X can be any character)

If the following error message appears, the expansion unit is at fault. Have the expansion unit serviced.

XX:XX:XX

ERROR - EXPANSION UNIT XXXX

(X can be any character)

60. Did the following appear on your screen?

**DO YOU WANT TO INCLUDE FIXED DISK
WRITE TESTS ON DRIVE D: (Y/N) ? y
PERFORMING SEEK TEST
PERFORMING WRITE TEST
PERFORMING TRACK ZERO TEST
PERFORMING SURFACE SCAN
PLEASE STAND BY**

YES - Go to Step 61.

NO - Record the error message.

If the following error message appears, the system unit is at fault. Have the system unit serviced.

**XX:XX:XX
ERROR - SYSTEM UNIT XXXX**
(X can be any character)

If the following error message appears, the expansion unit is at fault. Have the expansion unit serviced.

**XX:XX:XX
ERROR - EXPANSION UNIT XXXX**
(X can be any character)

62. Did the printer test run error free and the printer test pattern print correctly?

YES - Go to Step 63.

NO - Record any error message. Go to "Printer Problem Determination Procedures."

63. You have completed the Problem Determination Procedures with no failures. Remove the Diagnostics diskette and return it to the back of this manual. Your IBM Personal Computer should be ready to load your operating system.

If you should encounter further problems, contact your place of purchase for additional information.

IBM Printer Problem Determination Procedures

Before you proceed, follow these preliminary steps:

- 1.** Check your wall outlet for proper operation (use a working lamp).
- 2.** Verify that your printer cable is properly connected.
- 3.** Verify that the printer is plugged into the wall outlet and is turned on.

Did you find any problem while following the above steps?

YES - Correct the problem and run the Diagnostics again.

NO - Go to Step 4.

- 4.** Set the Power switches on the printer, system unit (and expansion unit, if attached) to Off.
- 5.** Disconnect the printer cable from the printer.
- 6.** Run the printer self-test.

If you need help in doing this, refer to Section 3, "Operations," for the procedure.

Did the self-test run without failures?

YES - Go to Step 12.

NO - Go to Step 7.

- 7.** Check that your ribbon is installed properly.
- 8.** Check that your forms are inserted properly.
- 9.** Check that there are no obstructions in the forms path.
- 10.** Check that the tractors are adjusted properly.

If you need help with any of the above, refer to Section 3, "Operations."

Did you find any problem while following the above steps?

YES - Correct the problem.

NO - Go to Step 11.

- 11.** Do you have any of these problems?
 - a. Your printer beeps even though the paper is installed properly.
 - b. Your printer does not beep when it is out of paper.
 - c. Some of the lights on the control panel do not work.
 - d. Your printer continues to print when it is out of paper.

YES - Have your printer serviced.

NO - Go to Step 15.

12. Did you receive any of the following error messages?

199

432

901

1401

YES - Go to Step 13.

NO - Go to Step 15.

13. Leave the printer cable disconnected from the printer and run the Diagnostics again.

Note: "Matrix Printer" will be missing from the menu of installed devices when you run Diagnostics this time. Verify your installed devices correctly (without the printer).

14. Did you receive the same error message when you ran Diagnostics this time?

YES - The problem is probably in the unit (system or expansion) that has the card your printer was attached to.

NO - Have the printer and cable serviced.

15. Your printer is also controlled by program commands from the system unit. If you have a printer problem only while running a particular program, examine the program thoroughly for commands being sent to the printer causing it to produce undesired results.

IBM Color Display Problem Determination Procedures

If your IBM Color Display requires service, it must be returned with the power cord.

1. Set the Power control to On.

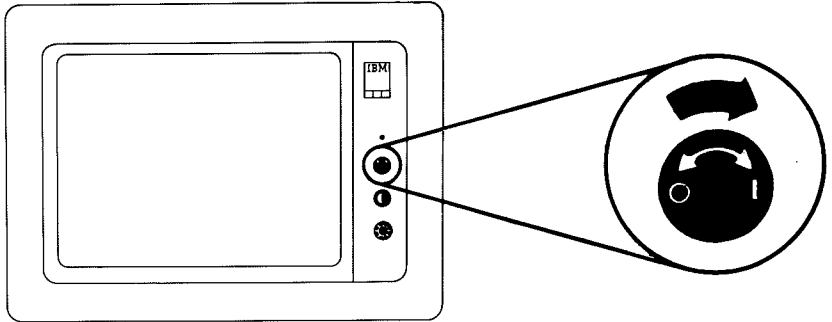

2. Is the Power-On indicator lit?

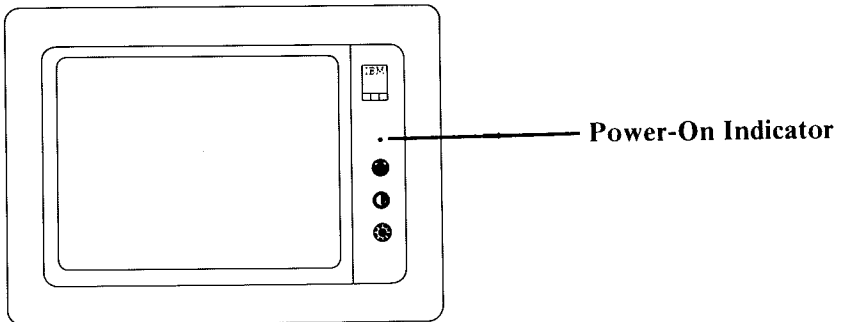

YES - Go to Step 3.

NO - Check that the power cord is plugged into a functioning wall outlet and the rear of the display. If it is, have the display serviced.

3. Set the Power switch on the system unit (and expansion unit, if attached) to Off.
4. Set the Brightness and Contrast controls fully clockwise.

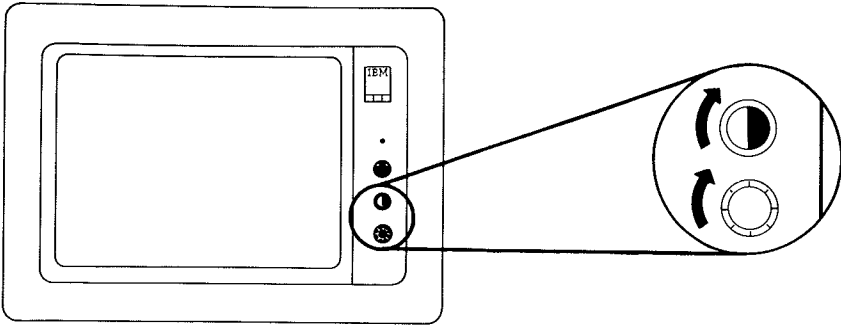

5. Turn the Vertical Size control fully counterclockwise. A black area should appear across the top and the bottom of the screen.

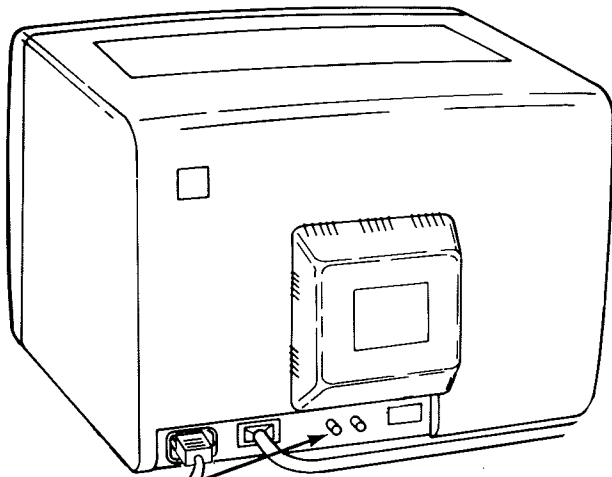

**Vertical Size
Control**

- 6.** Does a black area appear across the top and the bottom of the screen?

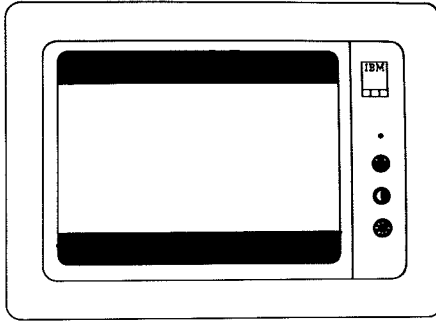

YES - Go to Step 7.

NO - Have the display serviced.

- 7.** Are the black areas at the top and bottom of the screen approximately equal in size?

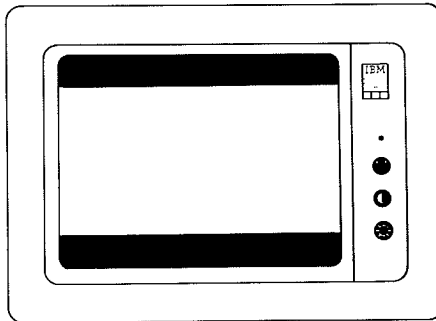

YES - Go to Step 8.

NO - Have the display serviced.

- 8.** Turn the Vertical Size control clockwise until the black areas at the top and bottom of the screen just disappear. If one of the black areas disappears before the other, continue to turn the control until the second black area is gone.

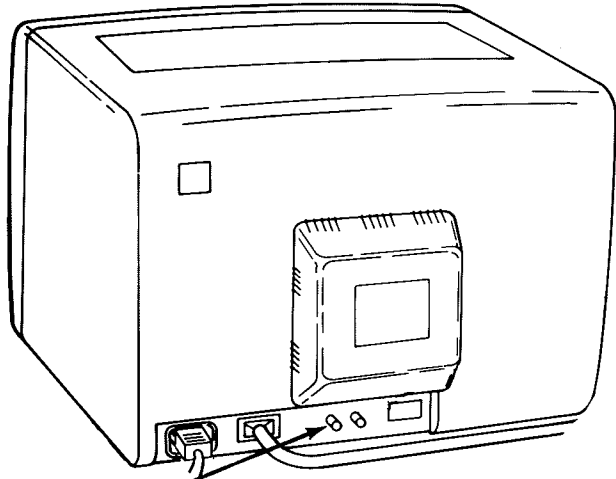

**Vertical Size
Control**

- 9.** Is the screen all white?

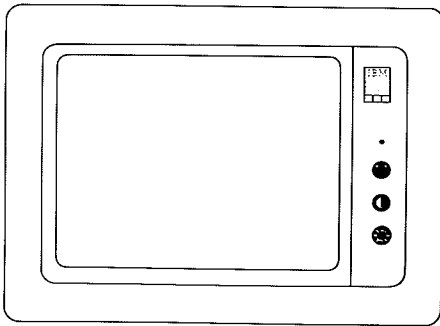

YES - Go to Step 14.

NO - Go to Step 10.

- 10.** Set the Power control to Off.
- 11.** Disconnect the display's signal cable from the Color/Graphics Monitor Adapter.

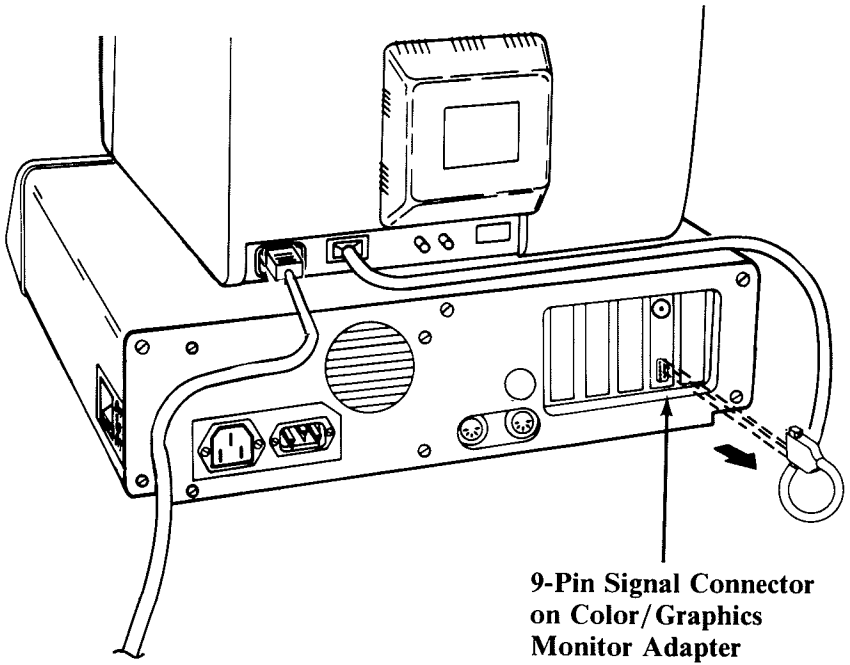

- 12.** Set the Power control to On.
- 13.** Is the screen white?
 - YES** - Have the unit serviced that contains the Color/Graphics Monitor Adapter.
 - NO** - Have the display serviced.
- 14.** While watching the screen, set the Power switch on the expansion unit (if attached) and the system unit to On.

- 15.** Did the screen change from white to black as soon as the Power switch on the unit having the Color/Graphics Monitor Adapter was set to On? (This totally black condition may last only 3 seconds before the display changes again.)

YES - Go to Step 16.

NO - Have the display serviced.

- 16.** Wait for the Power-on self test (POST) to complete. The IBM Personal Computer BASIC message will appear (if a diskette is not loaded or an operating system is not booted from the fixed disk drive) with a blinking cursor.

```
The IBM Personal Computer Basic Version  
CX.XX Copyright IBM Corp. XXXX  
***** Bytes free  
OK
```

```
1LIST 2RUN 3LOAD 4SAVE 5CONT 6LPT1 7TRON 8TROFF 9KEY 0SCREEN
```

- 17.** Is your screen blank?

YES - Have the unit serviced that contains the Color/Graphics Monitor Adapter.

NO - Go to Step 18.

- 18.** Is your screen stable?

YES - Go to Step 21.

NO - Go to Step 19.

- 19.** Turn the Vertical Hold control clockwise as far as it will go, then turn it counterclockwise until the screen stops rolling and is stable.

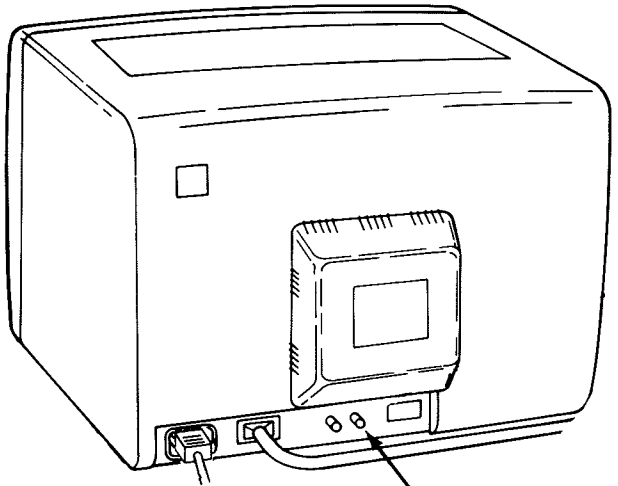

**Vertical Hold
Control**

- 20.** Were you able to make the screen stable?
- YES** - Go to Step 21.
- NO** - Have the display serviced.
- 21.** Look at the screen. Does it have white characters on a dark background?
- YES** - Go to Step 27.
- NO** - Go to Step 22.

- 22.** Set the Power switch on the system unit (and expansion unit, if attached) to Off.
- 23.** Set the display's Power control to Off.
- 24.** Disconnect the display's signal cable from the Color/Graphics Monitor Adapter.
- 25.** Set the display's Power control to On.
- 26.** Is the screen white?
YES - Have the unit serviced that contains the Color/Graphics Monitor Adapter.
NO - Have the display serviced.
- 27.** Turn the Brightness control fully counterclockwise.

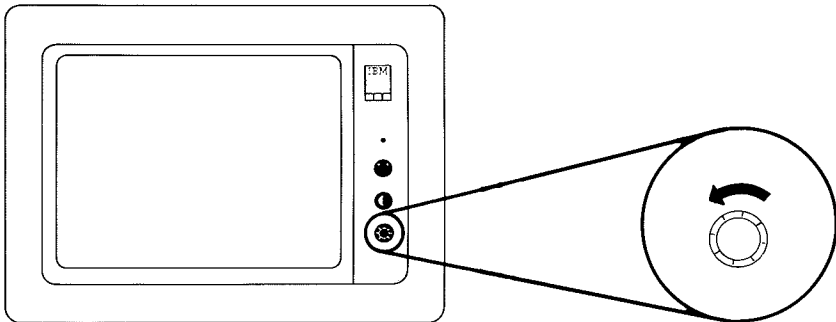

- 28.** Does the intensity of the characters decrease?
YES - Go to Step 29.
NO - Have the display serviced.

- 29.** Turn the Brightness control fully clockwise. Turn the Contrast control fully counterclockwise.

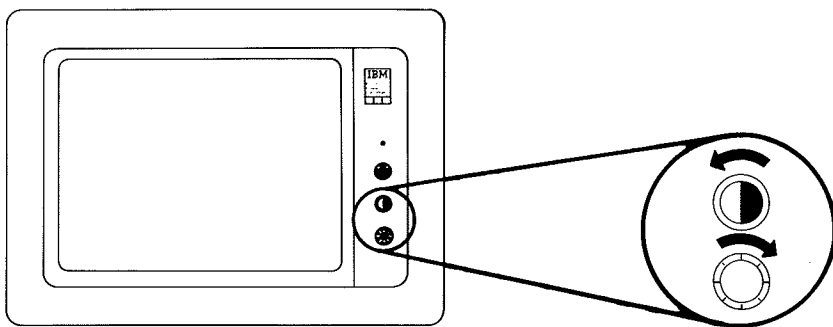

- 30.** Does the intensity of the characters decrease?

YES - Go to Step 31.

NO - Have the display serviced.

31. Turn the Contrast control fully clockwise. Look at the following examples.

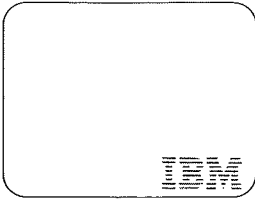

Too Dim

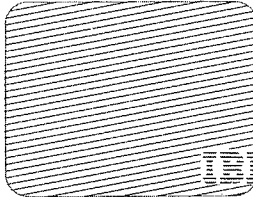

Too Wide

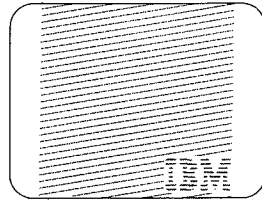

Too Narrow

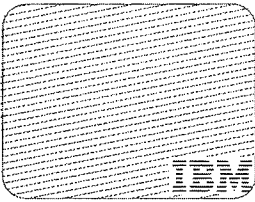

Out of Focus

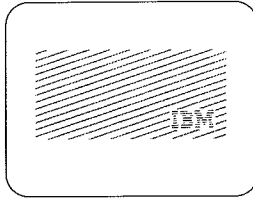

Shrunken

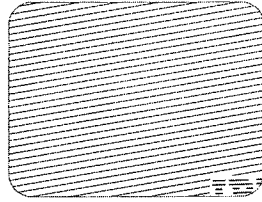

Characters shifted left or right or up and down off the display area

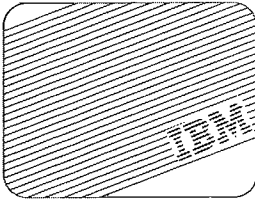

Tilted

32. Is your problem similar to one of the examples?

YES - Have the display serviced.

NO - Go to "Diagnostic Testing" in this section.

SECTION 5. OPTIONS

Introduction

This section has been provided to contain the option installation instructions for the options you purchased for your IBM Personal Computer. After your option has been installed, file the installation instructions under the appropriate bleeder tab, as shown in the figure below.

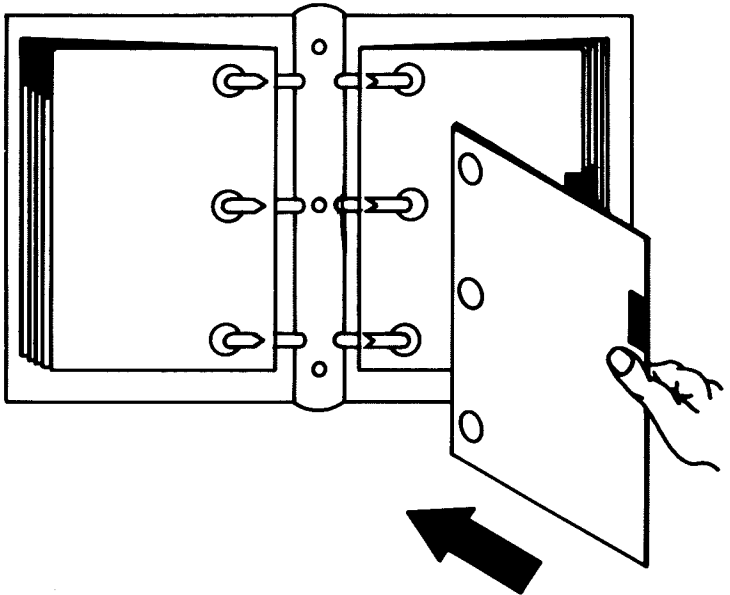

SECTION 5. OPTIONS

Contents

Introduction

IBM Monochrome Display

IBM Monochrome Display and Printer Adapter

Color/Graphics Monitor Adapter

IBM Color Display

IBM Printers

Printer Adapter

5¼ Inch Diskette Drive

5¼ Inch Diskette Drive Adapter

16KB Memory Module Kit

64KB Memory Module Kit

64/256KB Memory Expansion

Game Control Adapter

Asynchronous Communications Adapter

Prototype Card

**Synchronous Data Link Control (SDLC)
Communications Adapter**

IBM Communications Adapter Cable

IBM Personal Computer Expansion Unit

**Synchronous Data Link Control (SDLC)
Communications Adapter**

IBM Communications Adapter Cable

DISPLAYS

PRINTERS

DISKETTE/DISK

MEMORY

GENERAL

COMMUNICATIONS

SWITCH SETTINGS

Notes:

Switch Setting Charts

Use the illustrations below to determine which system board is in your system unit.

- A 64KB-256KB system board has a "B" stamped on the rear panel and 64KB-256KB CPU printed on the system board. If you have this system board, go to page 5-28.
- A 16KB-64KB system board has no identification on the rear panel and 16KB-64KB CPU is printed on the system board. If you have this system board, go to page 5-2.

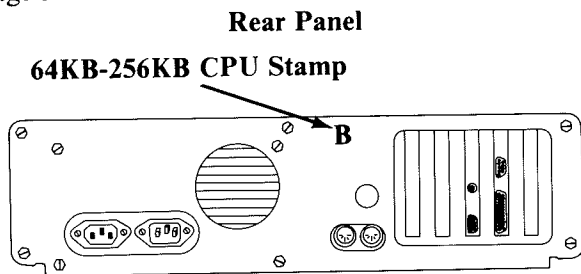

No "B" stamp indicates a 16KB-64KB CPU.

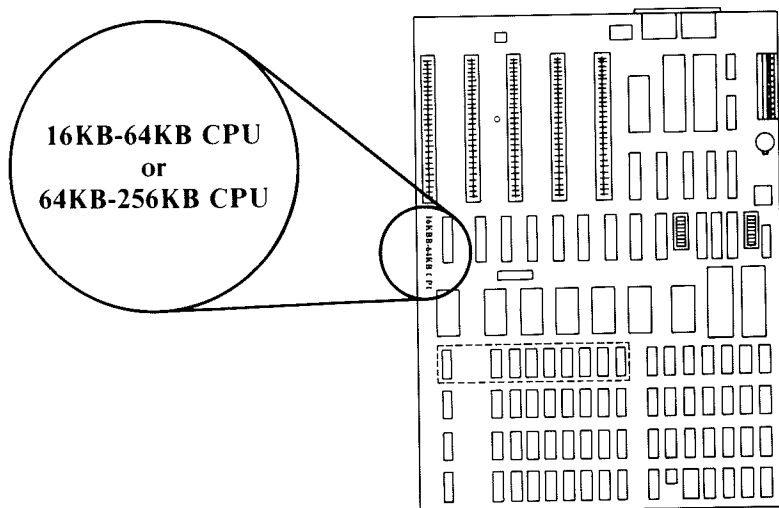

16K-64K System Board

To use the following switch setting charts, your system should have no "B" stamped on the rear panel and the system board should have 16KB-64KB CPU printed on the side.

Switch Setting Charts

System Board Switches

WARNING: Before you change any switch settings, make a note of how the switches are presently set.

Switch Block 1

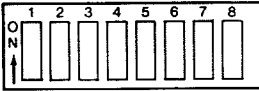

Switch	Function
--------	----------

- | | |
|-------|--|
| 1,7,8 | Number of 5-1/4 inch diskette drives installed |
| 2 | Coprocessor |
| 3,4 | System board memory switches |
| 5,6 | Type(s) of display(s) connected |

Switch Block 2

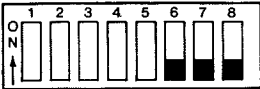

Switch	Function
--------	----------

- | | |
|-----------|------------------------------------|
| 1,2,3,4,5 | Amount of memory options installed |
| 6,7,8 | Always in the Off position |

Number of 5-1/4 Inch Diskette Drives Installed

	Switch Block 1	Switch Block 2
0 - Drives		
1 - Drive		
2 - Drives		

Type(s) of Display(s) Connected

WARNING: If an IBM Monochrome Display is connected to your system, Switch Block 1, switches 5 and 6, must always be Off. Damage to your display can result with any other switch settings.

	Switch Block 1	Switch Block 2	
IBM Monochrome Display (or IBM Monochrome Display plus another display)			
	Switch Block 1	Switch Block 2	
Color Display (Do not use if an IBM Monochrome Display is connected)			40x25 Mode
			80x25 Mode

Note: The 40x25 mode means there will be 40 characters across the screen and 25 lines down the screen. The 40x25 is normally used with a home television. The 80x25 mode means there will be 80 characters across the screen and 25 lines down the screen. The 80x25 mode, when used with home televisions and various displays, can cause loss of character quality.

Math Coprocessor

Switch Block 1

Switch Block 2

With Math Coprocessor

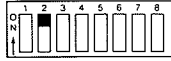

Without Math Coprocessor

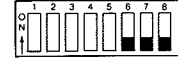
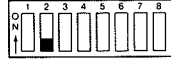

Memory Switch Settings (16KB-64KB CPU) System Board

16K Total Memory

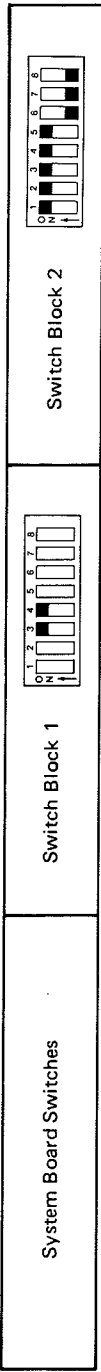

32K Total Memory

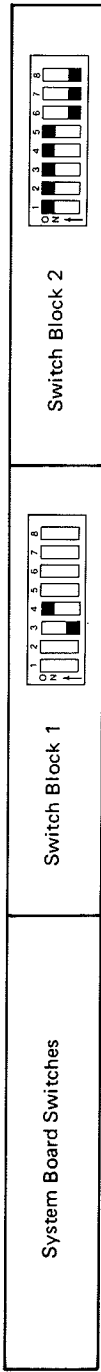

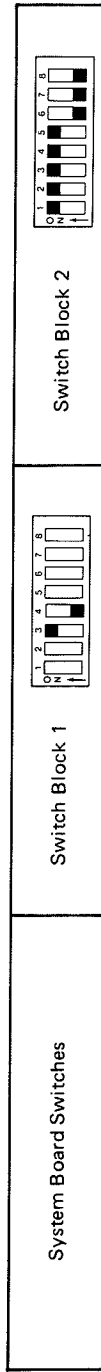

48K Total Memory



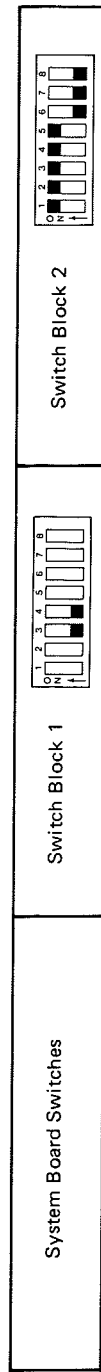

64K Total Memory







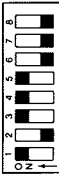

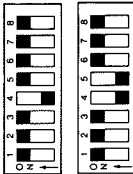
96K Total Memory
32K + (64K on System Board)

System Board Switches	 <p>Switch Block 1</p>	 <p>Switch Block 2</p>
1 - 32K option	64/256K Option Card Switches	64K Option Card Switches
	32K Option Card Switches	



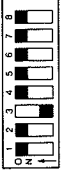

**128K Total Memory
64K + (64K on System Board)**

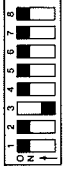
System Board Switches	Switch Block 1 	Switch Block 2 	
1 - 64/256K option with 64K installed	64/256K Option Card Switches 	64K Option Card Switches 	32K Option Card Switches
1 - 64K option			
2 - 32K options			



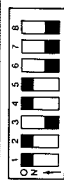
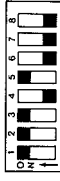
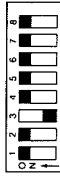
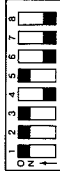
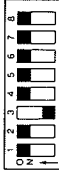

**160K Total Memory
96K + (64K on System Board)**

System Board Switches	Switch Block 1 	Switch Block 2 
64/256K Option Card Switches	64K Option Card Switches	32K Option Card Switches
1 - 64/256K option with 64K installed 1 - 32K option		
1 - 64K option 1 - 32K option		
3 - 32K options		  

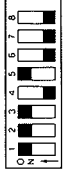

**192K Total Memory
128K + (64K on System Board)**

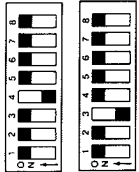
System Board Switches	Switch Block 1	Switch Block 2
<p>1 - 64/256K option with 64K installed 1 - 64K option</p>		
<p>2 - 64K options</p>		
<p>1 - 64/256K option with 64K installed 2 - 32K options</p>		
<p>1 - 64K option 2 - 32K options</p>		
<p>1 - 64/256K option with 128K installed</p>		

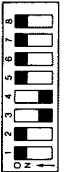

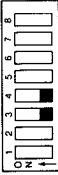
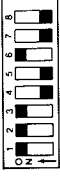

**224K Total Memory
160K + (64K on System Board)**

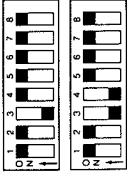
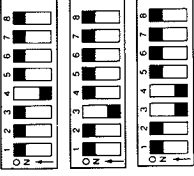
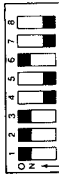
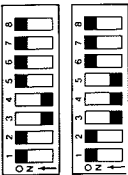
System Board Switches	Switch Block 1	Switch Block 2
1 - 64/256K option with 64K installed 1 - 64K option 1 - 32K option	64/256K Option Card Switches 	32K Option Card Switches 
2 - 64K options 1 - 32K option	64K Option Card Switches 	
1 - 64/256K option with 128K installed 1 - 32K option		

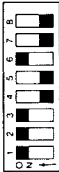

**256K Total Memory
192K + (64K on System Board)**

System Board Switches	Switch Block 1	Switch Block 2	
1 - 64/256K option with 192K installed			32K Option Card Switches
1 - 64/256K option with 128K installed 1 - 64K option			64K Option Card Switches
1 - 64/256K option with 64K installed 2 - 64K options			
3 - 64K options			
1 - 64/256K option with 128K installed 2 - 32K options			

**288K Total Memory
224K + (64K on System Board)**

System Board Switches	 <p align="center">Switch Block 1</p>	 <p align="center">Switch Block 2</p>
<p>1 - 64/256K option with 192K installed 1 - 32K option</p>	<p>64/256K Option Card Switches</p> 	<p>64K Option Card Switches</p>
<p>1 - 64/256K option with 128K installed 1 - 64K option 1 - 32K option</p>		

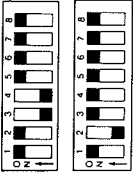
**320K Total Memory
256K + (64K on System Board)**

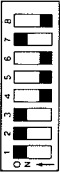
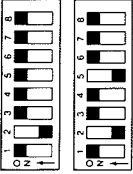
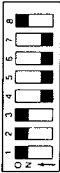
System Board Switches	Switch Block 1	Switch Block 2
<p>1 - 64/256K option with 128K installed 2 - 64K options</p>	<p>64/256K Option Card Switches</p> 	<p>64K Option Card Switches</p> 
<p>1 - 64/256K option with 192K installed 1 - 64K option</p>	<p>64/256K Option Card Switches</p> 	<p>32K Option Card Switches</p> 
<p>1 - 64/256K option with 192K installed 2 - 32K options</p>	<p>64/256K Option Card Switches</p> 	<p>32K Option Card Switches</p> 
<p>1 - 64/256K option with 256K installed</p>	<p>64/256K Option Card Switches</p> 	

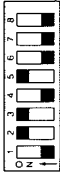
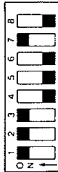
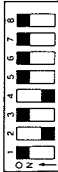

**352K Total Memory
288K + (64K on System Board)**

System Board Switches	Switch Block 1	Switch Block 2
1 - 64/256K option with 192K installed 1 - 64K option 1 - 32K option		
1 - 64/256K option with 256K installed 1 - 32K option		

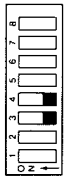
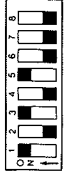
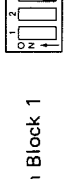
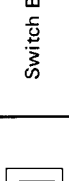
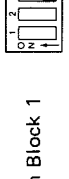
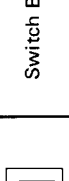
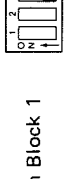
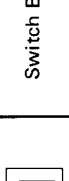

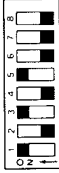

384K Total Memory
320K + (64K on System Board)

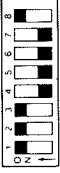
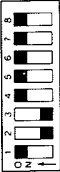
System Board Switches	Switch Block 1	Switch Block 2		
1 - 64/256K option with 192K installed 2 - 64K options			64/256K Option Card Switches	32K Option Card Switches
1 - 64/256K option with 256K installed 1 - 64/256K option with 64K installed			64/256K Option Card Switches	64K Option Card Switches
1 - 64/256K option with 256K installed 1 - 64K option			64/256K Option Card Switches	64K Option Card Switches
1 - 64/256K option with 256K installed 2 - 32K options			64/256K Option Card Switches	32K Option Card Switches

**416K Total Memory
352K + (64K on System Board)**

System Board Switches	Switch Block 1	Switch Block 2
<p>1 - 64/256K option with 256K installed 1 - 64/256K option with 64K installed 1 - 32K option</p>	<p>64/256K Option Card Switches</p>  	<p>64K Option Card Switches</p> 
<p>1 - 64/256K option with 256K installed 1 - 64K option 1 - 32K option</p>	<p>64/256K Option Card Switches</p> 	<p>32K Option Card Switches</p> 

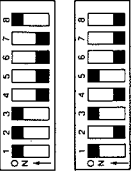
**448K Total Memory
384K + (64K on System Board)**

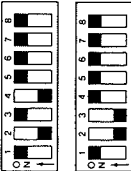
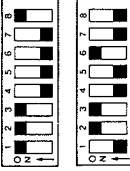
System Board Switches	Switch Block 1 	Switch Block 2 	
<p>1 - 64/256K option with 256K installed 1 - 64/256K option with 64K installed 1 - 64K option</p>	<p>64/256K Option Card Switches</p> 	<p>64K Option Card Switches</p> 	<p>32K Option Card Switches</p>
<p>1 - 64/256K option with 256K installed 2 - 64K options</p>			
<p>1 - 64/256K option with 256K installed 1 - 64/256K option with 128K installed</p>			



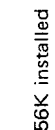

**480K Total Memory
416K + (64K on System Board)**

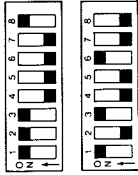
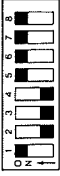
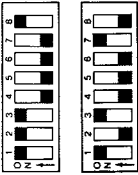
System Board Switches	Switch Block 1	Switch Block 2
<p>1 - 64/256K option with 256K installed 1 - 64/256K option with 128K installed 1 - 32K option</p>	<p>64/256K Option Card Switches</p> 	<p>64K Option Card Switches</p>
		<p>32K Option Card Switches</p> 

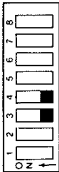

**512K Total Memory
448K + (64K on System Board)**

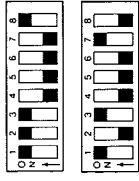
System Board Switches	Switch Block 1	Switch Block 2
<p>1 - 64/256K option with 256K installed 1 - 64/256K option with 128K installed 1 - 64K option</p>	<p>64/256K Option Card Switches</p> 	<p>64K Option Card Switches</p> 
<p>1 - 64/256K option with 256K installed 1 - 64/256K option with 192K installed</p>		<p>64K Option Card Switches</p>



**544K Total Memory
480K + (64K on System Board)**

System Board Switches	Switch Block 1 	Switch Block 2 
	64K Option Card Switches	32K Option Card Switches
<p>1 - 64/256K option with 256K installed 1 - 64/256K option with 192K installed 1 - 32K option</p>		

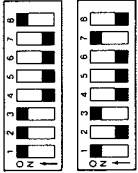
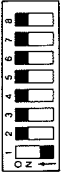
**576K Total Memory
512K + (64K on System Board)**

System Board Switches	Switch Block 1 	Switch Block 2 
<p>1 - 64/256K option with 256K installed 1 - 64/256K option with 192K installed 1 - 64K option</p>	<p>64/256K Option Card Switches</p> 	<p>64K Option Card Switches</p> 
<p>2 - 64/256K option with 256K installed</p>		<p>32K Option Card Switches</p>

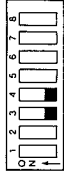
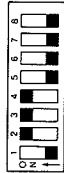
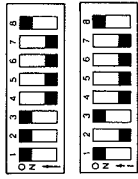





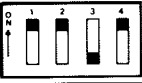

**608K Total Memory
544K + (64K on System Board)**

System Board Switches	Switch Block 1 	Switch Block 2 
	64/256K Option Card Switches 	64K Option Card Switches
2 - 64/256K option with 256K installed 1 - 32K option		32K Option Card Switches 

**640K Total Memory
576K + (64K on System Board)**

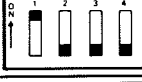
System Board Switches	Switch Block 1	Switch Block 2
<p>2 - 64/256K option with 256K installed 1 - 64K option</p>	<p>64/256K Option Card Switches</p>	<p>64K Option Card Switches</p>
<p>2 - 64/256K option with 256K installed 1 - 64/256K option with 64K installed</p>		<p>32K Option Card Switches</p>

Extender Card Switch Settings

System Memory	Extender Card Switch Block	Memory Segment
16K to 64K		1
96K to 128K		2
160K to 192K		3
224K to 256K		4
288K to 320K		5
352K to 384K		6
416K to 448K		7
480K to 512K		8
544K to 576K		9
608K to 640K		A

Notes:

64K-256K System Board

To use the following switch setting charts, your system should have a "B" stamped on the rear panel and the system board should have 64KB-256KB CPU printed on the side.

Notes:

Switch Setting Charts

System Board Switches

WARNING: Before you change any switch settings, make a note of how the switches are presently set.

Switch Block 1

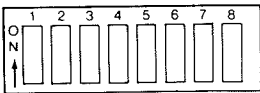

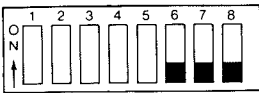

Switch	Function
1,7,8	Number of 5-1/4 inch diskette drives installed
2	Coprocessor
3,4	System board memory switches
5,6	Type(s) of display(s) connected

Switch Block 2





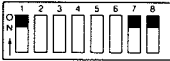
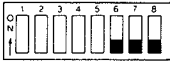
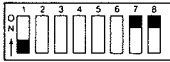
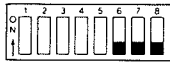
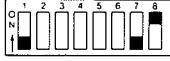



Switch	Function
1,2,3,4,5	Amount of memory options installed
6,7,8	Always in the Off position

Number of 5-1/4 Inch Diskette Drives Installed

	Switch Block 1	Switch Block 2
0 - Drives		
1 - Drive		
2 - Drives		

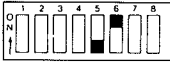
Type(s) of Display(s) Connected

WARNING: If an IBM Monochrome Display is connected to your system, Switch Block 1, switches 5 and 6, must always be Off. Damage to your display can result with any other switch settings.

IBM Monochrome Display (or IBM Monochrome Display plus another display)	Switch Block 1 	Switch Block 2 
Color Display (Do not use if an IBM Monochrome Display is connected)	Switch Block 1 	Switch Block 2 
		40x25 Mode
		
		80x25 Mode

Note: The 40x25 mode means there will be 40 characters across the screen and 25 lines down the screen. The 40x25 is normally used with a home television. The 80x25 mode means there will be 80 characters across the screen and 25 lines down the screen. The 80x25 mode, when used with home televisions and various displays, can cause loss of character quality.

Math Coprocessor

Switch Block 1

Switch Block 2

With Math Coprocessor

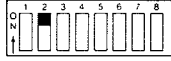

Without Math Coprocessor

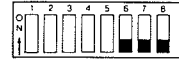
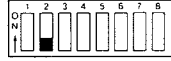

Memory Switch Settings (64KB-256KB CPU) System Board

64K Total Memory

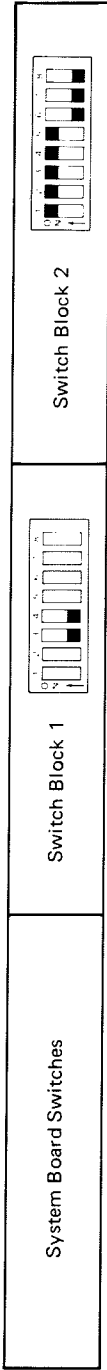

128K Total Memory

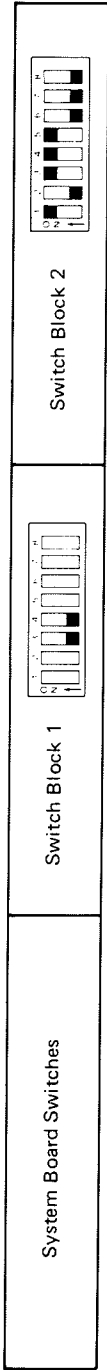

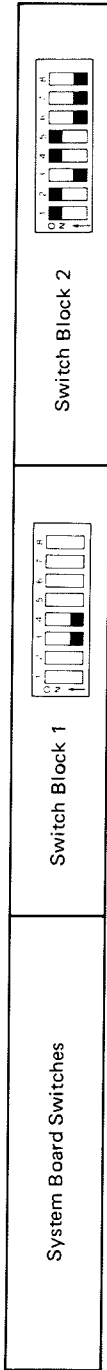

192K Total Memory



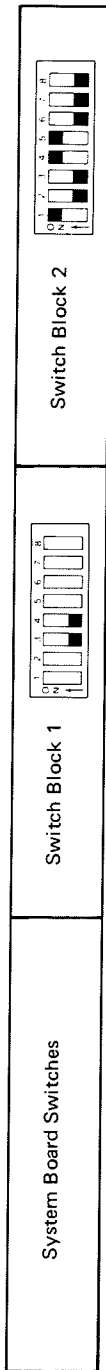

256K Total Memory

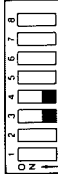

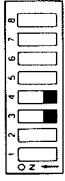
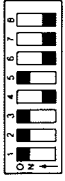
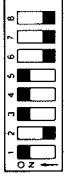

**288K Total Memory
32K + (256K on System Board)**

System Board Switches	 <p align="center">Switch Block 1</p>	 <p align="center">Switch Block 2</p>
1 - 32K option	64/256K Option Card Switches	32K Option Card Switches

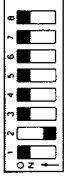
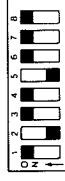

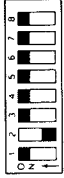
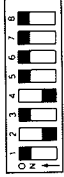
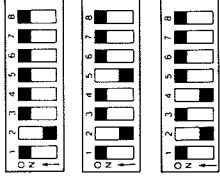

**320K Total Memory
64K + (256K on System Board)**

System Board Switches	 <p align="center">Switch Block 1</p>	 <p align="center">Switch Block 2</p>
<p>1 - 64/256K option with 64K installed</p> <p>1 - 64K option</p> <p>2 - 32K options</p>	<p>64/256K Option Card Switches</p> 	<p>64K Option Card Switches</p> 
		<p>32K Option Card Switches</p>  



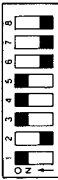

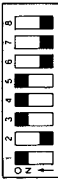
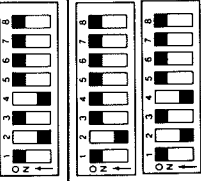
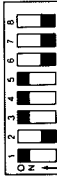
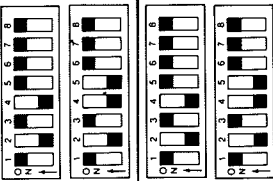
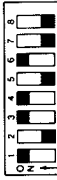
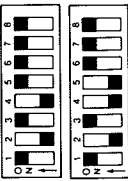
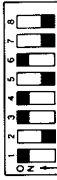
**352K Total Memory
96K + (256K on System Board)**

System Board Switches	Switch Block 1	Switch Block 2
1 - 64/256K option with 64K installed 1 - 32K option		
1 - 64K option 1 - 32K option		
3 - 32K options		





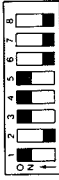
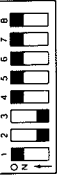
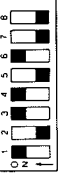



**384K Total Memory
128K + (256K on System Board)**

System Board Switches	Switch Block 1	Switch Block 2
1 - 64/256K option with 64K installed 1 - 64K option		
2 - 64K options		
1 - 64/256K option with 64K installed 2 - 32K options		
1 - 64K option 2 - 32K options		
1 - 64/256K option with 128K installed		

**416K Total Memory
160K + (256K on System Board)**

System Board Switches	Switch Block 1	Switch Block 2
1 - 64/256K option with 64K installed 1 - 64K option 1 - 32K option		
2 - 64K options 1 - 32K option		
1 - 64/256K option with 128K installed 1 - 32K option		

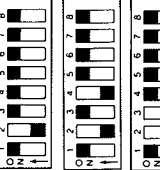

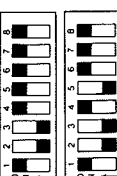



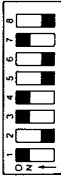
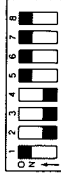
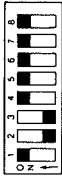
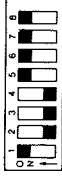

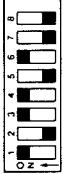
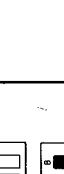
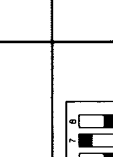

**448K Total Memory
192K + (256K on System Board)**

System Board Switches	Switch Block 1	Switch Block 2
1 - 64/256K option with 192K installed		
1 - 64/256K option with 128K installed 1 - 64K option		
1 - 64/256K option with 64K installed 2 - 64K options		
3 - 64K options		
1 - 64/256K option with 128 installed 2 - 32K options		





**480K Total Memory
224K + (256K on System Board)**

System Board Switches	Switch Block 1	Switch Block 2
1 - 64/256K option with 192K installed 1 - 32K option	64/256K Option Card Switches 	32K Option Card Switches 
1 - 64/256K option with 128K installed 1 - 64K option 1 - 32K option	64K Option Card Switches 	32K Option Card Switches 







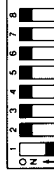

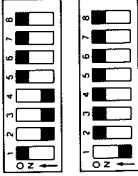
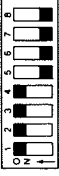

**512K Total Memory
256K + (256K on System Board)**

System Board Switches	Switch Block 1	Switch Block 2	
1 - 64/256K option with 128K installed 2 - 64K options			<p align="center">64/256K Option Card Switches</p> 
1 - 64/256K option with 192K installed 1 - 64K option			<p align="center">64K Option Card Switches</p> 
1 - 64/256K option with 192K installed 2 - 32K options			<p align="center">32K Option Card Switches</p> 
1 - 64/256K option with 256K installed			





**544K Total Memory
288K + (256K on System Board)**

System Board Switches	 <p align="center">Switch Block 1</p>	 <p align="center">Switch Block 2</p>
<ul style="list-style-type: none"> 1 - 64/256K option with 192K installed 1 - 64K option 1 - 32K option 	<p align="center">64/256K Option Card Switches</p> 	<p align="center">64K Option Card Switches</p> 
<ul style="list-style-type: none"> 1 - 64/256K option with 256K installed 1 - 32K option 		<p align="center">32K Option Card Switches</p> 



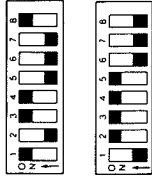

**576K Total Memory
320K + (256K on System Board)**

System Board Switches	Switch Block 1	Switch Block 2
<p>1 - 64/256K option with 192K installed 2 - 64K options</p>	<p>64/256K Option Card Switches</p> 	<p>64K Option Card Switches</p>  <p>32K Option Card Switches</p> 
<p>1 - 64/256K option with 256K installed 1 - 64/256K option with 64K installed</p>	<p>64/256K Option Card Switches</p> 	<p>64K Option Card Switches</p>  <p>32K Option Card Switches</p> 
<p>1 - 64/256K option with 256K installed 1 - 64K option</p>	<p>64/256K Option Card Switches</p> 	<p>64K Option Card Switches</p>  <p>32K Option Card Switches</p> 
<p>1 - 64/256K option with 256K installed 2 - 32K options</p>	<p>64/256K Option Card Switches</p> 	<p>64K Option Card Switches</p>  <p>32K Option Card Switches</p> 



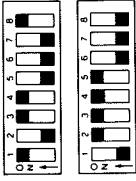

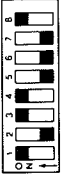
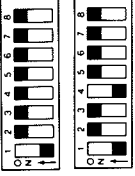
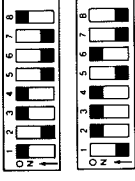



**608K Total Memory
352K + (256K on System Board)**

System Board Switches	Switch Block 1	Switch Block 2
<p>1 - 64/256K option with 256K installed 1 - 64/256K option with 64K installed 1 - 32K option</p>	<p>64/256K Option Card Switches</p> 	<p>64K Option Card Switches</p> 
<p>1 - 64/256K option with 256K installed 1 - 64K option 1 - 32K option</p>	<p>64/256K Option Card Switches</p> 	<p>32K Option Card Switches</p> 

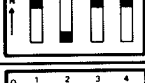
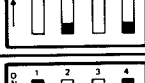
**640K Total Memory
384K + (256K on System Board)**

System Board Switches	Switch Block 1	Switch Block 2
<p>1 - 64/256K option with 256K installed 1 - 64/256K option with 64K installed 1 - 64K option</p>	<p>64/256K Option Card Switches</p> 	<p>64K Option Card Switches</p> 
<p>1 - 64/256K option with 256K installed 2 - 64K options</p>	<p>64/256K Option Card Switches</p> 	<p>64K Option Card Switches</p> 
<p>1 - 64/256K option with 256K installed 1 - 64/256K option with 128K installed</p>	<p>64/256K Option Card Switches</p> 	<p>32K Option Card Switches</p> 

Extender Card Switch Settings

System Memory	Extender Card Switch Block	Memory Segment
16K to 64K		1
96K to 128K		2
160K to 192K		3
224K to 256K		4
288K to 320K		5
352K to 384K		6
416K to 448K		7
480K to 512K		8
544K to 576K		9
608K to 640K		A

SWITCH SETTINGS

Notes:

Notes:

Notes:

SECTION 6. RELOCATE

Contents

Physical Preparation of the System	6-3
Short Distance Relocate	6-8
Long Distance Relocate for System and Expansion Unit(s)	6-9
Long Distance Relocate for Keyboard	6-10
Long Distance Relocate for IBM Monochrome or Color Display	6-11
Long Distance Relocate for IBM 80 CPS Matrix/Graphics Printer	6-12
Setup At New Location	6-13

Notes:

Physical Preparation of the System



If you have an expansion unit with a fixed disk drive installed, use the following procedure to prevent damage to the fixed disk during relocation.

WARNING: Normal shipping and handling can result in a permanent loss of all data on the fixed disk drive(s). It is recommended that all files be backed up onto diskettes before continuing with this procedure.

Depending on the amount of data stored, you may require as many as 64 diskettes to backup each fixed disk drive. Refer to the *IBM Disk Operating System* manual for a description of the BACKUP command.

1. Insert Diagnostics diskette.
2. Set the Power switch on the expansion unit (if attached) and system unit to ON.
3. The following message should appear on your screen.

```
SELECT AN OPTION
0 - RUN DIAGNOSTIC ROUTINES
1 - FORMAT DISKETTE
2 - COPY DISKETTE
3 - PREPARE FIXED DISK FOR RELOCATION
9 - EXIT TO SYSTEM DISKETTE
ENTER THE ACTION DESIRED
?
```

4. Press  then press  .

This step moves the disk head over track 305 which is the position designated for moving your system.

5. The following message should appear on your screen.

SELECT AN OPTION

0 - RUN DIAGNOSTIC ROUTINES

1 - FORMAT DISKETTE

2 - COPY DISKETTE

3 - PREPARE FIXED DISK FOR RELOCATION

9 - EXIT TO SYSTEM DISKETTE

ENTER THE ACTION DESIRED

? 3

FIXED DISK(S) READY FOR SHIPPING

6. Remove diskettes from diskette drive unit.

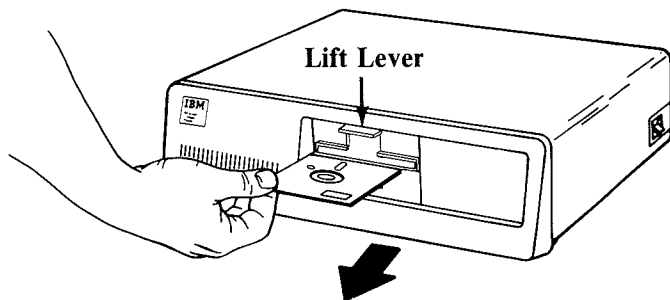

7. Position power switches to OFF on all units (System Unit, Printer, etc.).

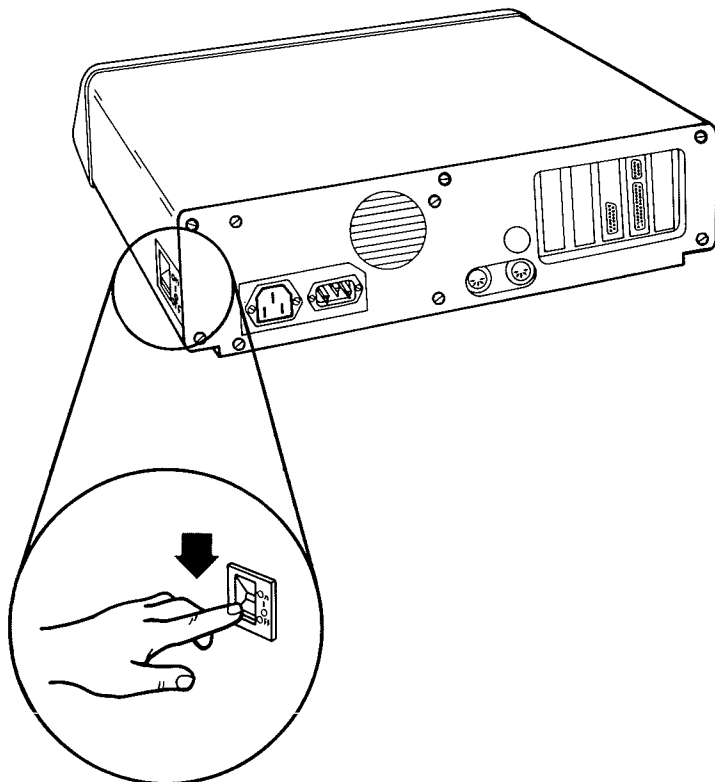

8. Unplug the system unit's (and expansion unit's) power cord from the wall outlet. Disconnect all cables from the rear of the unit(s).

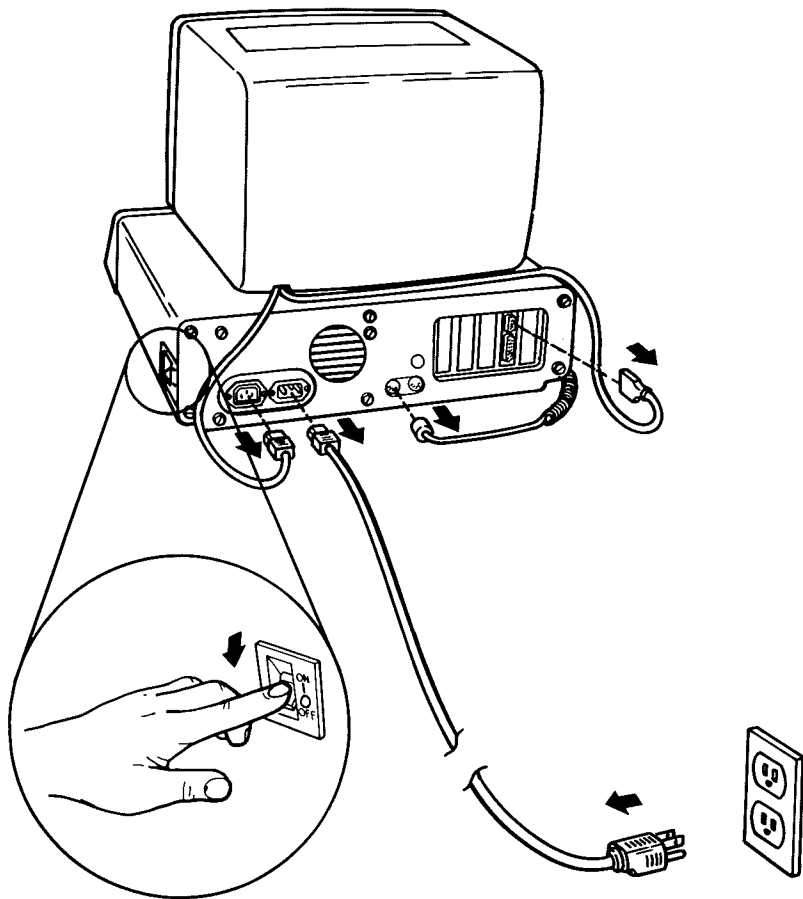

9. Coil the cables to protect the connectors.

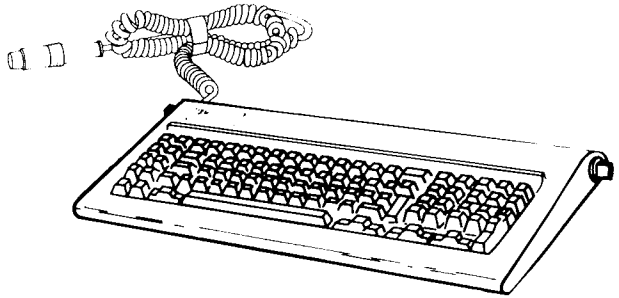

10. Tape coiled cables to system unit (and expansion unit) so the unit(s) may be carried safely. (IBM recommends filament or masking tape.)

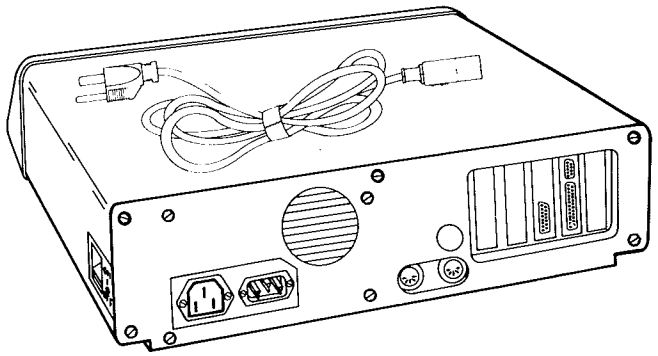

Short Distance Relocate

By short distance, we mean any distance where trucking is not involved. For example, moving from one office or floor to another. We recommend each unit be moved separately.

Note: A second person may be helpful (doors, stairs, etc.).

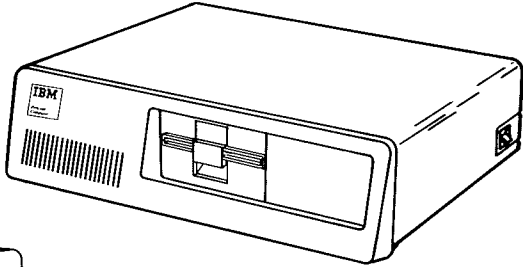

System Unit

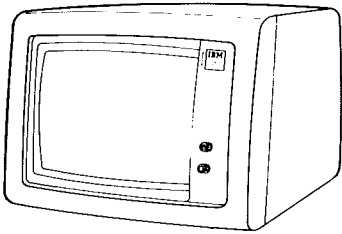

IBM Monochrome Display

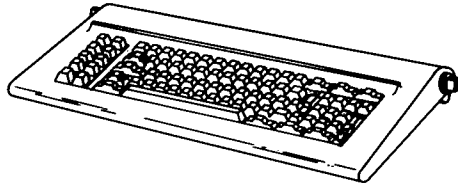

Keyboard

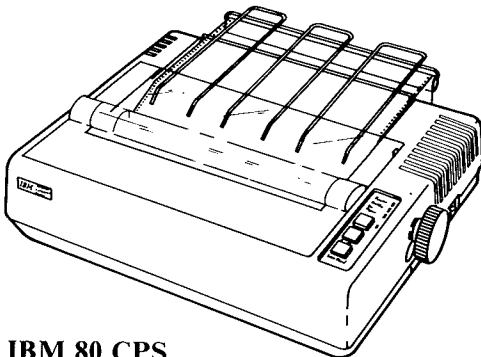

**IBM 80 CPS
Matrix/Graphics Printer**

Long Distance Relocate for System and Expansion Unit(s)

If you have saved the original cartons and packing material that your IBM Personal Computer units were shipped in, use them to pack your units.

If you are using different cartons, cushion well to avoid damage.

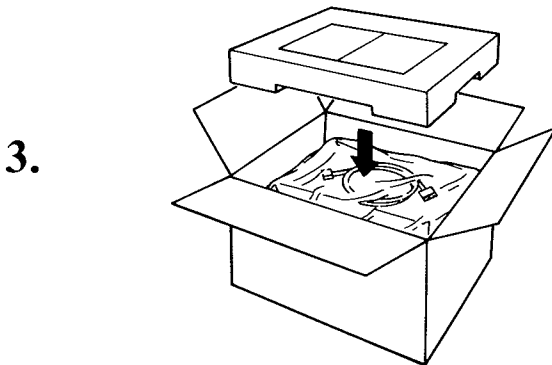
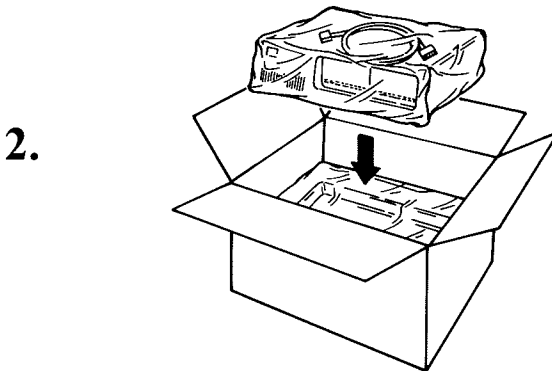
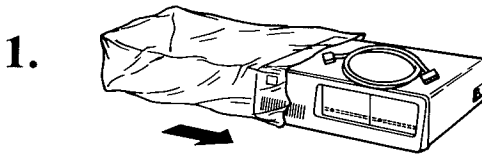

Long Distance Relocate for Keyboard

If you have saved the original cartons and packing material that your IBM Personal Computer units were shipped in, use them to pack your units.

If you are using different cartons, cushion well to avoid damage.

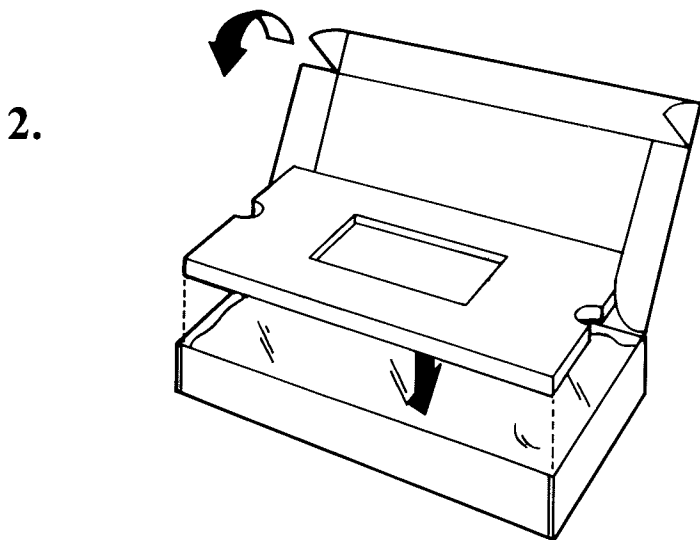
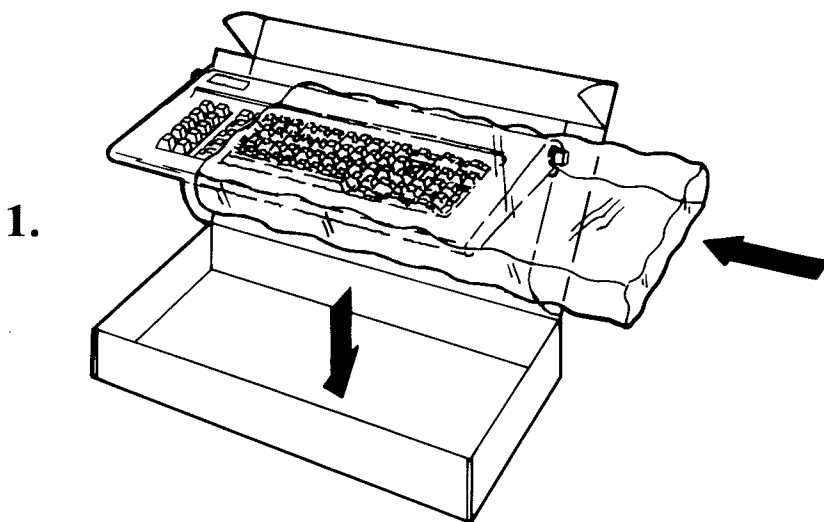

Long Distance Relocate for IBM Monochrome or Color Display

If you have saved the original cartons and packing material that your IBM Personal Computer units were shipped in, use them to pack your units.

If you are using different cartons, cushion well to avoid damage.

1.

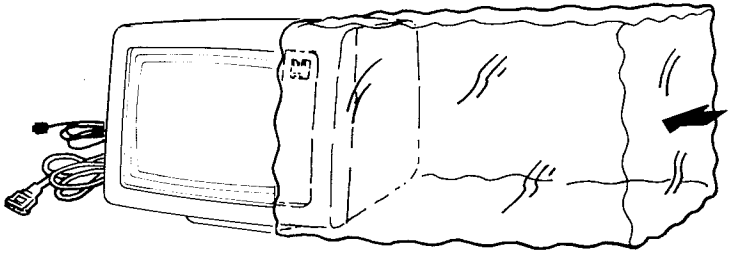

2.

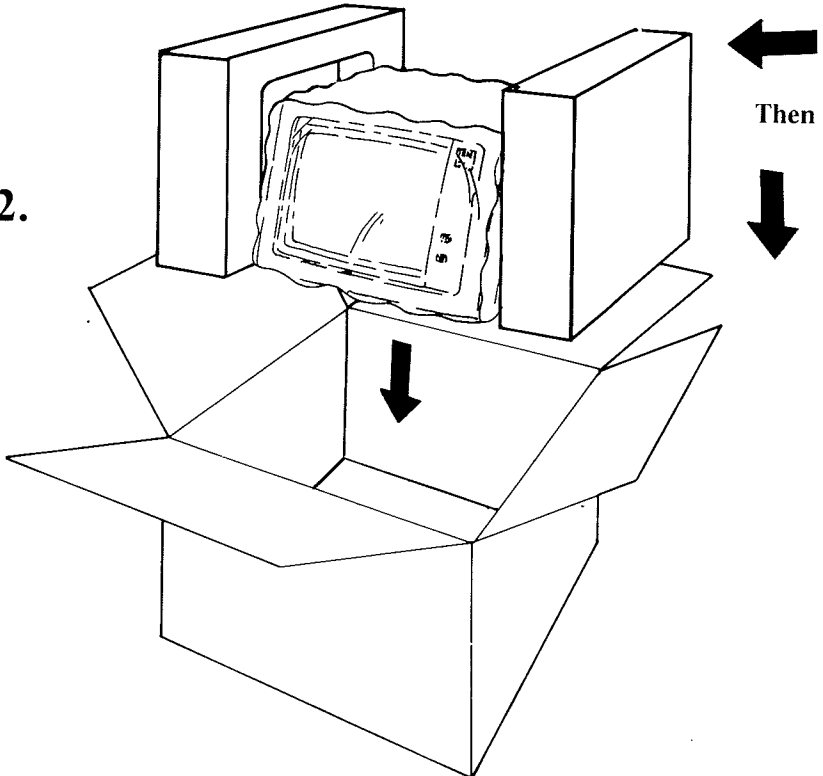

Long Distance Relocate for IBM 80 CPS Matrix/Graphics Printer

If you have saved the original cartons and packing material that your IBM Personal Computer units were shipped in, use them to pack your units.

If you are using different cartons, cushion well to avoid damage.

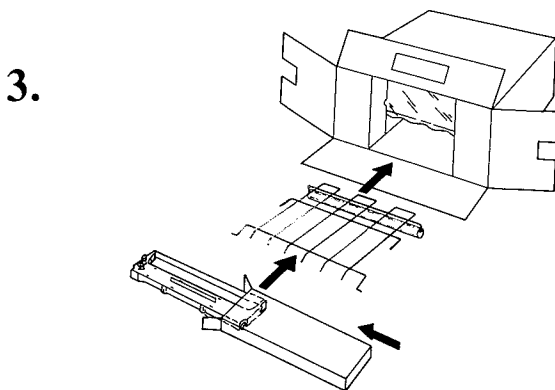
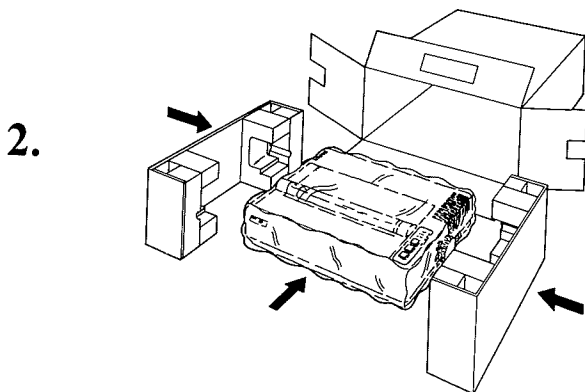
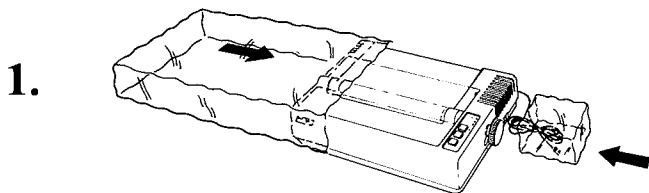

Setup At New Location

When your system arrives at the new location, carefully unpack the system.

For setting up and cabling your IBM Personal Computer, refer to "Setup," Section 2 of this manual.

Notes:

GLOSSARY

ASCII: American Standard Code for Information Interchange. The standard code using a coded character set consisting of 7-bit coded characters (8 bits including parity check), used for information interchange among data processing systems, data communications systems and associated equipment. The ASCII set consists of control characters and graphic characters.

BASIC: Beginner's All-purpose Symbolic Instruction Code. A programming language which uses common English words.

backup: Duplicating data from a fixed disk drive or diskette to a diskette which ensures availability of data in the event of loss or damage to the original.

CPS: Characters per second. Used to measure the printing speed of a printer.

cursor: A bar of light that indicates where data entered from the keyboard will appear on the display.

data: All information entered into or used by the computer.

diskette: A storage device consisting of a flexible magnetic disk inside a protective plastic jacket.

diskette drive: A device which uses diskettes for mass storage and retrieval of data.

DOS: Disk Operating System. A program which interacts with the processor and the disk or diskette drive to control the flow of data.

echo: A DOS function that sends data to be displayed to the printer as well as the screen.

fixed disk: A disk of rigid material with a magnetic coating, used for mass storage and retrieval of data.

formatting: The preparation of a disk or diskette for use by the computer.

formatted disk/diskette: A disk/diskette which can be used by the computer for the storage of data.

joy stick: A user supplied device that connects to the Game Control Adapter.

KB: Kilobyte. A kilobyte equals 1024 bytes of information.

MB: Megabyte. A megabyte equals 1,048,576 bytes of information.

modem: A device that allows information to be exchanged between computers, using telephone lines.

operating system: A program that supervises the execution of user programs by the computer.

POST: Power-On Self Test. A series of diagnostics which are executed each time the IBM Personal Computer's power is turned on.

prototype card: A blank circuit card which can be used to create custom adapters.

SDLC: Synchronous Data Link Control.

typematic: Keyboard buttons that will repeat when held depressed.

INDEX

A

- adding a statement
 BASIC 3-29
- adjustments
 - IBM Color Display
 - brightness Displays 3-3
 - contrast Displays 3-3
 - vertical hold Displays 3-5
 - vertical size Displays 3-6
 - IBM Monochrome Display
 - brightness Displays 3-1
 - contrast Displays 3-1
 - IBM Printers
 - forms thickness
 - Printers 3-14
 - left margin Printers 3-15
 - top of page setting
 - Printers 3-13
 - tractor assembly
 - Printers 3-11
 - keyboard
 - tilt position Setup 2-12
 - screen alignment Setup 2-19
- alternate key Keyboard 3-3
- art (*see* SAMPLES program)
- ASCII codes Printers 3-32
- Asynchronous Communications
 - communications menu
 - BASIC 3-17
 - description of
 - communications program
 - BASIC 3-18
 - Dow Jones/News Retrieval
 - BASIC 3-18
 - end communication program
 - BASIC 3-19
 - option examples
 - Introduction 1-6

- running the communication
 - program BASIC 3-16
- Series/1 communication
 - BASIC 3-18
- The Source BASIC 3-19

B

- backspace key Keyboard 3-3
- ball (*see* SAMPLES program)
- BASIC
 - adding a statement
 - BASIC 3-29
 - Advanced BASIC
 - BASIC 3-6
 - BASIC commands with
 - DOS counterparts
 - BASIC 3-9
 - BASIC prompt BASIC 3-7
 - cassette BASIC BASIC 3-5
 - changing BASIC programs
 - BASIC 3-25
 - COMM program
 - BASIC 3-16
 - communication program
 - BASIC 3-16
 - DOS, returning to
 - BASIC 3-9
 - EDIT command
 - BASIC 3-28
 - entering BASIC programs
 - BASIC 3-23
 - Files command BASIC 3-21
 - introduction BASIC 3-3
 - KILL command BASIC 3-9
 - LIST command
 - BASIC 3-26

- NAME command
 - BASIC 3-9
- remove a statement
 - BASIC 3-30
- returning to DOS
 - BASIC 3-9
- retyping a statement
 - BASIC 3-27
- running a BASIC program
 - BASIC 3-11
- running BASIC on another diskette with 1 drive
 - BASIC 3-20
- running BASIC on another diskette with 2 drives
 - BASIC 3-21
- running the communications program
 - BASIC 3-16
- running the SAMPLES program
 - BASIC 3-12
- screen alignment
 - BASIC 3-8
- startup screen
 - BASIC 3-7
- starting Advanced BASIC
 - BASIC 3-6
- starting BASIC
 - BASIC 3-5
- starting Cassette BASIC
 - BASIC 3-5
- starting Disk BASIC
 - BASIC 3-6
- stopping BASIC program
 - (see break)
- storing BASIC programs
 - BASIC 3-25
- break
 - Keyboard 3-8
- brightness control
 - color display Displays 3-3
 - monochrome display Displays 3-1
- byte
 - DOS 3-22
- cap lock key
 - Keyboard 3-7
- cartridge ribbon installation
 - Printers 3-5
- cassette
 - BASIC BASIC 3-3
 - diagnostics Problem Determination 4-1
 - file names BASIC 3-21
 - loading diagnostics Problem Determination 4-1
 - starting cassette BASIC BASIC 3-5
- character charts
 - Printers 3-32
- checking electrical connection
 - Problem Determination 4-1
- CHKDSK command
 - DOS 3-45
- circle (see SAMPLES program)
- color (see SAMPLES program)
- color display
 - controls Displays 3-3
 - moving Relocate 6-11
 - vertical hold adjustment Displays 3-5
 - vertical size adjustment Displays 3-6
- commands
 - CHKDSK DOS 3-45
 - COMP DOS 3-45
 - COPY DOS 3-64
 - DATE DOS 3-45
 - DIR DOS 3-53
 - DISKCOMP DOS 3-46
 - DISKCOPY DOS 3-57
 - EDIT BASIC 3-28
 - ERASE DOS 3-78
 - FILES BASIC 3-21
 - FORMAT DOS 3-48
 - KILL BASIC 3-9
 - LIST BASIC 3-26
 - MODE DOS 3-81
 - NAME BASIC 3-9
 - RENAME DOS 3-75
 - SYS DOS 3-46
 - TIME DOS 3-46
 - TYPE DOS 3-73

C

- cabling, system Setup 2-3
- calendar (see SAMPLES program)

- communication program
 - description BASIC 3-18
 - Dow Jones/News Retrieval BASIC 3-18
 - IBM Personal Computer BASIC 3-18
 - Series/1 BASIC 3-18
 - The Source BASIC 3-19
 - other services BASIC 3-19
- COMP command DOS 3-45
- contrast control
 - color display Displays 3-3
 - monochrome display Displays 3-1
- control codes Printers 3-19
- control key Keyboard 3-3
- controls
 - color display Displays 3-3
 - cursor down Keyboard 3-6
 - cursor left Keyboard 3-6
 - cursor right Keyboard 3-6
 - cursor up Keyboard 3-6
 - monochrome display Displays 3-1
 - printer Printers 3-4
- COPY command DOS 3-64
- cursor control keys Keyboard 3-6

D

- DATE command DOS 3-45
- default drive DOS 3-13
- delete key Keyboard 3-6
- diagnostics Problem Determination 4-1
- disk (*see* diskette)
- DIR command DOS 3-53
- DISKCOMP command DOS 3-46
- DISKCOPY command DOS 3-57

- diskette
 - care of diskettes DOS 3-24
 - description DOS 3-22
 - diskette in-use light Setup 2-18
 - diskette operating system (*see* DOS)
 - loading Setup 2-18
 - preparing for use (*see* FORMAT command)
 - write-protect notch DOS 3-25
- displays
 - IBM Color Display Displays 3-5
 - IBM Monochrome Display Displays 3-1
- donkey (*see* SAMPLES program)
- DOS (Disk Operating System)
 - backing up DOS with one drive DOS 3-27
 - backing up DOS with two drives DOS 3-31
 - backing up one file DOS 3-64
 - controlling DOS DOS 3-14
 - COPY command DOS 3-64
 - copying file with one drive DOS 3-67
 - copying file with two drives DOS 3-71
 - DATE command DOS 3-45
 - default drive DOS 3-13
 - DIR command DOS 3-53
 - DISKCOPY command DOS 3-57
 - DOS diskette files DOS 3-44
 - DOS function keys Keyboard 3-10
 - DOS prompt DOS 3-11
 - echo DOS 3-20

ERASE command
 DOS 3-78
file specifications
 DOS 3-38
files and filenames
 DOS 3-35
FORMAT command
 DOS 3-48
formatting several diskettes
 DOS 3-51
global filename characters
 DOS 3-39
introduction to DOS
 DOS 3-3
MODE command DOS 3-81
print as you type (*see* echo)
print screen DOS 3-19
RENAME command
 DOS 3-75
screen alignment DOS 3-81
starting DOS DOS 3-5
stopping a DOS command
 DOS 3-17
stopping screen DOS 3-19
summary of commands
 DOS 3-45
SYS command DOS 3-46
TIME command DOS 3-46
TYPE command DOS 3-73

E

echo Keyboard 3-11,
 DOS 3-20, DOS 3-73
end key Keyboard 3-6
enter key Keyboard 3-3
ERASE command DOS 3-78
escape key Keyboard 3-3

examples
 error message Problem
 Determination 4-1
 errors Problem
 Determination 4-1
 printer printout
 Printers 3-17
expansion unit Setup 2-9
 moving Relocate 6-3, 6-9
 problem determination
 Problem Determination 4-1

F

files DOS 3-35
file specifications DOS 3-38
FILES command DOS 3-21
filenames DOS 3-35
 global DOS 3-39
form feed Printers 3-4
FORMAT command
 DOS 3-48
forms loading Printers 3-8
forms rack Printers 3-9
function keys Keyboard 3-4

G

global filenames DOS 3-39
graphic printer (*see* printer)

H

home key Keyboard 3-6
how to
 cable system unit Setup 2-3
 determine problem
 Problem Determination 4-1

- install system unit Setup 2-3
- list installed Problem Determination 4-1
- load BASIC BASIC 3-5
- load BASICA BASIC 3-6
- load Disk BASIC BASIC 3-6

I

- insert key Keyboard 3-6
- installations
 - devices, options, and memory Options 5-1
 - Personal Computer Setup 2-3
 - print forms Printers 3-8
 - print ribbon cartridge Printers 3-5
- intensity control (*see* brightness)
- introduction Introduction 1-3
- isolating problem Problem Determination 4-1

K

- keyboard
 - adjustment Setup 2-12
 - BASIC usage Keyboard 3-2
 - DOS usage Keyboard 3-9
 - installation Setup 2-4
 - moving Relocate 6-10
- keys
 - alternate Keyboard 3-3
 - backspace Keyboard 3-3
 - cap lock Keyboard 3-7
 - control key Keyboard 3-3
 - cursor controls Keyboard 3-6
 - delete Keyboard 3-6
 - enter Keyboard 3-3
 - escape Keyboard 3-3
 - function Keyboard 3-4

- insert Keyboard 3-6
- minus Keyboard 3-5
- number lock Keyboard 3-5
- numeric keypad Keyboard 3-5
- plus Keyboard 3-5
- print screen Keyboard 3-7
- scroll lock Keyboard 3-7
- shift Keyboard 3-3
- spacebar Keyboard 3-2
- tab Keyboard 3-3
- typewriter area Keyboard 3-1

- KILL command BASIC 3-9
- knob roller Printers 3-12

L

- least significant bit (LSB) Printers 3-28
- left margin adjustment Printers 3-15
- levers
 - diskette load Setup 2-18
 - forms thickness control Printers 3-14
 - tractor lock Printers 3-11
- lights
 - color display (power on) Displays 3-3
 - diskette (in-use) Setup 2-18
 - printer Printers 3-3
- line feed Printers 3-4
- LIST command BASIC 3-26
- load
 - Diagnostics cassette Setup 2-20, Problem Determination 4-1
 - Diagnostics diskette Setup 2-18, Problem Determination 4-1
- loading forms Printers 3-8

M

- matrix printer (*see* printer)
- minus key Keyboard 3-5
- MODE command DOS 3-81
- modes Printers 3-18
- monochrome display
 - moving Relocate 6-11
 - operating Displays 3-1
- mortgage (*see* SAMPLES program)
- most significant bit (MSB) Printers 3-28
- moving
 - color display Relocate 6-11
 - expansion unit Relocate 6-3
 - keyboard Relocate 6-10
 - monochrome display Relocate 6-11
 - printers Relocate 6-12
 - system unit Relocate 6-9
- music (*see* SAMPLES program)

N

- NAME command BASIC 3-9
- no paper light Printers 3-3
- number lock key Keyboard 3-5
- numeric keypad Keyboard 3-5

O

- on/line light Printers 3-3
- On/Off switch
 - color display Displays 3-2
 - printers Printers 3-1
 - system unit Setup 2-5
- option examples
 - asynchronous communications Introduction 1-7
 - color display Introduction 1-7

- Color/Graphics Monitor Adapter Introduction 1-6
- diskette drive
 - Introduction 1-5
- expansion unit
 - Introduction 1-6
- monochrome display
 - Introduction 1-6
- printers Introduction 1-6
- printer adapter
 - Introduction 1-6
- prototype card
 - Introduction 1-7

P

- piechart (*see* SAMPLES program)
- plus key Keyboard 3-5
- power On/Off
 - color display Displays 3-2
 - printer Printer 3-1
 - system unit Setup 2-5
- Power-On Self Test (POST)
 - printer Printers 3-16
 - system unit Setup 2-7
- print screen key Keyboard 3-7
- printer
 - ASCII codes Printers 3-32
 - character chart Printers 3-32
 - control buttons Printers 3-4
 - control codes Printers 3-19
 - form feed button Printers 3-4
 - forms loading Printers 3-8
 - forms rack Printers 3-9
 - forms thickness control lever Printers 3-14
 - graphics codes Printers 3-34
 - left margin adjustment Printers 3-15
 - lights Printers 3-3
 - Line Feed button Printers 3-4

moving Relocate 6-12
No Paper light Printers 3-3
On Line button Printers 3-4
On Line light Printers 3-3
Power light Printers 3-3
power switch Printers 3-2
print modes Printers 3-18
print scale Printers 3-9
printout samples
 Printers 3-17
Ready light Printers 3-3
relocate Relocate 6-12
ribbon cartridge installation
 Printers 3-5
roller knob Printers 3-12
self test Printers 3-16
top of page setting
 Printers 3-13
tractor Printers 3-11
tractor lock lever
 Printers 3-11
problem determination
procedures Problem
Determination 4-1

R

ready light Printers 3-3
relocate
 color display Relocate 6-11
 expansion unit
 Relocate 6-3, 6-9
 keyboard Relocate 6-10
 monochrome display
 Relocate 6-11
 printers Relocate 6-12
 system unit Relocate 6-9
return to DOS BASIC 3-9

S

SAMPLES program
 BASIC 3-12
scratch diskette Problem
 Determination 4-1
screen alignment Setup 2-21
scroll lock key Keyboard 3-7
sectors DOS 3-22
self test, printers Printers 3-16
service information Problem
 Determination 4-1
shift key Keyboard 3-3
space (*see* SAMPLES program)
spacebar Keyboard 3-2
starting
 Advanced BASIC
 BASIC 3-6
 Cassette BASIC
 BASIC 3-5
 Disk BASIC BASIC 3-6
 DOS DOS 3-5
summary of DOS command
 DOS 3-45
SYS command DOS 3-46
system cabling Setup 2-3
system unit Setup 2-3
 moving Relocate 6-9
 problem determination
 Problem Determination 4-1

T

tab key Keyboard 3-3
TIME command DOS 3-46
top of page setting
 Printers 3-13
track diskette DOS 3-22
tractor Printers 3-11
tractor lock lever Printers 3-11
TYPE command DOS 3-73
tpestyles Printers 3-18
typewriter area Keyboard 3-2

U

units

expansion unit Setup 2-9

system unit Setup 2-3

V

vertical hold adjustment

Displays 3-5

vertical size adjustment

Displays 3-6

W

wrap plug Problem

Determination 4-1

communication Problem

Determination 4-1

write-protect notch DOS 3-25



Readers Comment Form

GUIDE TO OPERATIONS

1525818

Your comments assist us in improving the usefulness of our publication; they are an important part of the input used for revisions.

IBM may use and distribute any of the information you supply in any way it believes appropriate without incurring any obligation whatever. You may, of course, continue to use the information you supply.

Please do not use this form for technical questions regarding the IBM Personal Computer or programs for the IBM Personal Computer, or for requests for additional publications; this only delays the response. Instead, direct your inquiries or requests to your authorized IBM Personal Computer dealer.

Comments:

Tape

Please do not staple

Tape

Fold here

IBM PERSONAL COMPUTER
SALES & SERVICE
P.O. BOX 1328-C
BOCA RATON, FLORIDA 33432

POSTAGE WILL BE PAID BY ADDRESSEE

BUSINESS REPLY MAIL
FIRST CLASS PERMIT NO. 321 BOCA RATON, FLORIDA 33432



NO POSTAGE
NECESSARY
IF MAILED
IN THE
UNITED STATES

