

ASUS[®] P5S-B
Super7 Baby AT Motherboard

USER'S MANUAL

USER'S NOTICE

No part of this manual, including the products and software described in it, may be reproduced, transmitted, transcribed, stored in a retrieval system, or translated into any language in any form or by any means, except documentation kept by the purchaser for backup purposes, without the express written permission of ASUSTeK COMPUTER INC. ("ASUS").

ASUS PROVIDES THIS MANUAL "AS IS" WITHOUT WARRANTY OF ANY KIND, EITHER EXPRESS OR IMPLIED, INCLUDING BUT NOT LIMITED TO THE IMPLIED WARRANTIES OR CONDITIONS OF MERCHANTABILITY OR FITNESS FOR A PARTICULAR PURPOSE. IN NO EVENT SHALL ASUS, ITS DIRECTORS, OFFICERS, EMPLOYEES OR AGENTS BE LIABLE FOR ANY INDIRECT, SPECIAL, INCIDENTAL, OR CONSEQUENTIAL DAMAGES (INCLUDING DAMAGES FOR LOSS OF PROFITS, LOSS OF BUSINESS, LOSS OF USE OR DATA, INTERRUPTION OF BUSINESS AND THE LIKE), EVEN IF ASUS HAS BEEN ADVISED OF THE POSSIBILITY OF SUCH DAMAGES ARISING FROM ANY DEFECT OR ERROR IN THIS MANUAL OR PRODUCT.

Product warranty or service will not be extended if: (1) the product is repaired, modified or altered, unless such repair, modification or alteration is authorized in writing by ASUS; or (2) the serial number of the product is defaced or missing.

Products and corporate names appearing in this manual may or may not be registered trademarks or copyrights of their respective companies, and are used only for identification or explanation and to the owners' benefit, without intent to infringe.

- SiS is a trademark of Silicon Integrated Systems Corp.
- Adobe and Acrobat are registered trademarks of Adobe Systems Incorporated.
- Sound Blaster is a registered trademark of Creative Technology Ltd.
- Intel, LANDesk, and Pentium are registered trademarks of Intel Corporation.
- Symbios is a registered trademark of Symbios Logic Corporation.
- Windows and MS-DOS are registered trademarks of Microsoft Corporation.

The product name and revision number are both printed on the product itself. Manual revisions are released for each product design represented by the digit before and after the period of the manual revision number. Manual updates are represented by the third digit in the manual revision number.

For previous or updated manuals, BIOS, drivers, or product release information, contact ASUS at <http://www.asus.com.tw> or through any of the means indicated on the following page.

SPECIFICATIONS AND INFORMATION CONTAINED IN THIS MANUAL ARE FURNISHED FOR INFORMATIONAL USE ONLY, AND ARE SUBJECT TO CHANGE AT ANY TIME WITHOUT NOTICE, AND SHOULD NOT BE CONSTRUED AS A COMMITMENT BY ASUS. ASUS ASSUMES NO RESPONSIBILITY OR LIABILITY FOR ANY ERRORS OR INACCURACIES THAT MAY APPEAR IN THIS MANUAL, INCLUDING THE PRODUCTS AND SOFTWARE DESCRIBED IN IT.

Copyright © 1999 ASUSTeK COMPUTER INC. All Rights Reserved.

Product Name:	ASUS P5S-B
Manual Revision:	1.01 E364
Release Date:	April 1999

ASUS CONTACT INFORMATION

ASUSTeK COMPUTER INC. (Asia-Pacific)

Marketing

Address: 150 Li-Te Road, Peitou, Taipei, Taiwan 112
Telephone: +886-2-2894-3447
Fax: +886-2-2894-3449
Email: info@asus.com.tw

Technical Support

Tel (English): +886-2-2894-3447 ext. 706
Tel (Chinese): +886-2-2894-3447 ext. 111
Fax: +886-2-2895-9254
Email: tsd@asus.com.tw
Newsgroup: news2.asus.com.tw
WWW: www.asus.com.tw
FTP: ftp.asus.com.tw/pub/ASUS

ASUS COMPUTER INTERNATIONAL (America)

Marketing

Address: 6737 Mowry Avenue, Mowry Business Center, Building 2
Newark, CA 94560, USA
Fax: +1-510-608-4555
Email: info-usa@asus.com.tw

Technical Support

Fax: +1-510-608-4555
BBS: +1-510-739-3774
Email: tsd-usa@asus.com.tw
WWW: www.asus.com
FTP: ftp.asus.com.tw/pub/ASUS

ASUS COMPUTER GmbH (Europe)

Marketing

Address: Harkort Str. 25, 40880 Ratingen, BRD, Germany
Telephone: 49-2102-445011
Fax: 49-2102-442066
Email: sales@asuscom.de

Technical Support

Hotline: 49-2102-499712
BBS: 49-2102-448690
Email: tsd@asuscom.de
WWW: www.asuscom.de
FTP: ftp.asuscom.de/pub/ASUSCOM

CONTENTS

I. INTRODUCTION	7
How this Manual is Organized	7
Item Checklist	7
II. FEATURES	8
ASUS P5S-B Motherboard	8
Parts of the ASUS P5S-B Motherboard	11
III. HARDWARE SETUP	12
ASUS P5S-B Motherboard Layout	12
Hardware Setup Steps	15
1. Motherboard Settings	15
Compatible Cyrix CPU Identification	23
2. System Memory (DIMM)	25
DIMM Memory Installation Procedures:	26
3. Central Processing Unit (CPU)	27
4. Expansion Cards	29
Expansion Card Installation Procedure:	29
Assigning IRQs for Expansion Cards	29
Assigning DMA Channels for ISA Cards	30
ISA Cards and Hardware Monitor	30
5. External Connectors	31
Power Connection Procedures	43
Flash Memory Writer Utility	44
IV. BIOS SETUP	44
Main Menu	44
Managing and Updating Your Motherboard's BIOS	46
6. BIOS Setup	47
Load Defaults	48
Standard CMOS Setup	48
Details of Standard CMOS Setup	48
BIOS Features Setup	51
Details of BIOS Features Setup	51
Chipset Features Setup	54
Details of Chipset Features Setup	54
Power Management Setup	57
Details of Power Management Setup	57
PNP and PCI Setup	60
Details of PNP and PCI Setup	60

CONTENTS

Load BIOS Defaults	62
Load Setup Defaults	62
Supervisor Password and User Password	63
IDE HDD Auto Detection	64
Save & Exit Setup	65
Exit Without Saving	65
V. SOFTWARE SETUP	69
Operating Systems	69
Windows 98 First Time Installation	69
P5S-B Support CD	70
Installation Menu	70
Install ASUS PC Probe Vx.xx	71
Install VGA Driver	72
Install Audio Driver (only with onboard audio option)	73
Install ESS AudioRack32 (only with onboard audio option)	74
Install ESS Software Wave Table (only with onboard audio option)	75
Install PC-Cillin 98 Vx.xx	76
Install ADOBE AcroBat Reader Vx.x	77
Install Bus Master IDE Driver	78
Uninstalling Programs	79
VI. SOFTWARE REFERENCE	81
ASUS PC Probe	83
SiS 530 Display Properties	88
AudioRack32	91
Desktop Management Interface (DMI)	100
VII. APPENDIX	103
The ASUS PCI-L101 Fast Ethernet Card	103

FCC & DOC COMPLIANCE

Federal Communications Commission Statement

This device complies with FCC Rules Part 15. Operation is subject to the following two conditions:

- This device may not cause harmful interference, and
- This device must accept any interference received, including interference that may cause undesired operation.

This equipment has been tested and found to comply with the limits for a Class B digital device, pursuant to Part 15 of the FCC Rules. These limits are designed to provide reasonable protection against harmful interference in a residential installation. This equipment generates, uses and can radiate radio frequency energy and, if not installed and used in accordance with manufacturer's instructions, may cause harmful interference to radio communications. However, there is no guarantee that interference will not occur in a particular installation. If this equipment does cause harmful interference to radio or television reception, which can be determined by turning the equipment off and on, the user is encouraged to try to correct the interference by one or more of the following measures:

- Re-orient or relocate the receiving antenna.
- Increase the separation between the equipment and receiver.
- Connect the equipment to an outlet on a circuit different from that to which the receiver is connected.
- Consult the dealer or an experienced radio/TV technician for help.

WARNING! Any changes or modifications to this product not expressly approved by the manufacturer could void any assurances of safety or performance and could result in violation of Part 15 of the FCC Rules.

Canadian Department of Communications Statement

This digital apparatus does not exceed the Class B limits for radio noise emissions from digital apparatus set out in the Radio Interference Regulations of the Canadian Department of Communications.

I. INTRODUCTION

How this Manual is Organized

I. Introduction	Manual information and checklist
II. Features	Information on motherboard features
III. Installation	Instructions on motherboard/jumper setup
IV. BIOS Setup	Instructions on BIOS software setup
V. Software Setup	Information on the included support software
VI. Software Reference	References for the included support software
VII. Appendix	Optional items and reference

Item Checklist

Check that your package is complete. If you discover damaged or missing items, contact your retailer.

- (1) ASUS Motherboard
- (1) Ribbon cable for master and slave IDE drives
- (1) Ribbon cable for (1) 5.25" and (2) 3.5" floppy disk drives
- (1) Ribbon cable for VGA with mounting bracket
- (1) Connector set for PS/2 mouse and parallel port
- (1) Connector set for serial ports
- (1) Bag of spare jumpers
- (1) Support CD with drivers and utilities
- (1) Motherboard User's manual

- Connector set for LCD (with LCD chip onboard)
- Connector set for audio input/output and game/MIDI port (with audio chip onboard)

- ASUS IrDA-compliant module (optional)
- ASUS PCI-L101 Wake-On-LAN 10/100 ethernet card (optional)

II. FEATURES

ASUS P5S-B Motherboard

The ASUS P5S-B is carefully designed for the demanding PC user who wants advanced features in a small package.

Specifications

- **SiS AGPset:** SiS[®] (Silicon Integrated Systems Corp.) 530 AGPset with support for a 100MHz Front Side Bus (FSB), all current Socket 7 processors and integrated Super AGP 2X 2D/3D VGA controller for high performance hardware 2D/3D VGA acceleration.
- **Multi-Processor/Multi-Speed Support:** AMD[®] K6[®]-2/266 & faster, AMD[®] K6[®]/166 & faster, AMD[®] K5[™]/100–133, IBM[®]/Cyrix[®] 6x86MX[™]/M II[™] (PR166 & faster), IBM[®]/Cyrix[®] 6x86-PR166+ (Rev 2.7 or later), Intel[®] Pentium[®] 100–233MHz (P55C-MMX[™], P54C/P54CS).
- **Multi-Cache:** Features 512KB/1MB (when chip is available) pipelined-burst SRAM/L2 memory cache and integrated Tag RAM to make using the 100MHz bus speed possible.
- **PC100 Memory Support:** Equipped with three DIMM sockets to support Intel PC100-compliant SDRAMs (8, 16, 32, 64, 128, or 256MB) up to 768MB. These new SDRAMs are necessary to meet the enhanced 95MHz/100MHz bus speed requirement.
- **AGP 2X VGA Onboard:** SiS 530 built-in 2D/3D AGP VGA (on AGPset) with capability to use shared system memory or optional 8MB SDRAM as local graphics memory.
- **Peripheral Wake Up:** Supports modem wake up, keyboard wake up, and LAN card wake up functions from sleep or soft-off mode.
- **Onboard Audio (optional):** Provides ESS[®] Solo-1 PCI audio chipset with 3D surround and positioning capability and audio CODEC that conforms to AC'97 analog component specifications. Includes complete online software guide.
- **PC Health Monitoring:** Provides an easier and convenient way to examine and manage system status information, such as CPU and system voltages, temperatures, and fan status through the onboard PCIset (South Bridge) and the bundled PC Probe from ASUS.
- **UltraDMA/66 BM IDE:** Comes with an onboard PCI Bus Master IDE controller with two connectors that support four IDE devices in two channels, supports UltraDMA/66, UltraDMA/33, PIO Modes 3/4 and Bus Master IDE DMA Mode 2, and supports Enhanced IDE devices, such as Tape Backup, CD-ROM, CD-R, CD-RW, and LS-120 drives.
- **Wake-On-LAN:** Supports Wake-On-LAN activity through an optional ASUS PCI-L101 10/100 Fast Ethernet PCI card (see **APPENDIX**) or a similar ethernet card.
- **Multi-I/O:** Provides two high-speed UART compatible serial ports and one parallel port with EPP and ECP capabilities. UART2 can also be directed from COM2 (with SIR) to the Infrared Module for wireless connections.
- **USB:** Supports the Universal Serial Bus standard through the onboard connectors for multi-device connections.
- **IrDA:** Supports an optional infrared port module for a wireless interface.
- **Digital Flat Panel Interface:** Provides an optional direct connection for connecting a digital flat panel to your PC.

II. FEATURES

Special Features

- **Enhanced ACPI and Anti-Boot Virus BIOS:** Features a programmable BIOS, offering enhanced ACPI for Windows 98 compatibility, built-in firmware-based virus protection through Trend ChipAway Virus codes, and autodetection of most devices for virtually automatic setup.
- **Desktop Management Interface (DMI):** Supports DMI through BIOS, which allows hardware to communicate within a standard protocol creating a higher level of compatibility. (Requires DMI-enabled components.) (See **SOFTWARE REFERENCE**.)
- **Easy Installation:** Incorporates BIOS that supports autodetection of hard disk drives, PS/2 mouse, and Plug and Play devices to make the setup of hard disk drives, expansion cards, and other devices virtually automatic.
- **PC'98 Compliant:** Both the BIOS and hardware levels of this motherboard meet PC'98 compliancy. The new PC'98 requirements for systems and components are based on the following high-level goals: Support for Plug and Play compatibility and power management for configuring and managing all system components, and 32-bit device drivers and installation procedures for Windows 95/98/NT.
- **Symbios SCSI BIOS:** Supports optional ASUS SCSI controller cards or other Symbios SCSI cards through the onboard SYMBIOS firmware.

Performance Features

- **Concurrent PCI:** Concurrent PCI allows multiple PCI transfers from PCI master busses to the memory and processor.
- **High-Speed Data Transfer Interface:** This motherboard with its chipset and support for UltraDMA/66 doubles the UltraDMA/33 burst transfer rate to 66.6MB/s. UltraDMA/66 is backward compatible with both DMA/33 and DMA and with existing DMA devices and systems so there is no need to upgrade current EIDE/IDE drives and host systems. (UltraDMA/66 requires a 40-pin 80-conductor cable to be enabled and/or for UltraDMA Mode 4.)
- **SDRAM Optimized Performance:** Supports the new generation memory — Synchronous Dynamic Random Access Memory (SDRAM) — which increases the data transfer rate to 800MB/s max using PC100-compliant SDRAM.

Intelligent Features

- **Fan Status Monitoring and Alarm:** To prevent system overheat and system damage, the CPU and chassis fans are monitored for RPM and failure. Each fan can be set for its normal RPM range and alarm thresholds.
- **Temperature Monitoring and Alert:** To avoid any failures triggered by extremely high temperature, there is a heat sensor under the CPU to make sure your system is operating at a safe heat level.

II. FEATURES

- **Auto Fan Off:** The system fans will power off automatically **even in sleep mode**. This function reduces both energy consumption *and* **system noise**, and is an important feature in implementing silent PC systems.
- **Dual Function Power Button (requires ATX power supply):** Pushing the power button for less than 4 seconds when the system is in the working state places the system into one of two states: sleep mode or soft-off mode, depending on the BIOS setting (see *Power Management Setup* under **BIOS SETUP**). When the power button is pressed for more than 4 seconds, the system enters the soft-off mode regardless of the BIOS setting.
- **Keyboard Power Up:** Keyboard Power Up can be enabled or disabled to allow the computer to be powered on by pressing the keyboard's spacebar.
- **Voltage Monitoring and Alert:** System voltage levels are monitored to ensure stable current to critical motherboard components. Voltage specifications are more critical for future processors, so monitoring is necessary to ensure proper system configuration and management.
- **System Resources Alert:** Today's operating systems, such as Windows 95/98/NT and OS/2, require much more memory and hard drive space to present enormous user interfaces and run large applications. The system resource monitor will warn the user before the system resources are used up to prevent possible application crashes. Suggestions on managing the user's limited resources more efficiently are provided.
- **CPU Slow Down:** When CPU fans or system fans malfunction, the system will deactivate the CPU Clock line to decrease CPU utilization to the speed upon detection of system overheat. This will prevent CPU damage from system overheat. The CPU utilization will restore normal operations when temperature falls below a safe level.
- **Remote Ring On (requires external modem):** This feature allows a computer to be turned on remotely through an external modem. With this benefit on hand, any user can access vital information from their computer from anywhere in the world!
- **Message LED (requires ACPI-supported OS):** Turbo LEDs now act as information providers. Through the way a particular LED illuminates, the user can determine the stage the computer is in. A simple glimpse provides useful information to the user.

II. FEATURES

Parts of the ASUS P5S-B Motherboard

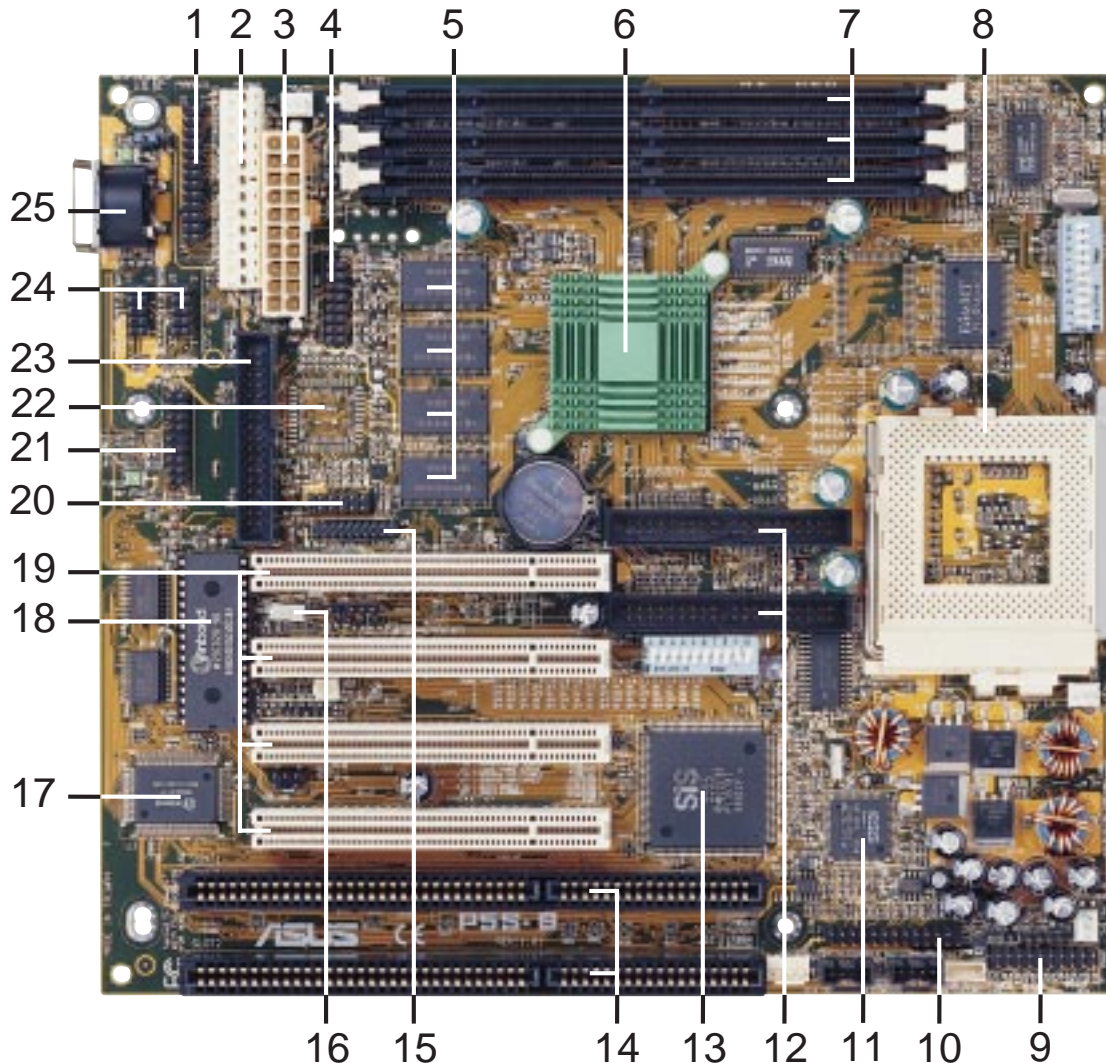

- | | |
|---|--|
| 1 Parallel Port Connector | 13 SiS Super South Bridge with Built-in Hardware Monitoring |
| 2 AT Power Connector | 14 ISA Slots |
| 3 ATX Power Connector | 15 LCD Header (with LCD chip onboard) |
| 4 VGA Header | 16 Wake-On-LAN Connector |
| 5 8MB VGA Memory (optional) | 17 Super Multi I/O Chip |
| 6 SiS AGPset with Heatsink | 18 Programmable Flash ROM (2Mbit) |
| 7 DIMM Sockets | 19 PCI Slots |
| 8 CPU ZIF Socket 7 | 20 TV Out Interface (optional) |
| 9 Panel Connectors | 21 PS/2 Mouse, USB, IR Connector |
| 10 Audio Connector (with audio chip onboard) | 22 LCD chip/TV Out chip (optional) |
| 11 PCI Audio (ESS Solo-1) (optional) | 23 Floppy Disk Drive Connector |
| 12 IDE Connectors | 24 Serial Port Connectors |
| | 25 Keyboard Connector |

III. HARDWARE SETUP

ASUS P5S-B Motherboard Layout

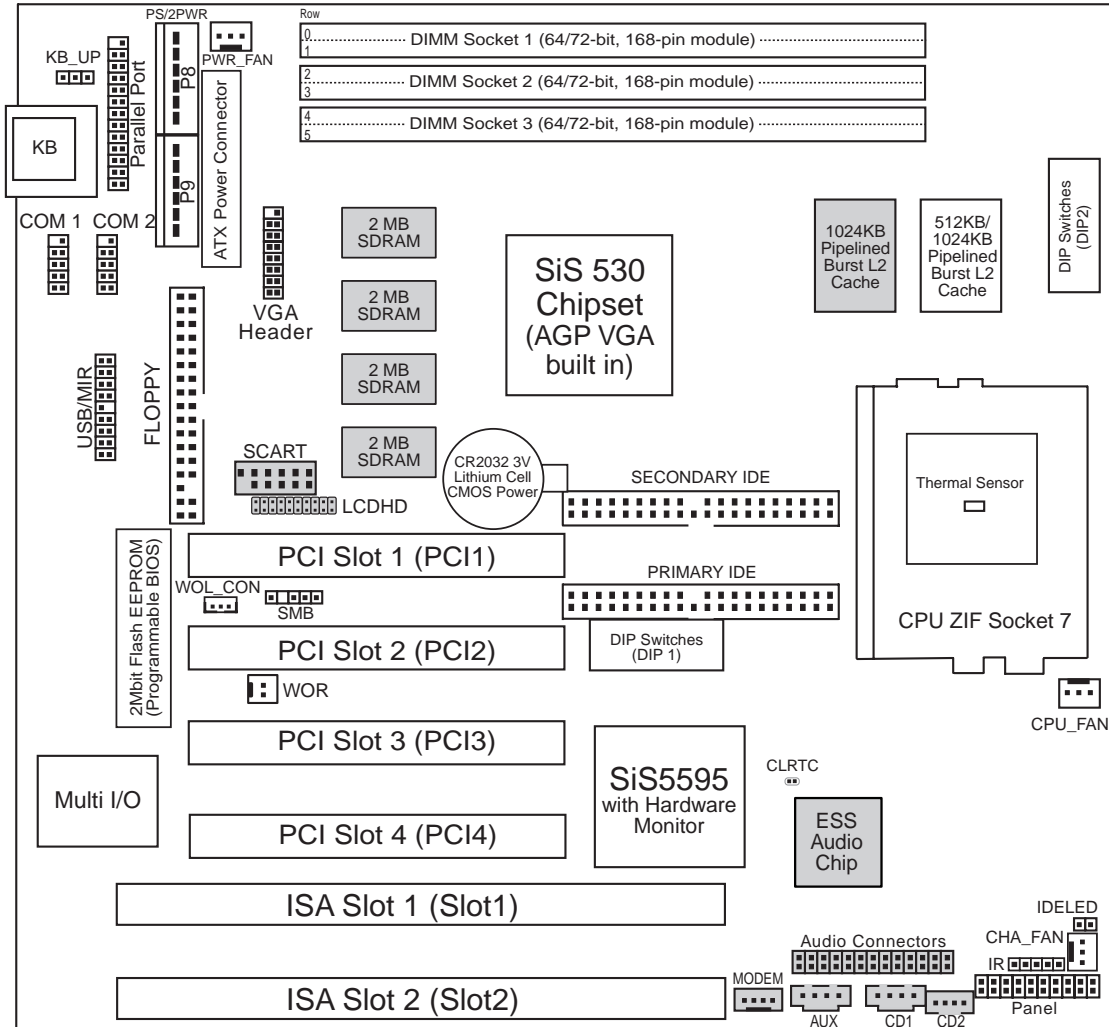

Dimmed components are optional.

III. HARDWARE SETUP

Motherboard Feature Settings

- | | |
|-------------------------------------|---|
| 1) KB_UP | p. 16 Keyboard Power (Wake) Up (Enable/Disable) |
| 2) DIP 1 – Switch 1 | p. 17 VGA Frame Buffer Setting (Shared/Local) |
| 3) DIP 1 – Switch 2 | p. 17 Onboard VGA Setting (Enable/Disable) |
| 4) DIP 1 – Switch 3 | p. 18 Onboard Audio Setting (Enable/Disable) |
| 5) DIP 1 – Switches 4, 5 | p. 18 VIO Setting |
| 6) DIP 2 – Switch 9 | p. 19 TV Out Setting (AV/RGB) |
| 7) DIP 2 – Switch 10 | p. 19 LCD Setting (Enable/Disable) |
| 8) DIP 2 – Switches 1, 2, 3, 4 | p. 20 CPU BUS Frequency Setting |
| 9) DIP 2 – Switch 5 | p. 20 Memory Transfer Mode Setting |
| 10) DIP 2 – Switches 6, 7, 8 | p. 21 CPU Core:BUS Frequency Multiple Setting |
| 11) DIP 1 – Switches 6, 7, 8, 9, 10 | p. 23 Voltage Regulator Output Selection |

Expansion Slots/Sockets

- | | |
|----------------------------|---|
| 1) DIMM Sockets | p. 25 168-Pin DIMM Memory Expansion Sockets |
| 2) CPU ZIF Socket 7 | p. 27 Central Processing Unit (CPU) Socket |
| 3) SLOT 1, SLOT 2 | p. 29 16-bit ISA Bus Expansion Slots* |
| 4) PCI 1, PCI2, PCI3, PCI4 | p. 29 32-bit PCI Bus Expansion Slots |

*The onboard hardware monitor uses the address 290H-297H so legacy ISA cards must not use this address or else conflicts will occur.

External Connectors

- | | |
|-----------------------|--|
| 1) PS2KB | p. 31 AT Keyboard Connector (5-pin Female) |
| 2) FLOPPY | p. 31 Floppy Disk Drive Connector (6-pin Female) |
| 3) PARALLEL | p. 32 Parallel Port Connector (26-1 pins) |
| 4) COM1/COM2 | p. 32 Serial Port Connectors (Two 10-1 pins) |
| 5) FAN | p. 33 Cooling Fan Connectors (3 pins) |
| 6) SMB | p. 33 SMBus Connector (5-1 pins) |
| 7) PRIMARY/SECOND.IDE | p. 34 Primary/Secondary IDE Connector (Two 40-1 pins) |
| 8) IDELED | p. 34 IDE Activity LED (2 pins) |
| 9) ATXPWR | p. 35 ATX Power Supply Connector (20 pins) |
| 10) PS2PWR | p. 35 AT Power Supply Connector (12 pins) |
| 11) USBMIR | p. 36 USB, PS/2 Mouse, Infrared Module Connector (18-1 pins) |
| 12) IR | p. 36 IrDA-Compliant Infrared Module Connector (5 pins) |
| 13) PWR (PANEL) | p. 37 ATX Power Switch/Soft Power Switch Lead (2 pins) |
| 14) IDELED (PANEL) | p. 37 IDE Activity LED Lead (2 pins) |
| 15) PLED (PANEL) | p. 37 System Power LED Lead (2 pins) |
| 16) RESET (PANEL) | p. 37 Reset Switch Lead (2 pins) |
| 17) MLED (PANEL) | p. 37 System Message LED (2 pins) |
| 18) KEYLOCK (PANEL) | p. 37 Keyboard Lock Switch Lead (2 pins) |
| 19) SPEAKER (PANEL) | p. 37 Speaker Output Connector (4 pins) |
| 20) WOLCON | p. 38 Wake-On-LAN Activity Connector (3 pins) |

III. HARDWARE SETUP

21) WOR	p. 38 Wake-On-Ring Connector (2 pins)
22) AUX, CD1, CD2	p. 39 Stereo Audio In Connector (4 pins)
23) MODEM	p. 39 Voice Modem In Connector (4 pins)
24) AUDIOCON	p. 39 Audio Header (26-1 pins)
25) SCART	p. 40 TV Out Connector (12-1 pin)
26) LCDHD	p. 40 LCD Header (20-1 pins)
27) VGA Header	p. 41 VGA Header (16 pins)

III. HARDWARE SETUP

Hardware Setup Steps

1. **Check Motherboard Settings**
2. **Install Memory Modules**
3. **Install the Central Processing Unit (CPU)**
4. **Install Expansion Cards**
5. **Connect Ribbon Cables, Cabinet Wires, and Power Supply**
6. **Setup the BIOS Software**

1. Motherboard Settings

This section explains how to change your motherboard's function settings through the use of switches and/or jumpers.

WARNING! Computer motherboards, baseboards and components, such as SCSI cards, contain very delicate Integrated Circuit (IC) chips. To protect them against damage from static electricity, you should follow some precautions whenever you work on your computer.

1. Unplug your computer when working on the inside.
2. Use a grounded wrist strap before handling computer components. If you do not have one, touch both of your hands to a safely grounded object or to a metal object, such as the power supply case.
3. Hold components by the edges and try not to touch the IC chips, leads or connectors, or other components.
4. Place components on a grounded antistatic pad or on the bag that came with the component whenever the components are separated from the system.

III. HARDWARE SETUP

1. Keyboard Power (Wake) Up (KB_UP)

This allows you to disable or enable the keyboard power or wake up function. Set to *Enable* if you want to use your keyboard (by pressing <Spacebar>) to power or wake up your computer. The default is set to *Disable* because not all computers have the appropriate ATX power supply.

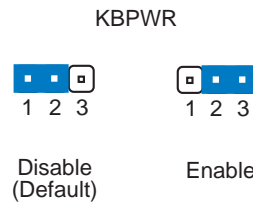
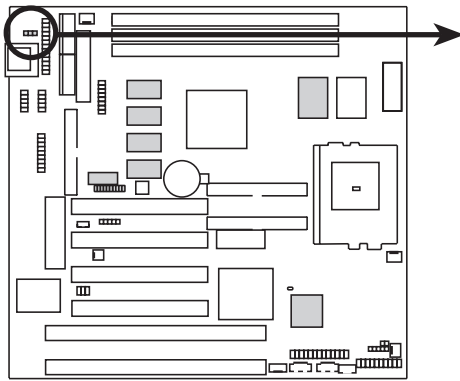

P5S-B Keyboard Power Up

Motherboard Feature Settings (DIP Switches – DIP1 & DIP 2)

Some of the motherboard's onboard functions can be adjusted through the DIP switches. The white block represents the switch's position. The following illustration shows all the switches in the OFF position.

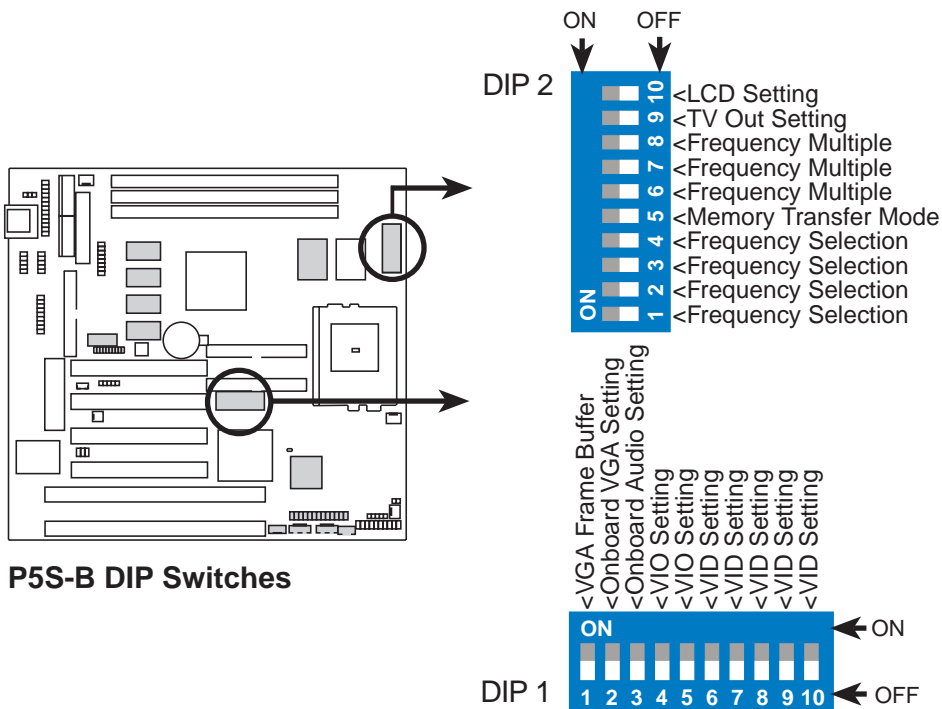

P5S-B DIP Switches

III. HARDWARE SETUP

2. VGA Frame Buffer Setting (DIP 1 – Switch 1)

This lets you select the display memory allocation mode. When *Shared* is selected, the integrated graphics accelerator uses up to 8MB of system memory as display memory. *Local* uses an optional dedicated onboard VGA memory (up to 8MB SDRAM).

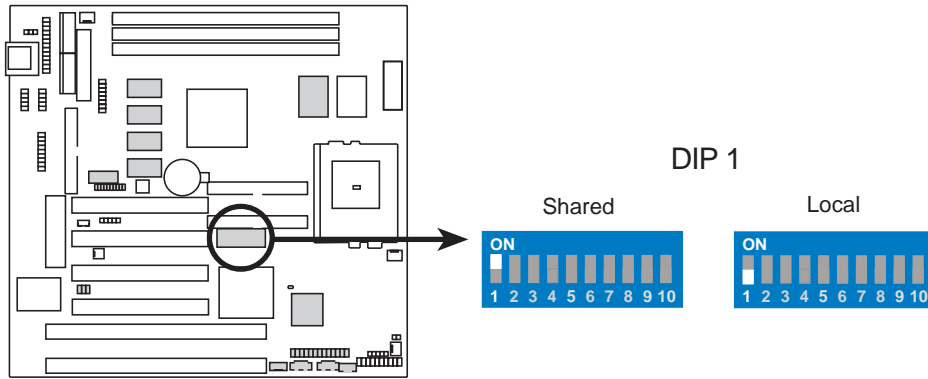

P5S-B VGA Frame Buffer Setting

3. Onboard VGA Setting (DIP 1 – Switch 2)

This lets you enable or disable the onboard AGP VGA. This may be disabled if you are using a VGA card on the expansion slot.

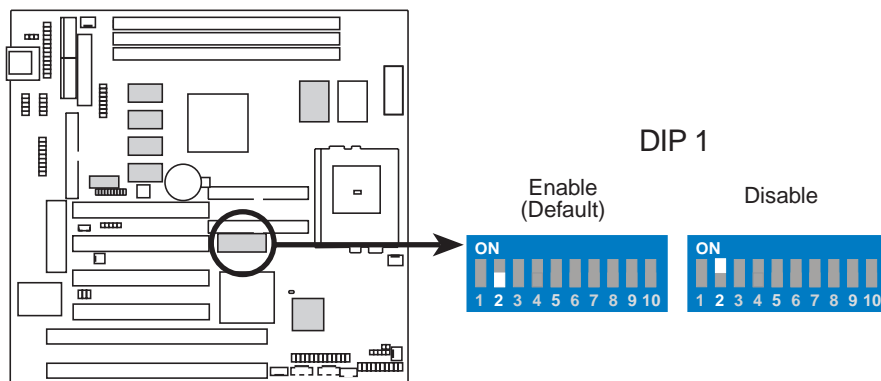

P5S-B Onboard VGA Setting

III. HARDWARE SETUP

4. Onboard Audio Setting (DIP 1-Switch 3)

This lets you enable or disable the optional onboard 32-bit PCI audio. This should be disabled if you are using an audio card on the expansion slot.

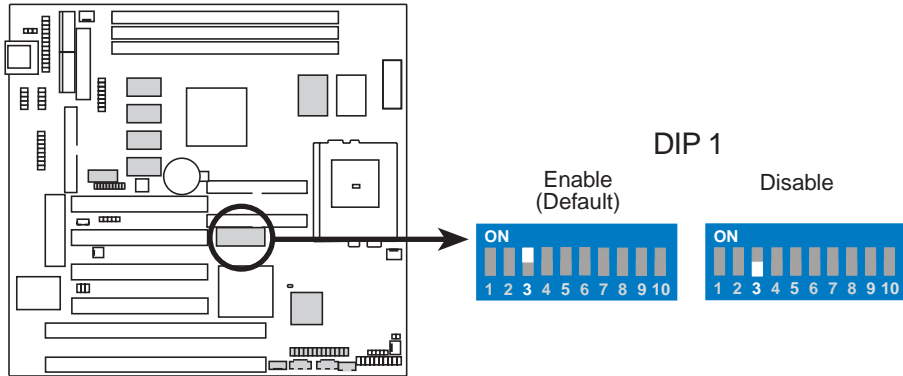

P5S-B Audio Setting

5. VIO Setting (DIP 1-Switches 4, 5)

The onboard voltage regulator allows you to select the voltage supplied to the DRAM, chipset, AGP, and the CPU's I/O buffer. **IMPORTANT!** Setting this function switch to 3.6V or 3.8V may reduce system life. It is strongly recommended that you leave your switch on its default setting of 3.5V.

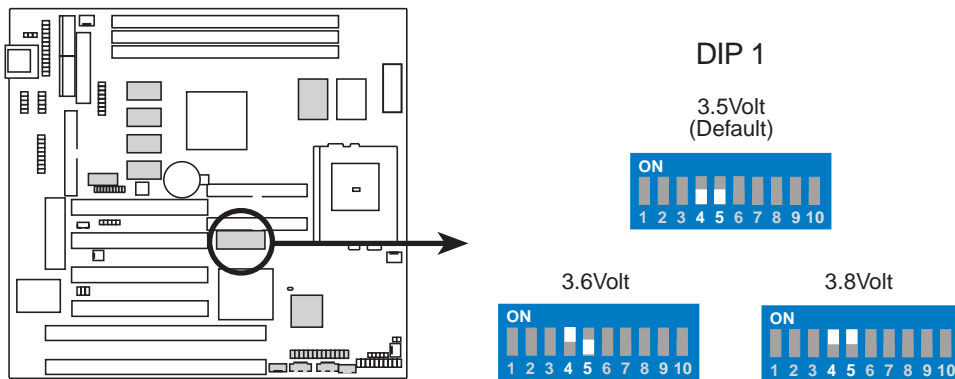

P5S-B Voltage I/O Setting

III. HARDWARE SETUP

7. TV Out Setting (DIP 2 – Switch 9)

This lets you select the signal that is inputted to your TV when using the optional TV Out connector. Select *AV* for a composite input or *RGB* for an RGB input. **NOTE:** This setting is available only on motherboards with the optional SCART interface support.

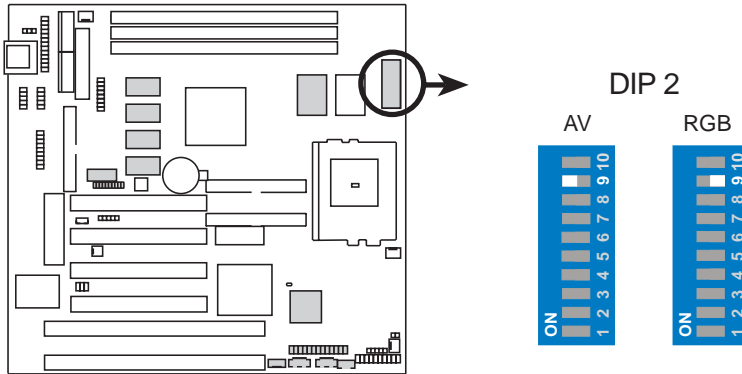

P5S-B TV Out (SCART) Setting

6. LCD Setting (DIP 2 – Switch 10)

If you want to connect an LCD monitor to your computer, you must set this switch to *Enable* to use it. See **LCD Header** in **External Connectors** for connection information. **NOTE:** This setting is available only on motherboards with the optional Digital Flat Panel (DFP) support.

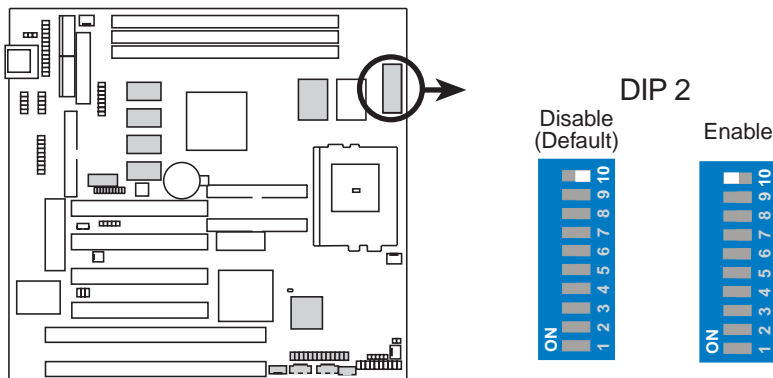

P5S-B LCD Setting

III. HARDWARE SETUP

8. CPU BUS Frequency Setting (DIP 2 – Switches 1, 2, 3, 4)

This option tells the clock generator what frequency to send to the CPU, chipset, and AGPset. This allows the selection of the CPU's *External* frequency (or *BUS Clock*). The BUS Clock multiplied by the BUS Ratio equals the CPU's *Internal* frequency (the advertised CPU speed). **NOTE:** You may set the memory speed independently from the CPU Bus Frequency. Depending on your memory type, PC66 (66MHz) or PC100 (100MHz), select the appropriate "RAM" speed along with the appropriate "CPU" speed.

9. Memory Transfer Mode Setting (DIP 2 – Switch 5)

The memory clock frequency can be set to be in asynchronous or asynchronous mode with respect to the CPU bus frequency.

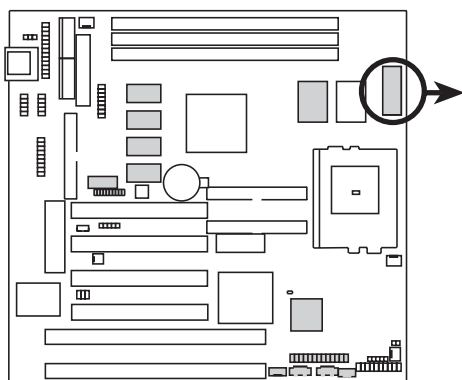

P5S-B
CPU Bus Frequency Setting

DIP 2	Switch 1	Switch 2	Switch 3	Switch 4
(SYNC)	(ASYNC)	(ASYNC)	(ASYNC)	(ASYNC)
CPU 66MHz	CPU 100MHz	CPU 66MHz	CPU 100MHz	CPU 100MHz
SDRAM 66MHz	SDRAM 100MHz	SDRAM 66MHz	SDRAM 100MHz	SDRAM 66MHz
PCI 33MHz	PCI 33MHz	PCI 37MHz	PCI 30MHz	PCI 32MHz
CPU 75MHz	CPU 105MHz	CPU 75MHz	CPU 105MHz	CPU 90MHz
SDRAM 75MHz	SDRAM 105MHz	SDRAM 75MHz	SDRAM 105MHz	SDRAM 60MHz
PCI 37MHz	PCI 35MHz	PCI 37MHz	PCI 37MHz	PCI 30MHz
CPU 90MHz	CPU 112MHz	CPU 90MHz	CPU 112MHz	CPU 95MHz
SDRAM 90MHz	SDRAM 112MHz	SDRAM 90MHz	SDRAM 112MHz	SDRAM 63MHz
PCI 30MHz	PCI 37MHz	PCI 30MHz	PCI 37MHz	PCI 32MHz
CPU 100MHz	CPU 105MHz	CPU 100MHz	CPU 105MHz	CPU 100MHz
SDRAM 66MHz	SDRAM 70MHz	SDRAM 66MHz	SDRAM 70MHz	SDRAM 66MHz
PCI 33MHz	PCI 35MHz	PCI 33MHz	PCI 35MHz	PCI 33MHz
CPU 100MHz	CPU 105MHz	CPU 100MHz	CPU 105MHz	CPU 100MHz
SDRAM 66MHz	SDRAM 70MHz	SDRAM 66MHz	SDRAM 70MHz	SDRAM 66MHz
PCI 33MHz	PCI 35MHz	PCI 33MHz	PCI 35MHz	PCI 33MHz

III. HARDWARE SETUP

10. CPU Core:BUS Frequency Multiple Setting (DIP 2 – Switches 6, 7, 8)

This option sets the frequency multiple between the CPU's *Internal* frequency and *External* frequency. These must be set in conjunction with the *CPU BUS Frequency Setting*.

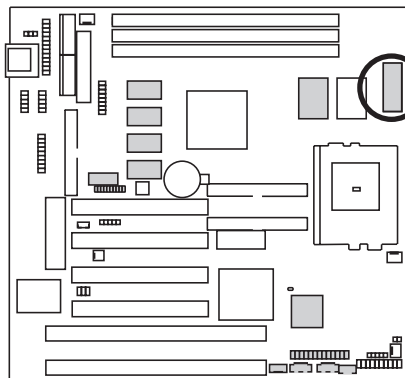

**P5S-B CPU
BUS Frequency Multiple**

- CPU A:** AMD-K6-2, AMD-K6
- CPU B:** Intel Pentium P54C, AMD-K5
- CPU C:** Intel Pentium P55C, IBM/Cyrix 6x86MX, IBM/Cyrix M II
- CPU D:** IBM/Cyrix 6x86, IBM/Cyrix 6x86L
- CPU E:** IDT WinChip 2™
- CPU F:** IDT WinChip C6

	DIP 2			
	ON	ON	ON	ON
CPU A →	3.5x(7/2)	2.0x(2/1)	2.5x(5/2)	3.0x(3/1)
CPU B →	1.5x(3/2)	2.0x(2/1)	2.5x(5/2)	3.0x(3/1)
CPU C →	3.5x(7/2)	2.0x(2/1)	2.5x(5/2)	3.0x(3/1)
CPU D →	3.0x(3/1)	2.0x(2/1)	1.0x(1/1)	—
CPU E →	3.5x(7/2)	3.33x(10/3)	2.5x(5/2)	3.0x(3/1)
CPU F →	4.0x(4/1)	2.0x(2/1)	2.0x(2/1)	3.0x(3/1)

	DIP 2			
	ON	ON	ON	ON
CPU A →	4.0x(4/1)	4.5x(9/2)	5.0x(5/1)	5.5x(11/2)
CPU B →	—	—	—	—
CPU C →	—	—	—	—
CPU D →	—	—	—	—
CPU E →	4.0x(4/1)	4.5x(9/2)	2.33x(7/3)	2.66x(8/3)
CPU F →	4.0x(4/1)	4.0x(4/1)	5.0x(5/1)	5.0x(5/1)

See next page for a table of the CPU BUS Frequency and CPU Core:BUS Frequency Multiple Settings of supported CPUs.

WARNING! Frequencies above 100MHz exceed the specifications for the on-board chipset and are not guaranteed to be stable. The table on the following page is for general reference purposes only. Always refer to the instructions included with your CPU when possible.

III. HARDWARE SETUP

Set the DIP switches by the internal speed of your CPU as follows:

CPU Model	Freq.	Mult.	BUS F.	(BUS Freq.) DIP 2				(Freq. Multiple) DIP 2		
				1	2	3	4	6	7	8
AMD-K6-3/400	400MHz	A-4.0x	100MHz	[ON]	[ON]	[OFF]	[ON]	[ON]	[OFF]	[ON]
AMD-K6-2/450	450MHz	A-4.5x	100MHz	[ON]	[ON]	[OFF]	[ON]	[ON]	[ON]	[ON]
AMD-K6-2/400	400MHz	A-4.0x	100MHz	[ON]	[ON]	[OFF]	[ON]	[ON]	[OFF]	[ON]
AMD-K6-2/380	380MHz	A-4.0x	95MHz	[OFF]	[OFF]	[ON]	[ON]	[ON]	[OFF]	[ON]
AMD-K6-2/366	366MHz	A-5.5x	66MHz	[ON]	[ON]	[ON]	[ON]	[OFF]	[OFF]	[ON]
AMD-K6-2/350	350MHz	A-3.5x	100MHz	[ON]	[ON]	[OFF]	[ON]	[OFF]	[OFF]	[OFF]
AMD-K6-2/333	333MHz	A-3.5x	95MHz	[OFF]	[OFF]	[ON]	[ON]	[OFF]	[OFF]	[OFF]
AMD-K6-2/300	300MHz	A-3.0x	100MHz	[ON]	[ON]	[OFF]	[ON]	[OFF]	[ON]	[OFF]
AMD-K6-2/266	266MHz	A-4.0x	66MHz	[ON]	[ON]	[ON]	[ON]	[ON]	[OFF]	[ON]
AMD-K6/300	300MHz	A-4.5x	66MHz	[ON]	[ON]	[ON]	[ON]	[ON]	[ON]	[ON]
AMD-K6/266	266MHz	A-4.0x	66MHz	[ON]	[ON]	[ON]	[ON]	[ON]	[OFF]	[ON]
AMD-K6/233	233MHz	A-3.5x	66MHz	[ON]	[ON]	[ON]	[ON]	[OFF]	[OFF]	[OFF]
AMD-K6/200	200MHz	A-3.0x	66MHz	[ON]	[ON]	[ON]	[ON]	[OFF]	[ON]	[OFF]
AMD-K6/166	166MHz	A-2.5x	66MHz	[ON]	[ON]	[ON]	[ON]	[ON]	[ON]	[OFF]
AMD-K5/133	100MHz	B-1.5x	66MHz	[ON]	[ON]	[ON]	[ON]	[OFF]	[OFF]	[OFF]
AMD-K5/100	100MHz	B-1.5x	66MHz	[ON]	[ON]	[ON]	[ON]	[OFF]	[OFF]	[OFF]
Intel Pentium P54C	166MHz	B-2.5x	66MHz	[ON]	[ON]	[ON]	[ON]	[ON]	[ON]	[OFF]
Intel Pentium P54C	133MHz	B-2.0x	66MHz	[ON]	[ON]	[ON]	[ON]	[ON]	[OFF]	[OFF]
Intel Pentium P54C	100MHz	B-1.5x	66MHz	[ON]	[ON]	[ON]	[ON]	[OFF]	[OFF]	[OFF]
Intel Pentium P55C	233MHz	C-3.5x	66MHz	[ON]	[ON]	[ON]	[ON]	[OFF]	[OFF]	[OFF]
Intel Pentium P55C	200MHz	C-3.0x	66MHz	[ON]	[ON]	[ON]	[ON]	[OFF]	[ON]	[OFF]
Intel Pentium P55C	166MHz	C-2.5x	66MHz	[ON]	[ON]	[ON]	[ON]	[ON]	[ON]	[OFF]
IBM/Cyrix M II-PR333	270MHz	C-3.0x	90MHz	[ON]	[OFF]	[ON]	[ON]	[OFF]	[ON]	[OFF]
IBM/Cyrix M II-PR300	225MHz	C-3.0x	75MHz	[OFF]	[ON]	[ON]	[ON]	[OFF]	[ON]	[OFF]
IBM/Cyrix M II-PR300	233MHz	C-3.5x	66MHz	[ON]	[ON]	[ON]	[ON]	[OFF]	[OFF]	[OFF]
IBM/Cyrix 6x86MX-PR233	200MHz	C-3.0x	66MHz	[ON]	[ON]	[ON]	[ON]	[OFF]	[ON]	[OFF]
IBM/Cyrix 6x86MX-PR200	166MHz	C-2.5x	66MHz	[ON]	[ON]	[ON]	[ON]	[ON]	[ON]	[OFF]
IBM/Cyrix 6x86-PR166+*	133MHz	D-2.0x	66MHz	[ON]	[ON]	[ON]	[ON]	[ON]	[OFF]	[OFF]
IBM/Cyrix 6x86L-PR166+*	133MHz	D-2.0x	66MHz	[ON]	[ON]	[ON]	[ON]	[ON]	[OFF]	[OFF]

*The only IBM or Cyrix 6x86(L) (or M1) that is supported on this motherboard is revision 2.7 or later (see next page).

III. HARDWARE SETUP

Compatible Cyrix CPU Identification

The only Cyrix 6x86-PR166+ CPU that is supported on this motherboard must be Revision 2.7 or later. Look on the underside of the CPU for the serial number. The number should read G8DC6620A or later.

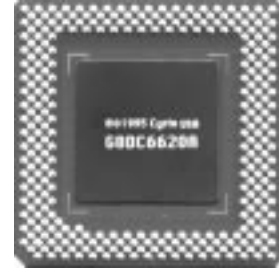

11. Voltage Regulator Output Selection (DIP 1 – Switches 6, 7, 8, 9, 10)

These jumpers set the V_{CORE} voltage supplied to the CPU. Switching regulators allow some settings to be the same for two voltages of different power planes.

WARNING! Because CPU designs change rapidly, the table on the following page is only intended as a simple guideline and thus may not be true for your CPU. Always refer to the CPU documentation for your CPU's voltage and then set the appropriate VID jumpers according to the **CPU V_{core} Voltage Selection** illustration.

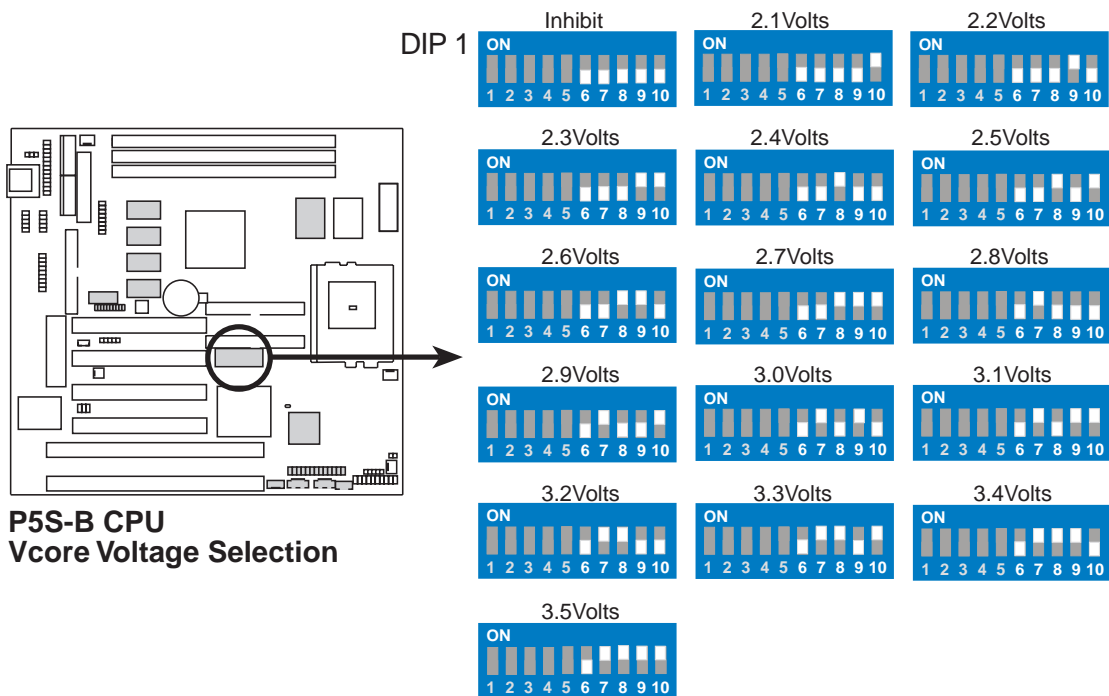

III. HARDWARE SETUP

Manufacturer	CPU Type	Single Plane	Dual Plane	DIP 1				
				6	7	8	9	10
AMD (.25micron)	K6-3/400 K6-2/450	----	2.4V(Dual)	[OFF]	[OFF]	[ON]	[OFF]	[OFF]
AMD (.25micron)	K6-2/266,300,333, 366,380,400 K6/233,266,300	----	2.2V(Dual)	[OFF]	[OFF]	[OFF]	[ON]	[OFF]
AMD	K5	3.5V(VRE)	----	[OFF]	[ON]	[ON]	[ON]	[ON]
IBM/Cyrix	6x86	3.5V(VRE)	----	[OFF]	[ON]	[ON]	[ON]	[ON]
IDT	WinChip2	3.5V(VRE)	----	[OFF]	[ON]	[ON]	[ON]	[ON]
Intel	P54C/P54CS	3.5V(VRE)	----	[OFF]	[ON]	[ON]	[ON]	[ON]
AMD	K5	3.4V(STD)	----	[OFF]	[ON]	[ON]	[ON]	[OFF]
Intel	P54C/P54CS	3.4V(STD)	---	[OFF]	[ON]	[ON]	[ON]	[OFF]
AMD (.35micron)	K6-233	----	3.2V(Dual)	[OFF]	[ON]	[ON]	[OFF]	[OFF]
AMD (.35micron)	K6-166,200	----	2.9V(Dual)	[OFF]	[ON]	[OFF]	[OFF]	[ON]
IBM/Cyrix	6x86MX	----	2.9V(Dual)	[OFF]	[ON]	[OFF]	[OFF]	[ON]
Intel	P55C-MMX	----	2.8V(Dual)	[OFF]	[ON]	[OFF]	[OFF]	[OFF]

III. HARDWARE SETUP

2. System Memory (DIMM)

This motherboard uses only Dual Inline Memory Modules (DIMMs). Sockets are available for **3.3Volt** (power level) unbuffered Synchronous Dynamic Random Access Memory (SDRAM) of either 8, 16, 32, 64, 128MB, or 256MB to form a memory size between 8MB and 768MB. One side (with memory chips) of the DIMM takes up one row on the motherboard.

To utilize the chipset's Error Checking and Correction (ECC) feature, you must use a DIMM module with 9 chips per side (standard 8 chips/side + 1 ECC chip) and make the proper settings in Chipset Features Setup under **BIOS SETUP**.

Memory speed setup is recommended through *SDRAM Configuration* in Chipset Features Setup under **BIOS SETUP**.

IMPORTANT! (see **Notes** below)

- **To make using bus speeds $\geq 95\text{MHz}$ possible, SDRAMs used must be compatible with the current Intel PC100 SDRAM specification..**

Install memory in any combination as follows:

DIMM Location	168-pin DIMM		Total Memory
DIMM1 (Rows 0&1)	SDRAM 8, 16, 32, 64, 128, 256MB	x1	
DIMM2 (Rows 2&3)	SDRAM 8, 16, 32, 64, 128, 256MB	x1	
DIMM3 (Rows 4&5)	SDRAM 8, 16, 32, 64, 128, 256MB	x1	
	Total System Memory (Max 768MB)	=	

NOTES

- **DIMMs that have more than 18 chips are not supported on this motherboard.**
- **To make using bus speeds $\geq 95\text{MHz}$ possible, use only PC100-compliant DIMMs.** Most systems will not even boot if non-compliant modules are used because of the strict timing issues involved with speeds $\geq 95\text{MHz}$.
- SDRAM chips are generally thinner and have higher pin density than EDO (Extended Data Output) chips.
- BIOS shows SDRAM memory on bootup screen.
- Single-sided DIMMs are available in 16, 32, 64, 128MB; double-sided in 32, 64, 128, 256MB.

III. HARDWARE SETUP

DIMM Memory Installation Procedures:

Insert the module(s) as shown. Because the number of pins are different on either side of the breaks, the module will only fit in the orientation as shown. DRAM SIMM modules have the same pin contacts on both sides. SDRAM DIMMs have different pin contacts on each side and therefore have a higher pin density.

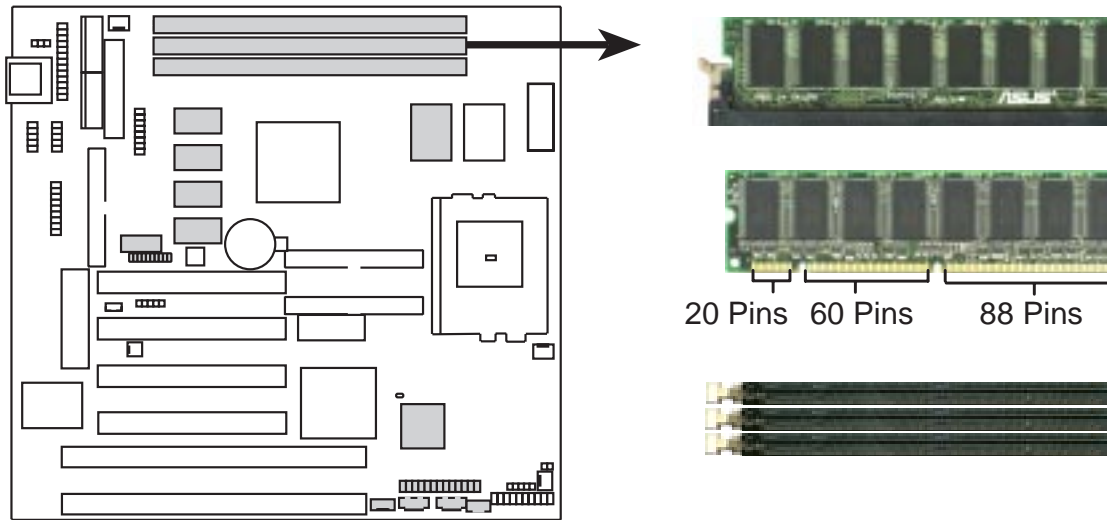

P5S-B 168-Pin DIMM Memory Sockets

The DIMMs must be 3.3Volt unbuffered SDRAMs. To determine the DIMM type, check the notches on the DIMMs (see figure below).

168-Pin DIMM Notch Key Definitions (3.3V)

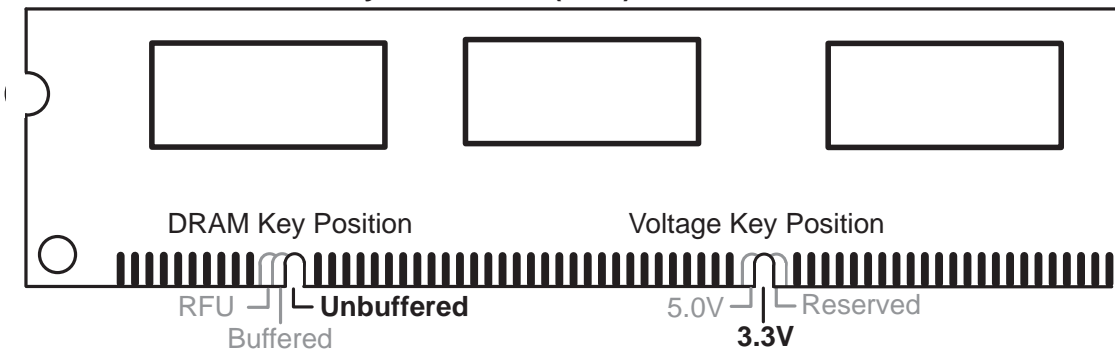

The notches on the DIMM will shift between left, center, or right to identify the type and also to prevent the wrong type from being inserted into the DIMM slot on the motherboard. You must tell your retailer the correct DIMM type before purchasing. This motherboard supports four clock signals.

III. HARDWARE SETUP

3. Central Processing Unit (CPU)

The motherboard provides a 321-pin ZIF Socket 7 that is backwards compatible with ZIF Socket 5 processors. The CPU that came with the motherboard should have a fan attached to it to prevent overheating. If this is not the case then purchase a fan before you turn on your system.

WARNING! Without a fan circulating air on the CPU, the CPU can overheat and cause damage to both the CPU and the motherboard.

To install a CPU, first turn off your system and remove its cover. Locate the ZIF socket and open it by first pulling the lever sideways away from the socket then upwards to a 90-degree right angle. Insert the CPU with the correct orientation as shown. Use the notched corner of the CPU with the white dot as your guide. The white dot should point towards the end the of the lever. Notice that there is a blank area where one hole is missing from that corner of the square array of pin holes and a “1” printed on the motherboard next to that corner. Because the CPU has a corner pin for three of the four corners, the CPU will only fit in the one orientation as shown. The picture is for reference only; you should have a CPU fan that will cover the face of the CPU. With the added weight of the CPU fan, no force is required to insert the CPU. Once completely inserted, hold down on the fan and close the socket’s lever.

IMPORTANT: You must set jumpers for “CPU to BUS Frequency Ratio” and jumpers for “BUS Frequency Selection” depending on the CPU that you install.

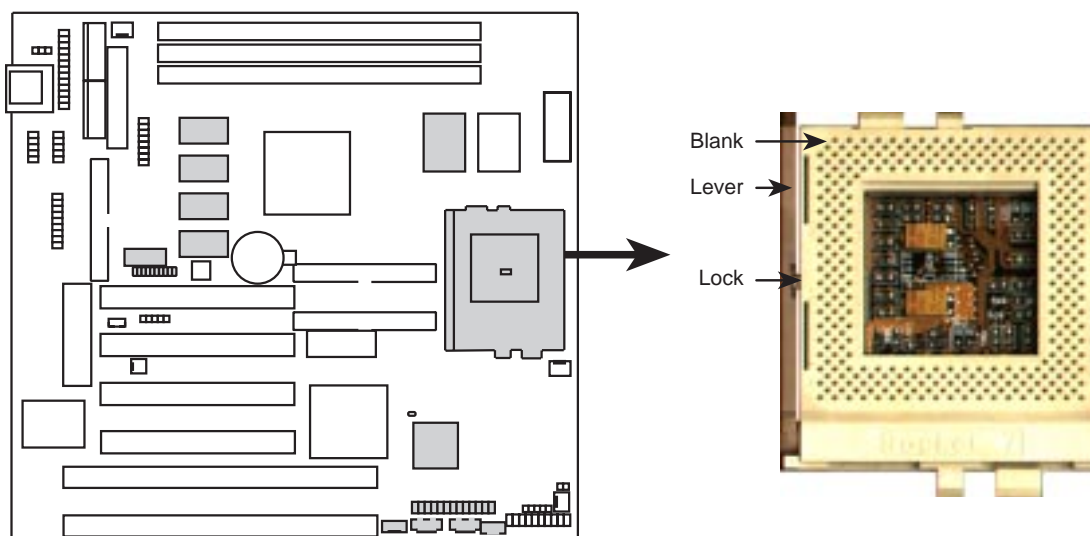

P5S-B ZIF Socket 7

(This page was intentionally left blank.)

III. HARDWARE SETUP

4. Expansion Cards

WARNING! Make sure that you unplug your power supply when adding or removing expansion cards or other system components. Failure to do so may cause severe damage to both your motherboard and expansion cards.

Expansion Card Installation Procedure:

1. Read your expansion card documentation on any hardware and software settings that may be required to setup your specific card.
2. Set any necessary jumpers on your expansion card.
3. Remove your computer system's cover.
4. Remove the bracket on the slot you intend to use.
Keep the bracket for possible future use.
5. Carefully align the card's connectors and press firmly.
6. Secure the card on the slot with the screw you removed in step 4.
7. Replace the computer system's cover.
8. Setup the BIOS if necessary
(such as "IRQ xx Used By ISA: Yes" in PNP AND PCI SETUP)
9. Install the necessary software drivers for your expansion card.

Assigning IRQs for Expansion Cards

Some expansion cards need to use an IRQ to operate. Generally an IRQ must be exclusively assigned to one use. In a standard design there are 16 IRQs available but most of them are already in use by parts of the system which leaves 6 free for expansion cards.

Both ISA and PCI expansion cards may need to use IRQs. System IRQs are available to cards installed in the ISA expansion bus first, and any remaining IRQs are then used by PCI cards. Currently, there are two types of ISA cards.

The original ISA expansion card design, now referred to as "Legacy" ISA cards, requires that you configure the card's jumpers manually and then install it in any available slot on the ISA bus. You may use Microsoft's Diagnostic (MSD.EXE) utility included in the Windows directory to see a map of your used and free IRQs. For Windows 95 users, the "Control Panel" icon in "My Computer," contains a "System" icon, which gives you a "Device Manager" tab. Double clicking on a specific device give you "Resources" tab which shows the Interrupt number and address. Make sure that no two devices use the same IRQs or your computer will experience problems when those two devices are in use at the same time.

III. HARDWARE SETUP

To simplify this process, this motherboard complies with the Plug and Play (PNP) specification which was developed to allow automatic system configuration whenever a PNP-compliant card is added to the system. For PNP cards, IRQs are assigned automatically from those available.

If the system has both Legacy and PNP ISA cards installed, IRQs are assigned to PNP cards from those not used by Legacy cards. The PCI and PNP configuration of the BIOS setup utility can be used to indicate which IRQs are being used by Legacy cards. For older Legacy cards that do not work with the BIOS, you can contact your vendor for an ISA Configuration Utility.

An IRQ number is automatically assigned to PCI expansion cards after those used by Legacy and PNP ISA cards. In the PCI bus design, the BIOS automatically assigns an IRQ to a PCI slot that has a card in it that requires an IRQ. To install a PCI card, you need to set something called the INT (interrupt) assignment. Since all the PCI slots on this motherboard use an INTA#, be sure that the jumpers on your PCI cards are set to INT A.

Assigning DMA Channels for ISA Cards

Some ISA cards, both legacy and PnP, may also need to use a DMA (Direct Memory Access) channel. DMA assignments for this motherboard are handled the same way as the IRQ assignment process described earlier. You can select a DMA channel in the PCI and PnP configuration section of the BIOS Setup utility.

IMPORTANT! To avoid conflicts, reserve the necessary IRQs and DMAs for legacy ISA cards (in PNP AND PCI SETUP under **BIOS SETUP**, choose *Yes* in *IRQ xx Used By ISA* and *DMA x Used By ISA* for those IRQs and DMAs you want to reserve).

ISA Cards and Hardware Monitor

The onboard hardware monitor uses the address 290H-297H, so legacy ISA cards must not use this address or else conflicts will occur.

III. HARDWARE SETUP

5. External Connectors

WARNING! Some pins are used for connectors or power sources. These are clearly separated from jumpers in the motherboard layout. Placing jumper caps over these will cause damage to your motherboard.

IMPORTANT! Ribbon cables should always be connected with the red stripe on the Pin 1 side of the connector. The four corners of the connectors are labeled on the motherboard. Pin 1 is the side closest to the power connector on hard drives and some floppy drives. IDE ribbon cable must be less than 18in. (46cm), with the second drive connector no more than 6in. (15cm) from the first connector.

1. Keyboard Connector (5-pin Female)

This connection supports either a standard IBM-compatible, 101/102-key, or 104-key keyboard (Windows 95/98-compatible).

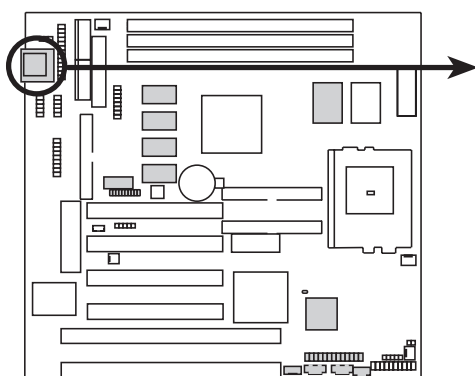

Keyboard Connector (5-pin female)



This motherboard accepts an AT Keyboard Connector Plug as shown here.

P5S-B Keyboard Connector

2. Floppy Disk Drive Connector (FLOPPY, 34-1 pin block)

This connector supports the provided floppy drive ribbon cable. After connecting the single end to the board, connect the two plugs on the other end to the floppy drives. **(Pin 5 is removed to prevent inserting in the wrong orientation when using ribbon cables with pin 5 plugged).**

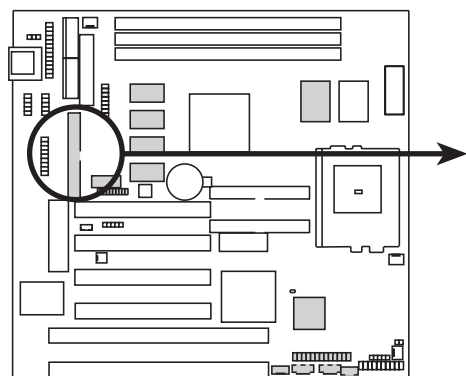

Floppy Disk Drive Connector



Pin 1

P5S-B Floppy Disk Drive Connector

III. HARDWARE SETUP

3. Parallel Port Connector (26-1 pin block)

This connector supports the included parallel port ribbon cable with mounting bracket. Connect the ribbon cable to this connection and mount the bracket to the case on an open slot. A PS/2 mouse/parallel connector is included if the optional USB/MIR connector is not used. You can make available the parallel port and choose the IRQ through the *Onboard Parallel Port* in **Chipset Features** under **BIOS SETUP**. (Pin 26 is removed to prevent inserting in the wrong orientation when using ribbon cables with pin 26 plugged).

NOTE: Serial printers must be connected to the serial port.

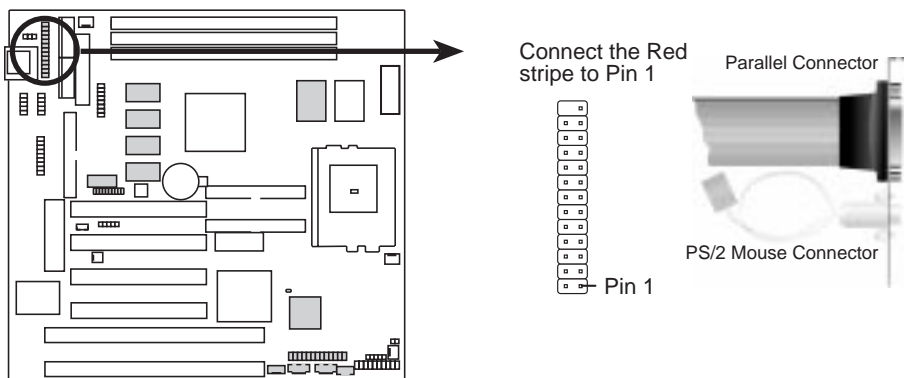

P5S-B Parallel Connector

4. Serial Port Connectors (COM1/COM2, two 10-1 pin blocks)

These connectors support the provided serial port ribbon cables with mounting bracket. Connect the ribbon cables to these connectors and mount the bracket to the case on an open slot. You can make available the parallel port and choose the IRQ through the *Onboard Serial Port* in **Chipset Features** under **BIOS SETUP**. (Pin 10 is removed to prevent inserting in the wrong orientation when using ribbon cables with pin 10 plugged).

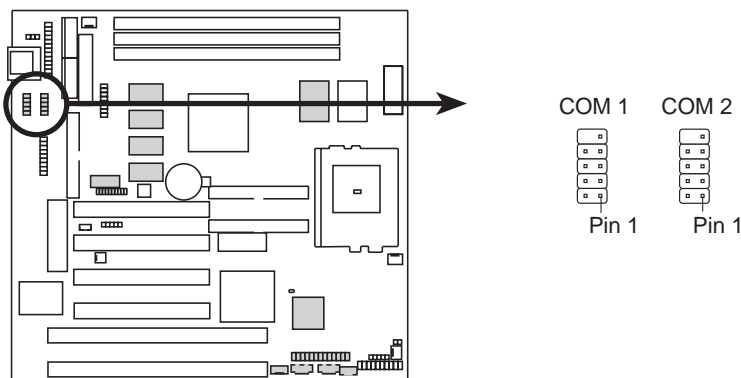

P5S-B Serial Port Connectors

III. HARDWARE SETUP

5. Cooling Fan Connectors (FAN, 3 pins)

These connectors support 3-pin CPU cooling fans of 500mA (6W) or less with a minimum of 3,500RPM. Depending on the fan manufacturer, the wiring and plug may be different. The red wire should be *Positive*, the black should be *Ground*, and the yellow wire should be *Rotation* signal.

WARNING! The CPU and/or motherboard will overheat if there is no airflow across the CPU. Damage may occur to the motherboard and/or the CPU fan if these pins are incorrectly used. **These are not jumpers, do not place jumper caps over these pins.**

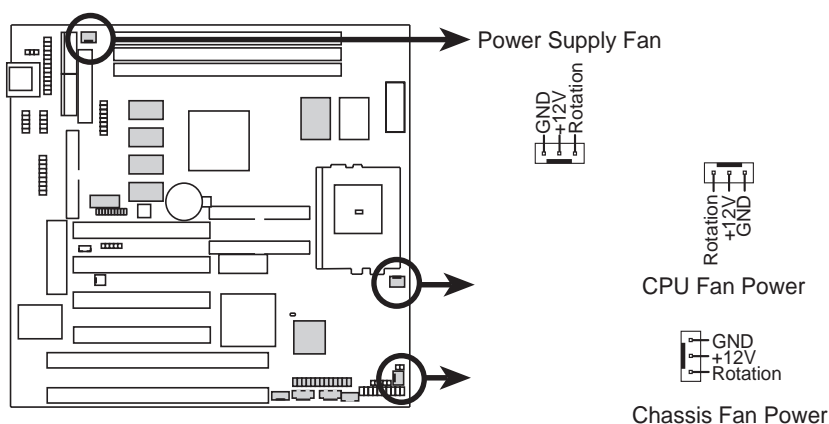

P5S-B 12Volt Cooling Fan Power

6. SMBus Connector (5-1 pin SMB)

This connector allows you to connect SMBus devices. SMBus devices communicate by means of the SMBus with an SMBus host and/or other SMBus devices. The SMBus or System Management Bus is a specific implementation of an I²C bus, which is a multi-master bus, that is, multiple chips can be connected to the same bus and each one can act as a master by initiating data transfer.

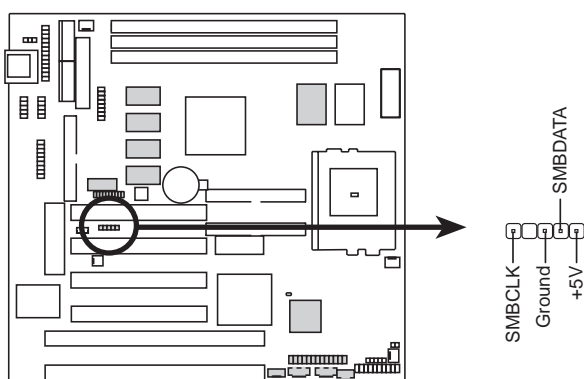

P5S-B SMBus Connector

III. HARDWARE SETUP

7. Primary / Secondary IDE Connectors (Two 40-1 pin block)

These connectors support the provided IDE hard disk ribbon cable. After connecting the single end to the board, connect the two plugs at the other end to your hard disk(s). If you install two hard disks on the same channel, you must set the second drive to Slave mode. Refer to the documentation of your hard disk for the jumper settings. BIOS now supports SCSI device or IDE CD-ROM bootup (see *HDD Sequence SCSI/IDE First & Boot Sequence* in the **BIOS Features Setup** under **BIOS SETUP**) (Pin 20 is removed to prevent inserting in the wrong orientation when using ribbon cables with pin 20 plugged).

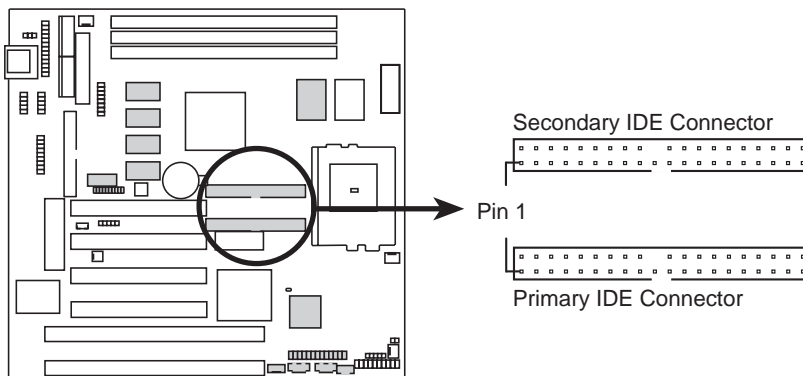

P5S-B IDE Connectors

NOTE: Orient the red markings (usually zigzag) on the IDE ribbon cable to pin 1

TIP: You may configure two hard disks to be both Masters using one ribbon cable on the primary IDE connector and another ribbon cable on the secondary IDE connector. You may install one operating system on an IDE drive and another on a SCSI drive and select the boot disk through BIOS Features Setup.

8. IDE Activity LED (IDELED, 2 pins)

This connector supplies power to the cabinet's IDE activity LED. Read and write activity by devices connected to the Primary or Secondary IDE connectors will cause the LED to light up.

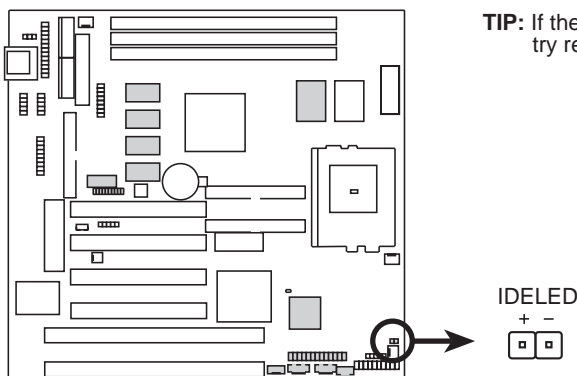

P5S-B IDE Activity LED

TIP: If the case-mounted LED does not light, try reversing the 2-pin plug.

III. HARDWARE SETUP

9. ATX Power Supply Connector (ATXPWR, 20-pin block)

This connector connects to an ATX power supply. The plug from the power supply will only insert in one orientation because of the different hole sizes. Find the proper orientation and push down firmly making sure that the pins are aligned.

IMPORTANT! Make sure that your ATX power supply can supply at least 10mAmp on the 5-volt standby lead (+5VSB). You may experience difficulty in powering on your system if your power supply cannot support the load. For Wake on LAN support, your ATX power supply must supply at least 720mA.

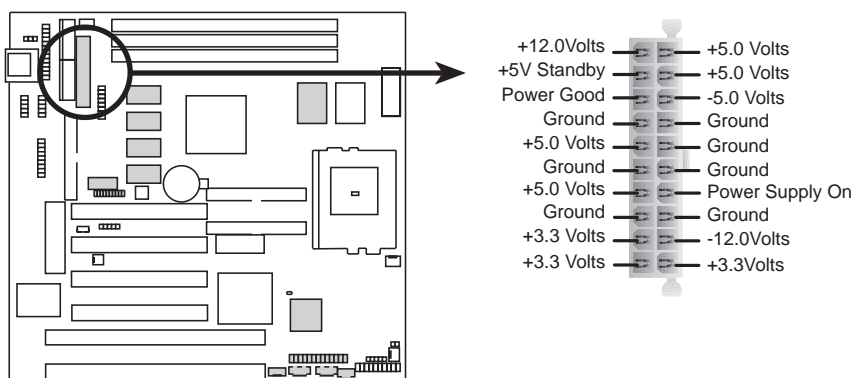

P5S-B ATX Power Connector

10. AT Power Supply Connector (PS2PWR, 12-pin block)

This connector connects to a standard 5 Volt power supply. To connect the leads from the power supply, ensure first that the power supply is not plugged. Most power supplies provide two plugs (P8 and P9), each containing six wires, two of which are black. Orient the connectors so that the black wires are together.

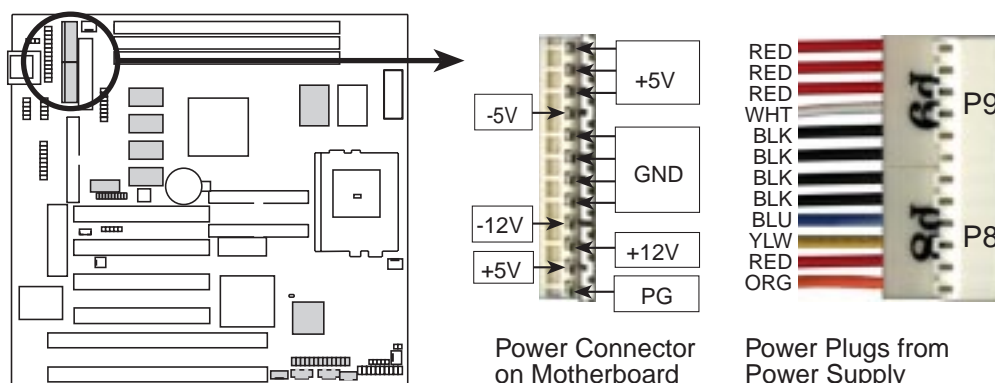

P5S-B AT Power Connector

At a slight angle, align the plastic guide pins on the lead to their receptacles on the connector. Once aligned, press the lead onto the connector until the lead locks into place.

III. HARDWARE SETUP

11. USB, PS/2 Mouse, Infrared, Module Connector (USBMIR, 18-1 pin block)

If you want to use PS/2 mouse, USB, or infrared (IrDA) devices, you need to purchase an optional USB/MIR connector set. You may use the bundled PS/2 mouse/parallel port connector set if you just want to use a PS/2 mouse. Either connector set connects to the 18-pin block and mounts to an open slot on your computer's chassis. The system will direct IRQ12 to the PS/2 mouse if one is detected. If not detected, expansion cards can use IRQ12. See *PS/2 Mouse Control* in **BIOS Features Setup** and *USB Function* in **PnP and PCI Setup** under **BIOS SETUP**. See *Second IrDA...* connector for details on the infrared connector.

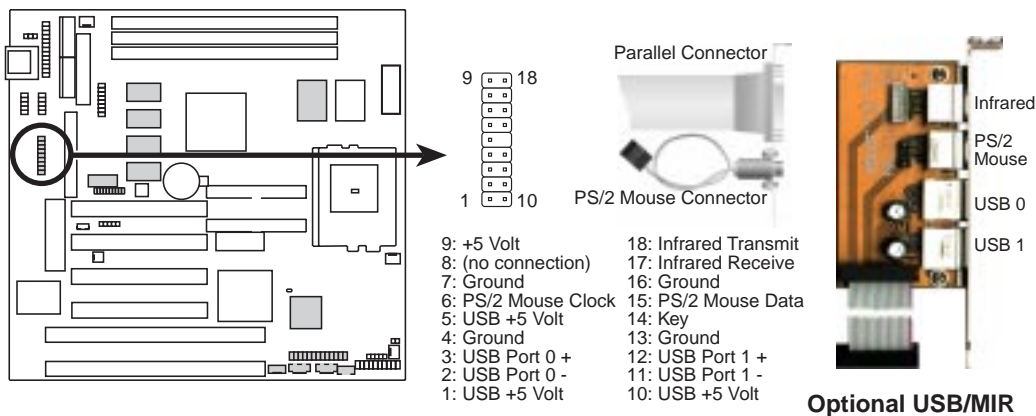

P5S-B PS/2 Mouse, USB, IrDA Module Connector

12. IrDA-Compliant Infrared Module Connector (IR, 5-pin block)

This connector supports the optional wireless transmitting and receiving infrared module. This module mounts to a small opening on system cases that support this feature. You must also configure the setting through *UART2 Use Infrared* in **Chipset Features Setup** to select whether UART2 is directed for use with COM2 or IrDA. Use the five pins as shown below (Back View) and connect a ribbon cable from the module to the motherboard according to the pin definitions.

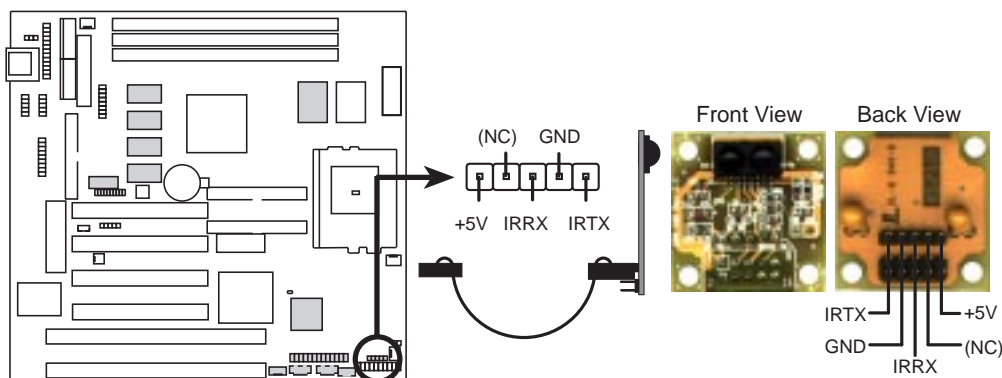

P5S-B Infrared Module Connector

III. HARDWARE SETUP

13. ATX Power Switch/Soft Power Switch Lead (PWR, 2 pins)

The system power can be controlled by a momentary switch connected to this lead. Pushing the button once will switch the system between ON and SLEEP. Pushing the switch while in the ON mode for more than 4 seconds will turn the system off. The system power LED shows the status of the system's power.

14. IDE Activity LED Lead (IDELED, 2 pins)

This connector supplies power to the cabinet's IDE activity LED. Read and write activity by devices connected to the Primary or Secondary IDE connectors will cause the LED to light up.

15. System Power LED Lead (PLED, 2 pins)

This 3-pin connector connects the system power LED, which lights when the system is powered on and blinks when it is in sleep mode.

16. Reset Switch Lead (RESET, 2 pins)

This 2-pin connector connects to the case-mounted reset switch for rebooting your computer without having to turn off your power switch. This is a preferred method of rebooting in order to prolong the life of the system's power supply.

17. Message LED Lead (MLED, 2 pins)

This indicates whether a message has been received from a fax/modem. The LED will remain lit when there is no signal and blink when there is data transfer or messages waiting in the inbox. This function requires ACPI OS support.

18. Keyboard Lock Switch Lead (KEYLOCK, 2 pins)

This 2-pin connector connects to the case-mounted key switch to allow keyboard locking.

19. Speaker Connector (SPEAKER, 4 pins)

This 4-pin connector connects to the case-mounted speaker.

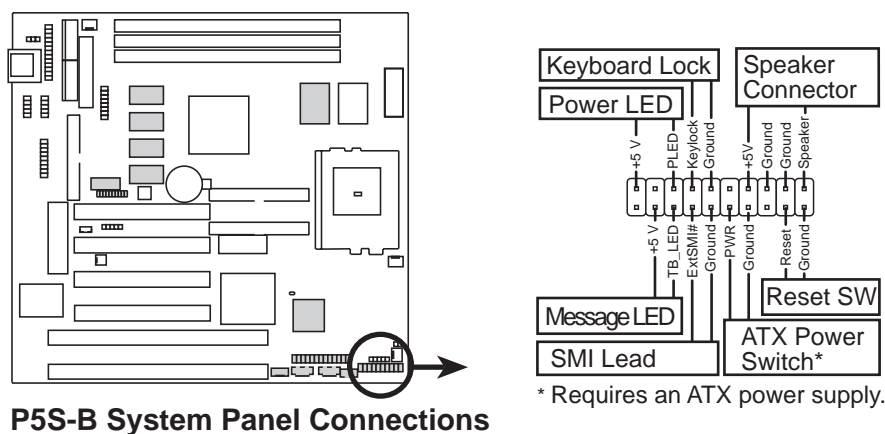

P5S-B System Panel Connections

III. HARDWARE SETUP

20. Wake-On-LAN Activity Connector (3-pin WOLCON)

The WOLCON connector allows the system to power up when there is a wakeup packet or signal is received from the network through the ASUS PCI-L101 LAN card (see **ASUS LAN CARD**).

IMPORTANT! This feature requires that the **WAKE On LAN Power Up Control** is set to *Enabled* (see Power Management Setup under **BIOS SETUP**) and that your system has an ATX power supply with at least 720mA +5V standby power.

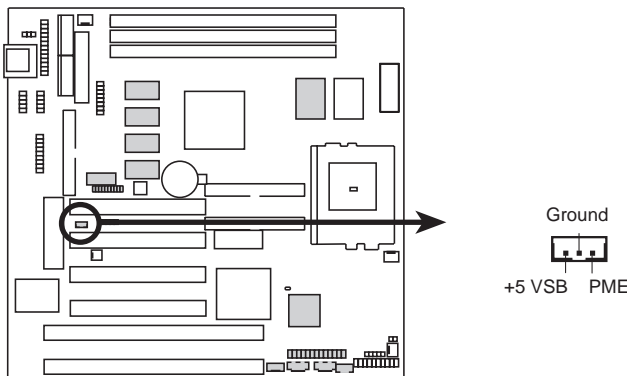

P5S-B Wake-On-LAN Connector

21. Wake-On-Ring Connector (2-pin WOR)

The WOR connector connects to internal modem cards with Wake-On-Ring output. The connector powers up the system when a ringup packet or signal is received through the internal modem card. **NOTE:** For external modems, Wake-On-Ring is detected through the COM port.

IMPORTANT! This feature requires that the **PWR UP On Modem Act Power Up Control** is set to *Enabled* (see Power Management Setup under **BIOS SETUP**) and that your system has an ATX power supply with at least 720mA +5V standby power.

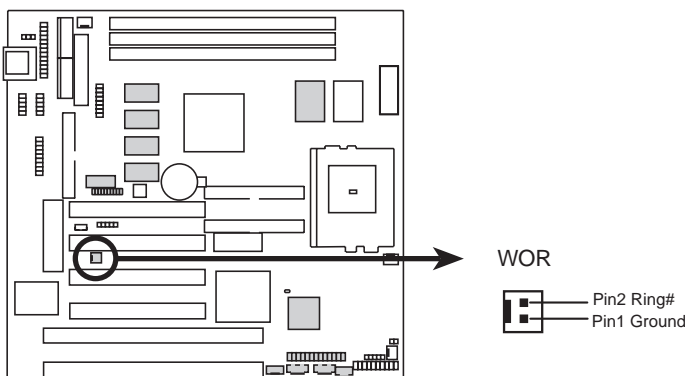

P5S-B Wake-On-Ring Connector

III. HARDWARE SETUP

22. Stereo Audio In Connector (4-pin AUX, CD1, CD2) /

23. Voice Modem In Connector (4-pin MODEM)

AUX, CD1 and CD2 allow you to receive stereo audio input from an internal CD-ROM drive or other sound sources, such as the ASUS TV Box, TV tuner or MPEG card. MODEM allows the optional onboard audio to interface with a voice modem card. It also allows the sharing of microphone and speaker between the onboard audio and the voice modem card. **To use this feature**, your voice modem card must have a similar connector. **NOTE:** This connector is available only on motherboards with the optional onboard audio support.

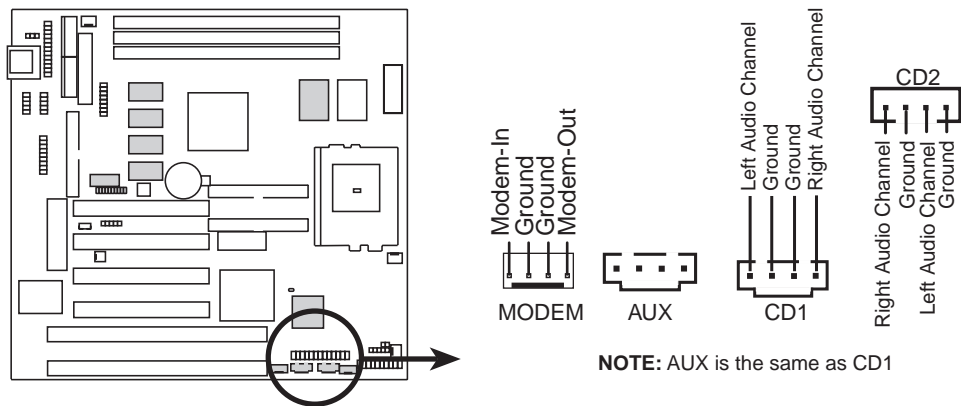

P5S-B Internal Audio Connectors

24. Audio Header (26-1 pin AUDIOCON)

This header supports the optional connector set for audio input/output and game/MIDI port. This connector set connects to the 25-pin block and mounts to an open slot on your computer's chassis. **NOTE:** This connector is available only on motherboards with the optional onboard audio support.

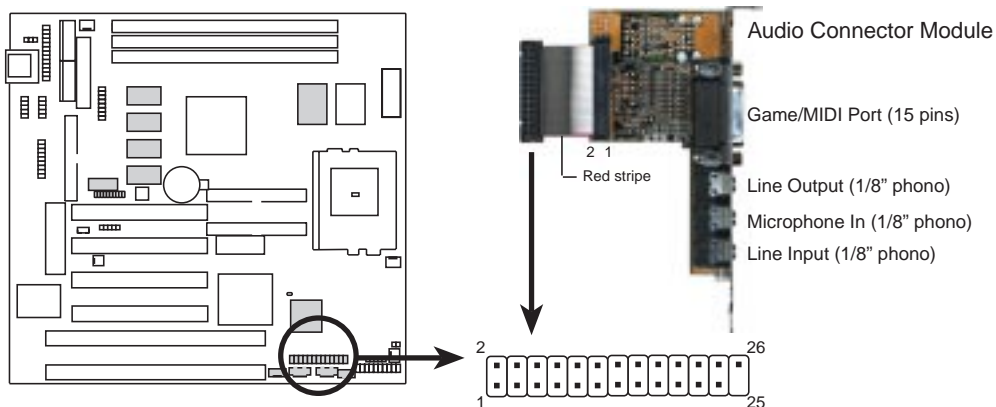

P5S-B Audio Header

III. HARDWARE SETUP

25. TV Out Connector (12-1 pin SCART)

This connector allows you to connect your computer directly to a TV with a SCART socket. **NOTE:** This connector is available only on motherboards with the optional SCART interface support.

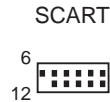
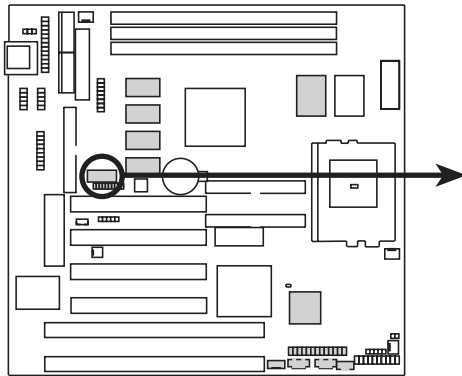

- | | |
|-------------|---------------------|
| 1: MODEM_IN | 7: GND |
| 2: SYNC | 8: GND |
| 3: RGB/AV# | 9: LUMA |
| 4: GND | 10: CHROMA |
| 5: GND | 11: COMPOSITE |
| 6: GND | 12: (No Connection) |

P5S-B TV Out Connector

26. LCD Header (20-1 pin LCDHD)

The LCD Header lets you connect an LCD monitor through the provided LCD cable with mounting bracket. Connect the cable to this header and mount the bracket to the case on a free expansion slot. You can make available the LCD port by setting DIP 2 – Switch 10 to *Enable* (ON). **NOTE:** This connector is available only on motherboards with the optional Digital Flat Panel (DFP) support.

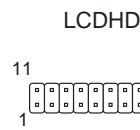
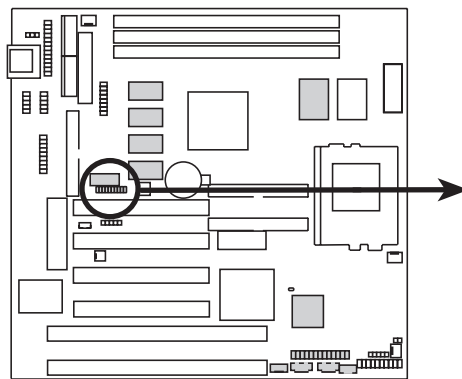

- | | |
|---------------------|---------------------|
| 1: FDDCLK | 11: FDDCDAT |
| 2: PLSENSE | 12: 0+5V |
| 3: GND | 13: TXC- |
| 4: TXC+ | 14: GND |
| 5: TX0- | 15: TX0+ |
| 6: GND | 16: TX1- |
| 7: TX1+ | 17: GND |
| 8: TX2- | 18: TX2+ |
| 9: GND | 19: (No connection) |
| 10: (No connection) | 20: (No connection) |

P5S-B LCD Header

III. HARDWARE SETUP

27. VGA Header (16-pin VGA)

The VGA Header lets you use the onboard AGP VGA and connect a standard (CRT) monitor through the provided VGA cable with mounting bracket. Connect the cable to this header and mount the bracket to the case on a free expansion slot. You can make available the VGA port by setting DIP 1 – Switch 2 to *Enable* (OFF).

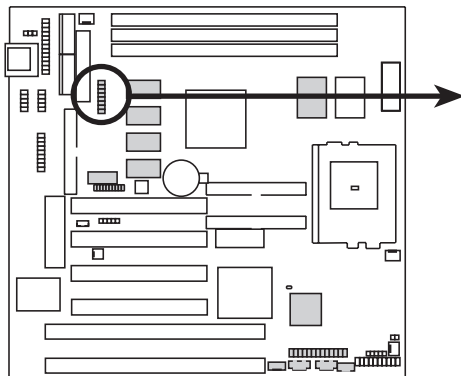

P5S-B VGA Header

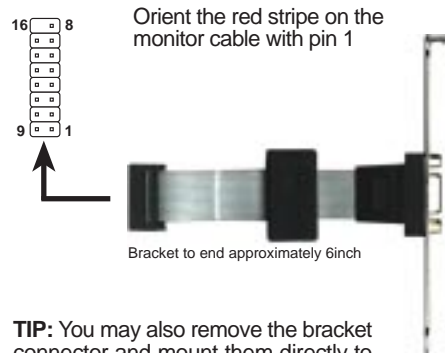

TIP: You may also remove the bracket connector and mount them directly to the case to save expansion slot space.

(This page was intentionally left blank.)

III. HARDWARE SETUP

Power Connection Procedures

1. After all jumpers and connections are made, close the system case cover.
2. Be sure that all switches are off (in some systems, marked with ○).
3. Connect the power supply cord into the power supply located on the back of your system case according to your system user's manual.
4. Connect the power cord into a power outlet that is equipped with a surge protector.
5. You may then turn on your devices in the following order:
 - a. Your monitor
 - b. External SCSI devices (starting with the last device on the chain)
 - c. Your system power. For ATX power supplies, you need to switch on the power supply as well as press the ATX power switch on the front of the case.
6. The power LED on the front panel of the system case will light. For ATX power supplies, the system LED will light when the ATX power switch is pressed. The monitor LED may light up after the system's if it complies with "green" standards or if it has a power standby feature. The system will then run power-on tests. While the tests are running, additional messages will appear on the screen. If you do not see anything within 30 seconds from the time you turn on the power, the system may have failed a power-on test. Recheck your jumper settings and connections or call your retailer for assistance.
7. During power-on, hold down <Delete> to enter BIOS setup. Follow the instructions in the next section, BIOS SETUP.

***Powering Off your computer:** You must first exit or shut down your operating system before switching off the power switch. For ATX power supplies, you can press the ATX power switch after exiting or shutting down your operating system. If you use Windows 95, click the **Start** button, click **Shut Down**, and then click **Shut down the computer?**. The power supply should turn off after Windows shuts down.

NOTE: The message "You can now safely turn off your computer" will not appear when shutting down with ATX power supplies.

IV. BIOS SETUP

Flash Memory Writer Utility

AFLASH.EXE: This is the Flash Memory Writer utility that updates the BIOS by uploading a new BIOS file to the programmable flash ROM chip on the motherboard. To determine the BIOS version of your motherboard, check the last four numbers of the code displayed on the upper left-hand corner of your screen during bootup. Larger numbers represent a newer BIOS file. This file works only in DOS mode.

NOTE: The following screen displays are provided as examples only and may not reflect the screen contents displayed on your system.

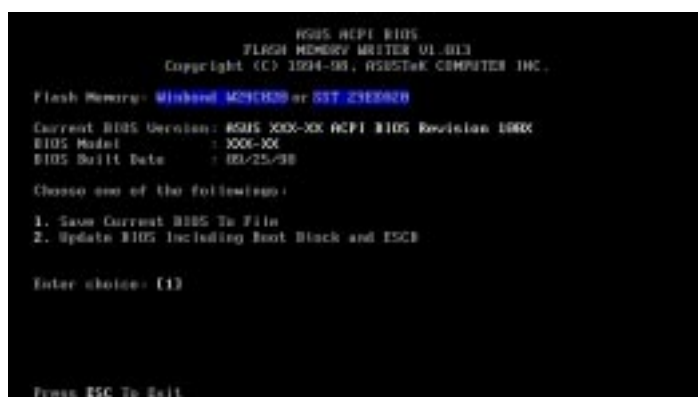

IMPORTANT! If “unknown” is displayed after **Flash Memory:**, the memory chip is either not programmable or is not supported by the ACPI BIOS and therefore, cannot be programmed by the Flash Memory Writer utility.

Main Menu

1. Save Current BIOS To File

This option allows you to save a copy of the original motherboard BIOS in case you need to reinstall it. It is recommended that you save **AFLASH.EXE** and the BIOS file to a bootable floppy disk.

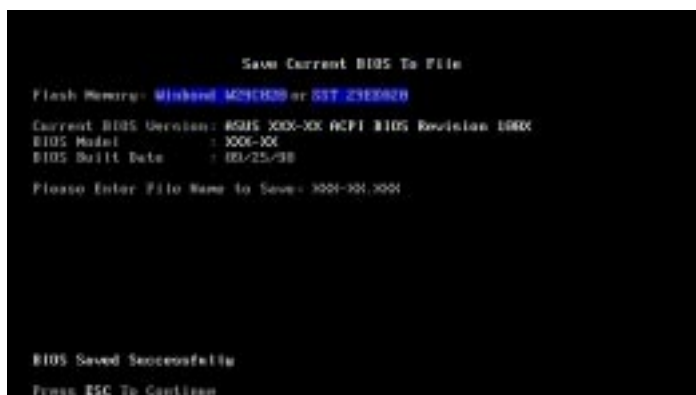

To save your current BIOS, type [1] at the **Main Menu** and then press <Enter>. The **Save Current BIOS To File** screen appears. Type a filename and the path and then press <Enter>.

IV. BIOS SETUP

2. Update BIOS Including Boot Block and ESCD

This option updates the boot block, the baseboard BIOS, and the ACPI extended system configuration data (ESCD) parameter block from a new BIOS file. See the next page for procedures on downloading an updated BIOS file.

To update your current BIOS, type [2] at the **Main Menu** and then press <Enter>. The **Update BIOS Including Boot Block and ESCD** screen appears. Type the filename of your new BIOS and the path and then press <Enter>.

```
Update BIOS Including Boot Block and ESCD
Flash Memory: Winbond W29C020 or SST 29E020
Current BIOS Version: 8525 3000-XX ACPI BIOS Revision 1000
BIOS Model          : 3000-XX
BIOS Build Date     : 09/25/98
Please Enter File Name for NEW BIOS: 81N3000-XX3000
```

When prompted to confirm the BIOS update, press **Y** to start the update.

```
Update BIOS Including Boot Block and ESCD
Flash Memory: Winbond W29C020 or SST 29E020
BIOS Version
(CURRENT) 3 8525 3000-XX ACPI BIOS Revision 1000
(Test.aud) 8525 3000-XX ACPI BIOS Revision 1000
BIOS Model
(CURRENT) 3 3000-XX
(Test.aud) 3000-XX
Date of BIOS Build
(CURRENT) 3 09/25/98
(DOOR,DOOR) 09/25/98
Check sum of XXXX.XXX is C370.
Are you sure (Y/N) ? Y
Press ESC To Return to Main Menu
```

The utility starts to program the new BIOS information into the flash ROM. When the programming is finished, *Flashed Successfully* will be displayed.

```
Update BIOS Including Boot Block and ESCD
Flash Memory: Winbond W29C020 or SST 29E020
BIOS Version
(CURRENT) 3 8525 3000-XX ACPI BIOS Revision 1000
(Test.aud) 8525 3000-XX ACPI BIOS Revision 1000
BIOS Model
(CURRENT) 3 3000-XX
(Test.aud) 3000-XX
Date of BIOS Build
(CURRENT) 3 09/25/98
(DOOR,DOOR) 09/25/98
Check sum of XXXX.XXX is C370.
Are you sure (Y/N) ? Y
Programming -- 3FFFF
Flashed Successfully
Press ESC To Return to Main Menu
```

Follow the onscreen instructions to continue.

```
8525 ACPI BIOS
FLASH MEMORY WRITER 01.B13
Copyright (C) 1994-98, ASUS/TAI COMPUTER INC.
Flash Memory: Winbond W29C020 or SST 29E020
Current BIOS Version: 8525 3000-XX ACPI BIOS Revision 1000
BIOS Model          : 3000-XX
BIOS Build Date     : 09/25/98
Choose one of the following:
1. Save Current BIOS To File
2. Update BIOS Including Boot Block and ESCD
Enter choice: [1]
You have flashed the EPROM. It is recommended that you turn off
the power, enter SETUP and Load Setup Defaults to have CMOS
updated with new BIOS when exits.
Press ESC To Exit
```

IV. BIOS SETUP
Flash Memory Writer

IV. BIOS SETUP

Managing and Updating Your Motherboard's BIOS

Upon First Use of the Computer System

1. Create a bootable system floppy disk by typing [FORMAT A:/S] from the DOS prompt without creating "AUTOEXEC.BAT" and "CONFIG.SYS" files.
2. Copy AFLASH.EXE to the just created boot disk.
3. Run AFLASH.EXE from this new disk and select option **1. Save Current BIOS to File**. See **1. Save Current BIOS To File** on the previous page for more details and the rest of the steps.

Updating BIOS Procedures (only when necessary)

1. Download an updated ASUS BIOS file from the Internet (WWW or FTP) or a BBS (Bulletin Board Service) (see ASUS CONTACT INFORMATION on page 3 for details) and save to the disk you created earlier.
2. Boot from the disk you created earlier.
3. At the "A:\>" prompt, type **AFLASH** and then press <Enter>.
4. At the **Main Menu**, type **2** and then press <Enter>. See **2. Update BIOS Including Boot Block and ESCD** on the previous page for more details and the rest of the steps.

WARNING! If you encounter problems while updating the new BIOS, DO NOT turn off your system since this might prevent your system from booting up. Just repeat the process, and if the problem still persists, update the original BIOS file you saved to disk above. If the Flash Memory Writer utility was not able to successfully update a complete BIOS file, your system may not be able to boot up. If this happens, your system will need service.

IV. BIOS SETUP

6. BIOS Setup

The motherboard supports 5-volt programmable 2-Mbit Flash ROM chips. These memory chips can be updated when BIOS upgrades are released. Use the Flash Memory Writer utility to download the new BIOS file into the ROM chip as described in detail in this section.

All computer motherboards provide a Setup utility program for specifying the system configuration and settings. If your motherboard came in a computer system, the proper configuration entries may have already been made. If so, invoke the Setup utility, as described later, and take note of the configuration settings for future reference; in particular, the hard disk specifications.

If you are installing the motherboard, reconfiguring your system or you receive a Run Setup message, you will need to enter new setup information. This section describes how to configure your system using this utility.

The BIOS ROM of the system stores the Setup utility. When you turn on the computer, the system provides you with the opportunity to run this program. This appears during the Power-On Self Test (POST). Press <Delete> to call up the Setup utility. If you are a little bit late pressing the mentioned key(s), POST will continue with its test routines, thus preventing you from calling up Setup. If you still need to call Setup, reset the system by pressing <Ctrl> + <Alt> + <Delete>, or by pressing the Reset button on the system case. You can also restart by turning the system off and then back on again. But do so only if the first two methods fail.

When you invoke Setup, the CMOS SETUP UTILITY main program screen will appear with the following options:



IV. BIOS SETUP

Load Defaults

Load BIOS Defaults loads the minimum settings for troubleshooting. **Load Setup Defaults**, on the other hand, is for loading optimized defaults for regular use. Choosing defaults at this level will modify all applicable settings.

A section at the bottom of the preceding screen displays the control keys for this screen. Take note of these keys and their respective uses.

Standard CMOS Setup

Standard CMOS Setup allows you to record some basic system hardware configuration and set the system clock and error handling. If the motherboard is already installed in a working system, you will not need to select this option anymore. However, if the configuration stored in the CMOS memory on the board gets lost or damaged, or if you change your system hardware configuration, you will need to respecify the configuration values. The configuration values usually get lost or corrupted when the power of the onboard CMOS battery weakens.



The preceding screen provides you with a list of options. At the bottom of this screen are the control keys. Take note of these keys and their respective uses.

User-configurable fields appear in a different color. If you need information on the selected field, press <F1>. The help menu will then appear to provide you with the information you need. The memory display at the lower right of the screen is read-only and automatically adjusts accordingly.

Details of Standard CMOS Setup

Date

To set the date, highlight the “Date” field and then press either <Page Up>/<Page Down> or <+>/<-> to set the current date. Follow the month, day and year format. Valid values for month, day and year are: **Month: (1 to 12), Day: (1 to 31), Year: (up to 2079)**

IV. BIOS SETUP

Time

To set the time, highlight the “Time” field and then press either <Page Up>/<Page Down> or <+>/<-> to set the current time. Follow the hour, minute and second format. Valid values for hour, minute and second are: (**Hour: (00 to 23)**), (**Minute: (00 to 59)**), (**Second: (00 to 59)**). If you do not want to modify the current time, press <Enter> three times to go to **HARD DISKS**.

NOTE: You can bypass the date and time prompts by creating an AUTOEXEC.BAT file. For information on how to create this file, refer to the MS-DOS manual.

Hard Disk Drives

This field records the specifications for all non-SCSI hard disk drives installed in your system. The onboard PCI IDE connectors provide Primary and Secondary channels for connecting up to four IDE hard disks or other IDE devices. Each channel can support up to two hard disks; the first of which is the “master” and the second is the “slave”.

Specifications for SCSI hard disks need not to be entered here since they operate using device drivers and are not supported by any the BIOS. If you install either the optional PCI-SC200 or PCI-SC860 SCSI controller card into the motherboard, see section VI for instructions. If you install other vendor’s SCSI controller card, refer to their respective documentations on how to install the required SCSI drivers.

For IDE hard disk drive setup, you can:

- Use the *Auto* setting for detection during bootup.
- Use the IDE HDD AUTO DETECTION in the main menu to automatically enter the drive specifications.
- Enter the specifications yourself manually by using the “User” option.

The entries for specifying the hard disk type include **CYLS** (number of cylinders), **HEAD** (number of read/write heads), **PRECOMP** (write precompensation), **LANDZ** (landing zone), **SECTOR** (number of sectors) and **MODE**. The **SIZE** field automatically adjusts according to the configuration you specify. The documentation that comes with your hard disk should provide you with the information regarding the drive specifications.

The **MODE** entry is for IDE hard disks only, and can be ignored for MFM and ESDI drives. This entry provides three options: *Normal*, *Large*, *LBA*, or *Auto* (see below). Set **MODE** to the *Normal* for IDE hard disk drives smaller than 528MB; set it to *LBA* for drives over 528MB that support Logical Block Addressing (LBA) to allow larger IDE hard disks; set it to *Large* for drives over 528MB that do not support LBA. *Large* type of drive can only be used with MS-DOS and is very uncommon. Most IDE drives over 528MB support the *LBA* mode.

IV. BIOS SETUP

Auto detection of hard disks on bootup

For each field: Primary Master, Primary Slave, Secondary Master, and Secondary Slave, you can select *Auto* under the TYPE and MODE fields. This will enable auto detection of your IDE hard disk during bootup. This will allow you to change your hard disks (with the power off) and then power on without having to reconfigure your hard disk type. If you use older hard disks that do not support this feature, then you must configure the hard disk in the standard method as described earlier by the “User” option.

NOTE: After the IDE hard disk drive information has been entered into BIOS, new IDE hard disk drives must be partitioned (such as with FDISK) and then formatted before data can be read from and write on. Primary IDE hard disk drives must have its partition set to *active* (also possible with FDISK).

NOTE: SETUP Defaults are noted in parenthesis next to each function heading.

Drive A / Drive B (None)

These fields record the types of floppy disk drives installed in your system. The available options for drives A and B are: *360K, 5.25 in.; 1.2M, 5.25 in.; 720K, 3.5 in.; 1.44M, 3.5 in.; 2.88M, 3.5 in.; None*

To enter the configuration value for a particular drive, highlight its corresponding field and then select the drive type using the left- or right-arrow keys.

Floppy 3 Mode Support (Disabled)

This is the Japanese standard floppy drive. The standard stores 1.2MB in a 3.5inch diskette. This is normally disabled but you may choose from either: *Drive A, Drive B, Both, and Disabled*

Video (EGA/VGA)

Set this field to the type of video display card installed in your system. The options are *EGA/VGA, CGA 40, CGA 80, and MONO* (for Hercules or MDA).

If you are using a VGA or any higher resolution card, choose *EGA/VGA*.

Halt On (All Errors)

This field determines which types of errors will cause the system to halt. Choose from *All Errors; No Errors; All,But Keyboard; All,But Diskette; and All,But Disk/Key*.

IV. BIOS SETUP

BIOS Features Setup

BIOS Features Setup consists of configuration entries that allow you to improve your system performance, or let you set up some system features according to your preference. Some entries are required by the motherboard's design to remain in their default settings.



A section at the lower right of the screen displays the control keys you can use. Take note of these keys and their respective uses. If you need information on a particular entry, highlight it and then press <F1>. A pop-up help menu will appear to provide you with the information you need. <F5> loads the last set values, <F6> and <F7> loads the BIOS default values and Setup default values, respectively.

NOTE: SETUP Defaults are noted in parenthesis next to each function heading.

Details of BIOS Features Setup

Boot Virus Detection (Enabled)

This field allows you to set boot virus detection, ensuring a virus-free boot sector. This new antivirus solution is unlike native BIOS tools, which offer limited virus protection typically by write-protecting the partition table. With this new solution, your computer is protected against boot virus threats earlier in the boot cycle, that is, before they have a chance to load into your system. This ensures your computer boots to a clean operating system. The system halts and displays a warning message when it detects a virus. If this occurs, you can either allow the operation to continue or use a virus-free bootable floppy disk to restart and investigate your system. Because of conflicts with new operating systems, for example, during installation of new software, you may have to set this to *Disabled* to prevent write errors.

CPU Internal Cache (Enabled)

Choose *Disable* to turn off the CPU's built-in level 1 cache.

External Cache (Enabled)

Choose *Disable* to turn off the CPU's external level 2 cache.

IV. BIOS SETUP

Quick Power On Self Test (Enabled)

This field speeds up the Power-On Self Test (POST) routine by skipping retesting a second, third, and fourth time. Setup default setting for this field is *Enabled*. A complete test of the system is done on each test.

HDD Sequence SCSI/IDE First (IDE)

When using both SCSI and IDE hard disk drives, IDE is always the boot disk using drive letter C (default setting of *IDE*). This new feature allows a SCSI hard disk drive to be the boot disk when set to *SCSI*. This allows multiple operating systems to be used on both IDE and SCSI drives or the primary operating system to boot using a SCSI hard disk drive.

Boot Sequence (A,C)

This field determines where the system looks first for an operating system. Options are *A,C*; *A,CDROM,C*; *CDROM,C,A*; *CDROM A,C*; *D,A*; *E,A*; *F,A*; *C only*; *LS/ZIP,C*; *LAN,A,C*; *LAN,C,A*; and *C,A*. The setup default setting, *A,C*, checks first the floppy disk and then the hard disk drive.

Boot Up Floppy Seek (Disabled)

When enabled, the BIOS will seek drive A one time.

Floppy Disk Access Control (R/W)

This allows protection of files from the computer system to be copied to floppy disk drives by allowing the setting of *Read Only* to only allow reads from the floppy disk drive but not writes. The setup default *R/W* allows both reads and writes.

IDE HDD Block Mode Sectors (HDD MAX)

This field enhances hard disk performance by making multi-sector transfers instead of one sector per transfer. Most IDE drives, except older versions, can utilize this feature. Selections are *HDD MAX*, *Disabled*, *2*, *4*, *8*, *16*, and *32*.

HDD S.M.A.R.T. capability (Disabled)

This field enables or disables S.M.A.R.T. (Self-Monitoring Analysis and Reporting Technology) support for S.M.A.R.T.-capable hard disk drives. This technology requires an application that can display S.M.A.R.T. warning messages.

PS/2 Mouse Function Control (Auto)

The setting of *Auto* allows the system to detect a PS/2 Mouse on bootup. If detected, IRQ12 will be used for the PS/2 Mouse. If not detected, IRQ12 will be reserved for expansion cards. *Enabled* will reserve IRQ12 for the PS/2 Mouse.

OS/2 Onboard Memory > 64M (Disabled)

When using OS/2 operating systems with installed DRAM of greater than 64MB, you need to *Enable* this option otherwise leave this on the setup default of *Disabled*.

.....

PCI/VGA Palette Snoop (Disabled)

Some display cards that are nonstandard VGA, such as graphic accelerators or MPEG video cards may not show colors properly. Setting this to *Enabled* should correct this problem. Otherwise, leave this on the default setting of *Disabled*.

IV. BIOS SETUP

Video ROM BIOS Shadow (Enabled)

This field allows you to change the video BIOS location from ROM to RAM. Relocating to RAM enhances system performance, as information access is faster than the ROM.

C8000 - CBFFF Shadow to DC000 - DFFFF Shadow (Disabled)

These fields are used for shadowing other expansion card ROMs. If you install other expansion cards with ROMs on them, you will need to know which addresses the ROMs use to shadow them specifically. Shadowing a ROM reduces the memory available between 640KB and 1024KB by the amount used for this purpose.

Boot Up NumLock Status (On)

This field enables users to activate the Number Lock function upon system boot.

Typematic Rate Setting (Disabled)

When enabled, you can set the **Typematic Rate** and **Delay**.

Typematic Rate (Chars/Sec) (6)

This field controls the speed at which the system registers repeated keystrokes. Options range from 6 to 30 characters per second. Setup default setting is **6**; other settings are **8, 10, 12, 15, 20, 24, and 30**.

Typematic Delay (Msec) (250)

This field sets the time interval for displaying the first and second characters. Four delay rate options are available: 250, 500, 750, and 1000.

Security Option (System)

When you specify a *Supervisor Password* and/or *User Password* (explained later in this section), the Security Option field determines when the system prompts for the password. The default setting is **System**, where the system prompts for the User Password every time you start your system. The other option is *Setup*, where the system goes through its startup routine unless the Setup utility is called, when the system prompts for the Supervisor Password.

IV. BIOS SETUP

Chipset Features Setup

Chipset Features Setup controls the configuration of the board's chipset. Control keys for this screen are the same as in the **BIOS Features Setup** screen.



NOTE: SETUP Defaults are noted in parenthesis next to each function heading.

Details of Chipset Features Setup

SDRAM Configuration (By SPD)

This sets the optimal timing for items 2-4. Leave on default setting, depending on the memory modules that you are using. Default setting is *By SPD*, which configures items 2-4 by reading the contents in the SPD (Serial Presence Detect) device. This 8-pin serial EEPROM device stores critical parameter information about the module, such as memory type, size, speed, voltage interface, and module banks.

SDRAM CAS Latency

This controls the latency between SDRAM read command and the time that the data actually becomes available. Leave on default setting.

SDRAM RAS Precharge Time

This controls the idle clocks after issuing a precharge command to SDRAM. Leave on default setting.

SDRAM RAS to CAS Delay

This controls the latency between SDRAM active command and the read/write command. Leave on default setting.

ROM Cycle Wait State (4-Wait)

Leave both on default setting.

16-bit I/O Recovery Time (5 BUSCLK) / 8-bit I/O Recovery Time (8 BUSCLK)

Timing for 16- and 8-bit ISA cards, respectively. Leave on default settings.

ISA Bus Clock (PCICLK/4)

Leave on default setting.

IV. BIOS SETUP

Graphics Aperture Size (64MB)

Memory-mapped, graphics data structures can reside in a Graphics Aperture. Leave on default setting.

Memory Hole At Address (None)

This allows you to specify the memory address space to be reserved for ISA expansion cards that specifically require this setting. Setting the address space to a particular setting (available settings: *15M-16M*, *14M-16M*, *12M-16M*) will make that memory space unavailable to the system. Expansion cards can only access memory up to 16M. The default is *None*.

Delayed Transaction (Enabled)

If *Enabled*, this frees the PCI Bus during CPU accessing of 8-bit ISA cards that normally consume about 50-60 PCI Clocks without PCI delayed transaction. If PCI Bus Masters cannot use the PCI Bus, leave this on the default setting of *Disabled* for some ISA cards that are not PCI 2.1 compliant.

VGA Shared Memory Size (4MB)

This allows you to specify the memory size (available settings: *2MB*, *4MB*, *8MB*) to be shared with the onboard VGA controller. Default setting is *4MB*.

.....

Onboard FDC Controller (Enabled)

When enabled, this field allows you to connect your floppy disk drives to the onboard floppy drive connector instead of a separate controller card. If you want to use a different controller card to connect the floppy disk drives, set this field to *Disabled*.

Onboard FDC Swap A & B (No Swap)

This field allows you to reverse the hardware drive letter assignments of your floppy disk drives. Two options are available: *Swap AB* and *No Swap* (default). If you want to switch drive letter assignments, set this field to *Swap AB*, and the swap will be controlled by the onboard chipset.

Onboard Serial Port 1 (3F8H/IRQ4)

Settings are *3F8H/IRQ4*, *2F8H/IRQ3*, *3E8H/IRQ4*, *2E8H/IRQ10*, and *Disabled* for the onboard serial connector.

Onboard Serial Port 2 (2F8H/IRQ3)

Settings are *3F8H/IRQ4*, *2F8H/IRQ3*, *3E8H/IRQ4*, *2E8H/IRQ10*, and *Disabled* for the onboard serial connector.

Onboard Parallel Port (378H/IRQ7)

This field sets the address of the onboard parallel port connector. You can select either *3BCH/IRQ7*, *378H/IRQ7*, *278H/IRQ5*, or *Disabled*. If you install an I/O card with a parallel port, ensure that there is no conflict in the address assignments. The PC can support up to three parallel ports as long as there are no conflicts for each port.

IV. BIOS SETUP

Parallel Port Mode (ECP+EPP)

This field allows you to set the operation mode of the parallel port. The setting *Normal*, allows normal-speed operation but in one direction only; *EPP* allows bidirectional parallel port operation at maximum speed; *ECP* allows the parallel port to operate in bidirectional mode and at a speed faster than the maximum data transfer rate; *ECP+EPP* allows normal speed operation in a two-way mode.

ECP DMA Select (3)

This selection is available only if you select *ECP* or *ECP+EPP* in the **Parallel Port Mode**. Select either DMA Channel *1*, *3*, or *Disabled*.

UART2 Use Infrared (Disabled)

When enabled, this field activates the onboard infrared feature and sets the second serial UART to support the infrared module connector on the motherboard. If your system already has a second serial port connected to the onboard COM2 connector, it will no longer work if you enable the infrared feature. By default, this field is set to *Disabled*, which leaves the second serial port UART to support the COM2 serial port connector. See **IrDA/Fast IR-Compliant Infrared Module Connector** under section III.

Onboard PCI IDE Enable (Both)

You can select to enable the *Primary* IDE channel, *Secondary* IDE channel, *Both*, or *Disable* both channels (for systems with only SCSI drives).

IDE Ultra DMA Mode (Auto)

This sets the IDE UltraDMA to be active when using UltraDMA-capable IDE devices. The BIOS will automatically adjust or disable this setting for slower IDE devices so that Auto or high settings will not cause problems for older IDE devices. Choose *Disable* if you do not want this feature for all devices.

IDE 0 Master/Slave PIO/DMA Mode, IDE 1 Master/Slave PIO/DMA Mode (Auto)

Each channel (0 and 1) has both a master and a slave making four IDE devices possible. Because each IDE device may have a different Mode timing (0, 1, 2, 3, 4), it is necessary for these to be independent. PIO and DMA timings can be independently set. The default setting of *Auto* will allow autodetection to ensure optimal performance.

IV. BIOS SETUP

Power Management Setup

Power Management Setup allows you to reduce power consumption. This feature turns off the video display and shuts down the hard disk after a period of inactivity.



NOTE: SETUP Defaults are noted in parenthesis next to each function heading.

Details of Power Management Setup

Power Management (User Define)

This field acts as the master control for the power management modes. *User Define* allows you to set power saving options according to your preference; *Disable* disables the power saving features; *Min Saving* puts the system into power saving mode after 40 min of system inactivity; *Max Saving* puts the system into power saving mode after 30 sec of system inactivity.

IMPORTANT: Advanced Power Management (APM) should be installed to keep the system time updated when the computer enters suspend mode activated by the BIOS Power Management. For DOS environments, you need to add `DEVICE=C:\DOS\POWER.EXE` in your `CONFIG.SYS`. For Windows 3.x and Windows 95, you need to install Windows with the APM feature. A battery and power cord icon labeled *Power* will appear in the **Control Panel**. Double-click *Power* to adjust your system's power properties and then click *Advanced* in the Power Management dialogue box. Windows 98, by default, installs the APM. Double-click *Power Management* in the **Control Panel** to select your preferred *Power Schemes* and/or power management behaviors (under the *Advanced* tab).

Video Off Option (Susp,Stby -> Off)

This field determines when to activate the video off feature for monitor power management. The settings are *All Modes -> Off*; *Always On*; *Suspend -> Off*; and *Susp,Stby -> Off*.

IV. BIOS SETUP

Video Off Method (DPMS OFF)

This field defines the video off features. These options are available: *DPMS OFF*, *DPMS Reduce ON*, *Blank Screen*, *V/H SYNC+Blank*, *DPMS Standby*, and *DPMS Suspend*. The DPMS (Display Power Management System) features allow the BIOS to control the video display card if it supports the DPMS feature. *Blank Screen* only blanks the screen (for monitors without power management or “green” features). If set up in your system, your screen saver will not display with *Blank Screen* selected). *V/H SYNC+Blank* blanks the screen and turns off vertical and horizontal scanning.

.....

PM Timers

This section controls the time-out settings for the Power Management scheme. The fields included in this section are **HDD Power Down**, which places the hard disk into its lowest power consumption mode, and the **Doze**, **Standby** and **Suspend** system inactivation modes.

The system automatically “wakes up” from any power saving mode when there is system activity, such as when a key is pressed from the keyboard, or when there is activity detected from the enabled IRQ channels.

HDD Power Down (Disable)

This shuts down any IDE hard disk drives in the system after a period of inactivity. This time period is user-configurable from *1 Min* to *15 Min* or *Disable*. This feature does not affect SCSI hard disks.

Doze Mode, Standby Mode, Suspend Mode (Disable)

These fields set the period of time after which each of these modes activate: *1 Min*, *2 Min*, *3 Min*, *4 Min*, *8 Min*, *20 Min*, *30 Min*, *40 Min*, or *1 Hour*. The default setting is *Disable*.

.....

Power Up Control

This section determines the ways the system can be controlled when it is started or restarted, when modem activity is detected, or when power to the computer is interrupted and reapplied.

AC PWR Loss Restart (Disabled)

This allows you to set how you want your system to boot up after the power has been interrupted. **Disabled** leaves your system off after reapplying power and **Enabled** boots up your system after reapplying power.

Ring Power Up (Enable)

This allows either settings of *Enable* or *Disable* for powering up the computer (turns the ATX power supply on) when the modem receives a call while the computer is off.

NOTE: The computer cannot receive or transmit data until the computer and applications are fully running, thus connection cannot be made on the first try. Turning an external modem off and then back on while the computer is off causes an initialization string that will also cause the system to power on.

IV. BIOS SETUP

Wake On LAN (Disable)

This allows you to remotely power up your system through your network by sending a wake-up frame or signal. With this feature, you can remotely upload/download data to/from systems during off-peak hours. Set to *Enable* to use this feature.

IMPORTANT: This feature requires the ASUS PCI-L101 LAN Card (see **APPENDIX**) or a similar ethernet card and an ATX power supply with at least 720mA +5V standby power.

Automatic Power Up (Disable)

This allows you to have an unattended or automatic power up of your system. You may configure your system to power up at a certain time of a day in a week by selecting *Enable*.

.....

Fan Monitor (xxxxRPM)

The onboard hardware monitor is able to detect the Chassis Fan Speed and CPU Fan Speed in Rotations Per Minute (RPM). These values refresh upon any key entries in the BIOS setup screen. Set to *Ignore* if one of these are not used so that error messages will not be given.

Thermal Monitor (xxxC/xxxF)

The onboard hardware monitor is able to detect the CPU temperature. These values refresh upon key entries. Set to *Ignore* only if necessary.

Voltage Monitor (xx.xV)

The onboard hardware monitor is able to detect the voltages put out by the voltage regulators. These values refresh upon key entries. Set to *Ignore* only if necessary.

NOTE: If any of the monitored items are out of range, an error message will appear: "Hardware Monitor found an error, enter POWER MANAGEMENT SETUP for details". You will then be prompted to "Press **F1** to continue, **DEL** to enter SETUP".

IV. BIOS SETUP

PNP and PCI Setup

This “PNP and PCI Setup” option configures the PCI bus slots. All PCI bus slots on the system use INTA#, thus all installed PCI cards must be set to this value.

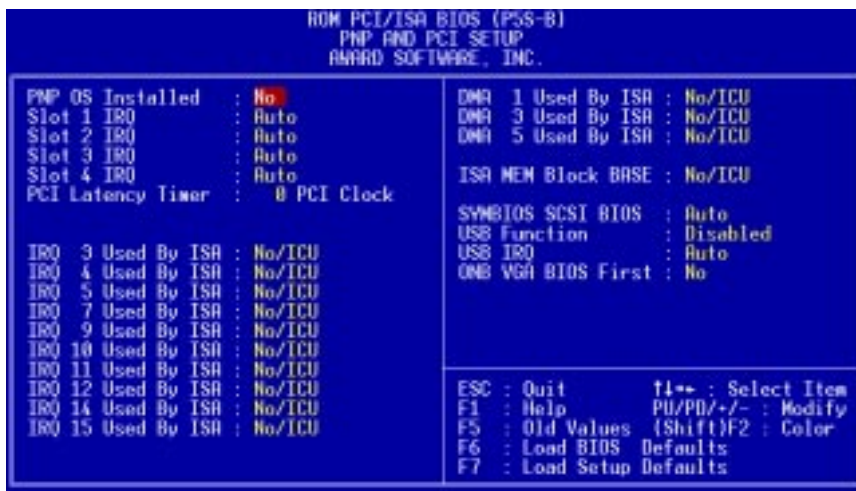

NOTE: SETUP Defaults are noted in parenthesis next to each function heading.

Details of PNP and PCI Setup

PNP OS Installed (No)

This field allows you to use a Plug-and-Play (PnP) operating system to configure the PCI bus slots instead of using the BIOS. Thus interrupts may be reassigned by the OS when *Yes* is selected. When a non-PnP OS is installed or to prevent reassigning of interrupt settings, select the default setting of *No*.

Slot 1 IRQ (Auto) / Slot 2 IRQ (Auto) / Slot 3 IRQ (Auto) / Slot 4 IRQ (Auto)

These fields set how IRQ use is determined for each PCI slot. The default setting for each field is *Auto*, which uses auto-routing to determine IRQ use. The other options are manual settings of *NA*, *3*, *4*, *5*, *7*, *9*, *10*, *11*, *12*, *14* or *15* for each slot.

PCI Latency Timer (32 PCI Clock)

The default setting of *32 PCI Clock* enables maximum PCI performance.

IRQ xx Used By ISA (No/ICU)

These fields indicate whether or not the displayed IRQ for each field is being used by a legacy (non-PnP) ISA card. Two options are available: *No/ICU* and *Yes*. The first option, the default value, indicates either that the displayed IRQ is not used or an ISA Configuration Utility (ICU) is being used to determine if an ISA card is using that IRQ. If you install a legacy ISA card that requires a unique IRQ, and you are not using an ICU, you must set the field for that IRQ to *Yes*. For example: If you install a legacy ISA card that requires IRQ 10, then set **IRQ10 Used By ISA** to *Yes*.

.....

IV. BIOS SETUP

DMA x Used By ISA (No/ICU)

These fields indicate whether or not the displayed DMA channel for each field is being used by a legacy (non-PnP) ISA card. Available options include: *No/ICU* and *Yes*. The first option, the default setting, indicates either that the displayed DMA channel is not used or an ICU is being used to determine if an ISA card is using that channel. If you install a legacy ISA card that requires a unique DMA channel, and you are not using an ICU, you must set the field for that channel to *Yes*.

ISA MEM Block BASE (No/ICU)

This field allows you to set the base address and block size of a legacy ISA card that uses any memory segment within the C800H and DFFFH address range. If you have such a card, and you are not using an ICU to specify its address range, select a base address from the six available options; the **ISA MEM Block SIZE** field will then appear for selecting the block size. If you have more than one legacy ISA card in your system that requires to use this address range, you can increase the block size to either 8K, 16K, 32K, or 64K. If you are using an ICU to accomplish this task, leave **ISA MEM Block BASE** to its default setting of *No/ICU*.

SYMBIOS SCSI BIOS (Auto)

Auto allows the BIOS to detect whether you have a Symbios SCSI card, if detected the onboard Symbios BIOS will be enabled, if not then it will be disabled. *Disabled* prevents the onboard Symbios BIOS to be enabled so that the external Symbios SCSI card's own BIOS can be used instead. **Note:** If your Symbios SCSI card does not have a BIOS the Symbios SCSI card will not function.

USB Function (Disabled)

This motherboard supports Universal Serial Bus (USB) devices. Set to *Enabled* if you want to use USB devices. Your system must support USB function. The default setting is *Disabled*.

USB IRQ (Auto)

This field allows you to reserve an IRQ# (3, 4, 5, 7, 9, 10, 11, 12, 14, or 15) for the USB to work. *Auto* assigns an IRQ# automatically to your USB device. If you are not using a USB device, you may disable this feature by setting it to *NA* to save an extra IRQ# for other devices or expansion cards.

ONB VGA BIOS First (No)

This field, when set to *Yes*, gives priority to the onboard VGA BIOS over other VGA controllers. The default setting is *No*.

IV. BIOS SETUP

Supervisor Password and User Password

These two options set the system passwords. “Supervisor Password” sets a password that will be used to protect the system and the Setup utility; “User Password” sets a password that will be used exclusively on the system. By default, the system comes without any passwords. To specify a password, highlight the type you want and then press <Enter>. A password prompt appears on the screen. Taking note that the password is case sensitive, and can be up to 8 alphanumeric characters long, type in your password and then press <Enter>. The system confirms your password by asking you to type it again. After setting a password, the screen automatically reverts to the main screen.



To implement password protection, specify in the “Security Option” field of the BIOS Features Setup screen when the system will prompt for the password. If you want to disable either password, press <Enter> instead of entering a new password when the “Enter Password” prompt appears. A message confirms the password has been disabled.

Forgot the password?

If you forgot the password, you can clear the password by erasing the CMOS Real Time Clock (RTC) RAM. The RAM data containing the password information is powered by the onboard button cell battery. To erase the RTC RAM: (1) Unplug your computer, (2) Short the solder points, (3) Turn ON your computer, (4) Hold down <Delete> during bootup and enter BIOS setup to re-enter user preferences.

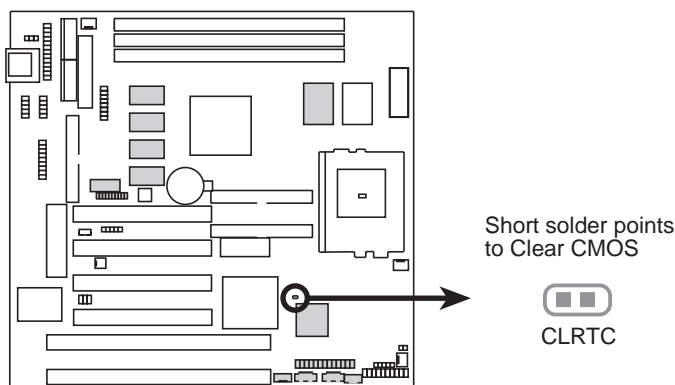

P5S-B Clear RTC RAM

IV. BIOS SETUP

IDE HDD Auto Detection

This “IDE HDD Auto Detection” option detects the parameters of an IDE hard disk drive, and automatically enters them into the Standard CMOS Setup screen.

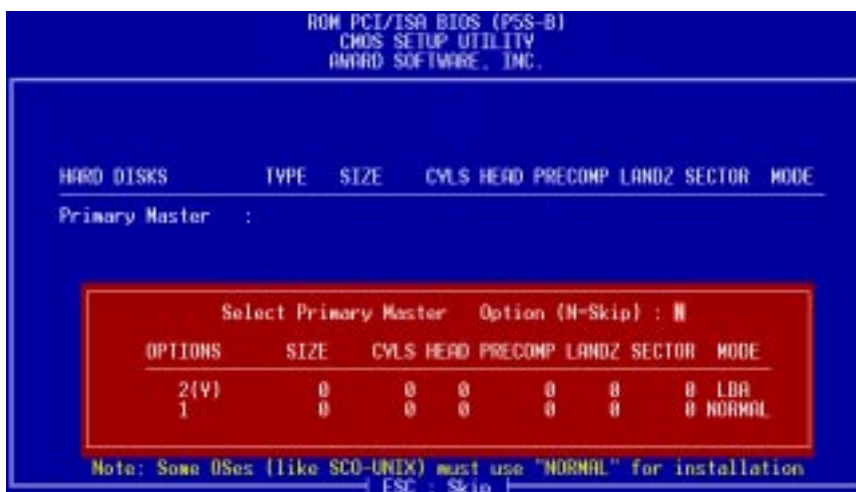

Up to four IDE drives can be detected, with parameters for each listed inside the box. To accept the optimal entries, press <Y> or else select from the numbers displayed under the OPTIONS field (2, 1, 3 in this case); to skip to the next drive, press <N>. If you accept the values, the parameters will appear listed beside the drive letter on the screen. The process then proceeds to the next drive letter. Pressing <N> to skip rather than to accept a set of parameters causes the program to enter zeros after that drive letter.

Remember that if you are using another IDE controller that does not feature Enhanced IDE support for four devices, you can only install two IDE hard disk drives. Your IDE controller must support the Enhanced IDE features in order to use Drive E and Drive F. The onboard PCI IDE controller supports Enhanced IDE, with two connectors for connecting up to four IDE devices. If you want to use another controller that supports four drives, you must disable the onboard IDE controller in the Chipset Features Setup screen.

When auto-detection is completed, the program automatically enters all entries you accepted on the field for that drive in the Standard CMOS Setup screen. Skipped entries are ignored and are not entered in the screen.

If you are auto-detecting a hard disk that supports the LBA mode, three lines will appear in the parameter box. Choose the line that lists LBA for an LBA drive. Do not select Large or Normal.

The auto-detection feature can only detect one set of parameters for a particular IDE hard drive. Some IDE drives can use more than one set. This is not a problem if the drive is new and empty.

IV. BIOS SETUP

IMPORTANT: If your hard disk was already formatted on an older previous system, incorrect parameters may be detected. You will need to enter the correct parameters manually or use low-level format if you do not need the data stored on the hard disk.

If the parameters listed differ from the ones used when the disk was formatted, the disk will not be readable. If the auto-detected parameters do not match the ones that should be used for your disk, do not accept them. Press <N> to reject the presented settings and enter the correct ones manually from the Standard CMOS Setup screen.

Save & Exit Setup

Select this option to save into the CMOS memory all modifications you specified during the current session. To save the configuration changes, highlight the “Save & Exit Setup” option on the main screen, type “Y”, and then press <Enter>.

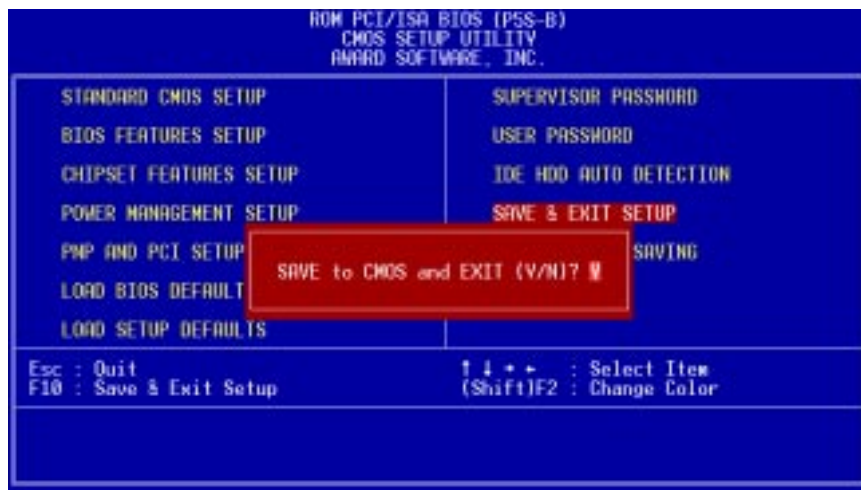

IV. BIOS SETUP
Save

Exit Without Saving

Select this option to exit the Setup utility without saving the modifications you specify during the current session. To exit without saving, highlight the “Exit Without Saving” option on the main screen and then press <Enter>.

(This page was intentionally left blank.)



V. SOFTWARE SETUP	69
Operating Systems	69
Windows 98 First Time Installation	69
P5S-B Support CD	70
Installation Menu	70
Install ASUS PC Probe Vx.xx	71
Install VGA Driver	72
Install Audio Driver (only with onboard audio option)	73
Install ESS AudioRack32 (only with onboard audio option)	74
Install ESS Software Wave Table (only with onboard audio option)	75
Install PC-Cillin 98 Vx.xx	76
Install ADOBE AcroBat Reader Vx.x	77
Install Bus Master IDE Driver	78
Uninstalling Programs	79

V. SOFTWARE SETUP

Operating Systems

You should always use the latest operating system and updates when using new hardware to ensure full compliancy. For Windows 95, you must use OSR 2.0 or later. For Windows NT 4.0, you must use Service Pack 3.0 or later.

Windows 98 First Time Installation

When you start Windows for the first time after the installation of your motherboard, Windows 98 will detect the onboard audio and video chips and may attempt to install a driver from its system registry. When prompted to restart, select **No** and then follow the normal setup procedures later in this section.

IMPORTANT: Selecting **No** for the initial restart prompt is a necessary step because Windows may load an older display driver that is incompatible with the onboard VGA chip. Always use the driver available on the ASUS Support CD or an applicable driver update from your ASUS vendor or from the ASUS web site.

NOTE: The screen displays in this and the following section may not reflect exactly the screen contents displayed on your screen.

V. SOFTWARE SETUP

P5S-B Support CD

NOTE: The support CD contents are subject to change at any time without notice.

To begin using your support CD disc, just insert it into your CD-ROM drive and the support CD installation menu should appear. If the menu does not appear, double click or run **D:\SETUP.EXE** (assuming that your CD-ROM drive is drive **D:**).

Installation Menu

- **Install ASUS PC Probe Vx.xx:** Installs a simple utility to monitor your computer's fan, temperature, and voltages.
- **Install VGA Driver:** Installs the necessary VGA drivers and utilities to access the features of the integrated VGA controller.
- **Install Audio Driver (Optional):** Installs the necessary audio drivers and utilities to access the features of the built-in PCI audio chipset.
- **Install ESS AudioRack32 (Optional):** Installs the ESS AudioRack utilities. Refer to the online help for more information.
- **Install ESS Software Wave Table (Optional):** Expands the audio sound card capability for increased sound effects.
- **Install PCCillin 98 Vx.xx:** Installs the PC-cillin virus protection software. View the online help for more information.
- **Install ADOBE Acrobat Reader Vx.x:** Installs the Adobe Acrobat Reader software necessary to view user's manuals saved in PDF format. Updated or other language versions of this motherboard's manual is available in PDF format at any of our web sites.
- **Show Motherboard Information:** Allows you to view information about your motherboard, such as product name, BIOS version, and CPU.
- **Browse Support CD:** Allows you to view the contents of the CD.
- **ReadMe:** Displays the filelist for the included support software.
- **Exit:** Exits the CD installation menu. (Click **RIGHT ARROW** on the lower-right corner of the main menu.)



Additional CD Contents: DMI Configuration Utility in the **DMI** folder, Flash BIOS writer in the **AFLASH** folder, IDE Bus Master driver for improved performance under Windows NT in the **BUSMASTR** folder, USB patch to fix problems when using the USB driver under Windows 95 OSR 2.1 in the **USBPATCH** folder.

V. SOFTWARE SETUP

Install ASUS PC Probe Vx.xx

Insert the Support CD that came with your motherboard into your CD-ROM drive or double-click the CD drive icon in **My Computer** to bring up the setup screen.

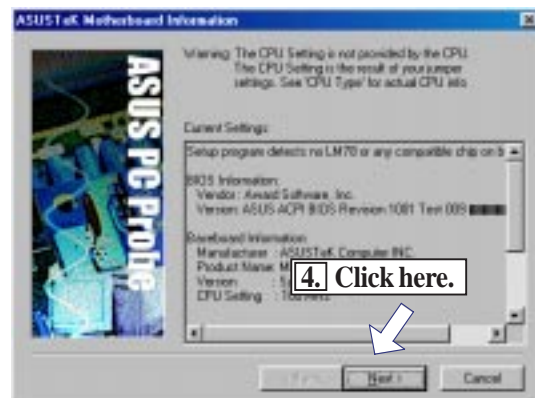

V. SOFTWARE SETUP

Install VGA Driver

Insert the Support CD that came with your motherboard into your CD-ROM drive or double-click the CD drive icon in **My Computer** to bring up the setup screen.

Install VGA Driver installs the video driver necessary to have higher VGA performance, resolutions, and special features.

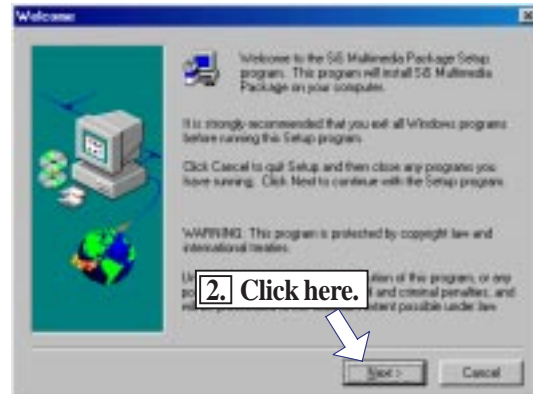

V. SOFTWARE SETUP

Install Audio Driver (only with onboard audio option)

Insert the Support CD that came with your motherboard into your CD-ROM drive or double-click the CD drive icon in **My Computer** to bring up the setup screen.

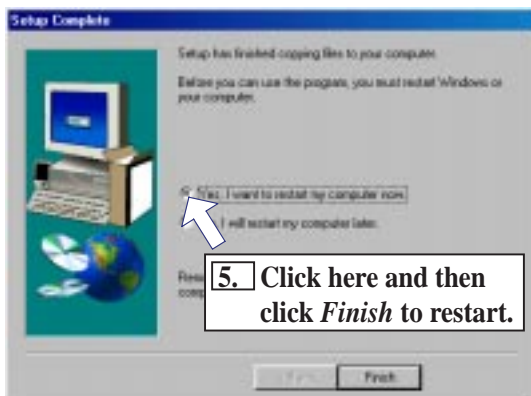

V. SOFTWARE SETUP

Install ESS AudioRack32 (only with onboard audio option)

Insert the Support CD that came with your motherboard into your CD-ROM drive or double-click the CD drive icon in **My Computer** to bring up the setup screen.

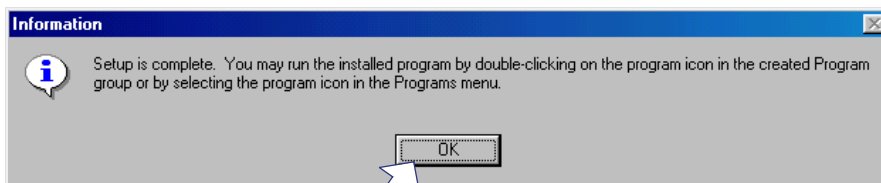
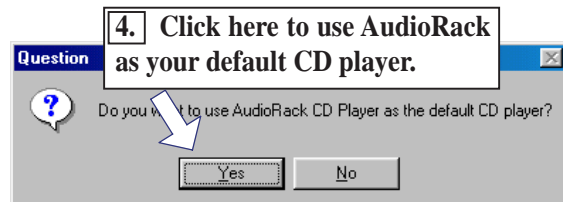
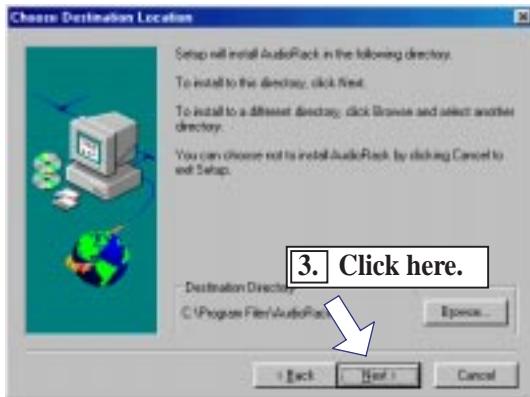
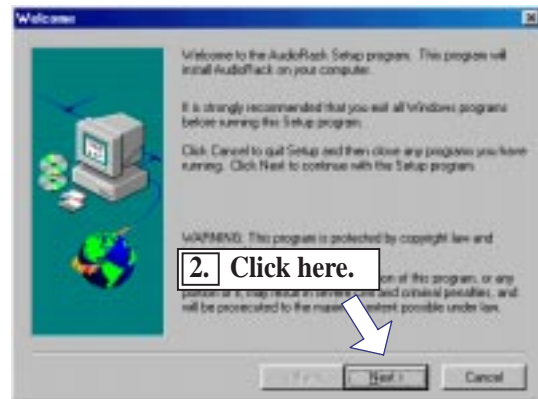

V. SOFTWARE SETUP

Install ESS Software Wave Table

(only with onboard audio option)

Insert the Support CD that came with your motherboard into your CD-ROM drive or double-click the CD drive icon in **My Computer** to bring up the setup screen.

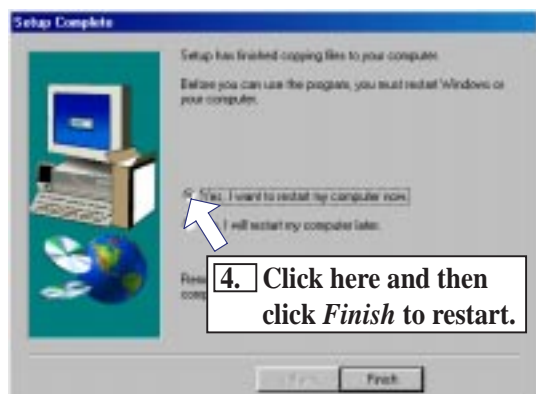

V. SOFTWARE SETUP

Install PC-Cillin 98 Vx.xx

Insert the Support CD that came with your motherboard into your CD-ROM drive or double-click the CD drive icon in **My Computer** to bring up the setup screen.



5 & 6. Select the preferred features by clicking the appropriate buttons.

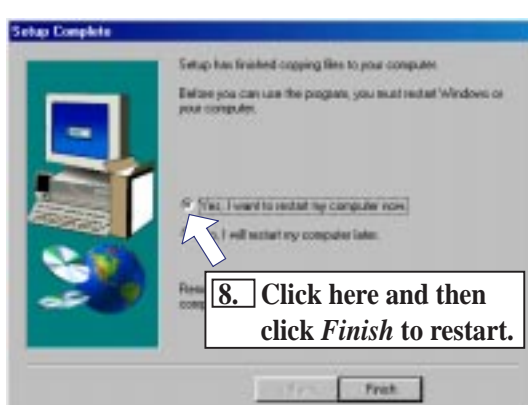
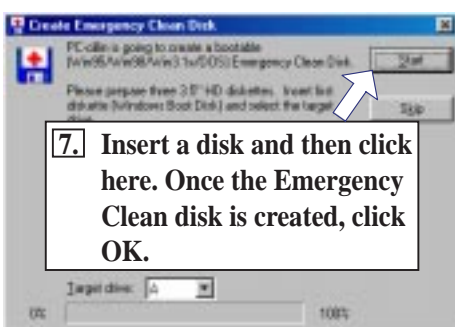
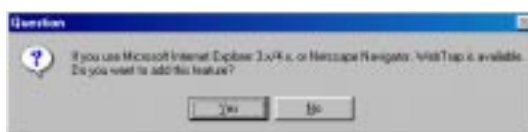

V. SOFTWARE SETUP

Install ADOBE AcroBat Reader Vx.x

Insert the Support CD that came with your motherboard into your CD-ROM drive or double-click the CD drive icon in **My Computer** to bring up the setup screen.

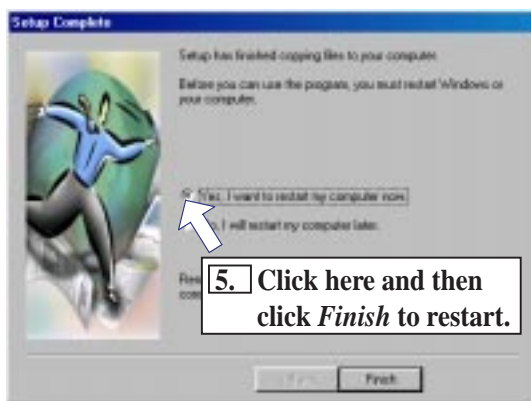
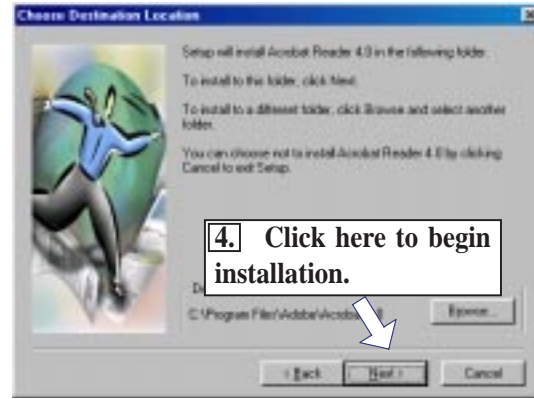
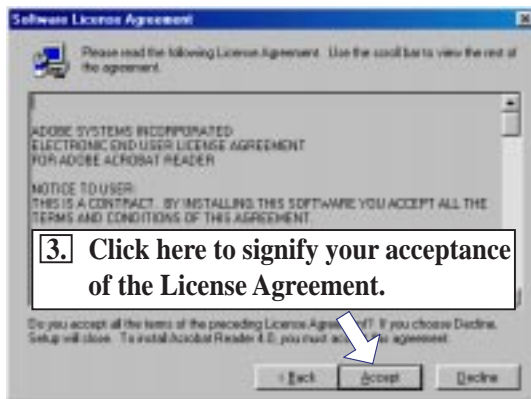
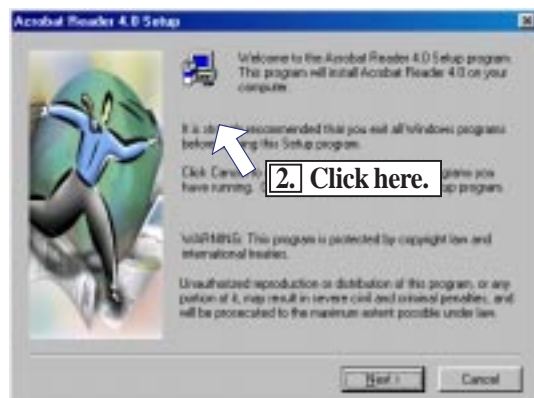

V. SOFTWARE SETUP

Install Bus Master IDE Driver

Insert the Support CD that came with your motherboard into your CD-ROM drive or double-click the CD drive icon in **My Computer** to bring up the setup screen. This option is available only for Windows NT systems.

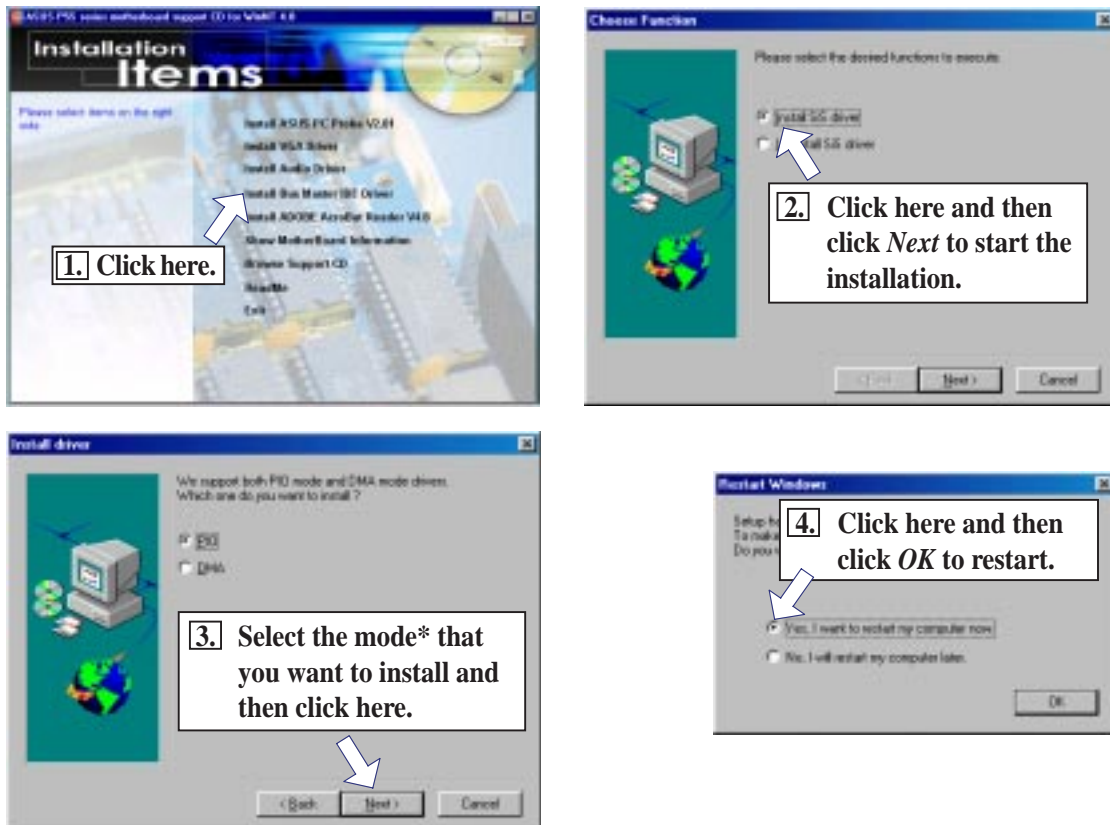

*Transfer Modes Supported

- **PIO Mode** or Programmed Input/Output Mode is the most common way computers transfer data to and from the disk drive. PIO Mode 4, which is the mode installed, differs only from the standard PIO transfer in how often the drive issues interrupts. In PIO Mode 4, each interrupt indicates the drive is ready for 4 sectors of data (read) or has completed the transfer of 4 sectors of data (write), compared with the one interrupt required in standard PIO for each sector. This eliminates some of the system overhead involved in a PIO transfer.
- **DMA (Direct Memory Access) Mode** is used in EISA-, VESA Local Bus-, and PCI-equipped systems. This mode is capable of very fast transfer rates using Bus Mastering. The advantage of using the Bus Master DMA is that it uses less CPU resources than PIO and therefore, it is useful in multitasking environments, where the CPU can work on a different program while data is transferred to or from IDE devices, such as hard disk or CD-ROM drives. **Ultra DMA**, which is the mode installed, is also known as Ultra-ATA (ATA is the “official” name for what the computer industry calls IDE or Integrated Drive Electronics) or Ultra-DMA/33. It is the latest advancement to the ATA specifications. Ultra-DMA, among others, almost doubles the maximum transfer speed of the ATA-3 standard and improves data integrity.

V. SOFTWARE SETUP

Uninstalling Programs

Add/Remove Programs is a basic component within Windows. You may use this function if a program does not provide its own uninstallation program.

1. Double-click here to open the Add/Remove Programs Properties dialog box.

2. Select the program you wish to remove and click here.

3. Click here.

Remove Programs From Your Computer

unInstallShield will remove the s Manager' from your computer. If the following components is rem

- ✓ Shared program files...
- ✓ Standard program files
- ✓ Folder items...
- ✓ Program folders...
- ✓ Program directories...
- ✓ Program registry entries...

Uninstall completed. be removed. You should manually remove items related to the application.

OK

(This page was intentionally left blank.)

VI. SOFTWARE REFERENCE



VI. SOFTWARE REFERENCE

VI. SOFTWARE REFERENCE	81
ASUS PC Probe	83
Starting ASUS PC Probe	83
Using the ASUS PC Probe	84
ASUS PC Probe Task Bar Icon	87
SiS 530 Display Properties	88
AudioRack32	91
The Command Center	92
The 3-D/Tone Controller	93
The Miniature Mode	93
The Audio Mixer	94
The Digital Audio Player	95
The MIDI Player	96
The Compact Disk Player	97
The Audio Recorder	98
Release Notes	99
Desktop Management Interface (DMI)	100

VI. SOFTWARE REFERENCE

ASUS PC Probe

ASUS PC Probe is a convenient utility to continuously monitor your computer system's vital components, such as fan rotations, voltages, and temperatures. It also has a utility that lets you review useful information about your computer, such as hard disk space, memory usage, and CPU type, CPU speed, and internal/external frequencies through the DMI Explorer.

Starting ASUS PC Probe

When ASUS PC Probe starts, a splash screen appears allowing you to select whether to show the screen again when you open PC Probe or not. To bypass this startup screen, clear the **Show up in next execution** check box.

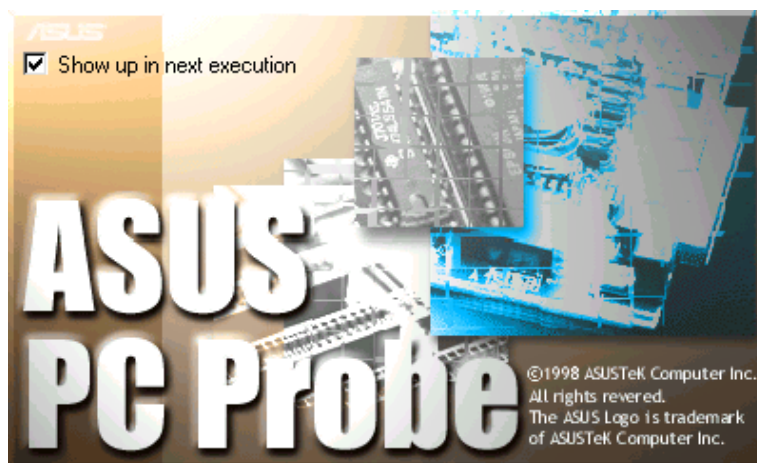

To open **ASUS PC Probe**, click the Windows **Start** button, point to **Programs**, and then **ASUS Utility**, and then click **Probe Vx.xx**.

The PC Probe icon  will appear on the taskbar's system tray indicating that ASUS PC Probe is running. Clicking the icon will allow you to see the status of your PC.



VI. SOFTWARE REFERENCE

Using ASUS PC Probe Monitoring

Monitor Summary

Shows a summary of the items being monitored.



Temperature Monitor

Shows the PC's temperature.

Temperature Warning threshold adjustment
(Move the slider up to increase the threshold level or down to decrease the threshold level)



Fan Monitor

Shows the PC's fan rotation.

Fan Warning threshold adjustment
(Move the slider up to increase the threshold level or down to decrease the threshold level)

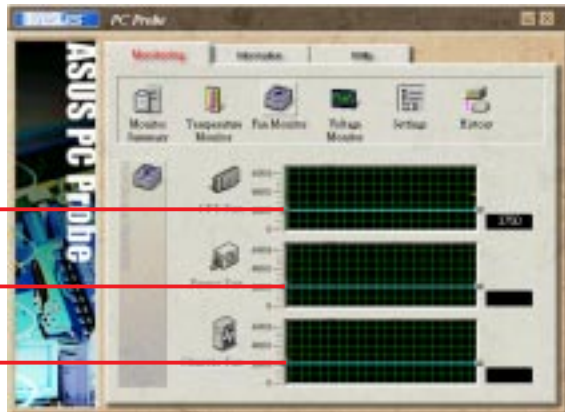

Voltage Monitor

Shows the PC's voltages.

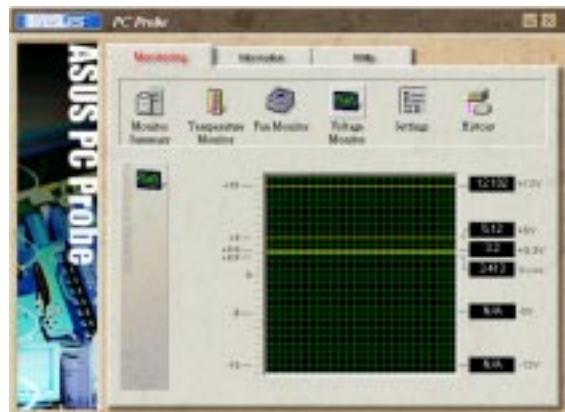

VI. SOFTWARE REFERENCE

Settings

Lets you set threshold levels and polling intervals or refresh times of the PC's temperature, fan rotation, and voltages.



History

Lets you record the monitoring activity of a certain component of your PC by date, time, and target history.



Information

Hard Drives

Shows the used and free space of the PC's hard disk drives and the file allocation table or file system used.



Memory

Shows the PC's memory load, memory usage, and paging file usage.



VI. SOFTWARE REFERENCE

Device Summary

Shows a summary of devices in your PC.



DMI Explorer

Shows information pertinent to the PC, such as CPU type, CPU speed, and internal/external frequencies, and memory size.



Utility

Lets you run programs outside of the ASUS Probe modules. To run a program, click **Execute Program**.



VI. SOFTWARE REFERENCE

ASUS PC Probe Task Bar Icon

Right clicking the PC Probe icon will bring up a menu to open or exit ASUS PC Probe and pause or resume all system monitoring.



When the ASUS PC Probe senses a problem with your PC, portions of the ASUS PC Probe icon changes to red, the PC speaker beeps, and the ASUS PC Probe monitor is displayed.

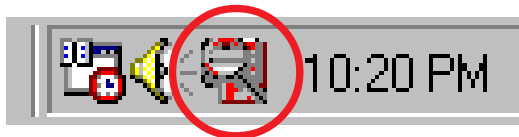

VI. SOFTWARE REFERENCE

SiS 530 Display Properties

The built-in 2D/3D AGP VGA on the SiS 530 AGPset supports professional graphics design, gaming, learning, and business applications.

To open the **SiS 530 Properties** dialog box, click **Start**, point to **Settings**, click **Control Panel**, double-click **Display**, click the **Settings** tab, and then the **Advanced** button.

General

The **Display** box displays the current font size of the selected monitor. To use a different font size, click the arrow, and then click the font size you want.

The **Compatibility** box lets you specify that you want your computer to apply changes to system color settings without restarting. **NOTE:** Some programs might not display colors correctly without being restarted after you make changes. To avoid this problem, close the program, change the color settings, and then open the program again.



Adapter

Shows what type of display adapter you are currently using. To install the software for a new display adapter, click **Change**.



NOTE: Your system may not show all of the settings here.

VI. SOFTWARE REFERENCE

Monitor

Shows what type of monitor you are currently using. To install the software for a new monitor, click **Change**.

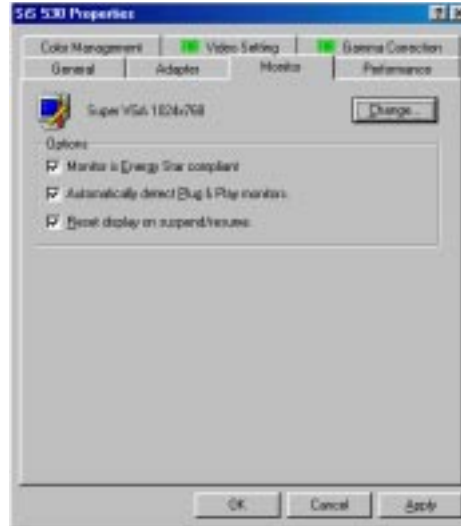

Performance

Specifies the degree of acceleration you want for your graphics hardware. Full acceleration is the fastest and is recommended for most computers. If your computer is having problems and you suspect graphics acceleration to be the cause, use the highest setting at which you do not have problems.

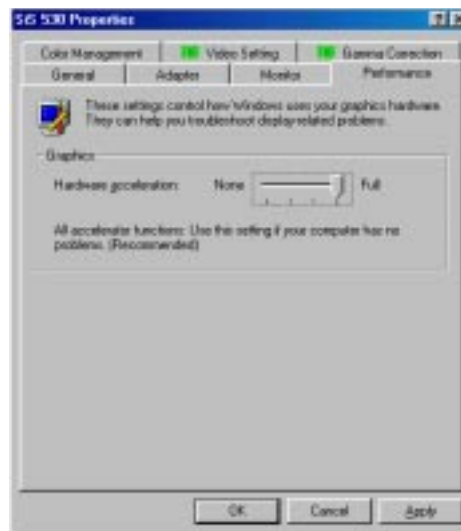

Video Setting

Allows you to adjust the brightness and contrast of the screen output. This function is available only in 16-bit color (high color, 65K-color) and 32-bit (true color plus 8 bits for an alpha channel, 16.7M-color) color depths.



VI. SOFTWARE REFERENCE

Color Management

Lists all the color profile currently associated with your monitor. Click a profile to make it the active profile. Otherwise, the default profile is the active profile.

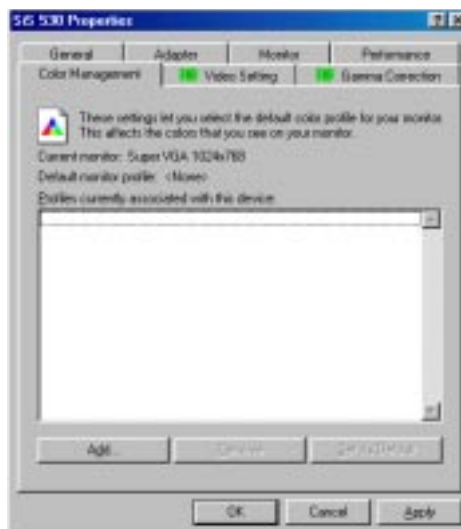

Gamma Correction

Allows you to adjust the quality of your display according to your preference. Gamma correction is available only in 16-bit color and 24-bit color (true color, 16.7M-color) modes. In 16-bit color and 8-bit color (standard color, 256-color) modes, gamma correction function is not supported.

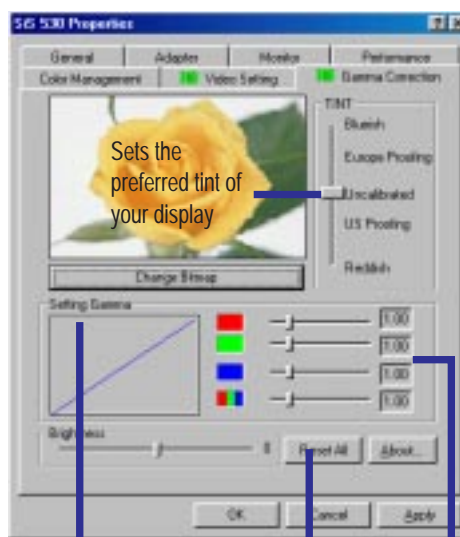

Sets your monitor's color mapping

Restores settings to the original program default

Allows adjustment of individual channel

VI. SOFTWARE REFERENCE

AudioRack32

The **AudioRack32** enables you to take advantage of your computer's audio capabilities with all of the controls conveniently in one compact space. You can play audio CDs, wave files (in WAV and .AUD formats), and MIDI files (in .MID and .RMI formats). With the multisource Audio Mixer, you can blend these sources with line-in and microphone sources any way you choose. You can then record your creations as wave files and edit them with the Audio Recorder.

The **AudioRack32** has six main parts:

- Command Center—customizes the appearance of the **AudioRack32**.
- 3-D/Tone Controller—gives your computer ambient 3D sound, transmitting any sound played through the **AudioRack32** into a wider arc.
- Audio Mixer—controls the volume and balance of the **AudioRack32** devices.
- Digital Audio Player—plays and records files in the .WAV format.
- MIDI Player—enables you to play MIDI files.
- Compact Disk Player—enables you to play audio CDs on a CD-ROM drive.

In addition, the **AudioRack32** has a miniature mode enabling you to control the **AudioRack32** while using minimal screen space.

The Audio Recorder is a separate application from the **AudioRack32**. It can be used to add effects and edit files recorded with the Digital Audio Player or by the Audio Recorder itself. The Audio Recorder can be launched from the **AudioRack32**'s Digital Audio Player or on its own.







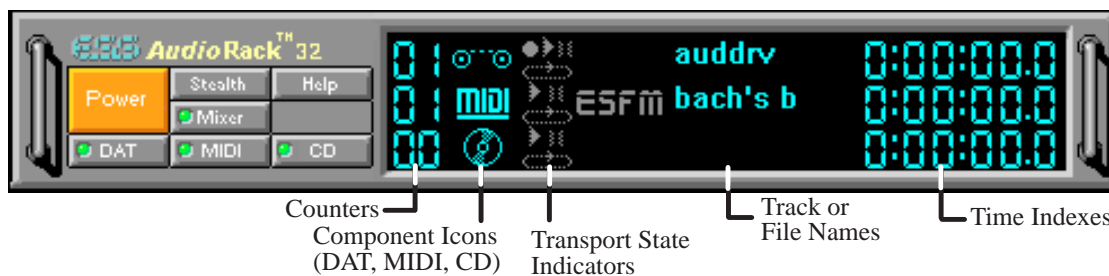

VI. SOFTWARE REFERENCE

The Command Center

The Command Center controls which parts of the *AudioRack32* are displayed. You can display or hide any part of the *AudioRack32* you choose, customizing its appearance to suit your needs or desires. It also displays information on the status of the different audio components.



The Command Center Controls

-  closes the *AudioRack32* window.
-  enables the Miniature mode, minimizing the *AudioRack32* display.
-  displays/hides the Digital Audio Player.
-  accesses On-line Help.
-  displays/hides the Compact Disk Player.
-  displays/hides the Audio Mixer.
-  displays/hides the MIDI Player.

The Command Center Display

Counter: shows you which track or file in the playlist the component is playing.

Component Icon: is displayed when the associated component is shown and is not displayed when the component is hidden.

Transport State Indicator: shows the state of a component. It indicates when the component is playing, paused, has the Auto Repeat enabled, or in the case of the Digital Audio Player, is recording.

Track or File Name: shows the name of the current track or file in the playlist.

Time Index: displays the amount of time elapsed for the track or file in hours, minutes, seconds, and tenths of a second.

VI. SOFTWARE REFERENCE

The 3-D/Tone Controller

The 3-D/Tone Controller lets you create an atmosphere of a resonant sound environment rather than an audio issuing from a 2D plane. See online help for more information.



The 3-D/Tone Controller Controls

The Spatial Control has four settings:

Max: provides the greatest effect, works best with games.

Mid: works best with most audio CDs and music (default setting).

Min: works best with some audio CDs.

Off: no spatilaization, normal stereo.

NOTE: You should have Spatializer hardware in your audio setup to be able to make full use of the controller functions in *AudioRack*. If you do not have, you may still see the controller, but it will have no effect on your PC's audio.

The Miniature Mode

The Miniature mode is designed to give you full control of the *AudioRack32* while using a minimum of space. You are able to effectively use the *AudioRack32* and still have enough room on your desktop to run other applications. In the Miniature mode, you can play, pause, stop, and control the master volume of the *AudioRack32*.

plays currently loaded tracks or files of active components

stops currently playing tracks or files of active components

pauses currently playing tracks or files of active components



controls the master volume

calls up a popup menu where you can restore the *AudioRack32*, invoke the **Always on Top** command, select active components (DAT, MIDI, or CD), or exit the *AudioRack32*. The Stop, Pause, and Play buttons affect components that are currently active

VI. SOFTWARE REFERENCE

The Audio Mixer

The Audio Mixer has two modes: Playback mode and Record mode. You can use these two modes to fully control which of your audio sources you are listening to or recording, how loud each of those sources are and how they are balanced. Each audio source has its own module with mute, balance and volume controls.

In addition, the Audio Mixer provides special effects controls for chorus, reverb, treble, bass, and 3-D effects.



The Audio Mixer Controls

The two Playback and Record toggle buttons are used to switch between Playback mode and Record mode.

The Effects toggle button switches the display to the effects panel where you can use the buttons to enable and disable effects and the sliders to control the amount of the effect.

There are a number of audio source modules displayed on the Audio Mixer. The exact number displayed depends on the capabilities of your hardware. Each module has three controls:



a slider to adjust the balance

a slider to adjust the volume

a button for muting

Modules that your hardware may provide for are: Master, Line, Wave, Mic, CD, MIDI, and Aux B.















VI. SOFTWARE REFERENCE

The Digital Audio Player

The Digital Audio Player enables you to play, record, and compress sound as .WAV files. In addition, you can play .AUD files. The .WAV files use PCM, which is the Windows' audio file format. The .AUD format uses ESPCM' compression to produce an audio file. Files are written directly to your hard disk as you record, enabling you to record very large files. Your only limitation is the amount of free space on your hard disk. The voice activation feature is useful for recording any kind of intermittent audio. The Digital Audio Player provides a choice of linear PCM (8 or 16 bit) recording. Note that you have additional options using the Audio Recorder, which is invoked by the **Edit** button.



The Digital Audio Player Controls

-  starts recording to your hard disk.
-  goes to the end of the wave file or to the next file in the current playlist.
-  plays the wave file currently loaded.
-  enables or disables the Auto Repeat.
-  activates or deactivates the Pause
-  opens the Audio Recorder window.
-  stops the file currently playing.
-  opens the Set Playlist dialog box.
-  goes back one second in the wave file.
-  starts a new file by opening the New Options dialog box.
-  goes forward one second in the wave file.
-  brings up the Open file dialog box in order to load a file into the Digital Audio Player.
-  goes to the beginning of the wave file or to the previous file in the current playlist.
-  saves an audio file.

The Digital Audio Player Display

 The Level Meter displays the output from the left (top) and right (bottom) channels when a wave file is played.

 By clicking on the image of the tape deck, you can display information about the file currently loaded in the Digital Audio Player. The display tells you the file name, size, number of bits per sample, sample rate, and whether the file was recorded in stereo or mono. Click again to return to the image of the tape deck.

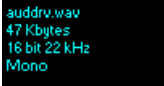
audrv.wav
47 Kbytes
16 bit 22 kHz
Mono









VI. SOFTWARE REFERENCE

The MIDI Player

The MIDI Player enables you to play MIDI files with the .MID or .RMI file extensions. These MIDI (Musical Instrument Digital Interface) files can be produced by sequencer programs and then played back using the MIDI Player. You can also mix MIDI files with other audio sources. Or you can compile MIDI files in a playlist and play them back in any order you choose.



The MIDI Player Controls

-  plays the MIDI file currently loaded.
-  goes back one file in the playlist.
-  activates/deactivates Pause
-  goes forward one file in the playlist.
-  stops the file currently playing.
-  enables/disables the Auto Repeat.
-  goes back one second in the MIDI file.
-  opens the Set Playlist dialog box.
-  goes forward one second in the MIDI file.

The MIDI Player Display

By clicking on the image of the floppy drive, you can display the length and name of the current MIDI file in the playlist. Click the display to return to the image of the floppy drive.

 The MIDI Player has an indicator to show when you are listening to ESFM. When the ESFM light to the left of the playlist button is lit, the MIDI Player is using ESFM synthesis. ESFM performs superior-quality music synthesis compared to that of traditional FM, producing richer timbre and greater depth of instrument voices. **FM synthesis is a lower quality technology compared with Wave table synthesis. This card supports Wave table synthesis therefore ESFM is not supported on this card.**











VI. SOFTWARE REFERENCE

The Compact Disk Player

If you have a CD-ROM drive, you can play audio CDs. Check your hardware manual about setting up CD audio hardware and drivers. The Compact Disk Player uses intelligent CD playlist management: The Compact Disk Player maintains a record of each CD you play. It remembers the last playlist you used with each CD and loads that playlist automatically whenever you insert that CD.



The Compact Disk Player Controls

-  plays the MIDI file currently loaded.
-  goes back one file in the playlist.
-  activates or deactivates the Pause
-  goes forward one file in the playlist.
-  stops the file currently playing.
-  enables or disables the Auto Repeat.
-  goes back one second in the MIDI file.
-  opens the Set Playlist dialog box.
-  goes forward one second in the MIDI file.
-  ejects the CD from the CD-ROM drive.

VI. SOFTWARE REFERENCE













The Audio Recorder

The Audio Recorder enables you to record, compress, store, and play back voice, music, and other sound. It provides settings for sound attributes such as mono/stereo, compression level, and sampling rate. You can use it to embed sound objects in documents created in applications that support object linking and embedding (OLE).

The Audio Recorder's edit, record, and playback capabilities are compatible with the Windows Sound Recorder and other recorders that record and play back in the PCM format. Like the Digital Audio Player, the Audio Recorder can record and play back .WAV and .AUD files. The Audio Recorder allows a choice of compression from low, medium, and high ESPCM and ADPCM.



The Audio Recorder Controls

-  starts a new audio file.
-  inserts the Clipboard audio at the cursor or replaces the selected portion.
-  opens an audio file.
-  mixes the Clipboard audio with the audio beginning at the cursor.
-  saves an audio file.
-  starts recording.
-  reverses the last change you made to the current audio file.
-  plays the currently loaded audio file.
-  removes the selected portion of the audio file and stores it on the Clipboard.
-  stops the file currently playing or recording.
-  copies the selected audio portion to the Clipboard without removing it.
-  determines the cursor position on the waveform.

The Audio Recorder Display



The four text boxes under the tool bar display the length in seconds of the selected part of the currently loaded file, the total length in seconds of the current file, whether the file is in stereo or mono, and the sampling rate in kilohertz.

To the right of the text boxes is a box displaying the icon associated with the particular file. If a file has no icon associated with it, it is given a default icon.

VI. SOFTWARE REFERENCE

Release Notes

This information is provided for convenience only. Information here is subject to change without prior notice. View the installation CD for any updated information in Readme text files. The AudioRack also provides detailed online help (click the **Help** button on the “Command Center”)

Disable Eject Button on the CD Player

Under the Windows directory in the file “auddrive.ini”, there is a string “DisableEjectButton=0” under the [cdplayer] section. If you would like to disable EJECT button on the CD player, you can change the value from 0 to 1. You need to close AudioRack and launch it again to make the new settings take effect.

Using AudioRack CD Player as Default CD Player

During installation, you will be asked if you want to use AudioRack CD player as the default CD player. Normally Windows 95 CD player is the default and will automatically run when an audio CD is inserted into the CD-ROM. If you answer “Yes”, the installation program will overwrite the value of the key [HKEY_CLASSES_ROOT]\AudioCD\shell\play\command in the registry. You may switch back to Windows 95 CD player by resetting this key value.

Configuring Playback Mixer

The PCI audio chip offers eight inputs for the playback mixer, including “Line”, “Wave”, “CD”, “Synth”, “Aux A”, “Aux B”, “Mic”, and “Mono In”. AudioRack can only display six of them at a time. You may configure the settings by modifying the file “auddrive.ini” in the Windows directory. Under the section [MixerRak], you can enable or disable the display of each input by setting its corresponding binary value to 1(enable) or 0(disable).

VI. SOFTWARE REFERENCE

Desktop Management Interface (DMI)

Introducing the ASUS DMI Configuration Utility

This motherboard supports DMI within the BIOS level and provides a DMI Configuration Utility to maintain the Management Information Format Database (MIFD). DMI is able to auto-detect and record information pertinent to a computer's system such as the CPU type, CPU speed, and internal/external frequencies, and memory size. The onboard BIOS will detect as many system information as possible and store those collected information in a 4KB block in the motherboard's Flash EPROM and allow the DMI to retrieve data from this database. Unlike other BIOS software, the BIOS on this motherboard uses the same technology implemented for Plug and Play to allow dynamic real-time updating of DMI information versus creating a new BIOS image file and requiring the user to update the whole BIOS. This DMI Configuration Utility also allows the system integrator or end user to add additional information into the MIFD such as serial numbers, housing configurations, and vendor information. Those information not detected by the motherboard BIOS and has to be manually entered through the DMI Configuration Utility and updated into the MIFD. This DMI Configuration Utility provides the same reliability as PnP updating and will prevent the refreshing failures associated with updating the entire BIOS.

Starting the ASUS DMI Configuration Utility

The DMI Configuration Utility (DMICFG2.EXE) must be used in real mode in order for the program to run, the base memory must be at least 180K. Memory managers like HIMEM.SYS (required by windows) must not be installed. You can boot up from a system diskette without AUTOEXEC.BAT and CONFIG.SYS files, "REM" HIMEM.SYS in the CONFIG.SYS, or press <Shift>+<F5> during bootup to bypass your AUTOEXEC.BAT and CONFIG.SYS files.

1. In Windows, copy DMICFG.EXE to your hard disk drive.
2. Restart your computer and press <Shift>+<F5> during bootup to enter safe mode command prompt.
3. Go to the directory containing DMICFG.EXE.
4. Type `DMICFG` and press <Enter> to run.

VI. SOFTWARE REFERENCE

Using the ASUS DMI Configuration Utility

NOTE: The following screen displays are provided as examples only and may not reflect the screen contents on your system.

Edit DMI (or delete)



Use the ←→ (left-right) cursors to move the top menu items and the ↑↓ (up-down) cursor to move between the left hand menu items. The bottom of the screen will show the available keys for each screen. Press enter at the menu item to enter the right hand screen for editing. “Edit component” appears on top. The reversed color field is the current cursor position and the blue text are available for editing. The orange text shows auto-detected information and are not available for editing. The blue text “Press [ENTER] for detail” contains a second pop-up menu is available, use the + - (plus-minus) keys to change the settings. Enter to exit *and save*, ESC to exit *and not save*.

If the user has made changes, ESC will prompt you to answer Y or N. Enter Y to go back to the left-hand screen *and save*, enter N to go back to left-hand screen and *not save*. If editing has not been made, ESC will send you back to the left hand menu without any messages.

Notes

A heading, *** BIOS Auto Detect ***, appears on the right for each menu item on the left side that has been auto detected by the system BIOS.

A heading, *** User Modified ***, will appear on the right for menu items that have been modified by the user.



VI. SOFTWARE REFERENCE

Save MIFD



You can save the MIFD (normally only saved to flash ROM) to a file by entering the drive and path here. If you want to cancel save, you may press ESC and a message “Bad File Name” appears here to show it was not saved.

Load MIFD



You can load the disk file to memory by entering a drive and path and file name here.

Load BIOS Defaults



You can load the BIOS defaults from a MIFD file and can clear all user modified and added data. You must reboot your computer in order for the defaults to be saved back into the Flash BIOS.

VII. APPENDIX

The ASUS PCI-L101 Fast Ethernet Card

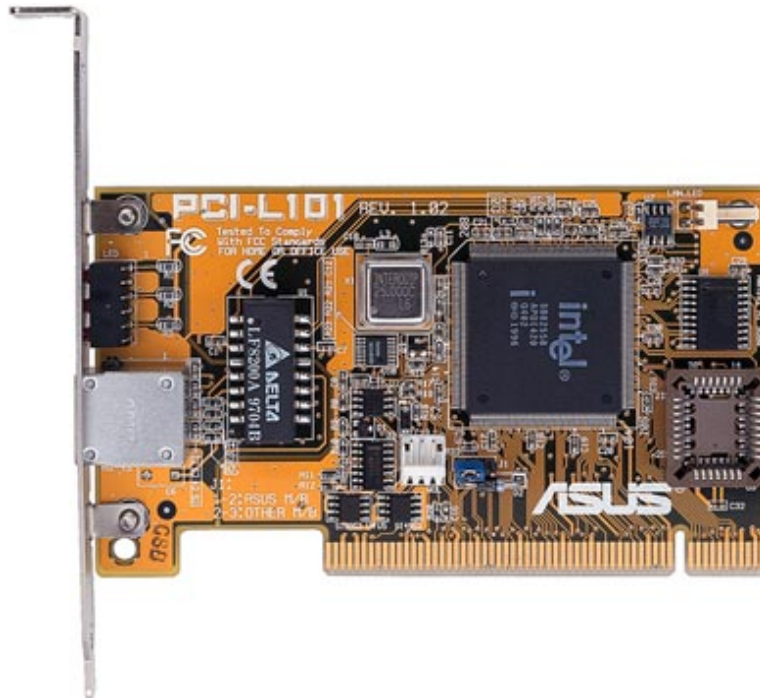

VII. APPENDIX
ASUS LAN Card

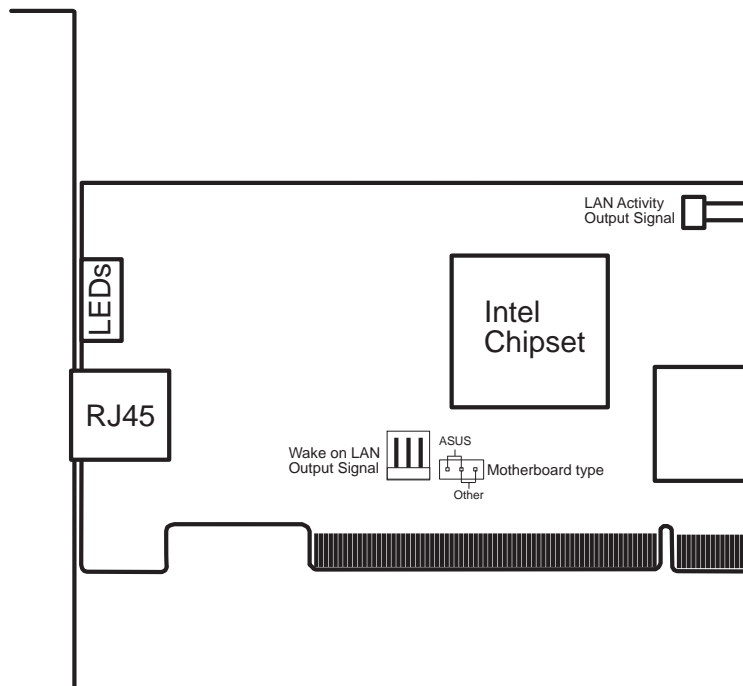

If you are using the ASUS PCI-L101 on an ASUS motherboard, leave the jumper on its default setting of “ASUS.” If you are using another brand of motherboard, set the jumper to “Other.” Connect the Wake on LAN (WOL) output signal to the motherboard’s WOL_CON in order to utilize the wake on LAN feature of the motherboard. Connect the LAN activity output signal (LAN_LED) to the system cabinet’s front panel LAN_LED in order to display the LAN data activity.

VII. APPENDIX

Features

- Intel 82558 Ethernet LAN Controller (Fully integrated 10BASE-T/100BASE-TX)
- Wake-On-LAN Remote Control Function Supported
- PCI Bus Master Complies to PCI Local Bus Rev. 2.1 specifications
- Consists of MAC & PHY (10/100Mbps) interfaces
- Complies to IEEE 802.3 10BASE-T and IEEE 802.3u 100BASE-TX interfaces
- Fully supports 10BASE-T & 100BASE-TX operations through a single RJ45 port
- Supports 32-bit Bus Master Technology / PCI Rev. 2.1
- Enhancements on ACPI & APM
- Adheres to PCI Bus Power Management Interface Rev. 1.0, ACPI Rev. 1.0, and Device Class Power Management Rev. 1.0
- IEEE 802.3u auto-negotiation for 10Mbps/100Mbps Network Data Transfer Rates.
- Provides LED indicators for monitoring network conditions
- Plug and Play

Software Driver Support

- **NetWare ODI Drivers** - Novell Netware 3.x, 4.x, DOS, OS/2 Client
- **NDIS 2.01 Drivers** - Microsoft LAN Manager, Microsoft Windows 3.11, IBM LAN Server
- **NDIS 3.0 Drivers** - Microsoft Windows NT, Microsoft Windows 95, Microsoft Windows 3.11

Question and Answer

Q: What is Wake-On-LAN ?

A: The Wake-On-LAN feature provides the capability to remotely power on systems supporting Wake-On-LAN by simply sending a wake-up frame. With this feature, remotely uploading/downloading data to/from systems during off-peak hours will be feasible.

Q: What can Wake-On-LAN do for you ?

A: Wake-On-LAN is a remote management tool with advantages that can reduce system management workload, provide flexibility to the system administrator's job, and then of course save you time-consuming efforts and costs.

Q: What components does Wake-On-LAN require to be enable?

A: To enable Wake-On-LAN function, your system requires Ethernet LAN adapter card that can activate Wake-On-LAN function, a client with Wake-On-LAN capability, and software such as LDCM Rev. 3.10 or up that can trigger wake-up frame.