

FCC Information and Copyright

This equipment has been tested and found to comply with the limits of a Class B digital device, pursuant to Part 15 of the FCC Rules. These limits are designed to provide reasonable protection against harmful interference in a residential installation. This equipment generates, uses, and can radiate radio frequency energy and, if not installed and used in accordance with the instructions, may cause harmful interference to radio communications. There is no guarantee that interference will not occur in a particular installation.

The vendor makes no representations or warranties with respect to the contents here and specially disclaims any implied warranties of merchantability or fitness for any purpose. Further the vendor reserves the right to revise this publication and to make changes to the contents here without obligation to notify any party beforehand.

Duplication of this publication, in part or in whole, is not allowed without first obtaining the vendor's approval in writing.

The content of this user's manual is subject to be changed without notice and we will not be responsible for any mistakes found in this user's manual. All the brand and product names are trademarks of their respective companies.

Table of Contents

Chapter 1: Introduction	3
1.1 Before You Start	3
1.2 Package Checklist	3
1.3 Motherboard Features	4
1.4 Rear Panel Connectors	5
1.5 Motherboard Layout	6
Chapter 2: Hardware Installation	7
2.1 Installing Central Processing Unit (CPU)	7
2.2 Fan Headers	9
2.3 Installing System Memory	10
2.4 Connectors and Slots	12
Chapter 3: Headers & Jumpers Setup	14
3.1 How to Setup Jumpers	14
3.2 Detail Settings	14
Chapter 4: RAID Functions	20
4.1 Operation System	20
4.2 Raid Arrays	20
4.3 How RAID Works	20
Chapter 5: Useful Help	22
5.1 Driver Installation Note	22
5.2 Award BIOS Beep Code	23
5.3 Extra Information	23
5.4 Troubleshooting	24
Appendencies: SPEC In Other Language	26
German	26
France	28
Italian	30
Spanish	32
Portuguese	34
Polish	36
Russian	38
Arabic	40
Japanese	42

CHAPTER 1: INTRODUCTION

1.1 BEFORE YOU START

Thank you for choosing our product. Before you start installing the motherboard, please make sure you follow the instructions below:

- Prepare a dry and stable working environment with sufficient lighting.
- Always disconnect the computer from power outlet before operation.
- Before you take the motherboard out from anti-static bag, ground yourself properly by touching any safely grounded appliance, or use grounded wrist strap to remove the static charge.
- Avoid touching the components on motherboard or the rear side of the board unless necessary. Hold the board on the edge, do not try to bend or flex the board.
- Do not leave any unfastened small parts inside the case after installation. Loose parts will cause short circuits which may damage the equipment.
- Keep the computer from dangerous area, such as heat source, humid air and water.

1.2 PACKAGE CHECKLIST

- ✦ HDD Cable X 1
- ✦ Installation Guide X 1
- ✦ Fully Setup Driver CD X 1 (full version manual files inside)
- ✦ Rear I/O Panel for ATX Case X 1
- ✦ FDD Cable X 1 (optional)
- ✦ Serial ATA Cable X 1 (optional)
- ✦ USB 2.0 Cable X1 (optional)
- ✦ Serial ATA Power Cable X 1 (optional)

Note: The package contents may differ by area or your motherboard version.

1.3 MOTHERBOARD FEATURES

	<i>P4M900-M7 FE</i>	<i>P4M890-M7 FE</i>
CPU	LGA 775 Intel Core2Duo/ Pentium 4/ Pentium D / Celeron D / Celeron 4xx processor up to 3.8 GHz *It is recommended to use processors with 95W power consumption. Supports Hyper Threading/ Execute Disable Bit/ Enhanced Intel SpeedStep®/ Intel Extended Memory 64 technology	LGA 775 Intel Core2Duo/ Pentium 4/ Pentium D / Celeron D / Celeron 4xx processor up to 3.8 GHz *It is recommended to use processors with 95W power consumption. Supports Hyper Threading/ Execute Disable Bit/ Enhanced Intel SpeedStep®/ Intel Extended Memory 64 technology
FSB	533 / 800 / 1066 MHz	533 / 800 / 1066 MHz
Chipset	VIA P4M900 VIA VT8237A	VIA P4M890 VIA VT8237A
Graphic	Chrome9 HC 3D / 2D Graphics Max Shared Video Memory is 256 MB	Chrome9 HC 3D / 2D Graphics Max Shared Video Memory is 256 MB
Super I/O	ITE 8712F Provides the most commonly used legacy Super I/O functionality. Low Pin Count Interface Environment Control initiatives, H/W Monitor Fan Speed Controller ITE's "Smart Guardian" function	ITE 8712F Provides the most commonly used legacy Super I/O functionality. Low Pin Count Interface Environment Control initiatives, H/W Monitor Fan Speed Controller ITE's "Smart Guardian" function
Main Memory	DIMM Slots x 2 Supports DDR2 533 / 667 Each DIMM supports 256/512MB/1GB/2GB DDR2 Max Memory Capacity 4GB Single Channel Mode DDR2 memory module Registered DIMM and ECC DIMM is not supported	DIMM Slots x 2 Supports DDR2 533 / 667 Each DIMM supports 256/512MB/1GB/2GB DDR2 Max Memory Capacity 4GB Single Channel Mode DDR2 memory module Registered DIMM and ECC DIMM is not supported
IDE	Integrated IDE Controller Ultra DMA 33~133 Bus Master Mode supports PIO Mode 0~4,	Integrated IDE Controller Ultra DMA 33~133 Bus Master Mode supports PIO Mode 0~4,
SATA	Integrated Serial ATA Controller Data transfer rates up to 1.5 Gb/s. SATA Version 1.0 specification compliant.	Integrated Serial ATA Controller Data transfer rates up to 1.5 Gb/s. SATA Version 1.0 specification compliant.
LAN PHY	Realtek RTL 8201CL PHY 10 / 100 Mb/s auto negotiation Half / Full duplex capability	Realtek RTL 8201CL PHY 10 / 100 Mb/s auto negotiation Half / Full duplex capability
Sound Codec	ALC662 5.1 channels audio out High-Definition Audio support	ALC662 5.1 channels audio out High-Definition Audio support

P4M900-M7 FE/P4M890-M7 FE

	P4M900-M7 FE		P4M890-M7 FE	
Slots	PCI Express x 16 slot	x1	PCI Express x 16 slot	x1
	PCI Express x 1 slot	x1	PCI Express x 1 slot	x1
	PCI slot	x2	PCI slot	x2
On Board Connector	Floppy connector	x1	Floppy connector	x1
	Printer Port Connector	x1	Printer Port Connector	x1
	IDE Connector	x2	IDE Connector	x2
	SATA Connector	x2	SATA Connector	x2
	Front Panel Connector	x1	Front Panel Connector	x1
	Front Audio Connector	x1	Front Audio Connector	x1
	CD-in Connector	x1	CD-in Connector	x1
	CPU Fan header	x1	CPU Fan header	x1
	System Fan header	x1	System Fan header	x1
	Clear CMOS header	x1	Clear CMOS header	x1
	USB connector	x2	USB connector	x2
	Power Connector (24pin)	x1	Power Connector (24pin)	x1
Power Connector (4pin)	x1	Power Connector (4pin)	x1	
Back Panel I/O	PS/2 Keyboard	x1	PS/2 Keyboard	x1
	PS/2 Mouse	x1	PS/2 Mouse	x1
	Serial Port	x1	Serial Port	x1
	VGA Port	x1	VGA Port	x1
	LAN port	x1	LAN port	x1
	USB Port	x4	USB Port	x4
	Audio Jack	x3	Audio Jack	x3
Board Size	190 mm (W) x 244 mm (L)		190 mm (W) x 244 mm (L)	
Special Feature	RAID 0 / 1 support		RAID 0 / 1 support	
OS Support	Windows 2000 / XP / VISTA Biostar Reserves the right to add or remove support for any OS with or without notice.		Windows 2000 / XP Biostar Reserves the right to add or remove support for any OS with or without notice.	

1.4 REAR PANEL CONNECTORS

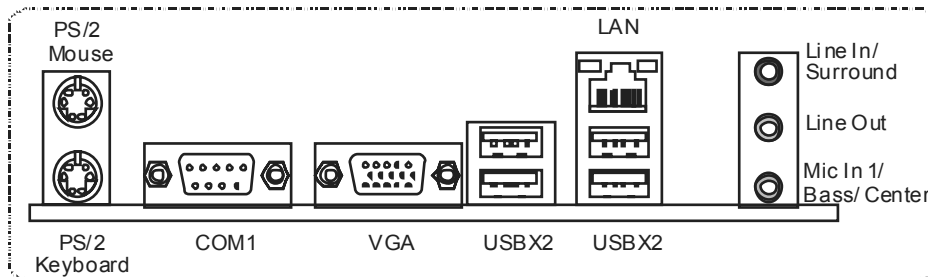

Since the audio chip supports High Definition Audio Specification, the function of each audio jack can be defined by software. The input / output function of each audio jack listed above represents the default setting. However, when connecting external microphone to the audio port, please use the Line In (blue) and Mic In (Pink) audio jack.

1.5 MOTHERBOARD LAYOUT

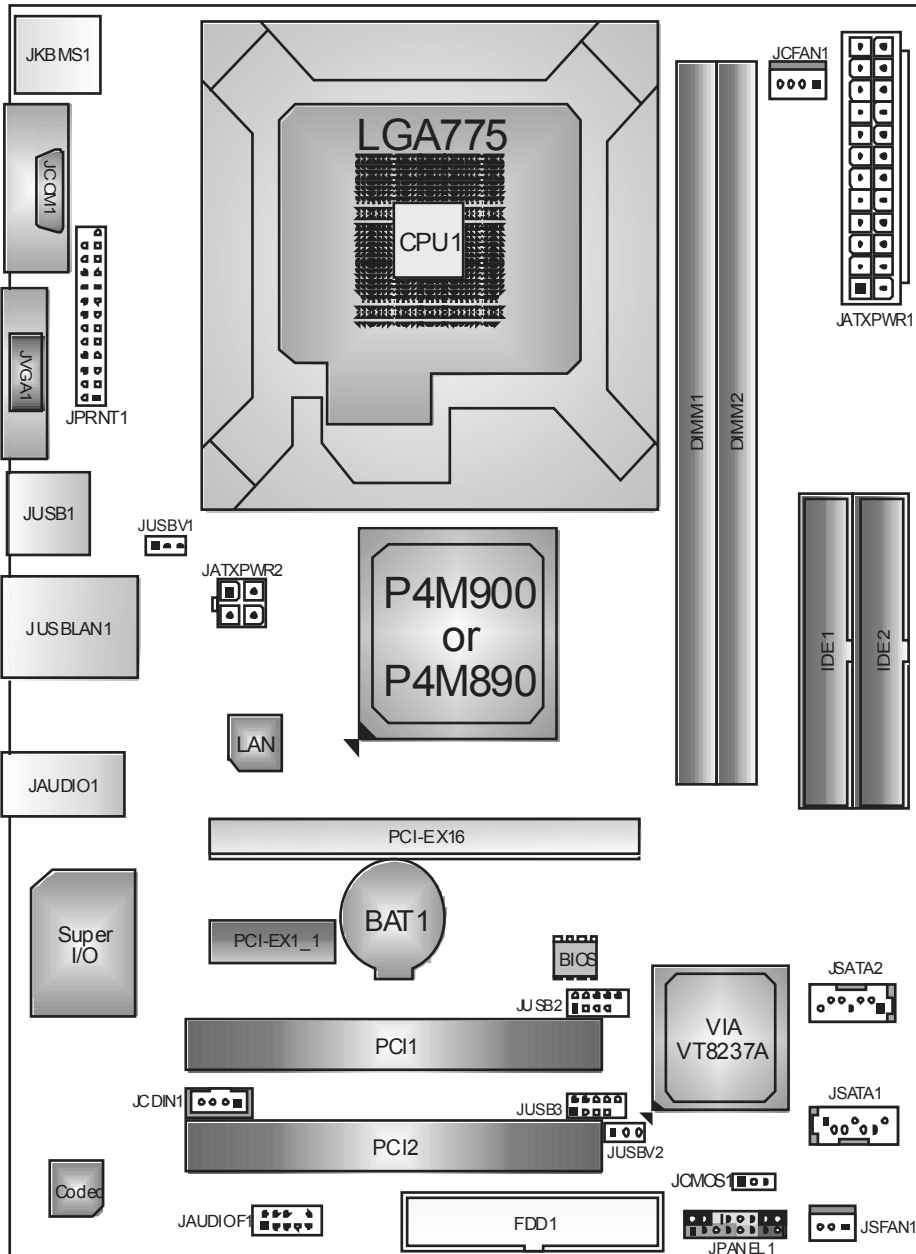

Note: ■ represents the 1st pin.

CHAPTER 2: HARDWARE INSTALLATION

2.1 INSTALLING CENTRAL PROCESSING UNIT (CPU)

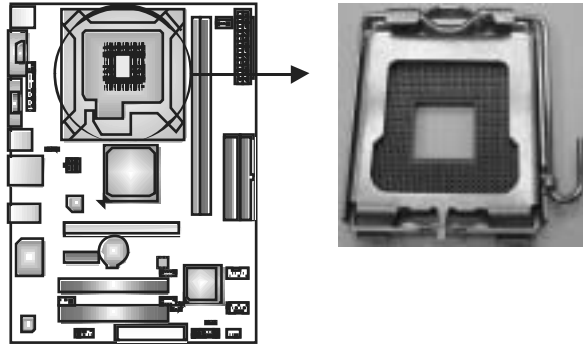

Special Notice

Remove Pin Cap before installation, and make good preservation for future use. When the CPU is removed, cover the Pin Cap on the empty socket to ensure pin legs won't be damaged.

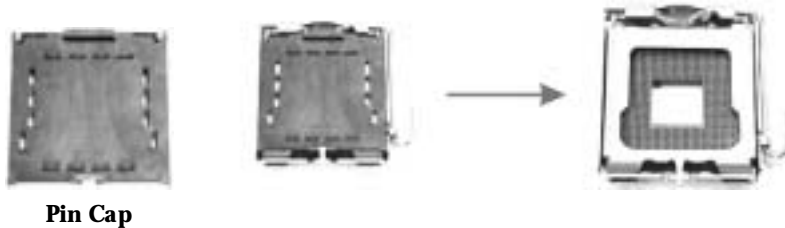

Pin Cap

Step 1: Pull the socket locking lever out from the socket and then raise the lever up to a 90-degree angle.

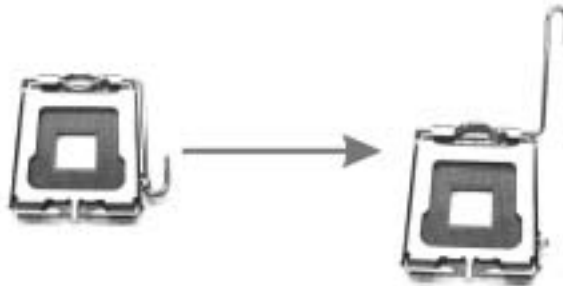

Step 2: Look for the triangular cut edge on socket, and the golden dot on CPU should point forwards this triangular cut edge. The CPU will fit only in the correct orientation.

Step 2-1:

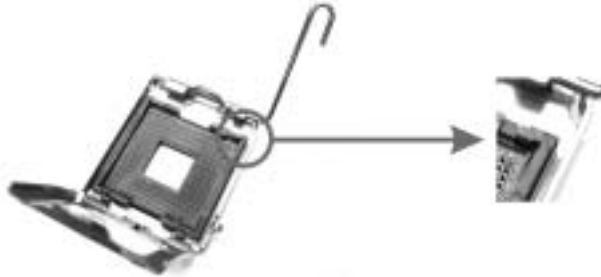

Step 2-2:

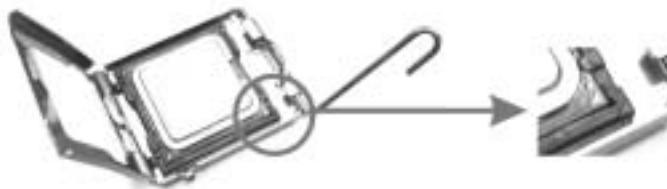

Step 3: Hold the CPU down firmly, and then lower the lever to locked position to complete the installation.



Step 4: Put the CPU Fan and heatsink assembly on the CPU and buckle it on the retention frame. Connect the CPU FAN power cable into the JCFAN1. This completes the installation.

2.2 FAN HEADERS

These fan headers support cooling-fans built in the computer. The fan cable and connector may be different according to the fan manufacturer. Connect the fan cable to the connector while matching the black wire to pin#1.

JCFAN1: CPU Fan Header

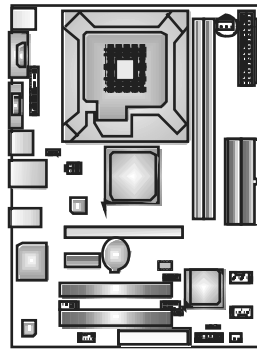

Pin	Assignment
1	Ground
2	+12V
3	FAN RPM rate sense
4	Smart Fan Control

JSFAN1: System Fan Header

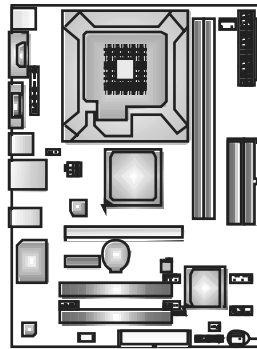

Pin	Assignment
1	Ground
2	+12V
3	FAN RPM rate sense

Note:

The JSFAN1 supports 3-pin head connector and the JCFAN1 supports 4-pin head connector. When connecting with wires onto connectors, please note that the red wire is the positive and should be connected to pin#2, and the black wire is Ground and should be connected to GND.

2.3 INSTALLING SYSTEM MEMORY

A. Memory Modules

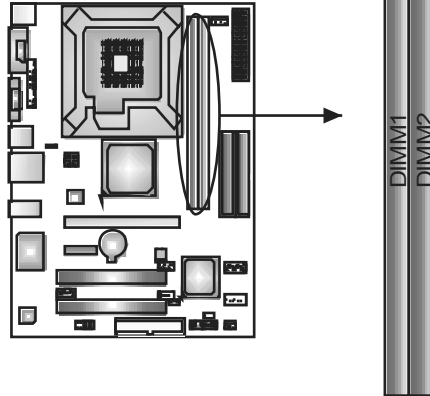

1. Unlock a DIMM slot by pressing the retaining clips outward. Align a DIMM on the slot such that the notch on the DIMM matches the break on the Slot.

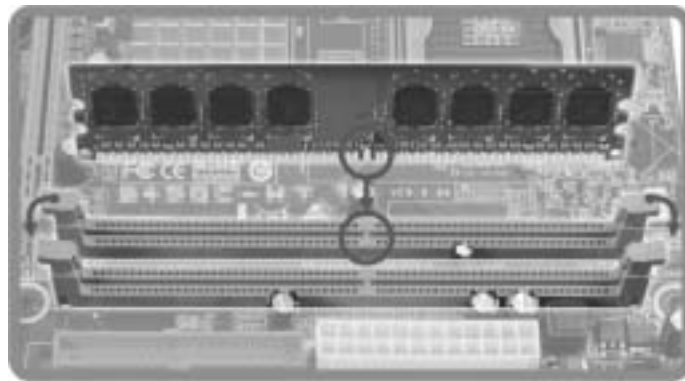

2. Insert the DIMM vertically and firmly into the slot until the retaining chip snap back in place and the DIMM is properly seated.

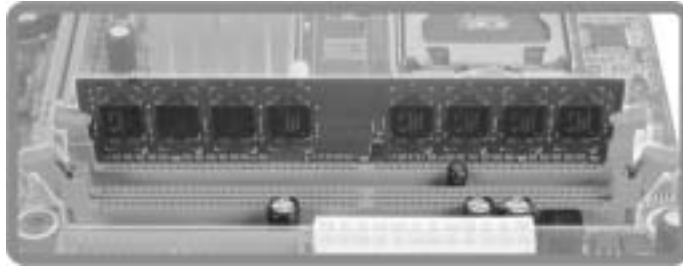

B. Memory Capacity

DIMM Socket Location	DDR2 Module	Total Memory Size
DIMM1	256MB/512MB/1GB/2GB	Max is 4GB.
DIMM2	256MB/512MB/1GB/2GB	

2.4 CONNECTORS AND SLOTS

FDD1: Floppy Disk Connector

The motherboard provides a standard floppy disk connector that supports 360K, 720K, 1.2M, 1.44M and 2.88M floppy disk types. This connector supports the provided floppy drive ribbon cable.

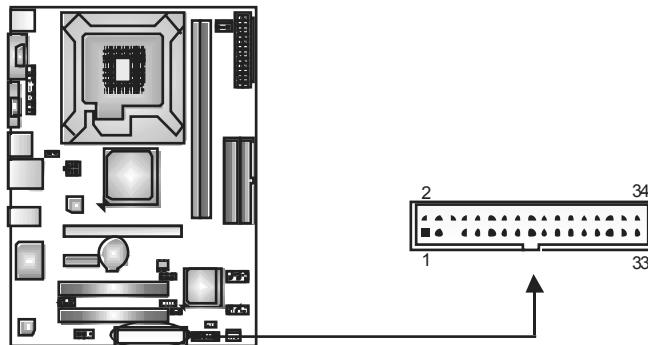

IDE1/IDE2: Hard Disk Connectors

The motherboard has a 32-bit Enhanced PCI IDE Controller that provides PIO Mode 0~4, Bus Master, and Ultra DMA 33/66/100/133 functionality. It has two HDD connectors: IDE1 (primary) and IDE2 (secondary).

The IDE connectors can connect a master and a slave drive, so you can connect up to four hard disk drives. The first hard drive should always be connected to IDE1.

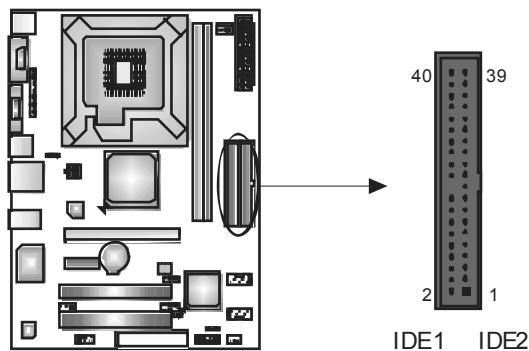

PCI-EX16: PCI-Express x16 Slot

- PCI-Express 1.0a compliant.
- Maximum theoretical realized bandwidth of 4GB/s simultaneously per direction, for an aggregate of 8GB/s totally.

PCI-EX1_1: PCI-Express x1 Slot

- PCI-Express 1.0a compliant.
- Data transfer bandwidth up to 250MB/s per direction; 500MB/s in total.
- PCI-Express supports a raw bit-rate of 2.5Gb/s on the data pins.
- 2X bandwidth over the traditional PCI architecture.

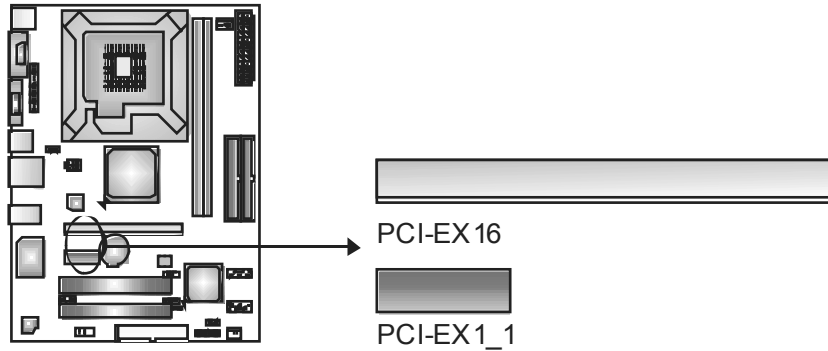

PCI/PCI2: Peripheral Component Interconnect Slots

This motherboard is equipped with 2 standard PCI slots. PCI stands for Peripheral Component Interconnect, and it is a bus standard for expansion cards. This PCI slot is designated as 32 bits.

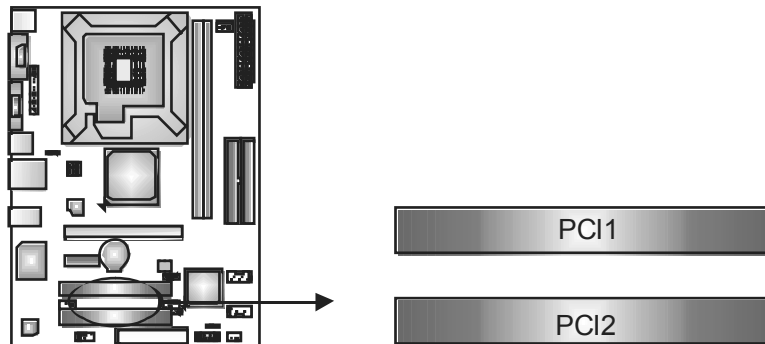

CHAPTER 3: HEADERS & JUMPERS SETUP

3.1 HOW TO SETUP JUMPERS

The illustration shows how to set up jumpers. When the jumper cap is placed on pins, the jumper is “close”, if not, that means the jumper is “open”.



3.2 DETAIL SETTINGS

JPANEL1: Front Panel Header

This 16-pin connector includes Power-on, Reset, HDD LED, Power LED, and speaker connection. It allows user to connect the PC case’s front panel switch functions.

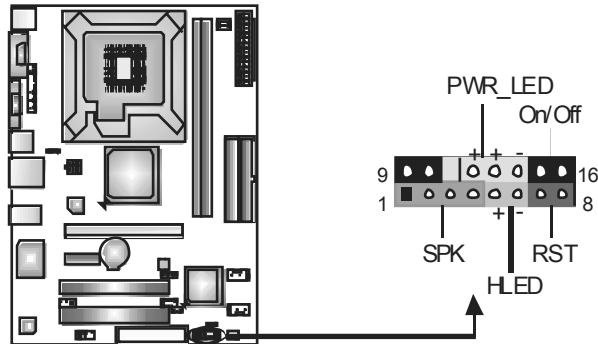

Pin	Assignment	Function	Pin	Assignment	Function
1	+5V		9	N/A	N/A
2	N/A	Speaker Connector	10	N/A	N/A
3	N/A		11	N/A	N/A
4	Speaker		12	Power LED (+)	Power LED
5	HDD LED (+)	13	Power LED (+)		
6	HDD LED (-)	14	Power LED (-)		
7	Ground	Reset button	15	Power button	Power-on button
8	Reset control		16	Ground	

ATX Power Source Connector: JATXPWR1

JATXPWR1 allows user to connect 24-pin power connector on the ATX power supply.

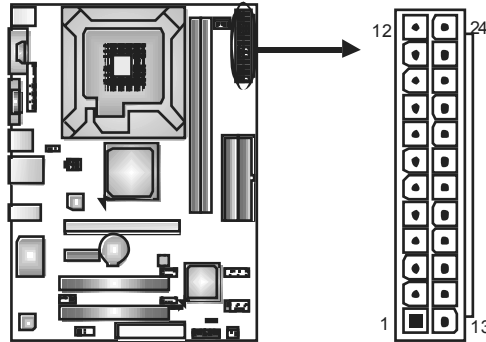

Pin	Assignment	Pin	Assignment
13	+3.3V	1	+3.3V
14	-12V	2	+3.3V
15	Ground	3	Ground
16	PS_ON	4	+5V
17	Ground	5	Ground
18	Ground	6	+5V
19	Ground	7	Ground
20	NC	8	PW_OK
21	+5V	9	StandbyVoltage+5V
22	+5V	10	+12V
23	+5V	11	+12V
24	Ground	12	+3.3V

JATXPWR2: ATX Power Source Connector

By connecting this connector, it will provide +12V to CPU power circuit.

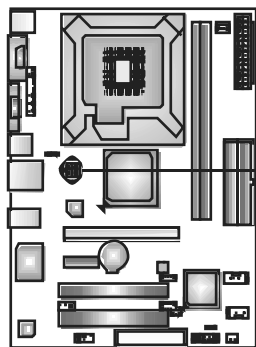

Pin	Assignment
1	+12V
2	+12V
3	Ground
4	Ground

Note:

Before power on the system, please make sure that both JATXPWR1 and JATXPWR2 connectors have been plugged-in.

JUSB2/JUSB3: Headers for USB 2.0 Ports at Front Panel

This header allows user to connect additional USB cable on the PC front panel, and also can be connected with internal USB devices, like USB card reader.

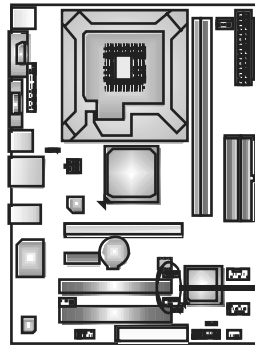

Pin	Assignment
1	+5V (fused)
2	+5V (fused)
3	USB-
4	USB-
5	USB+
6	USB+
7	Ground
8	Ground
9	Key
10	NC

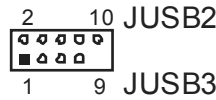

JSATA1/JSATA2: Serial ATA Connectors

The motherboard has a PCI to SATA Controller with 2 channels SATA interface, it satisfies the SATA 1.0 spec and with transfer rate of 1.5Gb/s.

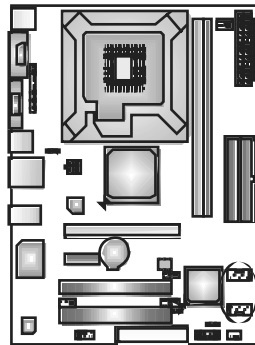

Pin	Assignment
1	Ground
2	TX+
3	TX-
4	Ground
5	RX-
6	RX+
7	Ground

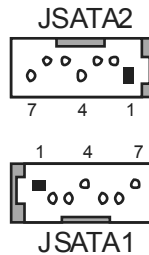

JAUDIOF1: Front Panel Audio Header

This header allows user to connect the front audio output cable with the PC front panel. This header allows only HD audio front panel connector; AC'97 connector is not acceptable.

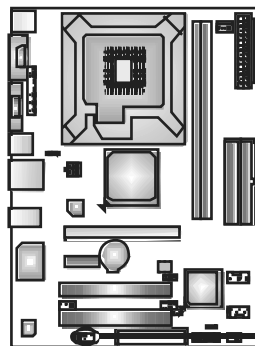

Pin	Assignment
1	Mic Left in
2	Ground
3	Mic Right in
4	GPIO
5	Right line in
6	Jack Sense
7	Front Sense
8	Key
9	Left line in
10	Jack Sense

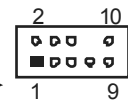

JCDIN1: CD-ROM Audio-in Connector

This connector allows user to connect the audio source from the variety devices, like CD-ROM, DVD-ROM, PCI sound card, PCI TV tuner card etc.

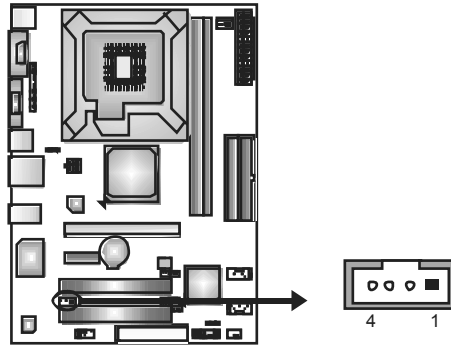

Pin	Assignment
1	Left Channel Input
2	Ground
3	Ground
4	Right Channel Input

JCMOS1: Clear CMOS Header

By placing the jumper on pin2-3, it allows user to restore the BIOS safe setting and the CMOS data, please carefully follow the procedures to avoid damaging the motherboard.

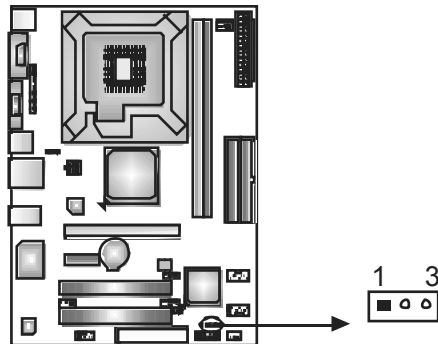

Pin 1-2 Close:
Normal Operation (default).



Pin 2-3 Close:
Clear CMOS data.

※ Clear CMOS Procedures:

1. Remove AC power line.
2. Set the jumper to "Pin 2-3 close".
3. Wait for five seconds.
4. Set the jumper to "Pin 1-2 close".
5. Power on the AC.
6. Reset your desired password or clear the CMOS data.

JPRNT1: Printer Port Connector

This header allows you to connect printer on the PC.

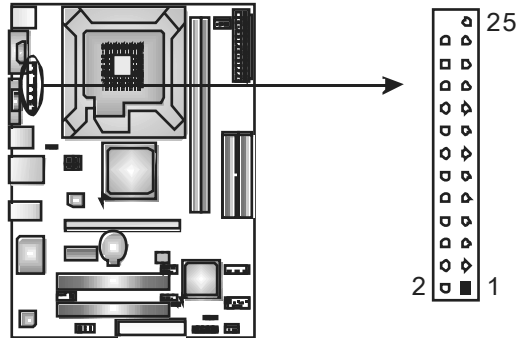

Pin	Assignment	Pin	Assignment
1	-Strobe	14	Ground
2	-ALF	15	Data 6
3	Data 0	16	Ground
4	-Error	17	Data 7
5	Data 1	18	Ground
6	-Init	19	-ACK
7	Data 2	20	Ground
8	-Scltin	21	Busy
9	Data 3	22	Ground
10	Ground	23	PE
11	Data 4	24	Ground
12	Ground	25	SCLT
13	Data 5	26	Key

JUSBV1/JUSBV2: Power Source Headers for USB Ports

Pin 1-2 Close:

JUSBV1: +5V for USB ports at JUSB1/JUSBLAN1.

JUSBV2: +5V for USB ports at front panel (JUSB2/JUSB3).

Pin 2-3 Close:

JUSBV1: +5V STB for USB ports at JUSB1/JUSBLAN1.

JUSBV2: +5V STB for USB ports at front panel (JUSB2/JUSB3).

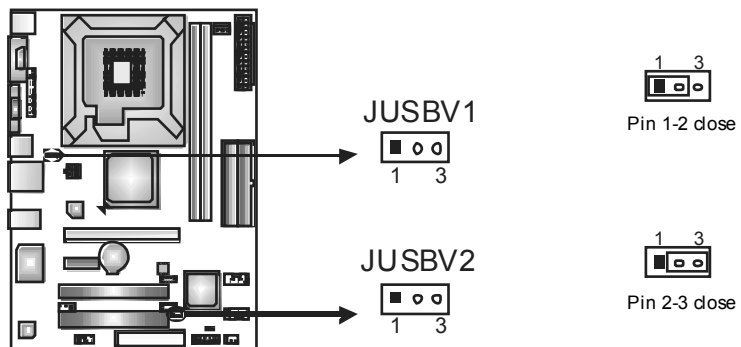

CHAPTER 4: RAID FUNCTIONS

4.1 OPERATION SYSTEM

Supports Windows XP, Windows 2000 Professional, and Windows Vista.

4.2 RAID ARRAYS

RAID supports the following types of RAID arrays:

RAID 0: RAID 0 defines a disk striping scheme that improves disk read and write times for many applications.

RAID 1: RAID 1 defines techniques for mirroring data.

4.3 How RAID WORKS

RAID 0:

The controller “stripes” data across multiple drives in a RAID 0 array system. It breaks up a large file into smaller blocks and performs disk reads and writes across multiple drives in parallel. The size of each block is determined by the stripe size parameter, which you set during the creation of the RAID set based on the system environment. This technique reduces overall disk access time and offers high bandwidth.

Features and Benefits

- **Drives:** Minimum 2, and maximum is up to 6 or 8. Depending on the platform.
- **Uses:** Intended for non-critical data requiring high data throughput, or any environment that does not require fault tolerance.
- **Benefits:** provides increased data throughput, especially for large files. No capacity loss penalty for parity.
- **Drawbacks:** Does not deliver any fault tolerance. If any drive in the array fails, all data is lost.
- **Fault Tolerance:** No.

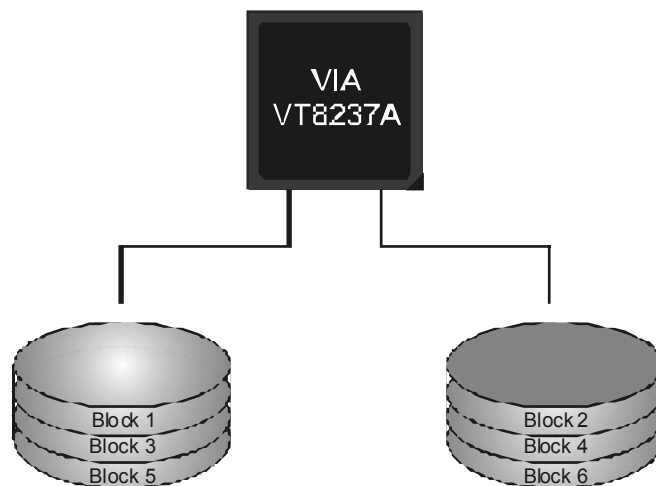

RAID 1:

Every read and write is actually carried out in parallel across 2 disk drives in a RAID 1 array system. The mirrored (backup) copy of the data can reside on the same disk or on a second redundant drive in the array. RAID 1 provides a hot-standby copy of data if the active volume or drive is corrupted or becomes unavailable because of a hardware failure.

RAID techniques can be applied for high-availability solutions, or as a form of automatic backup that eliminates tedious manual backups to more expensive and less reliable media.

Features and Benefits

- **Drives:** Minimum 2, and maximum is 2.
- **Uses:** RAID 1 is ideal for small databases or any other application that requires fault tolerance and minimal capacity.
- **Benefits:** Provides 100% data redundancy. Should one drive fail, the controller switches to the other drive.
- **Drawbacks:** Requires 2 drives for the storage space of one drive. Performance is impaired during drive rebuilds.
- **Fault Tolerance:** Yes.

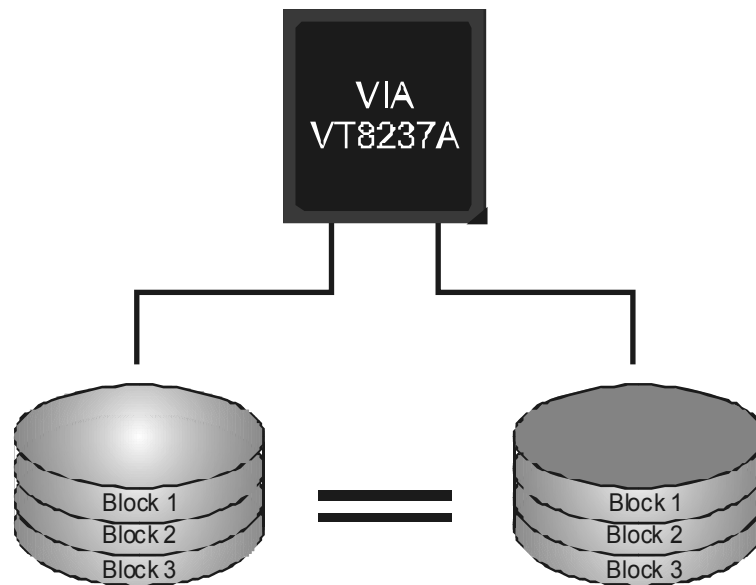

CHAPTER 5: USEFUL HELP

5.1 DRIVER INSTALLATION NOTE

After you installed your operating system, please insert the Fully Setup Driver CD into your optical drive and install the driver for better system performance.

You will see the following window after you insert the CD



The setup guide will auto detect your motherboard and operating system.

Note:

If this window didn't show up after you insert the Driver CD, please use file browser to locate and execute the file **SETUPEXE** under your optical drive.

A. Driver Installation

To install the driver, please click on the Driver icon. The setup guide will list the compatible driver for your motherboard and operating system. Click on each device driver to launch the installation program.

B. Software Installation

To install the software, please click on the Software icon. The setup guide will list the software available for your system, click on each software title to launch the installation program.

C. Manual

Aside from the paperback manual, we also provide manual in the Driver CD. Click on the Manual icon to browse for available manual.

Note:

You will need Acrobat Reader to open the manual file. Please download the latest version of Acrobat Reader software from

<http://www.adobe.com/products/acrobat/readstep2.html>

5.2 AWARD BIOS BEEP CODE

Beep Sound	Meaning
One long beep followed by two short beeps	Video card not found or video card memory bad
High-low siren sound	CPU overheated System will shut down automatically
One Short beep when system boot-up	No error found during POST
Long beeps every other second	No DRAM detected or install

5.3 EXTRA INFORMATION

CPU Overheated

If the system shutdown automatically after power on system for seconds, that means the CPU protection function has been activated.

When the CPU is over heated, the motherboard will shutdown automatically to avoid a damage of the CPU, and the system may not power on again.

In this case, please double check:

1. The CPU cooler surface is placed evenly with the CPU surface.
2. CPU fan is rotated normally.
3. CPU fan speed is fulfilling with the CPU speed.

After confirmed, please follow steps below to relief the CPU protection function.

1. Remove the power cord from power supply for seconds.
2. Wait for seconds.
3. Plug in the power cord and boot up the system.

Or you can:

1. Clear the CMOS data.
(See "Close CMOS Header: JCMOS1" section)
2. Wait for seconds.
3. Power on the system again.

5.4 TROUBLESHOOTING

Probable	Solution
<ol style="list-style-type: none"> No power to the system at all. Power light don't illuminate, fan inside power supply does not turn on. Indicator light on key board does not turn on. 	<ol style="list-style-type: none"> Make sure power cable is securely plugged in. Replace cable. Contact technical support.
System inoperative. Keyboard lights are on, power indicator lights are lit, and hard drive is spinning.	Using even pressure on both ends of the DIMM, press down firmly until the module snaps into place.
System does not boot from hard disk drive, can be booted from optical drive.	<ol style="list-style-type: none"> Check cable running from disk to disk controller board. Make sure both ends are securely plugged in; check the drive type in the standard CMOS setup. Backing up the hard drive is extremely important. All hard disks are capable of breaking down at any time.
System only boots from optical drive. Hard disk can be read and applications can be used but booting from hard disk is impossible.	<ol style="list-style-type: none"> Back up data and applications files. Reformat the hard drive. Re-install applications and data using backup disks.
Screen message says "Invalid Configuration" or "CMOS Failure."	Review system's equipment. Make sure correct information is in setup.
Cannot boot system after installing second hard drive.	<ol style="list-style-type: none"> Set master/slave jumpers correctly. Run SETUP program and select correct drive types. Call the drive manufacturers for compatibility with other drives.

This page is intentionally left blank.

APPENDENCIES: SPEC IN OTHER LANGUAGE**GERMAN**

	<i>P4M900-M7 FE</i>	<i>P4M890-M7 FE</i>
CPU	LGA 775 Intel Core2Duo/ Pentium 4/ Pentium D / Celeron D / Celeron 4xx Prozessoren mit bis zu 3,8 GHz *It is recommended to use processors with 95W power consumption. Unterstützt Hyper-Threading / Execute Disable Bit / Enhanced Intel SpeedStep® / Intel Architecture-64 / Extended Memory 64 Technology	LGA 775 Intel Core2Duo/ Pentium 4/ Pentium D / Celeron D / Celeron 4xx Prozessoren mit bis zu 3,8 GHz *It is recommended to use processors with 95W power consumption. Unterstützt Hyper-Threading / Execute Disable Bit / Enhanced Intel SpeedStep® / Intel Architecture-64 / Extended Memory 64 Technology
FSB	533 / 800 / 1066 MHz	533 / 800 / 1066 MHz
Chipsatz	VIA P4M900 VIA VT8237A	VIA P4M890 VIA VT8237A
Grafik	Chrome9 HC 3D / 2D Graphics Max. 256MB gemeinsam benutzter Videospeicher	Chrome9 HC 3D / 2D Graphics Max. 256MB gemeinsam benutzter Videospeicher
Super E/A	ITE 8712F Bietet die häufig verwendeten alten Super E/A-Funktionen. Low Pin Count-Schnittstelle Umgebungskontrolle, Hardware-Überwachung Lüfterdrehzahl-Controller "Smart Guardian"-Funktion von ITE	ITE 8712F Bietet die häufig verwendeten alten Super E/A-Funktionen. Low Pin Count-Schnittstelle Umgebungskontrolle, Hardware-Überwachung Lüfterdrehzahl-Controller "Smart Guardian"-Funktion von ITE
Arbeitsspeicher	DDR2 DIMM-Steckplätze x 2 Unterstützt DDR2 533 / 667 Jeder DIMM unterstützt 256/512MB/1GB/2GB DDR2. Max. 4GB Arbeitsspeicher Ein-Kanal DDR2 Speichermodul registrierte DIMMs. ECC DIMMs werden nicht unterstützt.	DDR2 DIMM-Steckplätze x 2 Unterstützt DDR2 533 / 667 Jeder DIMM unterstützt 256/512MB/1GB/2GB DDR2. Max. 4GB Arbeitsspeicher Ein-Kanal DDR2 Speichermodul registrierte DIMMs. ECC DIMMs werden nicht unterstützt.
IDE	Integrierter IDE-Controller Ultra DMA 33 / 66 / 100 / 133Bus Master-Modus Unterstützt PIO-Modus 0~4,	Integrierter IDE-Controller Ultra DMA 33 / 66 / 100 / 133Bus Master-Modus Unterstützt PIO-Modus 0~4,
SATA	Integrierter Serial ATA-Controller Datenrate bis zu 1.5Gb/s Konform mit der SATA-Spezifikation Version 1.0.	Integrierter Serial ATA-Controller Datenrate bis zu 1.5Gb/s Konform mit der SATA-Spezifikation Version 1.0.

P4M900-M7 FE/P4M890-M7 FE

	P4M900-M7 FE	P4M890-M7 FE
LAN PHY	Realtek RTL 8201CL PHY 10 / 100 Mb/s Auto-Negotiation Halb-/ Vollduplex-Funktion	Realtek RTL 8201CL PHY 10 / 100 Mb/s Auto-Negotiation Halb-/ Vollduplex-Funktion
Audio-Cod ec	ALC662 Unterstützt High-Definition Audio 5.1-Kanal-Audioausgabe	ALC662 Unterstützt High-Definition Audio 5.1-Kanal-Audioausgabe
Steckplätz e	PCI-Steckplatz x2 PCI Express x16 Steckplatz x1 PCI Express x1-Steckplatz x1	PCI-Steckplatz x2 PCI Express x16 Steckplatz x1 PCI Express x1-Steckplatz x1
Onboard-A nschluss	Diskettenlaufwerkanschluss x1 Druckeranschluss Anschluss x1 IDE-Anschluss x2 SATA-Anschluss x2 Fronttafelanschluss x1 Front-Audioanschluss x1 CD-IN-Anschluss x1 CPU-Lüfter-Sockel x1 System-Lüfter-Sockel x1 "CMOS löschen"-Sockel x1 USB-Anschluss x2 Stromanschluss (24-polig) x1 Stromanschluss (4-polig) x1	Diskettenlaufwerkanschluss x1 Druckeranschluss Anschluss x1 IDE-Anschluss x2 SATA-Anschluss x2 Fronttafelanschluss x1 Front-Audioanschluss x1 CD-IN-Anschluss x1 CPU-Lüfter-Sockel x1 System-Lüfter-Sockel x1 "CMOS löschen"-Sockel x1 USB-Anschluss x2 Stromanschluss (24-polig) x1 Stromanschluss (4-polig) x1
Rückseiten -E/A	PS/2-Tastatur x1 PS/2-Maus x1 Serieller Anschluss x1 VGA-Anschluss x1 LAN-Anschluss x1 USB-Anschluss x4 Audioanschluss x3	PS/2-Tastatur x1 PS/2-Maus x1 Serieller Anschluss x1 VGA-Anschluss x1 LAN-Anschluss x1 USB-Anschluss x4 Audioanschluss x3
Platinengr öße.	190 mm (B) X 244 mm (L)	190 mm (B) X 244 mm (L)
Sonderfun ktionen	Unterstützt RAID 0 / 1	Unterstützt RAID 0 / 1
OS-Unters tützung	Windows 2K / XP / VISTA Biostar behält sich das Recht vor, ohne Ankündigung die Unterstützung für ein Betriebssystem hinzuzufügen oder zu entfernen.	Windows 2K / XP Biostar behält sich das Recht vor, ohne Ankündigung die Unterstützung für ein Betriebssystem hinzuzufügen oder zu entfernen.

FRANCE

	<i>P4M900-M7 FE</i>	<i>P4M890-M7 FE</i>
UC	<p>LGA 775</p> <p>Processeurs Intel Core2Duo/ Pentium 4 / Pentium D / Celeron D / Celeron 4xx jusqu'à 3,8 GHz</p> <p>*It is recommended to use processors with 95W power consumption.</p> <p>Prend en charge les technologies Hyper-Threading / d'exécution de bit de désactivation / Intel SpeedStep® optimisée/ d'architecture Intel 64 / de mémoire étendue 64</p>	<p>LGA 775</p> <p>Processeurs Intel Core2Duo/ Pentium 4 / Pentium D / Celeron D / Celeron 4xx jusqu'à 3,8 GHz</p> <p>*It is recommended to use processors with 95W power consumption.</p> <p>Prend en charge les technologies Hyper-Threading / d'exécution de bit de désactivation / Intel SpeedStep® optimisée/ d'architecture Intel 64 / de mémoire étendue 64</p>
Bus frontal	533 / 800 / 1066 MHz	533 / 800 / 1066 MHz
Chipset	VIA P4M900 VIA VT8237A	VIA P4M890 VIA VT8237A
Graphiques	Chrome9 HC 3D / 2D Graphics Mémoire vidéo partagée maximale de 256 Mo	Chrome9 HC 3D / 2D Graphics Mémoire vidéo partagée maximale de 256 Mo
Super E/S	<p>ITE 8712F</p> <p>Fournit la fonctionnalité de Super E/S patrimoniales la plus utilisée.</p> <p>Interface à faible compte de broches</p> <p>Initiatives de contrôle environnementales, Moniteur de matériel</p> <p>Contrôleur de vitesse de ventilateur</p> <p>Fonction "Gardien intelligent" de l'ITE</p>	<p>ITE 8712F</p> <p>Fournit la fonctionnalité de Super E/S patrimoniales la plus utilisée.</p> <p>Interface à faible compte de broches</p> <p>Initiatives de contrôle environnementales, Moniteur de matériel</p> <p>Contrôleur de vitesse de ventilateur</p> <p>Fonction "Gardien intelligent" de l'ITE</p>
Mémoire principale	<p>Fentes DDR 2 DIMM x 2</p> <p>Prend en charge la DDR 2 533 / 667</p> <p>Chaque DIMM prend en charge des DDR2 de 256 Mo / 512 Mo / 1Go / 2 Go</p> <p>Capacité mémoire maximale de 4 Go</p> <p>Module de mémoire DDR2 à mode à simple voie</p> <p>Les DIMM à registres et DIMM avec code correcteurs d'erreurs ne sont pas prises en charge</p>	<p>Fentes DDR 2 DIMM x 2</p> <p>Prend en charge la DDR 2 533 / 667</p> <p>Chaque DIMM prend en charge des DDR2 de 256 Mo / 512 Mo / 1Go / 2 Go</p> <p>Capacité mémoire maximale de 4 Go</p> <p>Module de mémoire DDR2 à mode à simple voie</p> <p>Les DIMM à registres et DIMM avec code correcteurs d'erreurs ne sont pas prises en charge</p>
IDE	<p>Contrôleur IDE intégré</p> <p>Mode principale de Bus Ultra DMA 33 / 66 / 100 / 133</p> <p>Prend en charge le mode PIO 0~4,</p>	<p>Contrôleur IDE intégré</p> <p>Mode principale de Bus Ultra DMA 33 / 66 / 100 / 133</p> <p>Prend en charge le mode PIO 0~4,</p>
SATA	<p>Contrôleur Serial ATA intégré</p> <p>Taux de transfert jusqu'à 1.5 Go/s.</p> <p>Conforme à la spécification SATA Version 1.0</p>	<p>Contrôleur Serial ATA intégré</p> <p>Taux de transfert jusqu'à 1.5 Go/s.</p> <p>Conforme à la spécification SATA Version 1.0</p>

P4M900-M7 FE/P4M890-M7 FE

	P4M900-M7 FE	P4M890-M7 FE
LAN PHY	Realtek RTL 8201CL PHY 10 / 100 Mb/s négociation automatique Half / Full duplex capability	Realtek RTL 8201CL PHY 10 / 100 Mb/s négociation automatique Half / Full duplex capability
Codec audio	ALC662 Prise en charge de l'audio haute définition Sortie audio à 5.1 voies	ALC662 Prise en charge de l'audio haute définition Sortie audio à 5.1 voies
Fentes	Fente PCI x2 Slot PCI Express x16 x1 Slot PCI Express x 1 x1	Fente PCI x2 Slot PCI Express x16 x1 Slot PCI Express x 1 x1
Connecteur embarqué	Connecteur de disquette x1 Connecteur de Port d'imprimante x1 Connecteur IDE x2 Connecteur SATA x2 Connecteur du panneau avant x1 Connecteur Audio du panneau avant x1 Connecteur d'entrée CD x1 Embase de ventilateur UC x1 Embase de ventilateur système x1 Embase d'effacement CMOS x1 Connecteur USB x2 Connecteur d'alimentation (24 broches) x1 Connecteur d'alimentation (4 broches) x1	Connecteur de disquette x1 Connecteur de Port d'imprimante x1 Connecteur IDE x2 Connecteur SATA x2 Connecteur du panneau avant x1 Connecteur Audio du panneau avant x1 Connecteur d'entrée CD x1 Embase de ventilateur UC x1 Embase de ventilateur système x1 Embase d'effacement CMOS x1 Connecteur USB x2 Connecteur d'alimentation (24 broches) x1 Connecteur d'alimentation (4 broches) x1
E/S du panneau arrière	Clavier PS/2 x1 Souris PS/2 x1 Port série x1 Port VGA x1 Port LAN x1 Port USB x4 Fiche audio x3	Clavier PS/2 x1 Souris PS/2 x1 Port série x1 Port VGA x1 Port LAN x1 Port USB x4 Fiche audio x3
Dimensions de la carte	190 mm (l) X 244 mm (H)	190 mm (l) X 244 mm (H)
Fonctionnalités spéciales	Prise en charge RAID 0 / 1	Prise en charge RAID 0 / 1
Support SE	Windows 2K / XP / VISTA Biostar se réserve le droit d'ajouter ou de supprimer le support de SE avec ou sans préavis.	Windows 2K / XP Biostar se réserve le droit d'ajouter ou de supprimer le support de SE avec ou sans préavis.

ITALIAN

	<i>P4M900-M7 FE</i>	<i>P4M890-M7 FE</i>
CPU	LGA 775 Processore Intel Core2Duo/ Pentium 4 / Pentium D / Celeron D / Celeron 4xx fino a 3.8 GHz *It is recommended to use processors with 95W power consumption. Supporto di Hyper-Threading / Execute Disable Bit / Enhanced Intel SpeedStep® / Architettura Intel 64 / Tecnologia Extended Memory 64	LGA 775 Processore Intel Core2Duo/ Pentium 4 / Pentium D / Celeron D / Celeron 4xx fino a 3.8 GHz *It is recommended to use processors with 95W power consumption. Supporto di Hyper-Threading / Execute Disable Bit / Enhanced Intel SpeedStep® / Architettura Intel 64 / Tecnologia Extended Memory 64
FSB	533 / 800 / 1066 MHz	533 / 800 / 1066 MHz
Chipset	VIA P4M900 VIA VT8237A	VIA P4M890 VIA VT8237A
Grafica	Chrome9 HC 3D / 2D Graphics La memoria video condivisa massima è di 256MB	Chrome9 HC 3D / 2D Graphics La memoria video condivisa massima è di 256MB
Super I/O	ITE 8712F Fornisce le funzionalità legacy Super I/O usate più comunemente. Interfaccia LPC (Low Pin Count) Funzioni di controllo dell'ambiente: Monitoraggio hardware Controller velocità ventolina Funzione "Smart Guardian" di ITE	ITE 8712F Fornisce le funzionalità legacy Super I/O usate più comunemente. Interfaccia LPC (Low Pin Count) Funzioni di controllo dell'ambiente: Monitoraggio hardware Controller velocità ventolina Funzione "Smart Guardian" di ITE
Memoria principale	Alloggi DIMM DDR 2 x 2 Supporto di DDR2 533 / 667 Ciascun DIMM supporta DDR2 256MB / 512MB / 1GB / 2GB Capacità massima della memoria 4GB Modulo di memoria DDR2 a canale singolo DIMM registrati e DIMM ECC non sono supportati	Alloggi DIMM DDR 2 x 2 Supporto di DDR2 533 / 667 Ciascun DIMM supporta DDR2 256MB / 512MB / 1GB / 2GB Capacità massima della memoria 4GB Modulo di memoria DDR2 a canale singolo DIMM registrati e DIMM ECC non sono supportati
IDE	Controller IDE integrato Modalità Bus Master Ultra DMA 33 / 66 / 100 / 133 Supporto modalità PIO Mode 0-4	Controller IDE integrato Modalità Bus Master Ultra DMA 33 / 66 / 100 / 133 Supporto modalità PIO Mode 0-4
SATA	Controller Serial ATA integrato Velocità di trasferimento dei dati fino a 1.5 Gb/s. Compatibile specifiche SATA Versione 1.0.	Controller Serial ATA integrato Velocità di trasferimento dei dati fino a 1.5 Gb/s. Compatibile specifiche SATA Versione 1.0.

P4M900-M7 FE/P4M890-M7 FE

	<i>P4M900-M7 FE</i>	<i>P4M890-M7 FE</i>
LAN PHY	Realtek RTL 8201CL PHY Negoziazione automatica 10 / 100 Mb/s Capacità Half / Full Duplex	Realtek RTL 8201CL PHY Negoziazione automatica 10 / 100 Mb/s Capacità Half / Full Duplex
Codec audio	ALC662 Supporto audio High-Definition (HD) Uscita audio 5.1 canali	ALC662 Supporto audio High-Definition (HD) Uscita audio 5.1 canali
Alloggi	Alloggio PCI x2 Alloggio PCI Express x16 x1 Alloggio PCI Express x1 x1	Alloggio PCI x2 Alloggio PCI Express x16 x1 Alloggio PCI Express x1 x1
Connettori su scheda	Connettore floppy x1 Connettore Porta stampante x1 Connettore IDE x2 Connettore SATA x2 Connettore pannello frontale x1 Connettore audio frontale x1 Connettore CD-in x1 Collettore ventolina CPU x1 Collettore ventolina sistema x1 Collettore cancellazione CMOS x1 Connettore USB x2 Connettore alimentazione (24 pin) x1 Connettore alimentazione (4 pin) x1	Connettore floppy x1 Connettore Porta stampante x1 Connettore IDE x2 Connettore SATA x2 Connettore pannello frontale x1 Connettore audio frontale x1 Connettore CD-in x1 Collettore ventolina CPU x1 Collettore ventolina sistema x1 Collettore cancellazione CMOS x1 Connettore USB x2 Connettore alimentazione (24 pin) x1 Connettore alimentazione (4 pin) x1
I/O pannello posteriore	Tastiera PS/2 x1 Mouse PS/2 x1 Porta seriale x1 Porta VGA x1 Porta LAN x1 Porta USB x4 Connettore audio x3	Tastiera PS/2 x1 Mouse PS/2 x1 Porta seriale x1 Porta VGA x1 Porta LAN x1 Porta USB x4 Connettore audio x3
Dimensioni scheda	190 mm (larghezza) x 244 mm (altezza)	190 mm (larghezza) x 244 mm (altezza)
Caratteristiche speciali	Supporto RAID 0 / 1	Supporto RAID 0 / 1
Sistemi operativi supportati	Windows 2K / XP / VISTA Biostar si riserva il diritto di aggiungere o rimuovere il supporto di qualsiasi sistema operativo senza preavviso.	Windows 2K / XP Biostar si riserva il diritto di aggiungere o rimuovere il supporto di qualsiasi sistema operativo senza preavviso.

SPANISH

	<i>P4M900-M7 FE</i>	<i>P4M890-M7 FE</i>
CPU	LGA 775 Procesador Intel Core2Duo / Pentium 4 / Pentium D / Celeron D / Celeron 4xx hasta 3,8 GHz *It is recommended to use processors with 95W power consumption. Admite Hyper-Threading / Bit de deshabilitación de ejecución / Intel SpeedStep® Mejorado / Intel Architecture-64 / Tecnología Extended Memory 64	LGA 775 Procesador Intel Core2Duo / Pentium 4 / Pentium D / Celeron D / Celeron 4xx hasta 3,8 GHz *It is recommended to use processors with 95W power consumption. Admite Hyper-Threading / Bit de deshabilitación de ejecución / Intel SpeedStep® Mejorado / Intel Architecture-64 / Tecnología Extended Memory 64
FSB	533 / 800 / 1066 MHz	533 / 800 / 1066 MHz
Conjunto de chips	VIA P4M900 VIA VT8237A	VIA P4M890 VIA VT8237A
Gráficos	Chrome9 HC 3D / 2D Graphics Memoria máxima de vídeo compartida de 256MB	Chrome9 HC 3D / 2D Graphics Memoria máxima de vídeo compartida de 256MB
Súper E/S	ITE 8712F Le ofrece las funcionalidades heredadas de uso más común Súper E/S. Interfaz de cuenta Low Pin Iniciativas de control de entorno, Monitor hardware Controlador de velocidad de ventilador Función "Guardia inteligente" de ITE	ITE 8712F Le ofrece las funcionalidades heredadas de uso más común Súper E/S. Interfaz de cuenta Low Pin Iniciativas de control de entorno, Monitor hardware Controlador de velocidad de ventilador Función "Guardia inteligente" de ITE
Memoria principal	Ranuras DIMM DDR 2 x 2 Admite DDR2 de 533 / 667 Cada DIMM admite DDR de 256MB / 512MB / 1GB / 2GB Capacidad máxima de memoria de 4GB Módulo de memoria DDR 2 de canal Sencillo No admite DIMM registrados o DIMM compatibles con ECC	Ranuras DIMM DDR 2 x 2 Admite DDR2 de 533 / 667 Cada DIMM admite DDR de 256MB / 512MB / 1GB / 2GB Capacidad máxima de memoria de 4GB Módulo de memoria DDR 2 de canal Sencillo No admite DIMM registrados o DIMM compatibles con ECC
IDE	Controlador IDE integrado Modo bus maestro Ultra DMA 33 / 66 / 100 / 133 Soporte los Modos PIO 0~4,	Controlador IDE integrado Modo bus maestro Ultra DMA 33 / 66 / 100 / 133 Soporte los Modos PIO 0~4,
SATA	Controlador ATA Serie Integrado Tasas de transferencia de hasta 1.5 Gb/s. Compatible con la versión SATA 1.0.	Controlador ATA Serie Integrado Tasas de transferencia de hasta 1.5 Gb/s. Compatible con la versión SATA 1.0.

P4M900-M7 FE/P4M890-M7 FE

	<i>P4M900-M7 FE</i>	<i>P4M890-M7 FE</i>
Red Local	Realtek RTL 8201CL PHY Negociación de 10 / 100 Mb/s Funciones Half / Full dúplex	Realtek RTL 8201CL PHY Negociación de 10 / 100 Mb/s Funciones Half / Full dúplex
Códecs de sonido	ALC662 Soporte de sonido de Alta Definición Salida de sonido de 5.1 canales	ALC662 Soporte de sonido de Alta Definición Salida de sonido de 5.1 canales
Ranuras	Ranura PCI X2 Ranura PCI Express x16 X1 Ranura PCI express x 1 X1	Ranura PCI X2 Ranura PCI Express x16 X1 Ranura PCI express x 1 X1
Conectores en placa	Conector disco flexible X1 Conector Puerto de impresora X1 Conector IDE X2 Conector SATA X2 Conector de panel frontal X1 Conector de sonido frontal X1 Conector de entrada de CD X1 Cabecera de ventilador de CPU X1 Cabecera de ventilador de sistema X1 Cabecera de borrado de CMOS X1 Conector USB X2 Conector de alimentación (24 patillas) X1 Conector de alimentación (4 patillas) X1	Conector disco flexible X1 Conector Puerto de impresora X1 Conector IDE X2 Conector SATA X2 Conector de panel frontal X1 Conector de sonido frontal X1 Conector de entrada de CD X1 Cabecera de ventilador de CPU X1 Cabecera de ventilador de sistema X1 Cabecera de borrado de CMOS X1 Conector USB X2 Conector de alimentación (24 patillas) X1 Conector de alimentación (4 patillas) X1
Panel trasero de E/S	Teclado PS/2 X1 Ratón PS/2 X1 Puerto serie X1 Puerto VGA X1 Puerto de red local X1 Puerto USB X4 Conector de sonido X3	Teclado PS/2 X1 Ratón PS/2 X1 Puerto serie X1 Puerto VGA X1 Puerto de red local X1 Puerto USB X4 Conector de sonido X3
Tamaño de la placa	190mm. (A) X 244 Mm. (H)	190mm. (A) X 244 Mm. (H)
Funciones especiales	Admite RAID 0 / 1	Admite RAID 0 / 1
Soporte de sistema operativo	Windows 2K / XP / VISTA Biostar se reserva el derecho de añadir o retirar el soporte de cualquier SO con o sin aviso previo.	Windows 2K / XP Biostar se reserva el derecho de añadir o retirar el soporte de cualquier SO con o sin aviso previo.

PORTUGUESE

	<i>P4M900-M7 FE</i>	<i>P4M890-M7 FE</i>
CPU	LGA 775 Processador Intel Core2Duo/ Pentium 4 / Pentium D / Celeron D / Celeron 4xx até 3,8 GHz *It is recommended to use processors with 95W power consumption. Suporta as tecnologias Hyper-Threading / Execute Disable Bit / Enhanced Intel SpeedStep® / Intel Architecture -64 / Extended Memory 64	LGA 775 Processador Intel Core2Duo/ Pentium 4 / Pentium D / Celeron D / Celeron 4xx até 3,8 GHz *It is recommended to use processors with 95W power consumption. Suporta as tecnologias Hyper-Threading / Execute Disable Bit / Enhanced Intel SpeedStep® / Intel Architecture -64 / Extended Memory 64
FSB	533 / 800 / 1066 MHz	533 / 800 / 1066 MHz
Chipset	VIA P4M900 VIA VT8237A	VIA P4M890 VIA VT8237A
Placa gráfica	Chrome9 HC 3D / 2D Graphics Memória de vídeo máxima partilhada: 256 MB	Chrome9 HC 3D / 2D Graphics Memória de vídeo máxima partilhada: 256 MB
Especificação Super I/O	ITE 8712F Proporciona as funcionalidades mais utilizadas em termos da especificação Super I/O. Interface LPC (Low Pin Count). Iniciativas para controlo do ambiente Monitorização do hardware Controlador da velocidade da ventoinha Função "Smart Guardian" da ITE	ITE 8712F Proporciona as funcionalidades mais utilizadas em termos da especificação Super I/O. Interface LPC (Low Pin Count). Iniciativas para controlo do ambiente Monitorização do hardware Controlador da velocidade da ventoinha Função "Smart Guardian" da ITE
Memória principal	Ranuras DIMM DDR2 x 2 Suporta módulos DDR2 533 / 667 Cada módulo DIMM suporta uma memória DDR2 de 256MB / 512 MB / 1 GB / 2GB Capacidade máxima de memória: 4 GB Módulo de memória DDR2 de canal simples Os módulos DIMM registados e os DIMM ECC não são suportados	Ranuras DIMM DDR2 x 2 Suporta módulos DDR2 533 / 667 Cada módulo DIMM suporta uma memória DDR2 de 256MB / 512 MB / 1 GB / 2GB Capacidade máxima de memória: 4 GB Módulo de memória DDR2 de canal simples Os módulos DIMM registados e os DIMM ECC não são suportados
IDE	Controlador IDE integrado Modo Bus master Ultra DMA 33 / 66 / 100 / 133 Suporta o modo PIO 0~4,	Controlador IDE integrado Modo Bus master Ultra DMA 33 / 66 / 100 / 133 Suporta o modo PIO 0~4,
SATA	Controlador Serial ATA integrado Velocidades de transmissão de dados até 1.5 Gb/s. Compatibilidade com a especificação SATA versão 1.0.	Controlador Serial ATA integrado Velocidades de transmissão de dados até 1.5 Gb/s. Compatibilidade com a especificação SATA versão 1.0.

P4M900-M7 FE/P4M890-M7 FE

	P4M900-M7 FE	P4M890-M7 FE
LAN PHY	Realtek RTL 8201CL PHY Auto negociação de 10 / 100 MB/s Capacidade semi/full-duplex	Realtek RTL 8201CL PHY Auto negociação de 10 / 100 MB/s Capacidade semi/full-duplex
Codec de som	ALC662 Suporta a especificação High-Definition Audio Saída de áudio de 5.1 canais	ALC662 Suporta a especificação High-Definition Audio Saída de áudio de 5.1 canais
Ranhuras	Ranhura PCI x2 Ranhura PCI Express x16 x1 Ranhura PCI Express x 1 x1	Ranhura PCI x2 Ranhura PCI Express x16 x1 Ranhura PCI Express x 1 x1
Conectores na placa	Conector da unidade de disquetes x1 Conector da para impressora x1 Conector IDE x2 Conector SATA x2 Conector do painel frontal x1 Conector de áudio frontal x1 Conector para entrada de CDs x1 Conector da ventoinha da CPU x1 Conector da ventoinha do sistema x1 Conector para limpeza do CMOS x1 Conector USB x2 Conector de alimentação (24 pinos) x1 Conector de alimentação (4 pinos) x1	Conector da unidade de disquetes x1 Conector da para impressora x1 Conector IDE x2 Conector SATA x2 Conector do painel frontal x1 Conector de áudio frontal x1 Conector para entrada de CDs x1 Conector da ventoinha da CPU x1 Conector da ventoinha do sistema x1 Conector para limpeza do CMOS x1 Conector USB x2 Conector de alimentação (24 pinos) x1 Conector de alimentação (4 pinos) x1
Entradas/Saídas no painel traseiro	Teclado PS/2 x1 Rato PS/2 x1 Porta série x1 Porta VGA x1 Porta LAN x1 Porta USB x4 Tomada de áudio x3	Teclado PS/2 x1 Rato PS/2 x1 Porta série x1 Porta VGA x1 Porta LAN x1 Porta USB x4 Tomada de áudio x3
Tamanho da placa	190 mm (L) X 244 mm (A)	190 mm (L) X 244 mm (A)
Características especiais	Suporta as funções RAID 0 / 1	Suporta as funções RAID 0 / 1
Sistemas operativos suportados	Windows 2K / XP / VISTA A Biostar reserva-se o direito de adicionar ou remover suporte para qualquer sistema operativo com ou sem aviso prévio.	Windows 2K / XP A Biostar reserva-se o direito de adicionar ou remover suporte para qualquer sistema operativo com ou sem aviso prévio.

POLISH

	<i>P4M900-M7 FE</i>	<i>P4M890-M7 FE</i>
Procesor	LGA 775 Procesor Intel Core2Duo/ Pentium 4 / Pentium D / Celeron D / Celeron 4xx do 3,8 GHz *It is recommended to use processors with 95W power consumption. Obsługa Hyper-Threading / Execute Disable Bit / Enhanced Intel SpeedStep® / Intel Architecture-64 / Extended Memory 64 Technology	LGA 775 Procesor Intel Core2Duo/ Pentium 4 / Pentium D / Celeron D / Celeron 4xx do 3,8 GHz *It is recommended to use processors with 95W power consumption. Obsługa Hyper-Threading / Execute Disable Bit / Enhanced Intel SpeedStep® / Intel Architecture-64 / Extended Memory 64 Technology
FSB	533 / 800 / 1066 MHz	533 / 800 / 1066 MHz
Chipset	VIA P4M900 VIA VT8237A	VIA P4M890 VIA VT8237A
Grafika	Chrome9 HC 3D / 2D Graphics Maks. wielkość współdzielonej pamięci video wynosi 256MB	Chrome9 HC 3D / 2D Graphics Maks. wielkość współdzielonej pamięci video wynosi 256MB
Pamięć główna	Gniazda DDR2 DIMM x 2 Obsługa DDR2 533 / 667 Każde gniazdo DIMM obsługuje moduły 256MB / 512MB / 1GB / 2GB DDR2 Maks. wielkość pamięci 4GB Moduł pamięci DDR2 z trybem pojedynczego kanału Brak obsługi Registered DIMM oraz ECC DIMM	Gniazda DDR2 DIMM x 2 Obsługa DDR2 533 / 667 Każde gniazdo DIMM obsługuje moduły 256MB / 512MB / 1GB / 2GB DDR2 Maks. wielkość pamięci 4GB Moduł pamięci DDR2 z trybem pojedynczego kanału Brak obsługi Registered DIMM oraz ECC DIMM
Super I/O	ITE 8712F Zapewnia najbardziej powszechne funkcje Super I/O. Interfejs Low Pin Count Funkcje kontroli warunków pracy, Monitor H/W Kontroler prędkości wentylatora Funkcja ITE "Smart Guardian"	ITE 8712F Zapewnia najbardziej powszechne funkcje Super I/O. Interfejs Low Pin Count Funkcje kontroli warunków pracy, Monitor H/W Kontroler prędkości wentylatora Funkcja ITE "Smart Guardian"
IDE	Zintegrowany kontroler IDE Ultra DMA 33 / 66 / 100 / 133 Tryb Bus Master obsługa PIO tryb 0~4,	Zintegrowany kontroler IDE Ultra DMA 33 / 66 / 100 / 133 Tryb Bus Master obsługa PIO tryb 0~4,
SATA	Zintegrowany kontroler Serial ATA Transfer danych do 1.5 Gb/s. Zgodność ze specyfikacją SATA w wersji 1.0.	Zintegrowany kontroler Serial ATA Transfer danych do 1.5 Gb/s. Zgodność ze specyfikacją SATA w wersji 1.0.

P4M900-M7 FE/P4M890-M7 FE

	P4M900-M7 FE	P4M890-M7 FE
LAN PHY	Realtek RTL 8201CL PHY 10 / 100 Mb/s z automatyczną negocjacją szybkości Działanie w trybie połowicznego / pełnego dupleksu	Realtek RTL 8201CL PHY 10 / 100 Mb/s z automatyczną negocjacją szybkości Działanie w trybie połowicznego / pełnego dupleksu
Kodek dźwiękowy	ALC662 Obsługa High-Definition Audio 5.1 kanałowe wyjście audio	ALC662 Obsługa High-Definition Audio 5.1 kanałowe wyjście audio
Gniazda	Gniazdo PCI x2 Gniazdo PCI Express x16 x1 Gniazdo PCI Express x1 x1	Gniazdo PCI x2 Gniazdo PCI Express x16 x1 Gniazdo PCI Express x1 x1
Złącza wbudowane	Złącze napędu dyskietek x1 Złącze Port drukarki x1 Złącze IDE x2 Złącze SATA x2 Złącze panela przedniego x1 Przednie złącze audio x1 Złącze wejścia CD x1 Złącze główkowe wentylatora procesora x1 Złącze główkowe wentylatora systemowego x1 Złącze główkowe kasowania CMOS x1 Złącze USB x2 Złącze zasilania (24 pinowe) x1 Złącze zasilania (4 pinowe) x1	Złącze napędu dyskietek x1 Złącze Port drukarki x1 Złącze IDE x2 Złącze SATA x2 Złącze panela przedniego x1 Przednie złącze audio x1 Złącze wejścia CD x1 Złącze główkowe wentylatora procesora x1 Złącze główkowe wentylatora systemowego x1 Złącze główkowe kasowania CMOS x1 Złącze USB x2 Złącze zasilania (24 pinowe) x1 Złącze zasilania (4 pinowe) x1
Back Panel I/O	Klawiatura PS/2 x1 Mysz PS/2 x1 Port szeregowy x1 Port VGA x1 Port LAN x1 Port USB x4 Gniazdo audio x3	Klawiatura PS/2 x1 Mysz PS/2 x1 Port szeregowy x1 Port VGA x1 Port LAN x1 Port USB x4 Gniazdo audio x3
Wymiary płyty	190 mm (S) X 244 mm (W)	190 mm (S) X 244 mm (W)
Funkcje specjalne	Obsługa RAID 0 / 1	Obsługa RAID 0 / 1
Obsługa systemu operacyjn ego	Windows 2K / XP / VISTA Biostar zastrzega sobie prawo do dawania lub odwoływania obsługi dowolnego systemu operacyjnego bez powiadomienia.	Windows 2K / XP Biostar zastrzega sobie prawo do dawania lub odwoływania obsługi dowolnego systemu operacyjnego bez powiadomienia.

RUSSIAN

	P4M900-M7 FE	P4M890-M7 FE
CPU (центральный процессор)	LGA 775 Процессор Intel Core2Duo/ Pentium 4 / Pentium D / Celeron D / Celeron 4xx до 3.8 ГГц *It is recommended to use processors with 95W power consumption. Поддержка технологий Hyper-Threading / Execute Disable Bit / Enhanced Intel SpeedStep® / Intel Architecture-64 / Extended Memory 64 Technology	LGA 775 Процессор Intel Core2Duo/ Pentium 4 / Pentium D / Celeron D / Celeron 4xx до 3.8 ГГц *It is recommended to use processors with 95W power consumption. Поддержка технологий Hyper-Threading / Execute Disable Bit / Enhanced Intel SpeedStep® / Intel Architecture-64 / Extended Memory 64 Technology
FSB	533 / 800 / 1066 МГц	533 / 800 / 1066 МГц
Набор микросхем	VIA P4M900 VIA VT8237A	VIA P4M890 VIA VT8237A
Графика	Chrome9 HC 3D / 2D Graphics Максимальная совместно используемая видео память составляет 256 МБ	Chrome9 HC 3D / 2D Graphics Максимальная совместно используемая видео память составляет 256 МБ
Основная память	Слоты DDR2 DIMM x 2 Поддержка DDR2 533 / 667 Каждый модуль DIMM поддерживает 256МБ / 512МБ / 1ГБ / 2ГБ DDR2 Максимальная ёмкость памяти 4 ГБ Модуль памяти с одноканальным режимом DDR2 Не поддерживает зарегистрированные модули DIMM and ECC DIMM	Слоты DDR2 DIMM x 2 Поддержка DDR2 533 / 667 Каждый модуль DIMM поддерживает 256МБ / 512МБ / 1ГБ / 2ГБ DDR2 Максимальная ёмкость памяти 4 ГБ Модуль памяти с одноканальным режимом DDR2 Не поддерживает зарегистрированные модули DIMM and ECC DIMM
Super I/O	ITE 8712F Обеспечивает наиболее используемые действующие функциональные возможности Super I/O. Интерфейс с низким количеством выводов Инициативы по охране окружающей среды, Аппаратный монитор Регулятор скорости Функция ITE "Smart Guardian" (Интеллектуальная защита)	ITE 8712F Обеспечивает наиболее используемые действующие функциональные возможности Super I/O. Интерфейс с низким количеством выводов Инициативы по охране окружающей среды, Аппаратный монитор Регулятор скорости Функция ITE "Smart Guardian" (Интеллектуальная защита)
IDE	Встроенное устройство управления встроенными интерфейсами устройств Режим "хозяина" шины Ultra DMA 33 / 66 / 100 / 133 Поддержка режима PIO 0~4,	Встроенное устройство управления встроенными интерфейсами устройств Режим "хозяина" шины Ultra DMA 33 / 66 / 100 / 133 Поддержка режима PIO 0~4,
SATA	Встроенное последовательное устройство управления ATA скорость передачи данных до 1.5 гигабит/с. Соответствие спецификации SATA версия 1.0.	Встроенное последовательное устройство управления ATA скорость передачи данных до 1.5 гигабит/с. Соответствие спецификации SATA версия 1.0.

P4M900-M7 FE/P4M890-M7 FE

	P4M900-M7 FE	P4M890-M7 FE
Локальная сеть	Realtek RTL 8201CL PHY Автоматическое согласование 10 / 100 Мб/с Частичная / полная дуплексная способность	Realtek RTL 8201CL PHY Автоматическое согласование 10 / 100 Мб/с Частичная / полная дуплексная способность
Звуковой кодек	ALC662 Звуковая поддержка High-Definition 5.1-канальный звуковой выход	ALC662 Звуковая поддержка High-Definition 5.1-канальный звуковой выход
Слоты	Слот PCI x2 Слот PCI Express x16 x1 Слот PCI Express x 1 x1	Слот PCI x2 Слот PCI Express x16 x1 Слот PCI Express x 1 x1
Встроенный разъём	Разъём НГМД x1 Разъём Порт подключения принтера x1 Разъём IDE x2 Разъём SATA x2 Разъём на лицевой панели x1 Входной звуковой разъём x1 Разъём ввода для CD x1 Контактирующее приспособление вентилятора центрального процессора x1 Контактирующее приспособление вентилятора системы x1 Открытое контактирующее приспособление CMOS x1 USB-разъём x2 Разъём питания (24 вывод) x1 Разъём питания (4 вывод) x1	Разъём НГМД x1 Разъём Порт подключения принтера x1 Разъём IDE x2 Разъём SATA x2 Разъём на лицевой панели x1 Входной звуковой разъём x1 Разъём ввода для CD x1 Контактирующее приспособление вентилятора центрального процессора x1 Контактирующее приспособление вентилятора системы x1 Открытое контактирующее приспособление CMOS x1 USB-разъём x2 Разъём питания (24 вывод) x1 Разъём питания (4 вывод) x1
Задняя панель средств ввода-вывода	Клавиатура PS/2 x1 Мышь PS/2 x1 Последовательный порт x1 Порт VGA x1 Порт LAN x1 USB-порт x4 Гнездо для подключения наушников x3	Клавиатура PS/2 x1 Мышь PS/2 x1 Последовательный порт x1 Порт VGA x1 Порт LAN x1 USB-порт x4 Гнездо для подключения наушников x3
Размер панели	190 мм (Ш) X 244 мм (В)	190 мм (Ш) X 244 мм (В)
Специальные технические характеристики	Поддержка RAID 0 / 1	Поддержка RAID 0 / 1
Поддержка OS	Windows 2K / XP / VISTA Biostar сохраняет за собой право добавлять или удалять средства обеспечения для OS с или без предварительного уведомления.	Windows 2K / XP Biostar сохраняет за собой право добавлять или удалять средства обеспечения для OS с или без предварительного уведомления.

ARABIC

P4M890-M7 FE	P4M900-M7 FE	
LGA 775 Intel Core2Duo/ Pentium 4 / Pentium D / Celeron D / Celeron 4xx 8.3 بتردد يصل إلى 8.3 جيجا هرتز *It is recommended to use processors with 95W power consumption. Hyper-Threading / Execute Disable Bit / Enhanced Intel SpeedStep® / Extended Memory 64 Technology	LGA 775 Intel Core2Duo/ Pentium 4 / Pentium D / Celeron D / Celeron 4xx 8.3 بتردد يصل إلى 8.3 جيجا هرتز *It is recommended to use processors with 95W power consumption. Hyper-Threading / Execute Disable Bit / Enhanced Intel SpeedStep® / Extended Memory 64 Technology	وحدة المعالجة المركزية
533 / 800 / 1066 تردد	533 / 800 / 1066 تردد	الناقل الأمامي الجانبية
VIA P4M890 VIA VT8237A	VIA P4M900 VIA VT8237A	مجموعة الشرائح
Chrome9 HC 3D / 2D Graphics ميجا بايت 256 أقصى سعة لذاكرة الفيديو المشتركة	Chrome9 HC 3D / 2D Graphics ميجا بايت 256 أقصى سعة لذاكرة الفيديو المشتركة	بطاقة الرسومات
عدد 2 فتحة DDR2 DIMM ميجا بايت 533 / 667 تدعم الذاكرة من نوع سعة DDR2 تدعم ذاكرة من نوع DIMM كل فتحة ميجا بايت 1 و 2 جيجا بايت / 512 ميجا بايت 256 سعة ذاكرة قصوى 4 جيجا بايت أحادية القناة DDR2 وحدة ذاكرة ECC وتلك التي لا تتوافق مع DIMM لا تدعم رفائق الذاكرة	عدد 2 فتحة DDR2 DIMM ميجا بايت 533 / 667 تدعم الذاكرة من نوع سعة DDR2 تدعم ذاكرة من نوع DIMM كل فتحة ميجا بايت 1 و 2 جيجا بايت / 512 ميجا بايت 256 سعة ذاكرة قصوى 4 جيجا بايت أحادية القناة DDR2 وحدة ذاكرة ECC وتلك التي لا تتوافق مع DIMM لا تدعم رفائق الذاكرة	الذاكرة الرئيسية
ITE 8712F الأكثر استخداماً. Super I/O وظيفة Low Pin Count Interface تدعم تقنية وسائل التحكم في البيئة: مراقب لمعرفة حالة الأجهزة مراقب في سرعة المروحة من ITE "Smart Guardian" وظيفة	ITE 8712F الأكثر استخداماً. Super I/O وظيفة Low Pin Count Interface تدعم تقنية وسائل التحكم في البيئة: مراقب لمعرفة حالة الأجهزة مراقب في سرعة المروحة من ITE "Smart Guardian" وظيفة	Super I/O
متكامل IDE متحكم Ultra DMA 33 / 66 / 100 / 133 ناتق تقنية وضع رئيسي PIO Mode 0~4 دعم وضع	متكامل IDE متحكم Ultra DMA 33 / 66 / 100 / 133 ناتق تقنية وضع رئيسي PIO Mode 0~4 دعم وضع	منفذ IDE
متكامل Serial ATA متحكم نقل البيانات بسرعات تصل إلى 1.5 جيجابت/ثانية. 1.0 الإصدار SATA مطابقة لمواصفات	متكامل Serial ATA متحكم نقل البيانات بسرعات تصل إلى 1.5 جيجابت/ثانية. 1.0 الإصدار SATA مطابقة لمواصفات	SATA

P4M900-M7 FE/P4M890-M7 FE

P4M890-M7 FE		P4M900-M7 FE		
Realtek RTL 8201CL PHY تفاوض ثنائي 100/10 ميغا بايت / ثلية إمكانية النقل المزدوج الكامل/النصفي		Realtek RTL 8201CL PHY تفاوض ثنائي 100/10 ميغا بايت / ثلية إمكانية النقل المزدوج الكامل/النصفي		شبكة داخلية
ALC662 تدعم تقنية الصوت علي التعريف من 5.1 قنوات لخرج الصوت		ALC662 تدعم تقنية الصوت علي التعريف من 5.1 قنوات لخرج الصوت		كوديك الصوت
عدد 2	فتحة PCI	عدد 2	فتحة PCI	الفتحات
عدد 1	فتحة PCI Express x 16	عدد 1	فتحة PCI Express x 16	
عدد 1	فتحة PCI Express x 1	عدد 1	فتحة PCI Express x 1	
عدد 1	مقذ محرك أقراص مرنة	عدد 1	مقذ محرك أقراص مرنة	المنافذ على سطح اللوحة
عدد 1	مقذ طابعة	عدد 1	مقذ طابعة	
عدد 2	مقذ IDE	عدد 2	مقذ IDE	
عدد 2	مقذ SATA	عدد 2	مقذ SATA	
عدد 1	مقذ اللوحة الأممية	عدد 1	مقذ اللوحة الأممية	
عدد 1	مقذ الصوت الأممي	عدد 1	مقذ الصوت الأممي	
عدد 1	مقذ CD-IN	عدد 1	مقذ CD-IN	
عدد 1	وصلة مروحة وحدة المعالجة المركزية	عدد 1	وصلة مروحة وحدة المعالجة المركزية	
عدد 1	وصلة مروحة للظلم	عدد 1	وصلة مروحة للظلم	
عدد 1	وصلة مسح CMOS	عدد 1	وصلة مسح CMOS	
عدد 2	مقذ USB	عدد 2	مقذ USB	
عدد 1	مقذ توصيل الطاقة (24دوس)	عدد 1	مقذ توصيل الطاقة (24دوس)	
عدد 1	مقذ توصيل الطاقة (4دبليس)	عدد 1	مقذ توصيل الطاقة (4دبليس)	
عدد 1	لوحة مفاتيح PS/2	عدد 1	لوحة مفاتيح PS/2	
عدد 1	مؤس PS/2	عدد 1	مؤس PS/2	
عدد 1	مقذ تسلسلي	عدد 1	مقذ تسلسلي	
عدد 1	مقذ VGA	عدد 1	مقذ VGA	
عدد 1	مقذ شبكة لتصل محلية	عدد 1	مقذ شبكة لتصل محلية	
عدد 4	منافذ USB	عدد 4	منافذ USB	
عدد 3	مقيس صوت	عدد 3	مقيس صوت	
190 مم (عرض) X 244 مم (ارتفاع)		190 مم (عرض) X 244 مم (ارتفاع)		حجم اللوحة
RAID 0 / 1 تدعم تقنية		RAID 0 / 1 تدعم تقنية		مزايا خاصة
Windows 2K / XP بحقها في اضافة أو ازالة الدعم لأي نظام Biostar تحتفظ تشغيل باخطار أو بدون إخطار .		Windows 2K / XP / VISTA بحقها في اضافة أو ازالة الدعم لأي نظام Biostar تحتفظ تشغيل باخطار أو بدون إخطار .		دعم أنظمة التشغيل

JAPANESE

	P4M900-M7 FE	P4M890-M7 FE
CPU	LGA 775 Intel Core2Duo/ Pentium 4/ Pentium D / Celeron D / Celeron 4xx processor up to 3.8 GHz *It is recommended to use processors with 95W power consumption. Hyper-Threading / Execute Disable Bit / Enhanced Intel SpeedStep® / Intel Architecture-64 / Extended Memory 64 Technology をサポートします	LGA 775 Intel Core2Duo/ Pentium 4/ Pentium D / Celeron D / Celeron 4xx processor up to 3.8 GHz *It is recommended to use processors with 95W power consumption. Hyper-Threading / Execute Disable Bit / Enhanced Intel SpeedStep® / Intel Architecture-64 / Extended Memory 64 Technology をサポートします
FSB	533 / 800 / 1066 MHz	533 / 800 / 1066 MHz
チップセット	VIA P4M900 VIA VT8237A	VIA P4M890 VIA VT8237A
グラフィックス	Chrome9 HC 3D / 2D Graphics 最大の共有ビデオメモリは256MBです	Chrome9 HC 3D / 2D Graphics 最大の共有ビデオメモリは256MBです
メインメモリ	DDR2 DIMMスロット × 2 DDR2 533 / 667をサポート 各DIMMは 256/512MB/1GB/2GB DDR2をサ ポート 最大メモリ容量4GB シングル チャンネルモードDDR2メモリモジュ ール 登録済みDIMMとECC DIMMはサポートされま せん	DDR2 DIMMスロット × 2 DDR2 533 / 667をサポート 各DIMMは 256/512MB/1GB/2GB DDR2をサ ポート 最大メモリ容量4GB シングル チャンネルモードDDR2メモリモジュ ール 登録済みDIMMとECC DIMMはサポートされま せん
Super I/O	ITE 8712F もつとも一般に使用されるレガシーSuper I/O 機能を採用しています。 低ピンカウントインターフェイス 環境コントロールイニシアチブ、 H/Wモニター ファン速度コントローラ/ モニター ITEの「スマートガーディアン」機能	ITE 8712F もつとも一般に使用されるレガシーSuper I/O 機能を採用しています。 低ピンカウントインターフェイス 環境コントロールイニシアチブ、 H/Wモニター ファン速度コントローラ/ モニター ITEの「スマートガーディアン」機能
IDE	統合IDEコントローラ Ultra DMA 33 / 66 / 100 / 133バスマスタモー ド PIO Mode 0~4のサポート	統合IDEコントローラ Ultra DMA 33 / 66 / 100 / 133バスマスタモー ド PIO Mode 0~4のサポート
SATA	統合シリアルATAコントローラ 最高1.5 Gb/秒のデータ転送速度 SATAバージョン1.0仕様に準拠。	統合シリアルATAコントローラ 最高1.5 Gb/秒のデータ転送速度 SATAバージョン1.0仕様に準拠。

P4M900-M7 FE/P4M890-M7 FE

	P4M900-M7 FE	P4M890-M7 FE
LAN PHY	Realtek RTL 8201CL PHY 10 / 100 Mb/秒のオートネゴシエーション 半/全二重機能	Realtek RTL 8201CL PHY 10 / 100 Mb/秒のオートネゴシエーション 半/全二重機能
サウンド Codec	ALC662 ハイデフィニションオーディオのサポート 5.1 チャンネルオーディオアウト	ALC662 ハイデフィニションオーディオのサポート 5.1 チャンネルオーディオアウト
スロット	PCIスロット x2 PCI Express x16スロット x1 PCI Express x1スロット x1	PCIスロット x2 PCI Express x16スロット x1 PCI Express x1スロット x1
オンボード コネクタ	フロッピーコネクタ x1 プリンタポートコネクタ x1 IDEコネクタ x2 SATAコネクタ x2 フロントパネルコネクタ x1 フロントオーディオコネクタ x1 CDインコネクタ x1 CPUファンヘッダ x1 システムファンヘッダ x1 CMOSクリアヘッダ x1 USBコネクタ x2 電源コネクタ(24ピン) x1 電源コネクタ(4ピン) x1	フロッピーコネクタ x1 プリンタポートコネクタ x1 IDEコネクタ x2 SATAコネクタ x2 フロントパネルコネクタ x1 フロントオーディオコネクタ x1 CDインコネクタ x1 CPUファンヘッダ x1 システムファンヘッダ x1 CMOSクリアヘッダ x1 USBコネクタ x2 電源コネクタ(24ピン) x1 電源コネクタ(4ピン) x1
背面パネル I/O	PS/2キーボード x1 PS/2マウス x1 シリアルポート x1 VGAポート x1 LANポート x1 USBポート x4 オーディオジャック x3	PS/2キーボード x1 PS/2マウス x1 シリアルポート x1 VGAポート x1 LANポート x1 USBポート x4 オーディオジャック x3
ボードサイズ	190 mm (幅) X 244 mm (高さ)	190 mm (幅) X 244 mm (高さ)
特殊機能	RAID 0 / 1のサポート	RAID 0 / 1のサポート
OSサポー ト	Windows 2K / XP / VISTA Biostarは事前のサポートなしにOSサポートを 追加または削除する権利を留保します。	Windows 2K / XP Biostarは事前のサポートなしにOSサポートを 追加または削除する権利を留保します。

2008/04/07