Chapter 1

Overview

MX59 Pro is an all-in-one Pentium®-based motherboard that features **VIA MVP4** chipset with **onchip high performance 2D/3D AGP graphics controller and a 16-bit sound processor**. This motherboard utilizes the PCI/ISA architecture and Micro ATX form factor and integrates Super I/O controller, a PCI mode 4 enhanced IDE controller with bus master and Ultra DMA/66 to enhance system performance. It has **512KB** pipelined-burst second-level cache onboard and supports two Dual in-line memory module (DIMM) slots that allow the installation of **SDRAM** memory and expansion up to a maximum of **512MB**.

In addition to the above features, MX59 Pro also implements plenty of special features.

Full-range CPU core voltage This motherboard supports the CPU core voltage from 1.3V to 3.5V, that can be applied to various CPU type in future.

High Efficient Synchronous Switching Power Regulator Most of the current switching designs are asynchronous mode, which from the technical point of view, still consumes very high power as well as heat. This motherboard implements high efficient Synchronous switching design that the temperature of MOS FET is less than 36 degree C comparing with 57 degree Schottky diode of Asynchronous design.

Zero Voltage Wake on Modem In conjunction with ATX soft power On/Off, it is possible to have system totally power off and wakeup to automatically answer a phone call such as answering machine or to send/receive fax. The most important break through is not only external box modem but also internal modem card can be used to support 0V Wake On Modem. The MX59 Pro and FM56-P internal modem card implement special circuit (patent applied) to make sure the modem card work properly without any power.

Wake on LAN This feature is very similar as 0V Wake On Modem, but it is through local area network. To use Wake on LAN function, you must have a network card that supports this feature and also need to install a network management software.

Overview

Wake on RTC Timer The Wake Up Timer is more like an alarm, which wakes up and power on your system at a pre-defined time for specific application. It can be set to wake up everyday or on specific date within a month. The date/time accuracy is second.

Over Current Protection Circuit The Over Current Protection was very popular implemented on the Baby AT or ATX +5V/+12V switching power supply. It is very useful to prevent accidental short circuit when you install the motherboard, HDD, add-on cards into housing. But unfortunately, the new generation CPU and chipset use 3.3V/2.8V Voltage which has regulator to transfer 5V to 3.3V (Vcpuio, chipset, PBSRAM, SDRAM) and 2.8V (CPU Vcore), and makes 5V Over Current Protection useless. AOpen MX59 Pro supports 3.3V and 2.8V Over Current Protection, in conjunction with 5V/12V power supply provide the full line Over Current Protection.

CPU Thermal Protection MX59 Pro has a special thermal detection circuit to have warning through application software when the temperature is higher than a predefined value.

CPU and Housing Fan Monitoring MX59 Pro has one more "fan monitoring" function to prevent system overheat. There are two fan connectors, one is for CPU and the other can be an extra housing fan. The system will report and alarm fan malfunction though utility software such as Hardware Monitor utility (named AOHW100, where 100 means version number).

System Voltage Monitoring Furthermore, MX59 Pro implements a voltage monitoring system, As you turn on your system, this smart design will continue to monitor your system working voltage. If any of the system voltage is over the component's standard. There will be alarm though software such as Hardware Monitor utility for a warning to user.

Resetable Fuse MX59 Pro implements resetable fuses to prevent any accidental short circuit caused by keyboard or USB devices hot plug.

FCC DoC Certificate MX59 Pro has passed FCC DoC test. The radiation is very low, you can use any kind of housing.

Powerful Utility Software Included AOpen Bonus Pack CD disc contains many useful utilities, such as Norton Antivirus, AOchip, Hardware Monitoring Utility, and Suspend to Hard Drive utility.

Multi-language BIOS This breakthrough will help you set BIOS items without the language barrier.

1.1 Specifications

Form Factor	Micro ATX
Board Size	220 mm x 245 mm
CPU	Intel Pentium Processor P54C, PP/MT (P55C), AMD K5/ K6/K6-2/K6-III, Cyrix 6x86/M2 and IDT C6.
System Memory	DIMM 168-pin x2, maximum 512MB.
Second-level Cache	512KB pipelined-burst cache onboard
Chipset	VIA MVP4
Expansion Slots	ISA x1 and PCI x4
VGA (AGP)	High performance 2D/3D graphics controller onchip in VIA MVP4
Serial Port	Two serial ports UART 16C550 compatible
Parallel Port	One parallel port supports standard parallel port (SPP), enhanced parallel port (EPP) or extended capabilities port (ECP).
Floppy Interface	Floppy interface supports 3.5 inches drives with 720KB, 1.44MB or 2.88MB format or 5.25 inches drives with 360KB, 1.2MB format
IDE Interface	Dual-channel IDE interface support maximum 4 IDE hard disks or CDROM, mode 4, bus master hard disk drives and Ultra DMA/66 mode hard drives are also supported.
USB Interface	Two USB ports supported by USB bracket, the BIOS also supports USB driver to simulate legacy keyboard.
PS/2 Mouse	Mini-Din PS/2 mouse connector onboard.
Keyboard	Mini-Din PS/2 keyboard connector onboard.
RTC and Battery	RTC build in chipset, Lithium (CR-2032) battery.
BIOS	AWARD Plug-and-Play, 2M bit Flash ROM BIOS. Multi-language versions supported.

Overview

1.2 Zero Voltage Wake on Modem

The Wake on Modem discussed here is to wakeup from true power off (identified by fan of power supply is off), This motherboard still supports traditional green PC suspend mode but it is not discussed here.

With the help ATX soft power On/Off, it is possible to have system totally power off (The traditional suspend mode of power management function does not really turn off the system power supply), and wakeup to automatically answer a phone call such as answering machine or to send/receive fax. You may identify the true power off by checking fan of your power supply. Both external box modem and internal modem card can be used to support 0V Wake On Modem, but if you use external modem, you have to keep the box modem always power-on. AOpen MX59 Pro and internal modem card implement special circuit (patent applied) and make sure the modem card works properly without any power. We recommend you choose AOpen modem card (For example, FM56-P, FM56-H, etc.) for 0V Wake On Modem applications.

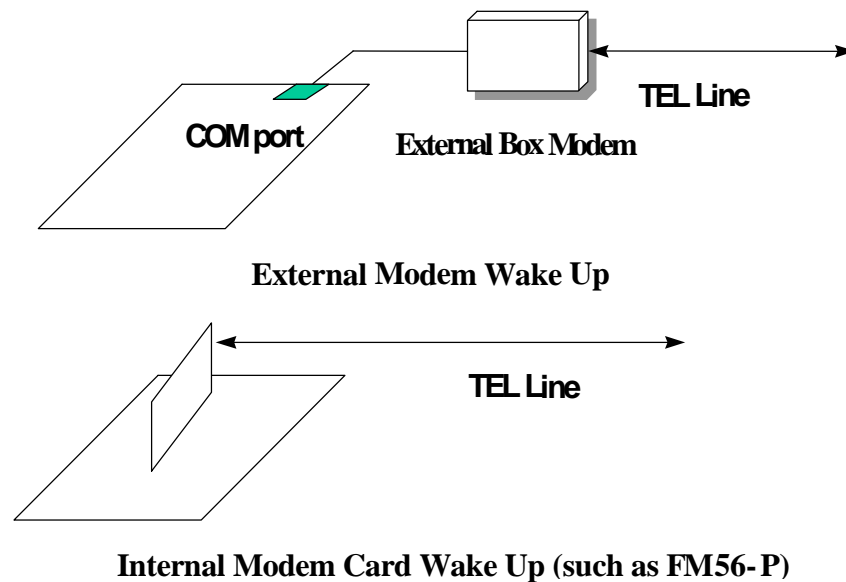

Overview

For Internal Modem Card (AOpen FM56-P):

1. Go into BIOS setup, Power Management à 0V Wake On Modem, select Enabled.
2. Setup your application, put into Windows 95.
3. Turn system power off by soft power switch.
4. Connect 4-pin Modem Ring-On cable from FM56-P RING connector to MX59 Pro connector WKUP.
5. Connect telephone line to FM56-P. You are now ready to use Wake On Modem.

For External Box Modem:

1. Go into BIOS setup, Power Management à 0V Wake On Modem, select Enabled.
2. Setup your application, put into Windows 95 Start Up.
3. Turn system power off by soft power switch.
4. Connect RS232 cable of external box Modem to COM1 or COM2.
5. Connect telephone line to external box Modem. Turn on Modem power (you must keep Modem power always on). You are now ready to use Wake On Modem.



Tip: External 0V Wake On Modem signal is detected through COM1 or COM2. Internal modem card wake up signal is detected through cable from connector RING (on modem card) to WKUP (on mainboard).



Note: If you use external modem, the power of external modem must be kept on to receive signal from telephone line. Internal modem card has no such limitation.

Overview

1.3 System Voltage Monitoring

This motherboard implements a voltage monitoring system. As you turn on your system, this smart design will continue to monitor your system working voltage. If any of the system voltage is over the component's standard. There will be alarm through application software such as Hardware Monitor utility for a warning to user. System voltage monitoring function monitors CPU core voltage. It is automatically implemented by BIOS and Hardware Monitor utility (the file name is like aohw100.exe, where 100 means the version number, no hardware installation is needed.

1.4 Fan Monitoring

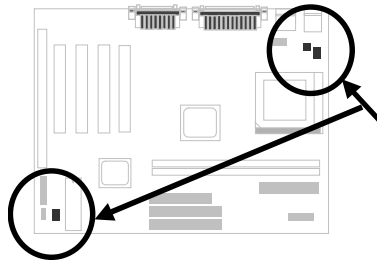

There are three fan connectors, two is for CPU, the other can be a housing fan. The fan monitoring function is implemented by connecting fan to 3-pin fan connector **CPUFAN1** and **FAN**, and installing Hardware Monitoring Utility.



Note: You need 3-pin fan that supports SENSE signal for fan monitoring function to work properly.

1.5 CPU Thermal Protection

This motherboard implements special thermal protection circuit below the CPU. When temperature is higher than a predefined value, the CPU speed will automatically slow down and there will be warning from BIOS and also Hardware Monitoring Utility software.

CPU Thermal Protection is automatically implemented by BIOS and utility software, no extra hardware installation is needed.

Chapter 2

Hardware Installation

This chapter gives you a step-by-step procedure on how to install your system. Follow each section accordingly.



Caution: *Electrostatic discharge (ESD) can damage your processor, disk drives, expansion boards, and other components. Always observe the following precautions before you install a system component.*

1. *Do not remove a component from its protective packaging until you are ready to install it.*
2. *Wear a wrist ground strap and attach it to a metal part of the system unit before handling a component. If a wrist strap is not available, maintain contact with the system unit throughout any procedure requiring ESD protection.*

Hardware Installation

2.1 Jumper and Connector Locations

The following figure shows the locations of the jumpers and connectors on the system board:

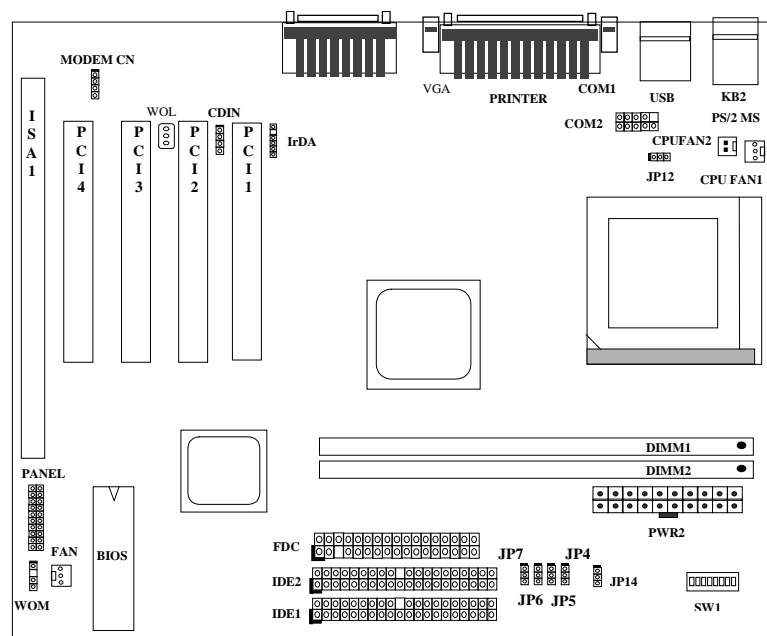

Hardware Installation

Jumpers:

SW1:	DIP Switch for CPU voltage and clock ratio
JP4, JP5, JP6, JP7	CPU external clock
JP12:	CPU I/O Voltage
JP14:	Clear CMOS

Connectors:

PS2:	PS/2 mouse connector
KB:	PS/2 keyboard connector
COM1:	COM1 connector
COM2:	COM2 connector
PRINTER:	Printer connector
PWR2:	ATX power connector
USB:	USB connector
FDC:	Floppy drive connector
IDE1:	IDE1 primary channel
IDE2:	IDE2 secondary channel
VGA:	VGA connector
CPUFAN1:	CPU fan connector
CDUFAN2:	CPU fan connector
FAN:	Fan connector
IrDA:	IrDA (Infrared) connector
PANEL:	Front panel (Multifunction) connector
CD-IN:	CD-audio connector
MODEM-CN:	Mono in (Pin 1-2) and Mic out (Pin 3-4)
WOM:	0V Wake On Modem connector
WOL:	Wake On LAN connector

Hardware Installation

2.2 Jumpers

Jumpers are made by pin headers and plastic connecting caps for the purpose of customizing your hardware. Doing so requires basic knowledge of computer hardware, be sure you understand the meaning of the jumpers before you change any setting. The onboard jumpers are normally set to their default with optimized settings.

On the mainboard, normally there is a bold line marked beside pin 1 of the jumper, sometimes, there are numbers also. If we connect (short) plastic cap to pin 1 and 2, we will say set it at 1-2, and when we say jumper is open, that means no plastic cap connected to jumper pins.



Open



Short



Jumper set at 1-2



Jumper set at 2-3

For your convenience to install a CPU, this motherboard also use a DIP switch to set CPU voltage and frequency ratio. The following figure simply shows you how to set this DIP switch, please see also to next sections for more details.

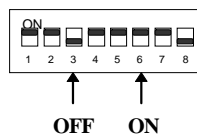

Hardware Installation

2.2.1 Setting the CPU Voltage

<u>S4</u>	<u>S5</u>	<u>S6</u>	<u>S7</u>	<u>S8</u>	<u>Vcore</u>
ON	ON	ON	ON	OFF	3.52V
OFF	ON	ON	ON	OFF	3.45V
OFF	OFF	ON	ON	OFF	3.2V
ON	OFF	OFF	ON	OFF	2.9V
OFF	OFF	OFF	ON	OFF	2.8V
OFF	OFF	ON	OFF	OFF	2.4V
ON	ON	OFF	OFF	OFF	2.3V
OFF	ON	OFF	OFF	OFF	2.2V

SW1 is used to select CPU core voltage (Vcore) and ratio, there are totally eight switches on the DIP. After installing CPU, remember to set the switch 4-8 to specify a proper Vcore.

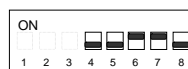
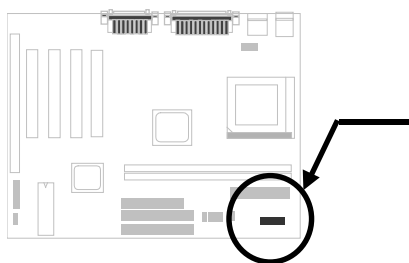

3.2V

K6-233

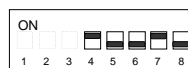

2.9V

K6-166/200 or M2

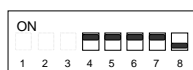

3.52V

6x86 or K5



2.8V

P55C (MMX)

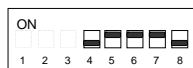

3.45V

P54C



2.4V

K6-2 400/450 and K6-III

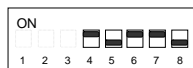

3.3V

IDT C6



2.2V

K6-266/300 or K6-2

Hardware Installation

The following table lists possible settings of current CPU available on the market. Note that the correct setting may vary because of new CPU product, please see to your CPU specification for more details.

CPU	Type	Vcore	S4	S5	S6	S7	S8
INTEL P54C	Single Voltage	3.45V	OFF	ON	ON	ON	OFF
INTEL P55C	Dual Voltage	2.8V	OFF	OFF	OFF	ON	OFF
AMD K5	Single Voltage	3.52V	ON	ON	ON	ON	OFF
AMD K6-166/200	Dual Voltage	2.9V	ON	OFF	OFF	ON	OFF
AMD K6-233	Dual Voltage	3.2V	OFF	OFF	ON	ON	OFF
AMD K6-266/300	Dual Voltage	2.2V	OFF	ON	OFF	OFF	OFF
AMD K6-2	Dual Voltage	2.2V	OFF	ON	OFF	OFF	OFF
AMD K6-2 400/450	Dual Voltage	2.4V	OFF	OFF	ON	OFF	OFF
AMD K6-III	Dual Voltage	2.4V	OFF	OFF	ON	OFF	OFF
Cyrix 6x86	Single Voltage	3.52V	ON	ON	ON	ON	OFF
Cyrix 6x86L	Dual Voltage	2.8V	OFF	OFF	OFF	ON	OFF
Cyrix M2	Dual Voltage	2.9V	ON	OFF	OFF	ON	OFF
IDT C6	Single Voltage	3.52V 3.3V	ON ON	ON OFF	ON ON	ON ON	OFF OFF



Warning: This high performance MX59 Pro motherboard that AOpen presented to you has a capability to overclock to 124MHz external clock while still conforming the design guide from VIA. This overclock scheme is accomplished by AOpen's technical expertise as well as manufacturing capabilities. However, please understand that some of the add-on cards might not work with this board properly when overclock scheme is engaged. Please use designated speed when you encountered such a problem.

Warning: Note that overclocking may cause thermal problem. Please make sure that the cooling fan and the heatsink were adequate to dissipate excessive heat that's generated by overclocking the CPU.



Tip: Normally, for single voltage CPU, Vcpuio (CPU I/O Voltage) is equal to Vcore, but for CPU that needs dual voltage such as PP/MT (P55C) or Cyrix 6x86L, Vcpuio is different from Vcore and must be set to Vio (PBSRAM and Chipset Voltage). The single or dual voltage CPU is automatically detected by hardware circuit.

Tip: For supporting more different CPUs in future, this motherboard uses five switches to specify Vcore. There are

Hardware Installation

32 settings totally, and the range is from 1.3V to 3.5V.

This motherboard supports the CPU core voltage from 1.3V to 3.5V, that can be applied to various CPUs in the future. For your reference, all settings are listed in the following table.

Vcore	S4	S5	S6	S7	S8
1.30V	OFF	OFF	OFF	OFF	ON
1.35V	ON	OFF	OFF	OFF	ON
1.40V	OFF	ON	OFF	OFF	ON
1.45V	ON	ON	OFF	OFF	ON
1.50V	OFF	OFF	ON	OFF	ON
1.55V	ON	OFF	ON	OFF	ON
1.60V	OFF	ON	ON	OFF	ON
1.65V	ON	ON	ON	OFF	ON
1.70V	OFF	OFF	OFF	ON	ON
1.75V	ON	OFF	OFF	ON	ON
1.80V	OFF	ON	OFF	ON	ON
1.85V	ON	ON	OFF	ON	ON
1.90V	OFF	OFF	ON	ON	ON
1.95V	ON	OFF	ON	ON	ON
2.00V	OFF	ON	ON	ON	ON
2.05V	ON	ON	ON	ON	ON
2.1V	ON	OFF	OFF	OFF	OFF
2.2V	OFF	ON	OFF	OFF	OFF
2.3V	ON	ON	OFF	OFF	OFF
2.4V	OFF	OFF	ON	OFF	OFF
2.5V	ON	OFF	ON	OFF	OFF
2.6V	OFF	ON	ON	OFF	OFF
2.7V	ON	ON	ON	OFF	OFF
2.8V	OFF	OFF	OFF	ON	OFF
2.9V	ON	OFF	OFF	ON	OFF
3.0V	OFF	ON	OFF	ON	OFF
3.1V	ON	ON	OFF	ON	OFF
3.2V	OFF	OFF	ON	ON	OFF
3.3V	ON	OFF	ON	ON	OFF
3.4V	OFF	ON	ON	ON	OFF
3.5V	ON	ON	ON	ON	OFF

Hardware Installation

2.2.2 Selecting the CPU Frequency

S1	S2	S3	CPU Frequency Ratio
OFF	OFF	OFF	1.5x (3.5x)
ON	OFF	OFF	2x (6x, 3.33x)
ON	ON	OFF	2.5x (1.75x)
OFF	ON	OFF	3x
ON	OFF	ON	4x
ON	ON	ON	4.5x
OFF	ON	ON	5x (2.33x)
OFF	OFF	ON	5.5x (2.66x)

Intel Pentium, Cyrix 6x86 and AMD K5/K6 CPU are designed to have different Internal (Core) and External (Bus) frequency. The ratio of Core/Bus frequency is selected by the switch 1-3 of SW1.



Note: Intel PP/MT MMX 233MHz is using 1.5x jumper setting for 3.5x frequency ratio, and AMD PR166 is using 2.5x setting for 1.75x frequency ratio.

Core frequency = Ratio * External bus clock

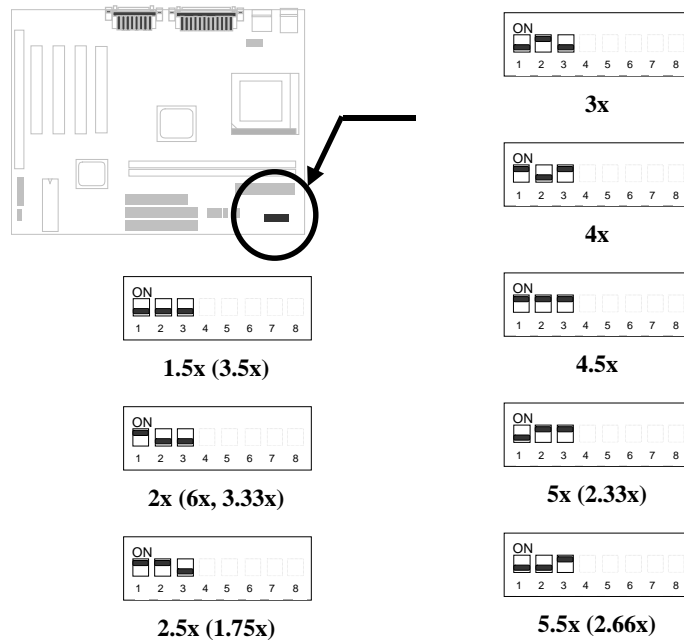

Hardware Installation

JP4	JP5	JP6	JP7	CPU	PCI
2-3	2-3	2-3	1-2	60MHz	30MHz
1-2	2-3	2-3	1-2	66.8MHz	33.4MHz
2-3	1-2	2-3	1-2	70MHz	35MHz
1-2	1-2	2-3	1-2	75MHz	25MHz
2-3	2-3	2-3	2-3	75MHz	37.5MHz
2-3	2-3	1-2	1-2	80MHz	28.7MHz
1-2	2-3	2-3	2-3	80MHz	40MHz
1-2	2-3	1-2	1-2	83.3MHz	27.7MHz
2-3	1-2	2-3	2-3	83.3MHz	41.7MHz
2-3	1-2	1-2	1-2	95.3MHz	31.6MHz
1-2	1-2	1-2	1-2	100MHz	33.3MHz
1-2	1-2	2-3	2-3	105MHz	35MHz
2-3	2-3	1-2	2-3	110MHz	36.7MHz
1-2	2-3	1-2	2-3	115MHz	38.3MHz
2-3	1-2	1-2	2-3	120MHz	40MHz
1-2	1-2	1-2	2-3	124MHz	41.3MHz

JP4, JP5 and JP6 are the selections of CPU external clock (bus clock), which is actually the clock from clock generator.

JP4, JP5, JP6 and JP7 are the selections of CPU external clock (bus clock) and PCI Clock.

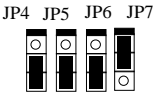
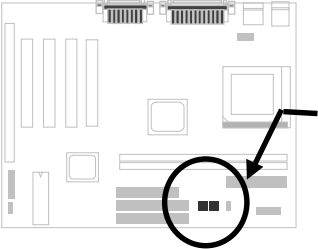

CPU:60MHz;
PCI:30MHz

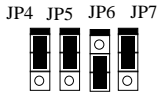

CPU:75MHz;
PCI:25MHz

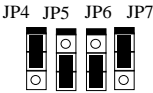

CPU:66.8MHz;
PCI:33.4MHz

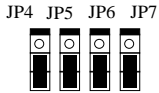

CPU:75MHz;
PCI:37.5MHz

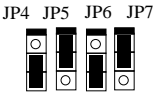

CPU:70MHz;
PCI:35MHz

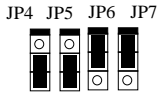

CPU:80MHz;
PCI:28.5MHz

Hardware Installation

JP4 JP5 JP6 JP7

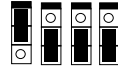

CPU:80MHz;
PCI:40MHz

JP4 JP5 JP6 JP7

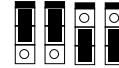

CPU:105MHz;
PCI:35MHz

JP4 JP5 JP6 JP7

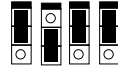

CPU:83.3MHz;
PCI:27.7MHz

JP4 JP5 JP6 JP7

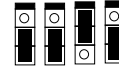

CPU:110MHz;
PCI:36.7MHz

JP4 JP5 JP6 JP7

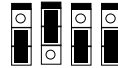

CPU:83.3MHz;
PCI:41.7MHz

JP4 JP5 JP6 JP7

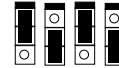

CPU:115MHz;
PCI:38.3MHz

JP4 JP5 JP6 JP7

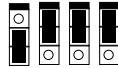

CPU:95.3MHz;
PCI:31.6MHz

JP4 JP5 JP6 JP7

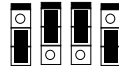

CPU:120MHz;
PCI:40MHz

JP4 JP5 JP6 JP7

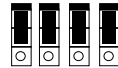

CPU:100MHz;
PCI:33.3MHz

JP4 JP5 JP6 JP7

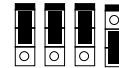

CPU:124MHz;
PCI:41.3MHz



Warning: VIA MVP4 chipset supports maximum 100MHz external CPU bus clock, the higher settings are for internal test only, **selecting these settings exceeds the specification of MVP4 chipset, which may cause serious system damage.**

Warning: While 100/105/110/112/115/120/124MHz is selected, we strongly recommend choosing PC100 SDRAM for system stability.

Hardware Installation



Caution: The following table lists possible settings of current CPU available on the market. The correct setting may vary because of new CPU product, refer to your CPU specification for more details.

INTEL Pentium	CPU Core Frequency	Ratio	External Bus Clock	S1	S2	S3	JP4,JP5,JP6,JP7
P54C 100	100MHz =	1.5x	66MHz	OFF	OFF	OFF	1-2 & 2-3 & 2-3 & 1-2
P54C 133	133MHz =	2x	66MHz	ON	OFF	OFF	1-2 & 2-3 & 2-3 & 1-2
P54C 166	166MHz =	2.5x	66MHz	ON	ON	OFF	1-2 & 2-3 & 2-3 & 1-2
P54C 200	200MHz =	3x	66MHz	OFF	ON	OFF	1-2 & 2-3 & 2-3 & 1-2

INTEL Pentium MMX	CPU Core Frequency	Ratio	External Bus Clock	S1	S2	S3	JP4,JP5,JP6,JP7
PP/MT 166	166MHz =	2.5x	66MHz	ON	ON	OFF	1-2 & 2-3 & 2-3 & 1-2
PP/MT 200	200MHz =	3x	66MHz	OFF	ON	OFF	1-2 & 2-3 & 2-3 & 1-2
PP/MT 233	233MHz =	3.5x	66MHz	OFF	OFF	OFF	1-2 & 2-3 & 2-3 & 1-2

Cyrix 6x86 & 6x86L	CPU Core Frequency	Ratio	External Bus Clock	S1	S2	S3	JP4,JP5,JP6,JP7
P166+	133MHz =	2x	66MHz	ON	OFF	OFF	1-2 & 2-3 & 2-3 & 1-2
P200+	150MHz =	2x	75MHz	ON	OFF	OFF	1-2 & 1-2 & 2-3 & 1-2

Cyrix M2	CPU Core Frequency	Ratio	External Bus Clock	S1	S2	S3	JP4,JP5,JP6,JP7
MX-PR200	166MHz =	2.5x	66MHz	ON	ON	OFF	1-2 & 2-3 & 2-3 & 1-2
	150MHz =	2x	75MHz	ON	OFF	OFF	1-2 & 1-2 & 2-3 & 1-2
MX-PR233	200MHz =	3x	66MHz	OFF	ON	OFF	1-2 & 2-3 & 2-3 & 1-2
	166MHz =	2x	83.3MHz	ON	OFF	OFF	1-2 & 2-3 & 1-2 & 1-2
MX-PR266	233MHz =	3.5x	66MHz	OFF	OFF	OFF	1-2 & 2-3 & 2-3 & 1-2
MX-PR300	225MHz =	3x	75MHz	OFF	ON	OFF	1-2 & 1-2 & 2-3 & 1-2
	233MHz =	3.5x	66MHz	OFF	OFF	OFF	1-2 & 2-3 & 2-3 & 1-2

IDT C6	CPU Core Frequency	Ratio	External Bus Clock	S1	S2	S3	JP4,JP5,JP6,JP7
C6-150	150MHz =	2x	75MHz	ON	OFF	OFF	1-2 & 1-2 & 2-3 & 1-2
C6-200	200MHz =	3x	66MHz	OFF	ON	OFF	1-2 & 2-3 & 2-3 & 1-2

AMD K5	CPU Core	Ratio	External	S1	S2	S3	JP4,JP5,JP6,JP7
--------	----------	-------	----------	----	----	----	-----------------

Hardware Installation

	Frequency		Bus Clock				
PR100	100MHz =	1.5x	66MHz	OFF	OFF	OFF	1-2 & 2-3 & 2-3 & 1-2
PR133	100MHz =	1.5x	66MHz	OFF	OFF	OFF	1-2 & 2-3 & 2-3 & 1-2
PR166	116MHz =	1.75x	66MHz	ON	ON	OFF	1-2 & 2-3 & 2-3 & 1-2

AMD K6	CPU Core Frequency	Ratio	External Bus Clock	S1	S2	S3	JP4,JP5,JP6,JP7
K6-166	166MHz =	2.5x	66MHz	ON	ON	OFF	1-2 & 2-3 & 2-3 & 1-2
K6-200	200MHz =	3x	66MHz	OFF	ON	OFF	1-2 & 2-3 & 2-3 & 1-2
K6-233	233MHz =	3.5x	66MHz	OFF	OFF	OFF	1-2 & 2-3 & 2-3 & 1-2
K6-266	266MHz=	4x	66MHz	ON	OFF	ON	1-2 & 2-3 & 2-3 & 1-2
K6-300	300MHz=	4.5x	66MHz	ON	ON	ON	1-2 & 2-3 & 2-3 & 1-2

AMD K6-2	CPU Core Frequency	Ratio	External Bus Clock	S1	S2	S3	JP4,JP5,JP6,JP7
K6-2 300	300MHz	3x	100MHz	OFF	ON	OFF	1-2 & 1-2 & 1-2 & 1-2
K6-2 333	333MHz	3.5x	95MHz	OFF	OFF	OFF	2-3 & 1-2 & 1-2 & 1-2
K6-2 350	350MHz	3.5x	100MHz	OFF	OFF	OFF	1-2 & 1-2 & 1-2 & 1-2
K6-2 366	366MHz	5.5x	66MHz	OFF	OFF	ON	1-2 & 2-3 & 2-3 & 1-2
K6-2 380	380MHz	4x	95MHz	ON	OFF	ON	2-3 & 1-2 & 1-2 & 1-2
K6-2 400	400MHz	4x	100MHz	ON	OFF	ON	1-2 & 1-2 & 1-2 & 1-2
K6-2 450	450MHz	4.5x	100MHz	ON	ON	ON	1-2 & 1-2 & 1-2 & 1-2
K6-2 475	475MHz	5x	95MHz	OFF	ON	ON	2-3 & 1-2 & 1-2 & 1-2
K6-III 400	400MHz	4x	100MHz	ON	OFF	ON	1-2 & 1-2 & 1-2 & 1-2
K6-III 450	450MHz	4.5	100MHz	ON	ON	ON	1-2 & 1-2 & 1-2 & 1-2



Note: Cyrix 6x86, 6x86MX (M2) and AMD K5 CPU use P-rating for the reference of CPU benchmark compared with INTEL P54C, their internal core frequency is not exactly equal to P-rating marked on the CPU. For example, Cyrix P166+ is 133MHz but performance is almost equal to P54C 166MHz and AMD PR133 is 100MHz but performance is almost equal to INTEL P54C 133MHz.

Hardware Installation

2.2.3 Clearing the CMOS

JP14	Clear CMOS
1-2	Normal operation (default)
2-3	Clear CMOS

You need to clear CMOS if you forget your system password. To clear the CMOS, follow the procedures listed below:

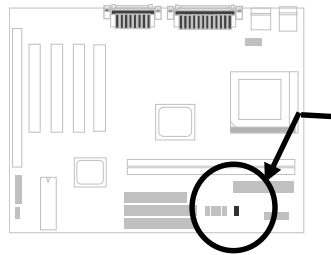

JP14



Normal Operation
(default)

JP14



Clear CMOS

The procedure to clear CMOS:

1. Turn off the system and unplug the AC power.
2. Remove ATX power cable from connector PWR2.
3. Locate **JP14** and short pins 2-3 for a few seconds.
4. Return **JP14** to its normal setting by shorting pins 1-2.
5. Connect ATX power cable back to connector PWR2.
6. Turn on the system power.
7. Press **DEL** during bootup to enter the BIOS Setup Utility and specify a new password, if needed.

Hardware Installation

2.2.4 I/O Voltage

JP12	I/O Voltage
1-2	3.32V
2-3	3.45V

JP12 is reserved for testing purposes only. This jumper enables you to set the voltage of the onboard chipset and PBRAM (Vio). For dual-voltage CPU, JP12 also functions as CPU I/O voltage (Vcpuio) controller.

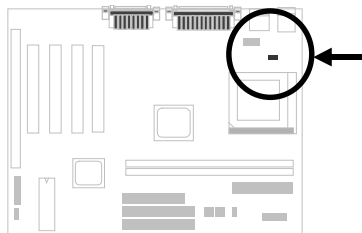

JP12



3.32V

JP12



3.45 V

Hardware Installation

2.3 Connectors

2.3.1 Power Cable

The ATX power supply uses 20-pin connector shown below. Make sure you plug in the right direction.



Caution: Make sure that the power supply is off before connecting or disconnecting the power cable.

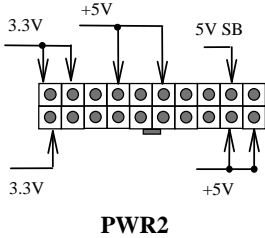
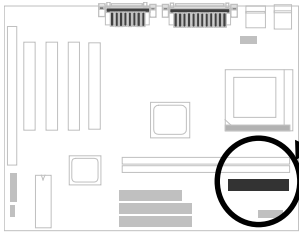

2.3.2 Fan Connectors

The CPU fan connectors are marked as **CPUFAN1** and **CPUFAN2** on the system board. You can plug the CPU fan cable to both the 2-pin fan connector CPUFAN2 and the 3-pin fan connector CPUFAN1. And **FAN** connector can be used to connect housing fan. Note that only CPUFAN1 and FAN support the fan monitoring function, because 3-pin fan has an extra pin called SENSE, which periodically sends fan signal out.

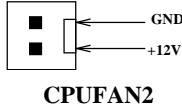
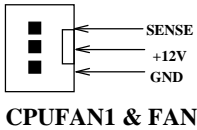
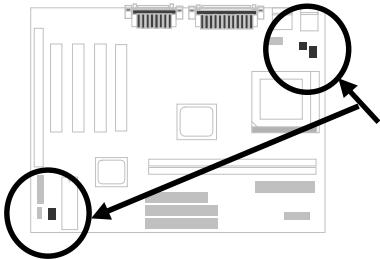

Hardware Installation

2.3.3 PS/2 Mouse

The onboard PS/2 mouse connector is a 6-pin Mini-Din connector marked **PS2**. The view angle of drawing shown here is from back panel of the housing.

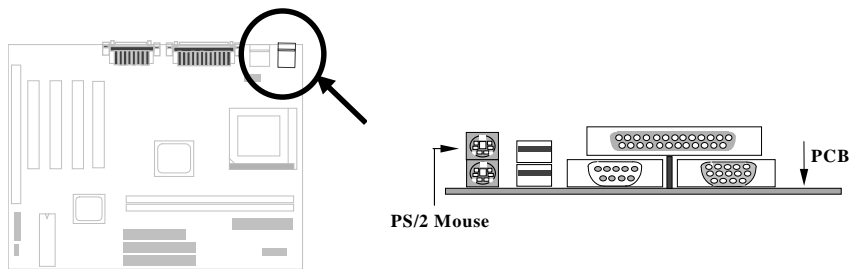

2.3.4 Keyboard

The onboard PS/2 keyboard connector is a 6-pin Mini-Din connector marked **KB2**. The view angle of drawing shown here is from back panel of the housing.

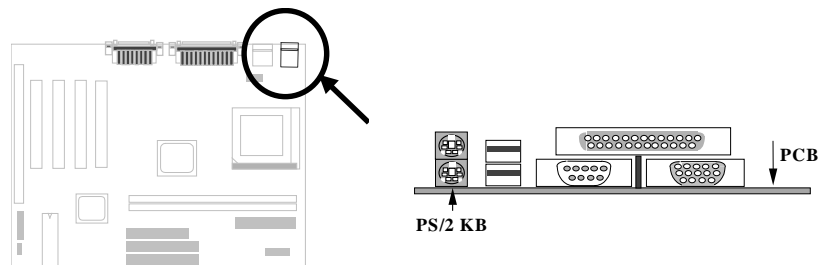

Hardware Installation

2.3.5 VGA (AGP)

2.3.5 Serial Devices (COM1)

The onboard serial connector **COM1** is a 9-pin D-type connector on the back panel of the mainboard.

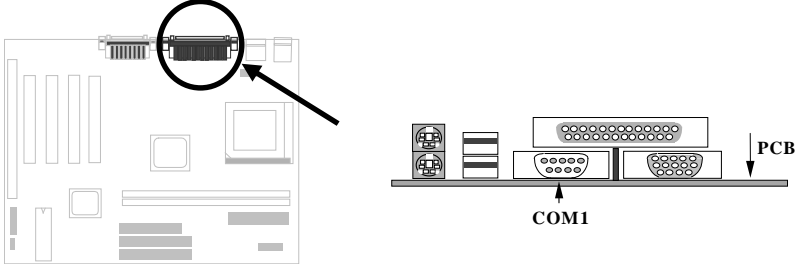

2.3.6 Serial Devices (COM2)

Plug in the 10-pin flat cable to the **COM2** connectors.

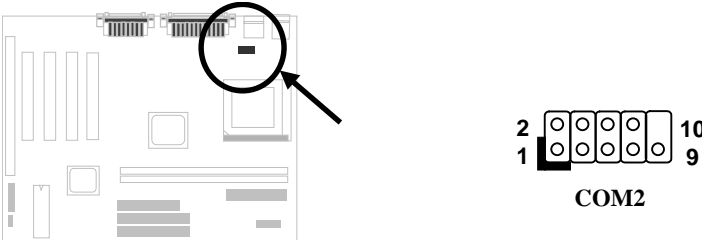

2.3.7 Printer

The onboard printer connector is a 25-pin D-type connector marked **PRINTER**. The view angle of drawing shown here is from back panel of the housing.

Hardware Installation

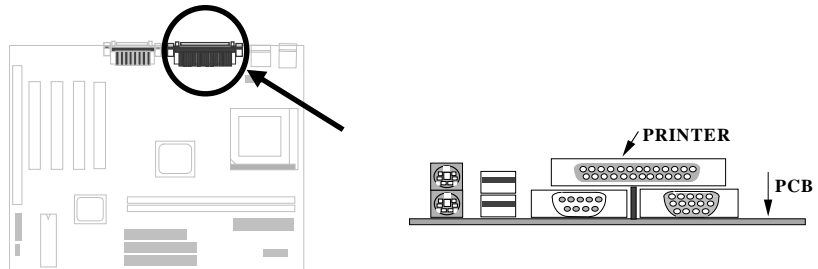

2.3.8 USB Device

You can attach USB devices to the USB connector. The motherboard contains two USB connectors, which are marked as **USB**.

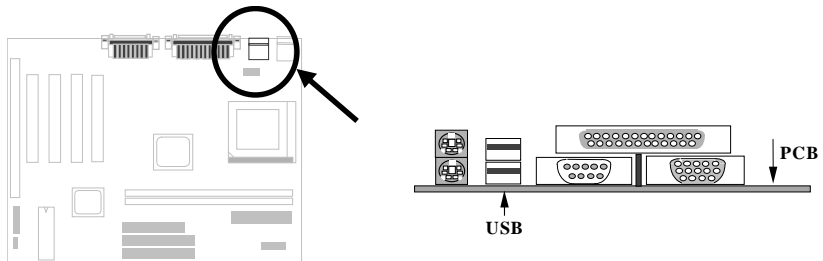

2.3.9 Floppy Drive

Connect the 34-pin floppy drive cable to the floppy drive connector marked as **FDC** on the system board.

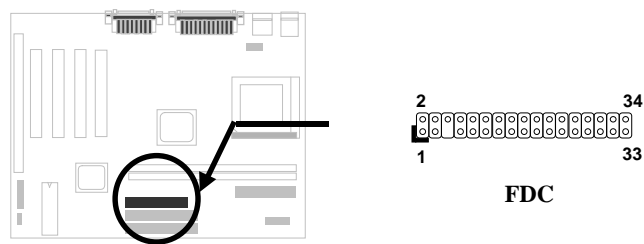

Hardware Installation

2.3.10 IDE Hard Disk and CD ROM

This mainboard supports two 40 pin IDE connectors marked as **IDE1** and **IDE2**. IDE1 is also known as primary channel and IDE2 as secondary channel, each channel supports two IDE devices that makes total of four devices.

In order to work together, the two devices on each channel must be set differently to master and slave mode, either one can be hard disk or CDROM. The setting as master or slave mode depends on the jumper on your IDE device, please refer to your hard disk and CDROM manual accordingly.

Connect your first IDE hard disk to master mode of the primary channel. If you have second IDE device to install in your system, connect it as slave mode on the same channel, and the third and fourth device can be connected on secondary channel as master and slave mode respectively.

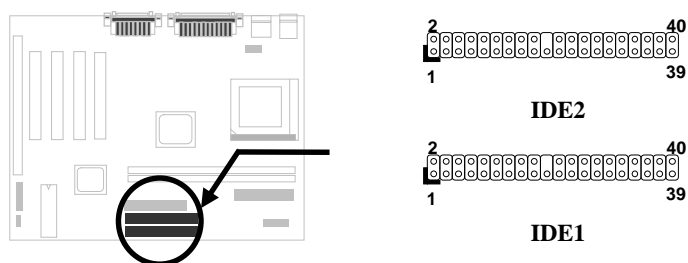

Caution: The specification of IDE cable is maximum 46cm (18 inches), make sure your cable does not exceed this length.

Caution: For better signal quality, it is recommended to set far end side device to master mode and follow the suggested sequence to install your new device. Please refer to the following figure.

Hardware Installation

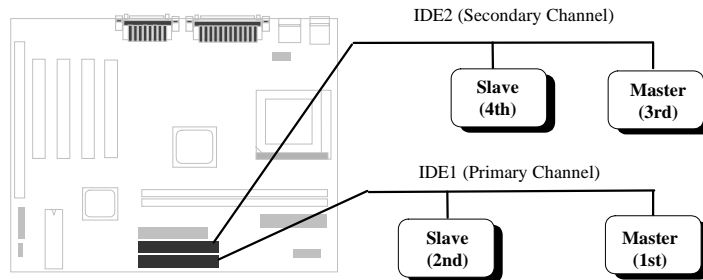

2.3.11 Panel Connector

The Panel (multifunction) connector is a 20-pin connector marked as **PANEL** on the board. Attach the power LED, keylock, speaker, SPWR, IDE LED and reset switch to the corresponding pins as shown in the figure.

If your ATX housing supports ACPI specification, the ACPI & Power the LED will keep flashing if you have enabled "suspend mode" item in the BIOS Setup.

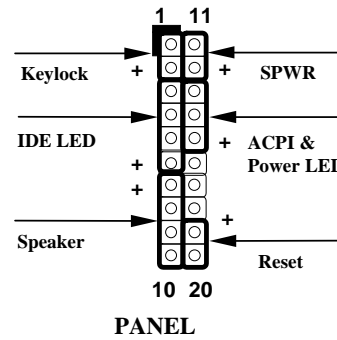
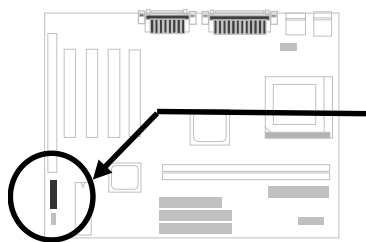
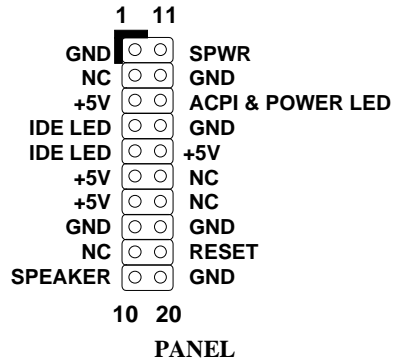

Hardware Installation

2.3.12 IrDA Connector

The IrDA connector can be configured to support wireless infrared module, with this module and application software such as Laplink or Win95 Direct Cable Connection, user can transfer files to or from laptops, notebooks, PDA and printers. This connector supports HPSIR (115.2Kbps, 2 meters), ASK-IR (56Kbps) and Fast IR (4Mbps, 2 meters).

Install infrared module onto IrDA connector and enable infrared function from BIOS setup, make sure to have correct orientation when you plug onto IrDA connector.

Pin	Description
1	+5V
2	NC
3	IRRX
4	GND
5	IRTX
6	NC

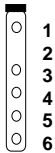
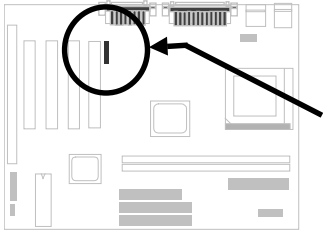

IrDA

2.3.13 CD Audio Connector

This connector is used to connect CD audio cable.

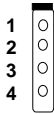
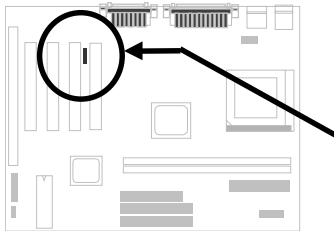

CDIN

Hardware Installation

2.3.14 Mono In/Mic Out Connector

This connector is used to connect Mono In/Mic Out connector of an internal modem card. The pin 1-2 is **Mono In**, and the pin 3-4 is **Mic Out**. Please note that there is no standard for this kind of connector yet, only some internal modem cards implement this connector.

Please see the pin definitions to connect the cable.

<u>Pin</u>	<u>Description</u>
1	Mono In
2	GND
3	GND
4	Mic Out



2.3.15 Wake on Modem Connector

This mainboard implements special circuit to support Wake on Modem, both Internal Modem Card (AOpen MP56) and external box Modem are supported. Since Internal Modem card consumes no power when system power is off, it is recommended to use Internal Modem. To use AOpen MP56, connect 4-pin cable from **RING** connector of MP56 to **WOM** connector on the mainboard.

<u>Pin</u>	<u>Description</u>
1	+5V SB
2	NC
3	RING
4	GND

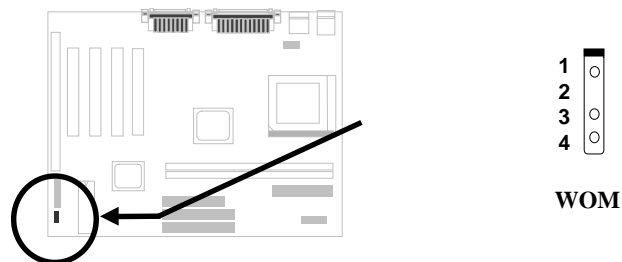

Hardware Installation

2.3.16 Wake on LAN Connector

This mainboard implements a **WOL** connector. To implement Wake on LAN, you need a network card that supports this feature. In addition, you also need to install a network management software.

<u>Pin</u>	<u>Description</u>
1	+5V SB
2	GND
3	LID

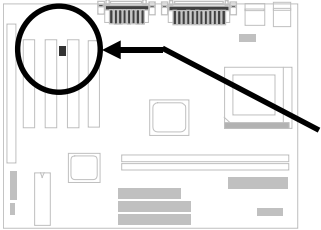

WOL

Hardware Installation

2.4 Configuring the System Memory

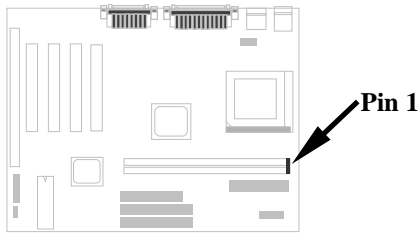

This mainboard has two 168 pin DIMM sockets (Dual-in-line Memory Module) that allow you to install system memory up to **512MB**.

The DIMM supported by this motherboard are always 64-bit wide SDRAM, which can be identified by the following factors:

- I. **Size:** single side, 1Mx64 (8MB), 2Mx64 (16MB), 4Mx64 (32MB), 8Mx64 (64MB), 16Mx64 (128MB), and double side, 1Mx64x2 (16MB), 2Mx64x2 (32MB), 4Mx64x2 (64MB), 8Mx64x2 (128MB).



Tip: Here is a trick to check if your DIMM is single-side or double-side -- if there are traces connected to golden finger pin 114 and pin 129 of the DIMM, the DIMM is probably double-side; otherwise, it is single-side. The following figure is for your reference.

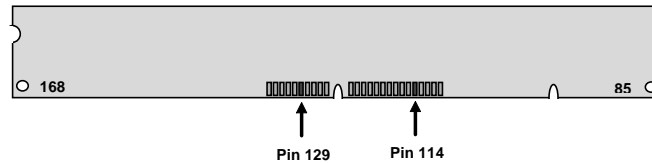

- II. **Speed:** Normally marked as -12, which means the clock cycle time is 12ns and maximum clock of this SDRAM is 83MHz. Sometimes you can also find the SDRAM marked as -67, which means maximum clock is 67MHz.
- III. **Buffered and non-buffered:** This motherboard supports non-buffered DIMMs. You can identify non-buffered DIMMs and buffered DIMMs according to the position of the notch, the following figure is for your reference:

Hardware Installation

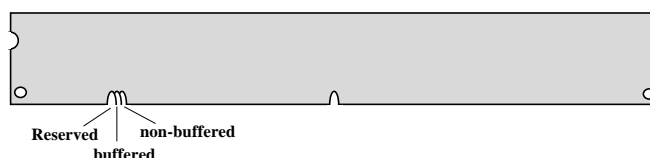

Because the positions are different, only non-buffered DIMMs can be inserted into the DIMM sockets on this motherboard. Although most of DIMMs on current market are non-buffered, we still suggest you to ask your dealer for the correct type.

- IV. 2-clock and 4-clock signals:** Although both of 2-clock and 4-clock signals are supported by this motherboard, we strongly recommend choosing a 4-clock SDRAM in consideration of reliability.



Tip: To identify 2-clock and 4-clock SDRAM, you may check if there are traces connected to golden finger pin 79 and pin 163 of the SDRAM. If there are traces, the SDRAM is probably 4-clock; Otherwise, it is 2-clock.

- V. Parity:** This motherboard supports standard 64 bit wide (without parity) and 72-bit wide (with parity) DIMM modules.

There is no jumper setting required for the memory size or type. It is automatically detected by the system BIOS. This motherboard supports maximum **512MB** system memory.

DIMM1	Size of DIMM1
None	0MB
8MB	8MB
16MB	16MB
32MB	32MB
64MB	64MB
128MB	128MB

DIMM2	Size of DIMM2
None	0MB
8MB	8MB
16MB	16MB
32MB	32MB
64MB	64MB
128MB	128MB

Total Memory Size = Size of DIMM1 + Size of DIMM2



Caution: There are some old DIMMs made by EDO or FPM memory chip, they can only accept 5V power and probably can not fit into the DIMM socket, make sure you have 3.3V true SDRAM DIMM before your insert it.

Hardware Installation

The driving capability of new generation chipset is limited because the lack of memory buffer (to improve performance). This makes DRAM chip count an important factor to be taking into consideration when you install SIMM. Unfortunately, there is no way that BIOS can identified the correct chip count, you need to calculate the chip count by yourself. The simple rule is: By visual inspection, use only SIMM with chip count less than 24 chips.

There is an important parameter affects SDRAM performance, CAS Latency Time. It is similar as CAS Access Time of EDO DRAM and is calculated as number of clock state. The SDRAM that AOpen had tested are listed below. If your SDRAM has unstable problem, go into BIOS "Chipset Features Setup", change CAS Latency Time to 3 clocks.

Manufacturer	Model	Suggested CAS Latency Time	5V Tolerance
Samsung	KM416511220AT-G12	2	Yes
NEC	D4S16162G5-A12-7JF	2	No
Hitachi	HMS5216805TT10	2	No
Fujitsu	81117822A-100FN	2	No
TI	TMX626812DGE-12	2	Yes
TI	TMS626812DGE-15	3	Yes
TI	TMS626162DGE-15	3	Yes
TI	TMS626162DGE-M67	3	Yes

Hardware Installation

The following table lists the recommended DRAM combinations:

DIMM Data chip	Bit size per side	Single/Double side	Chip count	DIMM size	Recommended
1M by 16	1Mx64	x1	4	8MB	Yes
1M by 16	1Mx64	x2	8	16MB	Yes
2M by 8	2Mx64	x1	8	16MB	Yes
2M by 8	2Mx64	x2	16	32MB	Yes
4M by 16	4Mx64	x2	8	64MB	Yes
4M by 16	4Mx64	x1	4	32MB	Yes
8M by 8	8Mx64	x1	8	64MB	Yes
8M by 8	8Mx64	x2	16	128MB	Yes

DIMM Data chip	Bit size per side	Single/Double side	Chip count	DIMM size	Recommended
2M by 32	2Mx64	x1	2	16MB	Yes, but not tested.
2M by 32	2Mx64	x2	4	32MB	Yes, but not tested.

The following table lists possible DRAM combinations that is **NOT** recommended:

DIMM Data chip	Bit size per side	Single/Double side	Chip count	DIMM size	Recommended
4M by 4	4Mx64	x1	16	32MB	No
4M by 4	4Mx64	x2	32	64MB	No
16M by 4	16Mx64	x1	16	128MB	No

Chapter 3

Software Installation

This chapter gives you a step-by-step procedure on how to install the driver and utility of this motherboard. Because chipset and technology improvement is faster than operating system, sometimes we need certain procedures to successfully install necessary software. Please follow each section accordingly.

Software Installation

3.1 Software Installation in Windows 95

For installing Windows 95, please make sure you have followed below procedures.

1. First, don't install any add-on card.
2. Install Window 95 into your system.
3. Install Windows 95 OSR2 v2.1, 1212 or 1214 version and later with USB support. Otherwise, you need to install USBSUPP.EXE.
4. Install the VIA 4 in 1 driver, which includes VIA Bus Master IDE Driver, AGP Vxd driver, IRQ routing driver, and VIA chipset function registry program.
5. Install the onchip AGP driver.
6. Install the onchip audio driver.
7. Finally, Install other add-on cards.

In the AOpen Bonus Pack CD disc, you can find above drivers in the path X:\Mx59pro\Driver (Where X: represents your CDROM drive).



Note: Make sure you have set the display mode to the default setting (640 x 480, 16 colors) prior to uninstalling the VIA 4 in 1 driver.

Note: Both VIA AGP driver and audio driver don't support Windows NT.

Software Installation

3.2 Software Installation in Windows 98

For installing Windows 98, please make sure you have followed below procedures.

1. First, don't install any add-on card.
2. Enable **USB Controller** in BIOS Setup menu to make BIOS fully capable of controlling IRQ assignment.
3. Install Window 98 into your system.
4. Install the VIA 4 in 1 driver, which includes VIA Bus Master IDE Driver, AGP Vxd driver, IRQ routing driver, and VIA chipset function registry program.
5. Install the onchip AGP driver.
6. Install the onchip audio driver.
7. Finally, Install other add-on cards.

In the AOpen Bonus Pack CD disc, you can find above drivers in the path X:\Mx59pro\Driver (Where X: represents your CDROM drive).



Note: Make sure you have set the display mode to the default setting (640 x 480, 16 colors) prior to uninstalling the VIA 4 in 1 driver.

Note: Both VIA AGP driver and audio driver don't support Windows NT.

Software Installation

3.3 Install Hardware Monitoring Utility

There are four high-valued Hardware Monitoring features being implemented on this motherboard.

1. **Over Current Protection:** Providing over current protection for CPU Vcore. In conjunction with the over current protection provided by ATX power supply on 3.3V/5V/12V, it gives the full line over current protection.
2. **System Voltage Monitoring:** As you turn your system on, this smart design will continue to monitor your system working voltage. If any of the system voltage is over the component's standard, there will be warning alarm from PC speaker when Hardware Monitoring Utility installed.
3. **Thermal Protection:** The higher speed of CPU, the more heat dissipation ability is needed to be taken into consideration. If the user does not use a correct fan for the CPU cooling, it is highly possible the CPU will be overheating and cause system unstable. AOpen motherboard monitors CPU temperature by using a thermal sensor.
4. **Fan Monitoring:** There are two three-pin fan connectors, one is for CPU and the other one can be connected to the housing fan. The system will report the rotational speed of the fan and alarm fan malfunction through Hardware Monitoring Utility.

The hardware monitoring function is automatically implemented by the BIOS and utility software (such as Hardware Monitoring Utility), no hardware installation is needed.

Hardware Monitoring Utility (the program's file name is like aohwxxx.exe, where xxx means the version number) is developed by AOpen which monitors the status of system voltage, thermal, & fan. This utility is especially designed for personal user. You may install it on your AOpen motherboard based system which comes with Hardware Monitoring features. To install Hardware Monitoring Utility, please follow the procedure below.

Choose "Hardware Monitoring Utility" from the autorun menu of AOpen Bonus Pack CD disc.

~ Or ~

Run \HwMon\95\aoHW140.exe

Software Installation

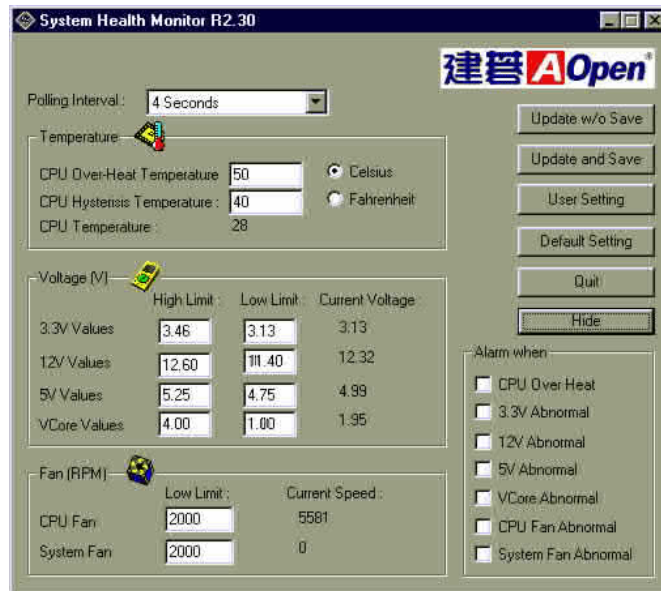

Software Installation

3.4 Install Norton AntiVirus

You can install this antivirus software from AOpen Bonus Pack CD disc, please follow the procedure below.

To install Norton Antivirus, please follow the procedure below.

To run AOchip, please follow the procedure below.

1. Choose "Norton Antivirus" from the autorun menu of AOpen Bonus Pack CD disc.
2. Choose one language version accordingly and click "OK" button.

~ Or ~

Brazilian version: Run \Nav\Brazilian\Setup.exe

Simple Chinese version: Run \Nav\China\Setup.exe

Traditional Chinese version: Run \Nav\Chinese\Setup.exe

Dutch version: Run \Nav\Dutch\Setup.exe

English version: Run \Nav\English\Setup.exe

French version: Run \Nav\French\Setup.exe

German version: Run \Nav\German\Setup.exe

Italian version: Run \Nav\Italian\Setup.exe

Japanese version: Run \Nav\Japanese\Setup.exe

Korean version: Run \Nav\Korean\Disk1\Setup.exe

Spanish version: Run \Nav\Spanish\Setup.exe

Software Installation

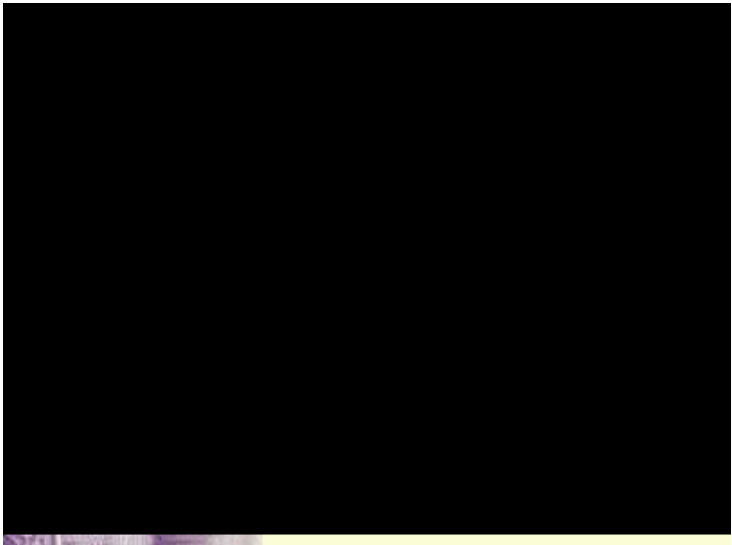

Software Installation

3.5 Install Docucom Reader

The AOpen Bonus Pack CD disc includes an online manual of this motherboard, which is PDF file format. You must use Docucom Reader to read these PDF files.

To install Docucom Reader, please follow the procedure below.

Choose "Docucom Reader" from the autorun menu of AOpen Bonus Pack CD disc.

~ Or ~

Run \Utility\Docucom\Setup\Setup.exe



Chapter 4

Award BIOS

This chapter tells how to configure the system parameters. You may update your BIOS via AWARD Flash Utility.



Important: Because the BIOS code is the most often changed part of the mainboard design, the BIOS information contained in this chapter (especially the Chipset Setup parameters) may be a little different compared to the actual BIOS that came with your mainboard.

AWARD BIOS

4.1 Entering the Award BIOS Setup Menu

The BIOS setup utility is a segment of codes/routines residing in the BIOS Flash ROM. This routine allows you to configure the system parameters and save the configuration into the 128 byte CMOS area, (normally in the RTC chip or directly in the main chipset). To enter the BIOS Setup, press **DEL** during POST (Power-On Self Test). The BIOS Setup Main Menu appears as follows.

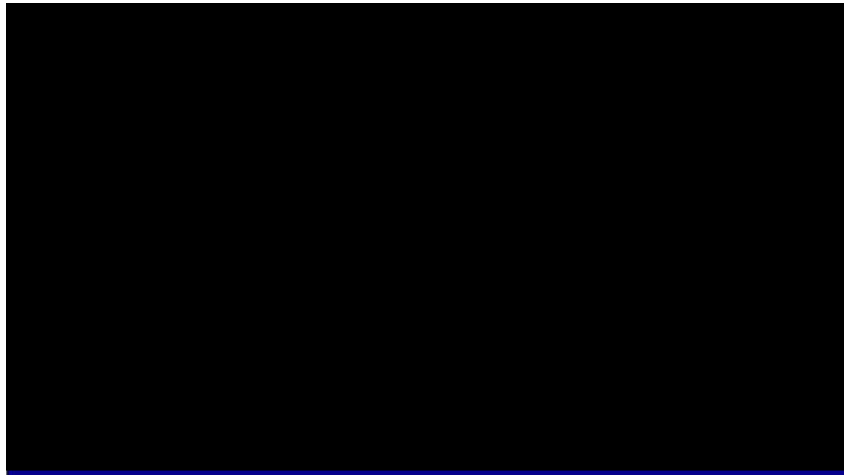



Tip: Choose "Load Setup Defaults" for recommended optimal performance. Choose "Load Turbo Defaults" for best performance with light system loading. Refer to section 3.7.

The section at the bottom of the screen tells how to control the screen. Use the arrow keys to move between items, F9 to change language, ESC to exit, and F10 to save the changes before exit. Another section at the bottom of the screen displays a brief description of the highlighted item.



After selecting an item, press Enter to select or enter a submenu.

4.2 Standard CMOS Setup

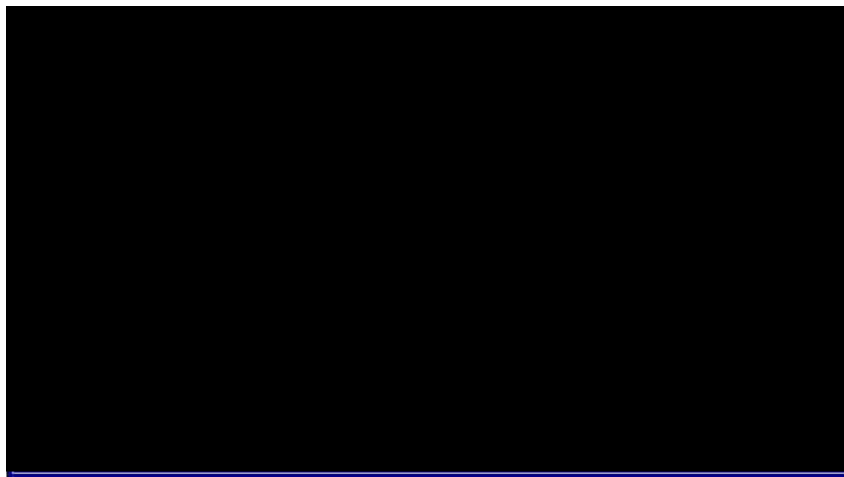

The "Standard CMOS Setup" sets the basic system parameters such as the date, time, and the hard disk type. Use the arrow keys to highlight an item and  or  to select the value for each item.



Standard CMOS à Date

To set the date, highlight the Date parameter. Press  or  to set the current date. The date format is month, date, and year.

Standard CMOS à Time

To set the time, highlight the Time parameter. Press  or  to set the current time in hour, minute, and second format. The time is based on the 24 hour military clock.

AWARD BIOS

Standard CMOS à Primary Master à Type
Standard CMOS à Primary Slave à Type
Standard CMOS à Secondary Master à Type
Standard CMOS à Secondary Slave à Type

Type
Auto
User
None

This item lets you select the IDE hard disk parameters that your system supports. These parameters are Size, Number of Cylinder, Number of Head, Start Cylinder for Pre-compensation, Cylinder number of Head Landing Zone and Number of Sector per Track. The default setting is **Auto**, which enables BIOS to automatically detect the parameters of installed HDD at POST (Power-On Self Test). If you prefer to enter HDD parameters manually, select **User**. Select **None** if no HDD is connected to the system.

The IDE CDROM is always automatically detected.



Tip: For an IDE hard disk, we recommend that you use the "IDE HDD Auto Detection" to enter the drive specifications automatically. See the section "IDE HDD Auto Detection".

Standard CMOS à Primary Master à Mode
Standard CMOS à Primary Slave à Mode
Standard CMOS à Secondary Master à Mode
Standard CMOS à Secondary Slave à Mode

Mode
Auto
Normal
LBA
Large

The enhanced IDE feature allows the system to use a hard disk with a capacity of more than 528MB. This is made possible through the Logical Block Address (LBA) mode translation. The LBA is now considered as a standard feature of current IDE hard disk on the market because of its capability to support capacity larger than 528MB. Note that if HDD is formatted with LBA On, it will not be able to boot with LBA Off.

AWARD BIOS

Standard CMOS à Drive A Standard CMOS à Drive B

Drive A

None
360KB 5.25"
1.2MB 5.25"
720KB 3.5"
1.44MB 3.5"
2.88MB 3.5"

These items select floppy drive type. The available settings and types supported by the mainboard are listed on the left.

Standard CMOS à Video

Video

EGA/VGA
CGA40
CGA80
Mono

This item specifies the type of video card in use. The default setting is VGA/EGA. Since current PCs use VGA only, this function is almost useless and may be disregarded in the future.

Standard CMOS à Halt On

Halt On

No Errors
All Errors
All, But Keyboard
All, But Diskette
All, But Disk/Key

This parameter enables you to control the system stops in case of Power-On Self Test (POST) error.

AWARD BIOS

4.3 BIOS Features Setup

This screen appears when you select the option "BIOS Features Setup" from the main menu.

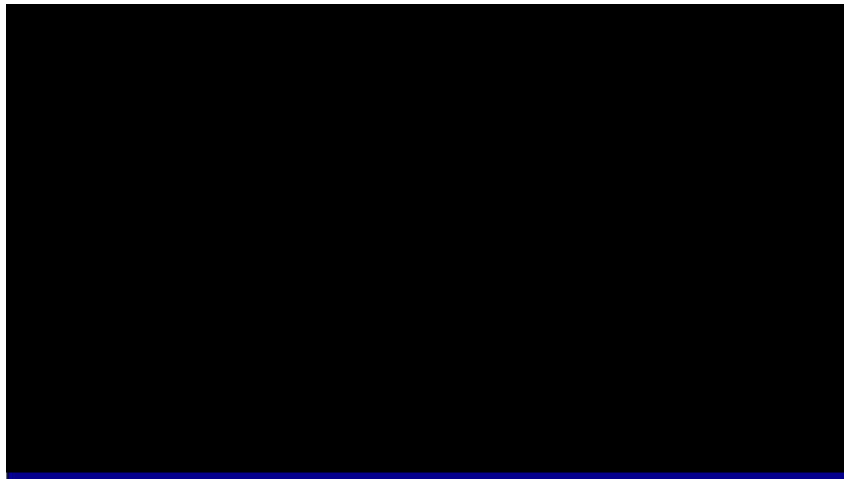

BIOS Features à Virus Warning

Virus Warning	Set this parameter to Enabled to activate the warning message. This feature protects the boot sector and partition table of your hard disk from virus intrusion. Any attempt during boot up to write to the boot sector of the hard disk drive stops the system and the following warning message appears on the screen. Run an anti-virus program to locate the problem.
Enabled	
Disabled	

<p style="text-align: center;">! WARNING ! Disk Boot Sector is to be modified Type "Y" to accept write, or "N" to abort write Award Software, Inc.</p>

AWARD BIOS

BIOS Features à CPU Internal Cache

External Cache Enabled Disabled	Enabling this parameter activates CPU internal cache. Disabling the parameter slows down the system. Therefore, we recommend that you leave it enabled unless you are troubleshooting a problem.
--	--

BIOS Features à External Cache

External Cache Enabled Disabled	Enabling this parameter activates the secondary cache (currently, PBRAM cache). Disabling the parameter slows down the system. Therefore, we recommend that you leave it enabled unless you are troubleshooting a problem.
--	--

BIOS Features à Quick Power On Self Test

Quick Power-on Self-test Enable Disabled	This parameter speeds up POST by skipping some items that are normally checked.
---	---

BIOS Features à Boot Sequence

Boot Sequence A,C,SCSI C,A,SCSI C,CDROM,A CDROM,C,A CDROM,A,C D,A,SCSI E,A,SCSI F,A,SCSI SCSI,A,C SCSI,C,A C only LS/ZIP,C	This parameter allows you to specify the system boot up search sequence. The hard disk ID are listed below: C: Primary master D: Primary slave E: Secondary master F: Secondary slave LS: LS120 drive ZIP: IOMEGA ZIP drive
---	---

AWARD BIOS

BIOS Features à Swap Floppy Drive

Swap Floppy Drive Enabled Disabled	This item allows you to swap floppy drives. For example, if you have two floppy drives (A and B), you can assign the first drive as drive B and the second drive as drive A or vice-versa.
---	--

BIOS Features à Boot Up NumLock Status

Boot up NumLock Status On Off	Setting this parameter to On enables the numeric function of the numeric keypad. Set this parameter to Off to disregard the function. Disabling the numeric function allows you to use the numeric keypad for cursor control.
--	---

BIOS Features à Memory Parity/ECC Check

Memory Parity/ECC Check Enabled Disabled	This item is used to enable or disable parity/ECC check function.
---	---

BIOS Features à Typematic Rate Setting

Typematic Rate Setting Enabled Disabled	Set this parameter to Enable/Disable the keyboard repeat function. When enabled, continually holding down a key on the keyboard will generate repeatedly keystrokes.
--	--

BIOS Features à Typematic Rate (Chars/Sec)

Typematic Rate 6 8 10 12 15 20 24 30	This item allows you to control the speed of repeated keystrokes. The default is 30 characters/sec.
---	---

AWARD BIOS

BIOS Features à Typematic Delay (Msec)

Typematic Delay
250
500
750
1000

This parameter allows you to control the delay time between the first and the second keystroke (where the repeated keystrokes begin). The typematic delay settings are 250, 500, 750, and 1000 msec.

BIOS Features à Security Option

Security Option
Setup
System

The **System** option limits access to both the System boot and BIOS setup. A prompt asking you to enter your password appears on the screen every time you boot the system.

The **Setup** option limits access only to BIOS setup.

To disable the security option, select Password Setting from the main menu, don't type anything and just press <Enter>.

BIOS Features à PCI/VGA Palette Snoop

PCI/VGA Palette Snoop
Enabled
Disabled

Enabling this item informs the PCI VGA card to keep silent (and to prevent conflict) when palette register is updated (i.e., accepts data without responding any communication signals). This is useful only when two display cards use the same palette address and plugged in the PCI bus at the same time (such as MPEQ or Video capture). In such case, PCI VGA is silent while MPEQ/Video capture is set to function normally.

BIOS Features à OS Select for DRAM > 64MB

OS Select for DRAM > 64MB
OS/2
Non-OS/2

Set to OS/2 if your system is utilizing an OS/2 operating system and has a memory size of more than 64 MB.

AWARD BIOS

BIOS Features à Show Logo On Screen

Show Logo On Screen

Enabled
Disabled

This item lets you decide if AOpen logo will appear in the POST screen.

BIOS Features à Video BIOS Shadow

Video BIOS Shadow

Enabled
Disabled

VGA BIOS Shadowing means to copy video display card BIOS into the DRAM area. This enhances system performance because DRAM access time is faster than ROM.

BIOS Features à C800-CBFF Shadow

BIOS Features à CC00-CFFF Shadow

BIOS Features à D000-D3FF Shadow

BIOS Features à D400-D7FF Shadow

BIOS Features à D800-DBFF Shadow

BIOS Features à DC00-DFFF Shadow

C8000-CBFFF Shadow

Enabled
Disabled

These six items are for shadowing ROM code on other expansion cards. Before you set these parameters, you need to know the specific addresses of that ROM code. If you do not know this information, enable all the ROM shadow settings.



Note: The F000 and E000 segments are always shadowed because BIOS code occupies these areas.

4.4 Chipset Features Setup

The "Chipset Features Setup" includes settings for the chipset dependent features. These features are related to system performance.

```
ROM PCI/ISA BIOS (00000010)
CHIPSET FEATURES SETUP
AWARD SOFTWARE, INC.

Bank 0/1 DRAM Timing : Normal
Bank 2/3 DRAM Timing : Normal
SDRAM CAS Latency   : 3
SDRAM Bank Interleave : Disabled
DRAM Read Pipeline  : Disabled
Cache R/CPU W Pipeline : Disabled
Video BIOS Cacheable : Disabled
System BIOS Cacheable : Disabled
Memory Hole         : Disabled
Init Display First  : AGP
Frame Buffer Size    : 8M
AGP Aperture Size   : 64M
Clock Spread Spectrum : Off
V2K CMOS Update     : Enabled

CPU to PCI Write Buffer : Enabled
PCI Dynamic Bursting   : Disabled
PCI Master 0 WS Write  : Enabled
PCI Delay Transaction  : Disabled
PCI#2 Access #1 Retry  : Disabled
AGP Master 1 WS Write  : Disabled
AGP Master 1 WS Read   : Disabled

ESC : Quit          ↑↓←→ : Select Item
F1  : Help          PU/PD/+/ - : Modify
F5  : Old Values    F9   : Language
F6  : Load Setup Defaults
F7  : Load Turbo Defaults
```



Caution: Make sure you fully understand the items contained in this menu before you try to change anything. You may change the parameter settings to improve system performance. However, it may cause system unstable if the settings are not correct for your system configuration.

AWARD BIOS

Chipset Features à Bank 0/1 Timing Chipset Features à Bank 2/3 Timing

<u>DRAM Timing</u> 60 ns 70 ns

This item is used to set DRAM timing parameters which can be automatically set by BIOS, 60ns and 70ns.

Chipset Features à SDRAM CAS Latency

<u>SDRAM CAS Latency</u> 2T 3T

This is an important parameter that affects SDRAM performance, the default setting is 2 clocks. If your system has unstable problem, change 2T to 3T.

Chipset Features à SDRAM Bank Interleave

<u>SDRAM Bank Interleave</u> Enabled Disabled
--

This item allows pages of different banks to be active.

Chipset Features à DRAM Read Pipeline

<u>DRAM Read Pipeline</u> Enabled Disabled

This item is used to enable or disable DRAM read pipeline.

Chipset Features à Cache R/W CPU Pipeline

<u>Cache R/W CPU Pipeline</u> Enabled Disabled

This item is used to enable or disable both cache read and CPU write pipeline.

Chipset Features à Video BIOS Cacheable

<u>Video BIOS Cacheable</u> Enabled Disabled

Allows the video BIOS to be cached to allow faster video performance.

AWARD BIOS

Chipset Features à System BIOS Cacheable

**System BIOS
Cacheable**

Enabled
Disabled

Enabling this item allows you to cache the system BIOS to further enhance system performance.

Chipset Features à Memory Hole

Memory Hole

Enabled
Disabled

This option lets you reserve system memory area for special ISA cards. The chipset accesses code/data of these areas from the ISA bus directly. Normally, these areas are reserved for memory mapped I/O card.

Chipset Features à Init Display First

Init Display First

PCI
AGP

If you installed a PCI VGA card and an AGP card at the same time, this item lets you decide which one is the initial display card.

Chipset Features à Frame Buffer Size

Frame Buffer Size

2M
4M
8M

The onboard AGP need to share a memory size with the system memory. You may set a larger size for getting better performance. The shared memory size is up to 8MB.

Chipset Features à AGP Aperture Size

AGP Aperture Size

4M
8M
16M
32M
64M
128M
256M

This item lets you determine the effective size of the AGP Graphic Aperture.

AWARD BIOS

Chipset Features à Clock Spread Spectrum

<u>Clock Spread Spectrum</u> On Off	This item is used to set clock spread spectrum for EMI testing. Normally, you don't need to change the default setting.
--	---

Chipset Features à Y2K CMOS Update

<u>Y2K CMOS Update</u> Enabled Disabled	This item is designed for some Y2K testing programs, for example, Check It 98. If you are using this kind of program to test your system and fails, enable this item and redo the test again.
--	---

PNP/PCI Configuration à CPU to PCI Write Buffer

<u>CPU to PCI Write Buffer</u> Disabled Enabled	This item is used to enable or disable CPU to PCI write buffer.
--	---

PNP/PCI Configuration à PCI Dynamic Bursting

<u>PCI Dynamic Bursting</u> Disabled Enabled	This item is used to enable or disable PCI dynamic bursting.
---	--

PNP/PCI Configuration à PCI Master 0 WS Write

<u>PCI Master 0 WS Write</u> Disabled Enabled	This item is used to control the PCI master write cycle. If enabled, there is no wait state. If disabled, there will be one wait state for PCI master write.
--	--

PNP/PCI Configuration à PCI Delay Transaction

<u>PCI Delay Transaction</u> Disabled Enabled	This item lets you control the Delayed Transaction function of the VIA 586A chipset (Intel PCI to ISA bridge). This function is used to meet latency of PCI cycles to or from ISA bus. Try to enable or disable it, if you have ISA card compatibility problem.
--	---

AWARD BIOS

PNP/PCI Configuration à PCI#2 Access #1 Retry

**PCI#2 Access #1
Retry**

Disabled
Enabled

This item is used to enable or disable AGP master retry disconnect. If enabled, AGP master will be disconnected if max retries are attempted without success. PCI#2 means AGP.

PNP/PCI Configuration à AGP Master 1 WS Write

**AGP Master 1 WS
Write**

Disabled
Enabled

This item is used to enable or disable AGP master 1 wait state write.

PNP/PCI Configuration à AGP Master 1 WS Read

**AGP Master 1 WS
Read**

Disabled
Enabled

This item is used to enable or disable AGP master 1 wait state read.

AWARD BIOS

4.5 Power Management Setup

The Power Management Setup screen enables you to control the motherboard's green features.



Power Management à ACPI Function

<u>ACPI Function</u>

Enabled
Disabled

If your OS is ACPI enabled you have to set this item to Enabled, or there may be unexpected errors. If your OS is APM mode, you can remain the Disabled setting.

Power Management à Power Management

<u>Power Management</u>

Max Saving
Mix Saving
User Defined
Disabled

This function allows you to set the default parameters of power-saving modes. Set to **Disable** to turn off power management function. Set to User Defined to choose your own parameters.

AWARD BIOS

Mode	Doze	Standby	Suspend	HDD Power Down
Min Saving	1 hour	1 hour	1 hour	15 min
Max Saving	1 min	1 min	1 min	1 min

Power Management à PM Controlled by APM

PM Controlled by APM Yes No	If "Max Saving" is selected, you can turn on this item, transfer power management control to APM (Advanced Power Management) and enhance power saving function. For example, stop CPU internal clock.
--	---

Power Management à Video Off Method

Video Off Method V/H SYNC + Blank DPMS Blank Screen	This determines the way that monitor is off. Blank Screen writes blanks to video buffer. V/H SYNC+Blank allows BIOS to control VSYNC and HSYNC signals. This function applies only for DPMS (Display Power Management Standard) monitor. The DPMS mode uses DPMS function provided by VGA card.
---	---

Power Management à Video Off After

Video Off After N/A Doze Standby Suspend	To turn off video monitor at which power down mode.
---	---

AWARD BIOS

Power Management à Suspend Mode Option

<u>Suspend Mode Option</u> PowerOn Suspend Suspend to Disk	You can select suspend mode by this item. Power On Suspend is the traditional Green PC suspend mode, the CPU clock is stop, all other devices are shut off. But power must be kept On to detect activities from modem, keyboard/mouse and returns the system to full power. The system activities is detected by monitoring the IRQ signals or I/O. Suspend to Disk saves system status, memory and screen image into hard disk, then the power can be totally Off. Next time, when power is turned On, the system goes back to your original work within just few seconds, which depending on your memory size. You need utility AOZVHDD to reserve disk space.
---	--

Power Management à Operating System

<u>Operating System</u> DOS Win 9x	To implement suspend function, you have to specify an operating system. Currently, only DOS and Win95/98 support this function.
---	---

Power Management à Doze Mode

<u>Doze Mode</u> Disabled 10 Sec 20 Sec 30 Sec 40 Sec 1 Min 2 Min 4 Min 6 Min 8 Min 10 Min 20 Min 30 Min 40 Min 1 Hour	This item lets you set the period of time after which the system enters into Doze mode. In this mode, the CPU clock slows down. The ratio is specified in the "Throttle Duty Cycle". Any activity detected returns the system to full power. The system activity (or event) is detected by monitoring the IRQ signals.
--	--

AWARD BIOS

Power Management à Suspend Mode

<u>Suspend Mode</u>
Disabled
10 Sec
20 Sec
30 Sec
40 Sec
1 Min
2 Min
4 Min
6 Min
8 Min
10 Min
20 Min
30 Min
40 Min
1 Hour

This item lets you set the period of time after which the system enters into Suspend mode. The Suspend mode can be Power On Suspend or Suspend to Hard Drive, selected by "Suspend Mode Option".

Power Management à HDD Power Down

<u>HDD Power Down</u>
Disabled
1 Min
.....
15 Min

This option lets you specify the IDE HDD idle time before the device enters the power down state. This item is independent from the power states previously described in this section (Standby and Suspend).

Power Management à Soft-Off by PWR-BTTN

<u>Soft-Off by PWR-BTTN</u>
Delay 4 sec.
Instant-Off

This is a specification of ACPI and supported by hardware. When **Delay 4 sec.** is selected, the soft power switch on the front panel can be used to control power On, Suspend and Off. If the switch is pressed less than 4 sec during power On, the system will go into Suspend mode. If the switch is pressed longer than 4 sec, the system will be turned Off. The default setting is **Instant-Off**, soft power switch is only used to control On and Off, there is no need to press 4 sec, and there is no Suspend.

AWARD BIOS

Power Management à VGA
Power Management à LPT & COM
Power Management à HDD & FDD
Power Management à DMA/Master

COM Ports Activity

ON
OFF

To enable or disable the detection of COM port, LPT, HDD, VGA, and DMA activities for power down state transition.

Power Management à Wake On LAN

Wake On LAN

Enabled
Disabled

This option lets you specify enable or disable Wake On LAN function.

Power Management à 0V Wake On Modem

0V Wake On Modem

Disabled
Enabled

This motherboard implements AOpen special circuit to detect modem ring signal and wakeup from soft power off. The most possible applications are automatic answering machine and fax send/receive. It does not like traditional green PC suspend mode, the system can be true power off, (identified by the fan of your power supply is off). You can use external box modem or AOpen MP56/F56 internal modem card for modem ring-on, but MP56/F56 is recommended, since MP56/F56 has special circuit to cooperate with this mainboard and the modem power and system power can be off together.

Power Management à Wake On RTC Timer

Wake On RTC Timer

Disabled
Enabled

This option lets you enable or disable the Wake on RTC Timer function.

AWARD BIOS

Power Management à Date (of Month)

<u>Date (of Month)</u>
0
1
.....
31

This item is displayed when you enable Wake on RTC Timer option. Here you can specify what date you want to wake up the system. For Example, setting to 15 will wake up the system on the 15th day of every month.



Note: Setting this item to 0 will wake up the system on the specified time (which can be set in the next item) every day.

Power Management à Timer (hh:mm:ss)

<u>Timer (hh:mm:ss)</u>
hh:mm:ss

This item is displayed when you enable Wake on RTC Timer option. Here you can specify what time you want to wake up the system.

Power Management à Primary INTR

<u>Primary</u>
ON
OFF

This item is used to enable or disable the detection of IRQ3-15 or NMI interrupt events for power down state transition. Normally, this is applied to network card.

Power Management à IRQ [3-15]

<u>IRQ [3-15],NMI</u>
Primary
Secondary
Disabled

Select Primary or Disabled option to enable or disable the detection of specified IRQ. If the Secondary option was selected, the system will wake up for 2ms after detecting the interrupt, and then return to power down status.

AWARD BIOS

4.6 PNP/PCI Configuration Setup

The PNP/PCI Configuration Setup allows you to configure the ISA and PCI devices installed in your system. The following screen appears if you select the option "PNP/PCI Configuration Setup" from the main menu.

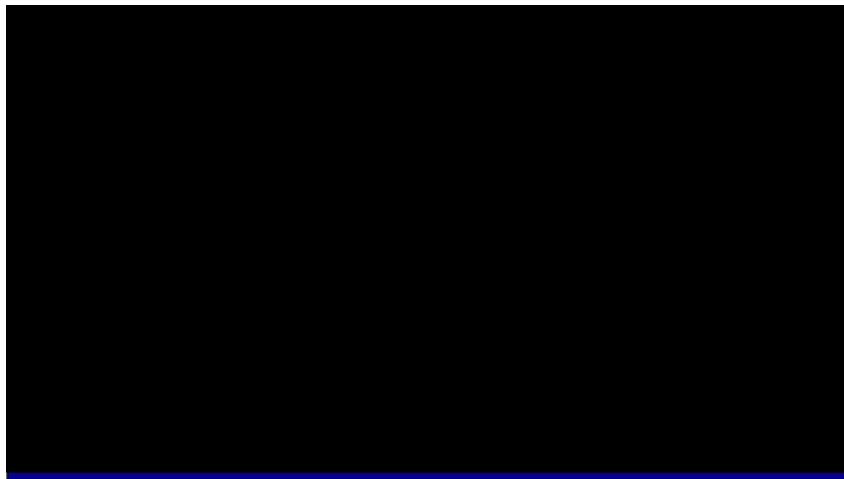

PNP/PCI Configuration à PnP OS Installed

<u>PnP OS Installed</u>	Normally, the PnP resources are allocated by BIOS during POST (Power-On Self Test). If you are using a PnP operating system (such as Windows 95), set this item to Yes to inform BIOS to configure only the resources needed for booting (VGA/IDE or SCSI). The rest of system resources will be allocated by PnP operating system.
Yes	
No	

AWARD BIOS

PNP/PCI Configuration à Resources Controlled By

<u>Resources Controlled by</u> Auto Manual

Setting this option to Manual allows you to individually assign the IRQs and DMAs to the ISA and PCI devices. Set this to **Auto** to enable the auto-configuration function.

PNP/PCI Configuration à Reset Configuration Data

<u>Reset Configuration Data</u> Enabled Disabled

In case conflict occurs after you assign the IRQs or after you configure your system, you can enable this function, allow your system to automatically reset your configuration and reassign the IRQs.

PNP/PCI Configuration à IRQ3 (COM2)

PNP/PCI Configuration à IRQ4 (COM1)

PNP/PCI Configuration à IRQ5 (Network/Sound or Others)

PNP/PCI Configuration à IRQ7 (Printer or Others)

PNP/PCI Configuration à IRQ9 (Video or Others)

PNP/PCI Configuration à IRQ10 (SCSI or Others)

PNP/PCI Configuration à IRQ11 (SCSI or Others)

PNP/PCI Configuration à IRQ12 (PS/2 Mouse)

PNP/PCI Configuration à IRQ14 (IDE1)

PNP/PCI Configuration à IRQ15 (IDE2)

<u>IRQ 3</u> Legacy ISA PCI/ISA PnP
--

If your ISA card is not PnP compatible and requires a special IRQ to support its function, set the selected IRQ to **Legacy ISA**. This setting informs the PnP BIOS to reserve the selected IRQ for the installed legacy ISA card. The default is **PCI/ISA PnP**. Take note that PCI cards are always PnP compatible (except old PCI IDE card).

AWARD BIOS

PNP/PCI Configuration à DMA 0
PNP/PCI Configuration à DMA 1
PNP/PCI Configuration à DMA 3
PNP/PCI Configuration à DMA 5
PNP/PCI Configuration à DMA 6
PNP/PCI Configuration à DMA 7

DMA 0

Legacy ISA
PCI/ISA PnP

If your ISA card is not PnP compatible and requires a special DMA channel to support its function, set the selected DMA channel to **Legacy ISA**. This setting informs the PnP BIOS to reserve the selected DMA channel for the installed legacy ISA card. The default is **PCI/ISA PnP**. Take note that PCI card does not require DMA channel.

Power Management à Modem Use IRQ

Modem Use IRQ

3
4
5
7
9
10
11
N/A

This item lets you set an IRQ for the modem.

AWARD BIOS

PNP/PCI Configuration à PCI-Slot1 IRQ (Right)

PNP/PCI Configuration à PCI-Slot2 IRQ

PNP/PCI Configuration à PCI-Slot3 IRQ

PNP/PCI Configuration à PCI-Slot4 IRQ (Left)

<u>PCI-Slot1 IRQ</u>
3
4
5
6
7
9
10
11
12
14
15
Auto

This item is reserved for engineering purpose to let you assign an IRQ manually to the add-on card on each PCI slot. If you select Auto, system will automatically assign an available value to the device.

It is suggested to use default setting, which is Auto, in order to comply with PnP specification completely.

AWARD BIOS

4.7 Load Setup Defaults

The "Load Setup Defaults" option loads optimized settings for optimum system performance. Optimal settings are relatively safer than the Turbo settings. All the product verification, compatibility/reliability test report and manufacture quality control are based on "Load Setup Defaults". We recommend that you use this settings for normal operation. "Load Setup Defaults" is not the slowest setting for this motherboard. If you need to verify an unstable problem, you may manually set the parameter in the "BIOS Features Setup" and "Chipset Features Setup" to get slowest and safer setting.

4.8 Load Turbo Defaults

The "Load Turbo Defaults" option gives better performance than "Load Setup Defaults". It is provided for the convenience of power user who wants to push the motherboard to get better performance. Turbo setting does not go through all the detail reliability and compatibility test, it is tested only with limited configuration and loading (for example, a system that contains only a VGA card and two DIMMs). Use Turbo setting only when you fully understand the items in Chipset Setup menu. The performance improvement of Turbo setting is normally around 3% to 5%, depending on the chipset and the application.

4.9 Integrated Peripherals

The following screen appears if you select the option "Integrated Peripherals" from the main menu. This option allows you to configure the I/O features.

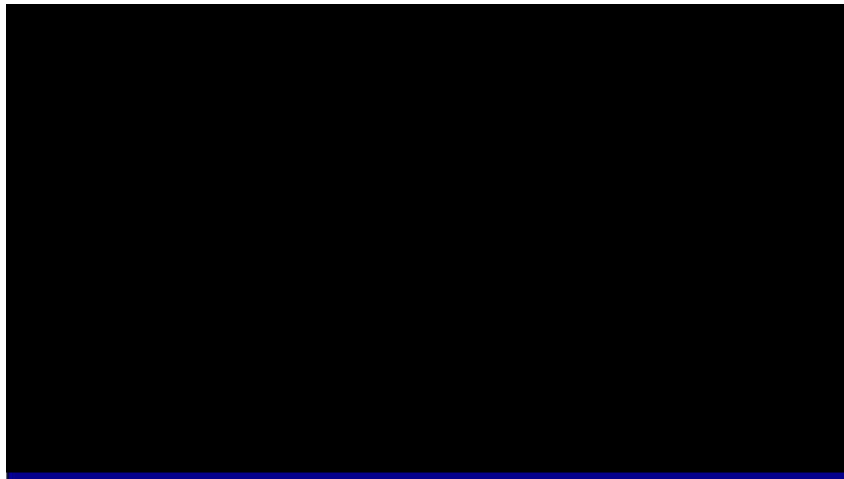

Integrated Peripherals à OnChip Primary IDE Integrated Peripherals à OnChip Secondary IDE

OnChip Primary IDE

Enabled
Disabled

This parameter lets you enable or disable the IDE device connected to the primary IDE connector.

Integrated Peripherals à IDE Prefetch Mode

IDE Prefetch Mode

Enabled
Disabled

This item is used to enable and disable IDE prefetch mode.

AWARD BIOS

Integrated Peripherals à IDE HDD Block Mode

IDE HDD Block Mode Enabled Disabled	This feature enhances disk performance by allowing multisector data transfers and eliminates the interrupt handling time for each sector. Most IDE drives, except with old designs, can support this feature.
--	---

Integrated Peripherals à Primary Master PIO Integrated Peripherals à Primary Slave PIO Integrated Peripherals à Secondary Master PIO Integrated Peripherals à Secondary Slave PIO

IDE Primary Master PIO Auto Mode 1 Mode 2 Mode 3 Mode 4	Setting this item to Auto activates the HDD speed auto-detect function. The PIO mode specifies the data transfer rate of HDD. For example: mode 0 data transfer rate is 3.3MB/s, mode 1 is 5.2MB/s, mode 2 is 8.3MB/s, mode 3 is 11.1MB/s and mode 4 is 16.6MB/s. If your hard disk performance becomes unstable, you may manually try the slower mode.
---	--



Caution: It is recommended that you connect the first IDE device of each channel to the endmost connector of the IDE cable. Refer to section 2.3 "Connectors" for details on how to connect IDE device(s).

Integrated Peripherals à Primary Master UDMA Integrated Peripherals à Primary Slave UDMA Integrated Peripherals à Secondary Master UDMA Integrated Peripherals à Secondary Slave UDMA

IDE Primary Master UDMA Auto Disabled	This item allows you to set the Ultra DMA/33 mode supported by the hard disk drive connected to your primary IDE connector.
--	---

AWARD BIOS

Power Management à AC PWR Auto Recovery

<u>AC PWR Auto Recovery</u> Former-Sts On Off	A traditional ATX system should remain at power off stage when AC power resumes from power failure. This design is inconvenient for a network server or workstation, without an UPS, that needs to keep power-on. This item is used to solve this problem. Selecting On lets the system can automatically power-on after AC power resumes; in the other hand, the system will power-off if you select Off. If Former-Sts option is selected, the system will power-on or power-off based on the original state.
---	---

Integrated Peripherals à OnChip Sound

<u>OnChip Sound</u> Disabled Enabled	This item is used to enable or disable the onboard audio.
---	---

Integrated Peripherals à OnChip Legacy Audio

<u>OnChip Legacy Audio</u> Disabled Enabled	This motherboard has a Sound Blaster Pro compatible onchip audio. This item should be set to Enabled under DOS mode.
--	--

Integrated Peripherals à SB I/O Base Address

<u>SB I/O Base Address</u> 220-22fh 240-24fh 260-26fh 280-28fh	This item is used to select SB I/O base address.
---	--

Integrated Peripherals à SB IRQ Select

<u>SB IRQ Select</u> IRQ5 IRQ7 IRQ9 IRQ10	This item is used to select IRQ for the onboard audio.
--	--

AWARD BIOS

Integrated Peripherals à SB DMA Select

<u>SB DMA Select</u> DMA0 DMA1 DMA2 DMA3	This item is used to select DMA for the onboard audio.
---	--

Integrated Peripherals à MPU-401 I/O Address

<u>MPU-401 I/O Address</u> 300-303h 310-313h 320-323h 330-333h	This item is used to select I/O base address for the MIDI port.
---	---

Integrated Peripherals à Onboard FDC Controller

<u>Onboard FDC Controller</u> Enabled Disabled	Setting this parameter to Enabled allows you to connect your floppy disk drives to the onboard floppy disk connector instead of a separate controller card. Change the setting to Disabled if you want to use a separate controller card.
---	--

Integrated Peripherals à Onboard Serial Port 1 Integrated Peripherals à Onboard Serial Port 2

<u>Onboard Serial Port 1</u> Auto 3F8/IRQ4 2F8/IRQ3 3E8/IRQ4 2E8/IRQ3 Disabled	This item allows you to assign address and interrupt for the board serial port. The default setting is Auto .
---	--

AWARD BIOS

Integrated Peripherals à UART Mode Select

UART Mode Select

Normal
HPSIR
ASKIR

This allows you to specify the mode of serial port2.
The available mode selections are:

- **Normal** - Sets serial port 2 to operate in normal mode. This is the default setting.
- **HPSIR** - Select this setting if you installed an Infrared module in your system via IrDA connector (refer to section 2.3 "Connectors"). This setting allows infrared serial communication at a maximum baud rate of 115K baud.
- **ASKIR** - Select this setting if you installed an Infrared module via IrDA connector (refer to section 2.3 "Connectors"). This setting allows infrared serial communication at a maximum baud rate of 19.2K baud.

Integrated Peripherals à IR Function Duplex

IR Function Duplex

Full
Half

This item lets you set the duplex mode for the IR communication. Full - Allows IR communication in bidirectional mode. Half - Allows IR communication in single direction only.



Note: This option appears only if the IR function is activated and the Onboard UART 2 Mode parameter is NOT set to Standard.

Integrated Peripherals à RxD, TxD Active

RxD, TxD Active

Hi, Lo
Lo, Hi
Lo, Lo
Hi, Hi

This item is used to select RxD (Receive Data) and TxD (Transmit Data) mode for UART, for instance, IR device, modem, etc. Normally, we suggest you keep the default setting. Please see the documentation that comes with your device.

AWARD BIOS

Integrated Peripherals à Onboard Parallel Port

<u>Onboard Parallel Port</u> 3BC/IRQ7 378/IRQ7 278/IRQ7 Disabled

This item controls the onboard parallel port address and interrupt.



Note: If you are using an I/O card with a parallel port, make sure that the addresses and IRQ do not conflict.

Integrated Peripherals à Onboard Parallel Mode

<u>Onboard Parallel Mode</u> SPP ECP EPP ECP+EPP

This item lets you set the parallel port mode. The mode options are SPP (Standard and Bidirection Parallel Port), EPP (Enhanced Parallel Port) and ECP (Extended Parallel Port). SPP is the IBM AT and PS/2 compatible mode. EPP enhances the parallel port throughput by directly writing/reading data to/from parallel port without latch. ECP supports DMA and RLE (Run Length Encoded) compression and decompression.

Integrated Peripherals à ECP Mode Use DMA

<u>ECP Mode Use DMA</u> 3 1
--

This item lets you set the DMA channel of ECP mode.

Integrated Peripherals à EPP Mode Select

<u>EPP Mode Select</u> EPP1.7 EPP1.9

This item lets you select EPP mode.

Integrated Peripherals à OnChip USB

<u>OnChip USB</u> Disabled Enabled

This item lets you enable or disable onboard USB.

AWARD BIOS

Integrated Peripherals à USB Keyboard Support

<u>USB Keyboard Support</u>

Enabled
Disabled

This item lets you enable or disable the USB keyboard driver within the onboard BIOS. The keyboard driver simulates legacy keyboard command and let you use USB keyboard during POST or after boot if you don't have USB driver in the operating system.



Caution: You can not use both USB driver and USB legacy keyboard at the same time. Disable "USB Keyboard Support" if you have USB driver in the operating system.

AWARD BIOS

4.10 Password Setting

Password prevents unauthorized use of your computer. If you set a password, the system prompts for the correct password before boot or access to Setup.

To set a password:

1. At the prompt, type your password. Your password can be up to 8 alphanumeric characters. When you type the characters, they appear as asterisks on the password screen box.
2. After typing the password, press Enter.
3. At the next prompt, re-type your password and press again to confirm the new password. After the password entry, the screen automatically reverts to the main screen.

To disable the password, press when prompted to enter the password. The screen displays a message confirming that the password has been disabled.

4.11 IDE HDD Auto Detection

If your system has an IDE hard drive, you can use this function to detect its parameters and enter them into the "Standard CMOS Setup" automatically.

This routine only detects one set of parameters for your IDE hard drive. Some IDE drives can use more than one set of parameters. If your hard disk is formatted using different parameters than those detected, you have to enter the parameters manually. If the parameters listed do not match the ones used to format the disk, the information on that disk will not be accessible. If the auto-detected parameters displayed do not match those that used for your drive, ignore them. Type N to reject the values and enter the correct ones manually from the Standard CMOS Setup screen.

4.12 Save & Exit Setup

This function automatically saves all CMOS values before leaving Setup.

4.13 Exit without Saving

Use this function to exit Setup without saving the CMOS value changes. Do not use this option if you want to save the new configuration.

4.14 NCR SCSI BIOS and Drivers

The NCR 53C810 SCSI BIOS resides in the same flash memory chip as the system BIOS. The onboard NCR SCSI BIOS is used to support NCR 53C810 SCSI control card without BIOS code.

The NCR SCSI BIOS directly supports DOS, Windows 3.1 and OS/2. For better system performance, you may use the drivers that come with the NCR SCSI card or with your operating system. For details, refer to the installation manual of your NCR 53C810 SCSI card.

4.15 BIOS Flash Utility

AOpen Easy Flash is more user friendly than traditional flash method. The BIOS binary file and flash routine are combined together and you simply run a single file to complete the flash process.

1. Get new BIOS upgrade program from AOpen's web site. For example, MX59P200.EXE.
2. Reboot the system to DOS mode without loading any memory handler (such as EMM386) or device driver. It needs around 520K free memory space.
3. Execute A:> MX59P200
DO NOT turn off the power during FLASH PROCESS.
4. Reboot the system by turn off the power after flash is completed.
5. Reload the "BIOS SETUP DEFAULT" and reconfigure other items as previous set. Save & Exit. Done!

Note: The upgrade of new BIOS will permanently replace your original BIOS content after flashing. The original BIOS setting and Win95/Win98 PnP information will be refreshed and you probably need to re-configure your system.