

System Board Layout

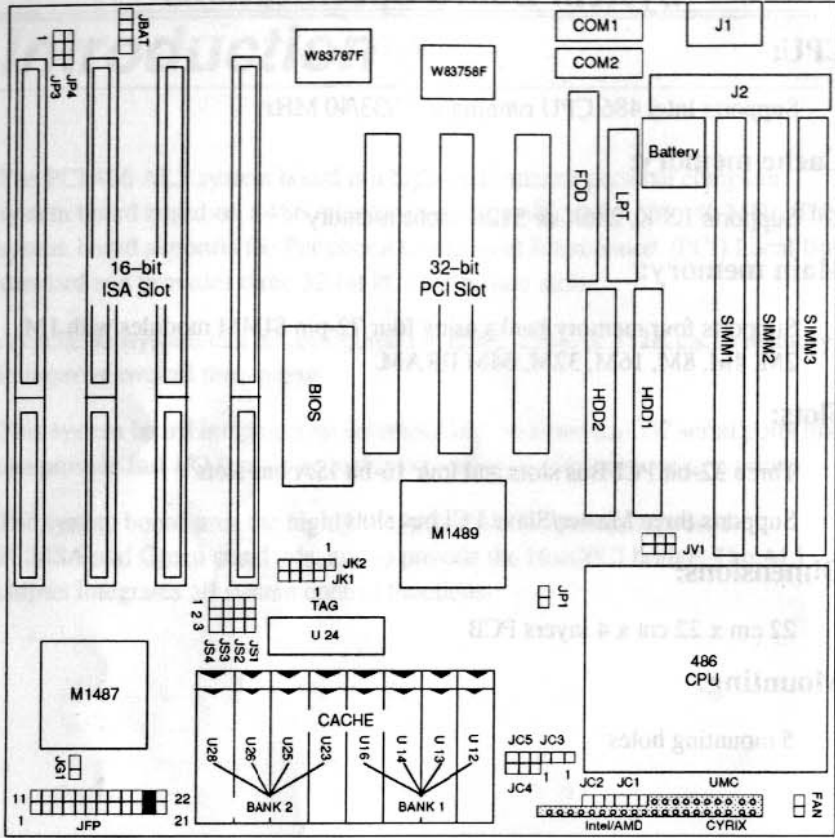

Figure 1-1. System board Layout

CHAPTER 2 Hardware Installation

When you install the system board, you must configure components, jumpers, and attach connectors.

Quick Reference

Installation Guide 2

Jumpers

- CPU Type — JC1~JC5, JRN1~JRN3 2
- Voltage Regulator — JV1, JP1 2
- CPU Speed — JK1, JK2 2
- Cache Selectors — JS1, JS2, JS4 2
- DACK# & DREQ Selectors — JP3, JP4 2

Connectors

- Keyboard Lock & Power LED — JFP (pins 1~5) 2
- Power Saving LED connector — JFP (pins 3~4) 2
- Speaker connector — JFP (pins 7~10) 2
- Sleep Switch connector — JFP (pins 8~9) 2
- Turbo LED connector — JFP (pins 12~13) 2
- Turbo switch — JFP (pins 15~17) 2
- Hardware Reset — JFP (pins 19~20) 2
- HDD LED — JFP (pins 21~22) 2
- Keyboard connector — J1 2
- Power connector — J2 2
- External Battery connector — JBAT 2
- Green connector — JG1 2
- CPU Fan Connector — JFAN 2

Installation Guide

For mainboard installation, it is important that the jumper settings are set correctly. Improper jumper settings will cause system instability or system hang-ups. Please refer to the installation procedures below.

□ STEP 1: Setting the CPU Type Jumper (JC1 – JC5, JRN1 –3).

JC4, JC5 are used for coprocessor setting.

JC2, JRN1–3 are used for power management (green function) setting. If not set properly, there might be no system display or “CTRL-ALT-DEL” (warm boot) might cause the system to hang.

JC1 are used for internal cache (write-back or write-through) setting.

Note: Please refer to the manual for the jumper setting for CPUs with internal write-back function (such as Intel P24D, Intel Pentium OverDrive P24T and AMD Enhanced CPU).

□ STEP 2: Setting the CPU Voltage Jumper (JV1, JP1).

During the purchase of your CPU, please confirm if the CPU you're getting is 3-volt (3.3 and 3.45), 4-volt or 5-volt.

For Intel, only DX4-75 and DX4-100 are 3-volt. The rest are 5-volt. There is also some special 5-volt CPUs, DX4 OverDrive and Pentium OverDrive P24T, which has a regulator and heat sink on the top surface.

For AMD, CPUs marked with 3 volt are 3-volt. The rest are 5-volt.

For Cyrix, CPUs marked with V50 and V66 are 3-volt. CPUs marked with V80 are 4-volt. CPUs without the “V” mark are 5-volt.

!Warning: Improper voltage setting might cause serious damage to your CPU.

□ STEP 3: Setting the CPU External Frequency Jumper (JK1 – JK2).

From the mark of the CPU, “486DXY-KK”:

Y = blank, refers to KK frequency.

Y = 2, refers to KK/2 frequency.

Y = 4, refers to KK/3 frequency.

For example:

486DX-33, external frequency is 33MHz.

486DX2-66, 66 divided by 2, external frequency is 33MHz.
The internal frequency is 66MHz.

486DX4-100, 100 divided by 3, external frequency is 33MHz. The internal frequency is 100MHz.

!Warning: Improper speed setting might cause system instability or system hang-ups. Setting the CPU to run in a frequency higher than what it actually supports might cause serious damage to your CPU.

□ STEP 4: Setting the Cache Size Jumper (JS1 – JS4).

This jumper must be set according to the actual cache size installed.

!Warning: Improper jumper setting might still show the cache size upon boot-up, but might cause system instability or system hang-ups.

STEP 5: Installing the SIMM Modules into the proper SIMM sockets.

During the purchase of your SIMM, please confirm if the SIMM you're getting is single density (single bank) or double density (double bank).

This mainboard supports only 4 banks of memory. So, this means that it can only accommodate 3 pieces of single density SIMM or 2 pieces of double density SIMM.

For single density SIMM, any sockets can be used. For double density SIMM, only SIMM1 and SIMM2 can be used, and SIMM1 must be filled up first.

SIMM1	SIMM2	SIMM3	TOTAL
Single:			
4M	—	—	4M
4M	4M	—	8M
4M	16M	—	20M
4M	4M	4M	12M
4M	4M	16M	24M
16M	—	—	16M
16M	16M	—	32M
16M	16M	16M	48M

SIMM1	SIMM2	SIMM3	TOTAL
Double:			
4M/4M	—	—	8M
4M/4M	4M/4M	—	16M
4M/4M	16M/16M	—	40M
16M/16M	—	—	32M
16M/16M	16M/16M	—	64M

SIMM1	SIMM2	SIMM3	TOTAL
Double + Single:			
4M	4M/4M	—	12M
4M	4M/4M	4M	16M
16M	4M/4M	—	24M
16M	4M/4M	16M	40M
4M	16M/16M	—	36M
4M	16M/16M	4M	40M
16M	16M/16M	—	48M
16M	16M/16M	16M	64M

!Warning: Improper installation will show the wrong memory size upon boot-up. Furthermore, it but might cause system instability or system hang-ups.

STEP 6: Setting the DACK#/DREQ# Jumper (JP3, JP4).

These jumpers can be left open and are required to be set only if you are using ECP/EPP devices. Before setting this jumper, check first which channel is available. A sound card normally uses an 8-bit DMA, so you have to check the DMA channel used, in case one is installed.

STEP 7: Connecting the front panels to JFP.

Connect JFP to the front panel of your system case.

□ STEP 8: Connecting the HDD, FDD, LPT, COM!, COM2, and all the other add-on cards and peripherals.

After booting up, you can press "DEL" key to enter SETUP. (You can refer to Chapter 3 for the BIOS Setup.) In Setup, you are only required to "set the standard Setup", "load the optimal values", and "detect the hard disk type." Afterwards, you can start working.

CPU Type Jumpers: JC1~5, JRN1~3

JC1~5 and JRN1~3 set the system board to recognize the type of CPU that is installed. Set JC1~5 and JRN1~3 according to CPU type as shown below. See Figure 1-1 for the location of the jumpers.

486SX Settings — Intel SX CPU without Green functions.

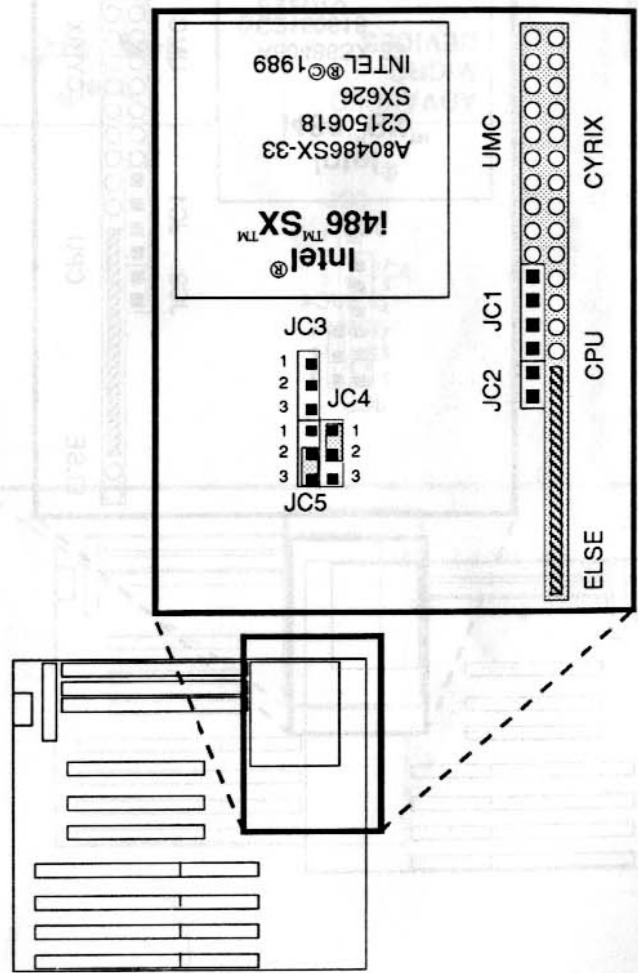

486SX Settings — Intel SX CPU with Green functions The CPU is marked with "5V1X."

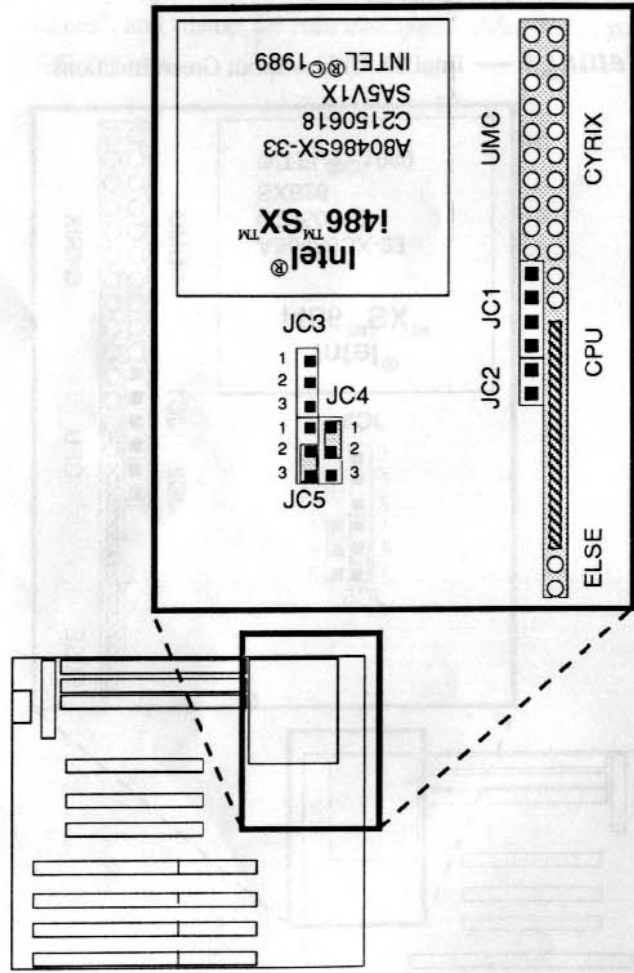

486DX/DX2 Settings — Intel CPU without Green function or AMD 486 DX/DX2 CPU.

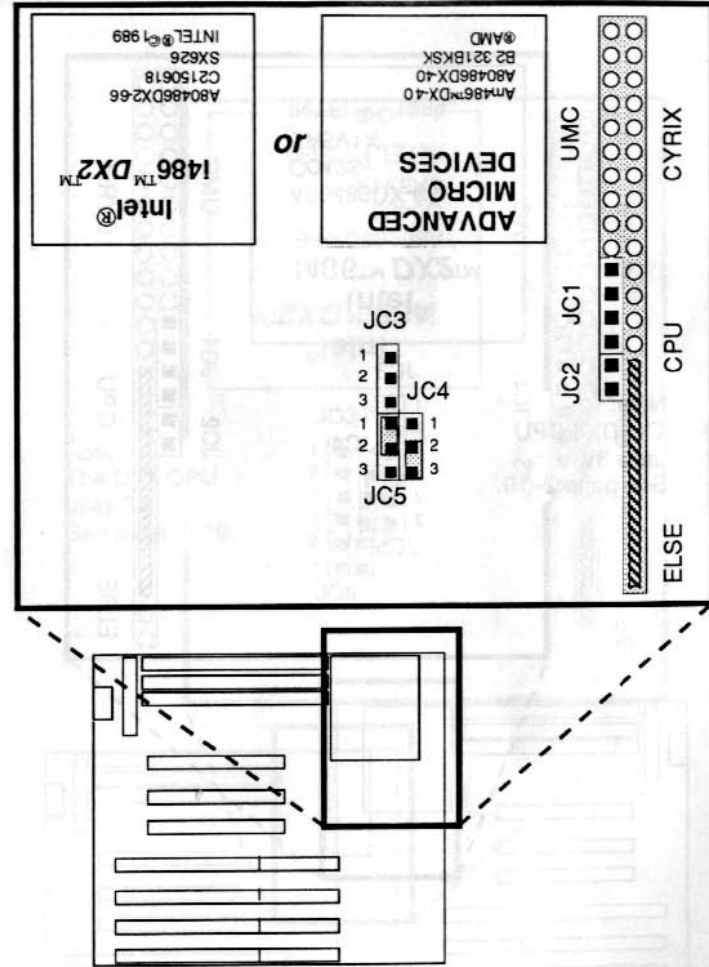

486DX/DX2/DX4 Settings

Intel CPU with Green function including 486DX, 486DX2, 486DX4, or DX4-OverDrive CPUs. These CPUs are marked with "5V1X".

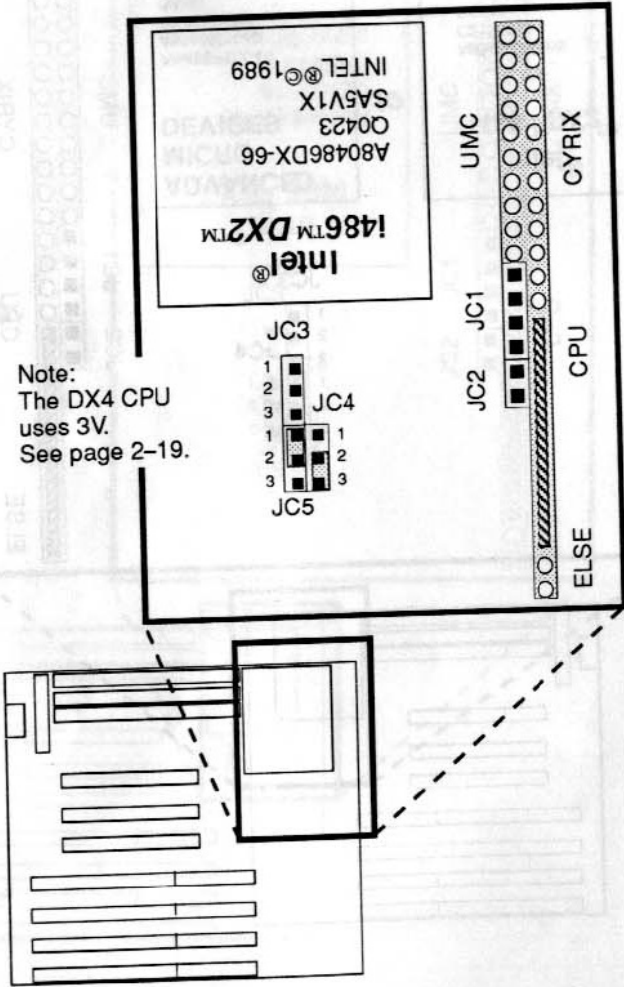

DX2 OverDrive Settings

Intel CPU with Green function including 486DX2 are marked with "OverDrive."

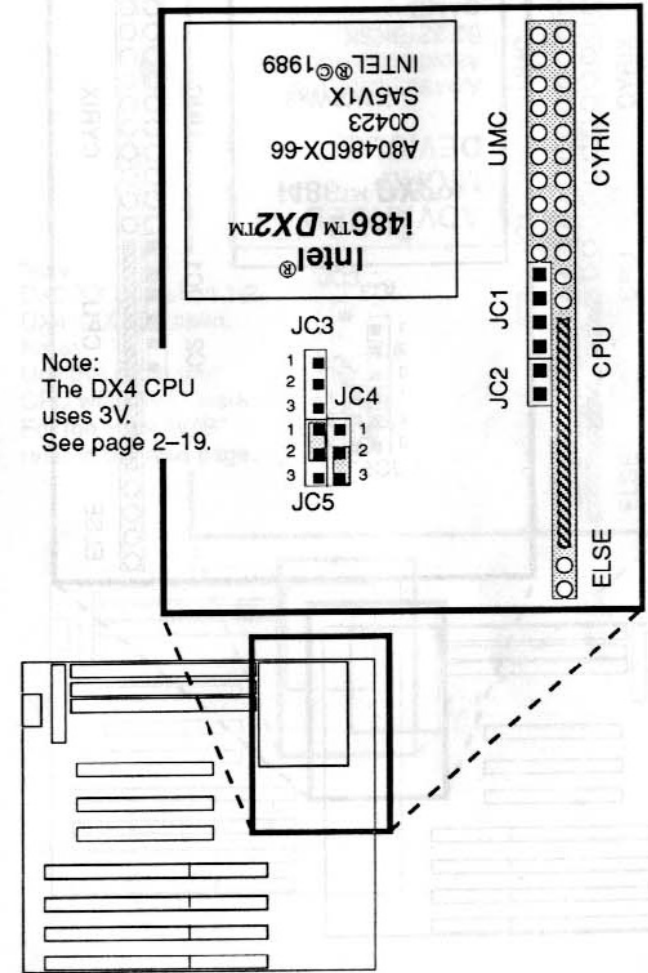

P24D/Pentium OverDrive (P24T) Settings

CPUs marked with "W5VIX" can support Write-Back mode for the CPU's internal cache.

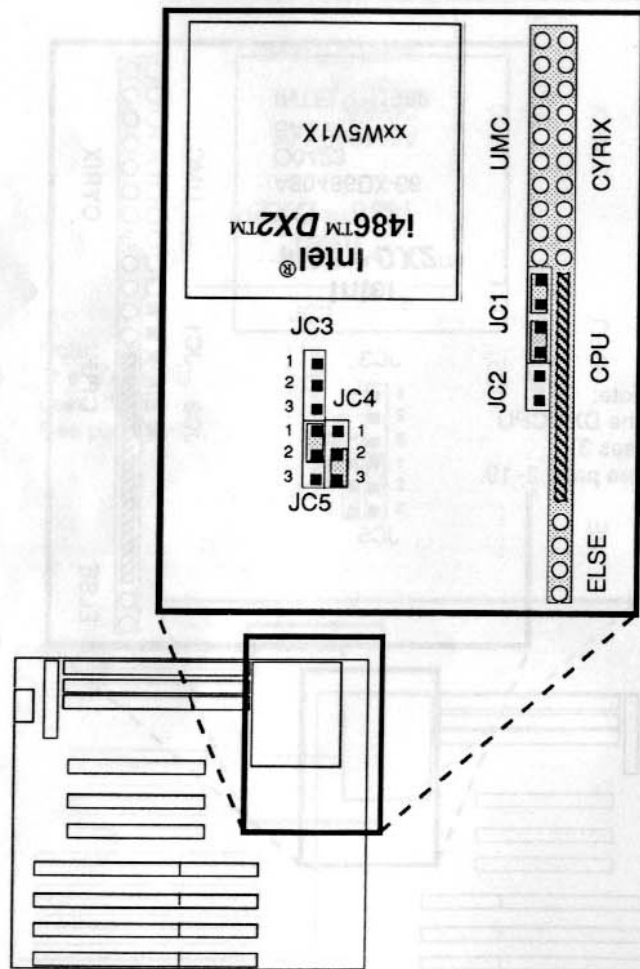

AMD Enhance 486 DX Settings

Includes DX2-66, DX2-80, and DX4-1XX. These CPUs are marked with 3V.

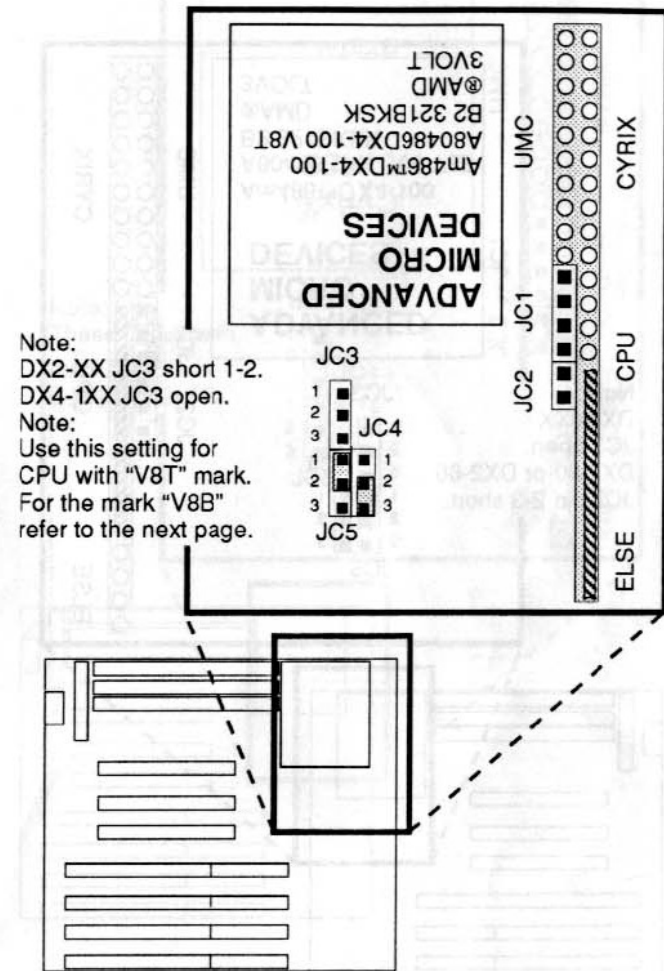

Note:
DX2-XX JC3 short 1-2.
DX4-1XX JC3 open.

Note:
Use this setting for
CPU with "V8T" mark.
For the mark "V8B"
refer to the next page.

AMD Enhance 486 DX Settings

CPUs marked with "V8B" can support Write-Back mode for the CPU's internal cache.

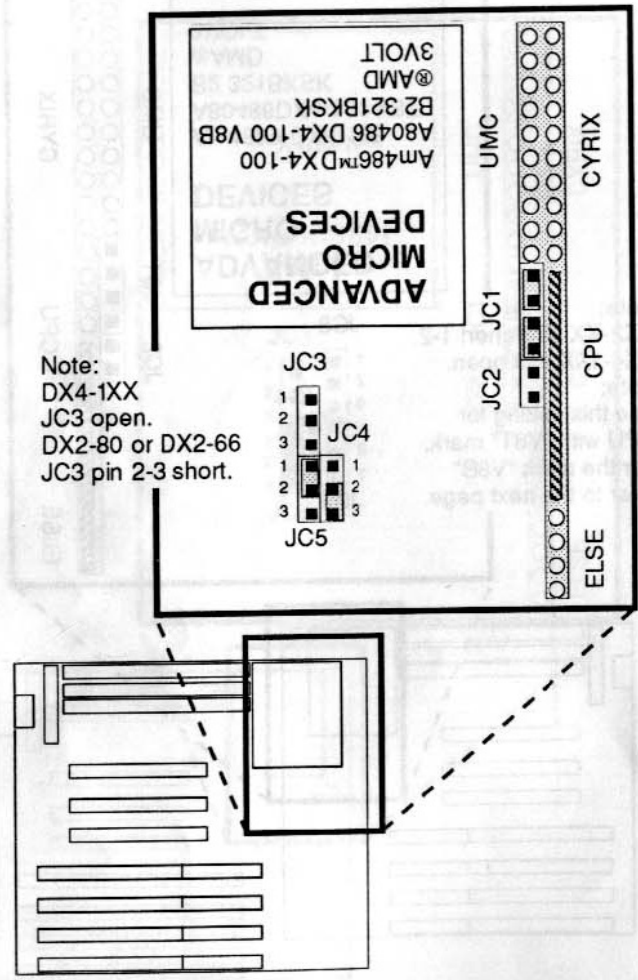

Cyrix/IBM/SGS CX 486DX2-XX

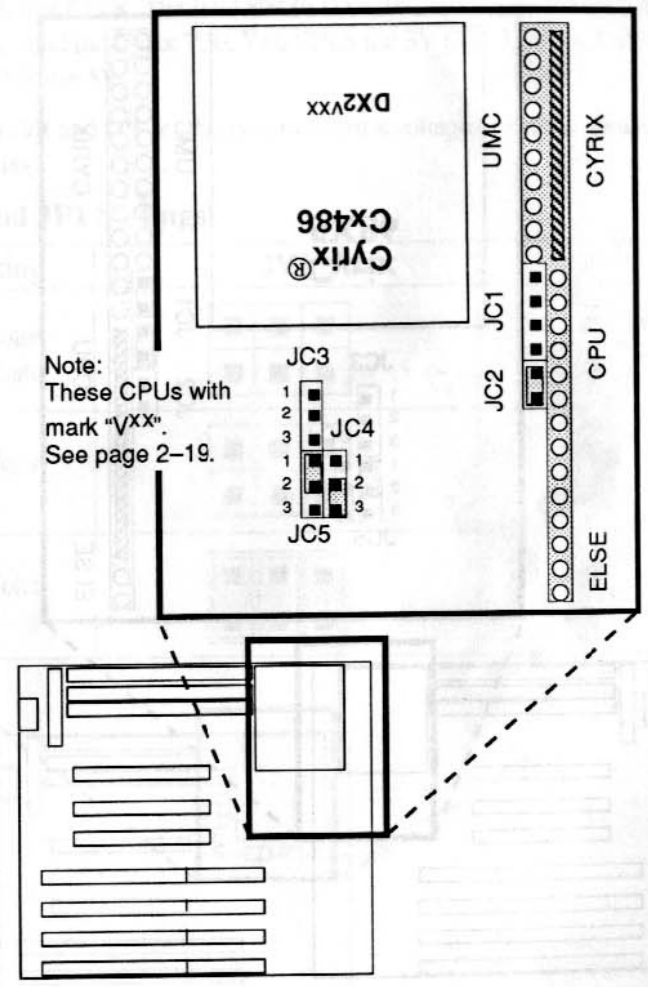

Cyril 5X86

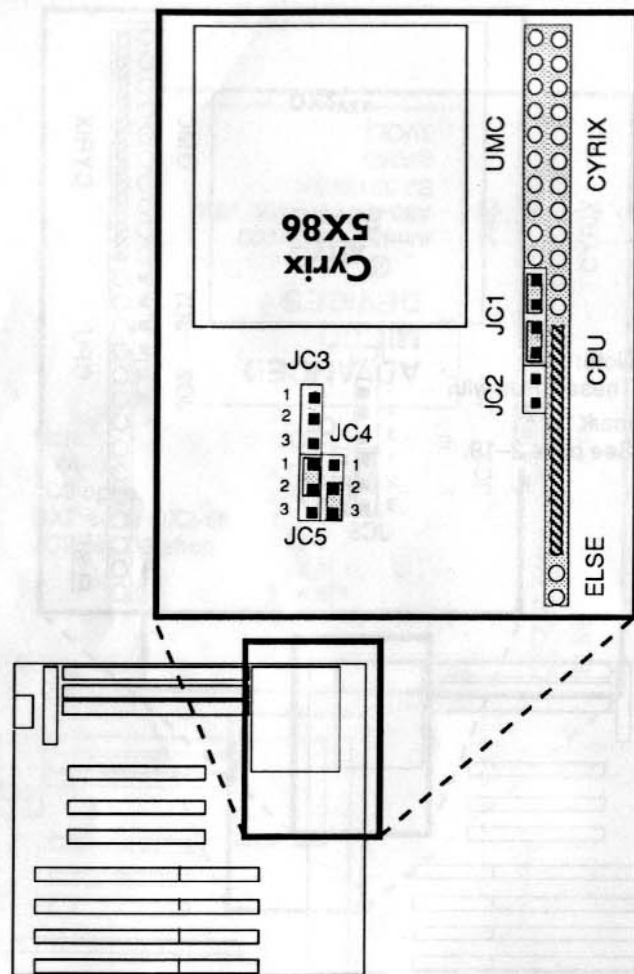

Voltage Regulating Jumpers: JV1, JP1

This system board provides three different voltages—5V, 3V, and 4V—for use with different CPUs. The Intel 80486 DX4-100 and the AMD DX2-80/DX4-100 CPUs and the Cyril V50, V66 CPUs use 3V (3V, 3.3V, or 3.45V). Most other CPUs use 5V.

Jumpers JV1 and JP1 set the system board's voltage as below. Default is the first setting.

JV1 and JP1 Settings

Setting	JV1	JP1
3 Volts (Default)		
4 Volts		
5 Volts		

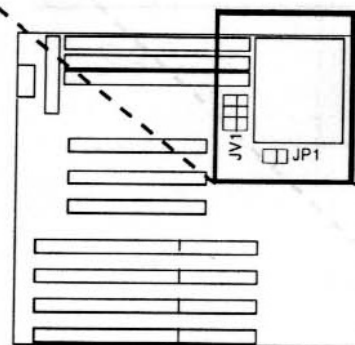

CPU Speed: JK1, JK2

Set jumpers JK1 and JK2 according to the speed of the CPU that is installed. See Figure 1-1 for the location of the jumpers.

JK1 and JK2 Settings

Jumper	25 MHz includes: 486SX-25, 486SX2-50, 486DX2-50, 486DX4-75	33 MHz includes: 486SX-33, 486SX2-66, 486DX-33, 486DX2-66, 486DX4-100	40 MHz includes: 486DX-40, 486DX2-80, 486DX4-120

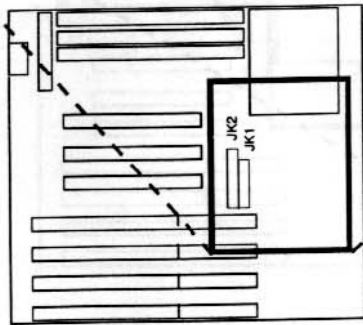

Cache Selection: JS1, JS2, JS4

The system board supports 128K, 256K, of cache memory. You configure cache memory by installing 32K8, or 64K8 SRAM chips in Data RAM sockets U12, U13, U14, U16 for bank 1 and U23, U25, U26, U28 for bank 2, and a 8K8, 16K8, or 32K8 SRAM chip in Tag socket U24. You then set jumpers JS1, JS2, as below. Note that speed required for SRAM chips is 20ns.

Cache Size	128K 32K8 x 4	256K 32K8 x 8	256K 64K8 x 4
JS1			
JS2			
JS4			

JS3

DACK# and DREQ Selectors: JP3, JP4

When the on-board printer port is set to ECP, you should also set the DMA channel used by the ECP. The system board provides DREQ 1, 3, and DACK #1, #3 for you to set. You must set the DREQ and DACK# channels the same way. See Figure 1-1 for the location of the jumpers.

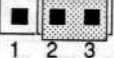
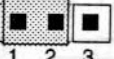
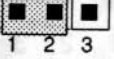
Description	Jumper Settings
DREQ1 / DACK#1	<p>JP3 </p> <p>JP4 </p>
DREQ3 / DACK#3	<p>JP3 </p> <p>JP4 </p>

Case Connector Block: JFP

The Turbo LED, Turbo Switch, Hardware Reset, Keylock, Power LED, Power Saving LED, Sleep Switch, Speaker and HDD LED all connect to the JFP Connector Block as shown below. See Figure 1-1 for JFP's location.

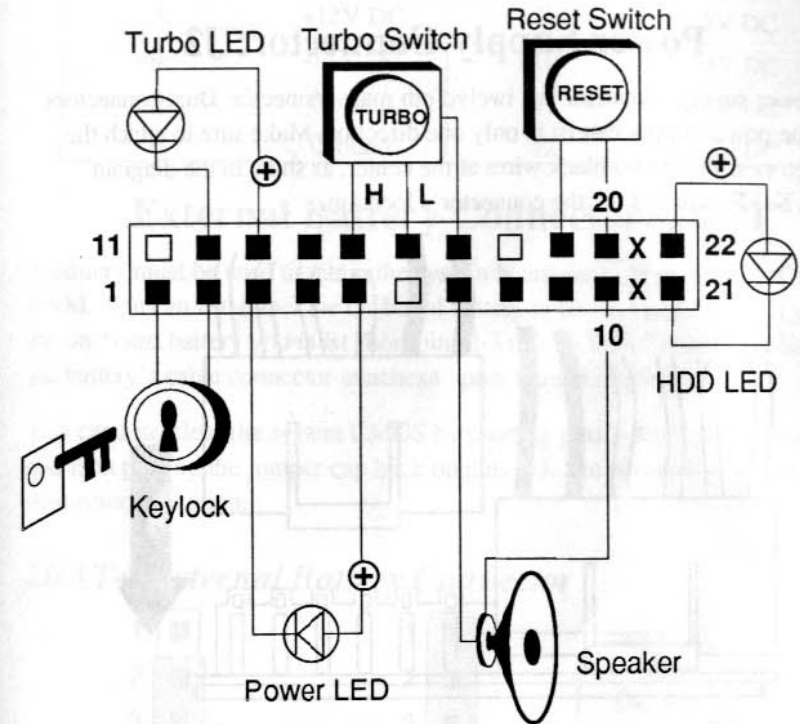

Figure 2-1. Case Connector Block - JFP

Keyboard Connector: J1

The system board provides a standard five-pin female DIN connector, J1, for attaching a keyboard. You can plug a keyboard cable directly into this connector. See Figure 1-1 for connector location.

Power Supply Connector: J2

The power supply connector is a twelve-pin male connector. Dual connectors from the power supply can fit in only one direction. Make sure to attach the connectors with the two black wires at the center, as show in the diagram below. See Figure 1-1 for the connector's location.

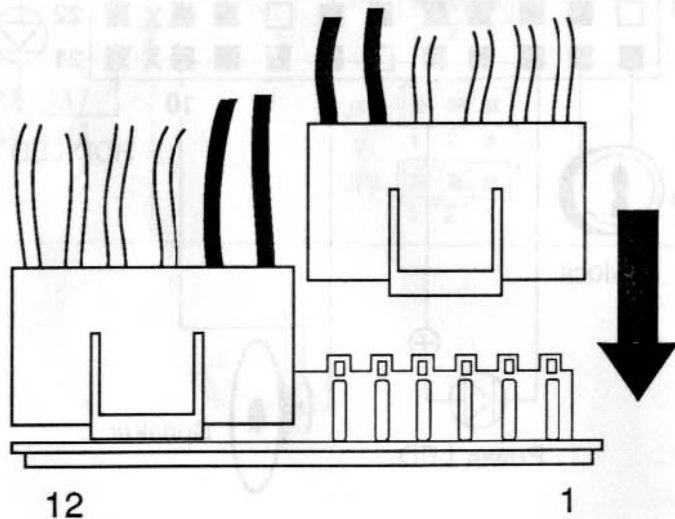

Figure 2-2. Attaching Power Supply Connectors

Connector Pin Description

Pin	Description	Pin	Description
1	Power Good	7	Ground
2	+5V DC	8	Ground
3	+12V DC	9	-5V DC
4	-12V DC	10	+5V DC
5	Ground	11	+5V DC
6	Ground	12	+5V DC

External Battery Connector: JBAT

A battery must be used to retain the system board configuration in CMOS RAM. You can use either the on-board battery or an external battery. If you use the on-board battery you must short pins 2-3 of JBAT. For an external battery, the battery's cable connector attaches to pins 1 and 4 of JBAT.

You can also clear the system CMOS by shorting pins 3-4 for a brief moment and then placing the jumper cap back on pins 2-3. See Figure 1-1 for the connector's location.

JBAT: External Battery Connector

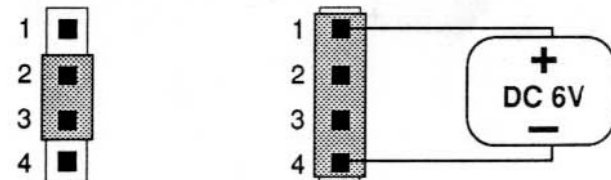

**Jumper Setting
for using
on-board Battery**

**External Battery
Connection**

Figure 2-3. Setting the External Battery Connector—JBAT