

**Version 1.0A**

Manual Rev: 1.0A  
Release Date: October 1999



### **FCC-B Radio Frequency Interference Statement**

This equipment has been tested and found to comply with the limits for a class B digital device, pursuant to part 15 of the FCC rules. These limits are designed to provide reasonable protection against harmful interference when the equipment is operated in a commercial environment. This equipment generates, uses and can radiate radio frequency energy and, if not installed and used in accordance with the instruction manual, may cause harmful interference to radio communications. Operation of this equipment in a residential area is likely to cause harmful interference, in which case the user will be required to correct the interference at his own expense.

#### **Notice 1**

The changes or modifications not expressly approved by the party responsible for compliance could void the user's authority to operate the equipment.

#### **Notice 2**

Shielded interface cables and A.C. power cord, if any, must be used in order to comply with the emission limits.

**VOIR LA NOTICE D'INSTALLATION AVANT DE RACCORDER  
AU RESEAU.**

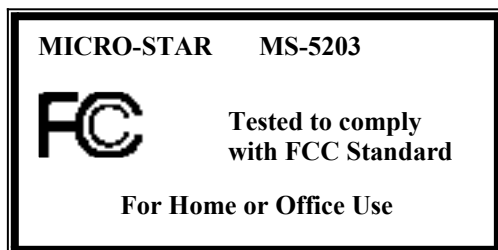

## **Edition**

October 1999

## **Copyright Notice**

The material in this document is the intellectual property of **MICRO-STAR INTERNATIONAL**. We take every care in the preparation of this document, but no guarantee is given as to the correctness of its contents. Our products are under continual improvement and we reserve the right to make changes without notice.

## **Trademarks**

All trademarks used in this manual are the property of their respective owners.

Intel and Pentium are registered trademarks of Intel Corporation.

PS/2 and OS/2 are registered trademarks of IBM Corporation.

Windows 95 and Windows NT are registered trademarks of Microsoft.

Netware is a registered trademark of Novell.

Award is a registered trademark of Award Software Inc.



**CAUTION:** Danger of explosion if battery is incorrectly replaced. Replace only with the same or equivalent type recommended by the manufacturer.

## **Safety Instructions**

1. Always read the safety instructions carefully.
2. Keep this User's Manual for future reference.
3. Keep this equipment away from humidity.
4. Lay this equipment on a reliable flat surface before setting it up.
5. The openings on the enclosure are for air convection hence protects the equipment from overheating. **DO NOT COVER THE OPENINGS.**
6. Make sure the voltage of the power source and adjust properly 110/220V before connecting the equipment to the power inlet.
7. Place the power cord such a way that people can not step on it. Do not place anything over the power cord.
8. Always Unplug the Power Cord before inserting any add-on card or module.
9. All cautions and warnings on the equipment should be noted.
10. Never pour any liquid into the opening that could damage or cause electrical shock.
11. If any of the following situations arises, get the equipment checked by a service personnel:
  - The power cord or plug is damaged
  - Liquid has penetrated into the equipment
  - The equipment has been exposed to moisture
  - The equipment has not work well or you can not get it work according to User's Manual.
  - The equipment has dropped and damaged
  - If the equipment has obvious sign of breakage
12. **DO NOT LEAVE THIS EQUIPMENT IN AN ENVIRONMENT UNCONDITIONED, STORAGE TEMPERATURE ABOVE 60<sup>0</sup>C (140<sup>0</sup>F), IT MAY DAMAGE THE EQUIPMENT.**

## Table of Contents

### Overview

<b>Chapter 1 MS-5203 CHASSIS INSTALLATION GUIDE</b>	1-1
Overview-----	1-1
Installation Tools-----	1-1
Screw-----	1-1
Front Panel Overview-----	1-2
Installation Procedures-----	1-4
<b>Chapter 2 MS-5186 Mainboard Introduction</b>	2-1
Features -----	2-2
Layout-----	2-5
<b>Chapter 3 Hardware Installation</b>	3-1
Central Processing Unit: CPU-----	3-1
CPU Installation Procedures-----	3-1
CPU Core Speed Derivation Procedures-----	3-2
Processor Voltage Setting-----	3-3
CPU Speed and Voltage Setting: SW1 & JV1-----	3-5
CPU Fan Connector: CFAN1-----	3-10
Clear CMOS Jumper: JBAT1-----	3-11

Memory Installation-----	3-12
Memory Bank Configuration-----	3-12
Memory Installation Procedures-----	3-13
Memory Population Rules-----	3-14
Case Connector : JFP1-----	3-15
Floppy Disk Connector: FDD-----	3-17
Hard Disk Connectors: IDE1 & IDE2-----	3-18
ATX 20-pin Power Connector-----	3-19
Remote Power On/Off Switch: JRMS1-----	3-20
Serial Port Connectors: COM 1 & COM 2-----	3-21
VGA DB 15 Pin Connector -----	3-22
S-Out and AV-Out Connector-----	3-23
Parallel Port Connector: LPT-----	3-24
Mouse and Keyboard Connector: JMS1/JKB1-----	3-25
Audio Port Connector-----	3-26
LAN Connector-----	3-27
Infrared Module Connector: IR(Sound 1)-----	3-28
USB Connector: USB1-----	3-29
Wake-Up on LAN Connector: JWOL1-----	3-30
Modem Wake Up Connector: JMDM1-----	3-31

Modem-In: JTAD1-----	3-32
AUX Line In Connector: JAUX1-----	3-33
CD-In Connector: JCD1-----	3-34
Front Panel Sound Connector: SOUND1-----	3-35
Case Speaker Connector: JSPL/JSPR-----	3-36
<b>Chapter 4 AWARD® BIOS SETUP</b>	4-1
Entering Setup-----	4-2
Getting Help-----	4-2
The Main Menu-----	4-3
Standard CMOS Setup-----	4-5
BIOS Features Setup-----	4-8
Chipset Features Setup-----	4-13
Power Management Setup-----	4-17
PnP/PCI Configuration Setup-----	4-22
Load Setup Defaults-----	4-26
Special Features Setup (optional)-----	4-27
Integrated Peripherals-----	4-29
Supervisor/User Password Setting-----	4-34
IDE HDD Auto Detection-----	4-35

<b>Chapter 5 VIA Chipset Driver</b>	5-1
Overview-----	5-1
Driver Setup & Usage Procedures for Windows® 98-----	5-3
Windows® NT 4.0-----	5-6
<b>Chapter 6 REALTEK® 8139B Fast Ethernet Lan Driver</b>	6-1
Overview-----	6-1
Lan Driver Setup-----	6-2
<b>Chapter 7 Multimedia Keyboard (optional)</b>	7-1
Overview-----	7-1
Driver Setup-----	7-2
Multimedia Button Function-----	7-5



---

## OVERVIEW

The MS-5203 is your ultimate home PC experience. It supports everything you need, similar to a desktop computer. With all of the computing capabilities needed are presented in an “all-in-one” platform. The MS-5203 is an all-in-one NetPC solution that support Intel Pentium processor with MMX technology, AMD K6/K6-2/K6-3, and Cyrix 6x86L/6x86MX. It also have a build in rich audio, 3D graphics, and 10/100Ethernet network. Standard Ultimate System Armor II Enhancement utilities software allows you to manage your system with much ease.

The MS-5203 is available in two colors: Black and White. Black 5203 (Panel A) comes with an CIR(Consumer Infrared) wireless keyboard with an optional IR remote control. White 5203 (Panel B) comes with SIR(Slow Infrared) and 2 x 2W speakers, but without wireless keyboard and remote control.

The MS-5203 can be attached to a TV set and be used to access the Internet using an IR wireless keyboard or an IR remote control. (for Panel A only)

This manual will go over the key features of the MS-5203 and the setup instructions.

---

## Chapter 1

### MS-5203 CHASSIS INSTALLATION GUIDE

#### 1. Overview

The MS-5203 is a specially designed chassis for MS-5186 mainboard. The chassis can accommodate one Floppy drive, Hard drive, and Standard CD-ROM. The chassis back panel support LAN, Speaker, PS/2® mouse and keyboard, Printer port, TV-OUT, S\_Out, and VGA port.

#### 2. Installation Tools

Tools you need before you start:

- screw driver (phillips cross head type)
- long nose pliers
- anti-static wrist strap or glove
- user's guide.

#### 3. Screw

Two types of screws are provided by the MS-5203: Flat head screw and Screw w/washer.



Flat Head

This type of screw is used to mount the mainboard into the Case.



Screw w/  
Washer

This type of screw is used to mount the Floppy Drive, CD-ROM Drive.

## 4. Front Panel Overview



5203 A

1	3.5" Floppy Drive
2	Standard CD-ROM Drive
3	Power On/Off Switch
4	Power LED Indicator
5	Hard Disk LED Indicator
6	Network LED Indicator
7	IR Window
8	Microphone Jack
9	Line-In Jack
10	Line-Out Jack
11	USB Ports

---

**Note:** Front Panel (A) comes with Remote Keyboard and Remote Controller(optional).

---

**Warning** Always turn on the monitor before the system. Otherwise, during BIOS post, the display will automatically use TV-out as the default display.

---

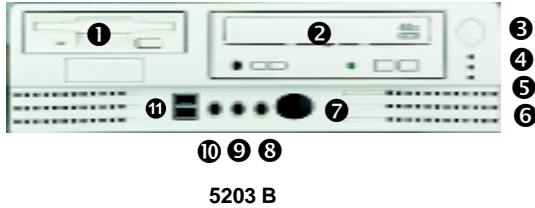

- |    |                         |
|----|-------------------------|
| 1  | 3.5" Floppy Drive       |
| 2  | Standard CD-ROM Drive   |
| 3  | Power On/Off Switch     |
| 4  | Power LED Indicator     |
| 5  | Hard Disk LED Indicator |
| 6  | Network LED Indicator   |
| 7  | IR Window               |
| 8  | Microphone Jack         |
| 9  | Line-In Jack            |
| 10 | Line-Out Jack           |
| 11 | USB Ports               |

**Warning** Always turn on the monitor before the system. Otherwise, during BIOS post, the display will automatically use TV-out as the default display.

---

## 5. Installation Procedures

The Cables used



The Mainboard

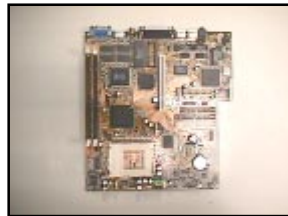

Riser Card

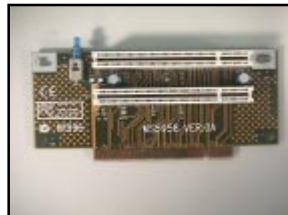

Front Panel Peripheral Connector



1. Remove the screws and open the cover.



2. Release the lock to remove the Front Panel Bezel.



3. Connect the Front Panel Peripheral connector. Secure with screws.



4. Reconnect the Front Panel Bezel



5. Remove the HDD Bracket  
- unscrew from the side.

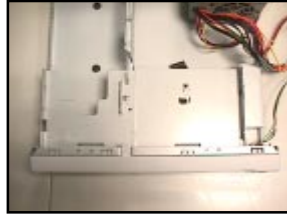

6. Remove the Cage Set  
- remove screws from both side.  
- push upward to unhook.

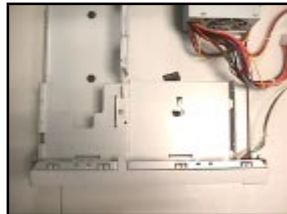

7. Slide the mainboard into the chassis from the left.  
Check for a perfect fit by pushing it toward the chassis' back panel.



8. Secure the mainboard with screws.



9. Install the CPU & CPU fan.



10. Insert DIMM Module.



11. Connect the Game port.



12. Connect COM B & Game Port.





13. Insert the Riser card.  
Secure with screws.



14. HDD Bracket.



15. Secure the Hard Disk into the HDD bracket with screws.



16. Connect the Front Panel switch and LED to the Mainboard. Connect the cable from the Front Panel Peripheral connector to the mainboard too.



17. Connect the Power supply connector.



18. Install the Cage set.  
Then, connect the HDD  
bracket from the side.  
Secure it with a screw.



19. Insert the CD-ROM drive.



20. Secure with screws.



21. Attach the Floppy Drive ear to the Floppy drive.



22. Connect the Floppy Drive into the Cage set.  
Insert Power and Cables (FDD, IDE1, IDE2).



23. Close the chassis cover.  
- secure with screws.



---

**Warning:** Ensure that the voltage setting switch located on the power supply has been set to the right voltage before turning the system on.

---

## Chapter 2

### **MS-5186 MAINBOARD INTRODUCTION**

The LPX VI15 mainboard is a high-performance all-in-one system mainboard. This mainboard supports Intel® Pentium® processor with MMX™ technology, Cyrix®/IBM® 6x86L/6x86MX/MII, AMD® K6/K6-2/K6-III, and IDT Winchip processors.

The mainboard uses the highly integrated Apollo MVP4. The Apollo MVP4 is a PC Socket-7 system logic North Bridge with integrated 2D/3D Graphics Accelerator. The core logic portion of the chip is based on the popular 100MHz VIA Apollo MVP3 chipset with enhanced features and graphics accelerator based on the Cyber9398DVD from Trident Microsystems. The VT82C686A Super I/O PCI integrated Peripheral Controller (PSIPC) is a high integration, high performance, power efficient and high compatibility device that supports Intel and non-Intel based processors plus PCI bus bridge functionality to make a complete Microsoft PC98-compliant PCI/ISA system. The VT82C686A supports PCI-to-ISA bus controller, four USB ports, dual bus-master IDE with Ultra DMA33/66, AC97 Basic Audio, System Hardware Monitoring, and integrated “Super I/O functionality”.

This Mainboard with Apollo MVP4 coupled with VT82C686A is an ideal performance energy efficient, and highly integrated computer systems.

## **2.1 Features**

### **CPU**

- Socket 7 support Intel® Pentium® processor with MMX™ technology.
- The Cyrix® 6x86L/6x86MX, AMD® K6/K6-2/K6-III and IDT™ WinChip processors are also supported.

### **Chipset**

- VIA® VT82C501(MVP4) AGPset. (North Bridge)
  - Support 66/100MHz CPU Bus
  - Support PC100 SDRAM
  - Integrated 2D/3D graphics with 3Dsetup engine
  - HW DVD Acceleration and advanced Video processor
- VIA® VT82C686 chipset. (South Bridge)
  - Support AC-97 basic audio
  - Integrated Super I/O
  - Integrated HW Monitor
  - High Performance Dual Ultra DMA 33/66 IDE ports
  - Advanced power management

### **FSB (Front Side Bus)**

- 66.6/95/100MHz clocks are supported.

### **Main Memory**

- Support four memory banks using two 168-pin unbuffered DIMM.
- Support a maximum memory size of 256MB DIMM.
- Support 3.3v SDRAM DIMM.

### **On-Board IDE**

- An IDE controller on the VIA® VT82686 Chipset provides IDE HDD/CD-ROM with PIO, Bus Master and Ultra DMA 33/66 operation modes.
- Can connect up to four IDE devices.

**On-Board Peripherals**

- On-Board Peripherals include:
  - 1 floppy port supports 2 FDD with 360K, 720K, 1.2M, 1.44M and 2.88Mbytes.
  - 2 serial connectors(COM A + COM B)
  - 1 parallel port supports SPP/EPP/ECP mode
  - 1 USB port
  - 2 IrDA connector for Consumer IR/FIR.
  - 1 Audio port

**Audio**

- Chip Integrated
  - Compliance to AC-97 V2.0 Specification
  - Support Hardware Sound Blaster-Pro and DOS legacy compatible
  - MPU401 MIDI interface

**Video**

- Chip Integrated
  - Integrated 2D/3D graphics with 3Dsetup engine
  - Integrated 230Mhz 32-bit RAMDAC
  - Complete TV-Out solution

**Network**

- Realtek 8139B 10/100M Ethernet
  - WFW baseline & NET PC specs compliant
  - ACPI
  - Magic packet filtering to wake-up on LAN
  - ARP & Flexible frame filtering
  - Software drivers are backwards compatible

**InfraRed**

- Wireless Keyboard (CIR) for Black chassis (Panel A)
- SIR for White chassis (Panel B)

**BIOS**

- The mainboard BIOS provides “Plug & Play” BIOS which detects the peripheral devices and expansion cards of the board automatically.
- The mainboard provides a Desktop Management Interface(DMI) function which records your mainboard specifications.
- ACPI(Advanced Configuration and Power Interface) feature.

**Dimension**

- LPX Form Factor : 25cm(L) x 22.3cm(W) x 4 layers PCB

**Mounting**

- 6 mounting holes.

**System Hardware Monitor**

- CPU Fan Revolution Detect
- CPU Fan Control (the fan will automatically stop when the system enters suspend mode)
- System Voltage Detect
- CPU Overheat Warning.
- Display Actual Current Voltage

**Riser Card**

- Two PCI slots

**Other Features**

- LAN Wake-Up
- Internal/External Modem Wake-Up

## 2.2 Layout

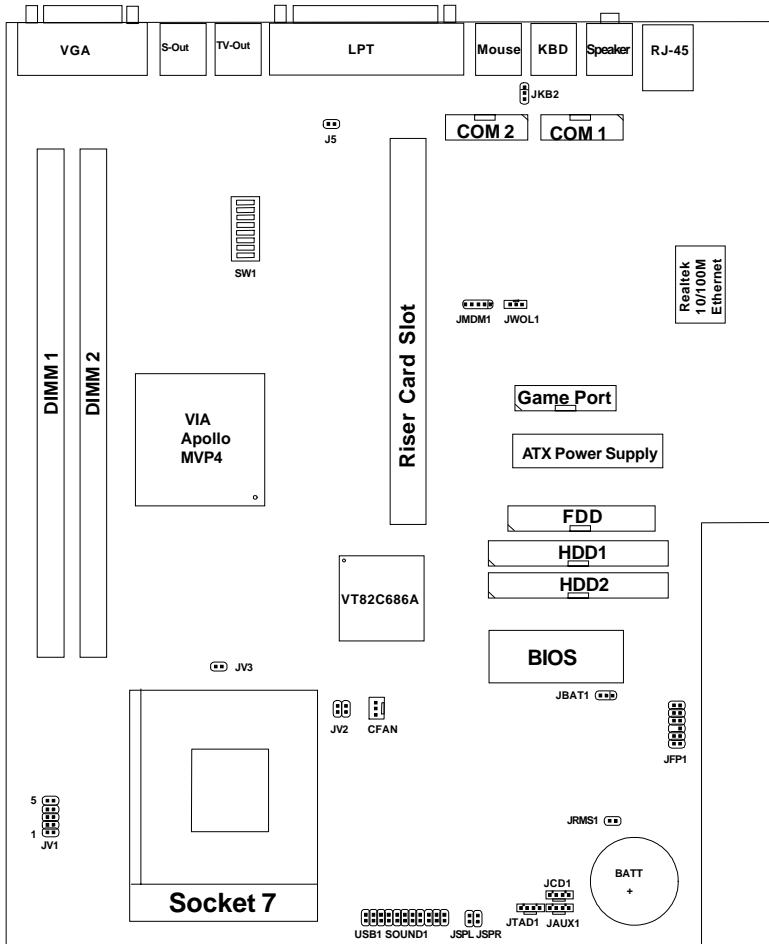

MS-5186 LPX VI15 Mainboard



## Chapter 3

### Hardware Installation

#### 3.1 Central Processing Unit: CPU

The LPX VI15 mainboard operates with Intel® Pentium® processor w/ MMX™ technology, Cyrix®/IBM 6x86L/6x86MX, AMD® K5/K6/K6-2/K6-III and IDT™ Winchip processors. It could operate with 1.8V to 3.52V processors. The mainboard provides a 321-pin ZIF Socket 7 for easy CPU installation. The CPU should always have a cooling fan attached to prevent overheating.

##### 3.1-1 CPU Installation Procedures

1. Pull the lever sideways away from the socket. Then raise the lever up to a 90-degree angle.

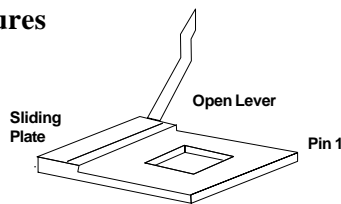

2. Locate Pin 1 in the socket and look for the white dot or cut edge in the CPU. Match Pin 1 with the white dot/cut edge. Then, insert the CPU. It should insert easily.

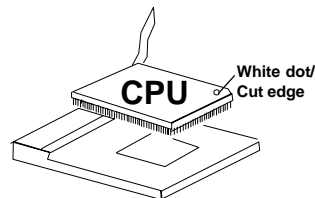

3. Press the lever down to complete the installation.

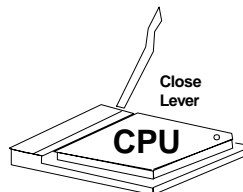

**3.1-2 CPU Core Speed Derivation Procedures**

- The DIP Switch SW1 (1, 2, and 3) are used to set the Core/Bus (Fraction) ratio of the CPU. The actual core speed of the CPU is the Host Clock Frequency multiplied by the Core/Bus ratio. For example:

$$\begin{aligned}
 \text{If } & \text{CPU Clock} & = & 66\text{MHz} \\
 & \text{Core/Bus ratio} & = & 3.5 \\
 \text{then } & \text{CPU core speed} & = & \text{Host Clock} \times \text{Core/Bus ratio} \\
 & & = & 66\text{MHz} \times 3.5 \\
 & & = & 233\text{MHz}
 \end{aligned}$$

SW1			CPU
1	2	3	Core/Bus Ratio
ON	OFF	OFF	2
ON	ON	OFF	2.5
OFF	ON	OFF	3
OFF	OFF	OFF	3.5
ON	OFF	ON	4
ON	ON	ON	4.5
OFF	ON	ON	5
OFF	OFF	ON	5.5

- The DIP Switch SW1 (5, 6, 7, and 8) are used to adjust the CPU clock frequency.

SW1				Clock
5	6	7	8	CPU
OFF	OFF	OFF	OFF	60
ON	OFF	OFF	OFF	66
OFF	OFF	OFF	ON	75
ON	OFF	ON	OFF	83.3
OFF	ON	ON	OFF	95
ON	ON	ON	OFF	100

**3.1-3 Processor Voltage Setting**

The Jumper Switch JV1 is used to set the processor voltage setting.

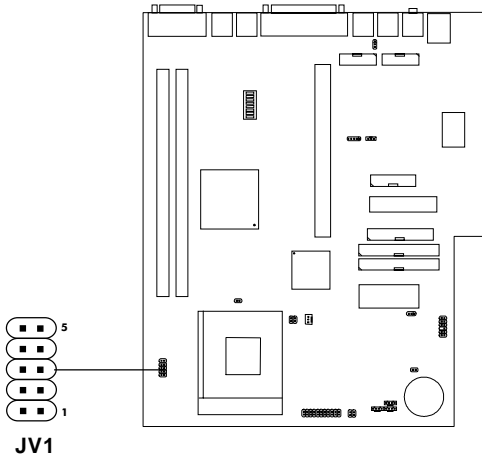

<b>JV1</b>					
<b>1</b>	<b>2</b>	<b>3</b>	<b>4</b>	<b>5</b>	<b>Vcore</b>
OPEN	SHORT	OPEN	OPEN	OPEN	2.2
SHORT	SHORT	OPEN	OPEN	OPEN	2.3
OPEN	OPEN	SHORT	OPEN	OPEN	2.4
OPEN	SHORT	SHORT	OPEN	OPEN	2.5
OPEN	OPEN	OPEN	SHORT	OPEN	2.8
SHORT	OPEN	OPEN	SHORT	OPEN	2.9
OPEN	OPEN	SHORT	SHORT	OPEN	3.2
SHORT	SHORT	SHORT	SHORT	OPEN	3.5

---



**Note:** Always consult vendor for proper CPU specification, before setting the processor voltage ( $V_{core}/V_{io}$ ). Improper setting may damage the processor and other components.

---

**a. Processor Single/Dual Voltage Setting: JV2/JV3**

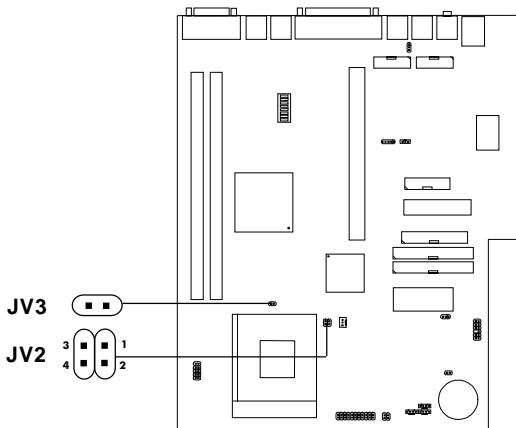
CPU comes with single or dual voltage. Ask vendor for CPU setting and set accordingly.

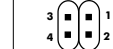

JV3	JV2	Voltage
		<b>Single Voltage</b>
		<b>Dual Voltage (default)</b>





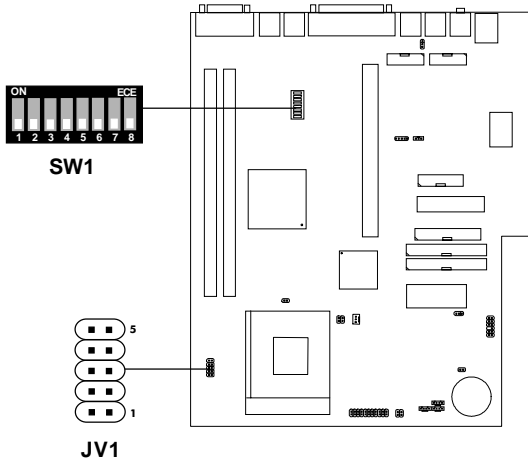

**3.1-4 CPU Speed and Voltage Setting: SW1 & JV1**

To adjust the speed and voltage of the CPU, you must know the specifications of your CPU (*always ask the vendor for CPU specifications*). Then refer to **Table 2.1 (Intel® processors)**, **Table 2.2 (Cyrix® processors)** and **Table 2.3 (AMD® processors)** for proper setting.

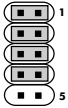
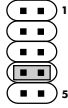







**Table 3.1 Intel® processors**

**Intel® Pentium® processors**

CPU Type	CPU Speed & Voltage					
	V/I/O	V/core	JV1	JV2	JV3	SW1
100MHz	3.5					
133MHz						
166MHz						
200MHz						

**Intel® Pentium® processors with MMX™ technology**









166MHz	3.3	2.8				
200MHz						
233MHz						

**Note:** If you encounter a CPU with different voltage, just go to Section 2.1-3 and look for the proper voltage settings.

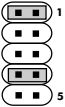





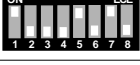



**Table 3.2 Cyrix® processors**

Cyrix® 6x86 processor uses PR to rate the speed of their processors based on Intel® Pentium® processor core speed. For example PR150 (120MHz) has 150MHz core speed of Intel® Pentium® processor but has 120MHz core speed in Cyrix®. Cyrix® 6x86 processor should always use a more powerful fan (ask vendor for proper cooling fan).







**Cyrix® 6x86L processors**

CPU Type	CPU Speed & Voltage					
	VIO	Vcore	JV1	JV2	JV3	SW1
6x86L PR166	3.4	2.8				
6x86L PR200						

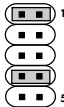
Cyrix® 6x86MX Processor

CPU Type	CPU Voltage					CPU Speed
	VI/O	Vcore	JV1	JV2	JV3	SW1
PR200 (66 x 2.5)	3.3	2.9				
PR233 (75 x 2.5)						
(66 x 3)						
(83 x 2)						
PR266 (75 x3)						
(66 x 3.5)						
(83 x 2.5)						

Cyrix® MII Processor

CPU Type	CPU Voltage					CPU Speed
	VI/O	Vcore	JV1	JV2	JV3	SW1
PR300 (66 x 3.5)	3.3	2.9				
(75 x 3)						
PR333 (83 x 3)						

**Note:** If you encounter a CPU with different voltage, just go to **Section 2.1-3** and look for the proper voltage settings.



**Table 3.3 AMD® Processor**

**AMD® K6/K6-2/K6-3 Processor**

CPU Type	CPU Voltage					CPU Speed					
	VI/O	Vcore	JV1	JV2	JV3	SW1					
166MHz	3.3	2.9									
200MHz											
233MHz	3.3	3.2									
266MHz	3.3	2.2									
300MHz											
K6-2 300MHz											
K6-2 333MHz											
K6-2 350MHz											
K6-2 380MHz											
K6-2 400MHz											
K6-2 450MHz						3.3	2.4				
K6-III 400MHz											
K6-III 450MHz											

### 3.1-5 CPU Fan Connector: CFAN1

This connector supports fan with +12V. When connecting the wire to the connector, always take note that the red wire is the positive and should be connected to the +12V pin and the black one to GND.

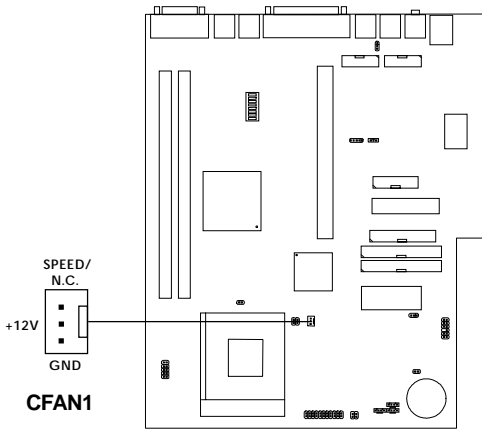



**Note:** Always consult vendor for proper CPU cooling fan.

---

### 3.2 Clear CMOS Jumper: JBAT1

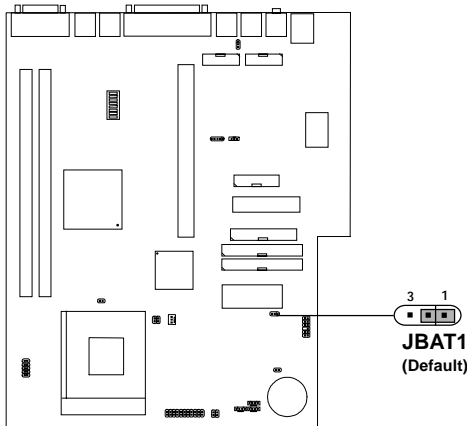
A battery must be used to retain the mainboard configuration in CMOS RAM. To retain the on-board battery you must always short pins 1-2 of JBAT1.



JBAT1	Function
	<p><b>Keep Data</b></p>
	<p><b>Clear Data</b></p>

**Note:** You can clear CMOS by shorting 2-3 pin, while the system is off. Leave for about 5 to 10 seconds. Then, return to 1-2 pin position. Avoid clearing the CMOS while the system is on for it will damage the mainboard. Always unplug the power cord from the wall socket.

## 3.3 Memory Installation

### 3.3-1 Memory Bank Configuration

The mainboard provides two unbuffered 168-pin DIMM(Double In-Line Memory) sockets. It supports four memory banks for a maximum of 256MB memory. Each bank supports up to 128MB memory. You can use DIMM from 8, 16, 32, 64, to 128MB.

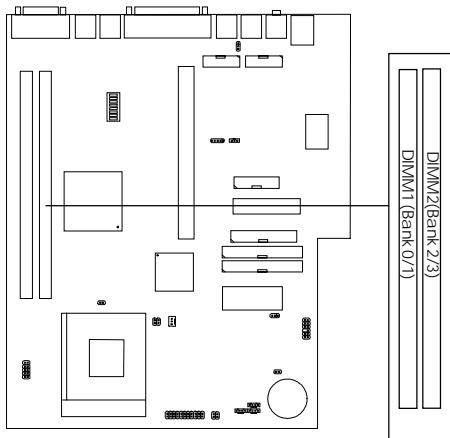

There are two kinds of DIMM specification supported by this mainboard: PC100 and PC66. 100MHz CPU Bus Frequency processor can only be used with PC100 or Higher(PC133) DIMM.

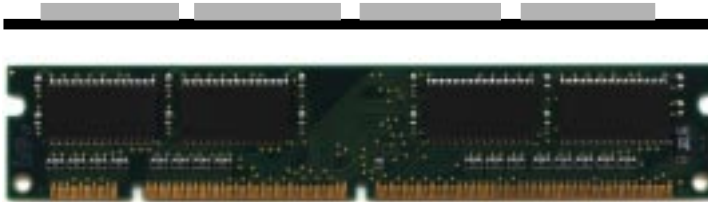
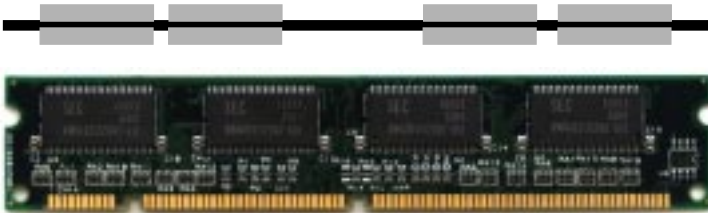
**3.3-2 Memory Installation Procedures:****b. How to install a DIMM Module****Single Sided DIMM****Double Sided DIMM**

1. The DIMM slot has two Notch Key called “VOLT and DRAM”, so the DIMM memory module can only fit in one direction.
2. Insert the DIMM memory module vertically into the DIMM slot. Then, push it in.

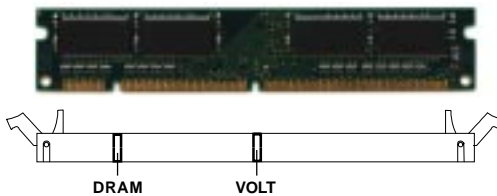

3. Close the plastic clip at the side of the DIMM slot.

**3.3-3 Memory Population Rules**

1. To operate properly, at least one 168-pin DIMM module must be installed.
2. This mainboard supports Table Free memory, so memory can be installed on (DIMM1) or (DIMM2) in any order.
3. Use only 3.3v DIMM memory module.

### 3.4 Case Connector: JFP1

The Power Switch, Reset Switch, Power LED, LAN LED and HDD LED are all connected to the JFP1 connector block.

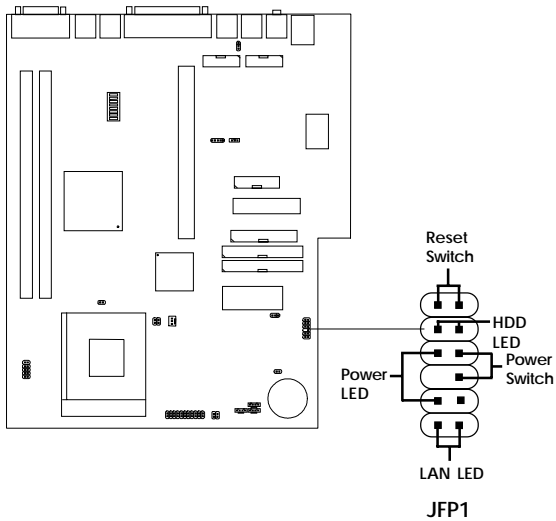

### **3.4-1 Power Switch**

Connect to a 2-pin push button switch. This switch had the same feature with JRMS1.

### **3.4-2 Reset Switch**

Reset switch is used to reboot the system rather than turning the power ON/OFF. Avoid rebooting while the HDD LED is lit. You can connect the Reset switch from the system case to this pin.

### **3.4-3 Power LED**

The Power LED is lit while the system power is on. You can connect the Power LED from the system case to this pin. When the system enters suspend mode, the power LED will blink. (see Power Saving LED Connector: JGL1)

### **3.4-4 HDD LED**

HDD LED shows the activity of a hard disk drive. Avoid turning the power off while the HDD led is lit. You can connect the HDD LED from the system case to this pin.

### **3.4-5 LAN LED**

This can be connected with LED that will shows any activity on your network.



### 3.5 Floppy Disk Connector: FDD

The mainboard also provides a standard floppy disk connector FDD that supports 360K, 720K, 1.2M, 1.44M and 2.88M floppy disk types. You can attach a floppy disk cable directly to this connector.

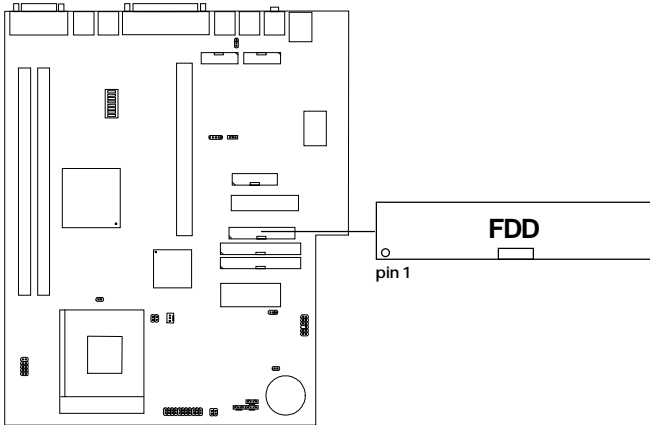

### 3.6 Hard Disk Connectors: IDE1 & IDE2

The mainboard has a 32-bit Enhanced PCI IDE Controller that provides for two HDD connectors IDE1 (primary) and IDE2 (secondary). You can connect up to four hard disk drives, CD-ROM, 120MB Floppy (reserved for future BIOS) and other devices to IDE1 and IDE2.

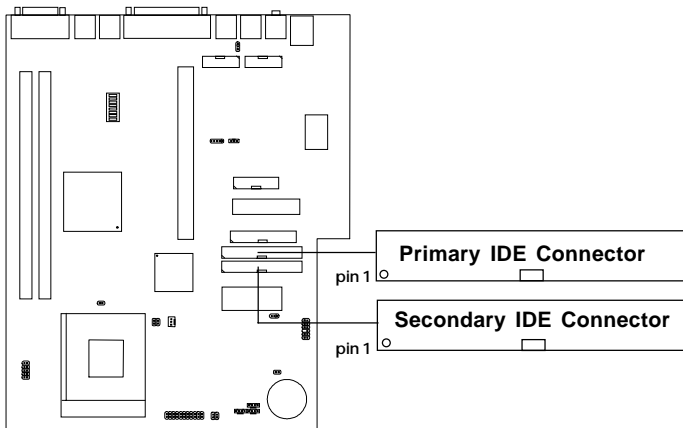

#### IDE1(primary IDE connector)

The first hard disk should always be connected to IDE1. IDE1 can connect a Master and a Slave drive.

#### IDE2(secondary IDE connector)

IDE2 can connect a Master and a Slave drive.

**3.7 ATX 20-pin Power Connector**

This type of connector already supports the remote ON/OFF function. However, you need to connect the **Remote Power On/OFF switch (JRMS1)**.

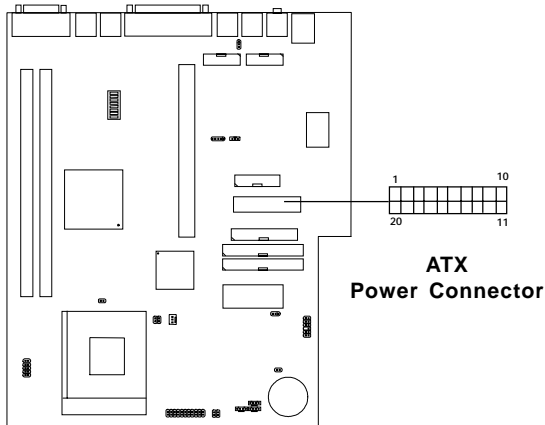

**PIN DEFINITION**

<b>PIN</b>	<b>SIGNAL</b>	<b>PIN</b>	<b>SIGNAL</b>
1	3.3V	11	3.3V
2	3.3V	12	-12V
3	GND	13	GND
4	5V	14	PS_ON
5	GND	15	GND
6	5V	16	GND
7	GND	17	GND
8	PW_OK	18	-5V
9	5V_SB	19	5V
10	12V	20	5V

**3.7-1 Remote Power On/Off Switch: JRMS1**

Connect to a 2-pin push button switch. During OFF state, press once and the system turns on. **During ON stage, push once and the system goes to sleep mode: pushing it more than 4 seconds will change its status from ON to OFF.** If you want to change the setup, you could go to the BIOS Power Management Setup. This is only used for ATX type power supply.

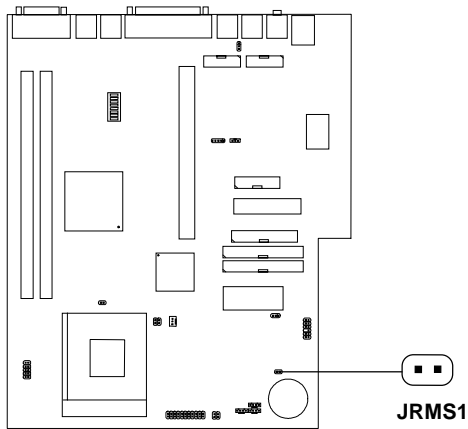

### **3.8 Serial Port Connectors: COM 1 & COM 2**

The mainboard provides two serial port (COM 1 and COM 2) connectors. These two connectors are 16550A high speed communication ports that send/receive 16 bytes FIFOs. You can attach a mouse or a modem cable directly into these connectors.

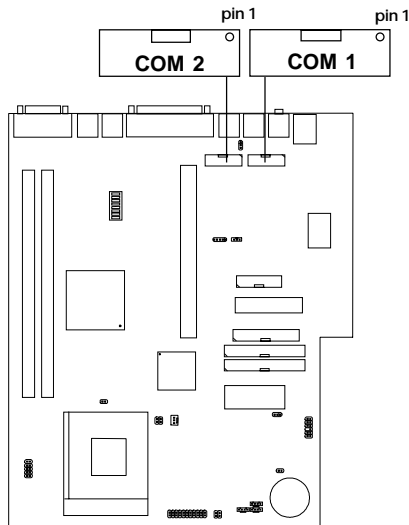

### 3.9 VGA DB 15 Pin Connector

The mainboard provides a DB 15-pin connector to connect to a VGA monitor.

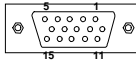

**VGA**

<b>Analog Video Display Connector(DB15-S)</b>	
<b>Pin</b>	<b>Signal Description</b>
1	Red
2	Green
3	Blue
4	Not used
5	Ground
6	Ground
7	Ground
8	Ground
9	Not used
10	Ground
11	Not used
12	SDA
13	Horizontal Sync
14	Vertical Sync
15	SCL

### 3.10 S-Out and AV-Out Connector

The mainboard provides two TV-Out Connector: S-Out and AV-Out. This mainboard can only support one monitor, either PC monitor or TV-Out at a time, but not at the same time.

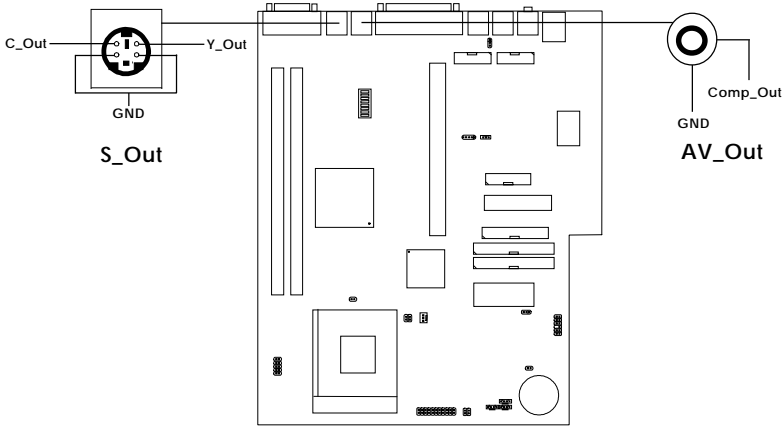

**Note:** If you want to use TV-Out, you need to remove the PC monitor cable and connect the TV before turning on the system. If not, then the PC Monitor will still be your monitor.

**3.11 Parallel Port Connector: LPT**

The mainboard provides a 25 pin female centronic connector for LPT. A parallel port is a standard printer port that also supports Enhanced Parallel Port(EPP) and Extended capabilities Parallel Port(ECP). See connector and pin definition below:

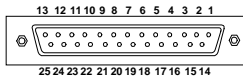

**LPT**

**PIN DEFINITION**

<b>PIN</b>	<b>SIGNAL</b>	<b>PIN</b>	<b>SIGNAL</b>
1	STROBE	14	AUTO FEED#
2	DATA0	15	ERR#
3	DATA1	16	INIT#
4	DATA2	17	SLIN#
5	DATA3	18	GND
6	DATA4	19	GND
7	DATA5	20	GND
8	DATA6	21	GND
9	DATA7	22	GND
10	ACK#	23	GND
11	BUSY	24	GND
12	PE	25	GND
13	SELECT		



### 3.12 Mouse Connector: JMS1

The mainboard provides a standard PS/2<sup>®</sup> mouse mini DIN connector for attaching a PS/2<sup>®</sup> mouse. You can plug a PS/2<sup>®</sup> mouse directly into this connector. The connector location and pin definition are shown below:

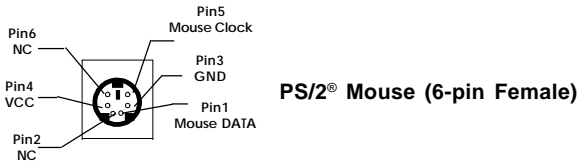

### 3.13 Keyboard Connector: JKB1

The mainboard provides a standard PS/2<sup>®</sup> keyboard mini DIN connector for attaching a keyboard. You can plug a keyboard cable directly into this connector.

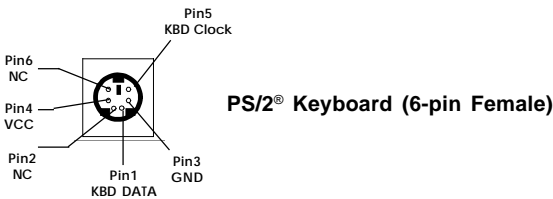

### **3.14 Audio Port Connector**

**Speaker** is a connector for Speakers or Headphones.



#### **1/8" Stereo Audio Connector**

### 3.15 LAN Connector

The mainboard provides a RJ-45 connector for your network need.

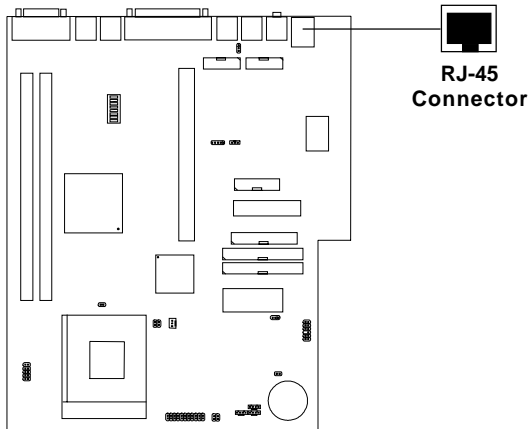

**3.16 Infrared Module Connector: IR (Sound1)**

The mainboard provides a 4-pin infrared connector(IR) for IR module. This connector is for optional wireless transmitting and receiving infrared module. If you want to use this function, you must configure the setting through BIOS setup.

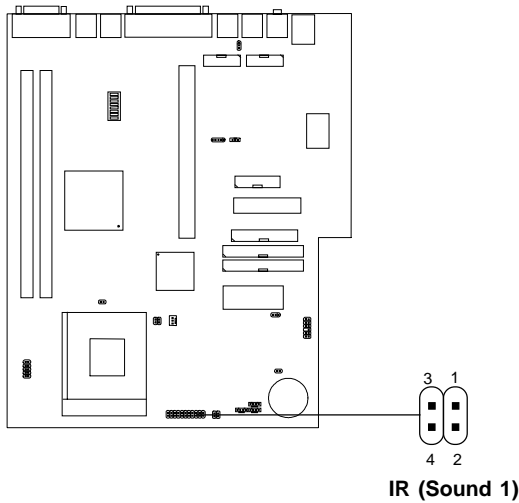

PIN	SIGNAL	DESCRIPTION
1	IRRX	IRRX
2	IRTX	IRTX
3	CIR	Consumer IR
4	5VSB	5V Stand By

**3.17 USB Connector: USB1**

Connect a USB cable to support USB device, such as keyboard and mouse.

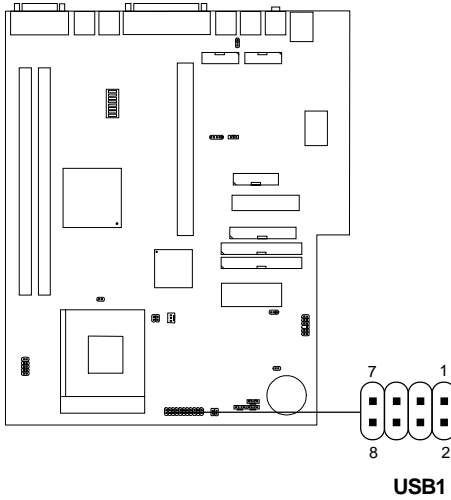

PIN	SIGNAL	DESCRIPTION
1	VCC	+5V
2	VCC	+5V
3	-Data 0	Negative Data Channel 0
4	-Data 1	Negative Data Channel 1
5	+Data 0	Positive Data Channel 0
6	+Data 1	Positive Data Channel 1
7	GND	Ground
8	GND	Ground

**USB Port Description**

### 3.18 Wake-Up on LAN Connector: JWOL1

The JWOL1 connector is for use with LAN add-on cards that supports Wake Up on LAN function.

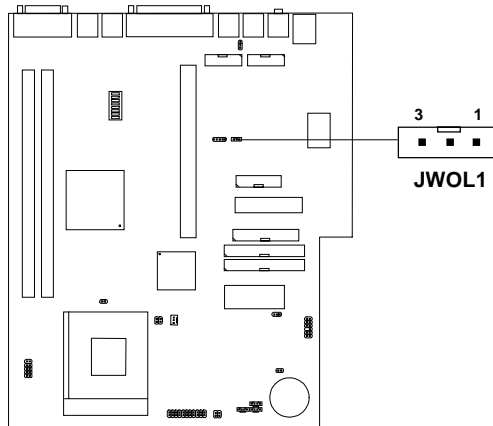

PIN	SIGNAL
1	5VSB
2	GND
3	MP_WAKEUP

**Note:** LAN wake-up signal is active “high”.

**Note:** To be able to use this function, you need a power supply that provide enough power for this feature.  
(power supply with 750 mA 5V Stand-by)

### 3.19 Modem Wake Up Connector: JMDM1

The JMDM1 connector is for use with Modem add-on card that supports the Modem Wake Up function.

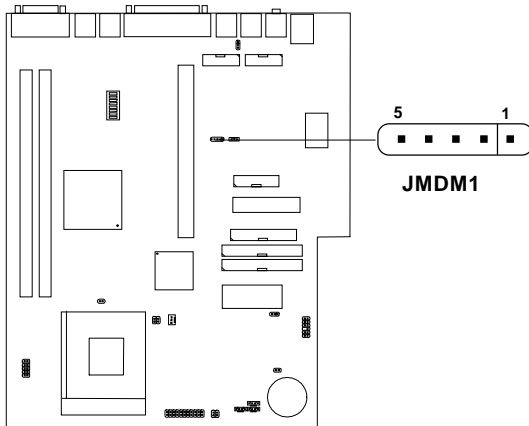

PIN	SIGNAL
1	NC
2	GND
3	MDM_WAKEUP
4	NC
5	5VSB

**Note:** Modem wake-up signal is active “low”.

**Note:** To be able to use this function, you need a power supply that provide enough power for this feature.  
(power supply with 750mA 5V Stand-by)

### 3.20 Modem-In: JTAD1

The connector is for Modem with internal voice connector.

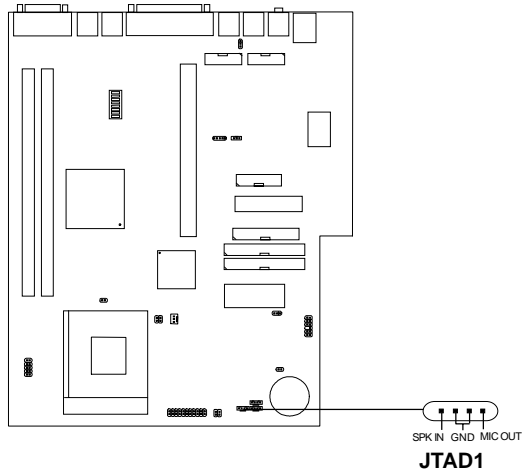

SPK\_IN is connected to the Modem Speaker Out connector.

MIC\_OUT is connected to the Modem Microphone In connector.



### **3.21 AUX Line In Connector: JAUx1**

This connector is used for DVD Add on Card with Line In connector.

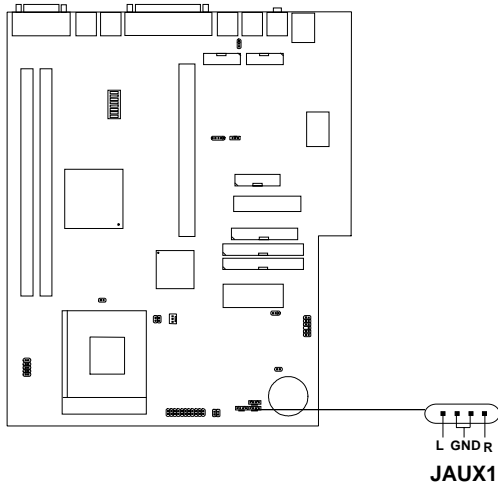

### **3.22 CD-In Audio Connector: JCD1**

This connector is for CD-ROM with internal voice connector.

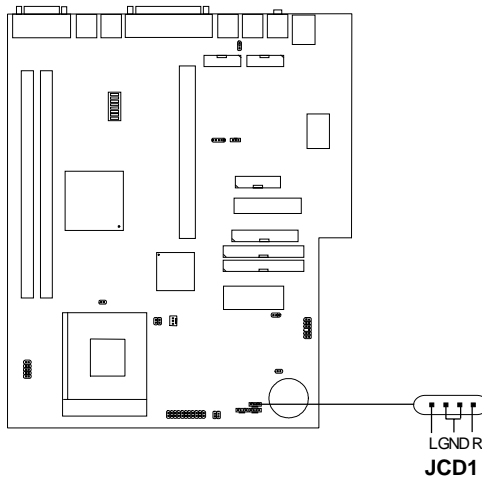

**3.23 Front Panel Sound Connector: SOUND1**

Connect the Front Panel Bezel audio into this connector.

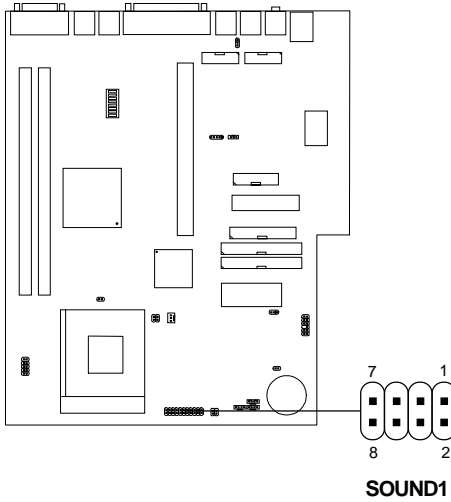

<b>PIN</b>	<b>SIGNAL</b>	<b>DESCRIPTION</b>
1	Line-In L	Line-In Left side
2	MIC In	Microphone In
3	Line-In R	Line-In Right side
4	NC	No Connection
5	Line-Out L	Line-Out Left side
6	Speaker L	Speaker Left side
7	Line-Out R	Line-Out Right side
8	Speaker R	Speaker Right side

### **3.24 Case Speaker Connector: JSPL/JSPR**

These connectors are used for case with built-in speaker. JSPL is left side speaker connector, while JSPR is right side speaker connector.

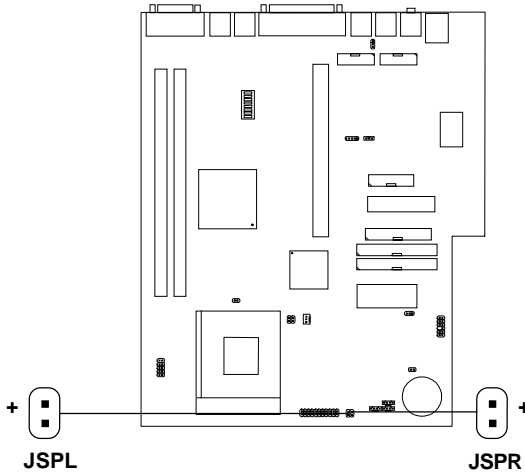

## **Chapter 4**

### **AWARD® BIOS SETUP**

Award® BIOS ROM has a built-in Setup program that allows users to modify the basic system configuration. This type of information is stored in battery-backed RAM (CMOS RAM), so that it retains the Setup information when the power is turned off.

## **4.1 Entering Setup**

Power on the computer and press <Del> immediately to allow you to enter Setup. The other way to enter Setup is to power on the computer. When the below message appears briefly at the bottom of the screen during the POST (Power On Self Test), press <Del> key or simultaneously press <Ctrl>, <Alt>, and <Esc> keys.

PRESS <DEL> TO ENTER SETUP, <ESC> TO SKIP MEMORY TEST

If the message disappears before you respond and you still wish to enter Setup, restart the system to try again by turning it OFF then ON or pressing the “RESET” button on the system case. You may also restart by simultaneously pressing <Ctrl>, <Alt>, and <Delete> keys. If you do not press the keys at the correct time and the system does not boot, an error message will be displayed and you will again be asked to:

PRESS <F1> TO CONTINUE, <DEL> TO ENTER SETUP

## **4.2 Getting Help**

### **Main Menu**

The on-line description of the highlighted setup function is displayed at the bottom of the screen.

### **Status Page Setup Menu/Option Page Setup Menu**

Press F1 to pop up a small help window that describes the appropriate keys to use and the possible selections for the highlighted item. To exit the Help Window, press <F1> or <Esc>.

### 4.3 The Main Menu

Once you enter Award® BIOS CMOS Setup Utility, the Main Menu (Figure 1) will appear on the screen. The Main Menu allows you to select from eleven setup functions and two exit choices. Use arrow keys to select among the items and press <Enter> to accept or enter the sub-menu.

```
ROM PCI/ISA BIOS (2A5LEM4F)
CMOS SETUP UTILITY
AWARD SOFTWARE, INC.
```

STANDARD CMOS SETUP	SPECIAL FEATURES SETUP
BIOS FEATURES SETUP	INTEGRATED PERIPHERALS
CHIPSET FEATURES SETUP	SUPERVISOR PASSWORD
POWER MANAGEMENT SETUP	USER PASSWORD
PNP/PCI CONFIGURATION	IDE HDD AUTO DETECTION
LOAD SETUP DEFAULTS	SAVE & EXIT SETUP
	EXIT WITHOUT SAVING
Esc : Quit	
↑↓→← : Select Item	
F10 : Save & Exit Setup (Shift)F2 : Change Color	
Time, Date, Hard Disk Type...	

#### Standard CMOS Setup

This setup page includes all the items in a standard compatible BIOS.

#### BIOS Features Setup

This setup page includes all the items of Award special enhanced features.

**Chipset Features Setup**

This setup page includes all the items of chipset special features.

**Power Management Setup**

This category determines the power consumption for system after setting the specified items. Default value is Disable.

**PCI Configuration Setup**

This category specifies the IRQ level for PCI and ISA devices.

**Load Setup Defaults**

Chipset defaults indicates the values required by the system for the maximum performance.

**Special Features Setup**

This function is reserved for System Hardware Monitor.

**Integrated Peripherals**

Change, set, or disable onboard I/O, IRQ, and DMA assignement.

**Supervisor Password/User Password**

Change, set or disable password. This function allows the user access to the system and setup or just setup.

**IDE HDD Auto Detection**

Automatically configure hard disk parameters.

**Save & Exit Setup**

Save CMOS value changes to CMOS and exit setup.

**Exit Without Saving**

Abandon all CMOS value changes and exit setup.



## 4.4 Standard CMOS Setup

The items in Standard CMOS Setup Menu are divided into 10 categories. Each category includes “no”, “one” or “more than one setup items”. Use the arrow keys to highlight the item and then use the <PgUp> or <PgDn> keys to select the value you want in each item.

ROM PCI/ISA BIOS (2A5LEM4F)  
STANDARD CMOS SETUP  
AWARD SOFTWARE, INC.

Date(mm:dd:yy): Fri, Feb 28,1997							
Time(hh:mm:ss): 00:00:00							
HARD DISKS	TYPE	SIZE	CYLS	HEADS	PRECOMP	LANDZONE	SECTOR MODE
Primary Master:	Auto	0	0	0	0	0	AUTO
Primary Slave :	Auto	0	0	0	0	0	AUTO
Secondary Master :	Auto	0	0	0	0	0	AUTO
Secondary Slave :	Auto	0	0	0	0	0	AUTO
Drive A :	1.44M,3.5in.			Base Memory:		640K	
Drive B :	None			Extended Base Memory:		15360K	
Video :	EGA/VGA			Other Memory:		384K	
Halt On :	All, but Keyboard			Total Memory:		16384K	
ESC : Quit      ↑↓→← : Select Item      PU/PD/+/- : Modify F1 : Help      (Shift)F2 : Change Color							

**Date**

The date format is <day><month> <date> <year>.

<b>Day</b>	Day of the week, from Sun to Sat, determined by BIOS. Read-only.
<b>month</b>	The month from Jan. through Dec.
<b>date</b>	The date from 1 to 31 can be keyed by numeric function keys.
<b>year</b>	The year, depends on the year of the BIOS

**Time**

The time format is <hour> <minute> <second>.

**PrimaryMaster/PrimarySlave  
SecondaryMaster/Secondary Slave**

These categories identify the types of 2 channels that have been installed in the computer. There are 45 pre-defined types and 4 user definable types for Enhanced IDE BIOS. Type 1 to Type 45 are pre-defined. Type User is user-definable.

Press PgUp/<+> or PgDn/<-> to select a numbered hard disk type or type the number and press <Enter>. Note that the specifications of your drive must match with the drive table. The hard disk will not work properly if you enter improper information for this category. If your hard disk drive type is not matched or listed, you can use Type User to define your own drive type manually.

If you select Type User, related information is asked to be entered to the following items. Enter the information directly from the keyboard and press <Enter>. This information should be provided in the documentation from your hard disk vendor or the system manufacturer.

If the controller of HDD interface is ESDI, the selection shall be  
“Type 1”.

If the controller of HDD interface is SCSI, the selection shall be  
“None”.

If the controller of HDD interface is CD-ROM, the selection shall be  
“None”.

<b>CYLS.</b>	number of cylinders
<b>HEADS</b>	number of heads
<b>PRECOMP</b>	write precom
<b>LANDZONE</b>	landing zone
<b>SECTORS</b>	number of sectors
<b>MODEHDD</b>	access mode

## 4.5 BIOS Features Setup

ROM PCI/ISA BIOS (2A5LEM4F)  
 BIOS FEATURES SETUP  
 AWARD SOFTWARE, INC.

Anti-Virus Protection	: Disabled	Video BIOS Shadow	: Enabled
CPU Internal Cache	: Enabled	C8000-CBFFF Shadow	: Disabled
External Cache	: Enabled	CC000-CFFFF Shadow	: Disabled
Quick Power on Self Test	: Enabled	D0000-D3FFF Shadow	: Disabled
Boot From LAN First	: Disabled	D4000-D7FFF Shadow	: Disabled
Boot Sequence	: A,C,SCSI	D8000-DBFFF Shadow	: Disabled
Swap Floppy Drive	: Disabled	DC000-DFFFF Shadow	: Disabled
Boot up Floppy Seek	: Enabled		
Boot up NumLock status	: On		
Gate A20 Option	: Fast		
Security Option	: Setup		
PCI/VGA palette snoop	: Disabled		
OS select for DRAM>64MB	: Non-OS2		
Report No FDD For WIN 95	: No		
		Esc : Quit    ↑↓→← : Select item F1 : Help PU/PD/+/- : modify F5 : Old Value(Shift) F2 : Color F7 : Load Setup Defaults	

### Anti-Virus Protection

During and after the system boots up, any attempt to write to the boot sector or partition table of the hard disk drive will halt the system and the following error message will appear. For the meantime, you can run an anti-virus program to locate the problem. The settings are Enabled or Disabled.

#### **!WARNING!**

Disk Boot Sector is to be modified  
 Type "Y" to accept write or "N" to abort write  
 Award Software, Inc.

<b>Disabled</b> (default)	No warning message to appear when anything attempts to access the boot sector or hard disk partition table.
<b>Enabled</b>	Activates automatically when the system boots up causing a warning message to appear when anything attempts to access the boot sector of hard disk partition table.

**Note:** *This function is available only for DOS and other OS that do not trap INT13.*

### **CPU Internal Cache**

The default value is Enabled. If your CPU is without Internal Cache then this item “CPU Internal Cache” will not be shown.

<b>Enabled</b> (default)	Enable cache
<b>Disabled</b>	Disable cache

**Note:** The internal cache is built in the processor.

### **CPU External Cache**

Choose Enabled (default) or Disabled. This option enables the level 2 cache memory.

### **Quick Power On Self Test**

This category speeds up Power On Self Test (POST) after you power on the computer. If this is set to Enabled, BIOS will shorten or skip some check items during POST.

<b>Enabled</b> (default)	Enable quick POST
<b>Disabled</b>	Normal POST

### **Boot From LAN First**

During Enabled, if there’s a LAN card Onboard, the booting priority will be from the LAN card. The default setting is Enabled.

---

**Boot Sequence**

This category determines which drive the computer searches first for the disk operating system (i.e., DOS). The settings are A,C,SCSI/C,A,SCSI/C,CD-ROM,A/CD-ROM,C,A/D,A,SCSI/E,A,SCSI/F,A,SCSI/SCSI,A,C/SCSI,C,A/C only, LS/ZIP,C. Default value is A, C, SCSI.

**Swap Floppy Drive**

Switches the floppy disk drives between being designated as A and B. Default is Disabled.

**Boot Up Floppy Seek**

During POST, BIOS will determine if the floppy disk drive installed is 40 or 80 tracks. 360K type is 40 tracks while 720K, 1.2M, and 1.44M are all 80 tracks.

**Enabled**(default) BIOS searches for floppy disk drive to determine if it is 40 or 80 tracks. Take note that BIOS can not tell from 720K, 1.2M , or 1.44M drive type as they are all 80 tracks.

**Disabled** BIOS will not search for the type of floppy disk drive by track number. There will be no warning message if the drive installed is 360K.

**Boot Up NumLock Status**

The default value is On.

**On** (default) Keypad is numeric keys.

**Off** Keypad is arrow keys.

**Gate A20 Option**

**Normal** The A20 signal is controlled by keyboard controller or chipset hardware.

**Fast** (default) The A20 signal is controlled by port 92 or chipset specific method.

### **Security Option**

This category allows you to limit access to the system and Setup, or just to Setup.

<b>System</b>	The system will not boot and access to Setup will be denied if the correct password is not entered at the prompt.
<b>Setup(default)</b>	The system will boot, but access to Setup will be denied if the correct password is not entered at the prompt.

### **PCI VGA Palette Snooping**

Choose Disabled or Enabled. Some graphic controllers which are not VGA compatible, take the output from a VGA controller and map it to their display as a way to provide the boot information and the VGA compatibility.

However, the color information coming from the VGA controller is drawn from the palette table inside the VGA controller to generate the proper colors, and the graphic controller needs to know what is in the palette of the VGA controller. To do this, the non-VGA graphic controller watches for the Write access to the VGA palette and registers the snoop data. In PCI based systems, where the VGA controller is on the PCI bus and a non-VGA graphic controller is on an ISA bus, the Write Access to the palette will not show up on the ISA bus if the PCI VGA controller responds to the Writes.

In this case, the PCI VGA controller should not respond to the Write. It should only snoop the data and permit the access to be forwarded to the ISA bus. The non-VGA ISA graphic controller can then snoop the data on the ISA bus. Unless you have the above situation, you should disable this option.

<b>Disabled</b> (default)	Disables the function
<b>Enabled</b>	Enables the function

**OS Selection for DRAM > 64MB**

Allows OS2® to be used with > 64 MB of DRAM. Settings are Non-OS/2 (default) and OS2. Set to OS/2 if using more than 64MB and running OS/2®.

**Report No FDD For WIN 95**

This function is only used when you are testing SCT for Windows® 95 Logo.

**Video BIOS Shadow**

Determines whether video BIOS will be copied to RAM for faster execution. Video shadow will increase the video performance.

<b>Enabled</b> (default)	Video shadow is enabled
<b>Disabled</b>	Video shadow is disabled

**C8000 - CFFFF Shadow/E8000 - EFFFF Shadow**

Determines whether the optional ROM will be copied to RAM for faster execution.

<b>Enabled</b>	Optional shadow is enabled
<b>Disabled</b> (default)	Optional shadow is disabled

**Note:** For C8000-DFFFF optional-ROM on PCI BIOS , BIOS will automatically enable the shadow RAM. User does not have to select the item.



## 4.6 Chipset Features Setup

The Chipset Features Setup option is used to change the values of the chipset registers. These registers control most of the system options in the computer.

Choose the “CHIPSET FEATURES SETUP” from the Main Menu and the following screen will appear.

**ROM PCI/ISA BIOS (2A5LEM4F)**

Bank 0/1 DRAM Timing	: SDRAM 10ns	TV-Out Mode	: NTSC
Bank 2/3 DRAM Timing	: SDRAM 10ns	Auto Detect DIMM/PCI Clk	: Enabled
SDRAM Cycle Length	: 3	Spread Spectrum	: Enabled
Memory ECC Check	: Non-ECC	CPU Host Clock (CPU/PCI)	: Default
DRAM Read Pipeline	: Enabled		
Sustained 3T Write	: Enabled		
Cache R/CPU W Pipeline	: Enabled		
Cache Timing	: Fast		
Video BIOS Cacheable	: Enabled		
System BIOS Cacheable	: Enabled		
Memory Hole	: Disabled		
Init Display First	: PCI Slot		
Frame Buffer Size	: 8M		
AGP Aperture Size	: 64M		
Onchip USB	: Enabled		
USB Keyboard Support	: Disabled	Esc : Quit	↑↓→← : Select item
Onchip Sound	: Enabled	F1 : Help	PU/PD/+/- : modify
Onchip Modem	: Disabled	F5 : Old Value(Shift)	F2 : Color
		F7 : Load Setup Defaults	

**Note:** Change these settings only if you are familiar with the chipset.

**Bank 0/1 DRAM Timing****Bank 2/3 DRAM Timing**

The DRAM timing is controlled by the DRAM Timing Registers. The Timings programmed into this register are dependent on the system design. Slower rates may be required in certain system designs to support loose layouts or slower memory.

**SDRAM Cycle Length**

This item allows you to select the SDRAM cycle length. The settings are 2 or 3.

**Memory ECC Mode**

If the DIMM installed support ECC, then select ECC to improve performance. Otherwise select Non-ECC.

**DRAM Read Pipeline**

This item sets the timing for pipeline burst mode read from DRAM. The default setting is Enabled.

**Sustained 3T Write**

This item select the access method of Cache.

Enabled      Write Through

Disabled     Write Back

**Cache R/CPU w Pipeline**

This item can enabled the pipelining of Cache read and CPU write cycle. The default setting is Enabled.

**Cache Timing**

This field allows you to determine the Cache burst mode timing.

**Fast**              Cache burst mode timing are 31112111.

**Fastest**          Cache burst mode timing are 31111111.

### **Video BIOS Cacheable**

Select Enabled allows caching of the system BIOS ROM at C0000h-F7FFFh, resulting in better video performance. However, if any program writes to this memory area, a system error may result.

<b>Enabled</b> (Default)	Video BIOS access cached
<b>Disabled</b>	Video BIOS access not cached

### **System BIOS Cacheable**

Select Enabled allows caching of the system BIOS ROM at F000h-FFFFFh, resulting in better system performance. However, if any program writes to this memory area, a system error may result.

<b>Enabled</b> (default)	BIOS access cached
<b>Disabled</b>	BIOS access not cached

### **Memory Hole**

In order to improve performance, certain space in memory can be reserved for ISA cards. This memory must be mapped into the memory space below 16 MB.

Enabled	Memory hole supported.
Disabled (default)	Memory hole not supported.

### **Init Display First**

Select whether to use PCI Slot VGA card or onboard VGA as the initial Display on the monitor.

### **Frame Buffer Size**

Select the Frame Buffer size. The settings are NA, 4M, 8M.

### **AGP Aperture Size (MB)**

Select the size of the Accelerated Graphics Port (AGP) aperture. The aperture is a portion of the PCI memory address range dedicated for graphics memory address space. Host cycles that hit the aperture range are forwarded to the AGP without any translation.

### **Onchip USB**

Set this option to Enable or Disable the onchip USB controller. The default setting is Enabled.

---

### **USB Keyboard Support**

Set this option to Enable or Disable the USB keyboard/mouse support. The default setting is Disabled.

### **Onchip Sound**

This item allows you to enabled or disabled the onboard sound chip. To enabled the onboard audio, set this item to enabled. Then, short JRTCK1 pin 1-2 and JSDIN pin 1-2.

### **Onchip Modem**

This item allows you to enabled or disabled the Soft Wave Modem for AMR(Modem Riser Card).

### **TV-Out Mode**

This item only work with MS-5967 TV-Out Interface installed. The settings are NTSC, PAL, Brazil.

### **Auto Detect DIMM/PCI Clk**

This item allows the clock generator to auto-detect the interface of DIMM/PCI. If there's no DIMM/PCI card present, then the clock will be shut down. The default setting is Enabled.

### **Spread Spectrum**

This item allows you to select the clock generator Spread Spectrum function. When overclocking the processor, always set this item to Disabled. The default is enabled.

### **CPU Host Clock (CPU/PCI)**

This item allows you to select the clock speed. Speed supported: 60, 66, 70, 75, 80, 83, 95, 100, 105, 110, 115, and 120MHz.

**Note:** Overclocking may result in an unstable system.

## 4.7 Power Management Setup

The Power Management Setup will appear on your screen like this:

```
ROM PCI/ISA BIOS (2A5LEM4F)
POWER MANAGEMENT SETUP
AWARD SOFTWARE, INC.
```

Power Management	:User Define	IRQ3(COM2)	:Primary
PM Control by APM	:Yes	IRQ4(COM1)	:Primary
Video Off Method	:DPMS Support	IRQ5(LPT2)	:Primary
Video Off After	:Suspend	IRQ6(FDD)	:Primary
Modem Use IRQ	:3	IRQ7(LPT1)	:Primary
Reserved IRQ 9	:Enabled	IRQ8(RTC Alarm)	:Disabled
Doze Mode	:Disabled	IRQ9(rsv)	:Secondary
Suspend Mode	:Disabled	IRQ10(rsv)	:Secondary
HDD Power Down	:Disabled	IRQ 11(Rsv)	:Primary
Soft-Off by PWR-BTTN	:Instant Off	IRQ12(PS/2 mouse)	:Primary
CPU Fan In Suspend	:Off	IRQ13(Copro)	:Primary
LED in Suspend	:Single	IRQ14(Hard Disk)	:Primary
		IRQ15(Rsv)	:Disabled
***PM Events***			
VGA	:OFF		
LPT&COM	:LPT/COM		
HDD&FDD	:ON		
RTC Alarm Resume	:Disabled		
		Esc : Quit    ↑↓→← : Select item	
		F1 : Help PU/PD/+/- : modify	
		F5 : Old Value(Shift) F2 : Color	
		F7 : Load Setup Defaults	
Wake Up by LAN/Ring	:Disabled		

### Power Management

This category determines the power consumption for system after selecting below items. Default value is Disable. The following pages tell you the options of each item & describe the meanings of each options.

**Power Management**

<b>User Define</b>	Users can configure their own power management.
<b>Min Saving</b>	Pre-defined timer values are used such that all timers are in their MAX value.
<b>Max Saving</b>	Pre-defined timer values are used such that all timers are in their MIN value.

**PM Control by APM**

<b>No</b>	System BIOS will ignore APM when power managing the system.
<b>Yes</b>	System BIOS will wait for APM's prompt before it enter any PM mode

**Note :** Enable this for O.S. with APM like Windows® 95/98, Windows® NT, etc.

**Video Off Method**

<b>Blank Screen</b>	The system BIOS will only blank off the screen when disabling video.
<b>V/H SYNC+Blank</b>	In addition to (1), BIOS will also turn off the V-SYNC & H-SYNC signals from VGA card to monitor.
<b>DPMS (default)</b>	This function is enabled only for VGA card supporting DPMS.

**Note:** Green monitors detect the V/H SYNC signals to turn off its electron gun.

**Video Off After**

The settings are N/A, Standby, Doze, or Suspend. This option is for choosing the setting in which the monitor will turn off.

<b>N/A</b>	Always turn on.
<b>Doze</b>	During Doze mode, the monitor will be turned off.
<b>Standby</b>	During Standby mode, the monitor will be turned off.
<b>Suspend</b>	During Suspend mode, the monitor will be turned off.

The default setting is Standby.

**MODEM Use IRQ**

Name the interrupt request (IRQ) line assigned to the modem (if any) on your system. Activity of the selected IRQ always awakens the system. The settings are NA, 3, 4, 5, 7, 9, 10, or 11.

**Reserve IRQ 9**

This item is reserved for Windows® 98 ACPI mode. Choose yes, if you use Windows® 98 ACPI mode. Otherwise, set to no.

**Doze Mode**

**Disable** System will never enter DOZE mode.

**10sec/20sec/30sec/  
40sec/1min/2min/  
4min/6min/8min/  
10min/20min/  
30min/40min/  
1hr** Defines the continuous idle time before the system enters DOZE mode. If any item defined in the options of “Power Down and Resume events” is enabled & active, DOZE timer will be reloaded. When the system have entered Doze mode, any of the items enabled in “Wake Up Events in Doze and Standby” will trigger the system to wake up.

**Suspend Mode**

**Disable** System will never enter STANDBY mode.

**10sec/20sec/30sec/  
40sec/1min/2min/  
4min/6min/8min/  
10min/20min/  
30min/40min/  
1hr** Defines the continuous idle time before the system enters STANDBY mode. If any item defined in the options of “Power Down and Resume events” is enabled & active, STANDBY timer will be reloaded. When the system has entered Standby mode, any of the items that are enabled in “Wake Up Events of Doze and Standby” will trigger the system to wake up.

**HDD Power Down**

**Disable**                      HDD's motor will not shut off.

**1 Min/2 Min/**              Defines the continuous HDD idle time before  
**3 Min/4 Min/**              the HDD enters the power saving mode (motor  
**5 Min/6 Min/**              off). BIOS will turn off the HDD's motor when  
**7 Min/8 Min/**              time is out.  
**9 Min/10 Min/**  
**11 Min/12 Min/**  
**13 Min/14 Min/**  
**15 Min**

**Soft-off by PWRBTN**

This field is for the soft-off function setting. When the board utilizes an ATX power supply, two types of settings are offered: Delay 4 sec. and Instant-off. When the setting is Delay 4 sec., users can power off the system by pressing POWER-ON button for 4 seconds. However, if users press POWER-ON button for less than 4 seconds, the system will enter suspend mode only. When the setting is Instant-off, pressing the POWER-ON button once will power off the system, and pressing again will power on the system.

**CPU Fan in Suspend**

During Off, if the system goes into suspend mode, the CPU fan will also stop. During On, the CPU fan will not stop.

**LED in Suspend**

This item determines which state the power LED will use. The settings are Dual color, and Single Color. During Dual Color, the Power LED will change its color in suspend mode. During Single Color, the Power LED will always remain lit.

---



## **PM Events**

Award BIOS defines 7 PM events in the power management mode (Doze & suspend). The user can initialize any PM Events to be Enable or Disable. When the system detects all of the enabled events do not have any activity, it will start the system Doze timer first if the Power Management is not Disabled. Once the system Doze timer is timed out, it will process doze power saving procedure by starting the system suspend timer. When the suspend timer times out, all of the CPU clock will stop by dropping system clock down to zero and remains this way until any one of the enabled events occurs.

<b>VGA</b>	<b>ON/OFF</b>
<b>LPT &amp; COM</b>	<b>NONE/LPT/COM/LPT&amp;COM</b>
<b>HDD &amp; FDD</b>	<b>ON/OFF</b>

## **RTC Alarm Resume**

This function is for setting date and time for your computer to boot up. During Disabled, you cannot use this function. During Enabled, choose the Date and Time Alarm:

<b>Date(of month) Alarm</b>	You can choose which day of the month the system will boot up. Set to 0, to boot every day.
<b>Time(hh:mm:ss) Alarm</b>	You can choose what hour, minute and second the system will boot up.

**Note:** If you have change the setting, you must let the system boot up until it goes to the operating system, before this function will work.

## **Wake Up by LAN/Ring**

During disabled, the system will ignore any incoming call from the Modem or LAN. During Enabled, the system will boot up if there's an incoming call from the Modem or LAN.

## 4.8 PNP/PCI Configuration Setup

You can manually configure the PCI Device's IRQ. The following pages tell you the options of each item & describe the meanings of each options.

**ROM PCI/ISA BIOS (2A5LEM4F)**  
**PNP/PCI CONFIGURATION SETUP**  
**AWARD SOFTWARE, INC.**

PnP OS Installed	:No	CPU to PCI Write Buffer	:Enabled
Resources Controlled By	:Manual	PCI Dynamic Bursting	:Enabled
Reset Configuration Data	:Disabled	PCI Master 0 WS Write	:Enabled
		PCI Delay Transaction	:Enabled
IRQ-3 assigned to	:PCI/ISA PnP	PCI#2 Access#1 Retry	:Enabled
IRQ-4 assigned to	:PCI/ISA PnP	AGP Master 1 WS Write	:Enabled
IRQ-5 assigned to	:PCI/ISA PnP	AGP Master 1 WS Read	:Disabled
IRQ-7 assigned to	:PCI/ISA PnP		
IRQ-9 assigned to	:PCI/ISA PnP	Assign IRQ for VGA	:Enabled
IRQ-10 assigned to	:PCI/ISA PnP		
IRQ-11 assigned to	:PCI/ISA PnP		
IRQ-12 assigned to	:PCI/ISA PnP		
IRQ-14 assigned to	:PCI/ISA PnP		
IRQ-15 assigned to	:PCI/ISA PnP		
DMA-0 assigned to	:PCI/ISA PnP		
DMA-1 assigned to	:PCI/ISA PnP	Esc : Quit	↑↓→← : Select item
DMA-3 assigned to	:PCI/ISA PnP	F1 : Help	FU/PD/+/- : modify
DMA-5 assigned to	:PCI/ISA PnP	F5 : Old Value(Shift)	F2 : Color
DMA-6 assigned to	:PCI/ISA PnP	F7 : Load Setup Defaults	
DMA-7 assigned to	:PCI/ISA PnP		

### PnP OS Installed

When set to YES, BIOS will only initialize the PnP cards used for booting (VGA, IDE, SCSI). The rest of the cards will be initialized by the PnP operating system like Windows® 95 or 98. When set to NO, BIOS will initialize all the PnP cards. So, for non-PnP operating system (DOS, Netware®), this option must set to Yes.

### **Resources Controlled By**

By Choosing “Auto” (default), the system BIOS will detect the system resource and automatically assign the relative IRQ and DMA Channel for each peripheral.

By Choosing “Manual”, the user will need to assign IRQ & DMA for add-on cards. Be sure that there is no conflict for IRQ/DMA and I/O ports.

**Note:** When choosing “Auto” you must be sure that all of the system add-on cards are PnP type.

### **Reset Configuration Data**

The system BIOS supports the PnP feature so the system needs to record which resource is assigned and protect resources from conflict. Every peripheral device has a node which is called ESCD. This node records which resources are assigned to it. The system needs to record and update ESCD to the memory locations. These locations (4K) are reserved at the system BIOS.

If Disabled (default) is chosen, the system’s ESCD will update only when the new configuration varies from the last one.

If Enabled is chosen, the system will be forced to update the system’s ESCD. Then, this option will be auto-set to Disable.

IRQ-3 assigned to : Legacy ISA  
IRQ-4 assigned to : Legacy ISA  
IRQ-5 assigned to : PCI/ISA PnP  
IRQ-7 assigned to : PCI/ISA PnP  
IRQ-9 assigned to : PCI/ISA PnP  
IRQ-10 assigned to : PCI/ISA PnP  
IRQ-11 assigned to : PCI/ISA PnP  
IRQ-12 assigned to : PCI/ISA PnP  
IRQ-14 assigned to : PCI/ISA PnP

IRQ-15 assigned to : PCI/ISA PnP  
DMA-0 assigned to : PCI/ISA PnP  
DMA-1 assigned to : PCI/ISA PnP  
DMA-3 assigned to : PCI/ISA PnP  
DMA-5 assigned to : PCI/ISA PnP  
DMA-6 assigned to : PCI/ISA PnP  
DMA-7 assigned to : PCI/ISA PnP

The above settings will be shown on the screen only if “Manual” is chosen for the *Resources Controlled By* function.

Legacy is the term which signifies that a resource is assigned to the ISA Bus and provides for non PnP ISA add-on card. PCI/ISA PnP signifies that a resource is assigned to the PCI Bus or provides for ISA PnP add-on cards and peripherals.

### **CPU to PCI Write Buffer**

This item allows you to Enabled or Disabled the CPU to PCI Write Buffer. The default setting is Enabled.

### **PCI Dynamic Bursting**

This setting allows you to Enabled or Disabled PCI Dynamic Bursting function. The default setting is Enabled.

### **PCI Master 0 WS Write**

**Enabled** zero wait state response.

**Disabled** one wait state response.

The default setting is Enabled.

### **PCI Delay Transaction**

This item allows you to Enabled or Disabled the PCI Delay Transaction.

**PCI#2 Access #1 Retry**

**Enabled** PCI#2 will be disconnected, if max retries are attempted without success.

**Disabled** PCI#2 will not be disconnected until access is finish.

**Assign IRQ for VGA**

Lets the user choose which IRQ to assign for VGA card.

## 4.9 Load Setup Defaults

This Main Menu item loads the default system values. If the CMOS is corrupted the defaults are loaded automatically. Choose this item and the following message appears:

“ Load Setup Defaults (Y / N) ? N “

To use the Setup defaults, change the prompt to “Y” and press < Enter >

**Note:** The Setup defaults can be customized to increase performance. However the BIOS defaults can always be used as a back up if there is some problem with the mainboard operation.

### 4.10 Special Features Setup (optional)

This Special Features Setup is used by System Hardware Monitor chipset. You can manually change the value of each option.

ROM PCI/ISA BIOS (2A5LEM4F)  
 INTEGRATED PERIPHERALS  
 AWARD SOFTWARE, INC.

<pre> ***** POST SHOWING ***** CPU Fan Detected      :Enabled Sys Fan Detected     :Disabled Chassis Intrusion Detect :Enabled Voltage Detected     :Enabled Vcore Voltage Detected :Enabled +2.5V Voltage Detected :Enabled +3.3V Voltage Detected :Enabled +5.0V Voltage Detected :Enabled + 12V Voltage Detected :Enabled                 </pre>	<pre> ***** SYSTEM MONITOR ***** CPU Fan RPM          :6367  System Temperature   :26°C/78°F CPU Temperature      :28°C/82°F CPU Critical Temp    :Disabled Shutdown Temp        :Disabled  Esc : Quit      ↑↓→←: Select item F1  : Help PU/PD/+/- : modify F5  : Old Value(Shift) F2 : Color F6  : Load BIOS Defaults F7  : Load Setup Defaults                 </pre>
---	---

#### **CPU Fan Detected/SYS Fan Detected//Voltage Detected/ Vcore Voltage Detected/+2.5V Voltage Detected/+3.3V Voltage Detected/+5.0 Voltage Detected/+12V Voltage Detected**

During Enabled, this will show the CPU/FAN voltage chart during system boot up. During Disabled, this will not show.

**CPU Fan RPM**

During Enabled, this will monitor the RPM of your CPU fan.

**System Temperature/CPU Temperature**

This will show the System and CPU temperature.

**CPU Critical Temp**

This option is for setting the critical temperature level for the processor. When the processor reach the temperature you set, this will reduce the load on the processor.

**Shutdown Temp**

This option is for setting the Shutdown temperature level for the processor. When the processor reach the temperature you set, this will shutdown the system. This function only works with Windows® 95 operating system.



## 4.11 Integrated Peripherals

ROM PCI/ISA BIOS (2A5LEM4F)  
 INTEGRATED PERIPHERALS  
 AWARD SOFTWARE, INC.

Onchip IDE First Channel : Enabled	Onboard Parallel Mode : ECP/EPP
Onchip IDE Second Channel: Enabled	ECP Mode Use DMA : 3
IDE Prefetch Mode : Enabled	EPP Mode Select : EPP1.9
IDE HDD Block Mode : Enabled	
Primary Master PIO : Auto	Onboard Legacy Audio : Enabled
Primary Slave PIO : Auto	Sound Blaster : Disabled
Secondary Master PIO : Auto	SB I/O Base Address : 220H
Secondary Slave PIO : Auto	SB IRQ Select : IRQ5
Primary Master UDMA : Auto	SB DMA Select : DMA1
Primary Slave UDMA : Auto	MPU-401 : Enabled
Secondary Master UDMA : Auto	MPU-401 I/O Address : 330-333H
Secondary Slave UDMA : Auto	FM Port (388-38BH) : Disabled
	Game Port (200-207H) : Enabled
Onboard FDD controller : Enabled	
Onboard Serial Port 1 : Auto	
Onboard Serial Port 2 : Auto	Esc : Quit ↑↓→←: Select item
UART2 Mode : Standard	F1 : Help PU/PD/+/- : modify
	F5 : Old Value(Shift) F2 : Color
	F7 : Load Setup Defaults
Onboard Parallel Port : 3F8/IRQ7	

### Onchip IDE First Channel Enabled/Disabled

### Onchip IDE Second Channel Enabled/Disabled

The system provides for a On-Board On-Chipset PCI IDE controller that supports Dual Channel IDE (Primary and Secondary). A maximum of 4 IDE devices can be supported. If the user install the Off-Board PCI IDE controller (i.e. add-on cards), the user must choose which channels will be disabled. This will depend on which channel will be used for the Off-Board PCI IDE add-on card.

**IDE Prefetch Mode**  
Enabled/Disabled

**IDE HDD Block Mode**  
Enabled/Disabled      Enabled allows the Block mode access for the IDE HDD.

**Primary Master PIO**  
Auto/Mode0/Mode1-4

**Primary Slave PIO**  
Auto/Mode0/Mode1-4

**Secondary Master PIO**  
Auto/Mode0/Mode1-4

**Secondary Slave PIO**  
Auto/Mode0/Mode1-4

For these 4 IDE options, choose “Auto” to have the system BIOS auto detect the IDE HDD operation mode for PIO access.

**Note:** Some IDE HDD can not operate at the responding HDD’s mode. When the user has selected “Auto” and the system BIOS has accepted the HDD response mode, the user may degrade the HDD’s operation mode. Ex: IF the HDD reported it can operate in mode 4 but it is not operating properly, the user will have to manually change the operation mode to mode 3.

Choosing Mode 1-4 will have the system ignore the HDD’s reported operation mode and use the selected mode instead.

**Note:** According to ATA specs. Mode 4 transfer rate is > Mode 3 > Mode 2 > Mode 1 > Mode 0. If the user’s HDD can operate at Mode 3 the user can also select a slower Mode (i.e. Mode 0-2) but not a faster Mode (ie Mode 4).

**Onboard FDD Controller****Enabled/Disabled**

The system has an on-board Super I/O chip with a FDD controller that supports 2 FDDs for 360K/720K/1.2M/1.44M/2.8M. Choose “Enabled” to use the on-board FDD controller for accessing the FDD. Otherwise choose “Disabled” to use the off-board FDD controller.

**Onboard Serial Port 1****Disabled/(3F8/IRQ4)/(2F8/IRQ3)/(3E8/IRQ4)/(2E8/IRQ3)****Onboard Serial Port 2****Disabled/(3F8/IRQ4)/(2F8/IRQ3)/(3E8/IRQ4)/(2E8/IRQ3)**

The system has an On-board Super I/O chipset with 2 serial ports. The On-board serial ports can be selected as:

**Disabled**

3F8/IRQ4	COM 1 uses IRQ4
2F8/IRQ3	COM 2 uses IRQ3
3E8/IRQ4	COM 3 uses IRQ4
2E8/IRQ3	COM 4 uses IRQ3

**Note:** Because the ISA Bus Interrupt accepts low to high edge trigger, the interrupt request line cannot be shared by multiple sources. If an off-board ISA add-on card with a serial port is installed, the user may have to disable the on-board serial port because it will conflict with IRQ request line for the off-board serial port.

### **UART2 Mode**

This item allows you to determine which Infra Red (IR) function of onboard I/O chip. If you choose IR function, the COM 2 will not function. If you want to use the IR, it is recommended to select HPSIR.

### **Onboard Parallel Port**

**Disabled**  
**(3BCH/IRQ7)/**  
**(278H/IRQ5)/**  
**(378H/IRQ7)**

There is a built-in parallel port on the on-board Super I/O chipset that provides Standard, ECP, and EPP features. It has the following options:

**Disable**  
3BCH/IRQ7 Line Printer port 0  
278H/IRQ5 Line Printer port 2  
378H/IRQ7 Line Printer port 1

### **Onboard Parallel Mode**

Normal : Standard Parallel Port  
EPP : Enhanced Parallel Port  
ECP : Extended Capability Port  
ECP/EPP

To operate the onboard parallel port as Standard Parallel Port only, choose "Normal". To operate the onboard parallel port in the ECP and EPP modes simultaneously, choose "ECP/EPP." By choosing "ECP", the onboard parallel port will operate in ECP mode only. Choosing "ECP/EPP" will allow the onboard parallel port to support both the ECP and EPP modes simultaneously. The ECP mode has to use the DMA channel, so choose the onboard parallel port with the ECP feature. After select-

ing it, the following message will appear: “ECP Mode Use DMA” At this time the user can choose between DMA channels 3 or 1. The onboard parallel port is EPP Spec. compliant, so after the user chooses the onboard parallel port with the EPP function, the following message will be displayed on the screen: “EPP Mode Select.” At this time either EPP 1.7 spec. or EPP 1.9 spec. can be chosen.

### **Onboard Legacy Audio**

This item is used to enabled/disabled the onboard legacy audio. If you want to use Game port or Midi Port, set this item to enabled.

## 4.12 Supervisor/User Password Setting

This Main Menu item lets you configure the system so that a password is required each time the system boots or an attempt is made to enter the Setup program. Supervisor Password allows you to change all CMOS settings but the User Password setting doesn't have this function. The way to set up the passwords for both Supervisor and User are as follow:

1. Choose "Change Password" in the Main Menu and press <Enter>. The following message appears:

"Enter Password:"

2. The first time you run this option, enter your password up to only 8 characters and press <Enter>. The screen does not display the entered characters. For no password just press <Enter>.
3. After you enter the password, the following message appears prompting you to confirm the password:

"Confirm Password:"

4. Enter exactly the same password you just typed in to confirm the password and press <Enter>.
  5. Move the cursor to Save & Exit Setup to save the password.
  6. If you need to delete the password you entered before, choose the Supervisor Password and press <Enter>. It will delete the password that you had before.
  7. Move the cursor to Save & Exit Setup to save the option you did. Otherwise, the old password will still be there when you turn on your machine next time.
-

### 4.13 IDE HDD Auto Detection

You can use this utility to automatically detect the characteristics of most hard drives.

When you enter this utility, the screen asks you to select a specific hard disk for Primary Master. If you accept a hard disk detected by the BIOS, you can enter “Y” to confirm and then press <Enter> to check next hard disk. This function allows you to check four hard disks and you may press the <Esc> after the <Enter> to skip this function and go back to the Main Menu.

**ROM ISA BIOS  
CMOS SETUP UTILITY  
AWARD SOFTWARE, INC.**

HARD DISKS	TYPE	SIZE	CYLS	HEADS	PRECOMP	LANDZONE	SECTOR MODE
Primary Master:	Auto	0	0	0	0	0	AUTO
Primary Slave :	Auto	0	0	0	0	0	AUTO
Secondary Master :	Auto	0	0	0	0	0	AUTO
Secondary Slave :	Auto	0	0	0	0	0	AUTO

Select Primary Master		Option (N=Skip) : N				
OPTIONS	SIZE	CYLS	HEAD	PRECOMP	LANDZ	SECTOR MODE
2	2112	1023	64	0	4094	63 LBA
1	2113	4095	16	65535	4094	63 NORMAL
3	2113	2047	32	65535	4094	63 LARGE

[ESC: Skip]

## **Chapter 5**

### **VIA CHIPSET DRIVER**

#### **1. Overview**

The MVP4 integrates an AGP 2.0 - compliant 2D/3D AGP graphics controller into the north bridge of the chipset. Packed with features, the controller incorporates a 64-bit 2D/3D graphics engine and video accelerator with advanced DVD video and optional TV output capability. The controller supports Win-95 and Win-98 / NT5 miniport drivers.

The Apollo MVP4 is paired with the VIA VT82C686A south bridge. Highly advanced, the south bridge combines an integrated 2D/3D engine with DVD hardware acceleration, AC-97 audio support for SoundBlaster Pro and FM synthesis legacy audio.

#### **1.1 Graphics Features**

- AGP 2.0 --Compliant
- 64-bit 2D/3D graphics engine and video accelerator
- DVD hardware accelerator

#### **1.2 Audio Features**

- AC'97 audio support for SoundBlaster Pro
- FM synthesis legacy audio



### 1.3 System Requirements

This section describes system requirements for the VGA Driver installation and Usage.

<b>Computer</b>	Intel® Pentium™ processor AMD® K6/K6-2/K6-III processor Cyrrix® MX/MII processor
<b>Monitor</b>	VGA Support, minimum 640x480 resolution
<b>Operating system</b>	DOS 5.0 or higher, Windows® 95/98, Windows® NT 3.51 or 4.0, or OS/2®
<b>CD-ROM</b>	Double Speed or Higher
<b>Chipset</b>	VIA® MVP4/VT82C686A chipset
<b>VGA BIOS</b>	Version 00.23 or Higher

## 2. Driver Setup & Usage Procedures for Windows® 98

Insert the CD-title into your CD-ROM drive. The CD will auto-run and will display the four icons in the monitor “VIA Chipset Drivers”, “VIA AC97 PCI Sound Drivers”, “VIA Enhance VGA Drivers” and “Download VIA Drivers”. In order to install the drivers correctly, you must install the “Via Chipset Drivers” first, and then install the “VIA AC97 PCI Sound Drivers” or “VIA Enhance VGA Drivers”.

### 2.1 VIA Chipset Drivers installation procedure:

- Step 1:** Insert the provided CD\_ROM disk into the CD-ROM drive.
  - Step 2:** Look for the CD\_ROM drive, double click on the CD\_ROM icon. This will show the setup screen.
  - Step 3:** Click on “Via Chipset Drivers” icon and the screen will show “VIA Service Pack 4.05”.
  - Step 4:** Click “Next” and the screen will show three drivers “Bus Master PCI IDE Driver”, “AGP VxD Driver” and “VIA Chipset Function’s Registry”. Select all three drivers and click on “Next”.
  - Step 5:** The setup program will request you to choose “Install”, “Uninstall” or “Enable/Disable (Ultra) DMA for IDE driver”. Please select “Install” and click “Next” to continue.
  - Step 6:** The setup program will request you to choose “Install VIA AGP VxD in turbo mode”, “Install VIA AGP VxD in normal mode” or “Uninstall VIA AGP VxD”. Please select “Install VIA AGP VxD in turbo mode” and click on “Next”.
  - Step 7:** The setup program will let you choose between “Install VIA Chipset Functions Registry” or “Uninstall VIA Chipset Functions Registry”. Please select “Install VIA Chipset Functions Registry” and then click “Next”.
  - Step 8:** The setup program will request you to choose whether to restart the computer or not. Please select “Yes, I want to restart my computer now” and click Finish. The computer will restart and finish the VIA Chipset Drivers installation.
-

**2.2 VIA AC97 PCI Sound Drivers installation procedure:**

- Step 1:** Insert the provided CD\_ROM disk into the CD-ROM drive.
- Step 2:** Look for the CD\_ROM drive, double click on the CD\_ROM icon. This will show the setup screen.
- Step 3:** Click on “VIA AC97 PCI Sound Drivers” icon and the screen will show “VIA AC97 PCI Sound Drivers”.
- Step 4:** Click “Next” to proceed and the screen will show “Install”, or “Remove”. Select “Install” and then click on “Next”.
- Step 5:** The setup program will request you to choose whether to restart the computer or not. Please select “Yes, I want to restart my computer now” and click Finish. The computer will restart and finish the AC97 Audio Drivers Installation.

**2.3 VIA Enhance VGA Drivers Installation Procedures**

- Step 1:** Insert the provided CD\_ROM disk into the CD-ROM drive.
- Step 2:** Look for the CD\_ROM drive, double click on the CD\_ROM icon. This will show the setup screen.
- Step 3:** Click on “VIA Enhance VGA Drivers” icon and click “Next”.
- Step 4:** The setup program will request you to choose whether to restart the computer or not. Please select “Yes, I want to restart my computer now” and click Finish. The computer will restart and finish the VGA Chipset Drivers installation.

**2.4 Change the display resolution and color**

- Step 1:** Click the “Start” icon at the left button of the screen.
- Step 2:** Select “Settings” then “Control Panel”. Click on “Control Panel”.
- Step 3:** Double click the “Display” icon and the screen will show “Display Properties” setting screen.
- Step 4:** Click the “Settings” icon to change the display resolution and color. Click “OK” when you finish setting the resolution and color.

**Note:** If you wish to have a good 3D graphic quality, please install the Direct X 6.

---

## **2.5 Enable the Ultra DMA Driver for IDE Driver**

- Step 1:** Insert the provided CD-ROM disk into the CD-ROM drive.
- Step 2:** Look for the CD-ROM drive, double click on the CD-ROM icon. This will show the setup screen.
- Step 3:** Click on the “VIA Chipset Drivers” icon and the screen will show “VIA Service Pack 4.05”.
- Step 4:** Click “Next” and the screen will show three drivers: “Bus Master PCI IDE Drivers”, “AGP VxD Drivers” and “VIA Chipset Function’s Registry”. Select the “Bus Master PCI IDE Drivers” icon and click “Next”.
- Step 5:** The setup program will request you to choose “Install”, “Uninstall” or “Enable/Disable (Ultra) DMA for IDE driver”. Please select “Enable/Disable (Ultra) DMA for IDE driver” and click “Next” to continue.
- Step 6:** The setup program will show the hard drive DMA mode, please click “Next”.
- Step 7:** The setup program will request you to choose whether to restart the computer or not. Please select “Yes, I want to restart my computer now” and click Finish. The computer will restart and finish the (Ultra) DMA Enable for IDE Master.

### 3. Windows® NT 4.0

Install Windows® NT 4.0 Service Pack 3 or the latest version before installing the VIA drivers.

Insert the CD-title in the CD-ROM drive. The CD will auto-run and will display four icons on the screen “VIA Chipset Drivers”, “VIA AC97 PCI Sound Drivers”, “VIA Enhance VGA Drivers” and “Download VIA Drivers”. In order to install the drivers properly, install the “VIA Chip Drivers” first and then install the “VIA AC97 PCI Sound Drivers” or “VIA Enhance VGA Drivers”.

#### 3.1 VIA Chipset Drivers Installation Procedure:

**Step 1:** Insert the provided CD\_ROM disk into the CD-ROM drive.

**Step 2:** Look for the CD\_ROM drive, double click on the CD\_ROM icon. This will show the setup screen.

**Step 3:** Click on “VIA Chipset Drivers” icon and the screen will show “VIA Service Pack 4.05”.

**Step 4:** Click “Next” to proceed and the screen will show “Install”, “Uninstall” or “Enable/Disable Ultra DMA for IDE Driver”. Select “Install” and then click on “Next”.

**Step 5:** The setup program will show the following on the screen: “To complete this installation, follow this steps”

1. Select the “SCSI Adapters” icon on the “Control Panel”.
2. Select the “Add..” button on the “Drivers” sheet.
3. Select the “VIA Bus Master IDE Drivers” and click the “OK” button
4. Reboot

Please click “Next” to exit the setup program.

**Step 6:** Follow the steps shown in **Step 5** to finish the VIA Chipset Drivers installation.

**3.2 VIA AC97 PCI Sound Drivers Installation Procedure:**

- Step 1:** Insert the provided CD\_ROM disk into the CD-ROM drive.
- Step 2:** Look for the CD\_ROM drive, double click on the CD\_ROM icon. This will show the setup screen.
- Step 3:** Click on “VIA AC97 PCI Sound Drivers” icon and the screen will show the “VIA PCI Audio Drivers” setup screen. Click “Next” to continue
- Step 4:** The setup program will show “Install” or “Remove” in the screen. Select “Install” and click “Next”
- Step 5:** The setup program will show the following on the screen:

Please choose “Add” from the next window and add the following device:  
VIA AC97 PCI Audio Device  
VIA MIDI External Port

Then click “OK”.

- Step 6:** Follow the steps shown in **Step 5** to finish the VIA AC97 PCI Audio Drivers Installation.

**3.3 VIA Enhance VGA Drivers Installation Procedure:**

- Step 1:** Insert the provided CD\_ROM disk into the CD-ROM drive.
- Step 2:** Look for the CD\_ROM drive, double click on the CD\_ROM icon. This will show the setup screen.
- Step 3:** Click on “VIA Enhance VGA Drivers” icon and the screen will show the “VIA Enhance VGA Drivers” setup screen. Click “Next” to continue.
- Step 4:** The setup program will ask you whether you want to restart your computer now or not. Select “Yes, I want to restart my computer now: and click “Finish”. The computer will restart and finish the VGA Drivers installation.
- Step 5:** After restarting the system, the system will ask to change the display resolution and color. Select the display resolution and color and click “OK”.

**3.4 Enable the Ultra DMA for IDE Driver:**

- Step 1:** Insert the provided CD-ROM disk into the CD-ROM drive.
- Step 2:** Look for the CD-ROM drive, double click on the CD-ROM icon. This will show the setup screen.
- Step 3:** Click on the “VIA Chipset Drivers” icon and the screen will show “VIA Service Pack 4.05”.
- Step 4:** Click “Next” and the screen will show three drivers: “Bus Master PCI IDE Drivers”, “AGP VxD Drivers” and “VIA Chipset Function’s Registry”. Select the “Bus Master PCI IDE Drivers” icon and click “Next”.
- Step 5:** The setup program will request you to choose “Install”, “Uninstall” or “Enable/Disable (Ultra) DMA for IDE driver”. Please select “Enable/Disable (Ultra) DMA for IDE driver” and click “Next” to continue.
- Step 6:** The setup program will show the hard drive DMA mode, please click “Next”.
- Step 7:** The setup program will request you to choose whether to restart the computer or not. Please select “Yes, I want to restart my computer now” and click Finish. The computer will restart and finish the (Ultra) DMA Enable for IDE Master.

## Chapter 6

# REALTEK® 8139B FAST ETHERNET LAN DRIVER

## 1. Overview

The Realtek 8139B is a sophisticated 32-bit PCI component, with enhanced scatter-gather bus mastering capabilities. Its true 32-bit architecture enables it to perform high speed data transfers on the PCI bus using four DMA channels.

### 1.1 Features

- IEEE 802.3/802.3u 10BASE-T and 100BASE-TX compatible
- Glueless 32-bit PCI bus master interface
- Backward software compatible to the 82557
- Internal transmit and receive FIFOs (3 kbytes each)
- Back-to-back transmit at 100 Mbps within minimum IFS
- EEPROM support for configuration and customized feature selection
- Advanced configuration and Power Interface Specification, Revision 1.0, and PCI Power Management Specification, Revision 1.0 compliant
- Remote Wake Up (Magic Packet\*) support in APM and ACPI modes
- ACPI “interesting” packet wake support in D0 to D3 low power states
- IEEE 802.3u Auto-Negotiation support for 10BASE-T and 100BASE-TX
- Full or half duplex capable at 10 or 100 Mbps
- IEEE 802.3x flow control support



## **2. LAN Driver Setup**

### **2.1 Windows® 95**

To install the driver, just insert the provided CD-ROM into the CD-ROM drive. The CD-ROM will autorun. Press the button for installing the LAN driver.

### **2.2 Other OS driver**

To install the driver for other operating system, just insert the provided CD-ROM into the CD-ROM drive.

Type:

CD-ROM Path:Network\Realtek\E100B\Setup\readme

This will show different procedure for the installation of LAN driver for different kind of operating system. Just follow the procedures given.

## Chapter 7

### **MULTIMEDIA KEYBOARD (for 5203 Panel A only)**

#### **1. Overview**

The Multimedia Keyboard combines the standard keyboard layout with 15 convenient Multimedia buttons which control the following:

- CD control buttons: Play/Pause, Previous/Fast Backward, Next/Fast Forward, Stop, and Eject.
- Volume control buttons: Volume Up, Volume Down, and Mute.
- World wide web site buttons: WWW, My Favorite, and WWW Search
- Power Management buttons: Power off, Sleep, and Wake up
- Shortcut button: provides an easy access to the document or program you most often use

## 2. Driver Setup

### 2.2 Installation for Windows 95/98

Please follow the instructions below on how to install the Multimedia Keyboard software to your PC system.

- Step 1: Insert the CD provided into your CD-ROM drive.
- Step 2: Click My Computer on the desktop of Windows® operating system, then double-click Control Panel.
- Step 3: Double-click Add New Hardware. Then click Next.
- Step 4: Click Next. The Windows 95 users skip this step.
- Step 5: Click No and Next
- Step 6: Click Keyboard in the list. Then click Next.
- Step 7: Click Have Disk.
- Step 8: In the blank text box, type the CD-ROM drive letter, followed by a colon (:), and a backslash (\), and the directory name depending on which operating system you use. For example, the command may look like these: **E:\Keyboard\BTC\5113**  
Or you may click Browse to find the correct directory. After the path is typed or selected, click OK.
- Step 9: Then you will find 'Multimedia Keyboard' in the model list on your screen. Click Next to continue.
- Step 10: Then you will find 'Multimedia Keyboard' in the model list on your screen. Click Next to continue.
- Step 11: After copying files, please click Yes to restart your computer and the installation procedures will be completed.

*If your operating system is Windows 95, after restarting the computer, the setup program will install a DCOM software to your harddisk, and the operating system needs to restart again. When the operating system restarts, the software will be loaded automatically.*

*Not embedded in Windows 95, DCOM (Distributed Component Object Model) is a new multimedia component built in Windows 98. Due to needing DCOM to run, Multimedia Keyboard driver will install it for Window 95 in setup procedures.*

---

**Note:** If you do not restart your computer, the Multimedia Buttons on your keyboard and the software will not work. Now the Multimedia Keyboard icon is shown on the taskbar of Windows®, and the 15 multimedia buttons on your keyboard are working.

### **2.3 Installation for Windows NT 4.0**

Please follow the instructions below on how to install the Multimedia Keyboard software to your PC system.

- Step 1: Insert the CD provided into your CD-ROM drive.
- Step 2: Click My Computer on the desktop of Windows® operating system, then double-click Control Panel.
- Step 3: Double-click Keyboard icon.
- Step 4: Click General folder. Then click Change.
- Step 5: Click Have Disk.
- Step 6: In the blank text box, type the CD-ROM drive letter, followed by a colon (:), and a backslash (\), and the directory name 'Keyboard\BTC\5113'.  
Or you may click Browse to find the correct directory. After the path is typed or selected, click OK.
- Step 7: Then you will find 'Multimedia Keyboard' in the model list on your screen. Click OK.
- Step 8: Now Windows is going to copy the necessary files to a sub-directory titled C:\PROGRAM FILES\MEDIAKEY\ in your hard disk. Click Close.
- Step 9: After copying files, please click Yes to restart your computer and the installation procedures will be completed. When the operating system restarts, the software will be loaded automatically.

**Note:** If you do not restart your computer, the Multimedia Buttons on your keyboard and the software will not work.

Now the Multimedia Keyboard icon is shown on the taskbar of Windows®, and the 15 multimedia buttons on your keyboard are working.

### **2.3 Uninstallation**

If you want to re-install the driver, you have to uninstall the driver first.

Step 1: Right-click the Multimedia Keyboard icon on the taskbar to pop up the setting menu.

Step 2: Click Exit to remove the Multimedia Keyboard driver from system memory.

Step 3: Click My Computer on the desktop of Windows® operating system, then double-click Control Panel.

Step 4: Double-click Add/Remove Programs icon.

Step 5: Select MediaKey in the list and click Add/Remove.

Step 6: Click OK to make sure you want to uninstall.





Please make sure that you have exited the driver first (steps 1 and 2).











Otherwise the uninstallation can not be done completely.

### 3. Multimedia Button Function

**Note:** Please make sure your system has properly installed the software and the hardware before you use the Multimedia Buttons.

The 15 Multimedia Buttons on the keyboard are labeled as following.

Icon	Function Name	Function Description
	WWW	launches to your Internet Browser application which should be pre-installed.
	Shortcut	provides you to create an easy access to the documents and programs you use most often. You have to use the Multimedia Keyboard Driver to define this Shortcut button. Please refer to the next chapter.
	My Favorite	launches to your Internet Browser application and opens My Favorite menu to provide you to select your favorite web site.
	WWW Search	launches to your Internet Browser application and go to a 'search' web site. If your Internet browser is Internet Explorer, the default web site is 'Yahoo! SearchBar Home Page' at ' <a href="http://www.yahoo.com/search/ie.html">http://www.yahoo.com/search/ie.html</a> '. If your Internet browser is Netscape, the default web site is 'Netscape Search' at ' <a href="http://home.netscape.com/search/">http://home.netscape.com/search/</a> '.

	Volume Down	lowers the volume of your audio output to the speakers.
	Volume Up	raises the volume of your audio output to the speakers.
	Mute	mutes the sound output. Repress this button to resume.
	Previous/ Fast Backward	skips backward to the previous file/track when pressing once quickly. If you keep pressing the button, the file/track will play backward fast. Once the button is released, the file/track plays normally.
	Play/Pause	starts to play the audio/video file in the current track. When the CD or Video is playing, press this button to pause it, and press the button again to resume it from the current position.
	Stop	stops the playing.
	Next / Fast Forward	skips forward to the next file/track when pressing once quickly. If you keep pressing the button, the file/track will play forward fast. Once the button is released, the file/track plays normally.
	Eject	ejects the CD tray.
	Power off	powers down the system.
	Sleep	puts the system to sleep (power-saving).
	Wake up	wakes up the system

---

### **3.1 About Play Function**

The Play function can play audio/video compact disc, and the video files (.AVI, .MPG, .MOV). Once you place a disc into the CD-ROM drive and press the Play button, the software will detect whether the disc is an Audio CD or a Video CD and then play. If neither audio nor video disc is on the CD-ROM drive, and the Play button is pressed, a dialog box will appear to help you find and select a video file to play.

If two CD-ROM drives are installed in your system, only the prior one can be controlled.

### **3.2 About 3 Power Management Buttons**

Three Power Management Buttons are the Power off, Sleep, and Wake up buttons. Using the 3 Power Management buttons needs particular system requirements. Please refer to *System Requirements* for detailed information.