

System Board Specifications

CPU:

- Supports Intel 486 SX / DX / DX2 / DX-4 CPUs, AMD 486 DX / DX2 / DX4-100 CPUs, Cyrix M7 CPUs and 4 V CPUs

Cache memory:

- Supports 128K, 256K, 512K or 1M cache memory

Main memory:

- Supports eight memory banks using four 72-pin SIMM modules with 4M, 8M, 16M, 32M DRAM.

Slots:

- Three 32-bit Master PCI Bus slots and four 16-bit ISA bus slots in maximum combinations of four 16-bit ISA and three PCI slots.

Battery:

- 3V Li battery

Dimensions:

- Standard baby-AT size: 25 x 22 cm x 4 layer PCB

Mounting:

- 6 mounting holes

System Board Layout

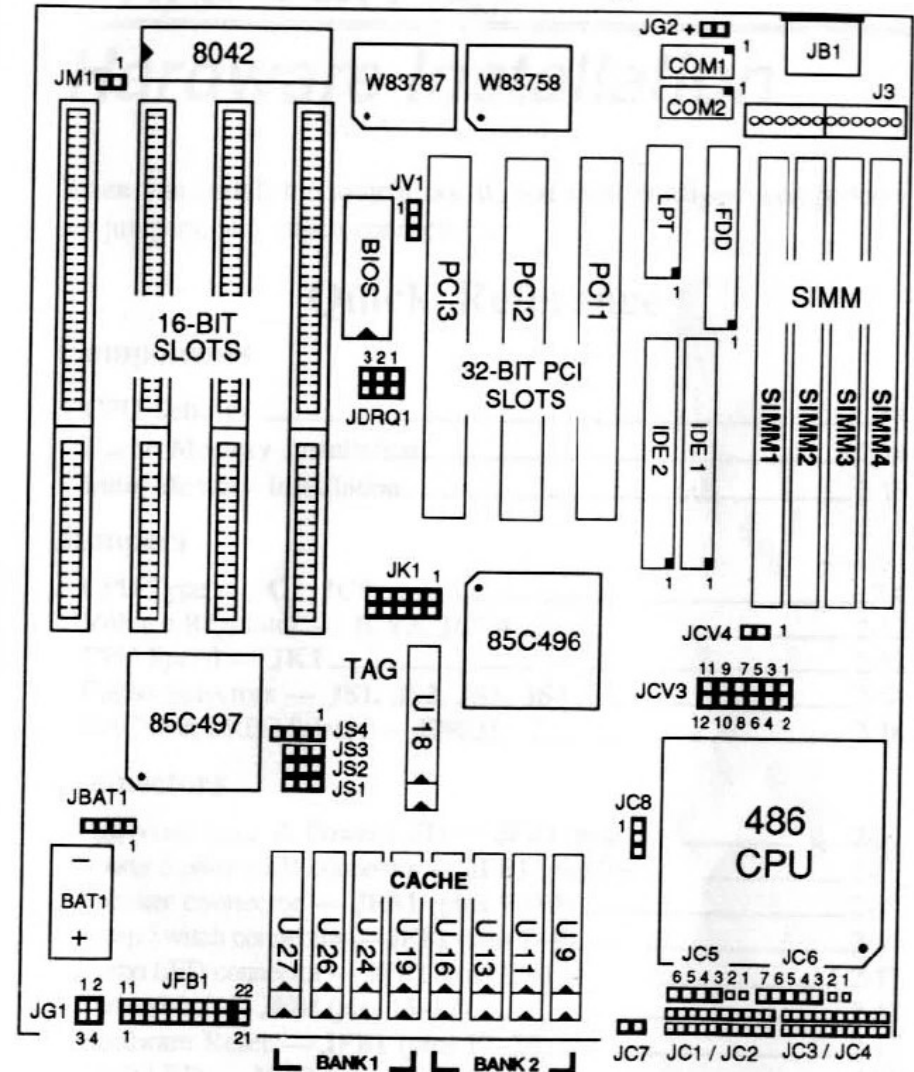

Figure 1-1. System board Layout

CPU Type Jumpers: JC1~JC8

JC1~JC8 set the system board to recognize the type of CPU that is installed. Set JC1~JC8 according to your CPU type as shown below.

** *Make sure that you set the board's jumpers according to your CPU type as described on the pages that follow.*

486SX Settings - SX CPU without Green functions

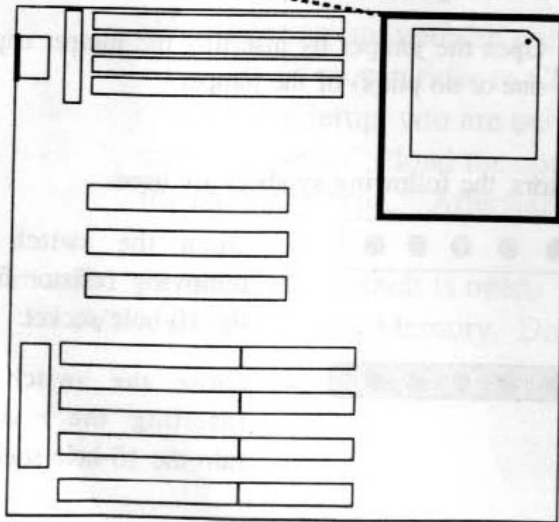
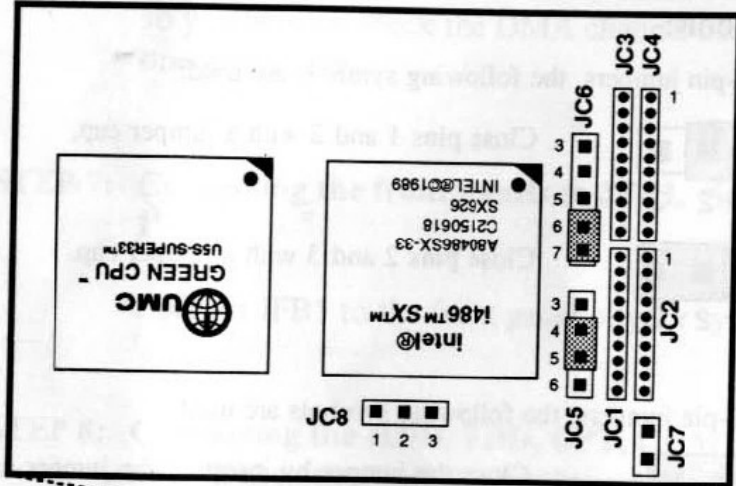

486SX Settings - Intel SX CPU with Green functions The CPU is marked with "5V1X."

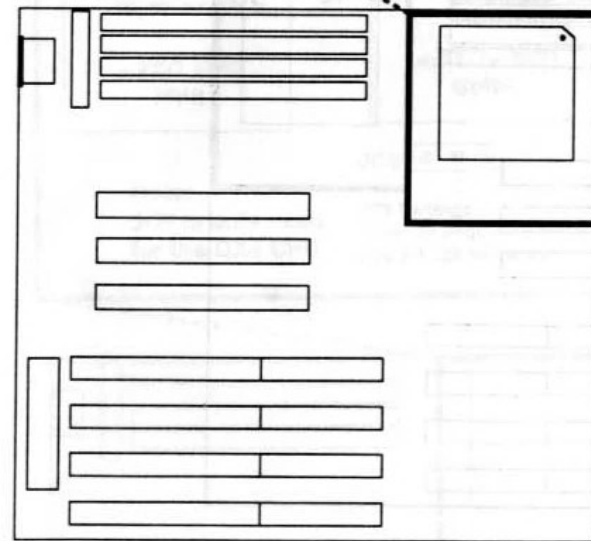
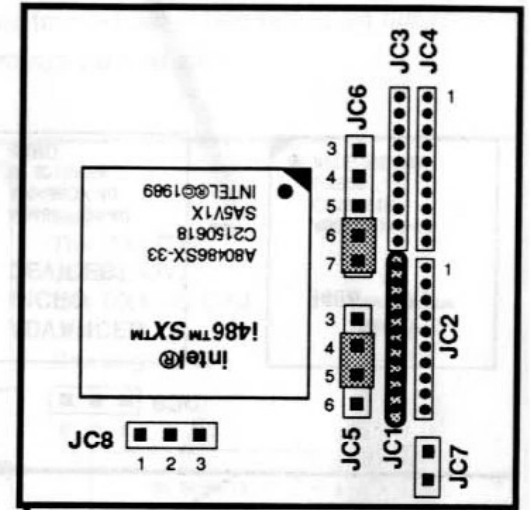

486DX/DX2 Settings - Intel CPU without Green function or AMD 486 DX/DX2 CPU.

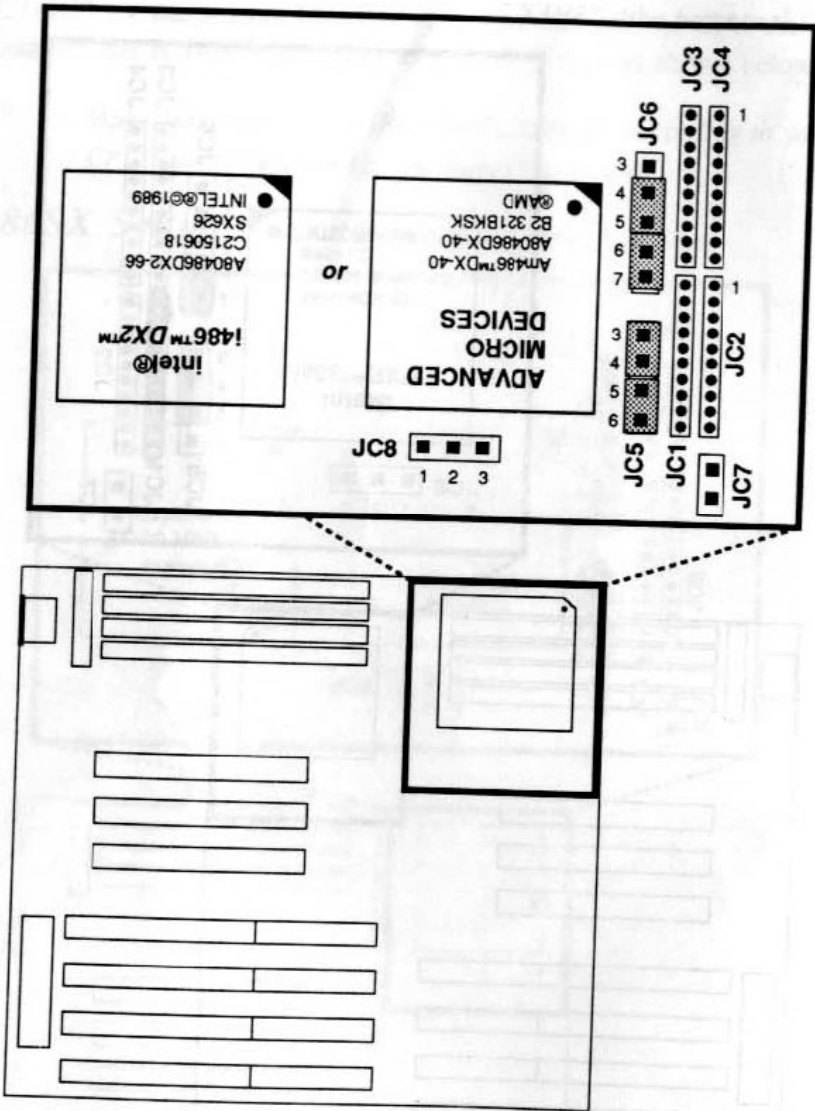

486DX/DX2/DX4/DX4OD Settings - Intel CPU with Green function including 486DX, 486DX2, or 486DX4 CPUs.

Note: For Intel 486DX Overdrive or 487SX CPUs, change the 4-5 closed pin setting to a 3-4 pin closed setting on jumper JC6. All other jumper settings stay the same.

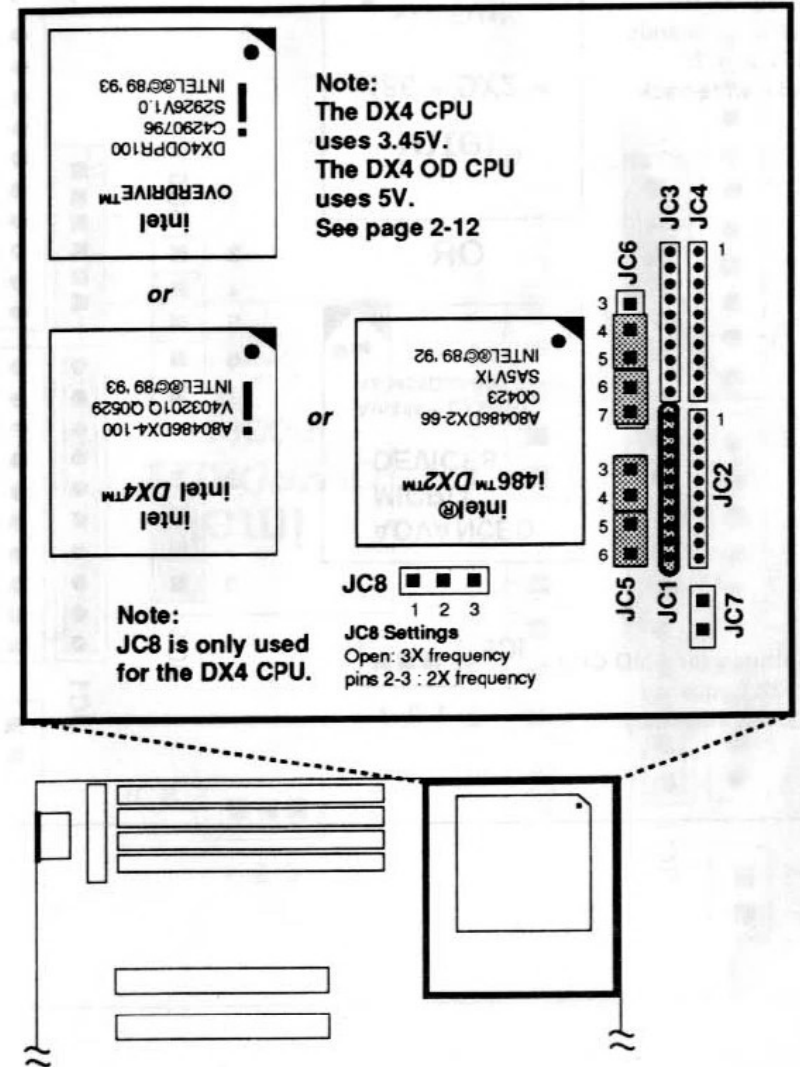

Intel P24D and AMD Enhanced Am486 Settings

Intel CPUs marked with "W5V1X" and AMD CPUs marked with "SV8B" can support Write-Back mode for the CPU's internal cache.

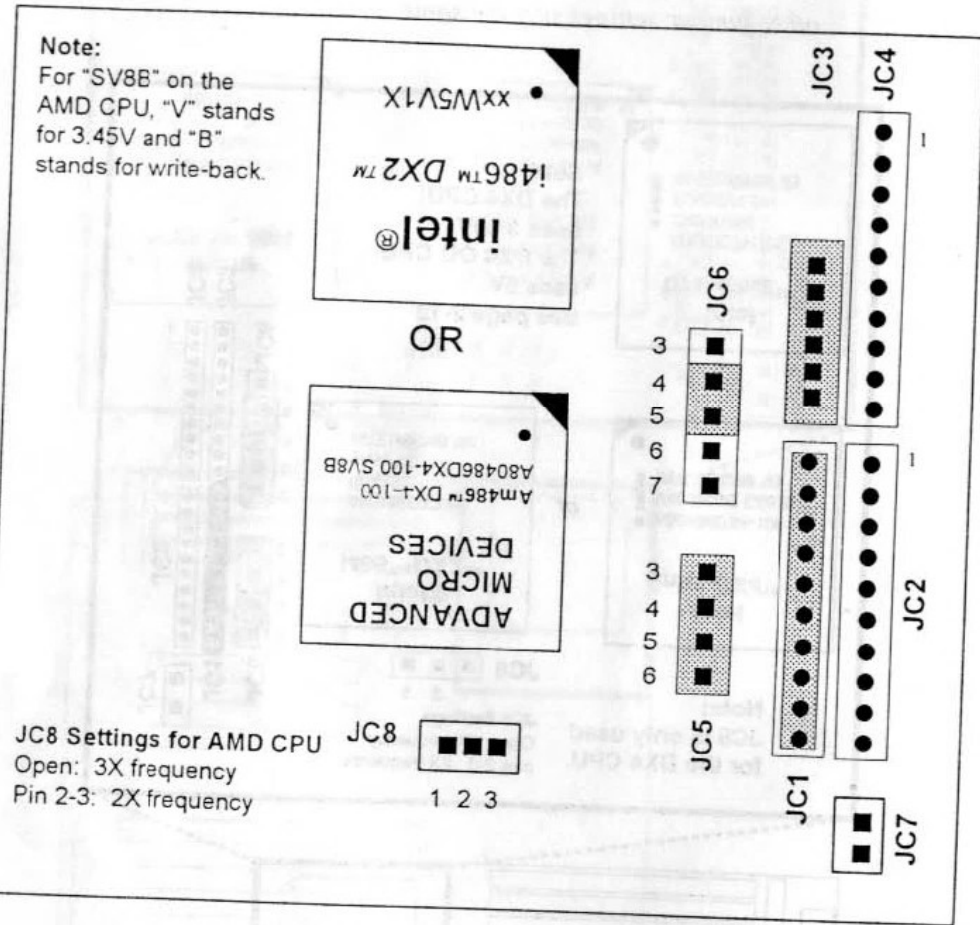

Intel P24T (Pentium OverDrive) Settings

Intel Pentium OverDrive, which is commonly referred to as P24T, is sold with a heatsink and a fan attached on top of it.

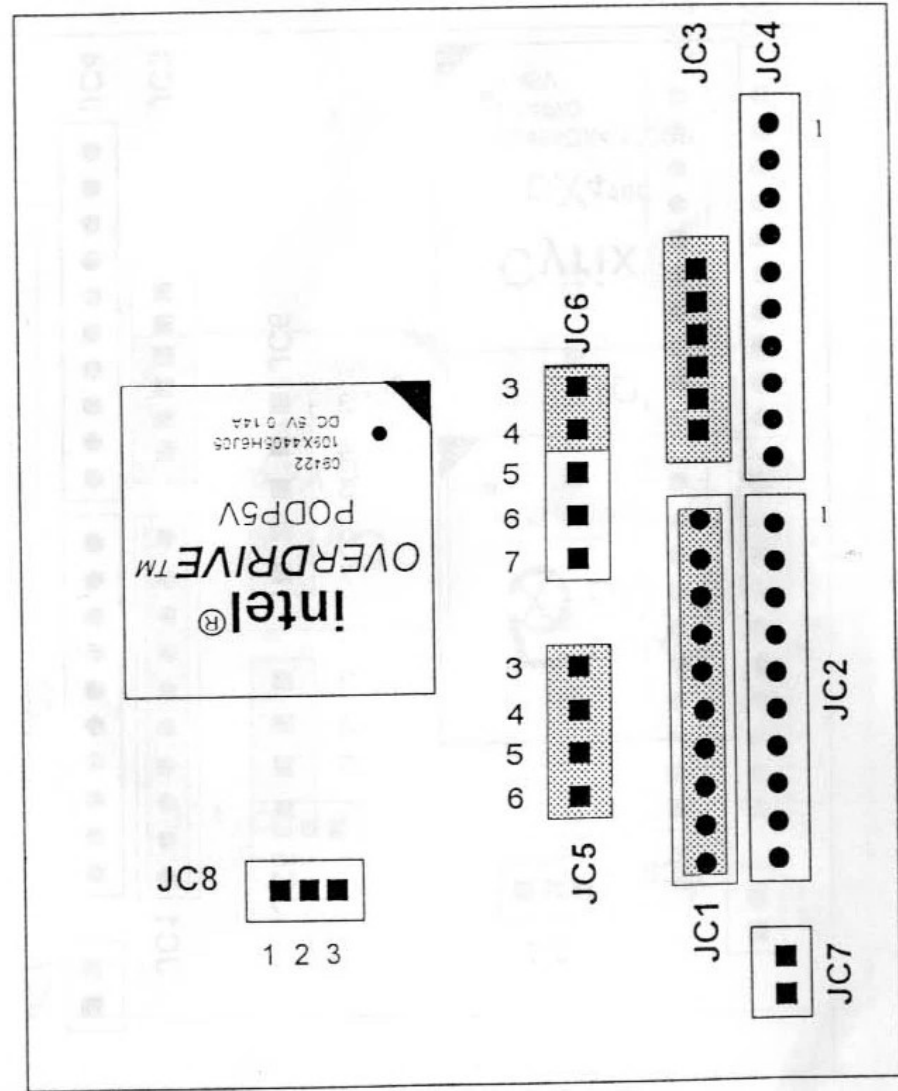

Cyrix 5x86 and Cyrix DX4 with Intel DX4 pin-out Settings

The voltage for these CPUs must be set to 3.45V.

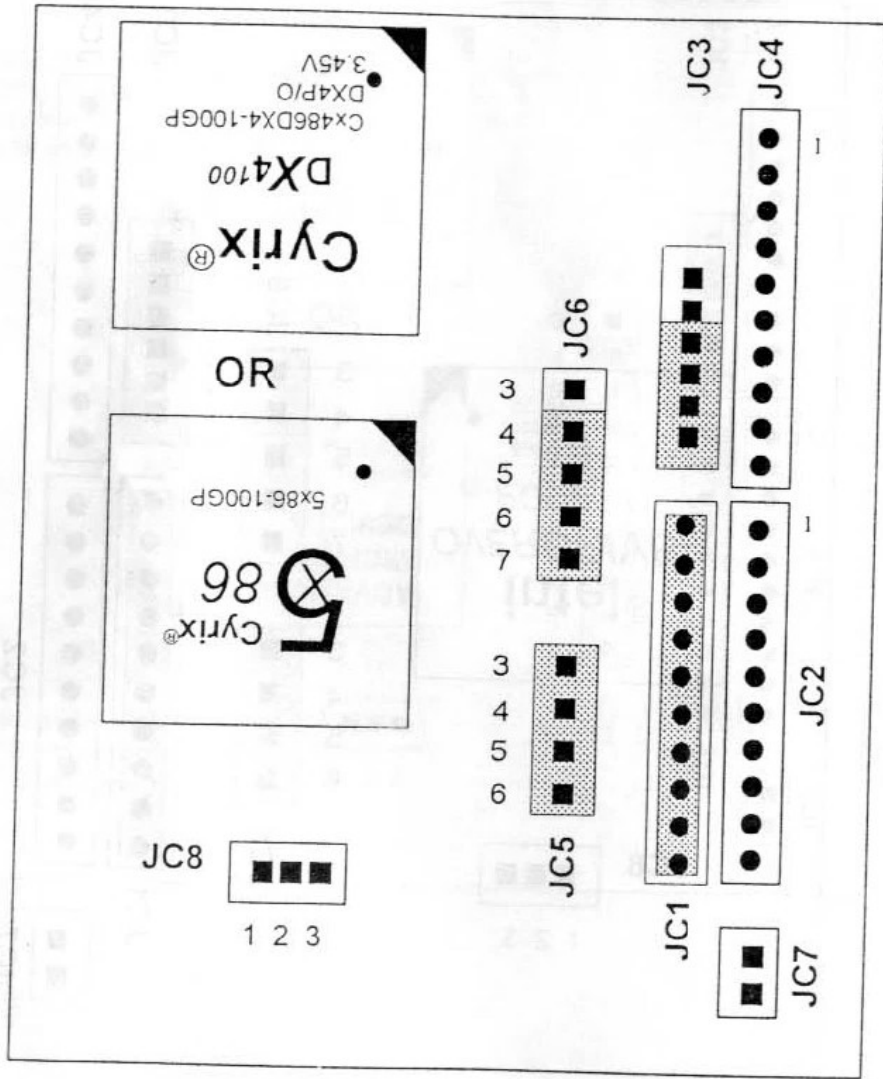

Cyrix DX4 with M7 pin-out Settings

The voltage for this CPU must be set to 3.45V.

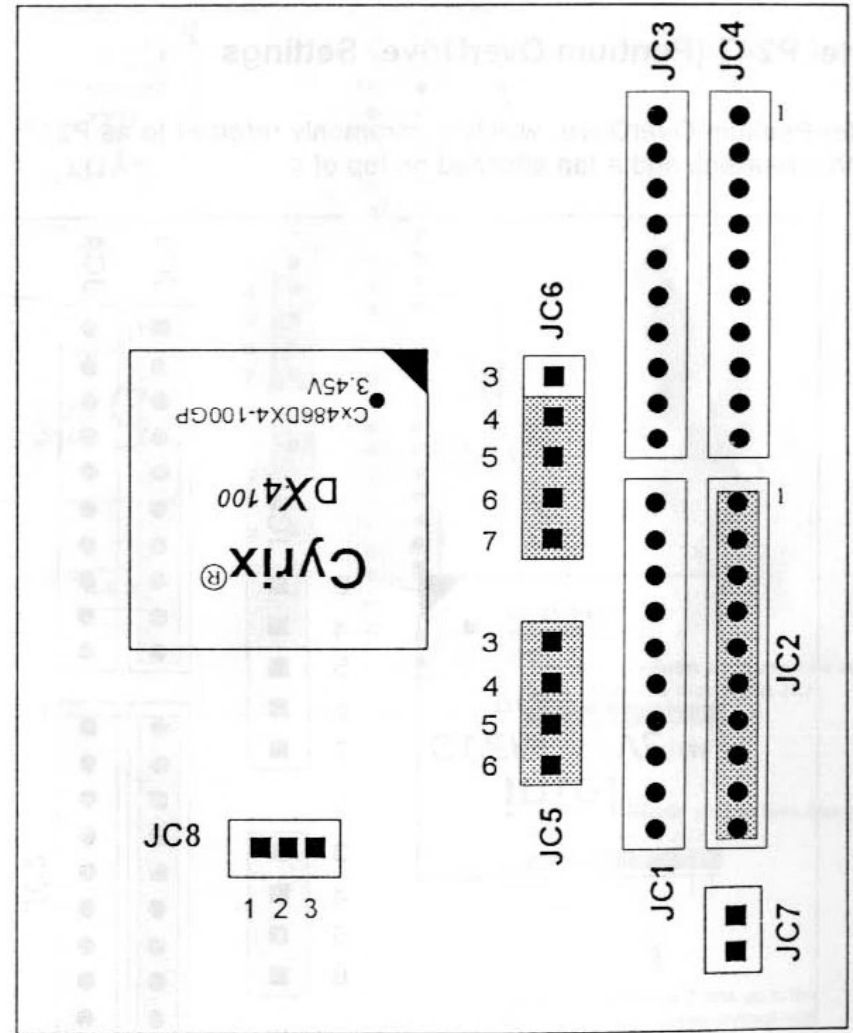

If JC3 was not changed to 1x6 pin array, follow the jumper settings mentioned in the user's manual. For CPUs not mentioned in the user's manual, see below.

Intel P24T (Pentium OverDrive) Settings

Intel Pentium OverDrive, which is commonly referred to as P24T, is sold with a heatsink and a fan attached on top of it.

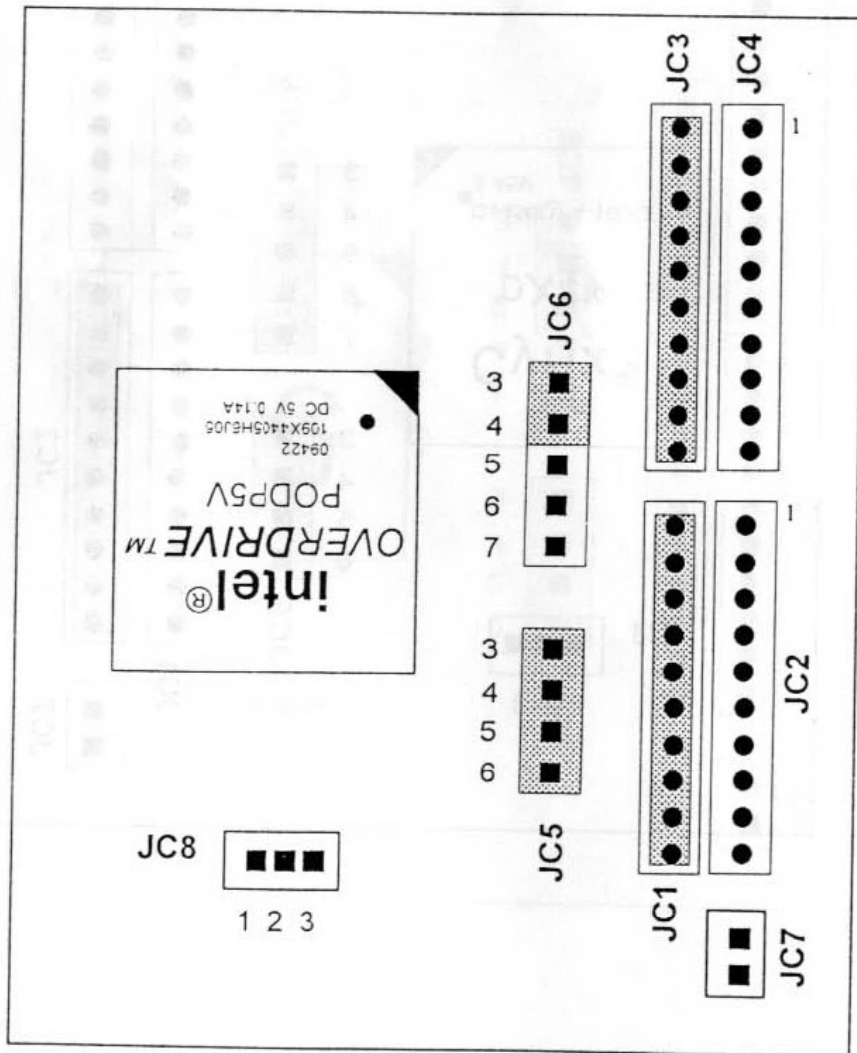

Cyrix 5x86 and Cyrix DX4 with Intel DX4 pin-out Settings

The voltage for these CPUs must be set to 3.45V.

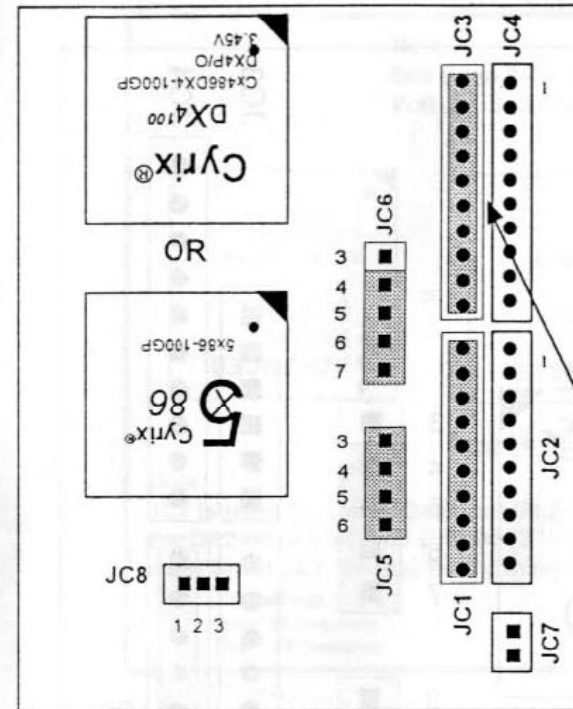

The 10-pin resistor array must be cut before it can be inserted in JC3.



Cut the 2 middle pins to look like this. Then insert in JC3.



Be sure to cut these 2 pins up to the root, so as not to cause contact with the mainboard's connector.

After you cut these 2 pins, you cannot use this to choose other CPU types.

Cyrix DX4 with M7 pin-out Settings

The voltage for this CPU must be set to 3.45V.

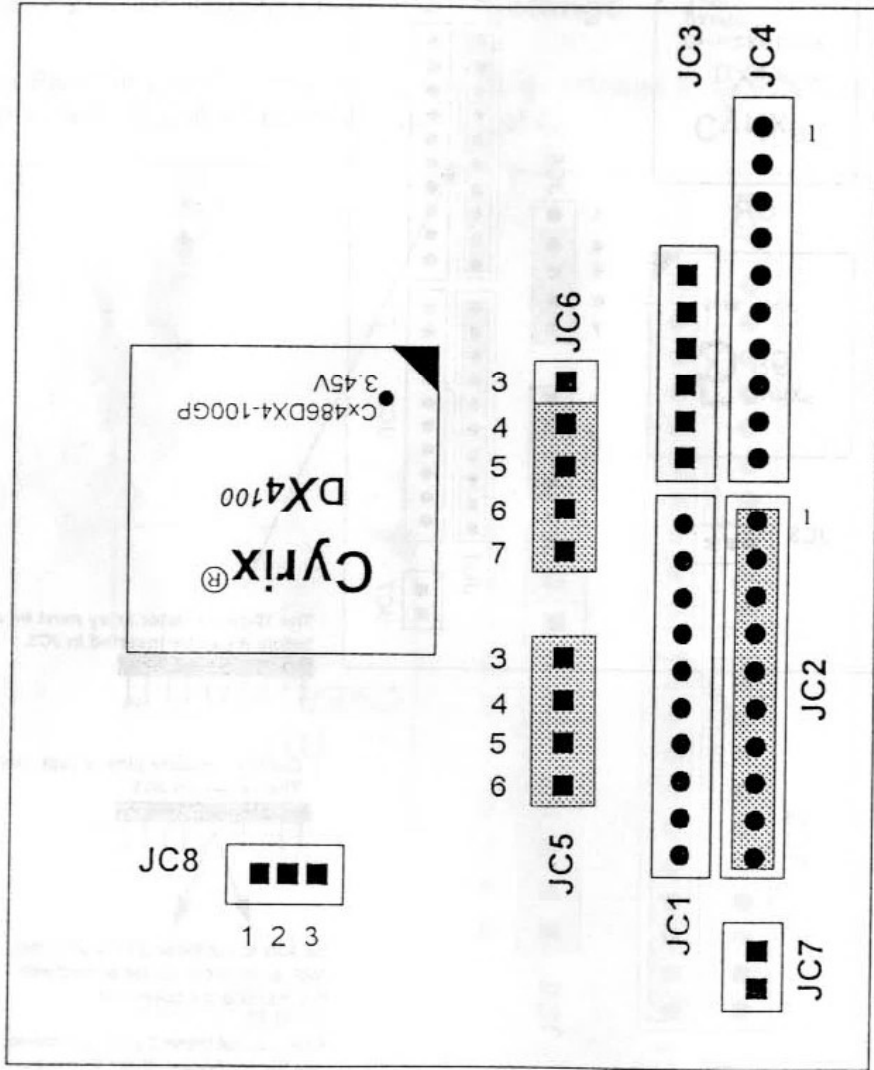

AMD 486DX Settings - includes DX2-66, DX2-80, and DX4-100. These CPUs are marked with "3 VOLT". Note that you must set the CPU Vcc to 3.45V.

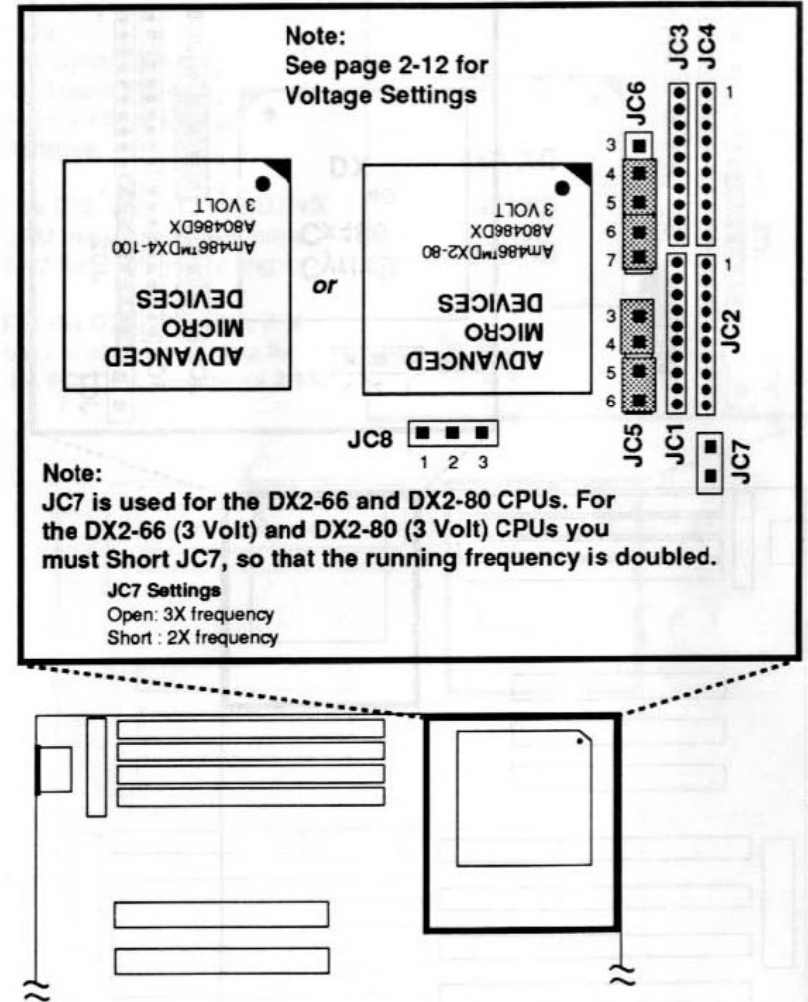

Cyrix M7 Settings

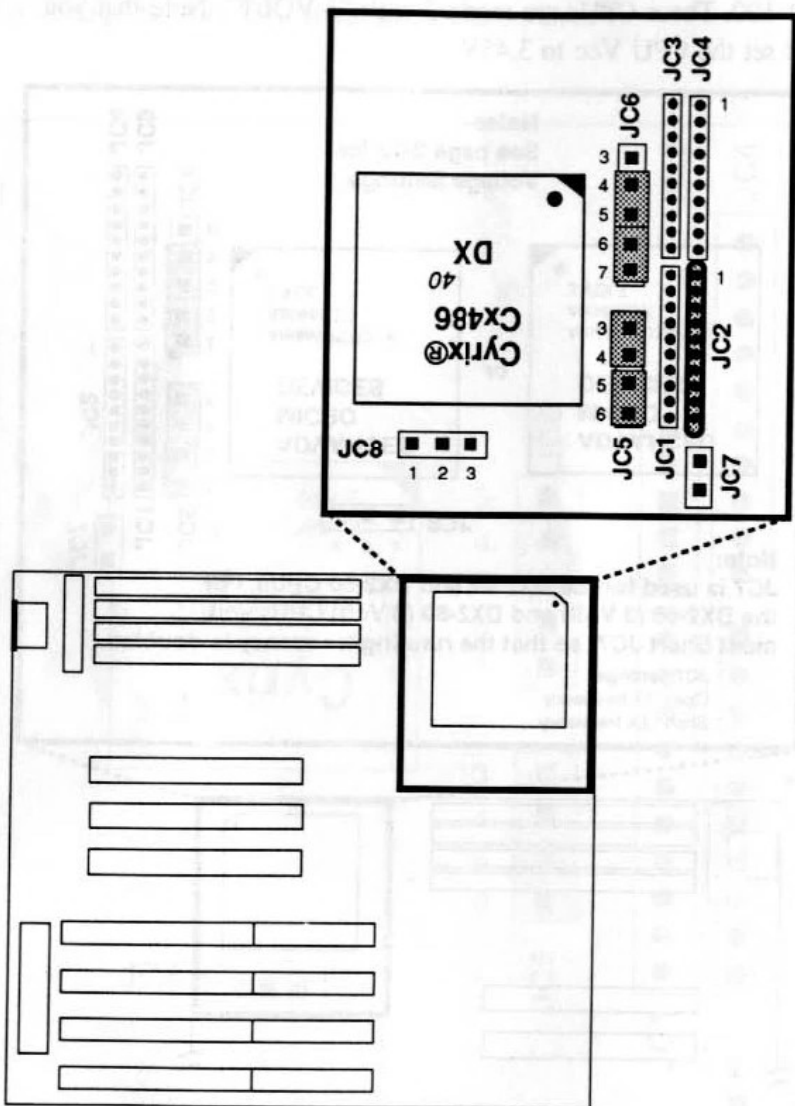

Cyrix Cx486 4V Settings

Note:
The Cyrix DX2-v80 CPU uses 4V. Refer to page 2-12 for Voltage Settings.

The DX2 v50/DX2 v66/DX v33 CPU uses 3.45V. See page 2-12 for Voltage Settings.

For the DX2-v80 CPU, it is best to choose 40MHz for the PCI CLK. See page 2-13.

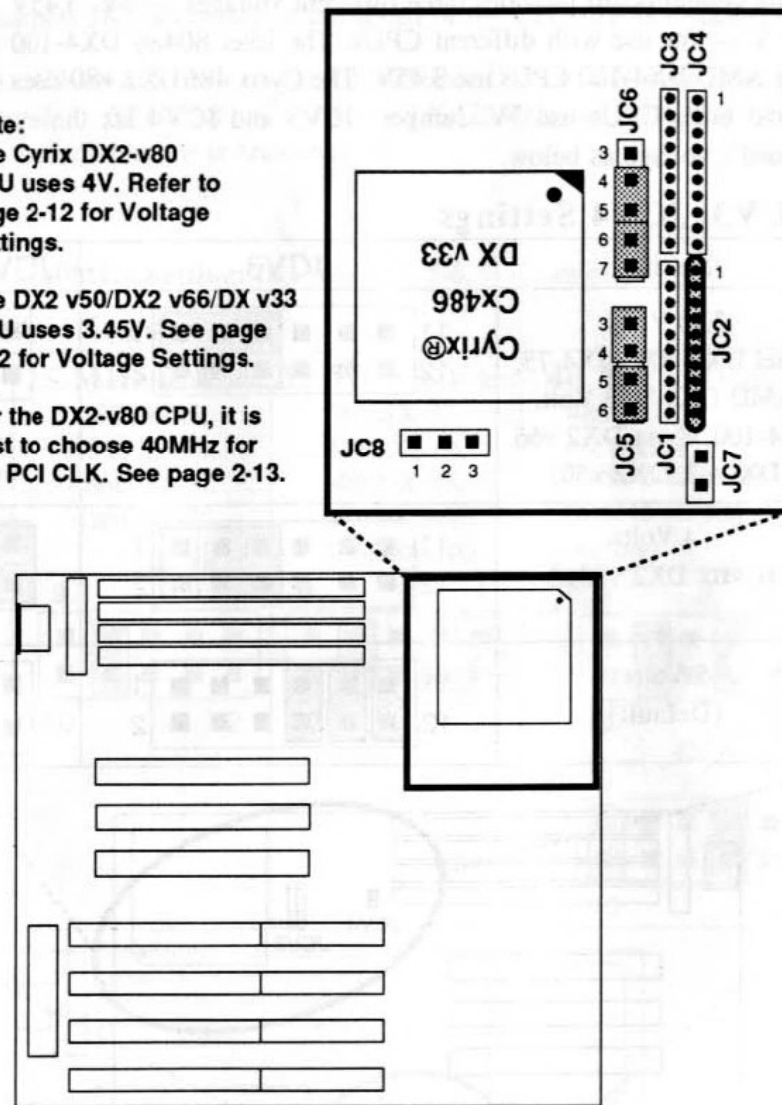

Voltage Regulating Jumpers: JCV3~4

This system board provides three different voltages — 5V, 3.45V and 4 V — for use with different CPUs. The Intel 80486 DX4-100 and the AMD DX4-100 CPUs use 3.45V. The Cyrix 486DX2 v80 uses 4V. Most other CPUs use 5V. Jumpers JCV3 and JCV4 set the system board's voltage as below.

JCV3, JCV4 Settings

Setting	JCV3	JCV4
3.45 Volts (Intel DX4-100, DX4-75, AMD DX2-80 3 Volt, DX4-100, Cyrix DX2 v66, DX v33, DX2 v50)		
4 Volts (Cyrix DX2 v80)		
5 Volts (Default)		

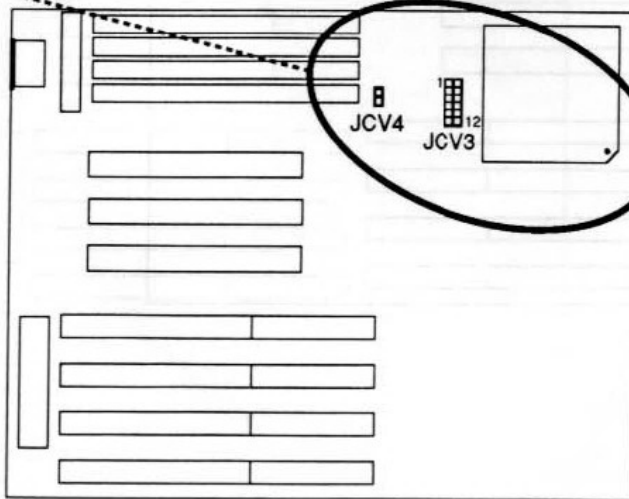

CPU Speed: JK1

Set jumpers JK1 according to the speed of the CPU that is installed.

Note: There are two settings for 40MHz. ① PCI CLK = 40MHz = 1 CPUCLK. ② PCI CLK=20MHz = 1/2 CPUCLK. Performance is better with ①

Note: 50MHz Setting: JK1 pins 1-2, 5-6, 9-10 are closed.

JK1 Settings

Jumper	25 MHz includes: 486SX-25, 486SX2-50, 486DX2-50, 486DX4-75	33 MHz includes: 486SX-33, 486SX2-66, 486DX-33, 486DX2-66, 486DX4-100	40 MHz includes: 486DX-40, 486DX2-80 Cyrix DX2 v80 (best to set for ① below)
JK1			<p>①</p> <p>or</p> <p>②</p>

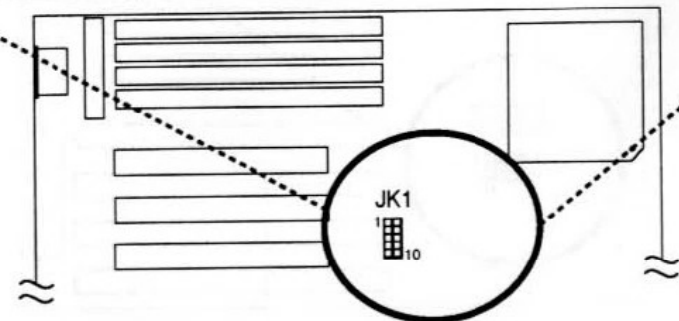

Cache Selection: JS1, JS2, JS3, JS4

The system board supports 128K, 256K, 512K, or 1M of cache memory. You configure cache memory by installing 32K8, 64K8, or 128K8 SRAM chips in Data RAM sockets U9~U27, and a 8K8, 16K8, 32K8 or 64K8 SRAM chip in Tag socket U18. You then set jumpers JS1, JS2, JS3 and JS4 as below. Note that speed required for SRAM chips is 20ns.

Cache Size and Memory Locations

Cache Size	Tag RAM (U18)	Data RAM (U19, U24, U26, U27)	Data RAM (U9, U11, U13, U16)
128K	8K8, 16K8, or 32K8	32K8	None
256K (32K8)	16K8 or 32K8	32K8	32K8
256K (64K8)	16K8 or 32K8	64K8	None
512K (64K8)	32K8	64K8	64K8
512K (128K8)	32K8	128K8	None
1M (128K8)	64K8	128K8	128K8

JS1~JS4: Cache Size Settings

Cache Size	JS4 JS3 JS2 JS1	Cache Size	JS4 JS3 JS2 JS1
128K (32K8)		512K (64K8)	
256K (32K8)		512K (128K8)	
256K (64K8)		1M (128K8)	

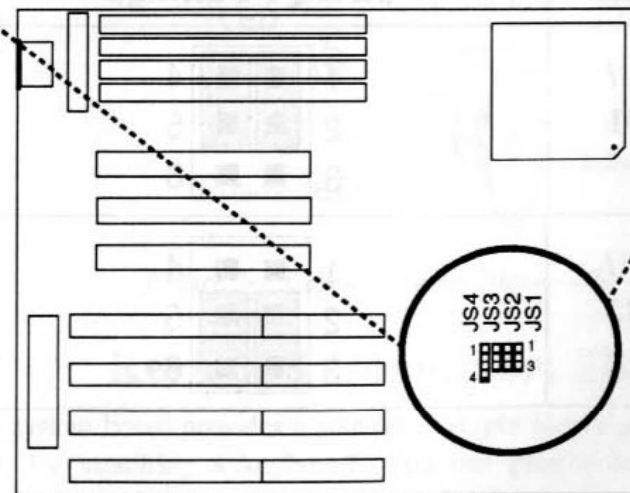

Memory Bank Configuration

The system board provides four 72-pin Single In-line Memory Module (SIMM) sockets on-board, numbered SIMM1~SIMM4. Each socket accepts single bank or double bank SIMM. You can install four single bank SIMM or a maximum of four double bank SIMM. There is no need to set jumpers for memory configuration. You can install any SIMM on any socket.

DAck# and DREQ Selector: JDRQ1

When the on-board printer port is set to ECP, you should also set the DMA channel used by the ECP. The system board provides DREQ 1, 3, and DACK #1, #3 for you to set. You must set the DREQ and DACK# channels the same way. See Figure 1-1 for the jumper's location.

If you use a sound card or a network card, you should make sure this jumper is open. The factory default setting is open (no jumper caps on JDRQ1).

Description	JDRQ1 Settings
DREQ1 / DACK#1	
DREQ3 / DACK#3	

Case Connector Block: JFB1

The Turbo LED, Turbo Switch, Hardware Reset, Keylock, Power LED, Power Saving LED, Sleep Switch, Speaker and HDD LED all connect to the JFP Connector Block as shown below. See Figure 1-1 for JFB1's location.

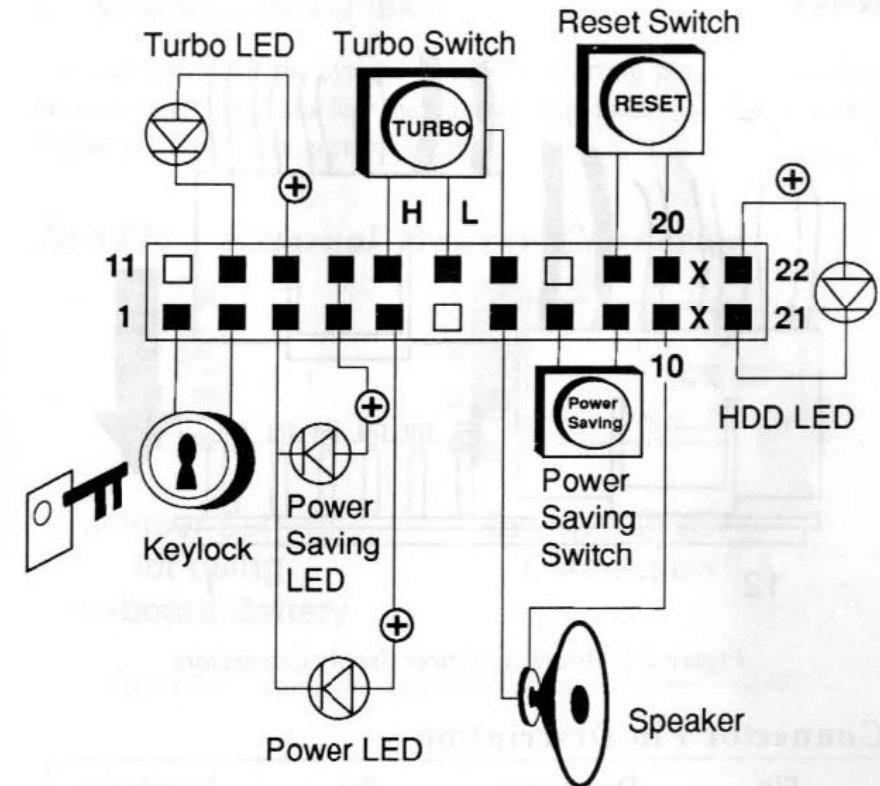

Figure 2-1. Case Connector Block - JFP

Keyboard Connector: JB1

The system board provides a standard five-pin female DIN connector, JB1, for attaching a keyboard. You can plug a keyboard cable directly into this connector. See Figure 1-1 for connector location.

Power Supply Connector: J3

The power supply connector is a twelve-pin male connector. Dual connectors from the power supply can fit in only one direction. Make sure to attach the connectors with the two black wires at the center, as show in the diagram below. See Figure 1-1 for the connector's location.

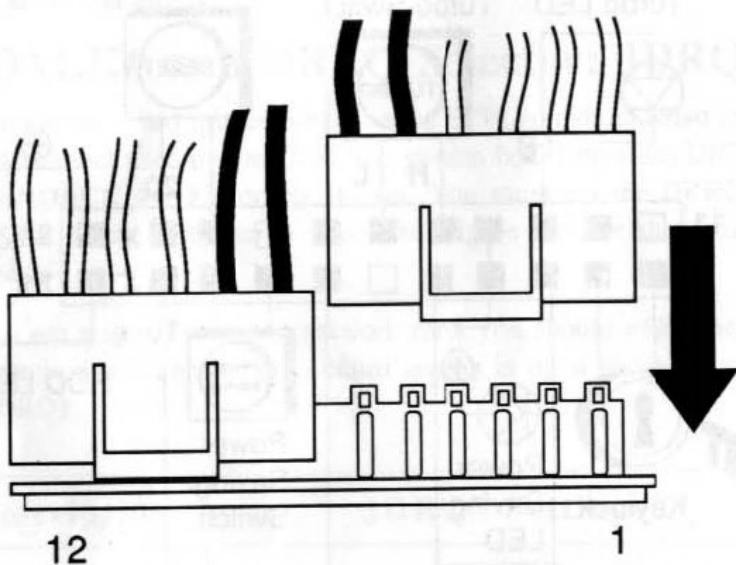

Figure 2-2. Attaching Power Supply Connectors

Connector Pin Description

Pin	Description	Pin	Description
1	Power Good	7	Ground
2	+5V DC	8	Ground
3	+12V DC	9	-5V DC
4	-12V DC	10	+5V DC
5	Ground	11	+5V DC
6	Ground	12	+5V DC

External Battery Connector: JBAT1

A battery must be used to retain the system board configuration in CMOS RAM. You can use either the on-board battery or an external battery. If you use the on-board battery you must short pins 2-3 of JBAT1. For an external battery, the battery's cable connector attaches to pins 1 and 4 of JBAT1.

You can also clear the system CMOS by shorting pins 3-4 for a brief moment and then placing the jumper cap back on pins 2-3. See Figure 1-1 for the connector's location.

JBAT1: External Battery Connector

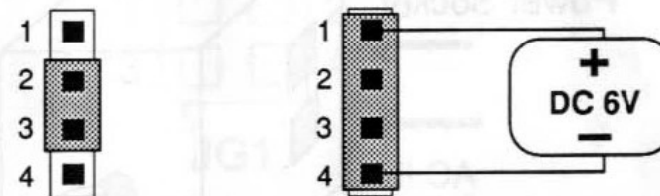

Jumper Setting
for using
on-board Battery

External Battery
Connection

Figure 2-3. Setting the External Battery Connector - JBAT1