



When you installing AGP card, please make sure the following notice is fully understood and practiced. If your AGP card has "AGP 4X/8X (1.5V) notch"(show below), please make sure your AGP card is AGP 4X/8X.



**Caution: AGP 2X card is not supported by Intel® 845(GE/PE) / 845(E/G) / 850(E) / E7205 / 865(G/PE/P) / 875P. You might experience system unable to boot up normally. Please insert an AGP Pro 4X/8X card.**



Example 1: Diamond Vipper V770 golden finger is compatible with 2X/4X mode AGP slot. It can be switched between AGP 2X(3.3V) or 4X(1.5V) mode by adjusting the jumper. The factory default for this card is 2X(3.3V). The GA-8KNXP / GA-8I875 Ultra (or any AGP Pro 4X/8X only) motherboards might not function properly, if you install this card without switching the jumper to 4X(1.5V) mode in it.

Example 2: Some ATi Rage 128 Pro graphics cards made by "Power Color", the graphics card manufacturer & some SiS 305 cards, their golden finger is compatible with 2X(3.3V) / 4X(1.5V) mode AGP slot, but they support 2X(3.3V) only. The GA-8KNXP / GA-8I875 Ultra (or any AGP Pro 4X/8X only) motherboards might not function properly, If you install this card in it.

Note : Although Gigabyte's AG32S(G) graphics card is based on ATi Rage 128 Pro chip, the design of AG32S(G) is compliance with AGP 4X(1.5V) specification. Therefore, AG32S(G) will work fine with Intel® 845(GE/PE) / 845(E/G) / 850(E) / E7205 / 865(G/PE/P) / 875P based motherboards.



Before you install PCI cards, please remove the Dual BIOS label from PCI slots if there is one.



- 💣 **The author assumes no responsibility for any errors or omissions that may appear in this document nor does the author make a commitment to update the information contained herein.**
- 💣 **Third-party brands and names are the property of their respective owners.**
- 💣 **Please do not remove any labels on motherboard, this may void the warranty of this motherboard.**
- 💣 **Due to rapid change in technology, some of the specifications might be out of date before publication of this booklet.**



**WARNING:** *Never run the processor without the heatsink properly and firmly attached. PERMANENT DAMAGE WILL RESULT!*

**Mise en garde :** *Ne faites jamais tourner le processeur sans que le dissipateur de chaleur soit fixé correctement et fermement. UN DOMMAGE PERMANENT EN RÉSULTERA !*

**Achtung:** *Der Prozessor darf nur in Betrieb genommen werden, wenn der Wärmeleiter ordnungsgemäß und fest angebracht ist. DIES HAT EINEN PERMANENTEN SCHADEN ZUR FOLGE!*

**Advertencia:** *Nunca haga funcionar el procesador sin el disipador de calor instalado correcta y firmemente. ¡SE PRODUCIRÁ UN DAÑO PERMANENTE!*

**Aviso:** *Nunca execute o processador sem o dissipador de calor estar adequado e firmemente conectado. O RESULTADO SERÁ UM DANO PERMANENTE!*

**警告:** *將散熱板牢固地安裝到處理器上之前，不要運行處理器。過熱將永遠損壞處理器！*

**警告:** *將散熱器牢固地安裝到處理器上之前，不要運行處理器。過熱將永遠損壞處理器！*

**경고:** *히트싱크를 제대로 또 단단히 부착시키지 않은 채 프로세서를 구동시키지 마십시오. 영구적 고장이 발생할합니다!*

**警告:** *永久的な損傷を防ぐため、ヒートシンクを正しくしっかりと取り付けるまでは、プロセッサを動作させないようにしてください。*

## Declaration of Conformity

We, Manufacturer/Importer  
(full address)

**G.B.T. Technology Trading GmbH**  
**Ausschlagler Weg 41, 1F, 20537 Hamburg, Germany**

declare that the product  
( description of the apparatus, system, installation to which it refers)

### **Mother Board**

GA-8KNXP / GA-8I875 Ultra  
is in conformity with

(reference to the specification under which conformity is declared)  
in accordance with 89/336 EEC-EMC Directive

<input type="checkbox"/> EN 55011	Limits and methods of measurement of radio disturbance characteristics of industrial,scientific and medical (ISM high frequency equipment	<input type="checkbox"/> EN 61000-3-2* <input checked="" type="checkbox"/> EN 60555-2	Disturbances in supply systems cause by household appliances and similar electrical equipment "Harmonics"
<input type="checkbox"/> EN 55013	Limits and methods of measurement of radio disturbance characteristics of broadcast receivers and associated equipment	<input type="checkbox"/> EN 61000-3-3* <input checked="" type="checkbox"/> EN 60555-3	Disturbances in supply systems cause by household appliances and similar electrical equipment "Voltage fluctuations"
<input type="checkbox"/> EN 55014	Limits and methods of measurement of radio disturbance characteristics of household electrical appliances, portable tools and similar electrical apparatus	<input checked="" type="checkbox"/> EN 50081-1 <input checked="" type="checkbox"/> EN 50082-1	Generic emission standard Part 1: Residual commercial and light industry Generic immunity standard Part 1: Residual commercial and light industry
<input type="checkbox"/> EN 55015	Limits and methods of measurement of radio disturbance characteristics of fluorescent lamps and luminaries	<input type="checkbox"/> EN 55081-2	Generic emission standard Part 2: Industrial environment
<input type="checkbox"/> EN 55020	Immunity from radio interference of broadcast receivers and associated equipment	<input type="checkbox"/> EN 55082-2	Generic emission standard Part 2: Industrial environment
<input checked="" type="checkbox"/> EN 55022	Limits and methods of measurement of radio disturbance characteristics of information technology equipment	<input type="checkbox"/> ENV 55104	Immunity requirements for household appliances tools and similar apparatus
<input type="checkbox"/> DIN VDE 0855 <input type="checkbox"/> part 10 <input type="checkbox"/> part 12	Cabled distribution systems; Equipment for receiving and/or <b>distribution</b> from sound and television signals	<input type="checkbox"/> EN50091-2	EMC requirements for uninterruptible power systems (UPS)

CE marking

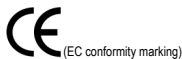

**The manufacturer also declares the conformity of above mentioned product with the actual required safety standards in accordance with LVD 73/23 EEC**

<input type="checkbox"/> EN 60065	Safety requirements for mains operated electronic and related apparatus for household and similar general use	<input type="checkbox"/> EN 60950	Safety for information technology equipment including electrical bussiness equipment
<input type="checkbox"/> EN 60335	Safety of household and similar electrical appliances	<input type="checkbox"/> EN 50091-1	General and Safety requirements for uninterruptible power systems (UPS)

**Manufacturer/Importer**

(Stamp)

Date : August 20, 2003

Signature:  
Name:

Timmy Huang  
Timmy Huang

# DECLARATION OF CONFORMITY

Per FCC Part 2 Section 2.1077(a)



**Responsible Party Name: G.B.T. INC. (U.S.A.)**

**Address: 17358 Railroad Street  
City of Industry, CA 91748**

**Phone/Fax No: (818) 854-9338/ (818) 854-9339**

hereby declares that the product

**Product Name: Motherboard**

**Model Number: GA-8KNXP / GA-8I875 Ultra**

Conforms to the following specifications:

FCC Part 15, Subpart B, Section 15.107(a) and Section 15.109(a),  
Class B Digital Device

## **Supplementary Information:**

This device complies with part 15 of the FCC Rules. Operation is subject to the following two conditions: (1) This device may not cause harmful and (2) this device must accept any inference received, including that may cause undesired operation.

Representative Person's Name: ERIC LU

Signature: *Eric Lu*

Date: August 20, 2003

GA-8KNXP / GA-8I875 Ultra  
P4 Titan Series Motherboard

# USER'S MANUAL

Pentium® 4 Processor Motherboard

Rev. 2002

12ME-8KNXP-2002

# Table of Content

Warning .....	4
Chapter 1 Introduction .....	5
Features Summary .....	5
GA-8KNXP / GA-8I875 Ultra Motherboard Layout .....	8
Block Diagram .....	9
Chapter 2 Hardware Installation Process .....	11
Step 1: Install the Central Processing Unit (CPU) .....	12
Step 1-1: CPU Installation .....	12
Step 1-2: CPU Cooling Fan Installation .....	13
Step 2: Install Memory Modules .....	14
Step 3: Install expansion cards .....	17
Step 3-1: AGP Card Installation .....	17
Step 3-2: DPS2 (Dual Power System 2) Installation* .....	18
Step 4: Connect ribbon cables, cabinet wires and power supply .....	19
Step 4-1: I/O Back Panel Introduction .....	19
Step 4-2: Connectors Introduction .....	21
Chapter 3 BIOS Setup .....	37
The Main Menu (For example: BIOS Ver. : R1a) .....	38
Standard CMOS Features .....	40
Advanced BIOS Features .....	43
Integrated Peripherals .....	45
Power Management Setup .....	51

\* For GA-8KNXP only.

PnP/PCI Configurations .....	54
PC Health Status .....	55
Frequency/Voltage Control .....	57
Select Language .....	60
Load Fail-Safe Defaults .....	61
Load Optimized Defaults .....	62
Set Supervisor/User Password .....	63
Save & Exit Setup .....	64
Exit Without Saving .....	65
Chapter 4 Technical Reference .....	67
@BIOS™ Introduction .....	67
EasyTune™ 4 Introduction .....	68
DPS2 (Dual Power System 2) Introduction* .....	69
Flash BIOS Method Introduction .....	70
2- / 4- / 6-Channel Audio Function Introduction .....	80
Jack-Sensing Introduction .....	86
UAJ Introduction .....	88
Xpress Recovery Introduction .....	90
Chapter 5 Appendix .....	93

\* For GA-8KNXP only.

## Warning



Computer motherboards and expansion cards contain very delicate Integrated Circuit (IC) chips. To protect them against damage from static electricity, you should follow some precautions whenever you work on your computer.

1. Unplug your computer when working on the inside.
2. Use a grounded wrist strap before handling computer components. If you do not have one, touch both of your hands to a safely grounded object or to a metal object, such as the power supply case.
3. Hold components by the edges and try not touch the IC chips, leads or connectors, or other components.
4. Place components on a grounded antistatic pad or on the bag that came with the components whenever the components are separated from the system.
5. Ensure that the ATX power supply is switched off before you plug in or remove the ATX power connector on the motherboard.

### Installing the motherboard to the chassis...

If the motherboard has mounting holes, but they don't line up with the holes on the base and there are no slots to attach the spacers, do not become alarmed you can still attach the spacers to the mounting holes. Just cut the bottom portion of the spacers (the spacer may be a little hard to cut off, so be careful of your hands). In this way you can still attach the motherboard to the base without worrying about short circuits. Sometimes you may need to use the plastic springs to isolate the screw from the motherboard PCB surface, because the circuit wire may be near by the hole. Be careful, don't let the screw contact any printed circuit write or parts on the PCB that are near the fixing hole, otherwise it may damage the board or cause board malfunctioning.



# Chapter 1 Introduction

## Features Summary

Form Factor	<ul style="list-style-type: none"> <li>30.5cm x 24.4cm ATX size form factor, 6 layers PCB</li> </ul>
Motherboard	<ul style="list-style-type: none"> <li>GA-8KNXP or GA-8I875 Ultra</li> </ul>
CPU	<ul style="list-style-type: none"> <li>Socket 478 for Intel® Micro FC-PGA2 Pentium® 4 processor</li> <li>Support Intel® Pentium® 4 (Northwood, Prescott) processor</li> <li>Support Intel® Pentium® 4 Processor with HT Technology <sup>(Note)</sup></li> <li>Intel® Pentium® 4 800/533/400MHz FSB</li> <li>2nd cache depends on CPU</li> </ul>
Chipset	<ul style="list-style-type: none"> <li>Chipset Intel® 875P HOST/AGP/Controller</li> <li>ICH5R I/O Controller Hub</li> </ul>
Memory	<ul style="list-style-type: none"> <li>6 184-pin DDR DIMM sockets</li> <li>Supports Dual Channel DDR400/DDR333/DDR266 DIMM</li> <li>Supports 128MB/256MB/512MB/1GB unbuffered DRAM</li> <li>Supports up to 4GB DRAM (Max)</li> <li>Supports only 2.5V DDR DIMM</li> <li>Supports 64bit ECC type DRAM integrity mode</li> </ul>
I/O Control	<ul style="list-style-type: none"> <li>IT8712F</li> </ul>
Slots	<ul style="list-style-type: none"> <li>1 AGP Pro slot supports 8X/4X mode</li> <li>5 PCI slots support 33MHz &amp; PCI 2.3 compliant</li> </ul>
On-Board IDE	<ul style="list-style-type: none"> <li>2 IDE controllers provides IDE HDD/CD-ROM (IDE1, IDE2) with PIO, Bus Master (Ultra DMA33/ATA66/ATA100) operation modes</li> <li>IDE3 and IDE4 compatible with RAID, Ultra ATA133/100, EIDE</li> </ul>
Serial ATA	<ul style="list-style-type: none"> <li>Controlled by ICH5R           <ul style="list-style-type: none"> <li>- 2 Serial ATA connectors (SATA0_SB/SATA1_SB) in 150 MB/s operation mode</li> </ul> </li> <li>Controlled by SiI3112           <ul style="list-style-type: none"> <li>- 2 Serial ATA connectors (SATA0_SII/SATA1_SII) in 150 MB/s operation mode</li> </ul> </li> </ul>

to be continued.....



Due to chipset (Intel 875P) architecture limitation, DDR 400 memory module is only supported when using FSB 800 Pentium 4 processor. A FSB 533 Pentium 4 processor will support DDR333 and DDR266 memory module. A FSB 400 Pentium 4 processor will only support DDR 266 memory module.



Only Silicon Image SiI3112 chip supports Serial ATA(SATA0\_SII/SATA1\_SII) connectors hot plug function.

On-Board Peripherals	<ul style="list-style-type: none"> <li>• 1 Floppy port supports 2 FDD with 360K, 720K, 1.2M, 1.44M and 2.88M bytes</li> <li>• 1 Parallel port supports Normal/EPP/ECP mode</li> <li>• 2 Serial ports (COMA &amp; COMB)</li> <li>• 8 USB 2.0/1.1 ports (4 x Rear, 4 x Front by cable)</li> <li>• 3 IEEE1394 (by cable)</li> <li>• 1 IrDA connector for IR/CIR</li> <li>• 1 Front Audio connector</li> </ul>
Hardware Monitor	<ul style="list-style-type: none"> <li>• CPU/System/Power fan revolution detect</li> <li>• CPU temperature detect</li> <li>• CPU warning temperature</li> <li>• System voltage detect</li> <li>• CPU/System/Power fan fail warning</li> </ul>
On-Board LAN	<ul style="list-style-type: none"> <li>• Intel 82547 (KENAI II CSA) Chipset Data transfer rate 10/100/1000 supported</li> <li>• 1 RJ45 port</li> </ul>
On-Board Sound	<ul style="list-style-type: none"> <li>• Realtek ALC658 UAJ CODEC</li> <li>• Supports Jack-Sensing function</li> <li>• Line Out / 2 front speaker</li> <li>• Line In / 2 rear speaker (by s/w switch)</li> <li>• Mic In / center &amp; subwoofer (by s/w switch)</li> <li>• SPDIF In / Out</li> <li>• CD In / AUX In / Game port</li> </ul>
On-Board IDE RAID	<ul style="list-style-type: none"> <li>• Onboard GigaRAID IT8212F chipset</li> <li>• Supports data striping (RAID 0) or mirroring (RAID 1) or striping+mirroring (RAID 0+RAID 1)</li> <li>• Supports JBOD function</li> <li>• Supports concurrent dual ATA133 IDE controller operation</li> <li>• Support ATAPI mode for HDD</li> <li>• Supports IDE bus master operation</li> <li>• Support ATA133/RAID mode switch by BIOS</li> <li>• Displays status and error checking messages during boot-up</li> <li>• Mirroring supports automatic background rebuilds</li> <li>• Features LBA and Extended Interrupt 13 drive translation in controller onboard BIOS</li> </ul>
On-Board SATA RAID	<ul style="list-style-type: none"> <li>• Built in ICH5R</li> <li>• Supports disk striping (RAID0) or mirroring (RAID 1)</li> <li>• Supports UDMA up to 150 MB/sec</li> <li>• UDMA and PIO Modes</li> <li>• Up to 2 SATA devices</li> <li>• ACPI and ATA/ATAPI6</li> <li>• Only supports Windows XP</li> </ul>

to be continued.....

On-Board SATA RAID	<ul style="list-style-type: none"> <li>• Built in Silicon Image SiI3112</li> <li>• Supports Disk striping (RAID0) or DISK Mirroring (RAID1)</li> <li>• Supports UDMA up to 150 MB/sec</li> <li>• UDMA and PIO Modes</li> <li>• Up to 2 SATA devices</li> <li>• ACPI and ATA/ATAPI6</li> <li>• Supports hot plug funcion (SATA0_SII/SATA1_SII)</li> </ul>
On-Board 1394	<ul style="list-style-type: none"> <li>• Built-in TSB43AB23 chip</li> </ul>
PS/2 Connector	<ul style="list-style-type: none"> <li>• PS/2 Keyboard interface and PS/2 Mouse interface</li> </ul>
BIOS	<ul style="list-style-type: none"> <li>• Licensed AWARD BIOS</li> <li>• Supports Dual BIOS</li> <li>• Supports Multi Language BIOS</li> <li>• Supports Face Wizard</li> <li>• Supports Q-Flash</li> </ul>
Additional Features	<ul style="list-style-type: none"> <li>• Supports CPU Dual Power System 2 (DPS2)*</li> <li>• PS/2 Keyboard power on by password</li> <li>• PS/2 Mouse power on</li> <li>• External Modem wake up</li> <li>• STR(Suspend-To-RAM)</li> <li>• Wake on LAN (WOL)</li> <li>• AC Recovery</li> <li>• Poly fuse for keyboard over-current protection</li> <li>• USB KB/Mouse wake up from S3</li> <li>• Supports @BIOS</li> <li>• Supports EasyTune 4</li> <li>• Supports clear password function</li> </ul>
Jumper less Overclocking	<ul style="list-style-type: none"> <li>• Over Clock (CPU/DDR/AGP) by BIOS</li> </ul>



#### HT functionality requirement content :

Enabling the functionality of Hyper-Threading Technology for your computer system requires all of the following platform components:

- CPU: An Intel® Pentium 4 Processor with HT Technology
- Chipset: An Intel® Chipset that supports HT Technology
- BIOS: A BIOS that supports HT Technology and has it enabled
- OS: An operation system that has optimizations for HT Technology



Please set the CPU host frequency in accordance with your processor's specifications.

We don't recommend you to set the system bus frequency over the CPU's specification because these specific bus frequencies are not the standard specifications for CPU, chipset and most of the peripherals. Whether your system can run under these specific bus frequencies properly will depend on your hardware configurations, including CPU, Chipsets, SDRAM, Cards...etc.

\* For GA-8KNXP only.

# GA-8KNXP / GA-8I875 Ultra Motherboard Layout

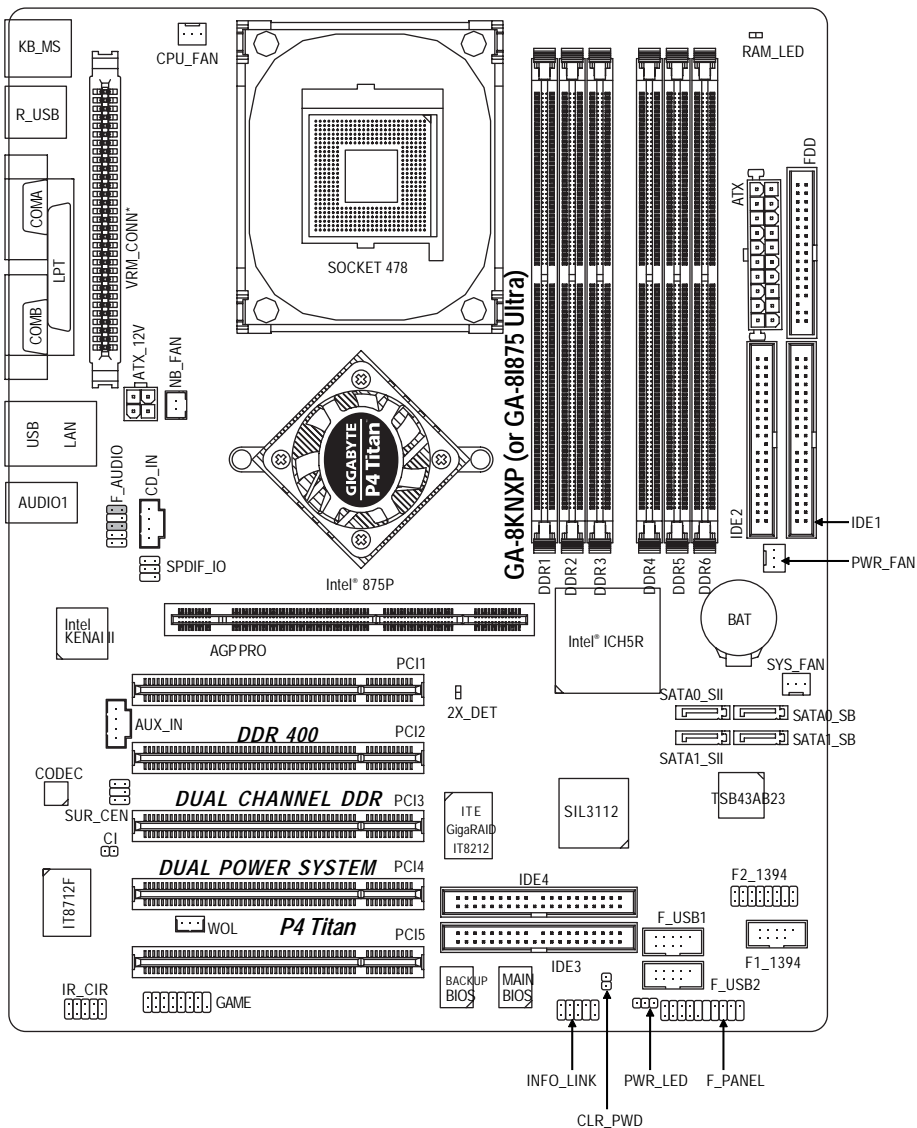

\* For GA-8KNXP only.

# Block Diagram

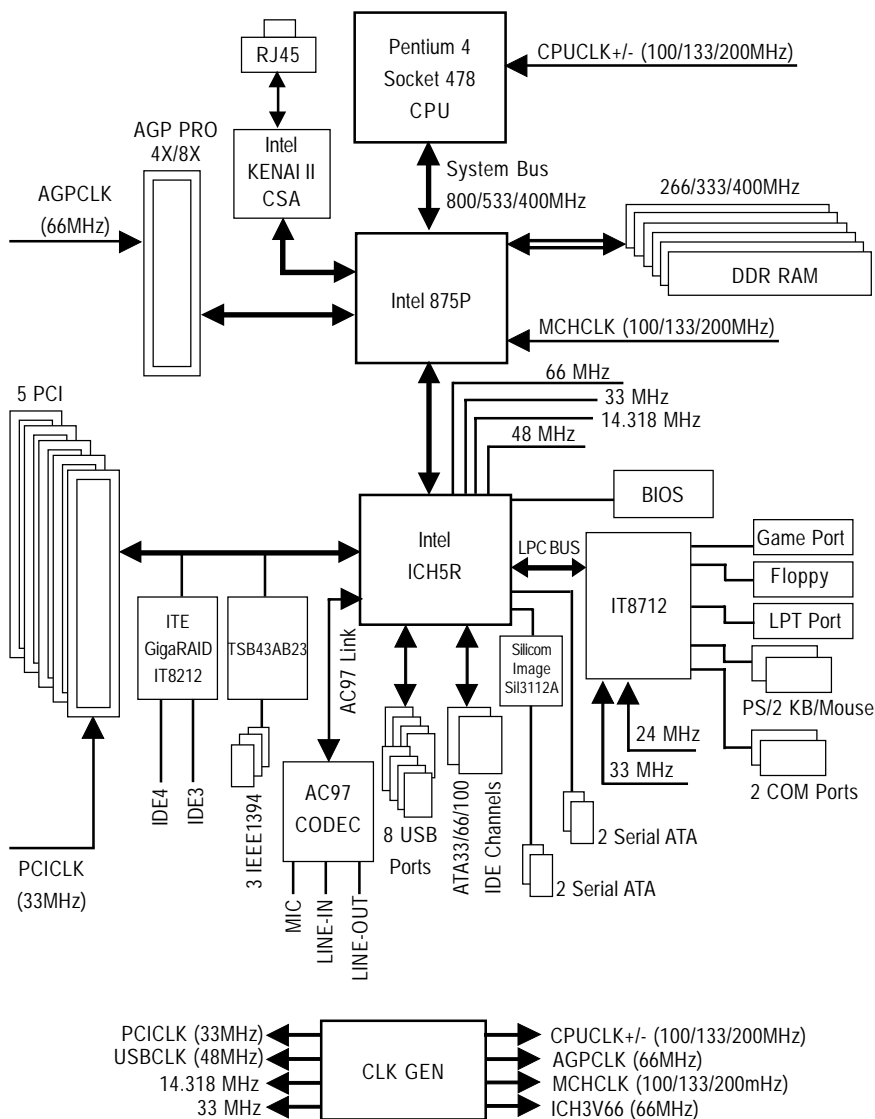



## Chapter 2 Hardware Installation Process

To set up your computer, you must complete the following steps:

- Step 1- Install the Central Processing Unit (CPU)
- Step 2- Install memory modules
- Step 3- Install expansion cards
- Step 4- Connect ribbon cables, cabinet wires, and power supply

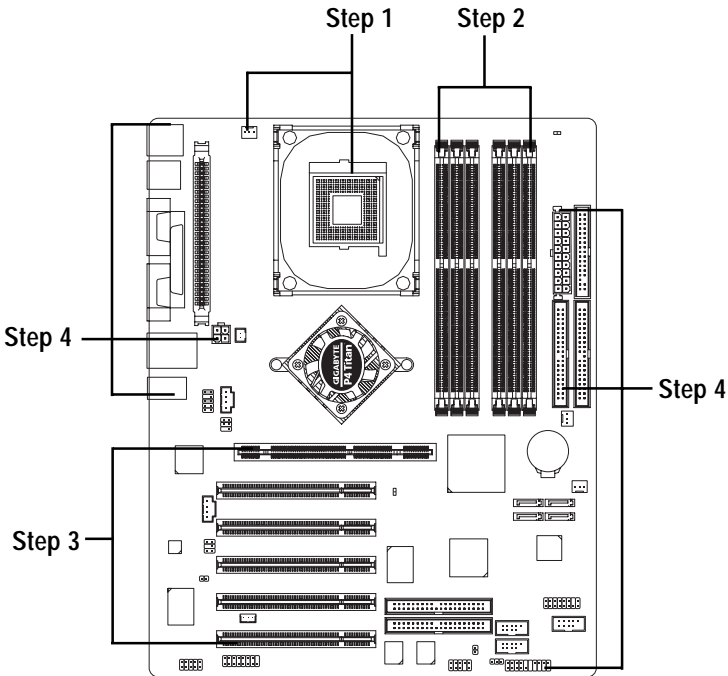

Congratulations! You have accomplished the hardware installation!

Turn on the power supply or connect the power cable to the power outlet. Continue with the BIOS/software installation.

## Step 1: Install the Central Processing Unit (CPU)



Before installing the processor, adhere to the following warning:

1. Please make sure the CPU type is supported by the motherboard.
2. If you do not match the CPU socket Pin 1 and CPU cut edge well, it will cause improper installation. Please change the insert orientation.

### Step 1-1: CPU Installation

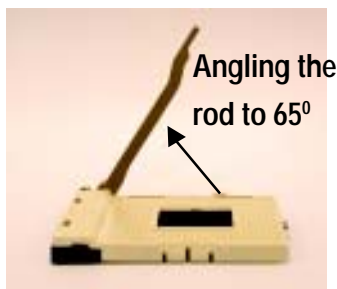

1. Angling the rod to 65-degree maybe feel a kind of tight , and then continue pull the rod to 90-degree when a noise "cough" made.

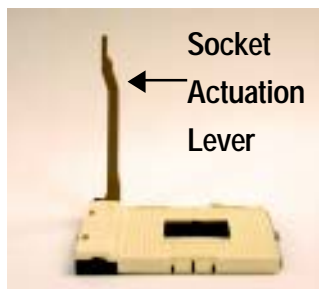

2. Pull the rod to the 90-degree directly.



3. CPU Top View

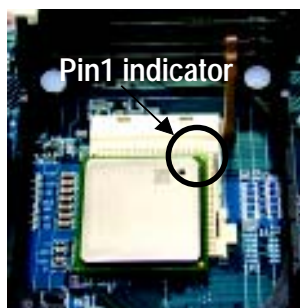

4. Locate Pin 1 in the socket and look for a (golden) cut edge on the CPU upper corner. Then insert the CPU into the socket.



## Step 1-2: CPU Cooling Fan Installation



Before installing the CPU cooling fan, adhere to the following warning:

1. Please use Intel approved cooling fan.
2. We recommend you to apply the thermal tape to provide better heat conduction between your CPU and cooling fan.

(The CPU cooling fan might stick to the CPU due to the hardening of the thermal paste. During this condition if you try to remove the cooling fan, you might pull the processor out of the CPU socket along with the cooling fan, and might damage the processor. To avoid this from happening, we suggest you to either use thermal tape instead of thermal paste, or remove the cooling fan with extreme caution.)

3. Make sure the CPU fan power cable is plugged in to the CPU fan connector, this completes the installation.

Please refer to CPU cooling fan user's manual for more detail installation procedure.



1. Fasten the cooling fan supporting-base onto the CPU socket on the motherboard.



2. Make sure the CPU fan is plugged to the CPU fan connector, than install complete.

## Step 2: Install Memory Modules



Before installing the memory modules, adhere to the following warning:

1. When DIMM LED is ON, do not install / remove DIMM from socket.
2. Please note that the DIMM module can only fit in one direction due to the one notch. Wrong orientation will cause improper installation. Please change the insert orientation.

The motherboard has 6 dual inline memory module (DIMM) sockets. The BIOS will automatically detect memory type and size. To install the memory module, just push it vertically into the DIMM socket. The DIMM module can only fit in one direction due to the notch. Memory size can vary between sockets.

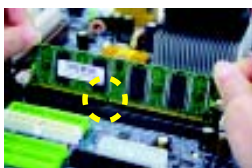
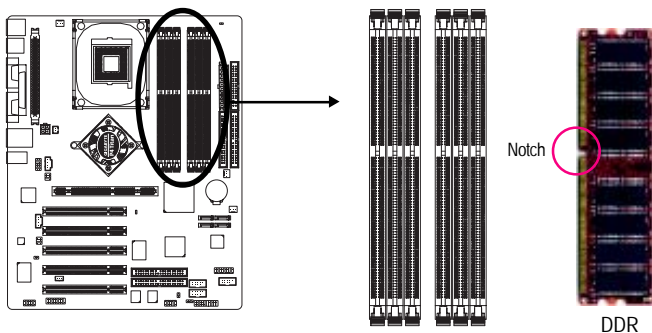

1. The DIMM socket has a notch, so the DIMM memory module can only fit in one direction.



2. Insert the DIMM memory module vertically into the DIMM socket. Then push it down.



3. Close the plastic clip at both edges of the DIMM sockets to lock the DIMM module.  
Reverse the installation steps when you wish to remove the DIMM module.

## DDR Introduction

Established on the existing SDRAM infrastructure, DDR (Double Data Rate) memory is a high performance and cost-effective solution that allows easy adoption for memory vendors, OEMs, and system integrators.

DDR memory is a great evolutionary solution for the PC industry that builds on the existing SDRAM architecture, yet make the awesome advances in solving the system performance bottleneck by doubling the memory bandwidth. Nowadays, with the highest bandwidth of 3.2GB/s of DDR400 memory and complete line of DDR400/333/266/200 memory solutions, DDR memory is the best choice for building high performance and low latency DRAM subsystem that are suitable for servers, workstations, and full range of desktop PCs.

### Dual Channel DDR:

GA-8KNXP / GA-8I875 Ultra supports Dual Channel Technology.

When Dual Channel Technology is activated, the bandwidth of memory bus will be double the original one, with the fastest speed at 6.4GB/s DDR400.

GA-8KNXP / GA-8I875 Ultra includes six DIMM slots, and each Channel has 3 DIMMs as following:

- ▶▶ Channel A : DIMM 1, 2, 3
- ▶▶ Channel B : DIMM 4, 5, 6

Below are the explanations:



1. One, three, or five DDR memory modules are installed: The Dual Channel Technology will not operate when one, three, or five DDR memory modules are installed and they will only work as Single Channel.
2. Two DDR memory modules are installed (the same memory size and type): The Dual Channel Technology will operate when two DDR memory modules are inserted individually into Channel A and Channel B (DIMM 1 pairs up with DIMM 4, DIMM 2, 5 and DIMM 3, 6). However, if the two DDR memory modules are inserted into the same Channel (DIMM 1,2,3 or DIMM 4,5,6) then Dual Channel Technology will not operate.
3. Three or five DDR memory modules are installed: Please note that The Dual Channel Technology will not operate when three or five DDR memory modules are installed: part of them will not be detected.
4. If four DDR memory modules are installed (two pairs of DDR memory modules with the same memory size and type): The Dual Channel Technology will operate when a pair of DDR memory modules are inserted into DIMM1, 4 and another pair into DIMM 2,5.

5. If six DDR memory modules are installed: To activate the Dual Channel Technology and to make the size of each DDR memory module detected, please use six DDR memory modules with identical size and type and insert them into the six DIMMs following the sequence below:

DIMM 1: Double or Single Side

DIMM 2: Single Side

DIMM 3: Single Side

DIMM 4: Double or Single Side (if DIMM1 is inserted a double-side module, then DIMM4 must also be inserted a double-side one.)

DIMM 5: Single Side

DIMM 6: Single Side

The following tables include all memory-installed combination types:

(Please note that those types not in the tables will not boot up.)

- Figure 1: Dual Channel Technology (DS: Double Side, SS: Single Side)

	DIMM 1	DIMM 2	DIMM 3	DIMM 4	DIMM 5	DIMM 6
2 memory modules	DS/SS	X	X	DS/SS	X	X
	X	DS/SS	X	X	DS/SS	X
	X	X	DS/SS	X	X	DS/SS
4 memory modules	DS/SS	DS/SS	X	DS/SS	DS/SS	X
6 memory modules	DS/SS	SS	SS	DS/SS	SS	SS

- Figure 2: Don't operate Dual Channel Technology (DS: Double Side, SS: Single Side)

	DIMM 1	DIMM 3	DIMM 5
1 memory module	DS/SS	X	X
	X	DS/SS	X
	X	X	DS/SS
2 memory modules	DS/SS	DS/SS	X
3 memory modules	DS/SS	SS	SS

## Step 3: Install expansion cards

### Step 3-1: AGP Card Installation

1. Read the related expansion card's instruction document before install the expansion card into the computer.
2. Remove your computer's chassis cover, screws and slot bracket from the computer.
3. Press the expansion card firmly into expansion slot in motherboard.
4. Be sure the metal contacts on the card are indeed seated in the slot.
5. Replace the screw to secure the slot bracket of the expansion card.
6. Replace your computer's chassis cover.
7. Power on the computer, if necessary, setup BIOS utility of expansion card from BIOS.
8. Install related driver from the operating system.



Please align the AGP card to the onboard AGP PRO slot and press firmly down on the slot.

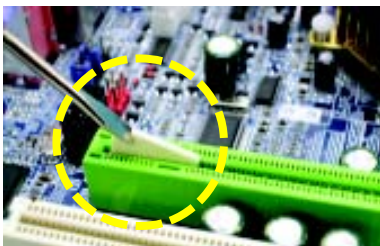

If you are installing a AGP PRO graphic card, please remove the protecting plate first.



When an AGP 2X (3.3V) card is installed the 2X\_DET will light up, indicating a non-supported graphics card is inserted. Informing users that system might not boot up normally due to AGP 2X (3.3V) is not supported by the chipset.

## Step 3-2: DPS2 (Dual Power System 2) Installation\*

### What is DPS2 ?

DPS2 (Dual Power System 2) is a daughter card which can provide you the Dual Power System function. A cool stylish neon blue DPS2 that supply a total 6-phase power circuit design, delivers a high durable power design for the new generation Intel® platform.



The DPS2 can work in a Dual Power System:

- Parallel Mode :  
DPS2 and motherboard CPU power can work simultaneously, providing a total of 6-phase power circuit.

### How to install a DPS2 ?

1. The DPS2 connector has a notch, so the DPS2 can only fit in one direction.
2. Insert the DPS2 vertically into the socket and then push it down.
3. Fix the DPS2 on the motherboard with the clip.
4. Reverse the installation steps if you want to remove the DPS2.

\* For GA-8KNXP only.

## Step 4: Connect ribbon cables, cabinet wires and power supply

### Step 4-1: I/O Back Panel Introduction

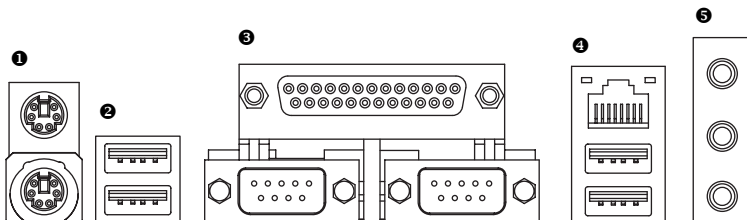

#### ❶ PS/2 Keyboard and PS/2 Mouse Connector

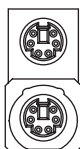

PS/2 Mouse Connector  
(6 pin Female)

PS/2 Keyboard Connector  
(6 pin Female)

- This connector supports standard PS/2 keyboard and PS/2 mouse.

#### ❷/❹ USB/LAN Connector

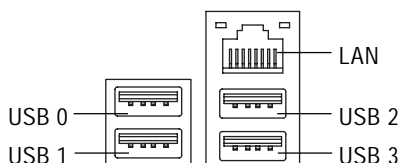

- Intel Kenai II CSA is Gigabit Ethernet with 1000Mbps speed.
- Before you connect your device(s) into USB connector(s), please make sure your device(s) such as USB keyboard, mouse, scanner, zip, speaker...etc. Have a standard USB interface. Also make sure your OS supports USB controller. If your OS does not support USB controller, please contact OS vendor for possible patch or driver upgrade. For more information please contact your OS or device(s) vendors.

### ④ Parallel Port and Serial Ports (COMA / COMB)

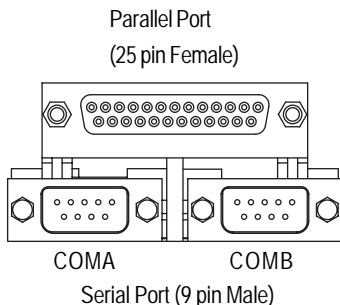

- This connector supports 2 standard COM ports and 1 Parallel port. Device like printer can be connected to Parallel port; mouse and modem etc. can be connected to Serial ports.

### ⑤ Audio Connectors

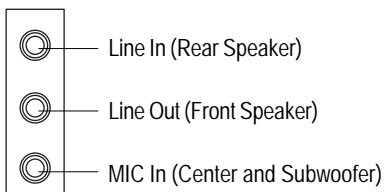

- After install onboard audio driver, you may connect speaker to Line Out jack, microphone to MIC In jack. Device like CD-ROM, walkman etc. can be connected to Line-In jack.

**Please note:**

You are able to use 2-/4-/6-channel audio feature by S/W selection.

If you want to enable 6-channel function, you have 2 choose for hardware connection.

**Method1:**

Connect "Front Speaker" to "Line Out"

Connect "Rear Speaker" to "Line In"

Connect "Center and Subwoofer" to "MIC Out".

**Method2:**

You can refer to page 31, and contact your nearest dealer for optional SUR\_CEN cable.



*If you want the detail information for 2-/4-/6-channel audio setup installation, please refer to page 80.*



## Step 4-2: Connectors Introduction

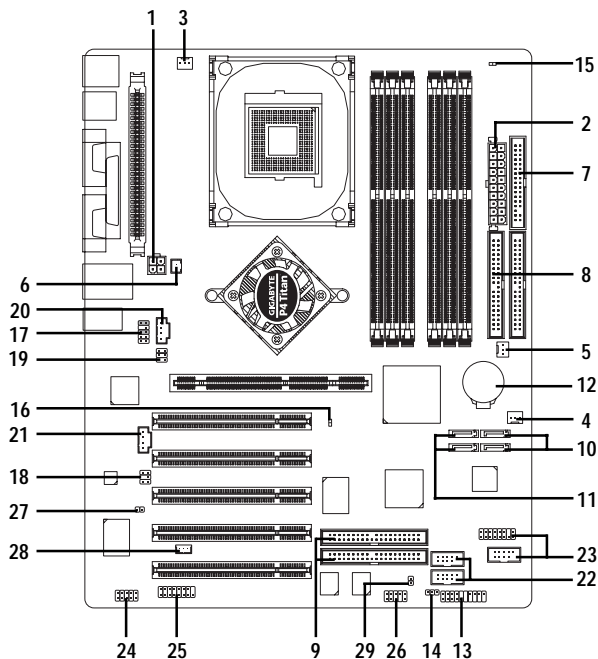

1) ATX_12V	16) 2X_DET
2) ATX	17) F_AUDIO
3) CPU_FAN	18) SUR_CEN
4) SYS_FAN	19) SPDIF_IO
5) PWR_FAN	20) CD_IN
6) NB_FAN	21) AUX_IN
7) FDD	22) F_USB1 / F_USB2
8) IDE1 / IDE2	23) F1_1394 / F2_1394
9) IDE3 / IDE4	24) IR_CIR
10) SATA0_SB / SATA1_SB	25) GAME
11) SATA0_SII / SATA1_SII	26) INFO_LINK
12) BAT	27) C1
13) F_PANEL	28) WOL
14) PWR_LED	29) CLR_PWD
15) RAM_LED	

### 1) ATX\_12V (+12V Power Connector)

This connector (ATX\_12V) supplies the CPU operation voltage (Vcore).  
 If this "ATX\_12V connector" is not connected, system cannot boot.

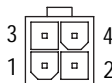
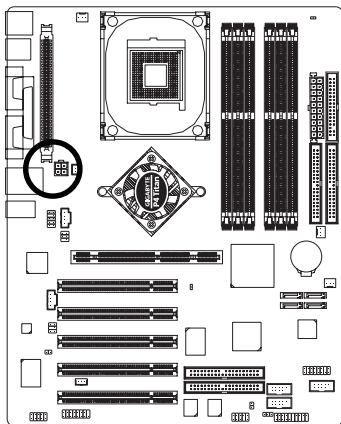

Pin No.	Definition
1	GND
2	GND
3	+12V
4	+12V

### 2) ATX (ATX Power)

AC power cord should only be connected to your power supply unit after ATX power cable and other related devices are firmly connected to the mainboard.

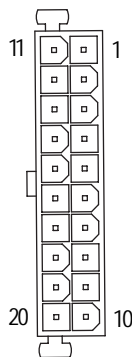
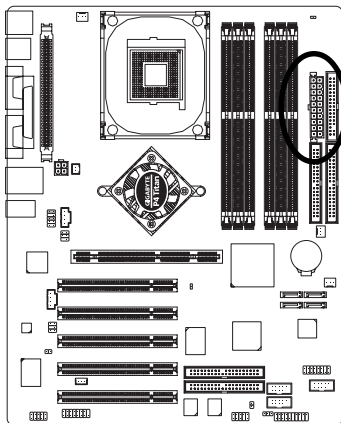

Pin No.	Definition
1	3.3V
2	3.3V
3	GND
4	VCC
5	GND
6	VCC
7	GND
8	Power Good
9	5V SB (stand by +5V)
10	+12V
11	3.3V
12	-12V
13	GND
14	PS_ON(soft on/off)
15	GND
16	GND
17	GND
18	-5V
19	VCC
20	VCC

### 3) CPU\_FAN (CPU Fan Connector)

Please note, a proper installation of the CPU cooler is essential to prevent the CPU from running under abnormal condition or damaged by overheating. The CPU fan connector supports Max. current up to 600 mA.

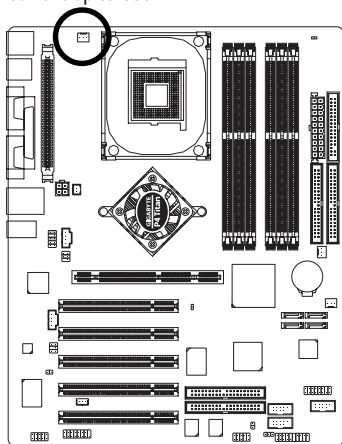

Pin No.	Definition
1	GND
2	+12V
3	Sense

### 4) SYS\_FAN (System Fan Connector)

This connector allows you to link with the cooling fan on the system case to lower the system temperature.

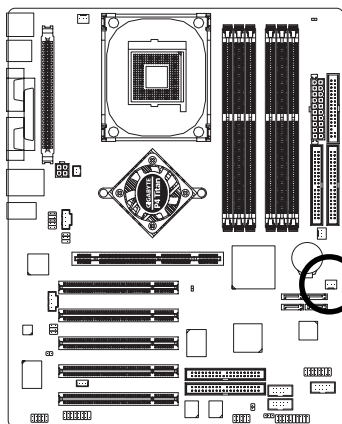

Pin No.	Definition
1	GND
2	+12V
3	Sense

## 5) PWR\_FAN (Power Fan Connector)

This connector allows you to link with the cooling fan on the system case to lower the system temperature.

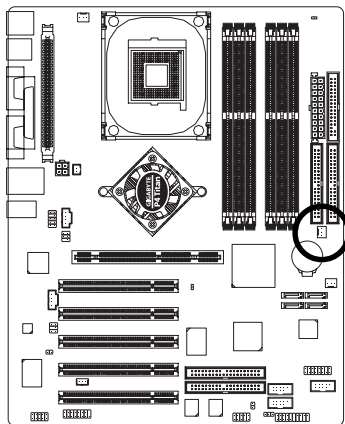

Pin No.	Definition
1	GND
2	+12V
3	Sense

## 6) NB\_FAN (Chip Fan Connector)

If you installed wrong direction, the chip fan will not work. Sometimes will damage the chip fan. (Usually black cable is GND)

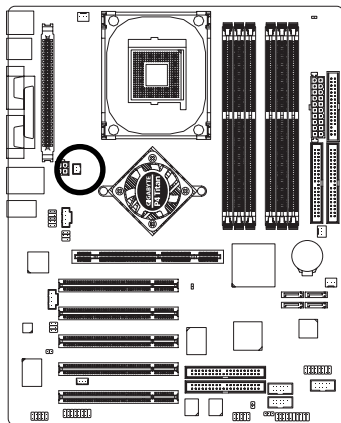

Pin No.	Definition
1	VCC
2	GND

## 7) FDD (Floppy Connector)

Please connect the floppy drive ribbon cables to FDD. It supports 360K, 1.2M, 720K, 1.44M and 2.88M bytes floppy disk types.

The red stripe of the ribbon cable must be the same side with the Pin1.

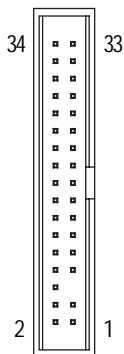
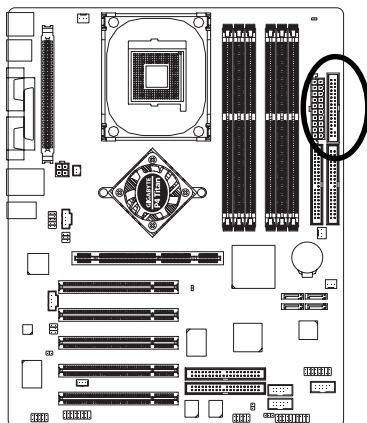

## 8) IDE1 / IDE2 (IDE1 / IDE2 Connector)

Important Notice:

Please connect first hard disk to IDE1 and connect CD-ROM to IDE2.

The red stripe of the ribbon cable must be the same side with the Pin1.

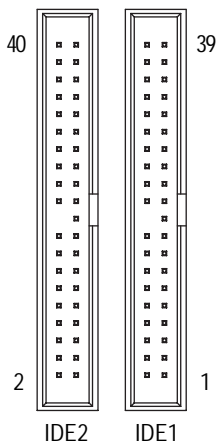
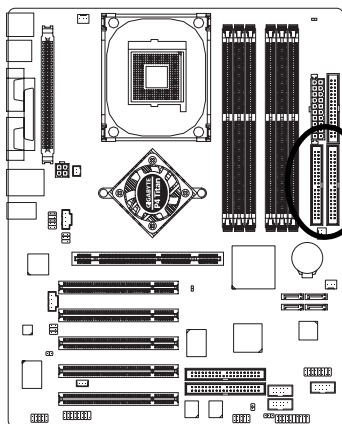

### 9) IDE3 / IDE4 (RAID/ATA133, Green Connector)

Important Notice: The red stripe of the ribbon cable must be the same side with the Pin1. If you wish to use IDE3 and IDE4, please use it in unity with BIOS (either RAID or ATA133). Then, install the correct driver to have proper operation. For details, please refer to the ITE RAID manual.

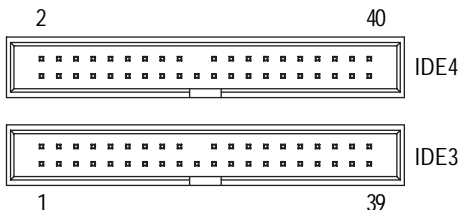
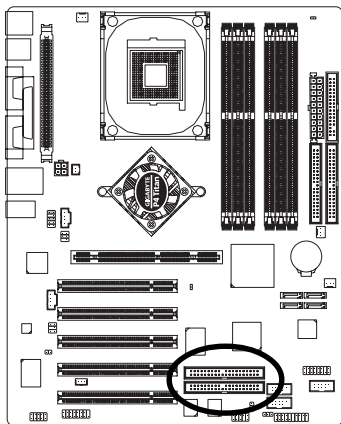

### 10) SATA0\_SB / SATA1\_SB (Serial ATA Connector)

You can connect the Serial ATA device to this connector, it provides you high speed transfer rates (150MB/sec). If you wish to use RAID function, please note that these two Serial ATA connectors just support RAID0 and only compatible with WinXP.

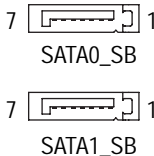
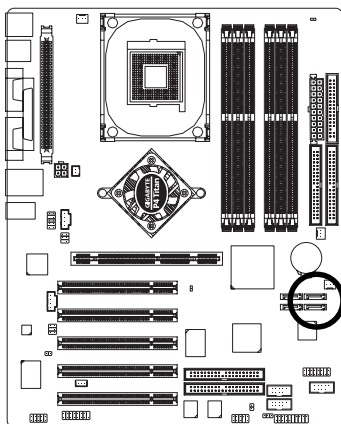

Pin No.	Definition
1	GND
2	TXP
3	TXN
4	GND
5	RXN
6	RXP
7	GND

## 11) SATA0\_SII / SATA1\_SII (Serial ATA Connector)

You can connect the Serial ATA device to this connector, it provides you high speed transfer rates (150MB/sec). If you wish to use RAID function, please use it in unity with BIOS and install the correct driver to have proper operation. For details, please refer to the SATA RAID manual.

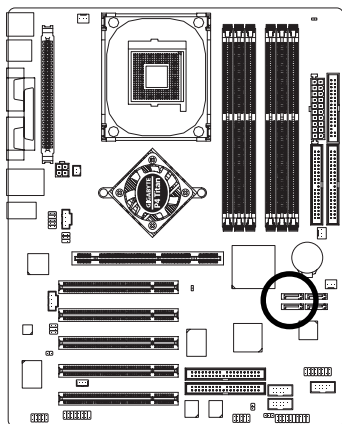

7  1  
SATA0\_SII

7  1  
SATA1\_SII

Pin No.	Definition
1	GND
2	TXP
3	TXN
4	GND
5	RXN
6	RXP
7	GND



These two Serial ATA(SATA0\_SII/SATA1\_SII) connectors support hot plug function.

## 12) BATTERY

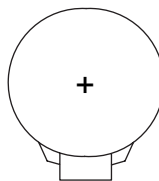
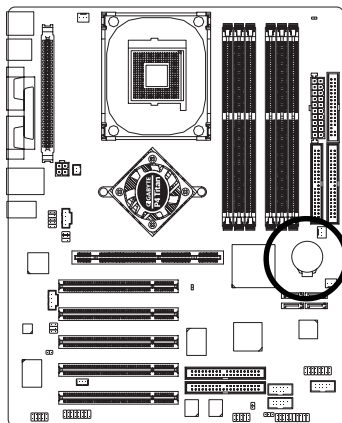

### CAUTION

- ❖ Danger of explosion if battery is incorrectly replaced.
- ❖ Replace only with the same or equivalent type recommended by the manufacturer.
- ❖ Dispose of used batteries according to the manufacturer's instructions.

If you want to erase CMOS...

1. Turn OFF the computer and unplug the power cord.
2. Remove the battery, wait for 30 second.
3. Re-install the battery.
4. Plug the power cord and turn ON the computer.

### 13) F\_PANEL (2 x 10 pins Connector)

Please connect the power LED, PC speaker, reset switch and power switch etc. of your chassis front panel to the F\_PANEL connector according to the pin assignment above.

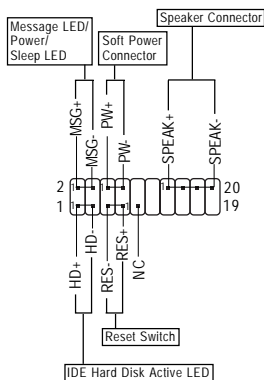
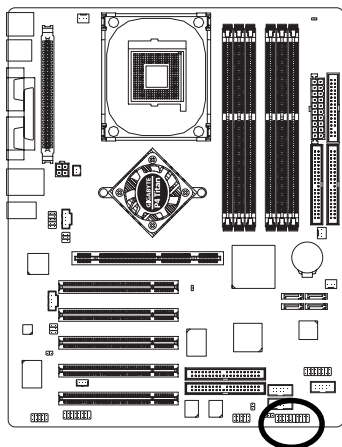

HD (IDE Hard Disk Active LED) (Blue)	Pin 1: LED anode(+) Pin 2: LED cathode(-)
SPK (Speaker Connector) (Amber)	Pin 1: VCC(+) Pin 2- Pin 3: NC Pin 4: Data(-)
RES (Reset Switch) (Green)	Open: Normal Operation Close: Reset Hardware System
PW (Soft Power Connector) (Red)	Open: Normal Operation Close: Power On/Off
MSG(Message LED/ Power/ Sleep LED) (Yellow)	Pin 1: LED anode(+) Pin 2: LED cathode(-)
NC (Purple)	NC



## 14) PWR\_LED

PWR\_LED is connect with the system power indicator to indicate whether the system is on/off. It will blink when the system enters suspend mode. If you use dual color LED, power LED will turn to another color.

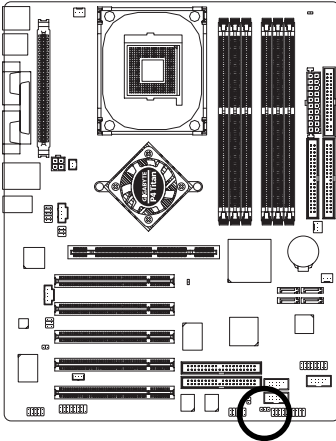

1 

Pin No.	Definition
1	MPD+
2	MPD-
3	MPD-

## 15) RAM\_LED

Do not remove memory modules while RAM\_LED is on. It might cause short or other unexpected damages due to the stand by voltage. Remove memory modules only when AC power cord is disconnected.

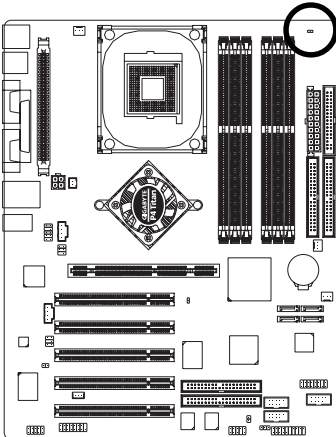

-  +

## 16) 2X\_DET

When an AGP 2X (3.3V) card is installed the 2X\_DET will light up, indicating a non-supported graphics card is inserted. Informing users that system might not boot up normally due to AGP 2X (3.3V) is not supported by the chipset.

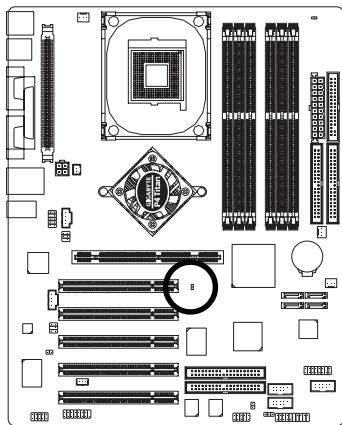

## 17) F\_AUDIO (Front Audio Connector)

If you want to use Front Audio connector, you must remove 5-6, 9-10 Jumper.

In order to utilize the front audio header, your chassis must have front audio connector. Also please make sure the pin assignment on the cable is the same as the pin assignment on the MB header. To find out if the chassis you are buying support front audio connector, please contact your dealer. Please note, you can have the alternative of using front audio connector or of using rear audio connector to play sound.

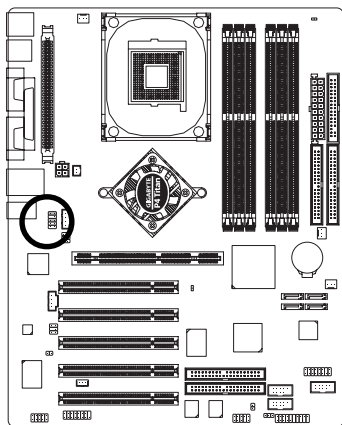

Pin No.	Definition
1	MIC
2	GND
3	REF
4	Power
5	Front Audio (R)
6	Rear Audio (R)
7	Reserved
8	No Pin
9	Front Audio (L)
10	Rear Audio (L)

## 18) SUR\_CEN (Surround Center Connector)

Please contact your nearest dealer for optional SUR\_CEN cable.

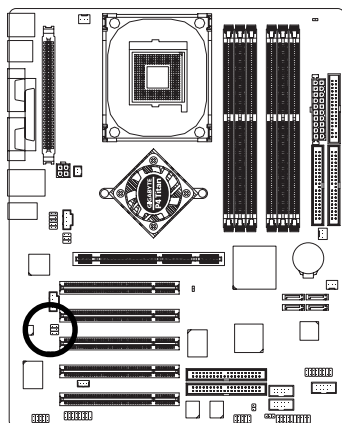

Pin No.	Definition
1	SUR OUTL
2	SUR OTR
3	GND
4	No Pin
5	CENTER_OUT
6	BASS_OUT

## 19) SPDIF\_IO (SPDIF In / Out Connector)

The SPDIF output is capable of providing digital audio to external speakers or compressed AC3 data to an external Dolby Digital Decoder. Use this feature only when your stereo system has digital input function. Be careful with the polarity of the SPDIF\_IO connector. Check the pin assignment carefully while you connect the SPDIF\_IO cable, incorrect connection between the cable and connector will make the device unable to work or even damage it. For optional SPDIF\_IO cable, please contact your local dealer.

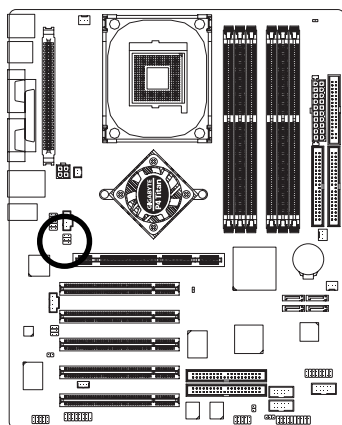

Pin No.	Definition
1	VCC
2	No Pin
3	SPDIF
4	SPDIFI
5	GND
6	GND

## 20) CD\_IN (CD In Connector)

Connect CD-ROM or DVD-ROM audio out to the connector.

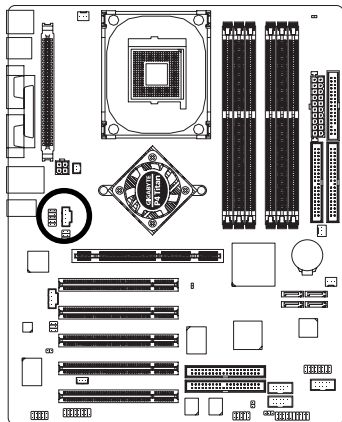

Pin No.	Definition
1	CD-L
2	GND
3	GND
4	CD-R

## 21) AUX\_IN (AUX In Connector)

Connect other device (such as PCI TV Tuner audio out) to the connector.

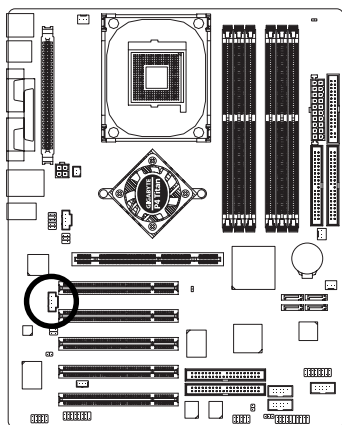

Pin No.	Definition
1	AUX-L
2	GND
3	GND
4	AUX-R

## 22) F\_USB1 / F\_USB2 (Front USB Connector, Yellow)

Be careful with the polarity of the front USB connector. Check the pin assignment carefully while you connect the front USB cable, incorrect connection between the cable and connector will make the device unable to work or even damage it. For optional front USB cable, please contact your local dealer.

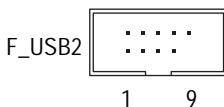
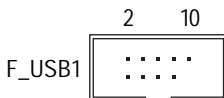
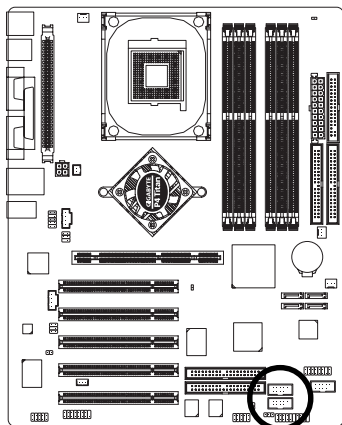

Pin No.	Definition
1	Power
2	Power
3	USB Dx-
4	USB Dy-
5	USB Dx+
6	USB Dy+
7	GND
8	GND
9	No Pin
10	NC

## 23) F1\_1394 / F2\_1394 (IEEE1394 Connector)

**Please Note:** Serial interface standard set by Institute of Electrical and Electronics Engineers, which has features like high speed, highbandwidth and hot plug. Be careful with the polarity of the IEEE1394 connector. Check the pin assignment carefully while you connect the IEEE1394 cable, incorrect connection between the cable and connector will make the device unable to work or even damage it. For optional IEEE1394 cable, please contact your local dealer.

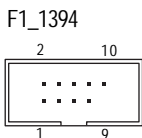
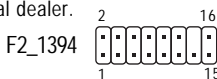
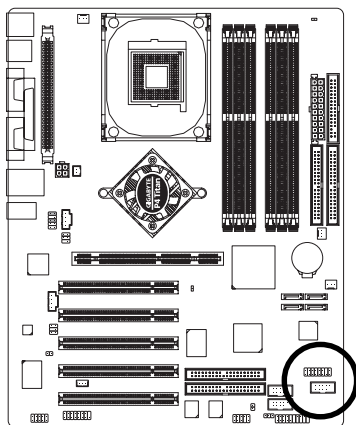

Pin No.	Definition
1	TPA2+
2	TPA2-
3	GND
4	GND
5	TPB2+
6	TPB2-
7	Power
8	Power
9	No Pin
10	GND

Pin No.	Definition
1	Power
2	Power
3	TPA0+
4	TPA0-
5	GND
6	GND
7	TPB0+
8	TPB0-
9	Power
10	Power
11	TPA1+
12	TPA1-
13	GND
14	No Pin
15	TPB1+
16	TPB1-

## 24) IR\_CIR

Make sure the pin 1 on the IR device is along with pin one the connector. To enable the IR/CIR function on the board, you are required to purchase an option IR/CIR module. To use IR function only, please connect IR module to Pin1 to Pin5. Be careful with the polarity of the IR/CIR connector. Check the pin assignment carefully while you connect the IR/CIR cable, incorrect connection between the cable and connector will make the device unable to work or even damage it. For optional IR/CIR cable, please contact your local dealer.

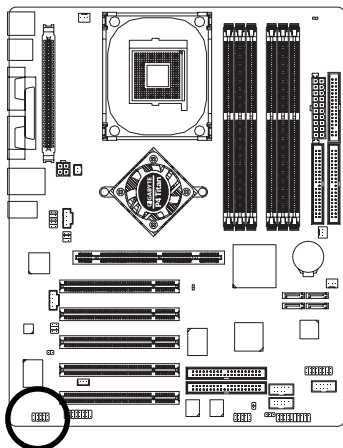

Pin No.	Definition
1	VCC
2	NC
3	IRRX
4	GND
5	IRTX
6	NC
7	CIRRX
8	+5VSB
9	CIRTX
10	NC

## 25) GAME (Game Connector)

This connector supports joystick, MIDI keyboard and other relate audio devices. Check the pin assignment while you connect the game cables. Please contact your nearest dealer for optional game cables.

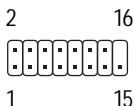
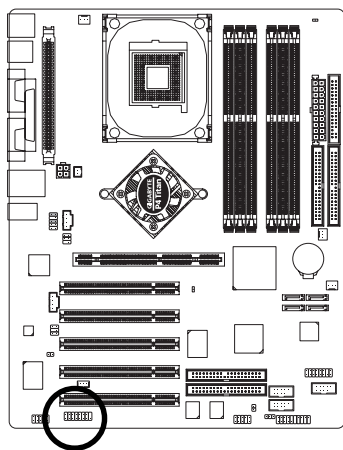

Pin No.	Definition
1	VCC
2	GRX1_R
3	GND
4	GPSA2
5	VCC
6	GPX2_R
7	GPY2_R
8	MSL_R
9	GPSA1
10	GND
11	GPY1_R
12	VCC
13	GPSB1
14	MSO_R
15	GPSB2
16	No Pin

## 26) INFO\_LINK

This connector allows you to connect some external devices to provide you extra function. Check the pin assignment while you connect the external device cable. Please contact your nearest dealer for optional external device cable.

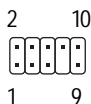
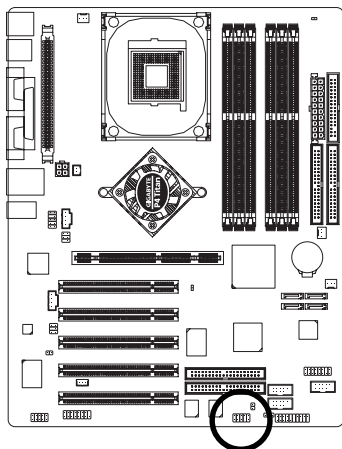

Pin No.	Definition
1	SMBCLK
2	VCC
3	SMBDATA
4	GPIO
5	GND
6	GND
7	No Pin
8	NC
9	+12V
10	+12V

## 27) CI (CASE OPEN)

This 2-pin connector allows your system to enable or disable the "Case Open" item in BIOS, if the system case begin remove.

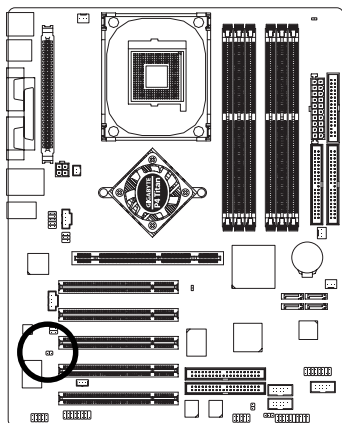

Pin No.	Definition
1	Signal
2	GND

## 28) WOL (Wake On LAN)

This connector allows the remote servers to manage this system via your network adapter which supports WOL. Be careful with the polarity of the WOL connector. Check the pin assignment carefully while you connect the WOL cable, incorrect connection between the cable and connector will make the device unable to work or even damage it. For optional WOL cable, please contact your local dealer.

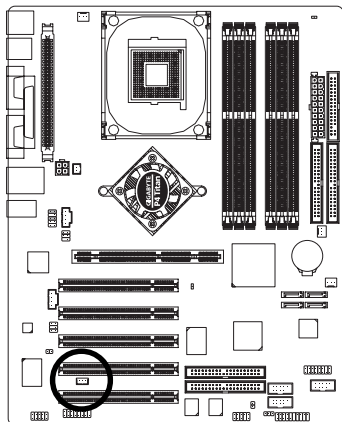

Pin No.	Definition
1	+5V SB
2	GND
3	Signal

## 29) CLR\_PWD

When Jumper is set to "open" and system is restarted, the password that is set will be cleared. On the contrary when Jumper is set to "close", the current status remains.

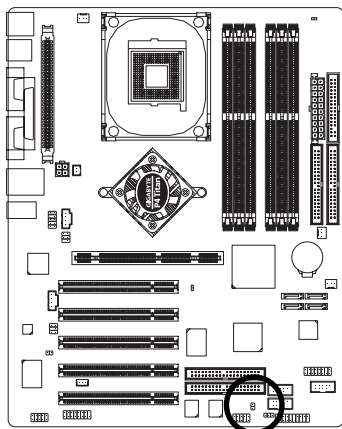

1

Open: Clear Password



1

Close: Normal



## Chapter 3 BIOS Setup

BIOS Setup is an overview of the BIOS Setup Program. The program that allows users to modify the basic system configuration. This type of information is stored in battery-backed CMOS RAM so that it retains the Setup information when the power is turned off.

### ENTERING SETUP

Powering ON the computer and pressing <Del> immediately will allow you to enter Setup. If you require more advanced BIOS settings, please go to "Advanced BIOS" setting menu. To enter Advanced BIOS setting menu, press "Ctrl+F1" key on the BIOS screen.

### CONTROL KEYS

<↑>	Move to previous item
<↓>	Move to next item
<←>	Move to the item in the left hand
<→>	Move to the item in the right hand
Enter	Select item
<Esc>	Main Menu - Quit and not save changes into CMOS Status Page Setup Menu and Option Page Setup Menu - Exit current page and return to Main Menu
<+/PgUp>	Increase the numeric value or make changes
<-/PgDn>	Decrease the numeric value or make changes
<F1>	General help, only for Status Page Setup Menu and Option Page Setup Menu
<F2>	Item Help
<F3>	Reserved
<F4>	Reserved
<F5>	Restore the previous CMOS value from CMOS, only for Option Page Setup Menu
<F6>	Load the file-safe default CMOS value from BIOS default table
<F7>	Load the Optimized Defaults
<F8>	Dual BIOS/Q-Flash function
<F9>	System Information
<F10>	Save all the CMOS changes, only for Main Menu

## GETTING HELP

### Main Menu

The on-line description of the highlighted setup function is displayed at the bottom of the screen.

### Status Page Setup Menu / Option Page Setup Menu

Press F1 to pop up a small help window that describes the appropriate keys to use and the possible selections for the highlighted item. To exit the Help Window press <Esc>.

## The Main Menu (For example: BIOS Ver. : R1a)

Once you enter Award BIOS CMOS Setup Utility, the Main Menu (Figure 1) will appear on the screen. The Main Menu allows you to select from eight setup functions and two exit choices. Use arrow keys to select among the items and press <Enter> to accept or enter the sub-menu.

CMOS Setup Utility-Copyright (C) 1984-2003 Award Software

▶ Standard CMOS Features	Select Language
▶ Advanced BIOS Features	Load Fail-Safe Defaults
▶ Integrated Peripherals	Load Optimized Defaults
▶ Power Management Setup	Set Supervisor Password
▶ PnP/PCI Configurations	Set User Password
▶ PC Health Status	Save & Exit Setup
▶ Frequency/Voltage Control	Exit Without Saving
ESC: Quit	F3: Change Language
F8: Dual BIOS / Q-Flash	F10: Save & Exit Setup
Time, Date, Hard Disk Type...	

Figure 1: Main Menu



**If you can't find the setting you want, please press "Ctrl+F1" to search the advanced option widden.**

- **Standard CMOS Features**

This setup page includes all the items in standard compatible BIOS.

- **Advanced BIOS Features**

This setup page includes all the items of Award special enhanced features.

- **Integrated Peripherals**  
This setup page includes all onboard peripherals.
- **Power Management Setup**  
This setup page includes all the items of Green function features.
- **PnP / PCI Configurations**  
This setup page includes all the configurations of PCI & PnP ISA resources.
- **PC Health Status**  
This setup page is the System auto detect Temperature, voltage, fan, speed.
- **Frequency / Voltage Control**  
This setup page is control CPU's clock and frequency ratio.
- **Select Language**  
This setup page is select multi language.
- **Load Fail-Safe Defaults**  
Fail-Safe Defaults indicates the value of the system parameters which the system would be in safe configuration.
- **Load Optimized Defaults**  
Optimized Defaults indicates the value of the system parameters which the system would be in best performance configuration.
- **Set Supervisor password**  
Change, set, or disable password. It allows you to limit access to the system and Setup, or just to Setup.
- **Set User password**  
Change, set, or disable password. It allows you to limit access to the system.
- **Save & Exit Setup**  
Save CMOS value settings to CMOS and exit setup.
- **Exit Without Saving**  
Abandon all CMOS value changes and exit setup.

## Standard CMOS Features

CMOS Setup Utility-Copyright (C) 1984-2003 Award Software

### Standard CMOS Features

Date (mm:dd:yy)	Tue, Mar 25 2003	Item Help
Time (hh:mm:ss)	22:31:24	Menu Level ►
►IDE Primary Master	[None]	Change the day, month, year
►IDE Primary Slave	[None]	
►IDE Secondary Master	[None]	<Week>
►IDE Secondary Slave	[None]	Sun. to Sat.
Drive A	[1.44M, 3.5"]	<Month>
Drive B	[None]	Jan. to Dec.
Floppy 3 Mode Support	[Disabled]	
Halt On	[All, But Keyboard]	<Day>
		1 to 31 (or maximum allowed in the month)
Base Memory	640K	
Extended Memory	127M	<Year>
Total Memory	128M	1999 to 2098
↑↓→←: Move    Enter:Select    +/-/PU/PD:Value    F10:Save    ESC:Exit    F1:General Help F3: Language    F5:Previous Values    F6:Fail-Safe Defaults    F7:Optimized Defaults		

Figure 2: Standard CMOS Features

### ☞ Date

The date format is <week>, <month>, <day>, <year>.

- ▶▶ Week      The week, from Sun to Sat, determined by the BIOS and is display only
- ▶▶ Month     The month, Jan. Through Dec.
- ▶▶ Day        The day, from 1 to 31 (or the maximum allowed in the month)
- ▶▶ Year        The year, from 1999 through 2098

## ☞ Time

The times format in <hour> <minute> <second>. The time is calculated base on the 24-hour military-time clock. For example, 1 p.m. is 13:00:00.

## ☞ IDE Primary Master, Slave / IDE Secondary Master, Slave

The category identifies the types of hard disk from drive C to F that has been installed in the computer. There are two types: auto type, and manual type. Manual type is user-definable; Auto type which will automatically detect HDD type.

Note that the specifications of your drive must match with the drive table. The hard disk will not work properly if you enter improper information for this category.

If you select User Type, related information will be asked to enter to the following items. Enter the information directly from the keyboard and press <Enter>. Such information should be provided in the documentation form your hard disk vendor or the system manufacturer.

- ▶▶ CYLS.                    Number of cylinders
- ▶▶ HEADS                 Number of heads
- ▶▶ PRECOMP             Write precomp
- ▶▶ LANDZONE            Landing zone
- ▶▶ SECTORS              Number of sectors

If a hard disk has not been installed select NONE and press <Enter>.

## ☞ Drive A / Drive B

The category identifies the types of floppy disk drive A or drive B that has been installed in the computer.

- ▶▶ None                    No floppy drive installed
- ▶▶ 360K, 5.25"            5.25 inch PC-type standard drive; 360K byte capacity.
- ▶▶ 1.2M, 5.25"            5.25 inch AT-type high-density drive; 1.2M byte capacity  
(3.5 inch when 3 Mode is Enabled).
- ▶▶ 720K, 3.5"             3.5 inch double-sided drive; 720K byte capacity
- ▶▶ 1.44M, 3.5"            3.5 inch double-sided drive; 1.44M byte capacity.
- ▶▶ 2.88M, 3.5"            3.5 inch double-sided drive; 2.88M byte capacity.

### ☞ **Floppy 3 Mode Support (for Japan Area)**

- ▶▶ Disabled            Normal Floppy Drive. (Default value)
- ▶▶ Drive A            Drive A is 3 mode Floppy Drive.
- ▶▶ Drive B            Drive B is 3 mode Floppy Drive.
- ▶▶ Both                Drive A & B are 3 mode Floppy Drives.

### ☞ **Halt on**

The category determines whether the computer will stop if an error is detected during power up.

- ▶▶ NO Errors            The system boot will not stop for any error that may be detected and you will be prompted.
- ▶▶ All Errors            Whenever the BIOS detects a non-fatal error the system boot will be stopped.
- ▶▶ All, But Keyboard    The system boot will not stop for all errors except a keyboard error. (Default value)
- ▶▶ All, But Diskette    The system boot will not stop for all errors except a disk error.
- ▶▶ All, But Disk/Key    The system boot will not stop for all errors except keyboard and disk errors.

### ☞ **Memory**

The category is display-only which is determined by POST (Power On Self Test) of the BIOS.

#### **Base Memory**

The POST of the BIOS will determine the amount of base (or conventional) memory installed in the system.

The value of the base memory is typically 512 K for systems with 512K memory installed on the motherboard, or 640 K for systems with 640 K or more memory installed on the motherboard.

#### **ExtendedMemory**

The BIOS determines how much extended memory is present during the POST.

This is the amount of memory located above 1MB in the CPU's memory address map.

# Advanced BIOS Features

CMOS Setup Utility-Copyright (C) 1984-2003 Award Software

## Advanced BIOS Features

▶ SCSI/RAID Cntrl Boot Order	[Press Enter]	Item Help
First Boot Device	[Floppy]	Menu Level ▶
Second Boot Device	[HDD-0]	Select onboard RAID or
Third Boot Device	[CDROM]	PCI SCSI boot rom
Password Check	[Setup]	order
Full Screen LOGO Show	[Enabled]	
Intel OnScreen Branding	[Enabled]	
# CPU Hyper-Threading	[Enabled]	
DRAM Data Integrity Mode	Non-ECC	

↑↓→←: Move Enter:Select +/-/PU/PD:Value F10:Save ESC:Exit F1:General Help  
F3: Language F5:Previous Values F6:Fail-Safe Defaults F7:Optimized Defaults

Figure 3: Advanced BIOS Features

"#" System will detect automatically and show up when you install the Intel® Pentium® 4 processor with HT Technology.

### ☞ SCSI/RAID Cntrl Boot Order

Select boot sequence for onboard (or add-on cards) SCSI, RAID, etc.

Use <↑> or <↓> to select a device, then press <+> to move it up, or <-> to move it down the list. Press <ESC> to exit this menu.

1. Intel RAID Controller                      Select your boot device priority by Intel RAID.
2. Silicon Image RAID Controller        Select your boot device priority by Silicon Image RAID.
3. ITE RAID Controller                     Select your boot device priority by ITE RAID.

### ☞ First / Second / Third Boot Device

- ▶▶ Floppy                      Select your boot device priority by Floppy.
- ▶▶ LS120                     Select your boot device priority by LS120.
- ▶▶ HDD-0-3                  Select your boot device priority by Hard Disk 0-3.
- ▶▶ SCSI                      Select your boot device priority by SCSI.
- ▶▶ CDROM                    Select your boot device priority by CDROM.
- ▶▶ ZIP                        Select your boot device priority by ZIP.

- ▶▶ USB-FDD            Select your boot device priority by USB-FDD.
- ▶▶ USB-ZIP            Select your boot device priority by USB-ZIP.
- ▶▶ USB-CDROM        Select your boot device priority by USB-CDROM.
- ▶▶ USB-HDD            Select your boot device priority by USB-HDD.
- ▶▶ LAN                 Select your boot device priority by LAN.
- ▶▶ Disabled            Select your boot device priority by Disabled.

### 🔓 **Password Check**

- ▶▶ Setup                The system will boot but will not access to Setup page if the correct password is not entered at the prompt. (Default value)
- ▶▶ System                The system will not boot and will not access to Setup page if the correct password is not entered at the prompt.

### 🔓 **Full Screen LOGO Show**

- ▶▶ Enabled              Display Full Screen LOGO during POST. (Default value)
- ▶▶ Disabled             Don't Display Full Screen LOGO during POST.

### 🔓 **Intel OnScreen Branding**

- ▶▶ Enabled              Show Intel OnScreen Branding. (Default value)
- ▶▶ Disabled             Don't display Intel brand logo.

### 🔓 **CPU Hyper-Threading<sup>#</sup>**

- ▶▶ Enabled              Enables CPU Hyper Threading Feature. Please note that this feature is only working for operating system with multi processors mode supported. (Default value)
- ▶▶ Disabled             Disables CPU Hyper Threading.

### 🔓 **DRAM Data Integrity Mode**

If you are using the Non-ECC DRAM, the mode will show "Non-ECC" and this function is disabled.

- ▶▶ ECC                    Set DRAM mode at ECC.
- ▶▶ Non-ECC              Set DRAM mode at Non-ECC.

<sup>#</sup> " System will detect automatically and show up when you install the Intel® Pentium® 4 processor with HT Technology.



# Integrated Peripherals

CMOS Setup Utility-Copyright (C) 1984-2003 Award Software  
Integrated Peripherals

On-Chip Primary PCI IDE	[Enabled]	Item Help
On-Chip Secondary PCI IDE	[Enabled]	Menu Level ►
On-Chip SATA	[Auto]	If a hard disk controller card is used, set at Disabled
<a href="#">SATA Port0 Configure as</a>	<a href="#">SATA Port0</a>	
<a href="#">SATA Port1 Configure as</a>	<a href="#">SATA Port1</a>	
SATA RAID Function	[Enabled]	
USB Controller	[Enabled]	[Enabled]
USB 2.0 Controller	[Enabled]	Enabled onboard IDE Port
USB Keyboard Support	[Disabled]	
USB Mouse Support	[Disabled]	
AC97 Audio	[Auto]	[Disabled]
Onboard H/W SATA	[Enabled]	Disabled onboard IDE Port
Serial ATA function	[RAID]	
Onboard H/W GIGARAID	[Enabled]	
GigaRAID Function	[RAID]	
Onboard H/W 1394	[Enabled]	
Onboard H/W LAN	[Enabled]	
Onboard Serial Port 1	[3F8/IRQ4]	
Onboard Serial Port 2	[2F8/IRQ3]	
UART Mode Select	[Normal]	
x <a href="#">UR2 Duplex Mode</a>	<a href="#">Half</a>	
Onboard Parallel Port	[378/IRQ7]	
Parallel Port Mode	[SPP]	
x <a href="#">ECP Mode Use DMA</a>	<a href="#">3</a>	
Game Port Address	[201]	
Midi Port Address	[Disabled]	
<a href="#">Midi Port IRQ</a>	<a href="#">10</a>	
CIR Port Address	[Disabled]	
x <a href="#">CIR Port IRQ</a>	<a href="#">11</a>	
↑↓→←: Move    Enter: Select    +/-/PU/PD: Value    F10: Save    ESC: Exit    F1: General Help F3: Language    F5: Previous Values    F6: Fail-Safe Defaults    F7: Optimized Defaults		

Figure 4: Integrated Peripherals

### ☞ **On-Chip Primary PCIIDE**

- ▶▶ Enabled            Enable onboard 1st channel IDE port. (Default value)
- ▶▶ Disabled            Disable onboard 1st channel IDE port.

### ☞ **On-Chip Secondary PCIIDE**

- ▶▶ Enabled            Enable onboard 2nd channel IDE port. (Default value)
- ▶▶ Disabled            Disable onboard 2nd channel IDE port.

### ☞ **On-chip SATA**

- ▶▶ Disabled            Disable SATA controller.
- ▶▶ Auto                When there is no device to be plugged in IDE1 or IDE2, SATA controller will remap to IDE controller.
- ▶▶ Manual              Set SATA Mode manually. (Default Value)

### ☞ **SATA Port0 Configure as**

- ▶▶ IDE Pri. Master    Remap SATA Port 0 to IDE Pri. Master.
- ▶▶ IDE Pri. Slave     Remap SATA Port 0 to IDE Pri. Slave.
- ▶▶ IDE Sec. Master    Remap SATA Port 0 to IDE Sec. Master.
- ▶▶ IDE Sec. Slave     Remap SATA Port 0 to IDE Sec. Slave.
- ▶▶ SATA Port0        SATA controller set to SATA port0. As this mode, it support by WinXP or later OS only. (Default value)
- ▶▶ SATA Port1        SATA controller set to SATA port1. As this mode, it support by WinXP or later OS only.

### ☞ **SATA Port1 Configure as**

- ▶▶ The values depend on SATA Port0.

### ☞ **SATA RAID Function**

- ▶▶ Enabled            Enable SATA Raid function when SATA Mode set to SATA Port 0 & SATA Port 1 only. (Default value)
- ▶▶ Disabled            Disable SATA Raid function.

### ☞ **USB Controller**

- ▶▶ Enabled            Enable USB Controller. (Default value)
- ▶▶ Disabled          Disable USB Controller.

### ☞ **USB 2.0 Controller**

Disable this function if you are not using onboard USB 2.0 feature.

- ▶▶ Enabled            Enable USB 2.0 Controller. (Default value)
- ▶▶ Disabled          Disable USB 2.0 Controller.

### ☞ **USB Keyboard Support**

- ▶▶ Enabled            Enable USB Keyboard Support.
- ▶▶ Disabled          Disable USB Keyboard Support. (Default value)

### ☞ **USB Mouse Support**

- ▶▶ Enabled            Enable USB Mouse Support.
- ▶▶ Disabled          Disable USB Mouse Support. (Default value)

### ☞ **AC'97 Audio**

- ▶▶ Auto                Auto detect AC'97 audio function. (Default Value)
- ▶▶ Disabled          Disable AC'97 audio function.

### ☞ **Onboard H/W SATA**

- ▶▶ Enabled            Enable onboard SATA function. (Default value)
- ▶▶ Disabled          Disable this function.

### ☞ **Serial ATA Function**

- ▶▶ RAID                Set onboard SATA chip function as RAID. (Default value)
- ▶▶ BASE                Set onboard SATA chip function as base.

### ☞ **GigaRAID Function**

- ▶▶ RAID                Set onboard GigaRAID chip function as RAID. (Default value)
- ▶▶ ATA                 Set onboard GigaRAID chip function as ATA.

### ☞ **Onboard H/WGIGARAID**

- ▶▶ Enabled            Enable onboard RAID function. (Default value)
- ▶▶ Disabled            Disable this function.

### ☞ **Onboard H/W 1394**

- ▶▶ Enabled            Enable onboard IEEE1394 function. (Default value)
- ▶▶ Disabled            Disable this function.

### ☞ **Onboard H/WLAN**

- ▶▶ Enabled            Enable Onboard H/W LAN function. (Default value)
- ▶▶ Disabled            Disable this function.

### ☞ **Onboard Serial Port 1**

- ▶▶ Auto                BIOS will automatically setup the port 1 address.
- ▶▶ 3F8/IRQ4            Enable onboard Serial port 1 and address is 3F8. (Default value)
- ▶▶ 2F8/IRQ3            Enable onboard Serial port 1 and address is 2F8.
- ▶▶ 3E8/IRQ4            Enable onboard Serial port 1 and address is 3E8.
- ▶▶ 2E8/IRQ3            Enable onboard Serial port 1 and address is 2E8.
- ▶▶ Disabled            Disable onboard Serial port 1.

### ☞ **Onboard Serial Port 2**

- ▶▶ Auto                BIOS will automatically setup the port 2 address.
- ▶▶ 3F8/IRQ4            Enable onboard Serial port 2 and address is 3F8.
- ▶▶ 2F8/IRQ3            Enable onboard Serial port 2 and address is 2F8. (Default value)
- ▶▶ 3E8/IRQ4            Enable onboard Serial port 2 and address is 3E8.
- ▶▶ 2E8/IRQ3            Enable onboard Serial port 2 and address is 2E8.
- ▶▶ Disabled            Disable onboard Serial port 2.

### ☞ **UART Mode Select**

This item allows you to determine which Infra Red(IR) function of Onboard I/O chip.

- ▶▶ ASKIR                Set onboard I/O chip UART to ASKIR Mode.
- ▶▶ IrDA                 Set onboard I/O chip UART to IrDA Mode.
- ▶▶ Normal              Set onboard I/O chip UART to Normal Mode. (Default Value)

### ☞ **UR2DuplexMode**

This feature allows you to select IR mode.

This function will be available when "UART Mode Select" is not set to Normal.

- ▶▶ Half                      IR Function Duplex Half. (Default Value)
- ▶▶ Full                      IR Function Duplex Full.

### ☞ **Onboard Parallel port**

This feature allows you to select from a given set of parameters if the parallel port uses the onboard I/O controller.

- ▶▶ Disabled                Disable onboard LPT port.
- ▶▶ 378/IRQ7                Enable onboard LPT port and address is 378/IRQ7. (Default Value)
- ▶▶ 278/IRQ5                Enable onboard LPT port and address is 278/IRQ5.
- ▶▶ 3BC/IRQ7                Enable onboard LPT port and address is 3BC/IRQ7.

### ☞ **Parallel Port Mode**

This feature allows you to connect with an advanced printer via the port mode it supports.

- ▶▶ SPP                      Using Parallel port as Standard Parallel Port. (Default Value)
- ▶▶ EPP                      Using Parallel port as Enhanced Parallel Port.
- ▶▶ ECP                      Using Parallel port as Extended Capabilities Port.
- ▶▶ ECP+EPP                Using Parallel port as ECP & EPP mode.

### ☞ **ECPModeUseDMA**

This feature allows you to select Direct Memory Access(DMA) channel if the ECP mode is selected.

This function will be available when "Parallel Port Mode" is set to ECP or ECP+EPP.

- ▶▶ 3                        Set ECP Mode Use DMA to 3. (Default Value)
- ▶▶ 1                        Set ECP Mode Use DMA to 1.

### ☞ **Game Port Address**

- ▶▶ 201                      Set Game Port Address to 201. (Default Value)
- ▶▶ 209                      Set Game Port Address to 209.
- ▶▶ Disabled                Disable this function.

### ☞ **Midi Port Address**

- ▶▶ 300                      Set Midi Port Address to 300.
- ▶▶ 330                      Set Midi Port Address to 330.
- ▶▶ Disabled                Disable this function. (Default Value)

### ☞ **Midi Port IRQ**

- ▶▶ 5                    Set Midi Port IRQ to 5.
- ▶▶ 10                  Set Midi Port IRQ to 10. (Default Value)

### ☞ **CIR Port Address**

- ▶▶ 310                  Set CIR Port Address to 310.
- ▶▶ 320                  Set CIR Port Address to 320.
- ▶▶ Disabled            Disable this function. (Default Value)

### ☞ **CIR Port IRQ**

- ▶▶ 5                    Set CIR Port IRQ to 5.
- ▶▶ 11                   Set CIR Port IRQ to 11. (Default Value)

# Power Management Setup

CMOS Setup Utility-Copyright (C) 1984-2003 Award Software

## Power Management Setup

		Item Help
ACPI Suspend Type	[S1(POS)]	Menu Level ►
Power LED in S1 state	[Blinking]	[S1]
Off by Power button	[Instant-off]	Set suspend type to
PME Event Wake Up	[Enabled]	Power On Suspend under
ModemRingOn/WakeOnLan	[Enabled]	ACPI OS
Resume by Alarm	[Disabled]	[S3]
x Date (of Month) Alarm	Everyday	Set suspend type to
x Time (hh:mm:ss) Alarm	0 : 0 : 0	Suspend to RAM under
Power On by Mouse	[Disabled]	ACPI OS
Power On by Keyboard	[Disabled]	
x KB Power ON Password	Enter	
AC Back Function	[Soft-Off]	

↑↓ → ← : Move    Enter: Select    +/-/PU/PD: Value    F10: Save    ESC: Exit    F1: General Help  
 F3: Language    F5: Previous Values    F6: Fail-Safe Defaults    F7: Optimized Defaults

Figure 5: Power Management Setup

### ☞ ACPI Suspend Type

- ▶▶ S1(POS)      Set ACPI suspend type to S1. (Default Value)
- ▶▶ S3(STR)      Set ACPI suspend type to S3.

### ☞ Power LED in S1 state

- ▶▶ Blinking      In standby mode(S1), power LED will blink. (Default Value)
- ▶▶ Dual/OFF      In standby mode(S1):
  - a. If use single color LED, power LED will turn off.
  - b. If use dual color LED, power LED will turn to another color.

### ☞ **Off by Power button**

- ▶▶ Instant-off            Press power button then Power off instantly. (Default value)
- ▶▶ Delay 4 Sec.        Press power button 4 sec. to Power off. Enter suspend if button is pressed less than 4 sec.

### ☞ **PME Event Wake Up**

- ▶▶ Disabled            Disable this function.
- ▶▶ Enabled             Enable PME Event Wake up. (Default Value)

### ☞ **ModemRingOn/WakeOnLAN**

An incoming call via modem can awake the system from any suspend state or an input signal comes from the other client server on the LAN can awake the system from any suspend state.

- ▶▶ Disabled            Disable Modem Ring on/wake on Lan function.
- ▶▶ Enabled             Enable Modem Ring on/wake on Lan. (Default Value)

### ☞ **Resume by Alarm**

You can set "Resume by Alarm" item to enabled and key in Data/time to power on system.

- ▶▶ Disabled            Disable this function. (Default Value)
- ▶▶ Enabled             Enable alarm function to POWER ON system.  
If RTC Alarm Lead To Power On is Enabled.  
Date (of Month) Alarm : Everyday, 1~31  
Time (hh: mm: ss) Alarm : (0~23) : (0~59) : (0~59)

### ☞ **Power On By Mouse**

- ▶▶ Disabled            Disabled this function. (Default value)
- ▶▶ Mouse Click        Double click on PS/2 mouse left button to power on the system.

### ☞ **Power On By Keyboard**

This feature allows you to set the method for powering-on the system.

The option "Password" allows you to set up to 5 alphanumeric characters to power-on the system.

The option "Keyboard 98" allows you to use the standard keyboard 98 to power on the system.

- ▶▶ Password            Enter from 1 to 5 characters to set the Keyboard Power On Password.
- ▶▶ Disabled            Disabled this function. (Default value)
- ▶▶ Keyboard 98        If your keyboard have "POWER Key" button, you can press the key to power on the system.



### ☞ **KB Power ON Password**

When "Power On by Keyboard" set at Password, you can set the password here.

- ▶▶ Enter                    Input password (from 1 to 5 characters) and press Enter to set the Keyboard Power On password.

### ☞ **ACBACK Function**

- ▶▶ Soft-Off                When AC-power back to the system, the system will be in "Off" state.  
(Default Value)
- ▶▶ Full-On                When AC-power back to the system, the system always in "On" state.
- ▶▶ Memory                When AC-power back to the system, the system will return to the Last state before AC-power off.

# PnP/PCI Configurations

CMOS Setup Utility-Copyright (C) 1984-2003 Award Software

## PnP/PCI Configurations

PCI 1/PCI 5 IRQ Assignment	[Auto]	Item Help
PCI 2 IRQ Assignment	[Auto]	Menu Level ►
PCI 3 IRQ Assignment	[Auto]	
PCI 4 IRQ Assignment	[Auto]	
↑↓→←: Move    Enter:Select    +/-/PU/PD:Value    F10:Save    ESC:Exit    F1:General Help F3: Language    F5:Previous Values    F6:Fail-Safe Defaults    F7:Optimized Defaults		

Figure 6: PnP/PCI Configurations

### ☞ PCI 1/PCI 5 IRQ Assignment

- ▶▶ Auto                      Auto assign IRQ to PCI 1/PCI 5. (Default value)
- ▶▶ 3,4,5,7,9,10,11,12,14,15    Set IRQ 3,4,5,7,9,10,11,12,14,15 to PCI 1/PCI 5.

### ☞ PCI 2 IRQ Assignment

- ▶▶ Auto                      Auto assign IRQ to PCI 2. (Default value)
- ▶▶ 3,4,5,7,9,10,11,12,14,15    Set IRQ 3,4,5,7,9,10,11,12,14,15 to PCI 2.

### ☞ PCI 3 IRQ Assignment

- ▶▶ Auto                      Auto assign IRQ to PCI 3. (Default value)
- ▶▶ 3,4,5,7,9,10,11,12,14,15    Set IRQ 3,4,5,7,9,10,11,12,14,15 to PCI 3.

### ☞ PCI 4 IRQ Assignment

- ▶▶ Auto                      Auto assign IRQ to PCI 4. (Default value)
- ▶▶ 3,4,5,7,9,10,11,12,14,15    Set IRQ 3,4,5,7,9,10,11,12,14,15 to PCI 4.

# PC Health Status

CMOS Setup Utility-Copyright (C) 1984-2002 Award Software

## PC Health Status

Reset Case Open Status	[Disabled]	Item Help
Case Opened	Yes	Menu Level ►
Vcore	OK	[Disabled]
DDR25V	OK	Don't reset case
+3.3V	OK	open status
+5V	OK	
+12V	OK	[Enabled]
Current CPU Temperature	33°C	Clear case open
Current CPU FAN Speed	4687 RPM	status at next boot
Current POWER FAN Speed	0 RPM	
Current SYSTEM FAN Speed	0 RPM	
CPU Warning Temperature	[Disabled]	
CPU FAN Fail Warning	[Disabled]	
POWER FAN Fail Warning	[Disabled]	
SYSTEM FAN Fail Warning	[Disabled]	
CPU Smart FAN Control	[Enabled]	
↑↓→←: Move    Enter: Select    +/-/PU/PD: Value    F10: Save    ESC: Exit    F1: General Help F3: Language    F5: Previous Values    F6: Fail-Safe Defaults    F7: Optimized Defaults		

Figure 7: PC Health Status

### Reset Case Open Status

#### Case Opened

If the case is closed, "Case Opened" will show "No".

If the case have been opened, "Case Opened" will show "Yes".

If you want to reset "Case Opened" value, set "Reset Case Open Status" to "Enabled" and save CMOS, your computer will restart.

#### Current Voltage (V) Vcore / DDR25V / +3.3V / +5V / +12V

►► Detect system's voltage status automatically.

### ☞ **Current CPU Temperature**

- ▶▶ Detect CPU Temp. automatically.

### ☞ **Current CPU/POWER/SYSTEM FAN Speed (RPM)**

- ▶▶ Detect CPU/POWER/SYSTEM Fan speed status automatically.

### ☞ **CPU Warning Temperature**

- ▶▶ 60°C / 140°F      Monitor CPU Temp. at 60°C / 140°F.
- ▶▶ 70°C / 158°F      Monitor CPU Temp. at 70°C / 158°F.
- ▶▶ 80°C / 176°F      Monitor CPU Temp. at 80°C / 176°F.
- ▶▶ 90°C / 194°F      Monitor CPU Temp. at 90°C / 194°F.
- ▶▶ Disabled            Disable this function.(Default value)

### ☞ **CPU FAN Fail Warning**

- ▶▶ Disabled            Fan Warning Function Disable. (Default value)
- ▶▶ Enabled             Fan Warning Function Enable.

### ☞ **POWER FAN Fail Warning**

- ▶▶ Disabled            Fan Warning Function Disable. (Default value)
- ▶▶ Enabled             Fan Warning Function Enable.

### ☞ **SYSTEM FAN Fail Warning**

- ▶▶ Disabled            Fan Warning Function Disable. (Default value)
- ▶▶ Enabled             Fan Warning Function Enable.

### ☞ **CPU Smart FAN Control**

- ▶▶ Enabled            Enable CPU Smart Fan control function. (Default value)
  - a. When the CPU temperature is higher than 40 degrees Celsius, CPU fan will run at full speed.
  - b. When the CPU temperature is lower than 40 degrees Celsius, CPU fan will run at low speed.
- ▶▶ Disabled            Disable this function.

# Frequency/Voltage Control

CMOS Setup Utility-Copyright (C) 1984-2003 Award Software

## Frequency/Voltage Control

		Item Help
CPU Clock Ratio	[15X]	
CPU Host Clock Control	[Disabled]	Menu Level ►
※ CPU Host Frequency (Mhz)	133	
※ AGP/PCI/SRC Fixed	66/33/100	
Memory Frequency For	[Auto]	
Memory Frequency (Mhz)	266	
AGP/PCI/SRC Frequency (Mhz)	66/33/100	
DIMM OverVoltage Control	[Normal]	
AGP OverVoltage Control	[Normal]	
Normal CPU Vcore	1.5250V	
↑↓→←: Move    Enter:Select    +/-/PU/PD:Value    F10:Save    ESC:Exit    F1:General Help F3: Language    F5:Previous Values    F6:Fail-Safe Defaults    F7:Optimized Defaults		

Figure 8: Frequency/Voltage Control

※ Those items will be available when "CPU Host Clock Control" is set to Enabled.

### ☞ CPU Clock Ratio

This option will not be shown or not be available if you are using a CPU with the locked ratio.

▶▶ 15X-21X      It depends on CPU Clock Ratio.

**This setup option will automatically assign by CPU detection.**

**For C-Stepping P4:** 8X,10X~24X default: 15X

**For Northwood CPU:** 12X~24X default: 16X

The option will display "Locked" and read only if the CPU ratio is not changeable.

### ☞ CPU Host Clock Control

Note: If system hangs up before enter CMOS setup utility, wait for 20 sec for times out reboot.

When time out occur, system will reset and run at CPU default Host clock at next boot.

- ▶▶ Disabled      Disable CPU Host Clock Control. (Default value)
- ▶▶ Enabled        Enable CPU Host Clock Control.

### ☞ CPU Host Frequency (Mhz)

- ▶▶ 100MHz ~ 355MHz      Set CPU Host Clock from 100MHz to 355MHz.

⚠\* Incorrect using it may cause your system broken. For power End-User use only!

### ☞ AGP/PCI/SRC Fixed

Serial ATA device is very sensitive to SRC clock. SRC over clock may make Serial ATA device function can't work properly.

- ▶▶ Adjust AGP/PCI/SRC clock asychrohus with CPU.

### ☞ Memory Frequency For

for FSB(Front Side Bus) frequency=400MHz,

- ▶▶ 2.0              Memory Frequency = Host clock X 2.0.
- ▶▶ 2.66            Memory Frequency = Host clock X 2.66.
- ▶▶ Auto            Set Memory frequency by DRAM SPD data. (Default value)

for FSB(Front Side Bus) frequency=533MHz,

- ▶▶ 2.0              Memory Frequency = Host clock X 2.0.
- ▶▶ 2.5              Memory Frequency = Host clock X 2.5.
- ▶▶ Auto            Set Memory frequency by DRAM SPD data. (Default value)

for FSB(Front Side Bus) frequency=800MHz,

- ▶▶ 2.0              Memory Frequency = Host clock X 2.0.
- ▶▶ 1.6              Memory Frequency = Host clock X 1.6.
- ▶▶ 1.33            Memory Frequency = Host clock X 1.33.
- ▶▶ Auto            Set Memory frequency by DRAM SPD data. (Default value)

### ☞ **Memory Frequency (Mhz)**

- ▶▶ The values depend on CPU Host Frequency(Mhz) .

### ☞ **AGP/PCI/SRC Frequency (Mhz)**

- ▶▶ The values depend on Fixed AGP/PCI/SRC Frequency.

### ☞ **DIMM OverVoltage Control**

- ▶▶ Normal                      Set DIMM OverVoltage Control to Normal. (Default value)
- ▶▶ +0.1V                      Set DIMM OverVoltage Control to +0.1V.
- ▶▶ +0.2V                      Set DIMM OverVoltage Control to +0.2V.
- ▶▶ +0.3V                      Set DIMM OverVoltage Control to +0.3V.

⚠\*Incorrect using it may cause your system broken. For power End-User use only!

### ☞ **AGP OverVoltage Control**

- ▶▶ Normal                      Set AGP OverVoltage Control to Normal. (Default value)
- ▶▶ +0.1V                      Set AGP OverVoltage Control to +0.1V.
- ▶▶ +0.2V                      Set AGP OverVoltage Control to +0.2V.
- ▶▶ +0.3V                      Set AGP OverVoltage Control to +0.3V.

⚠\*Incorrect using it may cause your system broken. For power End-User use only!

### ☞ **CPU Voltage Control**

- ▶▶ Supports adjustable CPU Vcore from 0.8375V to 1.6000V by 0.025V step.  
(Default value: Normal)

⚠\*Incorrect using it may cause your system broken. For power End-User use only!

### ☞ **Normal CPU Vcore**

- ▶▶ Display your CPU Vcore Voltage.

## Select Language

CMOS Setup Utility-Copyright (C) 1984-2003 Award Software

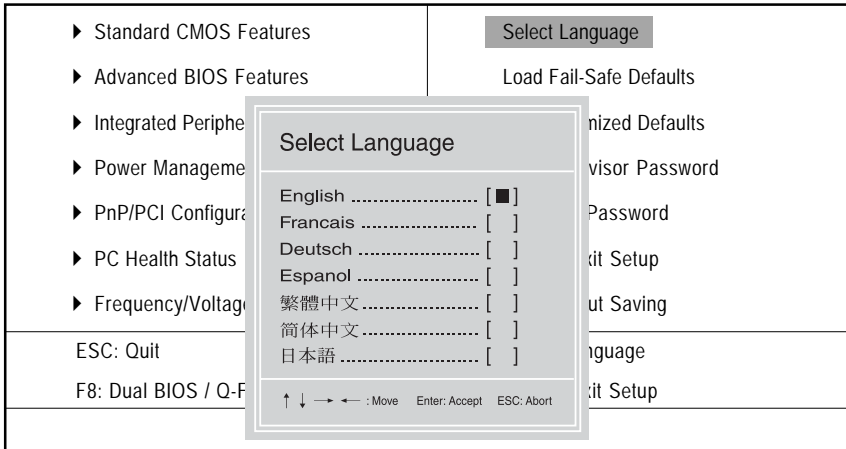

Figure 10: Select Language

### Select Language

Multi Language is supports 7 languages. There are English, French, German, Spanish, Traditional Chinese, Simplified Chinese, Japanese.



## Load Fail-Safe Defaults

CMOS Setup Utility-Copyright (C) 1984-2003 Award Software

▶ Standard CMOS Features	Select Language
▶ Advanced BIOS Features	Load Fail-Safe Defaults
▶ Integrated Peripherals	Load Optimized Defaults
▶ Power Management	Load Fail-Safe Defaults (Y/N) ? Y
▶ PnP/PCI Configurations	Set User Password
▶ PC Health Status	Save & Exit Setup
▶ Frequency/Voltage Control	Exit Without Saving
ESC: Quit	F3: Change Language
F8: Dual BIOS / Q-Flash	F10: Save & Exit Setup
Load Fail-Safe Defaults	

Figure 11: Load Fail-Safe Defaults

### Load Fail-Safe Defaults

Fail-Safe defaults contain the most appropriate values of the system parameters that allow minimum system performance.

## Load Optimized Defaults

CMOS Setup Utility-Copyright (C) 1984-2003 Award Software

▶ Standard CMOS Features	Select Language
▶ Advanced BIOS Features	Load Fail-Safe Defaults
▶ Integrated Peripherals	Load Optimized Defaults
▶ Power Management	Load Optimized Defaults (Y/N) ? Y
▶ PnP/PCI Configurations	Set User Password
▶ PC Health Status	Save & Exit Setup
▶ Frequency/Voltage Control	Exit Without Saving
ESC: Quit	
F3: Change Language	
F8: Dual BIOS / Q-Flash	
F10: Save & Exit Setup	
Load Optimized Defaults	

Figure 12: Load Optimized Defaults

### Load Optimized Defaults

Selecting this field loads the factory defaults for BIOS and Chipset Features which the system automatically detects.

## Set Supervisor/User Password

CMOS Setup Utility-Copyright (C) 1984-2003 Award Software

▶ Standard CMOS Features	Select Language
▶ Advanced BIOS Features	Load Fail-Safe Defaults
▶ Integrated Peripherals	Load Optimized Defaults
▶ Power Management	Enter Password: <input type="text"/>
▶ PnP/PCI Configurations	Set User Password
▶ PC Health Status	Save & Exit Setup
▶ Frequency/Voltage Control	Exit Without Saving
ESC: Quit	F3: Change Language
F8: Dual BIOS / Q-Flash	F10: Save & Exit Setup
Change/Set/Disable Password	

Figure 13: Password Setting

When you select this function, the following message will appear at the center of the screen to assist you in creating a password.

Type the password, up to eight characters, and press <Enter>. You will be asked to confirm the password. Type the password again and press <Enter>. You may also press <Esc> to abort the selection and not enter a password.

To disable password, just press <Enter> when you are prompted to enter password. A message "PASSWORD DISABLED" will appear to confirm the password being disabled. Once the password is disabled, the system will boot and you can enter Setup freely.

The BIOS Setup program allows you to specify two separate passwords:

SUPERVISOR PASSWORD and a USER PASSWORD. When disabled, anyone may access all BIOS Setup program function. When enabled, the Supervisor password is required for entering the BIOS Setup program and having full configuration fields, the User password is required to access only basic items.

If you select "System" at "Password Check" in Advance BIOS Features Menu, you will be prompted for the password every time the system is rebooted or any time you try to enter Setup Menu.

If you select "Setup" at "Password Check" in Advance BIOS Features Menu, you will be prompted only when you try to enter Setup.

## Save & Exit Setup

CMOS Setup Utility-Copyright (C) 1984-2003 Award Software

▶ Standard CMOS Features	Select Language
▶ Advanced BIOS Features	Load Fail-Safe Defaults
▶ Integrated Peripherals	Load Optimized Defaults
▶ Power Management	Save to CMOS and EXIT (Y/N) ? Y
▶ PnP/PCI	Save & Exit Setup
▶ PC Health Status	Exit Without Saving
▶ Frequency/Voltage Control	
ESC: Quit	F3: Change Language
F8: Dual BIOS / Q-Flash	F10: Save & Exit Setup
Save Data to CMOS	

Figure 14: Save & Exit Setup

Type "Y" will quit the Setup Utility and save the user setup value to RTC CMOS.

Type "N" will return to Setup Utility.

## Exit Without Saving

CMOS Setup Utility-Copyright (C) 1984-2003 Award Software

▶ Standard CMOS Features	Select Language
▶ Advanced BIOS Features	Load Fail-Safe Defaults
▶ Integrated Peripherals	Load Optimized Defaults
▶ Power Management	
▶ PnP/PCI Configurations	
▶ PC Health Status	Save & Exit Setup
▶ Frequency/Voltage Control	Exit Without Saving
ESC: Quit	
F3: Change Language	
F8: Dual BIOS / Q-Flash	
F10: Save & Exit Setup	
Abandon all Data	

Figure 15: Exit Without Saving

Type "Y" will quit the Setup Utility without saving to RTC CMOS.

Type "N" will return to Setup Utility.



## Chapter 4 Technical Reference

### @BIOS™ Introduction

**Gigabyte announces @BIOS**

**Windows BIOS Live Update Utility**



Have you ever updated BIOS by yourself? Or like many other people, you just know what BIOS is, but always hesitate to update it? Because you think updating newest BIOS is unnecessary and actually you don't know how to update it.

Maybe not like others, you are very experienced in BIOS updating and spend quite a lot of time to do it. But of course you don't like to do it too much. First, download different BIOS from website and then switch the operating system to DOS mode. Secondly, use different flash utility to update BIOS. The above process is not a interesting job. Besides, always be carefully to store the BIOS source code correctly in your disks as if you update the wrong BIOS, it will be a nightmare.

Certainly, you wonder why motherboard vendors could not just do something right to save your time and effort and save you from the lousy BIOS updating work? Here it comes! Now Gigabyte announces @BIOS -- the first Windows BIOS live update utility. This is a smart BIOS update software. It could help you to download the BIOS from internet and update it. Not like the other BIOS update software, it's a Windows utility. With the help of "@BIOS", BIOS updating is no more than a click.

Besides, no matter which mainboard you are using, if it's a Gigabyte's product\*, @BIOS help you to maintain the BIOS. This utility could detect your correct mainboard model and help you to choose the BIOS accordingly. It then downloads the BIOS from the nearest Gigabyte ftp site automatically. There are several different choices; you could use "Internet Update" to download and update your BIOS directly. Or you may want to keep a backup for your current BIOS, just choose "Save Current BIOS" to save it first. You make a wise choice to use Gigabyte, and @BIOS update your BIOS smartly. You are now worry free from updating wrong BIOS, and capable to maintain and manage your BIOS easily. Again, Gigabyte's innovative product erects a milestone in motherboard industries.

For such a wonderful software, how much it costs? Impossible! It's free! Now, if you buy a Gigabyte's motherboard, you could find this amazing software in the attached driver CD. But please remember, connected to internet at first, then you could have a internet BIOS update from your Gigabyte @BIOS.

## EasyTune™ 4 Introduction

### Gigabyte announces *EasyTune™ 4* Windows based Overclocking utility

EasyTune 4 carries on the heritage so as to pave the way for future generations.



"Overclock" might be one of the most common issues in computer field. But have many users ever tried it? The answer is probably "no". Because "Overclock" is thought to be very difficult and includes a lot of technical know-how, sometimes "Overclock" is even considered as special skills found only in some enthusiasts. But as to the experts in "Overclock", what's the truth? They may spend quite a lot of time and money to study, try and use many different hardware or BIOS tools

to do "Overclock". And even with these technologies, they still learn that it's quite a risk because the safety and stability of an "Overclock" system is unknown. Now everything is different because of a Windows based overclocking utility "EasyTune 4" --announced by Gigabyte. This windows based utility has totally changed the gaming rule of "Overclock". This is the first windows based overclocking utility is suitable for both normal and power users. Users can choose either "Easy Mode" or "Advanced Mode" for overclocking at their convenience. For users who choose "Easy Mode", they just need to click "Auto Optimize" to have autoed and immediate CPU overclocking. This software will then overdrive CPU speed automatically with the result being shown in the control panel. If users prefer "Overclock" by them, there is also another choice. Click "Advanced Mode" to enjoy "sport drive" class Overclocking user interface. "Advanced Mode", allows users to change the system bus / AGP / Memory working frequency in small increments to get ultimate system performance. It operates in coordination with Gigabyte motherboards. Besides, it is different from other traditional overclocking methods, EasyTune 4 doesn't require users to change neither BIOS nor hardware switch/jumper setting; on the other hand, they can do "Overclock" at easy step . Therefore, this is a safer way for "Overclock" as nothing is changed on software or hardware. If user runs EasyTune 4 over system's limitation, the biggest lost is only to restart the computer again and the side effect is then well controlled. Moreover, if one well-performed system speed has been tested in EasyTune 4, user can "Save" this setting and "Load" it in next time. Obviously, Gigabyte EasyTune 4 has already turned the "Overclock" technology toward to a newer generation. This wonderful software is now free bundled in Gigabyte motherboard attached in driver CD. Users may make a test drive of "EasyTune 4" to find out more amazing features by themselves.

\*Some Gigabyte products are not fully supported by EasyTune 4. Please find the products supported list in the web site.

\*Any "Overclocking action" is at user's risk, Gigabyte Technology will not be responsible for any damage or instability to your processor, motherboard, or any other components.



## DPS2 (Dual Power System 2) Introduction\*



**DPS2** - A new innovation technology from Gigabyte Technology in which gives you a total of 6-phase power circuit design. Providing 2 extra phase power circuits that motherboard design guideline recommended. In a DPS2 (Dual Power System 2)

designed motherboard, an additional 3-phase power circuit DPS2 daughter card is added on the motherboard. Providing a more durable and stable power circuit to sustain a larger electric current up to 150A. DPS2 specially design for the future coming processor, which demands a higher working frequency and a more stable and durable power circuit.

Working mode in a Dual Power System 2:

### Parallel Mode:

Both DPS2 and onboard power circuit working simultaneously, providing a total of 6-phase power circuit. If any power circuit fails, the remaining power circuit will keep working as main power circuit.

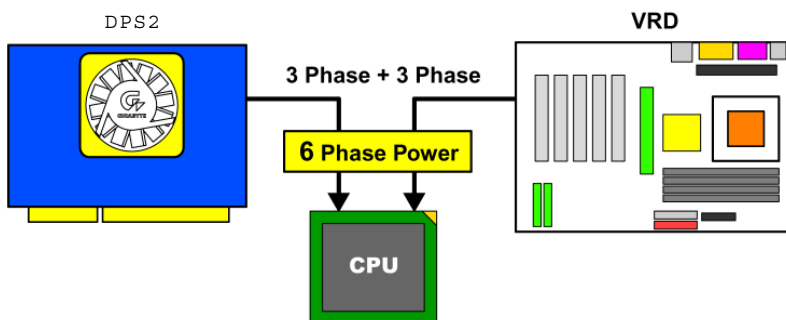

\* Only for GA-8KNXP.

# Flash BIOS Method Introduction

## Method 1 : Dual BIOS / Q-Flash

### A. What is Dual BIOS Technology?

Dual BIOS means that there are two system BIOS (ROM) on the motherboard, one is the Main BIOS and the other is Backup BIOS. Under the normal circumstances, the system works on the Main BIOS. If the Main BIOS is corrupted or damaged, the Backup BIOS can take over while the system is powered on. This means that your PC will still be able to run stably as if nothing has happened in your BIOS.

### B. How to use Dual BIOS and Q-Flash Utility?

- 1.) After power on the computer, pressing <Del> immediately during POST (Power On Self Test) it will allow you to enter Award BIOS CMOS SETUP, then press <F8> to enter Flash utility.

CMOS Setup Utility-Copyright (C) 1984-2003 Award Software

▶ Standard CMOS Features	Select Language
▶ Advanced BIOS Features	Load Fail-Safe Defaults
▶ Integrated Peripherals	Load Optimized Defaults
▶ Power M	Enter Dual BIOS / Q-Flash Utility (Y/N)? Y
▶ PnP/PCI Configurations	Set User Password
▶ PC Health Status	Save & Exit Setup
▶ Frequency/Voltage Control	Exit Without Saving
ESC: Quit	F3: Change Language
F8: Dual BIOS / Q-Flash	F10: Save & Exit Setup

## 2.) Award Dual BIOS Flash ROM Programming Utility

Dual BIOS Utility V1.30		
Boot From.....	Main Bios	
Main ROM Type/Size.....	SST 49LF003A	512K
Backup ROM Type/Size.....	SST 49LF003A	512K
Wide Range Protection	Disable	
Boot From	Main Bios	
Auto Recovery	Enable	
Halt On Error	Disable	
Keep DMI Data	Enable	
Copy Main ROM Data to Backup		
Load Default Settings		
Save Settings to CMOS		
Q-Flash Utility		
Update Main BIOS from Floppy		
Update Backup BIOS from Floppy		
Save Main BIOS to Floppy		
Save Backup BIOS to Floppy		
PgDn/PgUp: Modify	↑↓: Move	ESC: Reset F10: Power Off

## 3.) Dual BIOS Item explanation:

- **Wide Range Protection: Disable(Default), Enable**

Status 1:

If any failure (ex. Update ESCD failure, checksum error or reset...) occurs in the Main BIOS, just before the Operating System is loaded and after the power is on, and that the Wide Range Protection is set to "Enable", the PC will boot from Backup BIOS automatically.

Status 2:

If the ROM BIOS on peripherals cards(ex. SCSI Cards, LAN Cards,..) emits signals to request restart of the system after the user make any alteration on it, the boot up BIOS will not be changed to the Backup BIOS.

- **Boot From : Main BIOS(Default), Backup BIOS**

Status 1:

The user can set to boot from main BIOS or Backup BIOS.

Status 2:

If one of the main BIOS or the Backup BIOS fails, this item "*Boot From : Main BIOS(Default)*" will become gray and will not be changed by user.

- **Auto Recovery : Enable(Default), Disable**

When one of the Main BIOS or Backup BIOS occurs checksum failure, the working BIOS will automatically recover the BIOS of checksum failure.

(In the Power Management Setup of the BIOS Setting, if ACPI Suspend Type is set to Suspend to RAM, the Auto Recovery will be set to Enable automatically.)

(If you want to enter the BIOS setting, please press "Del" key when the boot screen appears.)

- **Halt On Error : Disable(Default), Enable**

If the BIOS occurs a checksum error or the Main BIOS occurs a WIDE RANGE PROTECTION error and Halt On Error set to Enable, the PC will show messages on the boot screen, and the system will pause and wait for the user's instruction.

If Auto Recovery : **Disable**, it will show *<or the other key to continue.>*

If Auto Recovery : **Enable**, it will show *<or the other key to Auto Recover.>*

- **Keep DMI Data : Enable(Default), Disable**

Enable: The DMI data won't be replaced by flashing new BIOS.(recommend)

Disable: The DMI data will be replaced by flashing new BIOS.

- **Copy Main ROM Data to Backup**

(If you boot from Backup ROM, this item will change to "Copy Backup ROM Data to Main")

Auto recovery message:

**BIOS Recovery: Main to Backup**

The means that the Main BIOS works normally and could automatically recover the Backup BIOS.

**BIOS Recovery: Backup to Main**

The means that the Backup BIOS works normally and could automatically recover the Main BIOS. (This auto recovery utility is set by system automatically and can't be changed by user.)

- **Load Default Settings**

Load dual BIOS default value.

- **Save Settings to CMOS**

Save revised setting.

### C. What is Q-Flash Utility?

Q-Flash utility is a pre-O.S. BIOS flash utility enables users to update its BIOS within BIOS mode, no more fooling around any OS.

### D. How to use Q-Flash?

#### Update Main BIOS from Floppy / Update Backup BIOS from Floppy

 In the A: drive, insert the "BIOS" diskette, then Press Enter to Run.

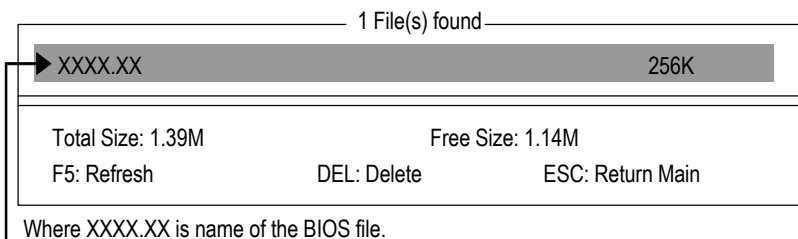

 Press Enter to Run.

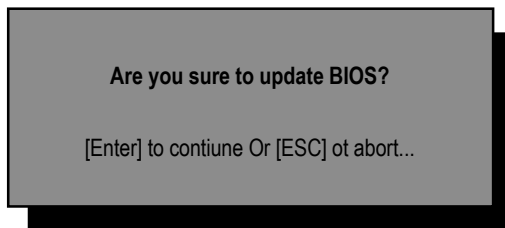

 Press Enter to Run.

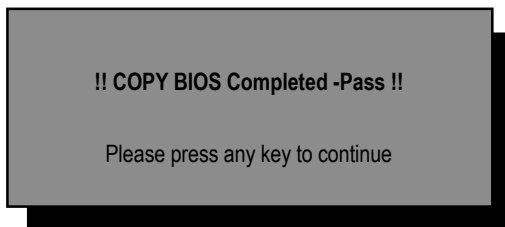

Congratulation! You have completed the flashed and now can restart system.

## Save Main BIOS to Floppy / Save Backup BIOS to Floppy

 In the A:drive, insert the floppy disk, then Press Enter to Run.

TYPE FILE NAME

▶ File name: XXXX.XX

---

Total Size: 1.39M Free Size: 1.39M

F5: Refresh DEL: Delete TAB: Switch

To name the file.

Congratulate you have accomplished the saving.

### CONTROLKEYS

<PgDn/PgUp>	Make changes
<↑>	Move to previous item
<↓>	Move to next item
<Enter>	Run
<Esc>	Reset
<F10>	Power Off



## DualBIOS™ Technology FAQ

GIGABYTE Technology is pleased to introduce DualBIOS technology, a hot spare for your system BIOS. This newest "Value-added" feature, in a long series of innovations from GIGABYTE, is available on this motherboard. Future GIGABYTE motherboards will also incorporate this innovation.

### What's DualBIOS™?

On GIGABYTE motherboards with DualBIOS there are physically two BIOS chips. For simplicity we'll call one your "Main BIOS" and the other we'll call your "Backup BIOS" (your "hot spare"). If your Main BIOS fails, the Backup BIOS almost automatically takes over on your next system boot. Almost automatically and with virtually zero down time! Whether the problem is a failure in flashing your BIOS or a virus or a catastrophic failure of the Main BIOS chip, the result is the same - the Backup BIOS backs you up, almost automatically.

### I. Q: What is DualBIOS™ technology?

#### Answer:

DualBIOS technology is a patented technology from Giga-Byte Technology. The concept of this technology is based on the redundancy and fault tolerance theory. DualBIOS™ technology simply means there are two system BIOSes (ROM) integrated onto the motherboard. One is a main BIOS, and the other is a backup BIOS. The mainboard will operate normally with the main BIOS, however, if the main BIOS is corrupt or damaged for various reasons, the backup BIOS will be automatically used when the system powered-On. Your PC will operate as before the main BIOS was damaged, and is completely transparent to the user.

## II. Q: Why does anyone need a motherboard with DualBIOS™ technology?

### Answer:

In today's systems there are more and more BIOS failures. The most common reasons are virus attacks, BIOS upgrade failures, and/or deterioration of the BIOS (ROM) chip itself.

1. New computer viruses are being found that attack and destroy the system BIOS. They may corrupt your BIOS code, causing your PC to be unstable or even not boot normally.
2. BIOS data will be corrupted if a power loss/surge occurs, or if a user resets the system, or if the power button is pressed during the process of performing a system BIOS upgrade.
3. If a user mistakenly updates their mainboard with the incorrect BIOS file, then the system may not be able to boot correctly. This may cause the PC system hang in operation or during boot.
4. A flash ROM's life cycle is limited according to electronic characteristics. The modern PC utilizes the Plug and Play BIOS, and is updated regularly. If a user changes peripherals often, there is a slight chance of damage to the flash ROM.

With Giga-Byte Technology's patented DualBIOS™ technology you can reduce the possibility of hangs during system boot up, and/or loss BIOS data due to above reasons.

This new technology will eliminate valuable system down time and costly repair bills cause by BIOS failures.

## III. Q: How does DualBIOS™ technology work?

### Answer:

This new technology will eliminate valuable system down time and costly repair bills cause by BIOS failures.

1. DualBIOS™ technology provides a wide range of protection during the boot up procedure. It protects your BIOS during system POST, ESCD update, and even all the way to PNP detection/assignment.
2. DualBIOS™ provides automatic recovery for the BIOS. When the first BIOS used during boot up does not complete or if a BIOS checksum error occurs, boot-up is still possible. In the DualBIOS™ utility, the "Auto Recovery" option will guarantee that if either the main BIOS or backup BIOS is corrupted, the DualBIOS™ technology will use the good BIOS and correct the wrong BIOS automatically.
3. DualBIOS™ provides manual recovery for the BIOS. DualBIOS™ technology contains a built-in flash utility, which can flash your system BIOS from backup to main and/or visa versa. There is no need for an OS-dependent flash utility program.
4. DualBIOS™ contains a one-way flash utility. The built-in one-way flash utility will ensure that the corrupt BIOS is not mistaken as the good BIOS during recovery and that the correct BIOS (main vs. backup) will be flashed. This will prevent the good BIOS from being flashed.



#### IV. Q: Who Needs DualBIOS™ technology?

##### Answer:

This new technology will eliminate valuable system down time and costly repair bills cause by BIOS failures.

1. Every user should have DualBIOS™ technology due to the advancement of computer viruses. Everyday, there are new BIOS-type viruses discovered that will destroy your system BIOS. Most commercial products on the market do not have solutions to guard against this type of virus intrusion. The DualBIOS™ technology will provide a state-of-the-art solution to protect your PC:
  - Case I.) Vicious computer viruses may wipe out your entire system BIOS. With a conventional single system BIOS PC, the PC will not be functional until it is sent for repairs.
  - Case II.) If the "Auto Recovery" option is enabled in the DualBIOS™ utility, and if a virus corrupts your system BIOS, the backup BIOS will automatically reboot the system and correct the main BIOS.
  - Case III.) A user may override booting from the main system BIOS. The DualBIOS™ utility may be entered to manually change the boot sequence to boot from the backup BIOS.
2. During or after a BIOS upgrade, if DualBIOS™ detects that the main BIOS is corrupt, the backup BIOS will take over the boot-up process automatically. Moreover, it will verify the main and backup BIOS checksums when booting-up. DualBIOS™ technology examines the checksum of the main and backup BIOS while the system is powered on to guarantee your BIOS operates properly.
3. Power Users will have the advantage of having two BIOS versions on their mainboard. The benefit is being able to select either version BIOS to suit the performance system needs.
4. Flexibility for high-end desktop PCs and workstation/servers. In the DualBIOS™ utility, the option can be set, "Halt On When BIOS Defects" to be enabled to halt your system with awarning message that the main BIOS has been corrupted. Most workstation/servers require constant operation to guarantee services have not been interrupted. In this situation, the "Halt On When BIOS Defects" message may be disabled to avoid system pauses during normal booting. Another advantage you gain from Giga-Byte's DualBIOS™ technology is the ability to upgrade from dual 2 Mbit BIOS to dual 4 Mbit BIOS in the future if extra BIOS storage is need.

## Method 2 : @BIOS™ Utility

If you don't have DOS boot disk, we recommend that you used Gigabyte @BIOS™ program to flash BIOS.

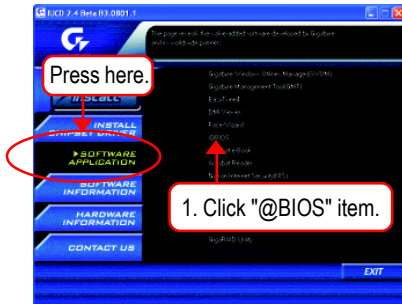

(1)

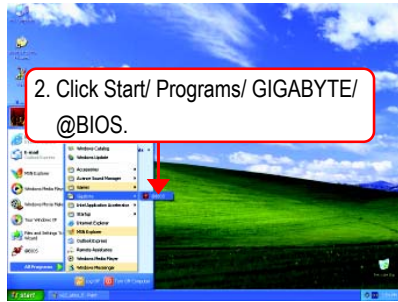

(2)

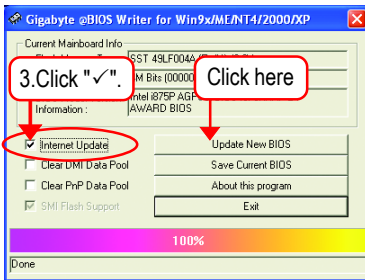

(3)

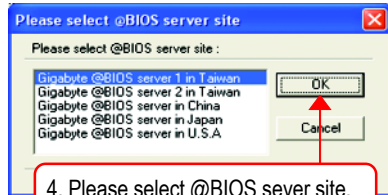

(4)

Methods and steps:

- I. Update BIOS through Internet
  - a. Click "Internet Update" icon
  - b. Click "Update New BIOS" icon
  - c. Select @BIOS™ sever
  - d. Select the exact model name on your motherboard
  - e. System will automatically download and update the BIOS.

## II. Update BIOS NOT through Internet:

- a. Do not click "Internet Update" icon
- b. Click "Update New BIOS"
- c. Please select "All Files" in dialog box while opening the old file.
- d. Please search for BIOS unzip file, downloading from internet or any other methods (such as: 8KNXP.R1a).
- e. Complete update process following the instruction.

## III. Save BIOS

In the very beginning, there is "Save Current BIOS" icon shown in dialog box. It means to save the current BIOS version.

## IV. Check out supported motherboard and Flash ROM:

In the very beginning, there is "About this program" icon shown in dialog box. It can help you check out which kind of motherboard and which brand of Flash ROM are supported.

### Note:

- a. In method I, if it shows two or more motherboard's model names to be selected, please make sure your motherboard's model name again. Selecting wrong model name will cause the system unbooted.
- b. In method II, be sure that motherboard's model name in BIOS unzip file are the same as your motherboard's. Otherwise, your system won't boot.
- c. In method I, if the BIOS file you need cannot be found in @BIOS™ server, please go onto Gigabyte's web site for downloading and updating it according to method II.
- d. Please note that any interruption during updating will cause system unbooted.

## 2- / 4- / 6-Channel Audio Function Introduction

The installation of windows 98SE/2K/ME/XP is very simple. Please follow next step to install the function!

### Stereo Speakers Connection and Settings:

We recommend that you use the speaker with amplifier to acquire the best sound effect if the stereo output is applied.

#### STEP 1:

Connect the stereo speakers or earphone to "Line Out".



Line Out

#### STEP 2:

After installation of the audio driver, you'll find an  icon on the taskbar's status area. Click the audio icon "Sound Effect" from the windows tray at the bottom of the screen.



#### STEP 3:

Select "Speaker Configuration", and choose the "2 channel for stereo speakers out put".

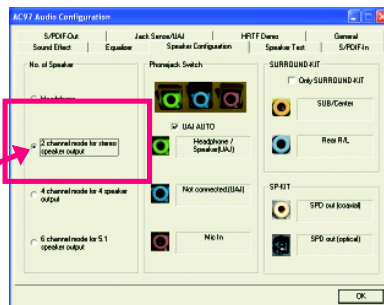
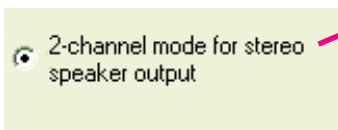

## 4 Channel Analog Audio Output Mode

STEP 1 :

Connect the front channels to "Line Out",  
the rear channels to "Line In".



Line Out Line In

STEP 2 :

After installation of the audio driver, you'll find an  icon on the taskbar's status area. Click the audio icon "Sound Effect" from the windows tray at the bottom of the screen.



STEP 3 :

Select "Speaker Configuration", and choose the "4 channel for 4 speakers out put".  
Disable "Only SURROUND-KIT", and press "OK".

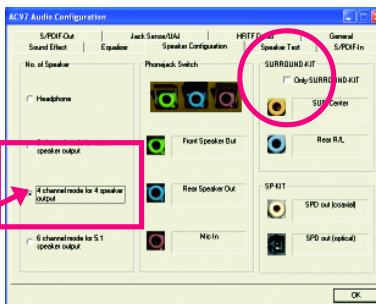
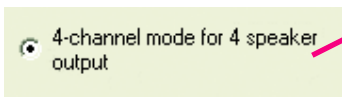

When the "Environment settings" is "None", the sound would be performed as stereo mode (2 channels output). Please select the other settings for 4 channels output.

## Basic 6 Channel Analog Audio Output Mode

Use the back audio panel to connect the audio output without any additional module.

STEP 1 :

Connect the front channels to "Line Out", the rear channels to "Line In", and the Center/Subwoofer channels to "MIC In".

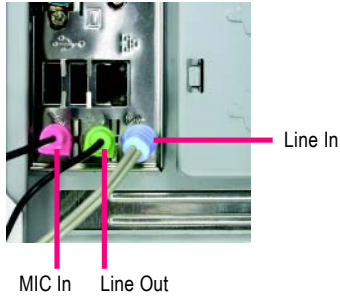

STEP 2 :

After installation of the audio driver, you'll find an  icon on the taskbar's status area. Click the audio icon "Sound Effect" from the windows tray at the bottom of the screen.



STEP 3 :

Select "Speaker Configuration", and choose the "6 channel for 5.1 speakers out put".

Disable "Only SURROUND-KIT" and press "OK".

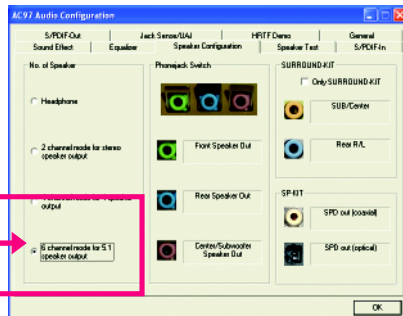
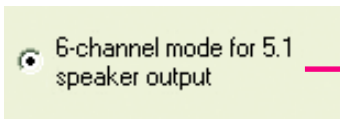

**Advanced 6 Channel Analog Audio Output Mode (using Audio Combo Kit,Optional Device):**

(Audio Combo Kit provides SPDIF output port : optical & coaxial and SURROUND-KIT : Rear R/L & CEN / Subwoofer)

SURROUND-KIT access analog output to rear channels and Center/Subwoofer channels. It is the best solution if you need 6 channel output, Line In and MIC at the same time. "SURROUND-KIT" is included in the GIGABYTE unique "Audio Combo Kit" as picture.

**STEP 1 :**

Insert the "SURROUND-KIT" in the back of the case , and fix it with the screw.

**STEP 2 :**

Connect the "SURROUND-KIT" to SUR\_CEN on the M/B.

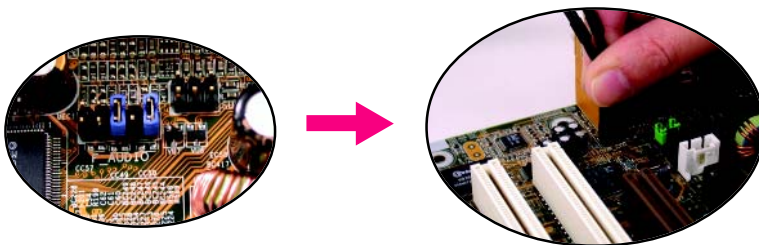

STEP 3 :

Connect the front channels to back audio panel's "Line Out", the rear channels to SURROUND-KIT's REAR R/L, and the Center/Subwoofer channels to SURROUND-KIT's SUB CENTER.

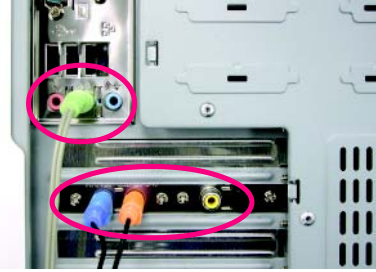

STEP 4 :

Click the audio icon "Sound Effect" from the windows tray at the bottom of the screen.

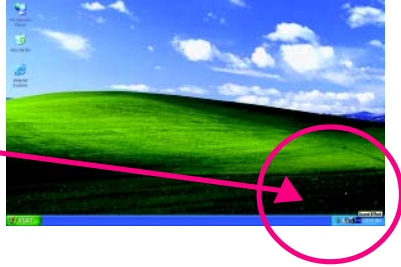

STEP 5 :

Select "Speaker Configuration", and choose the "6 channel for 5.1 speakers out put".

Enable "Only SURROUND-KIT" and press "OK".

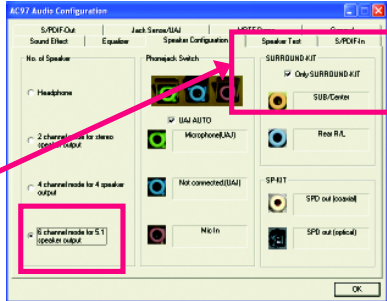
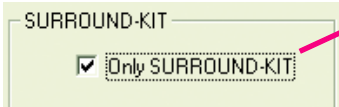

**Basic & Advanced 6 Channel Analog Audio Output ModeNotes:**

When the "Environment settings" is "None", the sound would be performed as stereo mode(2 channels output). Please select the other settings for 6 channels output.

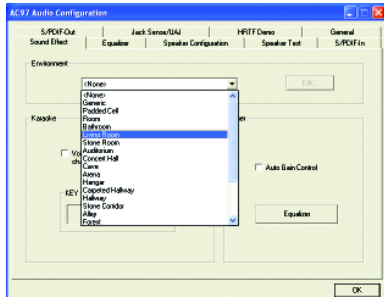



## SPDIF Output Device (Optional Device)

A "SPDIF output" device is available on the motherboard. Cable with rear bracket is provided and could link to the "SPDIF output" connector (As picture.) For the further linkage to decoder, rear bracket provides coaxial cable and Fiber connecting port.



1. Connect the SPDIF output device to the rear bracket of PC, and fix it with screw.



2. Connect SPDIF device to the motherboard.

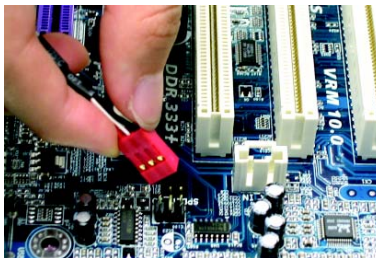

3. Connect SPDIF to the SPDIF decoder.



## Jack-Sensing Introduction



Jack-Sensing provides audio connectors error-detection function.



Install Microsoft DirectX8.1 or later version before to enable Jack-Sensing support for Windows 98/98SE/2000/ME.

Jack-Sensing includes 2 parts: AUTO and MANUAL. Following is an example for 2 channels (Windows XP):

### Introduction of audio connectors

You may connect CDROM, Walkman or others audio input devices to Line In jack, speakers, earphone or others output devices to Line Out jack, and microphone to MIC In jack.

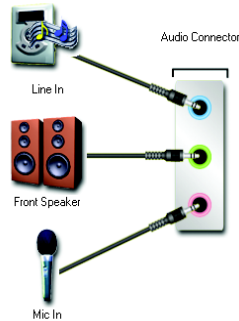

### Auto-detecting:

Please connect the devices to the right jacks as above. A window will appear as right picture if you setup the devices properly.

Please note that 3D audio function will only appear when 3D audio inputs.

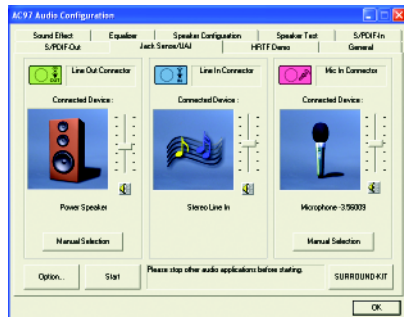

If you set wrong with the connectors, the warning message will come out as right picture.

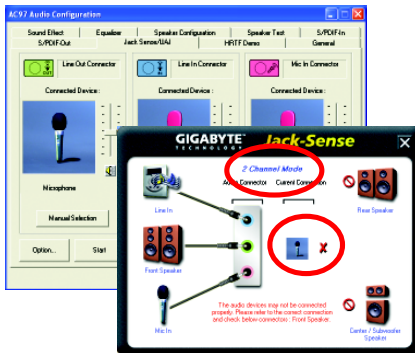

### Manual setting:

If the device picture shows different from what you set, please press "Manual Selection" to set.

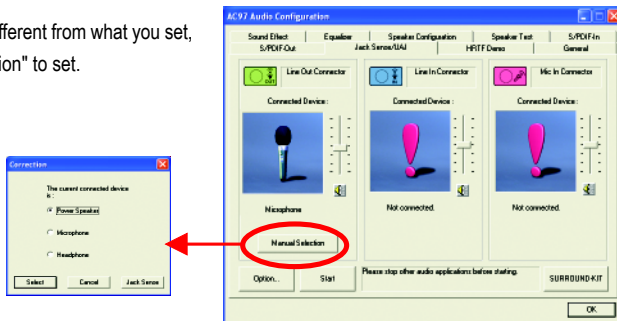

## UAJ Introduction

UAJ (Universal Audio Jack) has a very smart feature: It will switch signal automatically when user plugs his audio device to the wrong jack (Line-in/ Line-out).

That means users do not need to worry the Audio device should be plug in Line-in or Line-out jack, the device will work perfectly after UAJ is activated.



Install Microsoft DirectX8.1 or later version before to enable UAJ support for Windows 98/98SE/2000/ME.

**PS.** If UAJ couldn't work as expected, please disable this function by pressing button "UAJ information". And then Jack-Sense function will awake and auto-detect if the Audio device is plugged to the right jack (Line-in or Line-out).

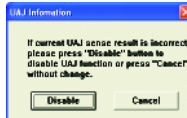
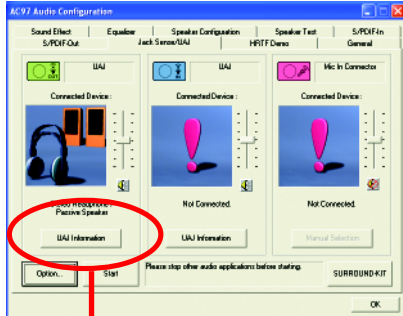

### Reviving UAJ:

You can click "UAJ AUTO" to revive UAJ function.

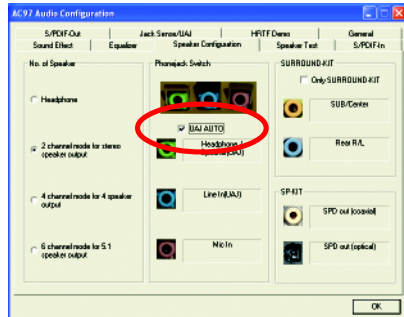

## Adjusting Sound Volume:

You can adjust sound volume by moving lever.  
Also you can mute sound by pressing the "mute button".



If there is only Line-in device plugged, UAJ will remind you there is no any Line-out device plugged in.

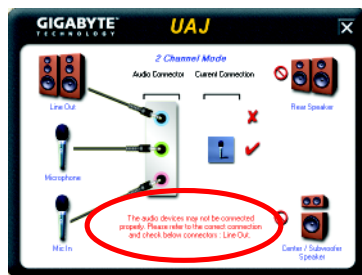

### Note:

If you want to use AUX IN function, you must disable UAJ function from the Speaker Configuration item in the AC97 Audio Configuration menu. After that, you'll have to use the Line-In volume lever in the "Volume Control" menu to adjust the volume because AUX IN and Line-In functions are controlled by the same audio signals.

# Xpress Recovery Introduction

## What is Xpress Recovery?

Xpress Recovery utility is an utility for backing up and restoring O.S. partition. If the hard drive can not work properly, you can restore it to the original state.



CAUTION

1. It supports FAT16, FAT32, NTFS format.
2. It must be connected to IDE1 Master.
3. It's only allows you to install one O.S.
4. It must be used with IDE hard disk supporting HPA.
5. The first partition must be set as the boot partition. When the boot partition is backed up, please do not change its size.
6. It is not recommend to use Xpress Recovery if you had ever used Ghost to return boot manager to NTFS format.



NOTE

1. System data and hard disk's reading/writing speed will affect backing up speed.
2. We recommend that you install Xpress Recovery immediately after installing O.S, drivers and applications.

## How to use the Xpress Recovery

There are two ways to enter the Xpress Recovery utility. (see the below)

1. Text Mode: press F9 during powering on the computer.

Press F9 during powering on the computer.

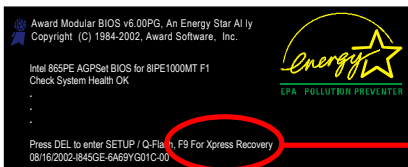

**F9 For Xpress Recovery**

2. BMP Mode: boot from CD-ROM

Please go to "Advanced BIOS" setting menu and set boot from CD-ROM, then save and exit the BIOS menu. Later, please insert MB driver CD into your drive when "Boot from CD:" appears at the bottom of the screen, press any key to enter Xpress Recovery.



**Boot from CD:**

You can highlight the item by using the arrows keys on your keyboard and enter key to enter the menu.

Text Mode:

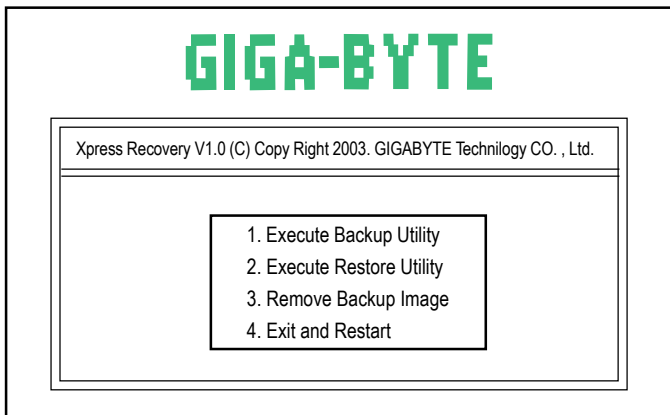

BMP Mode:



**If you ever entered Xpress Recovery by booting from CD-ROM, you'll still be directed to BMP mode by pressing F9 in the bootup screen.**

### 1.Execute Backup Utility:

 **Press B to Backup your System or Esc to Exit**

The Backup utility will scan the system automatically and back it up.

The backed up data will be saved as a hidden image.

### 2.Execute Restore Utility:

 **This program will recover your system to factory default.**

**Press R to recover your system.**

**Press Esc to exit**

Restore the backup image to the original state.

### 3.Remove Backup Image:

 **Are you sure to remove backup image? (Y/N)**

Remove the backup image.

### 4.Exit and Restart:

Exit and restart your computer.



# Chapter 5 Appendix

## Install Drivers



NOTE

### Pictures below are shown in Windows XP

Insert the driver CD-title that came with your motherboard into your CD-ROM drive, the driver CD-title will auto start and show the installation guide. If not, please double click the CD-ROM device icon in "My computer", and execute the setup.exe.

## INSTALL CHIPSET DRIVER

This page shows the drivers that need to be installed for the system. Click each item to install the driver manually or switch to the  to install the drivers automatically.

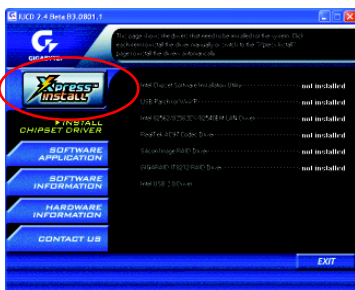

The "Xpress Install" uses the "Click and Forget" technology to install the drivers automatically. Just select the drivers you want then click the "GO" button. The  will finish the installation for you automatically.

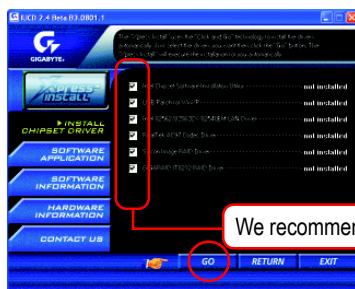

NOTE

Message: Some device drivers will restart your system automatically. After restarting your system the "Xpress Install" will continue to install other drivers.

We recommend that you install all components in the list.



Driver installation finished !  
You have to reboot system !

## Item Description

- Intel Chipset Software Installation Utility  
Tell the operating system how the chipset components will be configured.
- USB Patch for WinXP  
This patch driver can help you to resolve the USB device wake up S3 hang up issue in XP.
- Intel 82562/82562EX/82540EM LAN Driver  
For Intel® PRO/10/100/1000/Wireless Ethernet connections
- RealTek AC97 Codec Driver  
For Intel® ICH/ICH2/ICH4/ICH5/ICH5R AC97 audio
- Silicon Image RAID Driver  
Serial-ATA RAID driver for Silicon Image SiI3112
- GIGARAID IT8212 RAID Driver  
For GigaRAID IT8212 RAID IDE controller
- Intel USB 2.0 Driver  
It is recommended that you use the Microsoft Windows update for the most updated driver for XP/2K



*For USB2.0 driver support under Windows XP operating system, please use Windows Service Pack. After install Windows Service Pack, it will show a question mark "?" in "Universal Serial Bus controller" under "Device Manager". Please remove the question mark and restart the system (System will auto-detect the right USB2.0 driver).*

## SOFTWARE APPLICATION

This page reveals the value-added software developed by Gigabyte and its worldwide partners.



- **Gigabyte Windows Utilities Manager (GWUM)**  
This utility can integrate the Gigabyte's applications in the system tray
- **Gigabyte Management Tool (GMT)**  
A useful tool which can manage the computer via the network
- **EasyTune 4**  
Powerful utility that integrates the overclocking and hardware monitoring functions
- **DMI Viewer**  
Windows based utility which is used to browse the DMI/SMBIOS information of the system
- **Face-Wizard**  
New utility for adding BIOS logo
- **@BIOS**  
Gigabyte windows flash BIOS utility
- **Acrobat e-Book**  
Useful utility from Adobe
- **Acrobat Reader**  
Popular utility from Adobe for reading .PDF file format documents
- **Norton Internet Security (NIS)**  
Integrated utility which includes anti-virus, ads, etc.
- **DirectX 9.0**  
Install Microsoft DirectX 9 to enable 3D hardware acceleration that support for operating system to achieve better 3D performance.
- **Silicon Image SATA RAID Utility**  
Serial-ATA RAID utility for Silicon Image Sil3112
- **GigaRAID Utility**  
RAID utility for GigaRAID IT8212

## SOFTWARE INFORMATION

This page list the conctects of softwares and drivers in this CD title.



## HARDWARE INFORMATION

This page lists all device you have for this motherboard.



## CONTACT US

Please see the last page for details.



# Face-Wizard Utilities Installation

## What is Face-Wizard™ ?

Face-Wizard™ is a windows based utility with user-friendly interface that allows users to change the boot-up logo with picture from Gigabyte Logo Gallery on web site or other compatible picture you have.

## How does it work?

Face-Wizard™ allows user to select BIOS on board or file in hard drive, floppy disk, zip, MO or other storage devices and combine the compatible picture you prefer into BIOS. And not only this, Face-Wizard™ also helps user to update BIOS in windows mode.

## What's benefit for using Face-Wizard™ ?

It can personalize boot-up logo to show your unique style from others, and never again looking at the black and white boot up screen.

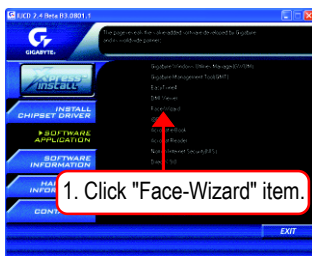

(1)

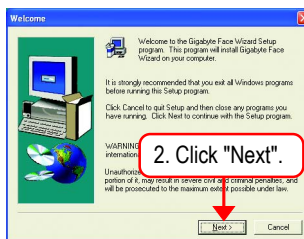

(2)

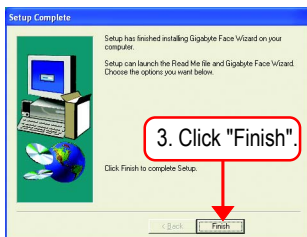

(3)

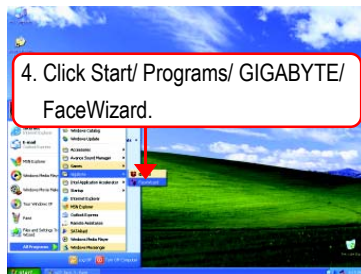

(4)

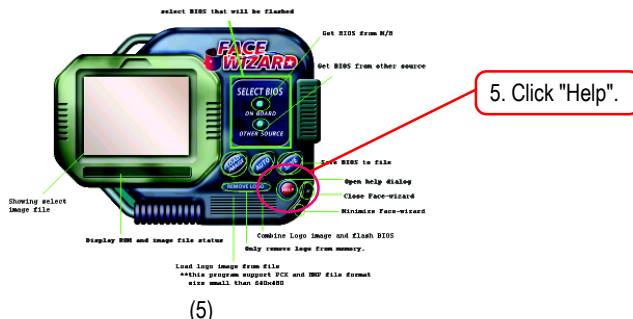

(5)

# EasyTune 4 Utilities Installation

Powerful utility that integrates the overclocking and hardware monitoring functions



(1)

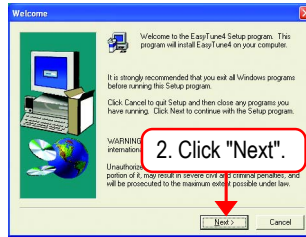

(2)

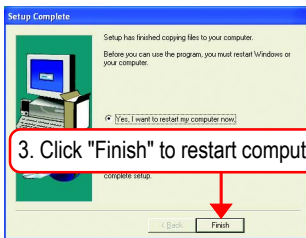

(3)

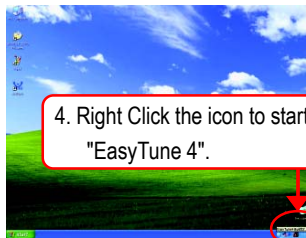

(4)

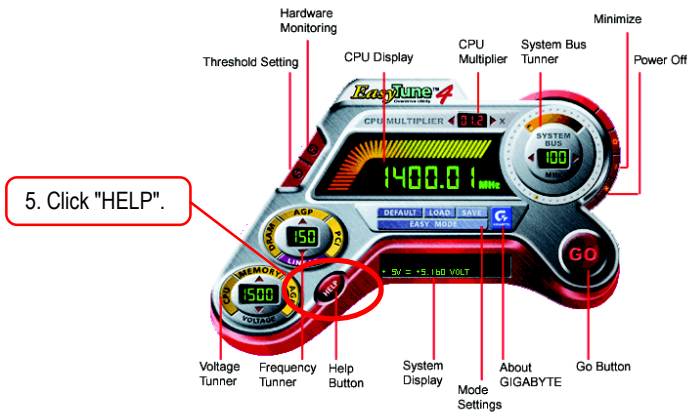

## FAQ

Below is a collection of general asked questions. To check general asked questions based on a specific motherboard model, please log on to <http://tw.giga-byte.com/faq/faq.htm>

**Question 1:** I cannot see some options that were included in previous BIOS after updating BIOS. Why?

**Answer:** Some advanced options are hidden in new BIOS version. Please press Ctrl and F1 keys after entering BIOS menu and you will be able to see these options.

**Questions 2:** Why is the light of my keyboard/optical mouse still on after computer shuts down?

**Answer:** In some boards, a small amount of electricity is kept on standby after computer shuts down and that's why the light is still on.

**Question 3:** Why cannot I use all functions in EasyTune™ 4?

**Answer:** The availability of the listed functions in EasyTune™ 4 depends on the MB chipset. If the chipset doesn't support certain functions in EasyTune™ 4, these functions will be locked automatically and you will not be able to use them.

**Question 4:** Why do I fail to install RAID and ATA drivers under Win 2000 and XP on boards that support RAID function after I connect the boot HDD to IDE3 or IDE4 ?

**Answer:** First of all, you need to save some files in the CD-ROM to a floppy disk before installing drivers. You also need to go through some rather different steps in the installation process. Therefore, we suggest that you refer to the installation steps in the RAID manual at our website. (Please download it at [http://tw.giga-byte.com/support/user\\_pdf/raid\\_manual.pdf](http://tw.giga-byte.com/support/user_pdf/raid_manual.pdf))

**Question 5:** How do I clear CMOS?

**Answer:** If your board has a Clear CMOS jumper, please refer to the Clear CMOS steps in the manual. If your board doesn't have such jumper, you can take off the on-board battery to leak voltage to clear CMOS. Please refer to the steps below:

Steps:

1. Turn off power.
2. Disconnect the power cord from MB.
3. Take out the battery gently and put it aside for about 10 minutes (Or you can use a metal object to connect the positive and negative pins in the battery holder to make them short for one minute).
4. Re-insert the battery to the battery holder.
5. Connect power cord to MB again and turn on power.
6. Press Del to enter BIOS and load Fail-Safe Defaults.
7. Save changes and reboot the system.

**Question 6:** Why does system seem unstable after updating BIOS?

**Answer:** Please remember to load Fail-Safe Defaults (Or Load BIOS Defaults) after flashing BIOS. However, if the system instability still remains, please clear CMOS to solve the problem.

**Question 7:** Why do I still get a weak sound after turning up the speaker to the maximum volume?

**Answer:** Please make sure the speaker you are using is equipped with an internal amplifier. If not, please change another speaker with power/amplifier and try again later.

**Question 8:** How do I disable onboard VGA card in order to add an external VGA card?

**Answer:** Gigabyte motherboards will auto-detect the external VGA card after it is plugged in, so you don't need to change any setting manually to disable the onboard VGA.

**Question 9:** Why cannot I use the IDE 2?

**Answer:** Please refer to the user manual and check whether you have connected any cable that is not provided with the motherboard package to the USB Over Current pin in the Front USB Panel. If the cable is your own cable, please remove it from this pin and do not connect any of your own cables to it.

**Question 10:** Sometimes I hear different continuous beeps from computer after system boots up. What do these beeps usually stand for?

**Answer:** The beep codes below may help you identify the possible computer problems. However, they are only for reference purposes. The situations might differ from case to case.

#### → AMI BIOS Beep Codes

\*Computer gives 1 short beep when system boots successfully.

\*Except for beep code 8, these codes are always fatal.

- 1 beep Refresh failure
- 2 beeps Parity error
- 3 beeps Base 64K memory failure
- 4 beeps Timer not operational
- 5 beeps Processor error
- 6 beeps 8042 - gate A20 failure
- 7 beeps Processor exception interrupt error
- 8 beeps Display memory read/write failure
- 9 beeps ROM checksum error
- 10 beeps CMOS shutdown register read/write error
- 11 beeps Cache memory bad

#### → AWARD BIOS Beep Codes

- 1 short: System boots successfully
- 2 short: CMOS setting error
- 1 long 1 short: DRAM or M/B error
- 1 long 2 short: Monitor or display card error
- 1 long 3 short: Keyboard error
- 1 long 9 short: BIOS ROM error
- Continuous long beeps: DRAM error
- Continuous short beeps: Power error



**Question 11:** How to set in the BIOS in order to bootup from SATA HDDs by either RAID or ATA mode?

**Answer:** Please set in the BIOS as follow:

1. Advanced BIOS features--> SATA/RAID/SCSI boot order: "SATA"
2. Advanced BIOS features--> First boot device: "SCSI"
3. Integrated Peripherals--> Onboard H/W Serial ATA: "enable"

Then it depends on the SATA mode that you need to set "RAID" to RAID mode or "BASE" to normal ATA mode in the item named Serial ATA function.

**Question 12:** For the M/B which have RAID function, how to set in the BIOS in order to bootup from IDE3, 4 by either RAID or ATA mode?

**Answer:** Please set in the BIOS as follow:

1. Advanced BIOS features-->(SATA)/RAID/SCSI boot order: "SATA"
2. Advanced BIOS features--> First boot device: "SCSI"
3. Integrated Peripherals--> Onboard H/W ATA/RAID: "enable"

Then it depends on the RAID mode that you need to set "RAID" to RAID mode or "ATA" to normal ATA mode in the item named RAID controller function.

**Question 13:** How to set in the BIOS to bootup from the IDE/ SCSI/ RAID card ?

**Answer:** Please set in the BIOS as follow:

1. Advanced BIOS features-->(SATA)/RAID/SCSI boot order: "SCSI"
2. Advanced BIOS features--> First boot device: "SCSI"

Then it depends on the mode(RAID or ATA) that you need to set in RAID/ SCSI BIOS.

# Troubleshooting



If you encounter any trouble during boot up, please follow the troubleshooting procedures.

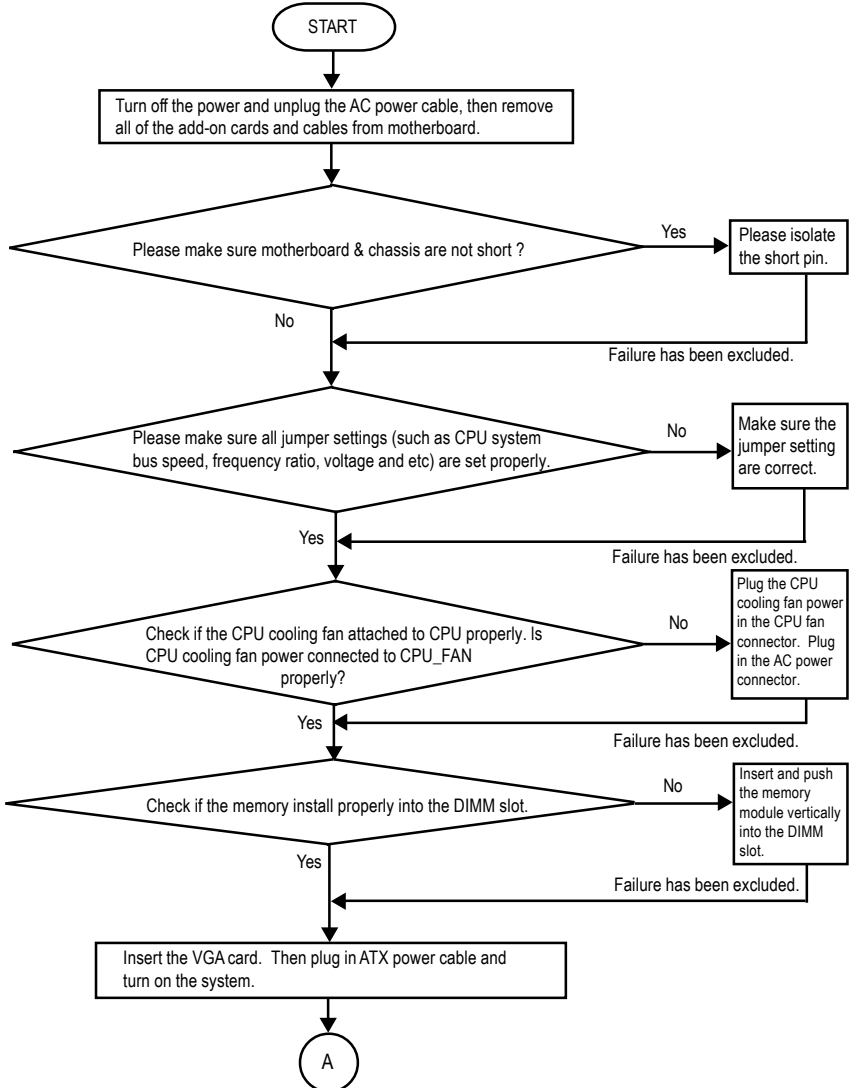

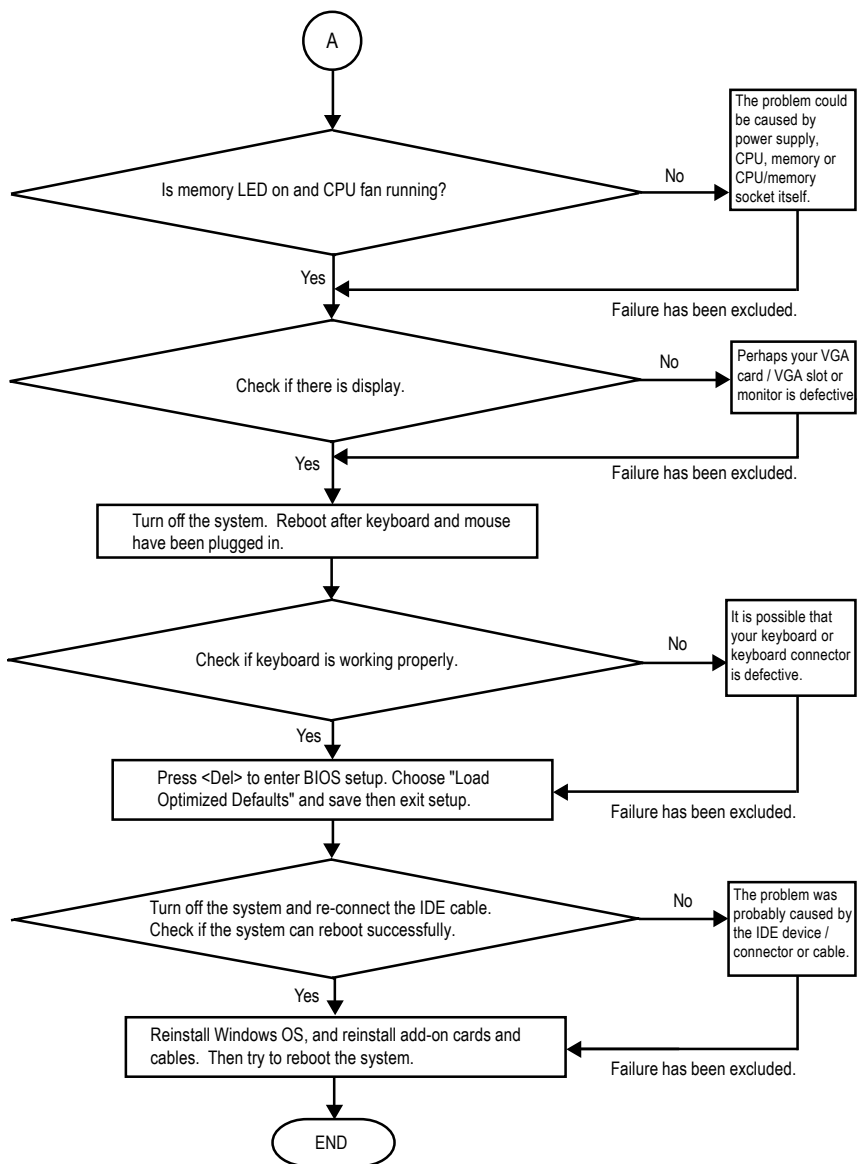

If the above procedure unable to solve your problem, please contact with your local retailer or national distributor for help. Or, you could submit your question to the service mail via Gigabyte website technical support zone (<http://www.gigabyte.com.tw>). The appropriate response will be provided ASAP.

# Technical Support/RMA Sheet

Customer/Country:	Company:	Phone No.:
Contact Person:	E-mail Add. :	

Model name/Lot Number:	PCB revision:
BIOS version:	O.S./A.S.:

Hardware Configuration	Mfs.	Model name	Size:	Driver/Utility:
CPU				
Memory Brand				
Video Card				
Audio Card				
HDD				
CD-ROM / DVD-ROM				
Modem				
Network				
AMR / CNR				
Keyboard				
Mouse				
Power supply				
Other Device				

Problem Description:

---



---

# Acronyms

Acronyms	Meaning
ACPI	Advanced Configuration and Power Interface
APM	Advanced Power Management
AGP	Accelerated Graphics Port
AMR	Audio Modem Riser
ACR	Advanced Communications Riser
BIOS	Basic Input / Output System
CPU	Central Processing Unit
CMOS	Complementary Metal Oxide Semiconductor
CRIMM	Continuity RIMM
CNR	Communication and Networking Riser
DMA	Direct Memory Access
DMI	Desktop Management Interface
DIMM	Dual Inline Memory Module
DRM	Dual Retention Mechanism
DRAM	Dynamic Random Access Memory
DDR	Double Data Rate
ECP	Extended Capabilities Port
ESCD	Extended System Configuration Data
ECC	Error Checking and Correcting
EMC	Electromagnetic Compatibility
EPP	Enhanced Parallel Port
ESD	Electrostatic Discharge
FDD	Floppy Disk Device
FSB	Front Side Bus
HDD	Hard Disk Device
IDE	Integrated Dual Channel Enhanced
IRQ	Interrupt Request

to be continued.....

Acronyms	Meaning
IOAPIC	Input Output Advanced Programmable Input Controller
ISA	Industry Standard Architecture
LAN	Local Area Network
I/O	Input / Output
LBA	Logical Block Addressing
LED	Light Emitting Diode
MHz	Megahertz
MIDI	Musical Instrument Digital Interface
MTH	Memory Translator Hub
MPT	Memory Protocol Translator
NIC	Network Interface Card
OS	Operating System
OEM	Original Equipment Manufacturer
PAC	PCI A.G.P. Controller
POST	Power-On Self Test
PCI	Peripheral Component Interconnect
RIMM	Rambus in-line Memory Module
SCI	Special Circumstance Instructions
SECC	Single Edge Contact Cartridge
SRAM	Static Random Access Memory



## CONTACT US

Contact us via the information in this page all over the world.

---

- Taiwan

Gigabyte Technology Co., Ltd.

Address: No.6, Bau Chiang Road, Hsin-Tien, Taipei Hsien, Taiwan, R.O.C.

TEL: 886 (2) 8912-4888

FAX: 886 (2) 8912-4004

E-mail:

We have been constantly striving hard to provide you with faster and more efficient mail replying service.

If you have any inquiry please classify it into the following topics.

The respective department will attend to the inquiry as soon as possible. Thank you for your cooperation!

WEB Address: <http://tw.giga-byte.com>

---

- USA

G.B.T. INC.

Address: 17358 Railroad St, City of Industry, CA 91748.

Tel: 1 (626) 854-9338

Fax: 1 (626) 854-9339

E-mail: [sales@giga-byte.com](mailto:sales@giga-byte.com)

[support@giga-byte.com](mailto:support@giga-byte.com)

WEB Address: <http://us.giga-byte.com>

---

- Germany

G.B.T. Technology Trading GmbH

Tel: 49-40-2533040

49-01803-428468 (Tech.)

Fax: 49-40-25492343 (Sales)

49-01803-428329 (Tech.)

E-mail: [support@gigabyte.de](mailto:support@gigabyte.de)

WEB Address: <http://de.giga-byte.com>

---

- Japan

Nippon Giga-Byte Corporation

WEB Address: <http://www.gigabyte.co.jp>

---

- U.K

G.B.T. TECH. CO. LTD.

Tel: 44-1908-362700

Fax: 44-1908-362709

E-mail: [support@gbt-tech.co.uk](mailto:support@gbt-tech.co.uk)

WEB Address: <http://uk.giga-byte.com>

---



---

- The Netherlands

Giga-Byte Technology B.V.

Address: Verdunplein 8 5627 SZ, Eindhoven, The Netherlands

Tel: +31 40 290 2088

NL Tech.Support : 0900-GIGABYTE (0900-44422983, €±0.2/M)

BE Tech.Support : 0900-84034 (€±0.4/M)

Fax: +31 40 290 2089

E-mail: [info@giga-byte.nl](mailto:info@giga-byte.nl)

Tech. Support E-mail: [support@giga-byte.nl](mailto:support@giga-byte.nl)

WEB Address: <http://nl.giga-byte.com>

---

- China

Shanghai Office

Tel: 86-21-64737410

Fax: 86-21-64453227

WEB Address: <http://cn.giga-byte.com>

GuangZhou Office

Tel: 86-20-87586273

Fax: 86-20-87544306

WEB Address: <http://cn.giga-byte.com>

Beijing Office

Tel: 86-10-82856054

86-10-82856064

86-10-82856094

Fax: 86-10-82856575

E-mail: [bjsupport@gigabyte.com.cn](mailto:bjsupport@gigabyte.com.cn)

WEB Address: <http://cn.giga-byte.com>

Chengdu Office

Tel: 86-28-85236930

Fax: 86-28-85256822

WEB Address: <http://cn.giga-byte.com>

---