



- **The author assumes no responsibility for any errors or omissions that may appear in this document nor does the author make a commitment to update the information contained herein.**
- **Third-party brands and names are the property of their respective owners.**
- **Please do not remove any labels on motherboard, this may void the warranty of this motherboard.**
- **Due to rapid change in technology, some of the specifications might be out of date before publication of this booklet.**
- **Before you install PCI cards, please remove the Dual BIOS label from PCI slots if there is one.**



WARNING: *Never run the processor without the heatsink properly and firmly attached. PERMANENT DAMAGE WILL RESULT!*

Mise en garde : *Ne faites jamais tourner le processeur sans que le dissipateur de chaleur soit fix correctement et fermement. UN DOMMAGE PERMANENT EN RÉSULTERA !*

Achtung: *Der Prozessor darf nur in Betrieb genommen werden, wenn der Wärmeableiter ordnungsgemäß und fest angebracht ist. DIES HAT EINEN PERMANENTEN SCHADEN ZUR FOLGE!*

Advertencia: *Nunca haga funcionar el procesador sin el dissipador de calor instalado correcta y firmemente. ¡SE PRODUCIRÁ UN DAÑO PERMANENTE!*

Aviso: *Nunca execute o processador sem o dissipador de calor estar adequado e firmemente conectado. O RESULTADO SERÁ UM DANO PERMANENTE!*

警告: 將散熱板牢固地安裝到處理器上之前，不要運行處理器。過熱將永遠損壞處理器！

警告: 將散熱器牢固地安裝到處理器上之前，不要運行處理器。過熱將永遠損壞處理器！

경고: 히트싱크를 제대로 또 단단히 부착시키지 않은 채 프로세서를 구동시키지 마십시오. 영구적 고장이 발생합니다!

警告: 永久的な損傷を防ぐため、ヒートシンクを正しくしっかりと取り付けるまでは、プロセッサを動作させないようにしてください。

GA-7VTXE/GA-7VTXH
AMD Socket A Processor Motherboard

USER'S MANUAL

AMD Athlon™ / Athlon™ XP / Duron™ Socket A Processor Motherboard
Rev. 1.0 Third Edition
12ME-7VTXE-1003

Table of Content

| | |
|--|----|
| Revision History | 6 |
| Item Checklist | 6 |
| WARNING! | 7 |
| | |
| Chapter 1 Introduction | 8 |
| Summary of Features | 8 |
| GA-7VTXE/GA-7VTXH Motherboard Layout | 10 |
| | |
| Chapter 2 Hardware Installation Process | 11 |
| Step 1: Install the Central Processing Unit (CPU) | 12 |
| Step1-1: CPU Speed Setup | 12 |
| Step1-2: CPU Installation | 13 |
| Step1-3:CPU Heat Sink Installation | 14 |
| Step 2: Install memory modules | 15 |
| Step 3: Install expansion cards | 17 |
| Step 4: Connect ribbon cables, cabinet wires, and power supply | 18 |
| Step4-1:I/O Back Panel Introduction | 18 |
| Step4-2: Connectors Introduction | 20 |
| | |
| Chapter 3 BIOS Setup | 24 |
| The Main Menu (For example: BIOS Ver. :F1) | 25 |
| Standard CMOS Features | 27 |
| BIOS Features Setup | 30 |
| Chipset Features Setup | 32 |
| Power Management Setup | 36 |

| | |
|--|----|
| PNP/PCI Configuration | 39 |
| Load Fail-Safe Defaults | 41 |
| Load Optimized Defaults | 42 |
| Integrated Peripherals | 43 |
| Hardware Monitor & MISC Setup | 46 |
| Set Supervisor / User Password | 47 |
| IDE HDD Auto Detection | 48 |
| Save & Exit Setup | 49 |
| Exit Without Saving | 50 |
| | |
| Chapter 4 Technical Reference | 51 |
| Block Diagram | 51 |
| Dual BIOS Introduction | 52 |
| Four Speaker & SPDIF Introduction(For GA-7VTXH Only) | 60 |
| @ BIOS Introduction | 64 |
| Easy TuneIII™ Introduction | 65 |
| | |
| Chapter 5 Appendix | 66 |

Revision History

| Revision | Revision Note | Date |
|----------|---|-----------|
| 1.0 | Initial release of the GA-7VTXE/GA-7VTXH motherboard user's manual. | Sep.2001 |
| 1.0 | Second release of the GA-7VTXE/GA-7VTXH motherboard user's manual. | Oct .2001 |
| 1.0 | Third release of the GA-7VTXE/GA-7VTXH motherboard user's manual. | Nov.2001 |

Item Checklist

- The GA-7VTXE/GA-7VTXH motherboard
- IDE cable x 1/ Floppy cable x 1
- CD for motherboard driver & utility (VUCD)
- GA-7VTXE/GA-7VTXH user's manual
- USB Cable (only for GA-7VTXH)

WARNING!

Computer motherboards and expansion cards contain very delicate Integrated Circuit (IC) chips. To protect them against damage from static electricity, you should follow some precautions whenever you work on your computer.

1. Unplug your computer when working on the inside.
2. Use a grounded wrist strap before handling computer components. If you do not have one, touch both of your hands to a safely grounded object or to a metal object, such as the power supply case.
3. Hold components by the edges and try not touch the IC chips, leads or connectors, or other components.
4. Place components on a grounded antistatic pad or on the bag that came with the components whenever the components are separated from the system.
5. Ensure that the ATX power supply is switched off before you plug in or remove the ATX power connector on the motherboard.

Installing the motherboard to the chassis...

If the motherboard has mounting holes, but they don't line up with the holes on the base and there are no slots to attach the spacers, do not become alarmed you can still attach the spacers to the mounting holes. Just cut the bottom portion of the spacers (the spacer may be a little hard to cut off, so be careful of your hands). In this way you can still attach the motherboard to the base without worrying about short circuits. Sometimes you may need to use the plastic springs to isolate the screw from the motherboard PCB surface, because the circuit wire may be near by the hole. Be careful, don't let the screw contact any printed circuit write or parts on the PCB that are near the fixing hole, otherwise it may damage the board or cause board malfunctioning.

Chapter 1 Introduction

Summary of Features

| | |
|----------------------|---|
| Form Factor | <ul style="list-style-type: none"> • 30.4cm x 20.5cm ATX size form factor, 4 layers PCB. |
| Motherboard | <ul style="list-style-type: none"> • GA-7VTXE/GA-7VTXH Motherboard |
| CPU | <ul style="list-style-type: none"> • Socket A processor AMD Athlon™/Athlon™ XP/ Duron™ (K7) 128K L1 & 256K/64K L2 cache on die 200/266MHz FSB and DDR bus speeds (PCI 33MHz) • Supports 1.4GHz and faster |
| Chipset | <ul style="list-style-type: none"> • VIA KT266A Memory/AGP/PCI Controller (PAC) • VIA VT8233 Integrated Peripheral Controller (PSIPC) |
| Memory | <ul style="list-style-type: none"> • 3 184-pin DDR sockets • Supports DDR DRAM PC1600/PC2100 • Supports up to 3.0GB DDR (Max) • Supports only 2.5V DDR DIMM |
| I/O Control | <ul style="list-style-type: none"> • IT8705 |
| Slots | <ul style="list-style-type: none"> • 1 AGP slot supports 4X/2X mode & AGP 2.0 Compliant • 5 PCI slots supports 33MHz & PCI 2.2 compliant |
| On-Board IDE | <ul style="list-style-type: none"> • 2 IDE bus master (ATA66/ATA100) IDE ports for up to 4 ATAPI devices • Supports PIO mode3,4 (/ATA66/ATA100) IDE & ATAPI CD-ROM |
| On-Board Peripherals | <ul style="list-style-type: none"> • 1 Floppy port supports 2 FDD with 360K, 720K, 1.2M, 1.44M and 2.88M bytes. • 1 Parallel port supports Normal/EPP/ECP mode • 1 Serial port (COMA & COMB) • 4 USB ports (Rear USB x 2, Front USB x 2) • 1 IrDA connector for IR |
| Hardware Monitor | <ul style="list-style-type: none"> • CPU/System Fan Revolution detect • CPU/System temperature detect • System Voltage Detect |

to be continued.....

| | |
|---------------------|--|
| On-Board Sound | <ul style="list-style-type: none">• Creative CT5880 Sound Chip*• AC97 CODEC• Line In/Line Out/Mic In/CD In/Game Port |
| On-Board LAN | <ul style="list-style-type: none">• Build in RTL8100L Chipset* |
| PS/2 Connector | <ul style="list-style-type: none">• PS/2 Keyboard interface and PS/2 Mouse interace |
| BIOS | <ul style="list-style-type: none">• Licensed AMI BIOS, 2M bit Flash ROM• Support Dual BIOS |
| Additional Features | <ul style="list-style-type: none">• STR(Suspend-To-RAM)• Wake on LAN**• AC Recovery• USB KB/Mouse wake up from S3• Supports @BIOS™• Supports Easy Tunell™ |

- Please set the CPU host frequency in accordance with your processor's specifications. We don't recommend you to set the system bus frequency over the CPU's specification because these specific bus frequencies are not the standard specifications for CPU, chipset and most of the peripherals. Whether your system can run under these specific bus frequencies properly will depend on your hardware configurations, including CPU, Chipsets, SDRAM, Cards....etc.

*** Only for GA-7VTXH.

**** Only for GA-7VTXE.

GA-7VTXE/GA-7VTXH Motherboard Layout

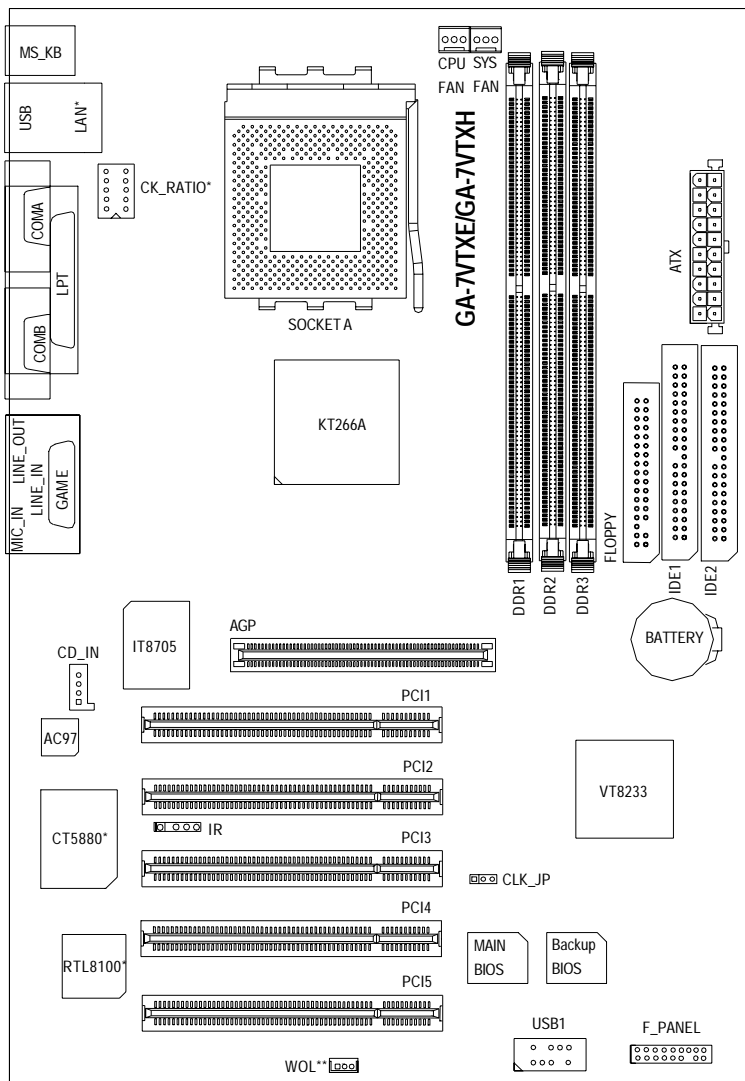

*** Only for GA-7VTXH.

**** Only for GA-7VTXE.

Chapter 2 Hardware Installation Process

To set up your computer, you must complete the following setups:

- Step 1- Set Dip Switch (CK_RATIO)* and system Jumper(CLK_JP)
- Step 2- Install the Central Processing Unit (CPU)
- Step 3- Install memory modules
- Step 4- Install expansion cards
- Step 5- Connect ribbon cables, cabinet wires, and power supply
- Step 6- Setup BIOS software
- Step 7- Install supporting software tools

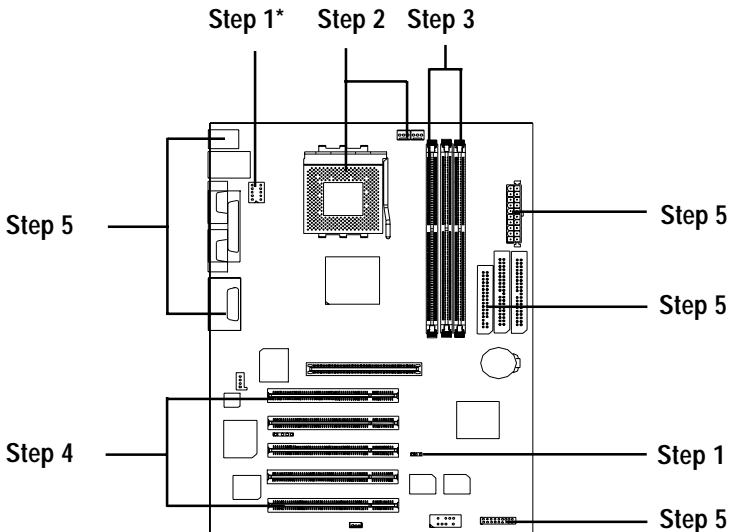

*** Only for GA-7VTXH.

Step 1: Install the Central Processing Unit (CPU)

Step1-1: CPU Speed Setup

The clock ratio can be switched by CK_RATIO and refer to below table.

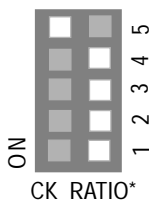
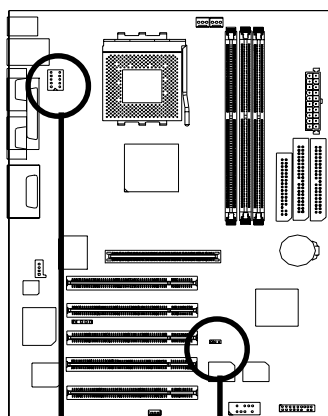

| CLK_JP | CPU | AGP | PCI | |
|--------|-----|-----|-----|-----------|
| 1 | 100 | 66 | 33 | 2-3 close |
| 1 | 133 | 66 | 33 | 1-2 close |

O: ON / X :OFF

| RATIO | 1 | 2 | 3 | 4 | 5 |
|---------------|---|---|---|---|---|
| AUTO(Default) | X | X | X | X | O |
| 5x | O | O | X | O | X |
| 5.5x | X | O | X | O | X |
| 6x | O | X | X | O | X |
| 6.5x | X | X | X | O | X |
| 7x | O | O | O | X | X |
| 7.5x | X | O | O | X | X |
| 8x | O | X | O | X | X |
| 8.5x | X | X | O | X | X |
| 9x | O | O | X | X | X |
| 9.5x | X | O | X | X | X |
| 10x | O | X | X | X | X |
| 10.5x | X | X | X | X | X |
| 11x | O | O | O | O | X |
| 11.5x | X | O | O | O | X |
| 12x | O | X | O | O | X |
| >=12.5x | X | X | O | O | X |

The system bus frequency can be switched at 100/133MHz by adjusting system jumper (CLK_JP). (The internal frequency depend on CPU.)

*** CK_RATIO only for GA-7VTXH.

Step1-2: CPU Installation



CPU Top View

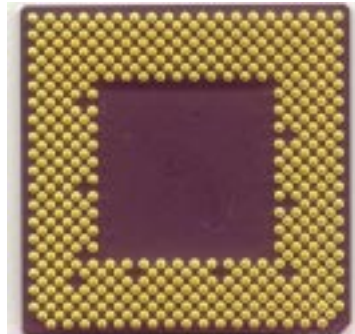

CPU Bottom View

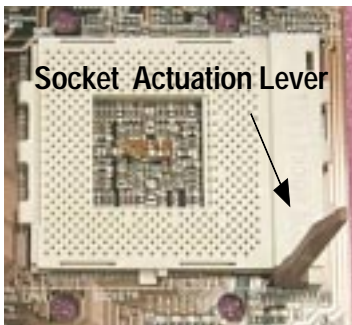

1. Pull up the CPU socket level and up to 90-degree angle.

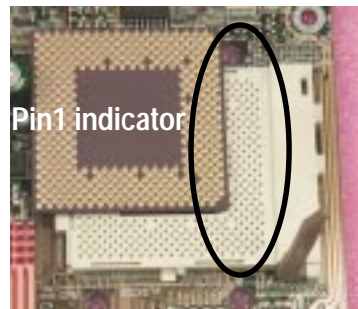

2. Locate Pin 1 in the socket and look for a (golden) cut edge on the CPU upper corner. Then insert the CPU into the socket.

- ⚡ Please make sure the CPU type is supported by the motherboard.
- ⚡ If you do not match the CPU socket Pin 1 and CPU cut edge well, it will cause improper installation. Please change the insert orientation.

Step1-3:CPU Heat Sink Installation



1. Press down the CPU socket lever and finish CPU installation.



2. Use qualified fan approved by AMD.

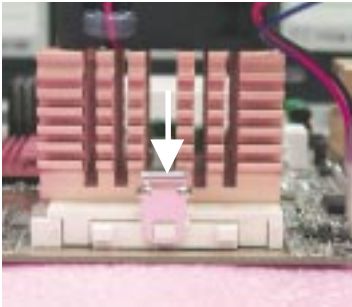

3. Fasten the heatsink supporting-base onto the CPU socket on the main-board.

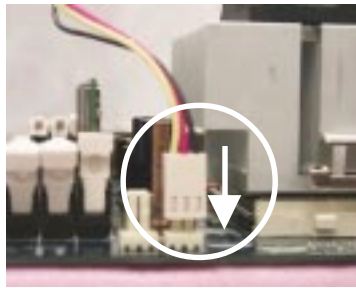

4. Make sure the CPU fan is plugged to the CPU fan connector, than install complete.

- Please use AMD approved cooling fan.
- We recommend you to apply the thermal paste to provide better heat conduction between your CPU and heatsink.
- Make sure the CPU fan power cable is plugged in to the CPU fan connector, this completes the installation.
- Please refer to CPU heat sink user's manual for more detail installation procedure.

Step 2: Install memory modules

The motherboard has 3 dual inline memory module (DIMM) sockets. The BIOS will automatically detect memory type and size. To install the memory module, just push it vertically into the DIMM Slot.

The DIMM module can only fit in one direction due to the notch. Memory size can vary between sockets.

Total Memory Sizes With Registered DDR DIMM

| Devices used on DIMM | 1 DIMMx64/x72 | 2 DIMMsx64/x72 | 3 DIMMsx64/x72 |
|-------------------------|---------------|----------------|----------------|
| 64 Mbit (4Mx4x4 banks) | 256 MBytes | 512 MBytes | 768 MBytes |
| 64 Mbit (2Mx8x4 banks) | 128 MBytes | 256 MBytes | 384 MBytes |
| 64 Mbit (1Mx16x4 banks) | 64 MBytes | 128 MBytes | 192 MBytes |
| 128 Mbit(8Mx4x4 banks) | 512 MBytes | 1 GBytes | 1.5 GBytes |
| 128 Mbit(4Mx8x4 banks) | 256 MBytes | 512 MBytes | 768 MBytes |
| 128 Mbit(2Mx16x4 banks) | 128 MBytes | 256 MBytes | 384 MBytes |
| 256 Mbit(16Mx4x4 banks) | 1 GBytes | 2 GBytes | 3 GBytes |
| 256 Mbit(8Mx8x4 banks) | 512 MBytes | 1 GBytes | 1.5 GBytes |
| 256 Mbit(4Mx16x4 banks) | 256 MBytes | 512 MBytes | 768 MBytes |
| 512 Mbit(16Mx8x4 banks) | 1 GBytes | 2 GBytes | 3 GBytes |
| 512 Mbit(8Mx16x4 banks) | 512 MBytes | 1 GBytes | 1.5 GBytes |

Total Memory Sizes With Unbuffered DDR DIMM

| Devices used on DIMM | 1 DIMMx64/x72 | 2 DIMMsx64/x72 | 3 DIMMsx64/x72 |
|-------------------------|---------------|----------------|----------------|
| 64 Mbit (2Mx8x4 banks) | 128 MBytes | 256 MBytes | 384 MBytes |
| 64 Mbit (1Mx16x4 banks) | 64 MBytes | 128 MBytes | 192 MBytes |
| 128 Mbit(4Mx8x4 banks) | 256 MBytes | 512 MBytes | 768 MBytes |
| 128 Mbit(2Mx16x4 banks) | 128 MBytes | 256 MBytes | 384 MBytes |
| 256 Mbit(8Mx8x4 banks) | 512 MBytes | 1 GBytes | 1.5 GBytes |
| 256 Mbit(4Mx16x4 banks) | 256 MBytes | 512 MBytes | 768 MBytes |
| 512 Mbit(16Mx8x4 banks) | 1 GBytes | 2 GBytes | 3 GBytes |
| 512 Mbit(8Mx16x4 banks) | 512 MBytes | 1 GBytes | 1.5 GBytes |



DDR

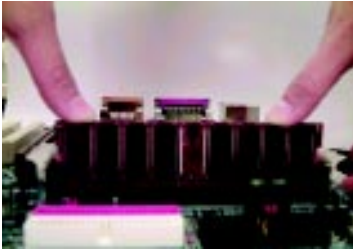

1. The DIMM slot has a notch, so the DIMM memory module can only fit in one direction.
 2. Insert the DIMM memory module vertically into the DIMM slot. Then push it down.
 3. Close the plastic clip at both edges of the DIMM slots to lock the DIMM module.
- **When STR/DIMM LED is ON, do not install/remove DDR from socket.**

DDR Introduction

Established on the existing SDRAM industry infrastructure, DDR (Double Data Rate) memory is a high performance and cost-effective solution that allows easy adoption for memory vendors, OEMs and system integrators.

DDR memory is a sensible evolutionary solution for the PC industry that builds on the existing SDRAM infrastructure, yet makes awesome advances in solving the system performance bottleneck by doubling the memory bandwidth. DDR SDRAM will offer a superior solution and migration path from existing SDRAM designs due to its availability, pricing and overall market support. PC2100 DDR memory (DDR266) doubles the data rate through reading and writing at both the rising and falling edge of the clock, achieving data bandwidth 2X greater than PC133 when running with the same DRAM clock frequency. With peak bandwidth of 2.1GB per second, DDR memory enables system OEMs to build high performance and low latency DRAM subsystems that are suitable for servers, workstations, high-end PC's and value desktop SMA systems. With a core voltage of only 2.5 Volts compared to conventional SDRAM's 3.3 volts, DDR memory is a compelling solution for small form factor desktops and notebook applications.

● **When STR/DIMM LED is ON, do not install/remove DDR from socket.**

Step 3: Install expansion cards

1. Read the related expansion card's instruction document before install the expansion card into the computer.
2. Remove your computer's chassis cover, necessary screws and slot bracket from the computer.
3. Press the expansion card firmly into expansion slot in motherboard.
4. Be sure the metal contacts on the card are indeed seated in the slot.
5. Replace the screw to secure the slot bracket of the expansion card.
6. Replace your computer's chassis cover.
7. Power on the computer, if necessary, setup BIOS utility of expansion card from BIOS.
8. Install related driver from the operating system.



Step 4: Connect ribbon cables, cabinet wires, and power supply

Step4-1:I/O Back Panel Introduction

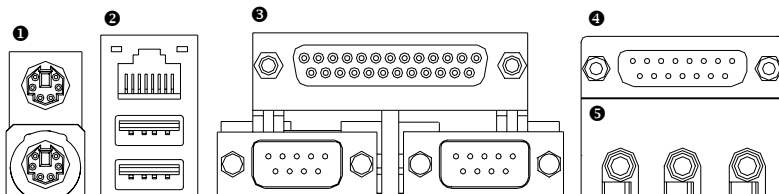

❶ PS/2 Keyboard and PS/2 Mouse Connector

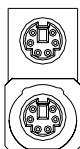

PS/2 Mouse Connector
(6 pin Female)

PS/2 Keyboard Connector
(6 pin Female)

➤ This connector supports standard PS/2 keyboard and PS/2 mouse.

❷ USB & LAN Connector

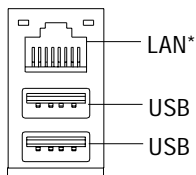

➤ Before you connect your device(s) into USB connector(s), please make sure your device(s) such as USB keyboard, mouse, scanner, zip, speaker..etc. Have a standard USB interface. Also make sure your OS (Win 95 with USB supplement, Win98, Windows 2000, Windows ME, Win NT with SP 6) supports USB controller. If your OS does not support USB controller, please contact OS vendor for possible patch or driver upgrade. For more information please contact your OS or device(s) vendors.

*** Only for GA-7VTXH.

3 Parallel Port , Serial Ports (COMA / COMB)

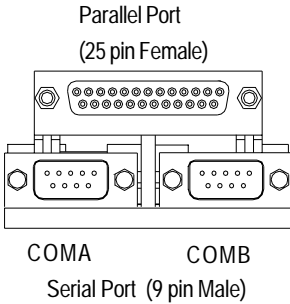

- This connector supports 2 standard COM ports ,1 Parallel port . Device like printer can be connected to Parallel port ; mouse and modem etc can be connected to Serial ports.

4 Game /MIDI Ports

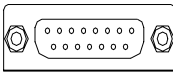

Joystick/ MIDI (15 pin Female)

- This connector supports joystick, MIDI keyboard and other relate audio devices.

5 Audio Connectors

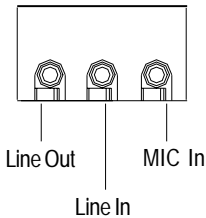

- After install onboard audio driver, you may connect speaker to Line Out jack, micro phone to MIC In jack. Device like CD-ROM , walkman etc can be connected to Line-In jack.

Step4-2: Connectors Introduction

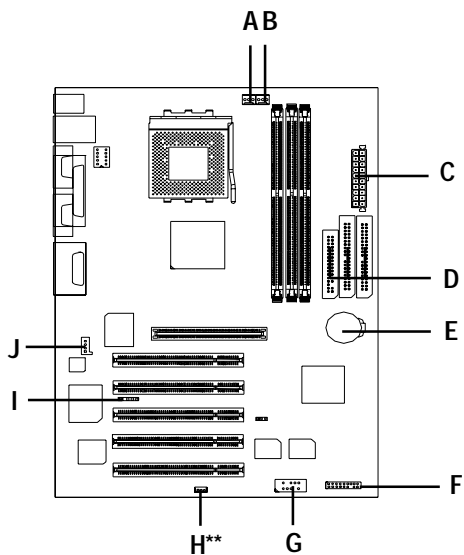

| | |
|---------------------|------------|
| A) CPU FAN | F) F_Panel |
| B) SYS FAN | G) USB1 |
| C) ATX | H) WOL** |
| D) Floppy/IDE1/IDE2 | I) IR |
| E) Battery | J) CD_IN |

**** Only for GA-7VTXE.

A) CPU_FAN (CPU_FAN Connector)



B) SYS_FAN (SYS_FAN Connector)



- The CPU fan connector supports Max. current up to 600 mA .

C) ATX (ATX Power)

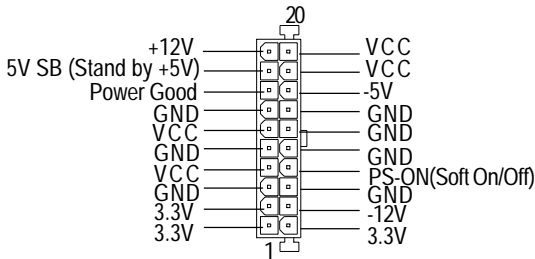

- AC power cord should only be connected to your power supply unit after ATX power cable and other related devices are firmly connected to the mainboard.

D) Floppy / IDE1 / IDE2

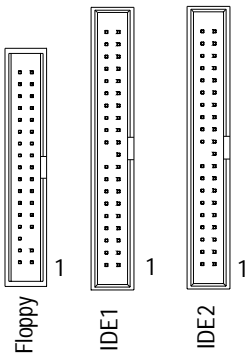

E) Battery

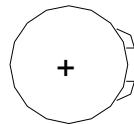

CAUTION

- ❖ Danger of explosion if battery is incorrectly replaced.
- ❖ Replace only with the same or equivalent type recommended by the manufacturer.
- ❖ Dispose of used batteries according to the manufacturer's instructions.

G) USB1

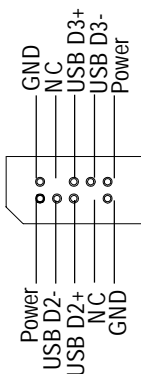

- Be careful with the polarity of the front panel USB connector. Check the pin assignment while you connect the front panel USB cable. Please contact your nearest dealer for optional front panel USB cable.

I) IR

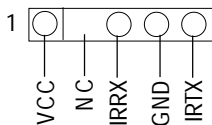

- Be careful with the polarity of the IR connector while you connect the IR. Please contact your nearest dealer for optional IR device.

H) WOL (Wake On LAN)**

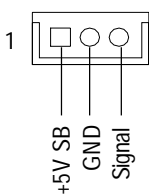

J) CD_IN

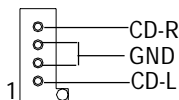

**** Only for GA-7VTXE.

F) F_PANEL (2x7 pins jumper)

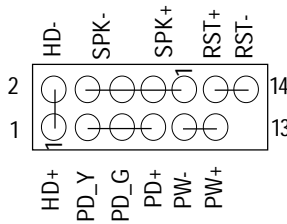

| | |
|-------------------------------|---|
| HD (IDE Hard Disk Active LED) | Pin 1: LED anode(+) Pin 2: LED cathode(-) |
| SPK (Speaker Connector) | Pin 1: VCC(+) Pin 2- Pin 3: NC Pin 4: Data(-) |
| RST (Reset Switch) | Open: Normal Operation Close: Reset Hardware System |
| PD+/PD_G/PD_Y(Power LED) | Pin 1: LED anode(+) Pin 2: LED cathode(-) Pin 3: LED cathode(-) |
| PW (Soft Power Connector) | Open: Normal Operation Close: Power On/Off |

- Please connect the power LED, PC speaker, reset switch and power switch etc of your chassis front panel to the front panel jumper according to the pin assignment above.

Chapter 3 BIOS Setup

BIOS Setup is an overview of the BIOS Setup Program. The program that allows users to modify the basic system configuration. This type of information is stored in battery-backed CMOS RAM so that it retains the Setup information when the power is turned off.

ENTERING SETUP

Power ON the computer and press immediately will allow you to enter Setup. If the message disappears before you respond and you still wish to enter Setup, restart the system to try again by turning it OFF then ON or pressing the "RESET" bottom on the system case. You may also restart by simultaneously press <Ctrl> - <Alt>- keys.

CONTROL KEYS

| | |
|----------|---|
| <↑> | Move to previous item |
| <↓> | Move to next item |
| <←> | Move to the item in the left hand |
| <→> | Move to the item in the right hand |
| <Esc> | Main Menu - Quit and not save changes into CMOS Status Page Setup Menu and Option Page Setup Menu - Exit current page and return to Main Menu |
| <+/PgUp> | Increase the numeric value or make changes |
| <-/PgDn> | Decrease the numeric value or make changes |
| <F1> | General help, only for Status Page Setup Menu and Option Page Setup Menu |
| <F2> | Reserved |
| <F3> | Reserved |
| <F4> | Reserved |
| <F5> | Restore the previous CMOS value from CMOS, only for Option Page Setup Menu |
| <F6> | Load the default CMOS value from BIOS default table, only for Option Page Setup Menu |
| <F7> | Load the Setup Defaults |
| <F8> | Reserved |
| <F9> | Reserved |
| <F10> | Save all the CMOS changes, only for Main Menu |

GETTINGHELP

Main Menu

The on-line description of the highlighted setup function is displayed at the bottom of the screen.

Status Page Setup Menu / Option Page Setup Menu

Press F1 to pop up a small help window that describes the appropriate keys to use and the possible selections for the highlighted item. To exit the Help Window press <Esc>.

The Main Menu (For example: BIOS Ver. :F3)

Once you enter AMI BIOS CMOS Setup Utility, the Main Menu (Figure 1) will appear on the screen. The Main Menu allows you to select from eight setup functions and two exit choices. Use arrow keys to select among the items and press <Enter> to accept or enter the sub-menu.

| | |
|---|-------------------------------|
| AMIBIOS SIMPLE SETUP UTILITY - VERSION 1.24e (C) 1999 American Megatrends, Inc. All Rights Reserved | |
| STANDARD CMOS SETUP | INTEGRATED PERIPHERALS |
| BIOS FEATURES SETUP | HARDWARE MONITOR & MISC SETUP |
| CHIPSET FEATURES SETUP | SUPERVISOR PASSWORD |
| POWER MANAGEMENT SETUP | USER PASSWORD |
| PNP / PCI CONFIGURATION | IDE HDD AUTO DETECTION |
| LOAD FAIL-SAFE DEFAULTS | SAVE & EXIT SETUP |
| LOAD OPTIMIZED DEFAULTS | EXIT WITHOUT SAVING |
| ESC: Quit ↑↓→← : Select Item (Shift)F2 : Change Color F5: Old Values | |
| F6: Load Fail-Safe Defaults F7: Load Optimized Defaults F8:Flash Utility F10:Save & Exit | |
| Time, Date , Hard Disk Type... | |

Figure 1: Main Menu

- **Standard CMOS Features**
This setup page includes all the items in standard compatible BIOS.
- **BIOS Features Setup**
This setup page includes all the adjustable items of AMI special enhanced features.
- **Chipset Features Setup**
This setup page includes all the adjustable items of chipset special features.

- **Power Management Setup**

This setup page includes all the adjustable items of Green function features.

- **PNP/PCI Configurations**

This setup page includes all the adjustable configurations of PCI & PnP ISA resources.

- **Load Fail-Safe Defaults**

Load Fail-Safe Defaults option loads preset system parameter values to set the system in its most stable configurations.

- **Load Optimized Defaults**

Load Optimized Defaults option loads preset system parameter values to set the system in its highest performance configurations.

- **Integrated Peripherals**

This setup page includes all onboard peripherals.

- **Hardware Monitor & MISC Setup**

This setup page is auto detect fan and temperature status.

- **Set Supervisor password**

Set Change or disable password. It allows you to limit access to the system and/or BIOS setup.

- **Set User password**

Set Change or disable password. It allows you to limit access to the system.

- **IDE HDD Auto Detection**

Automatically configure hard disk parameters.

- **Save & Exit Setup**

Save CMOS value settings to CMOS and exit setup.

- **Exit Without Saving**

Abandon all CMOS value changes and exit setup.

Standard CMOS Features

| AMIBIOS SETUP - STANDARD CMOS SETUP | | | | | | | | | | | | | | | | | | | | | | | | | | | | | | | | | | | | | | | | | |
|--|--------------------------|------|------|---------|-------|---------|-------|--------|------|------------|--------|--|--|--|--|--|--|-----------|--------|--|--|--|--|--|--|------------|--------|--|--|--|--|--|--|-----------|--------|--|--|--|--|--|--|
| (C) 1999 American Megatrends, Inc. All Rights Reserved | | | | | | | | | | | | | | | | | | | | | | | | | | | | | | | | | | | | | | | | | |
| Date (mm/dd/yyyy) : Fri Mar 16, 2001 | | | | | | | | | | | | | | | | | | | | | | | | | | | | | | | | | | | | | | | | | |
| Time (hh/mm/ss) : 14:44:35 | | | | | | | | | | | | | | | | | | | | | | | | | | | | | | | | | | | | | | | | | |
| <table border="1"> <thead> <tr> <th>TYPE</th> <th>SIZE</th> <th>CYLS</th> <th>HEAD</th> <th>PRECOMP</th> <th>LANDZ</th> <th>SECTOR</th> <th>MODE</th> </tr> </thead> <tbody> <tr> <td>Pri Master</td> <td>: Auto</td> <td></td> <td></td> <td></td> <td></td> <td></td> <td></td> </tr> <tr> <td>Pri Slave</td> <td>: Auto</td> <td></td> <td></td> <td></td> <td></td> <td></td> <td></td> </tr> <tr> <td>Sec Master</td> <td>: Auto</td> <td></td> <td></td> <td></td> <td></td> <td></td> <td></td> </tr> <tr> <td>Sec Slave</td> <td>: Auto</td> <td></td> <td></td> <td></td> <td></td> <td></td> <td></td> </tr> </tbody> </table> | | TYPE | SIZE | CYLS | HEAD | PRECOMP | LANDZ | SECTOR | MODE | Pri Master | : Auto | | | | | | | Pri Slave | : Auto | | | | | | | Sec Master | : Auto | | | | | | | Sec Slave | : Auto | | | | | | |
| TYPE | SIZE | CYLS | HEAD | PRECOMP | LANDZ | SECTOR | MODE | | | | | | | | | | | | | | | | | | | | | | | | | | | | | | | | | | |
| Pri Master | : Auto | | | | | | | | | | | | | | | | | | | | | | | | | | | | | | | | | | | | | | | | |
| Pri Slave | : Auto | | | | | | | | | | | | | | | | | | | | | | | | | | | | | | | | | | | | | | | | |
| Sec Master | : Auto | | | | | | | | | | | | | | | | | | | | | | | | | | | | | | | | | | | | | | | | |
| Sec Slave | : Auto | | | | | | | | | | | | | | | | | | | | | | | | | | | | | | | | | | | | | | | | |
| Floppy Drive A : 1.44 MB 3 ^{1/2} | Base Memory : 640 Kb | | | | | | | | | | | | | | | | | | | | | | | | | | | | | | | | | | | | | | | | |
| Floppy Drive B : Not Installed | Other Memory : 384 Kb | | | | | | | | | | | | | | | | | | | | | | | | | | | | | | | | | | | | | | | | |
| | Extended Memory : 127 Mb | | | | | | | | | | | | | | | | | | | | | | | | | | | | | | | | | | | | | | | | |
| Boot Sector Virus Protection : Disabled | Total Memory : 128 Mb | | | | | | | | | | | | | | | | | | | | | | | | | | | | | | | | | | | | | | | | |
| Month : Jan - Dec | ESC : Exit | | | | | | | | | | | | | | | | | | | | | | | | | | | | | | | | | | | | | | | | |
| Day : 01- 31 | ↑↓ : Select Item | | | | | | | | | | | | | | | | | | | | | | | | | | | | | | | | | | | | | | | | |
| Year : 1990 - 2099 | PU / PD / + / - :Modify | | | | | | | | | | | | | | | | | | | | | | | | | | | | | | | | | | | | | | | | |
| | (Shift) F2 : Color | | | | | | | | | | | | | | | | | | | | | | | | | | | | | | | | | | | | | | | | |

Figure 2: Standard CMOS Setup

Date

The date format is <week>, <month>, <day>, <year>.

- ▶▶ Week The week, from Sun to Sat, determined by the BIOS and is display only
- ▶▶ Month The month, Jan. Through Dec.
- ▶▶ Day The day, from 1 to 31 (or the maximum allowed in the month)
- ▶▶ Year The year, from 1990 through 2099

Time

The times format in <hour> <minute> <second>. The time is calculated base on the 24-hour military-time clock. For example, 1 p.m. is 13:00:00.

Primary Master, Slave / Secondary Master, Slave

The category identifies the types of hard disk from drive C to F that has been installed in the computer. There are two types: auto type, and manual type. Manual type is user-definable; Auto type which will automatically detect HDD type.

Note that the specifications of your drive must match with the drive table. The hard disk will not work properly if you enter improper information for this category.

If you select User Type, related information will be asked to enter to the following items. Enter the information directly from the keyboard and press <Enter>. Such information should be provided in the documentation form your hard disk vendor or the system manufacturer.

- ▶▶ CYLS. Number of cylinders
- ▶▶ HEADS number of heads
- ▶▶ PRECOMP write precomp
- ▶▶ LANDZONE Landing zone
- ▶▶ SECTORS number of sectors

If a hard disk has not been installed select NONE and press <Enter>.

Floppy Drive A / Drive B

The category identifies the types of floppy disk drive A or drive B that has been installed in the computer.

- ▶▶ None No floppy drive installed
- ▶▶ 360K, 5.25 in. 5.25 inch PC-type standard drive; 360K byte capacity.
- ▶▶ 1.2M, 5.25 in. 5.25 inch AT-type high-density drive; 1.2M byte capacity
(3.5 inch when 3 Mode is Enabled).
- ▶▶ 720K, 3.5 in. 3.5 inch double-sided drive; 720K byte capacity
- ▶▶ 1.44M, 3.5 in. 3.5 inch double-sided drive; 1.44M byte capacity.
- ▶▶ 2.88M, 3.5 in. 3.5 inch double-sided drive; 2.88M byte capacity.

Boot Sector Virus Protection

If it is set to enable, the category will flash on the screen when there is any attempt to write to the boot sector or partition table of the hard disk drive. The system will halt and the following error message will appear in the mean time. You can run anti-virus program to locate the problem.

- ▶▶ Enabled Activate automatically when the system boots up causing a warning message to appear when anything attempts to access the boot sector or hard disk partition table

- ▶▶ Disabled No warning message to appear when anything attempts to access the boot sector or hard disk partition table (Default Value)

Memory

The category is display-only which is determined by POST (Power On Self Test) of the BIOS.

Base Memory

The POST of the BIOS will determine the amount of base (or conventional) memory installed in the system.

The value of the base memory is typically 512 K for systems with 512 K memory installed on the motherboard, or 640 K for systems with 640 K or more memory installed on the motherboard.

Other Memory

This refers to the memory located in the 640 K to 1024 K address space. This is memory that can be used for different applications.

DOS uses this area to load device drivers to keep as much base memory free for application programs. Most use for this area is Shadow RAM.

ExtendedMemory

The BIOS determines how much extended memory is present during the POST.

This is the amount of memory located above 1 MB in the CPU's memory address map.

BIOS Features Setup

| AMIBIOS SETUP - BIOS FEATURES SETUP | |
|---|------------|
| (C) 1999 American Megatrends, Inc. All Rights Reserved | |
| 1st Boot Device | : Floppy |
| 2nd Boot Device | : IDE-0 |
| 3rd Boot Device | : CDROM |
| S.M.A.R.T. for Hard Disks | : Disabled |
| BootUp Num-Lock | : On |
| Floppy Drive Seek | : Disabled |
| Password Check | : Setup |
| BIOS Flash Protection | : Auto |
| ESC: Quit ↑↓→←: Select Item F1 : Help PU/PD+/-/ : Modify F5 : Old Values (Shift)F2: Color F6 : Load Fail-Safe Defaults F8:Flash Utility F7 : Load Optimized Defaults | |

Figure 3: BIOS Features Setup

☞ 1st / 2nd / 3rd Boot device

- ▶▶ Floppy Select your boot device priority by Floppy.
- ▶▶ ZIP A:/LS120 Select your boot device priority by ZIP A:/LS120.
- ▶▶ ATAPI ZIP C: Select your boot device priority by ATAPI ZIP C:.
- ▶▶ CDROM Select your boot device priority by CDROM.
- ▶▶ SCSI Select your boot device priority by SCSI.
- ▶▶ NETWORK Select your boot device priority by NETWORK.
- ▶▶ Disabled Disable this function.
- ▶▶ IDE-0-3 Select your boot device priority by IDE-0-3.
- ▶▶ USB FDD Select your boot device priority by USB FDD.

☞ S.M.A.R.T. for Hard Disks

- ▶▶ Enabled Enable HDD S.M.A.R.T. Capability.
- ▶▶ Disabled Disable HDD S.M.A.R.T. Capability. (Default value)

☞ Boot Up Num-Lock

- ▶▶ On Keypad is number keys. (Default value)
- ▶▶ Off Keypad is arrow keys.

☞ Floppy Drive Seek

During POST, BIOS will determine the floppy disk drive installed is 40 or 80 tracks. 360 K type is 40 tracks 720 K, 1.2 M and 1.44 M are all 80 tracks.

- ▶▶ Enabled BIOS searches for floppy disk drive to determine it is 40 or 80 tracks. Note that BIOS can not tell from 720 K, 1.2 M or 1.44 M drive type as they are all 80tracks.
- ▶▶ Disabled BIOS will not search for the type of floppy disk drive by track number. Note that there will not be any warning message if the drive installed is 360 K. (Default value)

☞ Password Check

Please refer to the detail on P.47

- ▶▶ Always The user must enter correct password in order to access the system and/or BIOS Setup.
- ▶▶ Setup The user must enter correct password in order to access BIOS setup utility. (Default Value)

☞ BIOS Flash Protection

This field lets you determine the states that flash BIOS.

- ▶▶ Auto BIOS enables flash write access automatically when updating BIOS data/ DMI/ESCD. (Default Value)
- ▶▶ Enabled During POST, DMI/ESCD would not be updated. But flash tools can update BIOS always.

Chipset Features Setup

| AMBIOS SETUP - CHIPSET FEATURES SETUP | |
|--|---------------|
| (C) 1999 American Megatrends, Inc. All Rights Reserved | |
| Top Performance | :Disabled |
| Configure SDRAM by SPD | :Enabled |
| DRAM Frequency | :100 |
| SDRAM CAS# Latency | :2 |
| SDRAM Command Rate | :2T Command |
| AGP Mode | :4X |
| AGP Comp. Driving | :Auto |
| Manual AGP Comp. Driving | :DA |
| AGP Fast Write | :Disable |
| AGP Aperture Size | :64MB |
| AGP Read Synchronization | :Disabled |
| PCI Delay Transaction | :Enabled |
| USB Controller | :All USB Port |
| USB Legacy Support | :Disabled |
| USB Port 64/60 Emulation | :Disabled |
| VCore Voltage | :Normal |
| ESC: Quit ↑↓→←: Select Item F1 : Help PU/PD+/-/: Modify F5 : Old Values (Shift)F2: Color F6 : Load Fail-Safe Defaults F8:Flash Utility F7 : Load Optimized Defaults | |

Figure 4: Chipset Features Setup

☞ Top Performance

- ▶▶ Disabled Top Performance Disabled. (Default Value)
- ▶▶ Enabled Top Performance Enabled.

☞ Configure SDRAM by SPD

- ▶▶ Disabled Disabled Configure SDRAM Timing by SPD.
- ▶▶ Enabled Enabled Configure SDRAM Timing by SPD. (Default Value)

☞ DRAM Frequency

- ▶▶ 100MHz Set DRAM Frequency is 100MHz. (Default Value).
- ▶▶ 133MHz Set DRAM Frequency is 133MHz.
- ▶▶ Auto Set DRAM Frequency is Auto.

☞ SDRAM CAS# Latency

- ▶▶ 2 For Fastest SDRAM DIMM module. (Default Value).
- ▶▶ 2.5 For Slower SDRAM DIMM module.

☞ SDRAM Command Rate

- ▶▶ 2T Command Set SDRAM Command Rate to 2T Command. (Default Value)
- ▶▶ 1T Command Set SDRAM Command Rate to 1T Command.

☞ AGP Mode

- ▶▶ 4X Set AGP Mode is 4X. (Default Value)
- ▶▶ 1X Set AGP Mode is 1X.
- ▶▶ 2X Set AGP Mode is 2X.

☞ AGP Comp. Driving

- ▶▶ Auto Set AGP Comp. Driving is Auto. (Default Value)
- ▶▶ Manual Set AGP Comp. Driving is Manual.

If AGP Comp. Driving is Manual.

Manual AGP Comp. Driving : 00-FF

☞ AGP Fast Write

- ▶▶ Disabled Disabled AGP Fast Write (Default Value)
- ▶▶ Enabled Enabled AGP Fast Write

☞ AGP Aperture Size

- ▶▶ 4MB Set AGP Aperture Size to 4MB.
- ▶▶ 8MB Set AGP Aperture Size to 8 MB.
- ▶▶ 16MB Set AGP Aperture Size to 16 MB.

- ▶▶ 32MB Set AGP Aperture Size to 32 MB.
- ▶▶ 64MB Set AGP Aperture Size to 64 MB. (Default Value)
- ▶▶ 128MB Set AGP Aperture Size to 128 MB.
- ▶▶ 256MB Set AGP Aperture Size to 256 MB.

☞ **AGP Read Synchronization**

- ▶▶ Enabled Enable AGP Read Synchronization.
- ▶▶ Disabled Disable AGP Read Synchronization. (Default Value)

☞ **PCI Delay Transaction**

- ▶▶ Enabled Enabled PCI Delay Transaction. (Default Value)
- ▶▶ Disabled Disabled PCI Delay Transaction.

☞ **USB Controller**

- ▶▶ Disabled Disable USB Controller function.
- ▶▶ USB Port 1&2 Enabled USB Port 1&2.
- ▶▶ USB Port 2&3 Enabled USB Port 2&3.
- ▶▶ USB Port 1&3 Enabled USB Port 1&3.
- ▶▶ USB1 Enabled USB Port 1.
- ▶▶ USB2 Enabled USB Port 2.
- ▶▶ USB3 Enabled USB Port 3.
- ▶▶ All USB Port Enabled All USB Port . (Default Value)

☞ **USB Legacy Support**

- ▶▶ Keyboard/FDD Set USB Legacy Support Keyboard / Floppy.
- ▶▶ KB/Mouse/FDD Set USB Legacy Support Keyboard / Mouse /Floppy.
- ▶▶ Disabled Disabled USB Legacy Support Function. (Default Value)

☞ **USB Port 64/60 Emulation**

- ▶▶ Enabled To use USB mouse under Win NT environment, set USB Legacy Support to KB/Mouse/FDD and USB Port 64/60 Emulation to enabled.
- ▶▶ Disabled Disable this Function. (Default Value)

⤵ VCore Voltage

- ▶▶ Normal Normal Function.(Default Value)
- ▶▶ +5.0% Set VCore voltage to +5.0%.
- ▶▶ +7.5% Set VCore voltage to +7.5%.
- ▶▶ +10.0% Set VCore voltage to +10.0%.

Power Management Setup

| AMIBIOS SETUP - POWER MANAGEMENT SETUP | | |
|--|--------------|---|
| (C) 1999 American Megatrends, Inc. All Rights Reserved | | |
| ACPI Standby State | :S1/POS | RTC Alarm Date :15 |
| USB Dev Wakeup From S3-S5 | :Disabled | RTC Alarm Hour :12 |
| Suspend Time Out(Minute) | :Disabled | RTC Alarm Minute :30 |
| IRQ3 | :Monitor | RTC Alarm Second :30 |
| IRQ 4 | :Monitor | |
| IRQ 5 | :Ignore | |
| IRQ 7 | :Monitor | |
| IRQ 9 | :Ignore | |
| IRQ 10 | :Ignore | |
| IRQ 11 | :Ignore | |
| IRQ 13 | :Ignore | |
| IRQ 14 | :Monitor | |
| IRQ 15 | :Ignore | |
| Soft-off by Power Button | :Instant off | |
| AC Back Function | :Soft-Off | |
| Modem Ring On/Wake On Lan | :Enabled | ESC: Quit ↑↓→←: Select Item |
| PME Event Wake Up | :Enabled | F1 : Help PU/PD+/-/ : Modify |
| Keyboard Wakeup From | :S1(Suspend) | F5 : Old Values (Shift)F2: Color |
| PS/2 Mouse Wakeup From | :S1(Suspend) | F6 : Load Fail-Safe Defaults F8:Flash Utility |
| Resume On RTC Alarm | :Disabled | F7 : Load Optimized Defaults |

Figure 5: Power Management Setup

☞ ACPI Standby State

- ▶▶ S1/POS Set ACPI standby state is S1. (Default Value)
- ▶▶ S3/STR Set ACPI standby state is S3.

☞ USB Dev Wakeup From S3~S5

USB Dev Wakeup From S3~S5 can be set when ACPI standby state set to S3/STR.

- ▶▶ Enabled Enable USB Dev Wakeup From S3~S5.
- ▶▶ Disabled Disable USB Dev Wakeup From S3~S5. (Default Value).

Suspend Time Out (Minute.)

- ▶▶ Disabled Disabled Suspend Time Out Function. (Default Value)
- ▶▶ 1 Enabled Suspend Time Out after 1min.
- ▶▶ 2 Enabled Suspend Time Out after 2min.
- ▶▶ 4 Enabled Suspend Time Out after 4min.
- ▶▶ 8 Enabled Suspend Time Out after 8min.
- ▶▶ 10 Enabled Suspend Time Out after 10min.
- ▶▶ 20 Enabled Suspend Time Out after 20min.
- ▶▶ 30 Enabled Suspend Time Out after 30min.
- ▶▶ 40 Enabled Suspend Time Out after 40min.
- ▶▶ 50 Enabled Suspend Time Out after 50min.
- ▶▶ 60 Enabled Suspend Time Out after 60min.

IRQ 3~IRQ15

- ▶▶ Ignore Ignore IRQ3 ~IRQ15.
- ▶▶ Monitor Monitor IRQ3~IRQ15.

Soft-off by Power Button

- ▶▶ Instant-off Soft switch ON/OFF for POWER ON/OFF. (Default Value)
- ▶▶ Delay 4 sec Soft switch on 4sec for power OFF.

AC Back Function

- ▶▶ Soft-Off When AC-power back to the system, the system will be in "Soft-Off" state.
(Default Value)
- ▶▶ Full-On When AC-power back to the system, the system will be in "Full-On" state.
- ▶▶ Memory When AC-power back to the system, the system will return to the Last state
before AC-power off.

PNP/PCI Configuration

| AMIBIOS SETUP - PNP/PCI CONFIGURATION | |
|--|-----------|
| (C) 1999 American Megatrends, Inc. All Rights Reserved | |
| VGA Boot From | : AGP |
| PCI Slot 1/5 IRQ Priority | : Auto |
| PCI Slot 2 IRQ Priority | : Auto |
| PCI Slot 3 IRQ Priority | : Auto |
| PCI Slot 4 IRQ Priority | : Auto |
| IRQ3 | : PCI/PnP |
| IRQ4 | : PCI/PnP |
| IRQ5 | : PCI/PnP |
| IRQ7 | : PCI/PnP |
| IRQ9 | : PCI/PnP |
| IRQ10 | : PCI/PnP |
| IRQ11 | : PCI/PnP |
| IRQ14 | : PCI/PnP |
| IRQ15 | : PCI/PnP |
| ESC: Quit ↑↓→←: Select Item F1 : Help PU/PD+/-/ : Modify F5 : Old Values (Shift)F2: Color F6 : Load Fail-Safe Defaults F8:Flash Utility F7 : Load Optimized Defaults | |

Figure 6: PNP/PCI Configuration

☞ **VGA Boot From**

- ▶▶ AGP Set VGA Boot from AGP VGA Card. (Default Value)
- ▶▶ PCI Set VGA Boot from PCI VGA Card.

☞ **PCI Slot1/5, 2, 3, 4 IRQ Priority**

- ▶▶ Auto The system will reserved a free IRQ for PCI slot 1/5, 2, 3, 4 device.
(Default Value)
- ▶▶ 3 The system will reserved IRQ3 for PCI slot 1/5, 2, 3, 4 device if no legacy
ISA device using IRQ3.
- ▶▶ 4 The system will reserved IRQ for PCI slot 1/5, 2, 3, 4 device if no legacy
ISA device using IRQ4.
- ▶▶ 5 The system will reserved IRQ5 for PCI slot 1/5, 2, 3, 4 device if no legacy
ISA device using IRQ5.

- ▶▶7 The system will reserved IRQ7 for PCI slot 1/5, 2, 3, 4 device if no legacy ISA device using IRQ7.
- ▶▶9 The system will reserved IRQ9 for PCI slot 1/5, 2, 3, 4 device if no legacy ISA device using IRQ9.
- ▶▶10 The system will reserved IRQ10 for PCI slot 1/5, 2, 3, 4 device if no legacy ISA device using IRQ10.
- ▶▶11 The system will reserved IRQ11 for PCI slot 1/5, 2, 3, 4 device if no legacy ISA device using IRQ11.

☞ **IRQ (3,4,5,7,9,10,11,14,15)**

- ▶▶ ISA The resource reserved for Legacy ISA device.
- ▶▶ PCI / PnP The resource can be assigned to PCI/ PnP device.

Load Fail-Safe Defaults

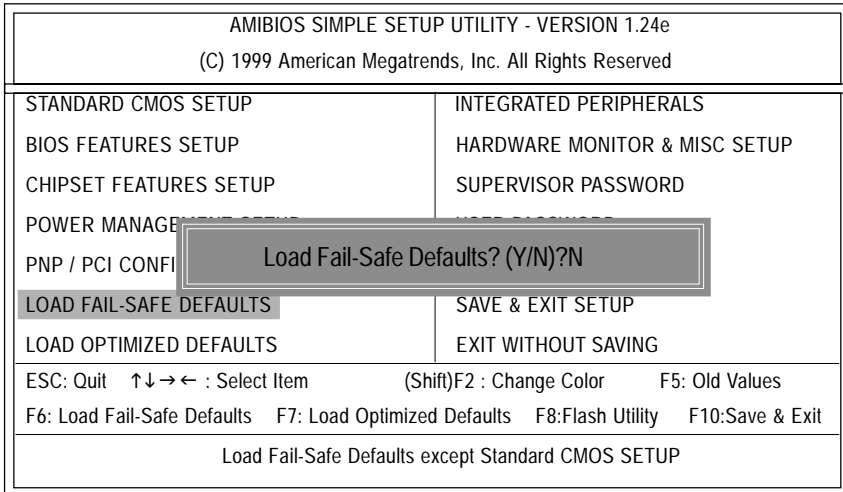

Figure 7: Load Fail-Safe Defaults

☞ Load Fail-Safe Defaults

Fail-Safe defaults contain the most appropriate system parameter values of to configure the system to achieve maximum stability.

Load Optimized Defaults

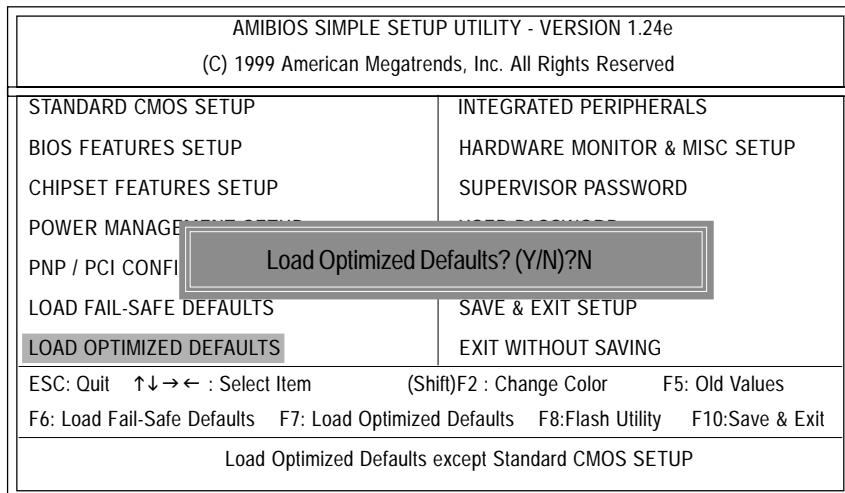

Figure 8: Load Optimized Defaults

Load Optimized Defaults

Optimized defaults contain the most appropriate system parameter values to configure the system to achieve maximum performance.

Integrated Peripherals

| AMIBIOS SETUP - INTEGRATED PERIPHERALS | |
|--|----------|
| (C) 1999 American Megatrends, Inc. All Rights Reserved | |
| OnBoard FDC | :Auto |
| OnBoard Serial Port 1 | :Auto |
| OnBoard Serial Port 2 | :Auto |
| Serial Port2 Mode | :Normal |
| OnBoard Parallel Port | :Auto |
| Parallel Port Mode | :ECP |
| Parallel Port IRQ | :Auto |
| Parallel Port DMA | :Auto |
| OnBoard IDE | :Both |
| OnBoard MC'97 Modem | :Auto |
| OnBoard Creative Sound | :Enabled |
| OnBoard LAN Chip | :Enabled |

ESC: Quit ↑↓→←: Select Item
 F1 : Help PU/PD+/-/ : Modify
 F5 : Old Values (Shift)F2: Color
 F6 : Load Fail-Safe Defaults F8:Flash Utility
 F7 : Load Optimized Defaults

Figure 9: Integrated Peripherals

☞ On Board FDC

- ▶▶Auto Set On Board FDC is Auto (Default Value).
- ▶▶Disabled Disabled On Board FDC
- ▶▶Enabled Enabled On Board FDC

☞ Onboard Serial Port 1

- ▶▶Auto BIOS will automatically setup the port 1 address (Default Value).
- ▶▶3F8/COM1 Enable onboard Serial port 1 and address is 3F8.
- ▶▶2F8/COM2 Enable onboard Serial port 1 and address is 2F8.
- ▶▶3E8/COM3 Enable onboard Serial port 1 and address is 3E8.
- ▶▶2E8/COM4 Enable onboard Serial port 1 and address is 2E8.
- ▶▶Disabled Disable onboard Serial port 1.

Onboard Serial Port 2

- ▶▶ Auto BIOS will automatically setup the port 2 address (Default Value).
- ▶▶ 3F8/COM1 Enable onboard Serial port 2 and address is 3F8.
- ▶▶ 2F8/COM2 Enable onboard Serial port 2 and address is 2F8.
- ▶▶ 3E8/COM3 Enable onboard Serial port 2 and address is 3E8.
- ▶▶ 2E8/COM4 Enable onboard Serial port 2 and address is 2E8.
- ▶▶ Disabled Disable onboard Serial port 2.

Serial Port 2 Mode

- ▶▶ Normal Normal operation. (Default Value)
 - ▶▶ IrDA Onboard I/O chip supports IrDA
 - ▶▶ ASK IR Onboard I/O chip supports ASK IR.
 - ▶▶ SCR Onboard I/O chip supports SCR.
- SCR option is shown only when there's SCR hardware function is installed.

OnBoard Parallel port

- ▶▶ 378 Enable On Board LPT port and address is 378.
- ▶▶ 278 Enable On Board LPT port and address is 278.
- ▶▶ 3BC Enable On Board LPT port and address is 3BC.
- ▶▶ Auto Set On Board LPT port is Auto. (Default Value)
- ▶▶ Disabled Disable On Board LPT port.

Parallel Port Mode

- ▶▶ EPP Using Parallel port as Enhanced Parallel Port.
- ▶▶ ECP Using Parallel port as Extended Capabilities Port. (Default Value)
- ▶▶ Normal Normal Operation.
- ▶▶ EPP+ECP Using Parallel port as Enhanced Parallel Port & Extended Capabilities Port.

☞ **Parallel Port IRQ**

- ▶▶ 7 Set Parallel Port IRQ is 7.
- ▶▶ Auto Set Auto to parallel Port IRQ DMA Channel. . (Default Value).
- ▶▶ 5 Set Parallel Port IRQ is 5.

☞ **Parallel Port DMA**

- ▶▶ Auto Set Auto to parallel port mode DMA Channel. . (Default Value).
- ▶▶ 3 Set Parallel Port DMA is 3.
- ▶▶ 1 Set Parallel Port DMA is 1.
- ▶▶ 0 Set Parallel Port DMA is 0.

☞ **OnBoard IDE**

- ▶▶ Disabled Disabled OnBoard IDE
- ▶▶ Both Set OnBoard IDE is Both (Default Value).
- ▶▶ Primary Set OnBoard IDE is Primary
- ▶▶ Secondary Set OnBoard IDE is Secondary

☞ **OnBoard MC'97 Modem**

- ▶▶ Auto Enabled On Board MC'97 Modem. (Default Value)
- ▶▶ Disabled Disabled On Board MC'97 Modem.

☞ **OnBoard Creative Sound**

- ▶▶ Enabled Enabled OnBoard Creative Sound. (Default Value)
- ▶▶ Disabled Disabled OnBoard Creative Sound.

☞ **OnBoard Lan Chip**

- ▶▶ Enabled Enabled OnBoard Lan Chip. (Default Value)
- ▶▶ Disabled Disabled OnBoard Lan Chip.

Hardware Monitor & MISC Setup

| AMIBIOS SETUP - HARDWARE MONITOR & MISC SETUP | |
|--|--------------|
| (C) 1999 American Megatrends, Inc. All Rights Reserved | |
| CPU Host Clock (Mhz) | :By Jumper |
| CPU Temp. | : 35°C/ 95°F |
| System Temp. | : 33°C/ 91°F |
| CPU Fan Speed | : 5273 RPM |
| System Fan Speed | : 0 RPM |
| Vcore | : +1.632V |
| Vtt | : +3.344V |
| +3.300V | : +3.296V |
| +5.000V | : +5.080V |
| +12.000V | : +11.840V |
| 5V SB | : +4.972V |
| ESC: Quit ↑↓→← : Select Item | |
| F1 : Help PU/PD+/- : Modify | |
| F5 : Old Values (Shift)F2: Color | |
| F6 : Load Fail-Safe Defaults F8:Flash Utility | |
| F7 : Load Optimized Defaults | |

Figure 10: Hardware Monitor & MISC Setup

CPU Host Clock (Mhz)

- ▶▶ By Jumper Set CPU Host Clock by jumper. (Default Value)
- ▶▶ 133 Set CPU Host Clock to 133MHz~161MHz.
- ▶▶ 100 Set CPU Host Clock to 100MHz~128MHz.

CPU / System Temp.

- ▶▶ Detect CPU / System Temperature automatically.

CPU / System FAN Speed

- ▶▶ Detect CPU / System Fan speed status automatically .

Current Voltage (V) VCORE / Vtt / +3.3V / +12V / +5V / 5VSB

- ▶▶ Detect system's voltage status automatically.

Set Supervisor / User Password

When you select this function, the following message will appear at the center of the screen to assist you in creating a password.

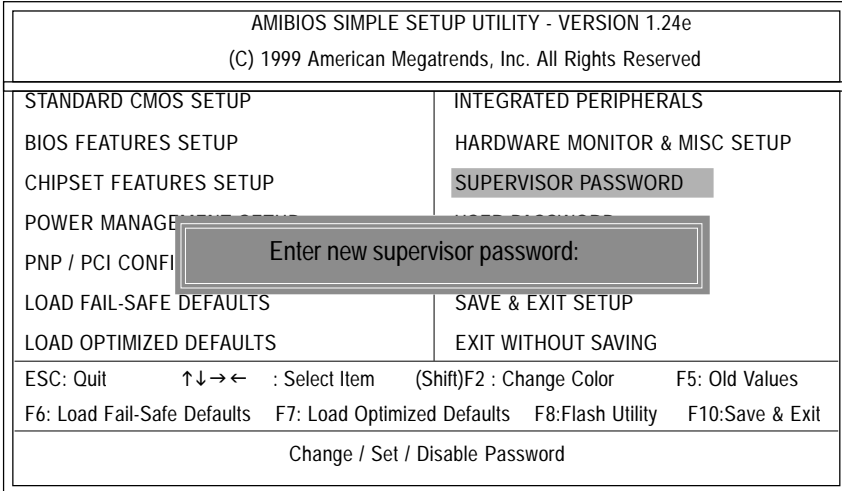

Figure 11: Password Setting

Type the password, up to six characters, and press <Enter>. You will be asked to confirm the password. Type the password again and press <Enter>. You may also press <Esc> to abort the selection and not enter a password.

To disable password, just press <Enter> when you are prompted to enter password. A message "PASSWORD DISABLED" will appear to confirm the password being disabled. Once the password is disabled, the system will boot and you can enter Setup freely.

The BIOS Setup program allows you to specify two separate passwords: a SUPERVISOR PASSWORD and a USER PASSWORD. When disabled, anyone may access all BIOS Setup program function. When enabled, the Supervisor password is required for entering the BIOS Setup program and having full configuration fields, the User password is required to access only basic items.

If you select "Always" at "Password Check" in BIOS Features Setup Menu, you will be prompted for the password every time the system is rebooted or any time you try to enter Setup Menu.

If you select "Setup" at "Password Check" in BIOS Features Setup Menu, you will be prompted only when you try to enter Setup.

IDE HDD Auto Detection

| AMIBIOS SETUP - STANDARD CMOS SETUP | | | | | | | | | | | | | | | | | | | | | | | | | | | | | | | | | | | | | | | | | |
|--|--------------------------|------|------|---------|-------|---------|-------|--------|------|------------|--------|--|--|--|--|--|--|-----------|--------|--|--|--|--|--|--|------------|--------|--|--|--|--|--|--|-----------|--------|--|--|--|--|--|--|
| (C) 1999 American Megatrends, Inc. All Rights Reserved | | | | | | | | | | | | | | | | | | | | | | | | | | | | | | | | | | | | | | | | | |
| Date (mm/dd/yyyy) : Fri Mar 16, 2001 | | | | | | | | | | | | | | | | | | | | | | | | | | | | | | | | | | | | | | | | | |
| Time (hh/mm/ss) : 14:44:35 | | | | | | | | | | | | | | | | | | | | | | | | | | | | | | | | | | | | | | | | | |
| <table border="1"> <thead> <tr> <th>TYPE</th> <th>SIZE</th> <th>CYLS</th> <th>HEAD</th> <th>PRECOMP</th> <th>LANDZ</th> <th>SECTOR</th> <th>MODE</th> </tr> </thead> <tbody> <tr> <td>Pri Master</td> <td>: Auto</td> <td></td> <td></td> <td></td> <td></td> <td></td> <td></td> </tr> <tr> <td>Pri Slave</td> <td>: Auto</td> <td></td> <td></td> <td></td> <td></td> <td></td> <td></td> </tr> <tr> <td>Sec Master</td> <td>: Auto</td> <td></td> <td></td> <td></td> <td></td> <td></td> <td></td> </tr> <tr> <td>Sec Slave</td> <td>: Auto</td> <td></td> <td></td> <td></td> <td></td> <td></td> <td></td> </tr> </tbody> </table> | | TYPE | SIZE | CYLS | HEAD | PRECOMP | LANDZ | SECTOR | MODE | Pri Master | : Auto | | | | | | | Pri Slave | : Auto | | | | | | | Sec Master | : Auto | | | | | | | Sec Slave | : Auto | | | | | | |
| TYPE | SIZE | CYLS | HEAD | PRECOMP | LANDZ | SECTOR | MODE | | | | | | | | | | | | | | | | | | | | | | | | | | | | | | | | | | |
| Pri Master | : Auto | | | | | | | | | | | | | | | | | | | | | | | | | | | | | | | | | | | | | | | | |
| Pri Slave | : Auto | | | | | | | | | | | | | | | | | | | | | | | | | | | | | | | | | | | | | | | | |
| Sec Master | : Auto | | | | | | | | | | | | | | | | | | | | | | | | | | | | | | | | | | | | | | | | |
| Sec Slave | : Auto | | | | | | | | | | | | | | | | | | | | | | | | | | | | | | | | | | | | | | | | |
| Floppy Drive A : 1.44 MB 3 ^{1/2} | Base Memory : 640 Kb | | | | | | | | | | | | | | | | | | | | | | | | | | | | | | | | | | | | | | | | |
| Floppy Drive B : Not Installed | Other Memory : 384 Kb | | | | | | | | | | | | | | | | | | | | | | | | | | | | | | | | | | | | | | | | |
| | Extended Memory : 255 Mb | | | | | | | | | | | | | | | | | | | | | | | | | | | | | | | | | | | | | | | | |
| Boot Sector Virus Protection : Disabled | Total Memory : 256 Mb | | | | | | | | | | | | | | | | | | | | | | | | | | | | | | | | | | | | | | | | |
| Month : Jan - Dec | ESC : Exit | | | | | | | | | | | | | | | | | | | | | | | | | | | | | | | | | | | | | | | | |
| Day : 01- 31 | ↑↓ : Select Item | | | | | | | | | | | | | | | | | | | | | | | | | | | | | | | | | | | | | | | | |
| Year : 1990 - 2099 | PU / PD / + / - :Modify | | | | | | | | | | | | | | | | | | | | | | | | | | | | | | | | | | | | | | | | |
| | (Shift) F2 : Color | | | | | | | | | | | | | | | | | | | | | | | | | | | | | | | | | | | | | | | | |

Figure 12: IDE HDD Auto Detection

Type "Y" will accept the H.D.D. parameter reported by BIOS.

Type "N" will keep the old H.D.D. parameter setup. If the hard disk cylinder number is over 1024, then the user can select LBA mode or LARGER mode for DOS partition larger than 528 MB.

Save & Exit Setup

| AMIBIOS SIMPLE SETUP UTILITY - VERSION 1.24e (C) 1999 American Megatrends, Inc. All Rights Reserved | |
|--|-------------------------------|
| STANDARD CMOS SETUP | INTEGRATED PERIPHERALS |
| BIOS FEATURES SETUP | HARDWARE MONITOR & MISC SETUP |
| CHIPSET FEATURES SETUP | SUPERVISOR PASSWORD |
| POWER MANAGEMENT SETUP | USER PASSWORD |
| PNP / PCI CONF | SAVE & EXIT SETUP |
| LOAD FAIL-SAFE DEFAULTS | EXIT WITHOUT SAVING |
| LOAD OPTIMIZED DEFAULTS | |
| ESC: Quit ↑↓→← : Select Item (Shift)F2 : Change Color F5: Old Values | |
| F6: Load Fail-Safe Defaults F7: Load Optimized Defaults F8:Flash Utility F10:Save & Exit | |
| Save Data to CMOS & Exit SETUP | |

Figure 13: Save & Exit Setup

Type "Y" will quit the Setup Utility and save the user setup value to RTC CMOS.

Type "N" will return to Setup Utility.

Exit Without Saving

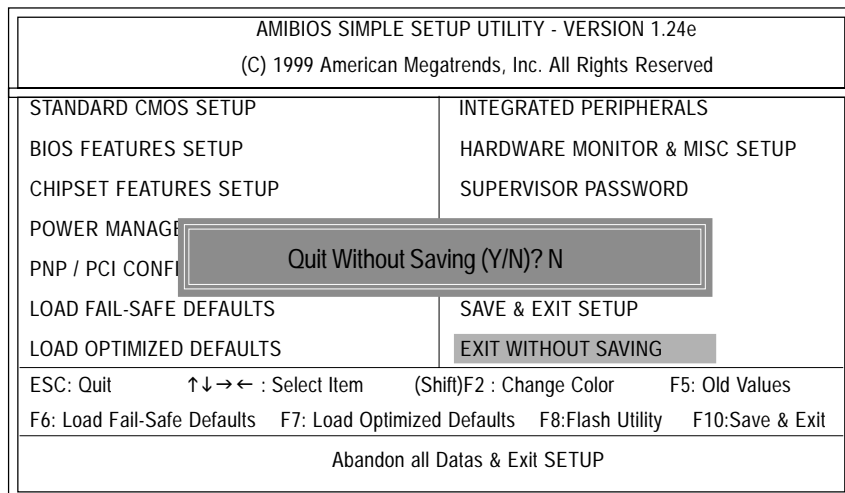

Figure 14: Exit Without Saving

Type "Y" will quit the Setup Utility without saving to RTC CMOS.

Type "N" will return to Setup Utility.

Chapter 4 Technical Reference

Block Diagram

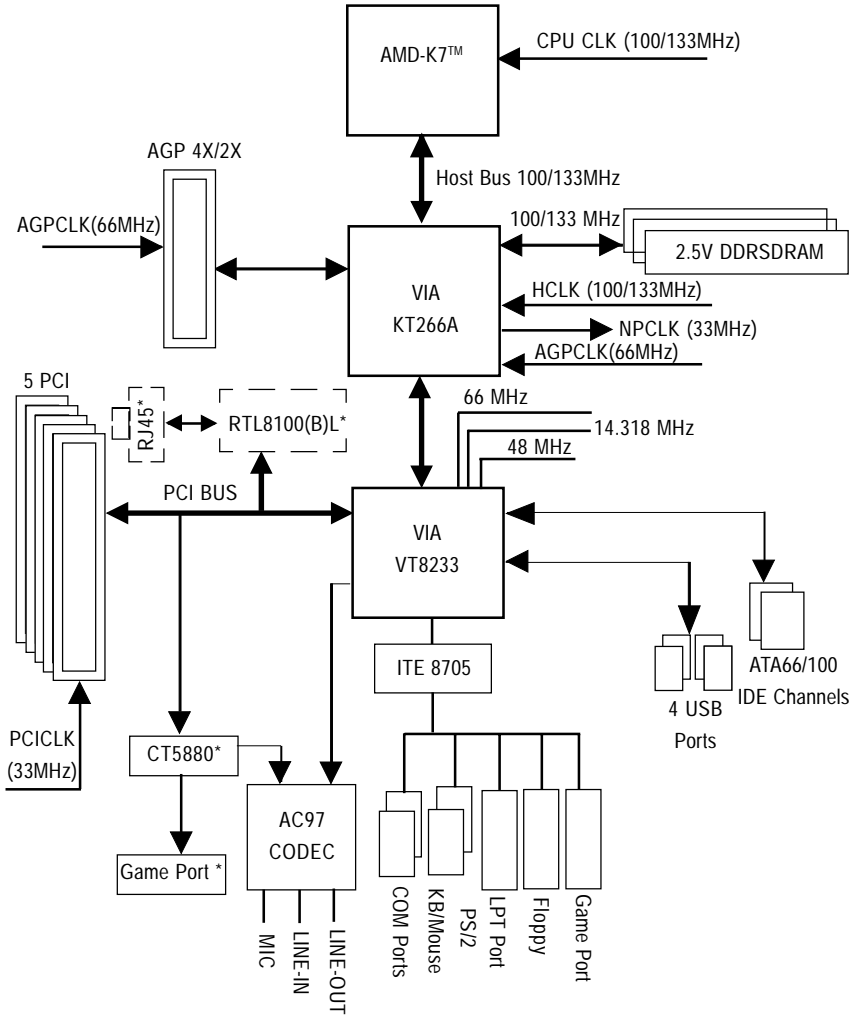

*** Only for GA-7VTXH.

Dual BIOS Introduction

A. What is Dual BIOS Technology?

Dual BIOS means that there are two system BIOS (ROM) on the motherboard, one is the Main BIOS and the other is Backup BIOS. Under the normal circumstances, the system works on the Main BIOS. If the Main BIOS is corrupted or damaged, the Backup BIOS can take over while the system is powered on. This means that your PC will still be able to run stably as if nothing has happened in your BIOS.

B. How to use Dual BIOS and Q-Flash Utility?

a. Boot Screen



When you press "DEL" in to the Setup screen, you can press F8 in to the Flash Utility.

b. AMI Dual BIOS Flash ROM Programming Utility

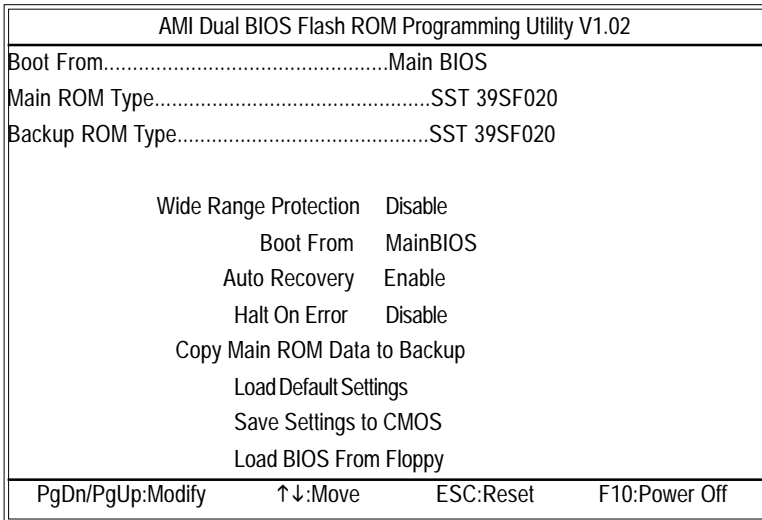

c. Dual BIOS Item explanation:

BIOS will auto detect:

Boot From : Main BIOS

Main ROM Type : SST 39SF020

Backup ROM Type : SST 39SF020

Wide Range Protection: Disable(Default), Enable

Status 1:

If any failure (ex. Update ESCD failure, checksum error or reset...) occurs in the Main BIOS , just before the Operating System is loaded and after the power is on, and that the Wide Range Protection is set to "Enable", the PC will boot from Backup BIOS automatically.

Status 2:

If the ROM BIOS on peripherals cards(ex. SCSI Cards, LAN Cards,..) emits signals to request restart of the system after the user make any alteration on it, the boot up BIOS will not be changed to the Backup BIOS.

Boot From : Main BIOS (Default), Backup BIOS

Status 1:

The user can set to boot from main BIOS or Backup BIOS.

Auto Recovery : Enabled(Default), Disabled

When one of the Main BIOS or Backup BIOS occurs checksum failure, the working BIOS will automatically recover the BIOS of checksum failure.

(In the Power Management Setup of the BIOS Setting, if ACPI Suspend Type is set to Suspend to RAM, the Auto Recovery will be set to Enable automatically.)

(If you want to enter the BIOS setting, please press "Del" key when the boot screen appears.)

Halt On Error : Disable(Default), Enable

If the BIOS occurs a checksum error or the Main BIOS occurs a WIDE RANGE PROTECTION error and Halt On BIOS Defects set to Enable, the PC will show messages on the boot screen, and the system will pause and wait for the user's instruction.

If Auto Recovery: Disable, it will show <or the other key to continue.>

If Auto Recovery: Enable, it will show <or the other key to Auto Recover.>

Copy Main ROM Data to Backup

Backup message:

Are you sure to copy BIOS?

[Enter] to continue or [Esc] to abort...

The means that the Main BIOS works normally and could automatically recover the Backup BIOS. Or the means that the Backup BIOS works normally and could automatically recover the Main BIOS.

(This auto recovery utility is set by system automatically and can't be changed by user.)

C. What is Q-Flash Utility?

Q-Flash utility is a pre-O.S. BIOS flash utility enables users to update its BIOS within BIOS mode, no more fooling around any OS.

D. How to use Q-Flash?

Load BIOS From Floppy

 In the A:drive, insert the "BIOS" diskette, then Press Enter to Run.

 Input BIOS file name in the text box. Press "Enter".



LoadXXXX.XX

The screenshot shows a grey rectangular box with a black border containing the text "LoadXXXX.XX". A black arrow points upwards from the text "Where XXX.XX is name of the BIOS file." to the "X" characters in the prompt.

Where XXX.XX is name of the BIOS file.

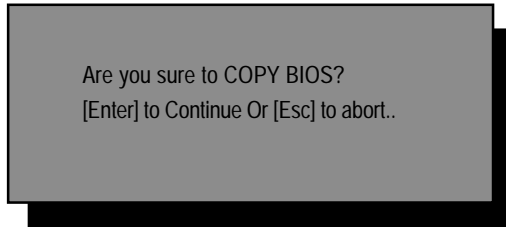

Are you sure to COPY BIOS?
[Enter] to Continue Or [Esc] to abort..

The screenshot shows a grey rectangular box with a black border containing the text "Are you sure to COPY BIOS?" and "[Enter] to Continue Or [Esc] to abort..".

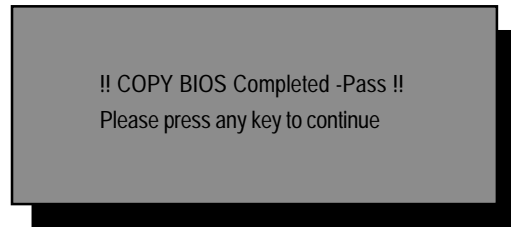

!! COPY BIOS Completed -Pass !!
Please press any key to continue

The screenshot shows a grey rectangular box with a black border containing the text "!! COPY BIOS Completed -Pass !!" and "Please press any key to continue".

Congratulation! You have completed the flashed and now can restart system.



DualBIOS™ Technology FAQ

GIGABYTE Technology is pleased to introduce DualBIOS technology, a hot spare for your system BIOS. This newest “Value-added” feature, in a long series of innovations from GIGABYTE, is available on this motherboard. Future GIGABYTE motherboards will also incorporate this innovation.

What’s DualBIOS™?

On GIGABYTE motherboards with DualBIOS there are physically two BIOS chips. For simplicity we’ll call one your “Main BIOS” and the other we’ll call your “Backup” BIOS (your “hot spare”). If your Main BIOS fails, the Backup BIOS almost automatically takes over on your next system boot. Almost automatically and with virtually zero down time! Whether the problem is a failure in flashing your BIOS or a virus or a catastrophic failure of the Main BIOS chip, the result is the same - the Backup BIOS backs you up, almost automatically.

I. Q: What is DualBIOS™ technology?**Answer:**

DualBIOS technology is a patented technology from Giga-Byte Technology. The concept of this technology is based on the redundancy and fault tolerance theory. DualBIOS™ technology simply means there are two system BIOSes (ROM) integrated onto the motherboard. One is a main BIOS, and the other is a backup BIOS. The mainboard will operate normally with the main BIOS, however, if the main BIOS is corrupt or damaged for various reasons, the backup BIOS will be automatically used when the system powered-On. Your PC will operate as before the main BIOS was damaged, and is completely transparent to the user.

II. Q: Why does anyone need a motherboard with DualBIOS™ technology?**Answer:**

In today's systems there are more and more BIOS failures. The most common reasons are virus attacks, BIOS upgrade failures, and/or deterioration of the BIOS (ROM) chip itself.

1. New computer viruses are being found that attack and destroy the system BIOS. They may corrupt your BIOS code, causing your PC to be unstable or even not boot normally.
2. BIOS data will be corrupted if a power loss/surge occurs, or if a user resets the system, or if the power button is pressed during the process of performing a system BIOS upgrade.
3. If a user mistakenly updates their mainboard with the incorrect BIOS file, then the system may not be able to boot correctly. This may cause the PC system hang in operation or during boot.
4. A flash ROM's life cycle is limited according to electronic characteristics. The modern PC utilizes the Plug and Play BIOS, and is updated regularly. If a user changes peripherals often, there is a slight chance of damage to the flash ROM.

With Giga-Byte Technology's patented DualBIOS™ technology you can reduce the possibility of hangs during system boot up, and/or loss BIOS data due to above reasons. This new technology will eliminate valuable system down time and costly repair bills cause by BIOS failures.

III. Q: How does DualBIOS™ technology work?

Answer:

1. DualBIOS™ technology provides a wide range of protection during the boot up procedure. It protects your BIOS during system POST, ESCD update, and even all the way to PNP detection/assignment.
2. DualBIOS™ provides automatic recovery for the BIOS. When the first BIOS used during boot up does not complete or if a BIOS checksum error occurs, boot-up is still possible. In the DualBIOS™ utility, the "Auto Recovery" option will guarantee that if either the main BIOS or backup BIOS is corrupted, the DualBIOS™ technology will use the good BIOS and correct the wrong BIOS automatically.
3. DualBIOS™ provides manual recovery for the BIOS. DualBIOS™ technology contains a built-in flash utility, which can flash your system BIOS from backup to main and/or visa versa. There is no need for an OS-dependent flash utility program.
4. DualBIOS™ contains a one-way flash utility. The built-in one-way flash utility will ensure that the corrupt BIOS is not mistaken as the good BIOS during recovery and that the correct BIOS (main vs. backup) will be flashed. This will prevent the good BIOS from being flashed.

IV. Q: Who Needs DualBIOS™ technology?

Answer:

1. Every user should have DualBIOS™ technology due to the advancement of computer viruses.

Everyday, there are new BIOS-type viruses discovered that will destroy your system BIOS. Most commercial products on the market do not have solutions to guard against this type of virus intrusion. The DualBIOS™ technology will provide a state-of-the-art solution to protect your PC:

Case I.) Vicious computer viruses may wipe out your entire system BIOS. With a conventional single system BIOS PC, the PC will not be functional until it is sent for repairs.

Case II.) If the "Auto Recovery" option is enabled in the DualBIOS™ utility, and if a virus corrupts your system BIOS, the backup BIOS will automatically reboot the system and correct the main BIOS.

Case III.) A user may override booting from the main system BIOS. The DualBIOS™ utility may be entered to manually change the boot sequence to boot from the backup BIOS.

2. During or after a BIOS upgrade, if DualBIOS™ detects that the main BIOS is corrupt, the backup BIOS will take over the boot-up process automatically. Moreover, it will verify the main and backup BIOS checksums when booting-up. DualBIOS™ technology examines the checksum of the main and backup BIOS while the system is powered on to guarantee your BIOS operates properly.
3. Power Users will have the advantage of having two BIOS versions on their mainboard. The benefit is being able to select either version BIOS to suit the performance system needs.
4. Flexibility for high-end desktop PCs and workstation/servers. In the DualBIOS™ utility, the option can be set, "Halt On When BIOS Defects," to be enabled to halt your system with a warning message that the main BIOS has been corrupted. Most workstation/servers require constant operation to guarantee services have not been interrupted. In this situation, the "Halt On When BIOS Defects" message may be disabled to avoid system pauses during normal booting. Another advantage you gain from Giga-Byte's DualBIOS™ technology is the ability to upgrade from dual 2 Mbit BIOS to dual 4 Mbit BIOS in the future if extra BIOS storage is need.

Four Speaker & SPDIF Introduction(For GA-7VTXH Only)

Four Speaker Introduction

A. What is Four Speaker?

The Creative CT5880 audio chip can support up to 4 speaker output. If you select "Four speaker out", Line In will be reconfigured as another line out to support a second pair of speakers.

B. How to use Four Speaker?

Microsoft Windows 98 Second Edition setup procedure:



Click the audio icon along the task bar and select "Configure 3D Audio"

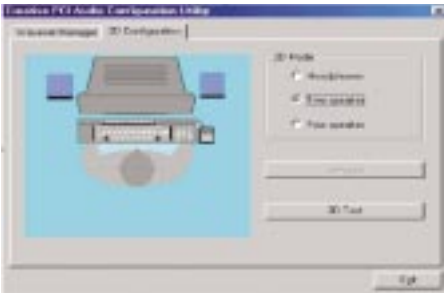

Select two speaker (Default)

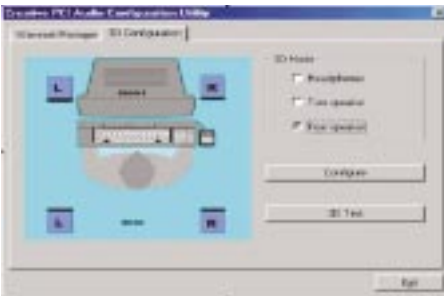

Select "Four speaker" item.

Microsoft Windows Me setup procedure:



Go to "Control Panel" and double click "Sounds and Multimedia".

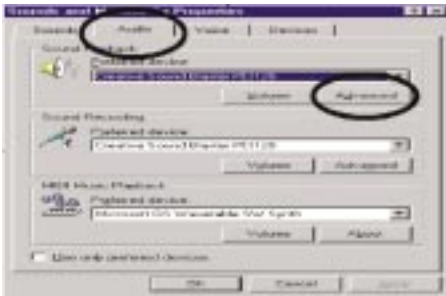

Select "Audio" Page, and click "Advanced" button.



Select "Quadraphonic Speakers" and click ok.

C. Four Speaker Application

The four speaker function will only be supported in application softwares that use Microsoft DirectX and Creative EAX, for example, the game titles, software DVD player and MP3 player.

SPDIF Introduction

A. What is SPDIF?

The SPDIF output is capable of providing digital signal to AC3 decoder which can support upto 5.1 speakers.

B. How to use SPDIF?

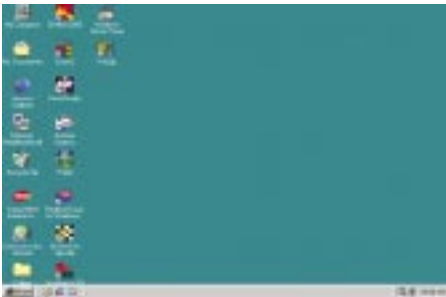

Click your mouse right button in "My Computer" and select the "Properties" item.

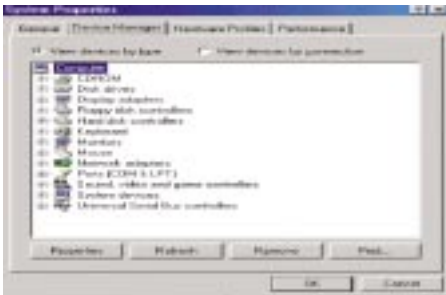

Click "Device Manager" item.

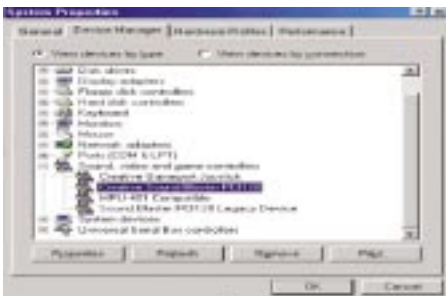

Click "Sound, video and game controllers" item and select the "Creative Sound Blaster PCI128" item.

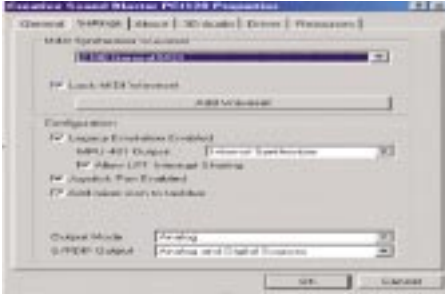

Click "Settings" item and select the "Output Mode" item.

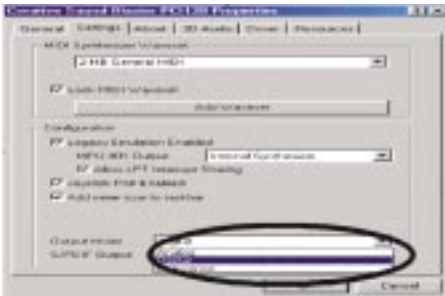

Click "Digital" item, Line Out will be reconfigure to SPDIF Out.

Recommend you to select "Autosense", It will automatically detect the type (mono or stereo) of the audio connector that you plug into Line Out audio jack, then configure Line Out to either SPDIF or Speaker accordingly.

@ BIOS Introduction

Gigabyte announces @ BIOS

Windows BIOS live update utility



Have you ever updated BIOS by yourself? Or like many other people, you just know what BIOS is, but always hesitate to update it? Because you think updating newest BIOS is unnecessary and actually you don't know how to update it.

Maybe not like others, you are very experienced in BIOS updating and spend quite a lot of time to do it. But of course you don't like to do it too much. First, download different BIOS from website and then switch the operating system to DOS mode. Secondly, use different flash utility to update BIOS. The above process is not a interesting job. Besides, always be carefully to store the BIOS source code correctly in your disks as if you update the wrong BIOS, it will be a nightmare.

Certainly, you wonder why motherboard vendors could not just do something right to save your time and effort and save you from the lousy BIOS updating work? Here it comes! Now Gigabyte announces @BIOS—the first Windows BIOS live update utility. This is a smart BIOS update software. It could help you to download the BIOS from internet and update it. Not like the other BIOS update software, it's a Windows utility. With the help of "@BIOS", BIOS updating is no more than a click.

Besides, no matter which mainboard you are using, if it's a Gigabyte's product*, @BIOS help you to maintain the BIOS. This utility could detect your correct mainboard model and help you to choose the BIOS accordingly. It then downloads the BIOS from the nearest Gigabyte ftp site automatically. There are several different choices; you could use "Internet Update" to download and update your BIOS directly. Or you may want to keep a backup for your current BIOS, just choose "Save Current BIOS" to save it first. You make a wise choice to use Gigabyte, and @BIOS update your BIOS smartly. You are now worry free from updating wrong BIOS, and capable to maintain and manage your BIOS easily. Again, Gigabyte's innovative product erects a milestone in mainboard industries.

For such a wonderful software, how much it costs? Impossible! It's free! Now, if you buy a Gigabyte's motherboard, you could find this amazing software in the attached driver CD. But please remember, connected to internet at first, then you could have a internet BIOS update from your Gigabyte @BIOS.

Easy TuneIII™ Introduction

Gigabyte announces *EasyTuneIII* Windows overdrive utility



“Overdrive” might be one of the most common issues in computer field. But have many users ever tried it? The answer is probably “no”. Because “overdrive” is thought to be very difficult and includes a lot of technical know-how, sometimes “overdrive” is even considered as special skills found only in some enthusiasts.

But as to the experts in “overdrive”, what’s the truth? They may spend quite a lot of time and money to study, try and use many different hardware and software tools to do “overdrive”. And even with these technologies, they still learn that it’s quite a risk because the safety and stability of an “overdrive” system is unknown.

Now everything is different because of a Windows overdrive utility EasyTuneIII—announced by Gigabyte. This utility has totally changed the gaming rule of “overdrive”. This is the first overdrive utility suitable for both normal and power users. Users can choose either “Easy Mode” or “Advanced Mode” to run “overdrive” at their convenience. For users who choose “Easy Mode”, they just need to click “Auto Optimize” to have auto and immediate CPU overclocking. This software will then overdrive CPU speed automatically with the result being shown in the control panel. If someone prefers to “overdrive” by oneself, there is also another choice. Click “Advanced Mode” to enjoy “sport drive” class overclocking. In “Advanced Mode”, one can change the system bus speed in small increments to get ultimate system performance. And no matter which mainboard is used, if it’s a Gigabyte’s product”, EasyTuneIII helps to perform the best of system.

Besides, different from other traditional over-clocking methods, EasyTuneIII doesn’t require users to change neither BIOS nor hardware switch/jumper setting; on the other hand, they can do “overdrive” at only one click. Therefore, this is a safer way for “overdrive” as nothing is changed on software or hardware. If user runs EasyTuneIII over system’s limitation, the biggest lost is only to restart the computer again and the side effect is then well controlled. Moreover, if one well-performed system speed been tested in EasyTuneIII, user can “Save” this bus speed and “Load” it in next time. Obviously, Gigabyte EasyTuneIII has already turned the “overdrive” technology toward to a newer generation.

This wonderful software is now free bundled in Gigabyte motherboard attached driver CD. Users may make a test drive of “EasyTuneIII” to find out more amazing features by themselves.

Chapter 5 Appendix

Picture below are shown in Windows ME (VUCD driver version 1.81)

Appendix A: VIA 4 in 1 Service Pack Driver Installation

A. VIA 4 in 1 Service Pack Driver Utility:

Insert the driver CD-title that came with your motherboard into your CD-ROM driver, the driver CD-title will auto start and show the installation guide. If not, please double click the CD-ROM device icon in "My computer", and execute the setup.exe.



(1)

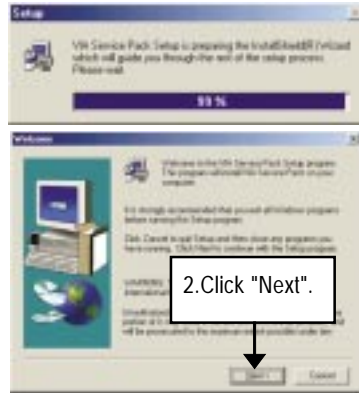

(2)

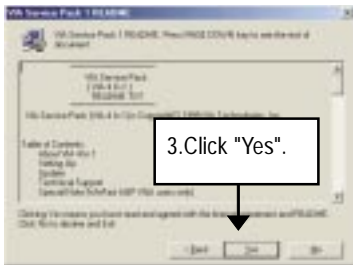

(3)

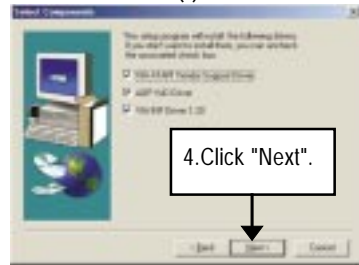

(4)



(5)

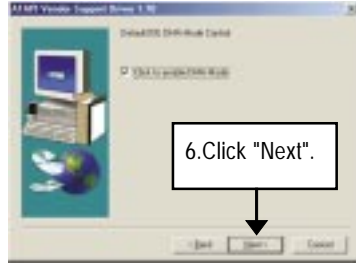

(6)



(7)

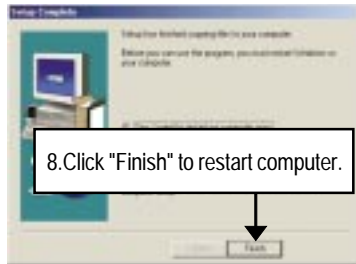

(8)

Appendix B: AC97 Sound Chipset Driver

"AC'97 Audio Driver" under Windows ME will auto install.

Appendix C: Creative CT5880 Chipset Driver Installation (Only for GA-7VTXH)

Insert the driver CD-title that came with your motherboard into your CD-ROM driver, the driver CD-title will auto start and show the installation guide. If not, please double click the CD-ROM device icon in "My computer", and execute the setup.exe.



1. Click "Creative CT5880 Sound Driver" item.

(1)

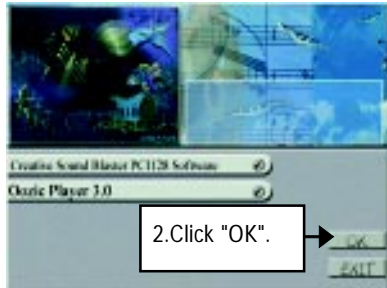

2. Click "OK".

(2)



(3)

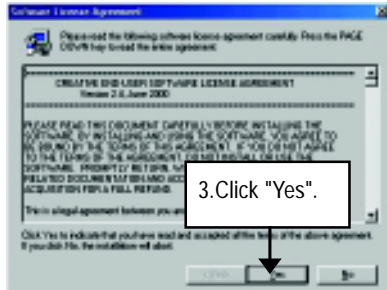

3. Click "Yes".

(4)



(5)

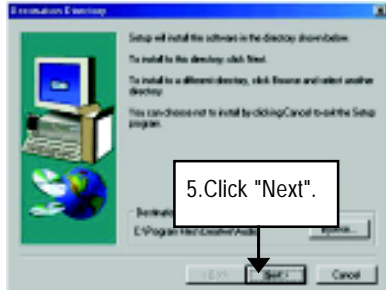

(6)

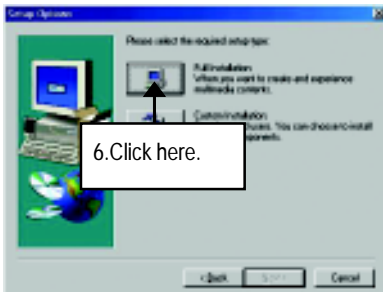

(7)

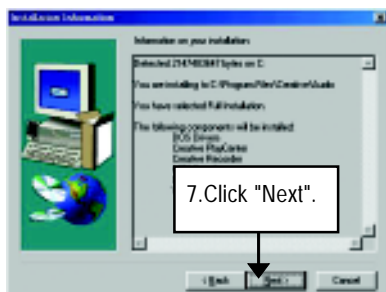

(8)



(9)

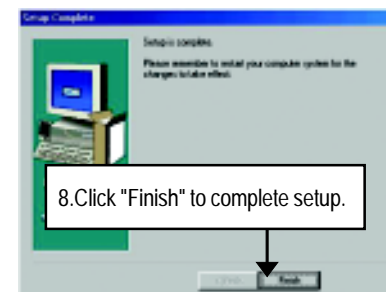

(10)

Oozic Player Installation

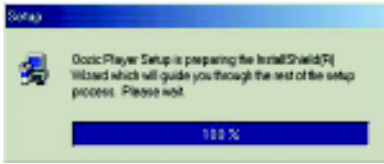

(1)



(2)

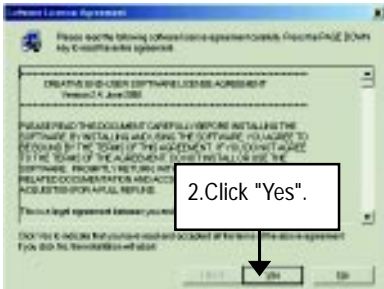

(3)



(4)



(5)



(6)



(7)



Please base on your actual requirement, select "Yes" or "No" accordingly.

(8)

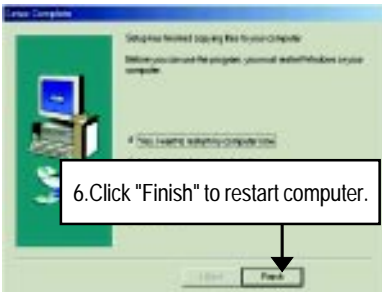

(9)

Appendix D: RealTek 8139/8100 Network Driver (Only for GA-7VTXH)

"RealTek 8139/8100 Network Driver" under Windows ME will auto install. If you would like to install LAN driver, please refer to attached README.txt file for detail instruction. Please install the driver through CD-ROM by the path D:\Network\Rtl (This manual assumes that your CD-ROM device drive letter is D:).

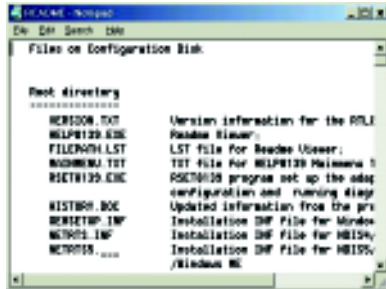
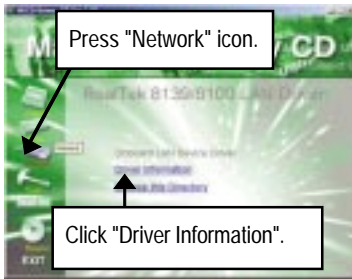

Appendix E: EasyTuneIII Utilities Installation

Insert the driver CD-title that came with your motherboard into your CD-ROM driver, the driver CD-title will auto start and show the installation guide. If not, please double click the CD-ROM device icon in "My computer", and execute the setup.exe.

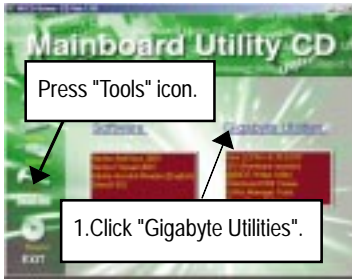

(1)

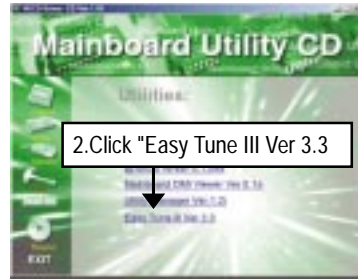

(2)



(3)

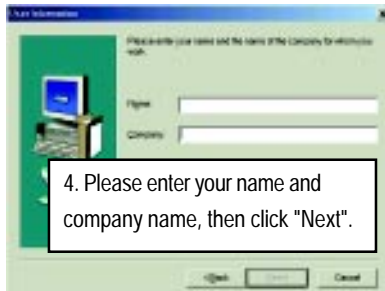

(4)



(5)



(6)

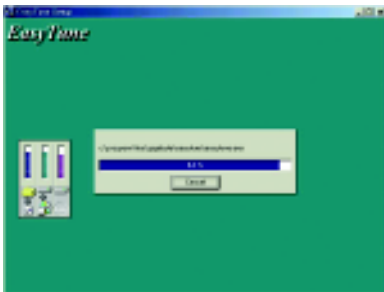

(7)



(8)

Appendix F: BIOS Flash Procedure

BIOS update procedure:

If your OS is Win9X, we recommend that you used Gigabyte @BIOS™ Program to flash BIOS.



(1)

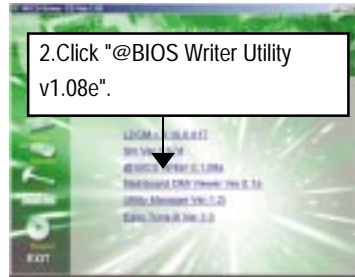

(2)

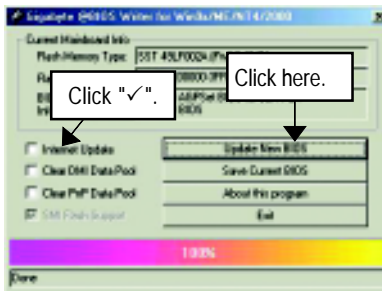

(3)

Methods and steps:

- I. Update BIOS through Internet
 - a. Click "Internet Update" icon
 - b. Click "Update New BIOS" icon
 - c. Select @BIOS™ sever ("Gigabyte @BIOS™ sever 1 in Taiwan" and "Gigabyte @BIOS™ sever 2 in Taiwan" are available for now, the others will be completed soon)
 - d. Select the exact model name on your motherboard
 - e. System will automatically download and update the BIOS.

II. Update BIOS NOT through Internet:

- a. Do not click "Internet Update" icon
- b. Click "Update New BIOS"
- c. Please select "All Files" in dialog box while opening the old file.
- d. Please search for BIOS unzip file, downloading from internet or any other methods (such as: 8ITXR.F3).
- e. Complete update process following the instruction.

III. Save BIOS

In the very beginning, there is "Save Current BIOS" icon shown in dialog box. It means to save the current BIOS version.

IV. Check out supported motherboard and Flash ROM:

In the very beginning, there is "About this program" icon shown in dialog box. It can help you check out which kind of motherboard and which brand of Flash ROM are supported.

Note:

- a. In method I, if it shows two or more motherboard's model names to be selected, please make sure your motherboard's model name again. Selecting wrong model name will cause the system unbooted.
- b. In method II, be sure that motherboard's model name in BIOS unzip file are the same as your motherboard's. Otherwise, your system won't boot.
- c. In method I, if the BIOS file you need cannot be found in @BIOS™ server, please go onto Gigabyte's web site for downloading and updating it according to method II.
- d. Please note that any interruption during updating will cause system unbooted

We use GA-8ITXR motherboard and Flash841 BIOS flash utility as example.

Please flash the BIOS according to the following procedures if you are now under the DOS mode.

Flash BIOS Procedure:

STEP 1:

- (1) Please make sure you have set "Auto" for BIOS Setup (BIOS Flash Protection). For more detail please refer to page 31.
- (2) Please make sure your system has installed the extraction utility such as winzip or pkunzip.
Firstly you have to install the extraction utility such as winzip or pkunzip for unzip the files. Both of these utilities are available on many shareware download pages like <http://www.shareware.cnet.com>

STEP 2: Make a DOS boot diskette. (See example: Windows 98 O.S.)

Beware: Windows ME/2000 are not allowed to make a DOS boot diskette.

- (1) Go to the DOS command prompt in MS-DOS or Windows 9x and, with an available floppy disk in the floppy drive. Please leave the diskette "UN-write protected" type. Double click the "My Computer" icon from Desktop, then click "3.5 diskette (A)" and right click to select "Format (M)

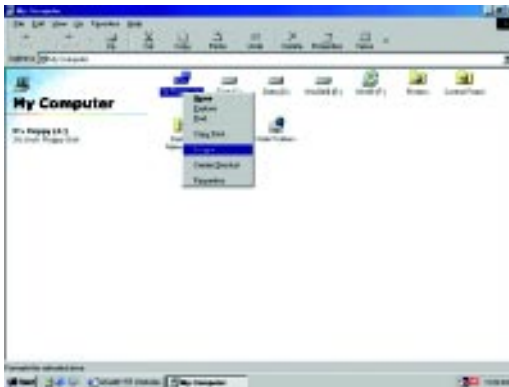

- (2) Select the "Quick (erase)" for Format Type, and pick both "Display summary when finished" and "Copy system files", after that press "Start". That will format the floppy and transfer the needed system files to it.

Beware: This procedure will erase all the prior data on that floppy, so please proceed accordingly.

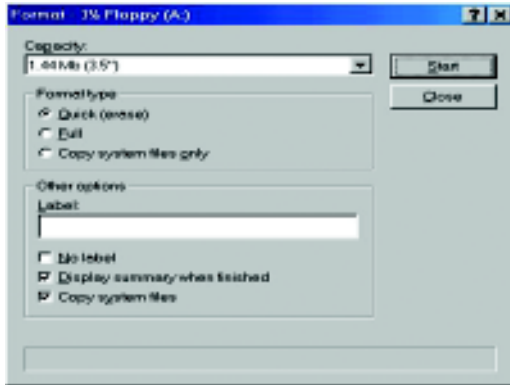

- (3) After the floppy has been formatted completely, please press "Close".



STEP 3: Download BIOS and BIOS utility program.

- (1) Please go to Gigabyte website <http://www.gigabyte.com.tw/chinese-web/index.html>, and click "Support".



- (2) From Support zone, click the "Motherboards BIOS & Drivers".



- (5) At this time the screen shows the following picture, please click "Extract" button to unzip the files.

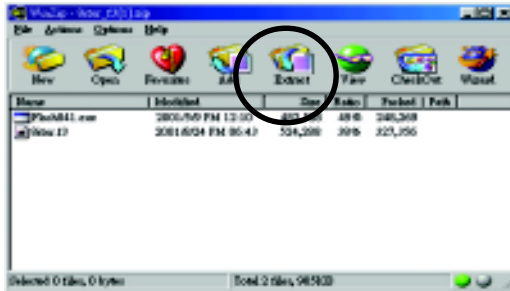

- (6) Please extract the download files into the clean bootable floppy disk A mentioned in STEP 2, and press "Extract".

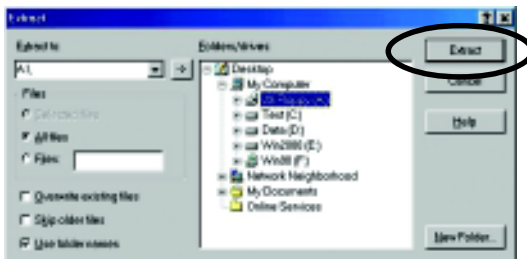

STEP 4: Make sure the system will boot from the floppy disk.

- (1) Insert the floppy disk (contains bootable program and unzip file) into the floppy drive A. Then, restart the system. The system will boot from the floppy disk. Please press key to enter BIOS setup main menu when system is boot up.



- (2) Once you enter the BIOS setup utility, the main menu will appear on the screen. Use the arrows to highlight the item "BIOS FEATURES SETUP".

| | |
|--|---|
| AMIBIOS SIMPLE SETUP UTILITY - VERSION 2.00 (C) 2001 American Megatrends, Inc. All Rights Reserved | |
| STANDARD CMOS SETUP BIOS FEATURES SETUP CHIPSET FEATURES SETUP POWER MANAGEMENT SETUP PNP / PCI CONFIGURATION LOAD FAIL-SAFE DEFAULTS LOAD OPTIMIZED DEFAULTS | INTEGRATED PERIPHERALS HARDWARE MONITOR & MISC SETUP SUPERVISOR PASSWORD USER PASSWORD IDE HDD AUTO DETECTION SAVE & EXIT SETUP EXIT WITHOUT SAVING |
| ESC: Quit ↑↓←→ : Select Item (Shift)F3 : Select Language F5: Old Values F6: Fail-Safe Values F7: Optimized Values F8: Flash Utility F10: Save & Exit | |
| Current Language: English Time, Date , Hard Disk Type... | |

- (3) Press "Enter" to enter "BIOS FEATURES SETUP" menu. Use the arrows to highlight the item "1st Boot Device", and then use the "Page Up" and "Page Down" keys to select "Floppy".

| | |
|---|--|
| AMIBIOS SETUP - BIOS FEATURES SETUP (C) 2001 American Megatrends, Inc. All Rights Reserved | |
| BIOS Flash Protection : Auto 1st Boot Device : Floppy 2nd Boot Device : IDE-0 3rd Boot Device : CDROM Floppy Drive Seek : Disabled BootUp Num-Lock : On Password Check : Setup S.M.A.R.T. for Hard Disks : Disabled | ESC: Quit ↑↓←→: Select Item F1 : Help PU/PD/+/- : Modify F5 : Old Values (Shift)F3: Select Language F6 : Fail-Safe F8: Flash Utility F7 : Optimized |

- (4) Press "ESC" to go back to previous screen. Use the arrows to highlight the item "SAVE & EXIT SETUP" then press "Enter". System will ask "SAVE to CMOS and EXIT (Y/N)?" Press "Y" and "Enter" keys to confirm. Now the system will reboot automatically, the new BIOS setting will be taken effect next boot-up.

| | |
|---|---|
| AMIBIOS SIMPLE SETUP UTILITY - VERSION 2.00 (C) 2001 American Megatrends, Inc. All Rights Reserved | |
| STANDARD CMOS SETUP BIOS FEATURES SETUP CHIPSET FEATURES SETUP POWER MANAGEMENT SETUP PNP / PCI CONF LOAD FAIL-SAFE DEFAULTS LOAD OPTIMIZED DEFAULTS | INTEGRATED PERIPHERALS HARDWARE MONITOR & MISC SETUP SUPERVISOR PASSWORD USER PASSWORD SAVE & EXIT SETUP EXIT WITHOUT SAVING |
| Save to CMOS and EXIT (Y/N)? Y | |
| ESC: Quit ↑↓←→ : Select Item (Shift)F3 : Select Language F5: Old Values F6: Fail-Safe Values F7: Optimized Values F8: Flash Utility F10: Save & Exit | |
| Current Language: English Save Data to CMOS & Exit SETUP | |

STEP 5: BIOS flashing.

- (1) After the system boot from floppy disk, type "A:\> dir/w" and press "Enter" to check the entire files in floppy A. Then type the "BIOS flash utility" and "BIOS file" after A:\>. In this case you have to type "A:\> Flash841 8ITXR.F3" and then press "Enter".

```
Starting Windows 98...

Microsoft(R) Windows98
© Copyright Microsoft Corp 1981-1999

A:\> dir/w
Volume in drive A has no label
Volume Serial Number is 11E5-092F
Directory of A:\
COMMAND.COM      8ITXR.F3  FLASH841.EXE
3 file(s)        1,101,098 bytes
0 dir(s)         62,464 bytes free

A:\> Flash841 8ITXR.F3
```

- (2) Now screen appears the following Flash Utility main menu. Press "Enter", the highlighted item will locate on the model name of the right-upper screen. Right after that, press "Enter" to start BIOS Flash Utility.

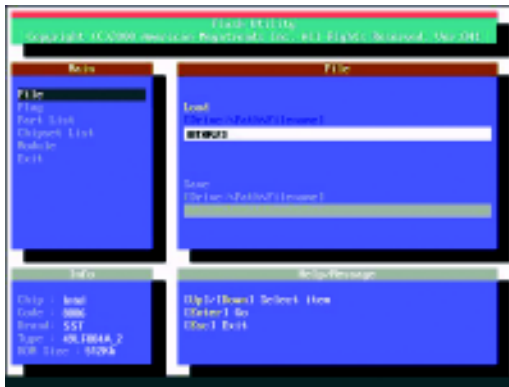

- (3) It will pop up a screen and asks "Are you sure to flash the BIOS?" Press [Enter] to continue the procedure, or press [ESC] to quit.

Beware: Please do not turn off the system while you are upgrading BIOS. It will render your BIOS corrupted and system totally inoperative.

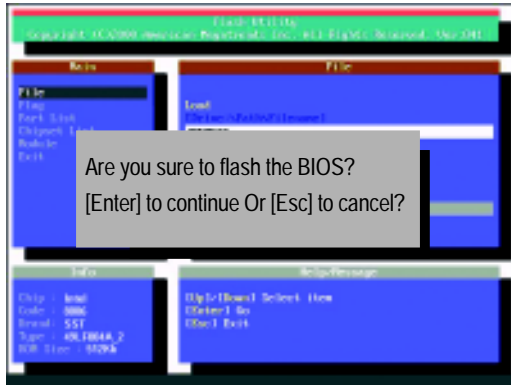

- (4) The BIOS flash completed. Please press [ESC] to exit Flash Utility.

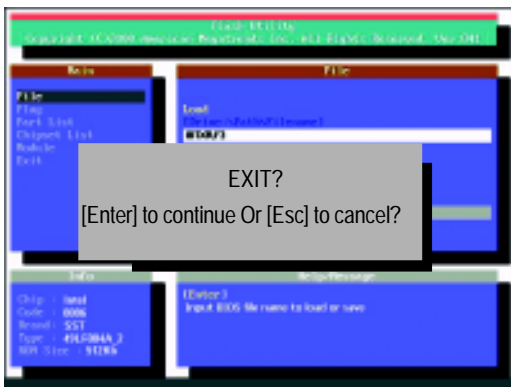

STEP 6: Load BIOS defaults.

Normally the system redetects all devices after BIOS has been upgraded. Therefore, we highly recommend reloading the BIOS defaults after BIOS has been upgraded. This important step resets everything after the flash.

- (1) Take out the floppy diskette from floppy drive, and then restart the system. The boot up screen will indicate your motherboard model and current BIOS version.



- (2) Don't forget to press key to enter BIOS setup again when system is boot up. Use the arrows to highlight the item "LOAD OPTIMIZED DEFAULTS" then press "Enter". System will ask "Load OPTIMIZED Defaults (Y/N)?" Press "Y" and "Enter" keys to confirm.

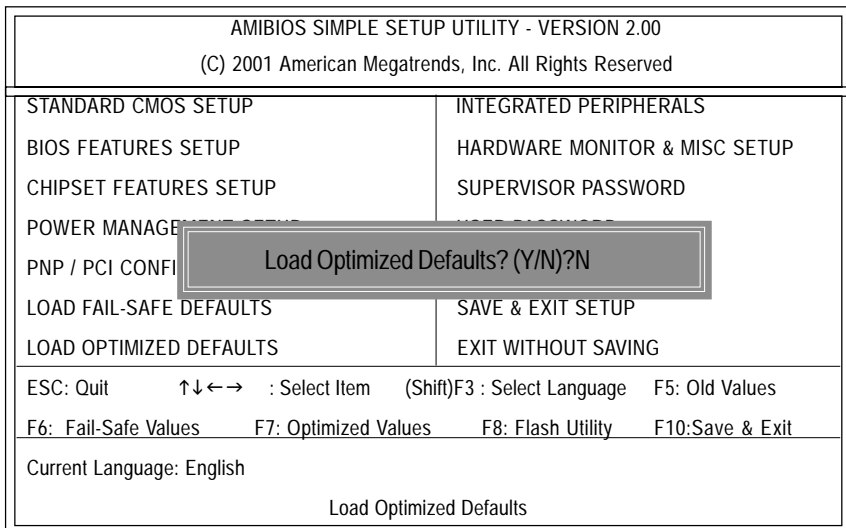

- (3) Use the arrows to highlight the item "SAVE & EXIT SETUP" and press "Enter". System will ask "SAVE to CMOS and EXIT (Y/N)?" Press "Y" and "Enter" keys to confirm. Now the system will reboot automatically, the new BIOS setting will be taken effect next boot-up.

| AMBIOS SIMPLE SETUP UTILITY - VERSION 2.00 | |
|---|-------------------------------|
| (C) 2001 American Megatrends, Inc. All Rights Reserved | |
| STANDARD CMOS SETUP | INTEGRATED PERIPHERALS |
| BIOS FEATURES SETUP | HARDWARE MONITOR & MISC SETUP |
| CHIPSET FEATURES SETUP | SUPERVISOR PASSWORD |
| POWER MANAGEMENT SETUP | USER PASSWORD |
| PNP / PCI CONF | SAVE & EXIT SETUP |
| LOAD FAIL-SAFE DEFAULTS | EXIT WITHOUT SAVING |
| LOAD OPTIMIZED DEFAULTS | |
| ESC: Quit ↑↓←→ : Select Item (Shift)F3 : Select Language F5: Old Values | |
| F6: Fail-Safe Values F7: Optimized Values F8: Flash Utility F10: Save & Exit | |
| Current Language: English | |
| Save Data to CMOS & Exit SETUP | |

- (4) Congratulate you have accomplished the BIOS flash procedure.

Appendix G: Acronyms

| Acronyms | Meaning |
|----------|---|
| ACPI | Advanced Configuration and Power Interface |
| APM | Advanced Power Management |
| AGP | Accelerated Graphics Port |
| AMR | Audio Modem Riser |
| ACR | Advanced Communications Riser |
| BIOS | Basic Input / Output System |
| CPU | Central Processing Unit |
| CMOS | Complementary Metal Oxide Semiconductor |
| CRIMM | Continuity RIMM |
| CNR | Communication and Networking Riser |
| DMA | Direct Memory Access |
| DMI | Desktop Management Interface |
| DIMM | Dual Inline Memory Module |
| DRM | Dual Retention Mechanism |
| DRAM | Dynamic Random Access Memory |
| DDR | Double Data Rate |
| ECP | Extended Capabilities Port |
| ESCD | Extended System Configuration Data |
| ECC | Error Checking and Correcting |
| EMC | Electromagnetic Compatibility |
| EPP | Enhanced Parallel Port |
| ESD | Electrostatic Discharge |
| FDD | Floppy Disk Device |
| FSB | Front Side Bus |
| HDD | Hard Disk Device |
| IDE | Integrated Dual Channel Enhanced |
| IRQ | Interrupt Request |
| I/O | Input / Output |
| IOAPIC | Input Output Advanced Programmable Input Controller |
| ISA | Industry Standard Architecture |
| LAN | Local Area Network |

to be continued.....

| Acronyms | Meaning |
|----------|-------------------------------------|
| LBA | Logical Block Addressing |
| LED | Light Emitting Diode |
| MHz | Megahertz |
| MIDI | Musical Interface Digital Interface |
| MTH | Memory Translator Hub |
| MPT | Memory Protocol Translator |
| NIC | Network Interface Card |
| OS | Operating System |
| OEM | Original Equipment Manufacturer |
| PAC | PCI A.G.P. Controller |
| POST | Power-On Self Test |
| PCI | Peripheral Component Interconnect |
| RIMM | Rambus in-line Memory Module |
| SCI | Special Circumstance Instructions |
| SECC | Single Edge Contact Cartridge |
| SRAM | Static Random Access Memory |
| SMP | Symmetric Multi-Processing |
| SMI | System Management Interrupt |
| USB | Universal Serial Bus |
| VID | Voltage ID |

Technical Support/RMA Sheet



| | | |
|-------------------|---------------|------------|
| Customer/Country: | Company: | Phone No.: |
| Contact Person: | E-mail Add. : | |

| | |
|------------------------|---------------|
| Model name/Lot Number: | PCB revision: |
| BIOS version: | O.S./A.S.: |

| Hardware Configuration | Mfs. | Model name | Size: | Driver/Utility: |
|------------------------|------|------------|-------|-----------------|
| CPU | | | | |
| Memory | | | | |
| Brand | | | | |
| Video Card | | | | |
| Audio Card | | | | |
| HDD | | | | |
| CD-ROM / DVD-ROM | | | | |
| Modem | | | | |
| Network | | | | |
| AMR / CNR | | | | |
| Keyboard | | | | |
| Mouse | | | | |
| Power supply | | | | |
| Other Device | | | | |
| | | | | |
| | | | | |
| | | | | |

Problem Description:



DECLARATION OF CONFORMITY

Per FCC Part 2 Section 2.1077(a)



Responsible Party Name: G.B.T.INC.

**Address: 18305 Valley Blvd., Suite#A LA
Puent, CA 91744**

Phone/FaxNo: (818) 854-9338/ (818) 854-9339

hereby declares that the product

ProductName: Motherboard

ModelNumber: GA-7VTXE/GA-7VTXH

Conforms to the following specifications:

FCC Part 15, Subpart B, Section 15.107(a) and Section 15.109(a),
Class B Digital Device

Supplementary Information:

This device complies with part 15 of the FCC Rules. Operation is subject to the following two conditions: (1) This device may not cause harmful and (2) this device must accept any inference received, including that may cause undesired operation.

Representative Person's Name: ERIC LU

Signature: Eric Lu

Date: Sep. 26,2001

Declaration of Conformity

We, Manufacturer/Importer
(full address)

G.B.T. Technology Trading GmbH
Ausschlagler Weg 41, 1F, 20537 Hamburg, Germany

declare that the product
(description of the apparatus, system, installation to which it refers)

Mother Board

GA-7VTXE/GA-7VTXH
is in conformity with

(reference to the specification under which conformity is declared)

in accordance with 89/336 EEC-EMC Directive

- | | | | |
|---|--|--|--|
| <input type="checkbox"/> EN 55011 | Limits and methods of measurement of radio disturbance characteristics of industrial, scientific and medical (ISM) high frequency equipment | <input type="checkbox"/> EN 61000-3-2* <input checked="" type="checkbox"/> EN 60555-2 | Disturbances in supply systems cause by household appliances and similar electrical equipment "Harmonics" |
| <input type="checkbox"/> EN 55013 | Limits and methods of measurement of radio disturbance characteristics of broadcast receivers and associated equipment | <input type="checkbox"/> EN 61000-3-3* <input checked="" type="checkbox"/> EN 60555-3 | Disturbances in supply systems cause by household appliances and similar electrical equipment "Voltage fluctuations" |
| <input type="checkbox"/> EN 55014 | Limits and methods of measurement of radio disturbance characteristics of household electrical appliances, portable tools and similar electrical apparatus | <input checked="" type="checkbox"/> EN 50081-1 <input checked="" type="checkbox"/> EN 50082-1 | Generic emission standard Part 1: Residual commercial and light industry Generic immunity standard Part 1: Residual commercial and light industry |
| <input type="checkbox"/> EN 55015 | Limits and methods of measurement of radio disturbance characteristics of fluorescent lamps and luminaries | <input type="checkbox"/> EN 55081-2 | Generic emission standard Part 2: Industrial environment |
| <input type="checkbox"/> EN 55020 | Immunity from radio interference of broadcast receivers and associated equipment | <input type="checkbox"/> EN 55082-2 | Generic emission standard Part 2: Industrial environment |
| <input checked="" type="checkbox"/> EN 55022 | Limits and methods of measurement of radio disturbance characteristics of information technology equipment | <input type="checkbox"/> ENV 55104 | Immunity requirements for household appliances tools and similar apparatus |
| <input type="checkbox"/> DIN VDE 0855 <input type="checkbox"/> part 10 <input type="checkbox"/> part 12 | Cabled distribution systems; Equipment for receiving and/or distribution from sound and television signals | <input type="checkbox"/> EN50091-2 | EMC requirements for uninterruptible power systems (UPS) |

CE marking



(EC conformity marking)

**The manufacturer also declares the conformity of above mentioned product
with the actual required safety standards in accordance with LVD 73/23 EEC**

- | | | |
|-----------------------------------|---|-------------------------------------|
| <input type="checkbox"/> EN 60065 | Safety requirements for mains operated electronic and related apparatus for household and similar general use | <input type="checkbox"/> EN 60950 |
| <input type="checkbox"/> EN 60335 | Safety of household and similar electrical appliances | <input type="checkbox"/> EN 50091-1 |

Manufacturer/Importer

Date : Sep. 26, 2001

(Stamp)

Signature: Rex Lin
Name: Rex Lin