

SUPER  [®]

SUPER  [®] X7SBA

USER'S MANUAL

Revision 1.1

The information in this User's Manual has been carefully reviewed and is believed to be accurate. The vendor assumes no responsibility for any inaccuracies that may be contained in this document, makes no commitment to update or to keep current the information in this manual, or to notify any person or organization of the updates. **Please Note: For the most up-to-date version of this manual, please see our web site at www.supermicro.com.**

Super Micro Computer, Inc. ("Supermicro") reserves the right to make changes to the product described in this manual at any time and without notice. This product, including software, if any, and documentation may not, in whole or in part, be copied, photocopied, reproduced, translated or reduced to any medium or machine without prior written consent.

IN NO EVENT WILL SUPERMICRO BE LIABLE FOR DIRECT, INDIRECT, SPECIAL, INCIDENTAL, SPECULATIVE OR CONSEQUENTIAL DAMAGES ARISING FROM THE USE OR INABILITY TO USE THIS PRODUCT OR DOCUMENTATION, EVEN IF ADVISED OF THE POSSIBILITY OF SUCH DAMAGES. IN PARTICULAR, SUPERMICRO SHALL NOT HAVE LIABILITY FOR ANY HARDWARE, SOFTWARE, OR DATA STORED OR USED WITH THE PRODUCT, INCLUDING THE COSTS OF REPAIRING, REPLACING, INTEGRATING, INSTALLING OR RECOVERING SUCH HARDWARE, SOFTWARE, OR DATA.

Any disputes arising between manufacturer and customer shall be governed by the laws of Santa Clara County in the State of California, USA. The State of California, County of Santa Clara shall be the exclusive venue for the resolution of any such disputes. Supermicro's total liability for all claims will not exceed the price paid for the hardware product.

FCC Statement: This equipment has been tested and found to comply with the limits for a Class A digital device pursuant to Part 15 of the FCC Rules. These limits are designed to provide reasonable protection against harmful interference when the equipment is operated in a commercial environment. This equipment generates, uses, and can radiate radio frequency energy and, if not installed and used in accordance with the manufacturer's instruction manual, may cause harmful interference with radio communications. Operation of this equipment in a residential area is likely to cause harmful interference, in which case you will be required to correct the interference at your own expense.

California Best Management Practices Regulations for Perchlorate Materials: This Perchlorate warning applies only to products containing CR (Manganese Dioxide) Lithium coin cells. "Perchlorate Material-special handling may apply. See www.dtsc.ca.gov/hazardouswaste/perchlorate"

WARNING: Handling of lead solder materials used in this product may expose you to lead, a chemical known to the State of California to cause birth defects and other reproductive harm.

Manual Revision 1.1

Release Date: August 27, 2009

Unless you request and receive written permission from Super Micro Computer, Inc., you may not copy any part of this document.

Information in this document is subject to change without notice. Other products and companies referred to herein are trademarks or registered trademarks of their respective companies or mark holders.

Copyright © 2009 by Super Micro Computer, Inc.
All rights reserved.

Printed in the United States of America

Preface

About This Manual

This manual is written for system integrators, PC technicians and knowledgeable PC users. It provides information for the installation and use of the **SUPER**® X7SBA motherboard. The X7SBA supports a Quad-Core or a Dual-Core Intel® Xeon 3000 Series Processor at system bus speeds of 1333/1066/800 MHz. With the Intel® Xeon 3000 Series Processor and the 3210 Chipset built in, the X7SBA offers unprecedented energy efficiency performance and provides optimized low-power, 64-bit computing solutions for single/uni-processor (UP) systems based on the Intel Core™ microarchitecture. With support of the Intel Virtualization Technology, the Intel Extended Memory 64 Technology, and the Enhanced Intel Speedstep Technology, the X7SBA delivers server platforms that are reliable, easy-to-use, environmentally-friendly, and economical in TCO (Total Cost of Operations). Please refer to our web site (<http://www.supermicro.com/Products>) for updates or visit Intel's web site for processor support. This product is intended to be professionally installed and serviced by a technician.

Manual Organization

Chapter 1 describes the features, specifications and performance of the X7SBA mainboard and provides detailed information about the chipset.

Chapter 2 provides hardware installation instructions. Read this chapter when installing the processor, memory modules and other hardware components into the system. If you encounter any problems, see **Chapter 3**, which describes troubleshooting procedures for the video, the memory and the system setup.

Chapter 4 includes an introduction to BIOS and provides detailed information on running the CMOS Setup utility.

Appendix A provides BIOS POST Beep Codes.

Appendix B and **Appendix C** provide the Windows OS and other software installation instructions.

Conventions Used in the Manual

Special attention should be given to the following symbols for proper installation and to prevent damage done to the components or injury to yourself:



Warning: Important information given to ensure proper system installation or to prevent damage to the components.

Note: Additional Information given to differentiate various models or to ensure correct system setup.

Table of Contents

Preface

About This Manual	iii
Manual Organization	iii
Conventions Used in the Manual	iii

Chapter 1: Introduction

1-1 Overview	1-1
Checklist	1-1
Contacting Supermicro	1-2
SUPER X7SBA Image	1-3
SUPER X7SBA Layout	1-4
SUPER X7SBA Quick Reference	1-5
Motherboard Features	1-6
Chipset/System Block Diagram	1-8
1-2 Chipset Overview	1-9
1-3 PC Health Monitoring	1-10
1-4 Power Configuration Settings	1-10
1-5 ACPI Features	1-11
1-6 Power Supply	1-12

Chapter 2: Installation

2-1 Static-Sensitive Devices	2-1
2-2 Mounting the Motherboard in the Chassis	2-1
2-3 Processor and Heatsink Installation	2-2
2-4 Installing DDR 2 Memory	2-6
2-5 I/O Port/Front Control Panel Connector Locations	2-7
Back Panel Connectors/IO Ports	2-7
Front Control Panel	2-8
Front Control Panel Pin Definitions	2-9
NMI Button	2-9
Power LED	2-9
HDD LED	2-10
NIC1/NIC2 LED Indicators	2-10
OH/Fan Fail LED	2-11
Power Failure LED	2-11
Reset Button	2-12
Power Button	2-12

2-6	Connecting Cables	2-13
	ATX Power Connectors	2-13
	Processor Power Connector	2-13
	Overheat/Fan Failure	2-14
	Chassis Intrusion	2-14
	Alarm Reset	2-15
	Power LED	2-15
	Universal Serial Bus (USB)	2-16
	GLAN Ports	2-16
	ATX PS/2 Keyboard and PS/2 Mouse Ports	2-17
	Speaker Connector	2-17
	Fan Headers	2-18
	Wake-On-Ring	2-19
	Wake-On-LAN	2-19
	VGA Connector	2-20
	SMB_PS Connector	2-20
	T-SGPIO Headers	2-21
	Power Fault	2-21
2-7	Jumper Settings	2-22
	Explanation of Jumpers	2-22
	GLAN Enable/Disable	2-22
	Clear CMOS	2-23
	SMBus to PCI/PCI-Exp. Slots	2-23
	Watch Dog Enable	2-24
	VGA Enable	2-24
	USB Wake-Up	2-25
2-8	Onboard Indicators	2-26
	GLAN LED Indicators	2-26
	Onboard Power LED Indicator	2-26
2-9	Floppy Connector, SIMSO IPMI and Printer Connections	2-27
	Floppy Connector	2-27
	Parallel Connector	2-28
	SIMSO IPMI	2-28

Chapter 3: Troubleshooting

3-1	Troubleshooting Procedures	3-1
	Before Power On	3-1
	No Power	3-1
	No Video	3-1

Memory Errors.....	3-2
Losing the System's Setup Configuration	3-2
3-2 Technical Support Procedures	3-2
3-3 Frequently Asked Questions	3-3
3-4 Returning Merchandise for Service	3-4

Chapter 4: BIOS

4-1 Introduction	4-1
4-2 Running Setup	4-2
4-3 Main BIOS Setup	4-2
4-4 Advanced Setup	4-5
4-5 Security Setup	4-22
4-6 Boot Setup	4-24
4-7 Exit	4-25

Appendices:

Appendix A: BIOS POST Beep Codes	A-1
Appendix B: Installing the Windows OS	B-1
Appendix C: Other Software Installation Instructions	C-1

Chapter 1

Introduction

1-1 Overview

Checklist

Congratulations on purchasing your computer motherboard from an acknowledged leader in the industry. Supermicro boards are designed with the utmost attention to detail to provide you with the highest standards in quality and performance.

Please check that the following items have all been included with your motherboard. If anything listed here is damaged or missing, contact your retailer.

All the following items are included in the retail box only:

One (1) Supermicro Mainboard

One (1) floppy drive ribbon cable (CBL-022)

Six (6) SATA cables (CBL-044)

One (1) I/O shield (CSE-P0T7L)

One (1) Supermicro CD containing drivers and utilities

One (1) User's/BIOS Manual

Contacting Supermicro

Headquarters

Address: Super Micro Computer, Inc.
980 Rock Ave.
San Jose, CA 95131 U.S.A.

Tel: +1 (408) 503-8000

Fax: +1 (408) 503-8008

Email: marketing@supermicro.com (General Information)
support@supermicro.com (Technical Support)

Web Site: www.supermicro.com

Europe

Address: Super Micro Computer B.V.
Het Sterrenbeeld 28, 5215 ML
's-Hertogenbosch, The Netherlands

Tel: +31 (0) 73-6400390

Fax: +31 (0) 73-6416525

Email: sales@supermicro.nl (General Information)
support@supermicro.nl (Technical Support)
rma@supermicro.nl (Customer Support)

Asia-Pacific

Address: Super Micro, Inc.
4F, No. 232-1 Liancheng Road
Chung-Ho 235, Taipei Hsien, Taiwan, R.O.C.

Tel: +886-(2) 8226-3990

Fax: +886-(2) 8226-3991

Web Site: www.supermicro.com.tw

Technical Support:

Email: support@supermicro.com.tw

Tel: 886-2-8228-1366, ext.132 or 139

SUPER X7SBA Image



An Important Note to the User

- All images and graphics shown in this manual were based upon the latest PCB Revision available at the time of publishing. The motherboard you've received may or may not look exactly the same as the graphics shown in this manual.

Motherboard Layout

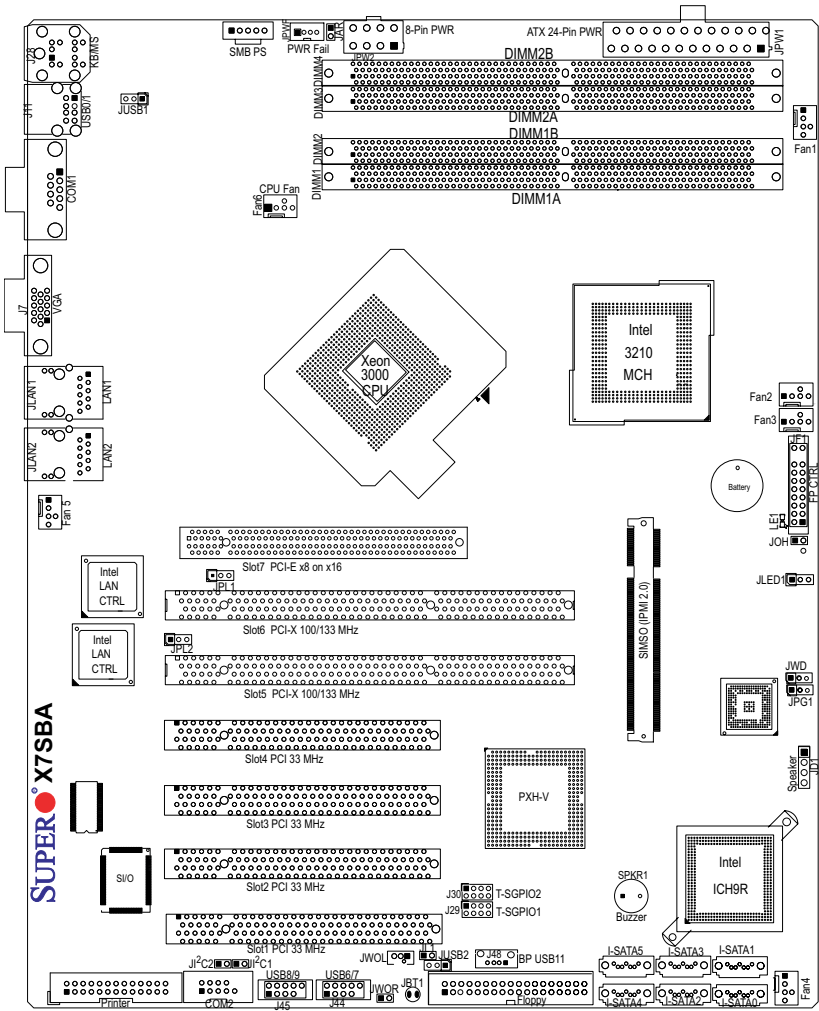

Important Notes to the User

- Jumpers not indicated are for testing only.
- See Chapter 2 for detailed information on jumpers, I/O ports and JF1 Front Panel Connections.
- "1" indicates the location of "Pin 1".
- When the LE1 LED is on, the 5V Standby PWR is on. Maker sure to turn off the power before installing or removing components.

X7SBA Quick Reference

Jumper	Description	Default Setting
JBT1	CMOS Clear	(See Chapter 2)
J1 ² C1/J1 ² C2	I ² C (SMB) Bus to PCI slots	(Open/Open: Disabled)
JPG1	Video Enable	Pins 1-2 (Enabled)
JPL1/JPL2	Giga-bit LAN 1/2 Enable	Pins 1-2 (Enabled)
JWD	Watch Dog Time-out	Pins 1-2 (Reset)
JPUSB1	Back Panel USB Wake Up	Pins 1-2 (Enabled)
JPUSB2	Front Panel USB Wake Up	Pins 2-3 (Disabled)

Connector	Description
Alarm Reset	Alarm Reset Connection (JAR)
COM1, COM2	COM Port 1 & COM 2 Header
Fans 1-6	System Fan Headers (Fans 1-5), Fan6: CPU Fan
Floppy Connector	Floppy Disk Connector
FP Control	Front Panel Control Header (JF1)
I-SATA0~I-SATA5	Intel SATA Headers #0~#5 (JS1-JS6)
JD1	Speaker Header (Pins 3-4: Internal Buzzer Enable, Pins 1-4: External Speaker Cable)
JL1	Chassis Intrusion Header
JLED1	Power LED Header
JOH	Overheat LED Header
JPW1	ATX 24-Pin Power Connector
JPW2	12V 8-pin Power Connector (Required)
JWOL	Wake On LAN Header
JWOR	Wake On Ring header
KB/Mouse	PS/2 Keyboard/Mouse Connector (J28)
LAN 1/LAN 2	Ethernet RJ45 (Gigabit LAN) Port1/Port2 Connectors
Power Fail	Power Failure Connector (JPWF)
Printer	Parallel Port (Printer) Header
SMB PS	Power Supply SMBus (I ² C)
SIMSO IPMI	SIMSO IPMI 2.0 Socket
SPKR1	Internal Buzzer
T-SGPIO 1/2	Serial General Purpose I/O Headers 1/2 (J29/J30)
USB 0/1	Backpanel USB Ports 0/1 (J11)
USB 6/7, 8/9	Front Panel USB headers #6/#7 (J44), #8/#9 (J45)
USB 11	Front Accessible USB Port 11 (JUSB48)
VGA	VGA Connector (J7)

LED Indicator	Description
LE 1	Onboard Standby PWR warning LED Indicator

Motherboard Features

CPU

- A Quad Core/Dual Core Intel Xeon 3000 Series Processor at a system bus speed of 1333/1066/800 MHz.
- EM64T, Enhanced Intel SpeedStep (EIST) supported

Using the EM64T Feature

- Install a 64-bit OS (Windows XP Professional x64 Ed, Server 2003x64 Ed.)
- Install the 64-bit drivers for all MB components, devices and add-on cards

OS Licensing Support

- Intel Quad Core/Dual Core CPU supports: Windows 2000 Professional, Windows Advanced Server, Windows XP Home, Windows XP Professional, Windows Server 2003 (Standard, Enterprise) and Windows Vista Operating Systems

Memory (Note: See Section 2-4 for details.)

- Four DIMM slots support Dual/Single Channel DDR2 800/667 MHz up to 8 GB of ECC Unbuffered DDR2 SDRAM.

Chipset

- Intel 3210
- Intel ICH9R
- Intel PXH-V

Expansion Slots

- Four (4) PCI 32-Bit/33 MHz (Slot 1~Slot 4)
- Two (2) PCI-X 64-Bit 100/133 MHz slot (Slot 5/Slot 6)
- One (1) PCI-Exp. x8 on x16 slot (Slot 7)

BIOS

- 16Mb Firmware Hub Phoenix BIOS
- APM 1.2, DMI 2.3, PCI 2.3, ACPI 1.0, Plug and Play (PnP), SMBIOS 2.3 and USB Keyboard support

PC Health Monitoring

- Onboard voltage monitors for CPU cores, Chipset Voltage, Memory Voltage, +1.8V,+3.3V, +3.3V Standby, +5V, +5V Standby, +12V, and -12V
- CPU 3-phase-switching voltage regulator
- Status monitor for fan speed & System OH/Fan Fail LED/Control
- Pulse Width Modulation Fan Control & Low noise fan speed control
- Environmental temperature monitoring via BIOS, PWR-Up from AC PWR loss
- Supero Doctor III, NMI
- System Resource alert via Supero Doctor III

ACPI Features

- Slow blinking LED for suspend state indicator
- Main switch override mechanism
- External modem ring-on

Onboard I/O

- Intel ICH9R SATA Controller, 6 connectors for 6 devices with support of RAID functions 0, 1, 5 and 10 (in the Windows OS environment)
- 1 floppy port interface (up to 2.88 MB)
- 1 Fast UART 16550 compatible serial port and 1 header
- 1 Parallel (Printer) Port
- Two Intel single-port 82573V and 82573L Gigabit Ethernet Controllers
- PS/2 mouse and PS/2 keyboard ports
- Up to 7 USB (Universal Serial Bus) 2.0 ports/headers
- VGA Connector
- Low Profile SIMSO IPMI 2.0
- Super I/O (Winbond 83627HF) with hardware monitoring
- XGI Z9S w/32 MB DDR2

Temperature

- Monitoring CPU, chassis environment
- CPU Thermal Trip support
- Thermal Monitor 2 (TM2) (available if supported by the CPU)

Other

- Wake-on-LAN (WOL)
- Wake-on-Ring (WOR)
- Onboard Standby PWR warning LED Indicator ("LE 1")

CD Utilities

- Drivers and software for Intel 3210 chipset utilities

Dimensions

- 12" (L) x 9.5" (W) (304.8 mm x241.30 mm)

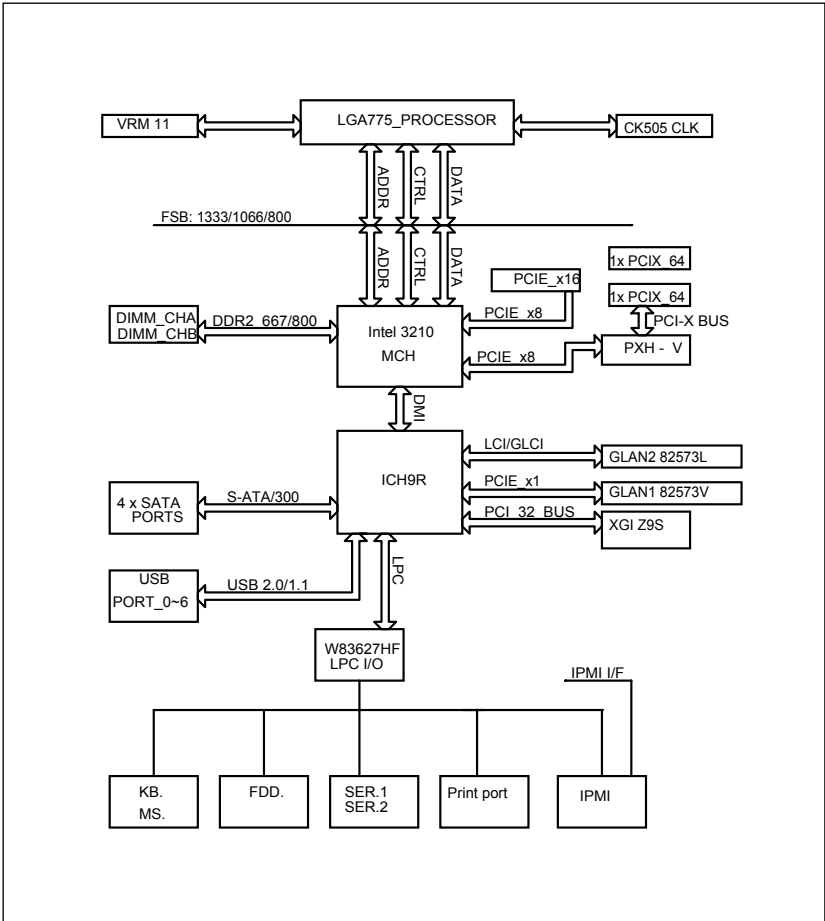

**The Intel 3210 Chipset:
System Block Diagram**

Note: This is a general block diagram and may not exactly represent the features on your motherboard. See the following pages for the actual specifications of the motherboard.

1-2 Chipset Overview

The Intel 3210 chipset, designed for use with the Quad Core/Dual Core Intel® Xeon 3000 Series Processor, is comprised of two primary components: the Memory Controller Hub (MCH) and the I/O Controller Hub ICH9R. In addition, the PXH-V chip is used for added functionality. The X7SBA provides the performance and feature-set required for cost-effective, power-efficient UP system platforms.

Memory Controller Hub (MCH)

The function of the MCH is to manage the data flow between four interfaces: the CPU interface, the DDR2 System Memory Interface, the PCI Express Interface (Note Below), and the Direct Media Interface (DMI).

The MCH is optimized for a Quad Core/Dual Core Xeon 3000 series processor in the LGA775 Land Grid Array Package with a FSB frequency of 1333/1066/800 MHz. The 3210 MCH supports 36-bit host bus addressing, allowing the CPU to access to the entire 64 GB of the host address space. It also has a 12-deep In-Order Queue to support up to 12 outstanding pipelined address request on the host bus. It supports one or two channels of DDR2 SDRAM. The 3210 platform uses the ninth generation I/O Controller Hub (ICH9R) to provide I/O related functions.

The Ninth Generation I/O Controller Hub (ICH9R)

The I/O Controller ICH9R provides the data buffering and interface arbitration required for the system to operate efficiently. It also provides the bandwidth needed for the system to maintain its peak performance. The Direct Media Interface (DMI) provides the connection between the MCH and the ICH9R. The ICH9R supports up to two PCI-Express x8 slots, six Serial ATA ports and eight USB 2.0 ports. In addition, the ICH9R offers the Intel Matrix Storage Technology which provides various RAID options for data protection and rapid data access. It also supports the next generation of client management through the use of PROActive technology in conjunction with Intel's next generation Gigabit Ethernet controller.

Intel ICH9R System Features

The I/O Controller Hub provides the I/O subsystem with access to the rest of the system. Functions and capabilities include:

Advanced Power Management

SMBus 2.0 (I²C)

SST/PECI Fan Speed Control

SPI Flash

Low Pin Count (LPC) Interface

Note: The Intel 3210 chipset does not support add-in graphics cards in the PCI-E interface provided by the Memory Controller Hub (MCH).

1-3 PC Health Monitoring

This section describes the PC health monitoring features of the X7SBA. The motherboard has an onboard System Hardware Monitor chip that supports PC health monitoring.

Onboard Voltage Monitors

The onboard voltage monitor will scan the voltages for the CPU Cores, Chipset Voltage, Memory Voltage, +1.8V, +3.3V, +3.3V Standby, +5V, +5V Standby, +12V, and -12V continuously (via SuperO Doctor III). Once a voltage becomes unstable, it will give a warning or send an error message to the screen. The user can adjust the voltage thresholds to define the sensitivity of the voltage monitor.

Fan Status Monitor with Firmware Speed Control

The PC health monitor can check the RPM status of the cooling fans. The onboard fans are controlled by Thermal Management via Hardware Monitoring in the BIOS.

CPU Overheat/Fan Fail LED and Control

This feature is available when the user enables the CPU overheat warning function in the BIOS. This allows the user to define an overheat temperature. When the temperature reaches the predefined threshold, the CPU thermal trip feature will be activated and it will send a signal to the Speaker LED and, at the same time, the CPU speed will be decreased. It will also activate the alarm if a fan failure occurs.

Recovery from AC Power Loss

BIOS provides a setting for you to determine how the system will respond when AC power is lost and then restored to the system. You can choose for the system to remain powered off (in which case you must hit the power switch to turn it back on) or for it to automatically return to a power on state. See the Power Lost Control setting in the BIOS chapter to change this setting. The default setting is **Last State**.

1-4 Power Configuration Settings

This section describes features of your motherboard that deal with power and power settings.

Slow Blinking LED for Suspend-State Indicator

When the CPU goes into a suspend state, the chassis power LED will start blinking to indicate that the CPU is in suspend mode. When the user presses any key, the CPU will wake-up and the LED will automatically stop blinking and remain on.

BIOS Support for USB Keyboard

If the USB keyboard is the only keyboard in the system, this keyboard will function like a normal keyboard during system boot-up.

Main Switch Override Mechanism

When an ATX power supply is used, the power button can function as a system suspend button. When the user presses the power button, the system will enter a SoftOff state. The monitor will be suspended and the hard drive will spin down. Pressing the power button again will cause the whole system to wake-up. During the SoftOff state, the ATX power supply provides power to keep the required circuitry in the system "alive". In case the system malfunctions, and you want to turn off the power, just press and hold the power button for 4 seconds. The power will turn off and no power will be provided to the motherboard.

Wake Ring-On (WOR)

Wake-up events can be triggered by a device such as the external modem ringing when the system is in the SoftOff state. Note that external modem ring-on can only be used with an ATX 2.01 (or above) compliant power supply.

Wake-On-LAN (WOL)

Wake-On-LAN is defined as the ability of a management application to remotely power up a computer that is powered off. Remote PC setup, up-dates and asset tracking can occur after hours and on weekends so that daily LAN traffic is kept to a minimum and users are not interrupted. The motherboard has a 3-pin header (WOL) to connect to the 3-pin header on a Network Interface Card (NIC) that has WOL capability. In addition, an onboard LAN controller can also support WOL without any connection to the WOL header. The 3-pin WOL header is to be used with a LAN add-on card only.

Note: Wake-On-LAN requires an ATX 2.01 (or above) compliant power supply.

1-5 ACPI Features

ACPI stands for Advanced Configuration and Power Interface. The ACPI specification defines a flexible and abstract hardware interface that provides a standard way to integrate power management features throughout a PC system, including its hardware, operating system and application software. This enables the system to automatically turn on and off peripherals such as CD-ROMs, network cards, hard disk drives and printers. This also includes consumer devices connected to the PC such as VCRs, TVs, telephones and stereos.

In addition to enabling operating system-directed power management, ACPI provides a generic system event mechanism for Plug and Play and an operating system-independent interface for configuration control. ACPI leverages the Plug

and Play BIOS data structures while providing a processor architecture-independent implementation that is compatible with both Windows and Linux Operating Systems.

1-6 Power Supply

As with all computer products, a stable power source is necessary for proper and reliable operation. It is even more important for processors that have high CPU clock rates of 1 GHz and faster.

The **SUPER** X7SBA accommodates 12V ATX power supplies. Although most power supplies generally meet the specifications required by the CPU, some are inadequate. A 2 amps of current supply on a 5V Standby rail is strongly recommended.

The X7SBA accommodates ATX power supplies. It is strongly recommended that you use a high quality power supply that meets ATX power supply Specification 2.02 or above. You should use one that will supply at least 350W of power. Also your power supply must supply 1.5A for the Ethernet ports. It must also be SSI compliant (info at <http://www.ssiforum.org/>). Additionally, in areas where noisy power transmission is present, you may choose to install a line filter to shield the computer from noise. It is recommended that you also install a power surge protector to help avoid problems caused by power surges.

Chapter 2

Installation

2-1 Static-Sensitive Devices

Electrostatic-Discharge (ESD) can damage electronic components. To prevent damage to your system board, it is important to handle it very carefully. The following measures are generally sufficient to protect your equipment from ESD.

Precautions

- Use a grounded wrist strap designed to prevent static discharge. Touch a grounded metal object before removing the board from the antistatic bag.
- Handle the board by its edges only; do not touch its components, peripheral chips, memory modules or gold contacts. When handling chips or modules, avoid touching their pins.
- Put the motherboard and peripherals back into their antistatic bags when not in use.
- For grounding purposes, make sure your computer chassis provides excellent conductivity between the power supply, the case, the mounting fasteners and the motherboard.
- Use only the correct type of onboard CMOS battery. Do not install the onboard upside down battery to avoid possible explosion.

Unpacking

The motherboard is shipped in antistatic packaging to avoid static damage. When unpacking the board, make sure the person handling it is static protected.

2-2 Mounting the Motherboard in the Chassis

All motherboards have standard mounting holes to fit different types of chassis. Make sure that the locations of all the mounting holes for both the motherboard and the chassis match. Although a chassis may have both plastic and metal mounting fasteners, metal ones are highly recommended because they ground the motherboard to the chassis. Make sure that the metal standoffs click in or are screwed in tightly. Then use a screwdriver to secure the motherboard onto the motherboard tray. To avoid damaging the motherboard and its components, please do not use a force greater than 8 lb/inch on each mounting screw during motherboard installation.

Note: Some components are very close to the mounting holes. Please take all necessary precautionary measures to prevent damage done to these components when installing the motherboard into the chassis.

2-3 Processor and Heatsink Installation



When handling the processor package, avoid placing direct pressure on the label area of the fan.

Notes:

1. Always connect the power cord last and always remove it before adding, removing or changing any hardware components. Make sure that you install the processor into the CPU socket before you install the CPU heatsink.
2. Intel's boxed LGA 775 package contains the CPU fan and heatsink assembly. If you buy a CPU separately, make sure that you use only Intel-certified multi-directional heatsink and fan.
3. The Intel LGA 775 heatsink and fan comes with a push-pin design and no tool is needed for installation. (Refer to Note 7 below.)
4. Make sure to install the motherboard into the chassis before you install the CPU heatsink and fan. (Refer to Note 7 below.)
5. When purchasing an LGA 775 CPU or when receiving a motherboard with an LGA 775 CPU pre-installed, make sure that the CPU plastic cap is in place and none of the CPU pins are bent; otherwise, contact the retailer immediately.
6. Refer to the MB Features Section for more details on CPU support.
7. When the X7SBA motherboard is installed in a server, please use the SNK-P0016/SNK-P0016P Passive Heatsink only.

Installation Procedures

For proper system setup, please follow the procedure below:

1. Install the heatsink backplate into the chassis if needed.
2. Install the motherboard into the chassis.
3. Install the CPU onto the motherboard.
4. Install the heatsink or/and cooling fans (if any).
5. Connect fan and power cables (if any).

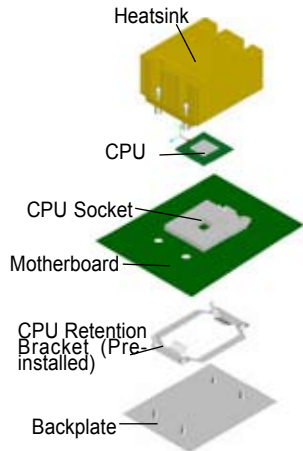

Installation of the LGA775 Processor

1. Press the socket lever to release the load plate, which covers the CPU socket, from its locking position.

Socket Lever

Load Plate

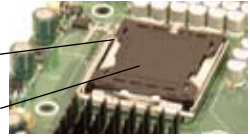

2. Gently lift the socket lever to open the load plate.



3. Locate Pin 1 on the CPU socket.

Note: Pin 1 is the corner marked with a triangle. Please Note that the North Key and the South Key are located vertically in the CPU housing.



Load Plate



4. Position the motherboard in such a way that Pin 1 of the CPU socket is located at the left bottom of the CPU housing.

North Key

Pin 1

South Key

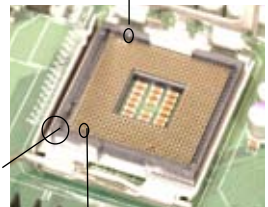

5. Use your thumb and your index finger to hold the CPU at the North Center Edge and the South Center Edge of the CPU.

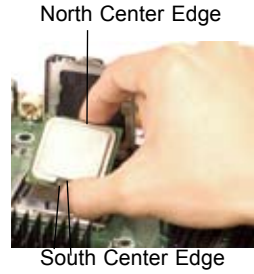

6. Align Pin 1 of the CPU with Pin 1 of the socket. Once aligned, carefully lower the CPU straight down to the socket. (Do not drop the CPU on the socket. Do not move the CPU horizontally or vertically. Do not rub the CPU against the surface or against any pins of the socket to avoid damage to the CPU or the socket.)

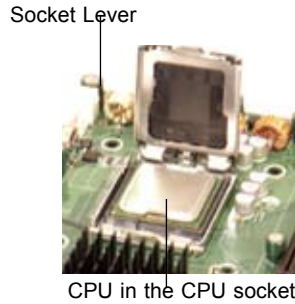

7. With the CPU inside the socket, inspect the four corners of the CPU to make sure that the CPU is properly installed.

8. Use your thumb to gently push the lever down and lock it in the hook.



9. If the CPU is properly installed into the socket, the plastic cap will be automatically released from the load plate when the lever is pushed into the hook. Remove the plastic cap from the motherboard.



Plastic cap is released from the load plate if CPU properly installed.

 **Warning:** Please keep the plastic cap. The motherboard and the CPU must be shipped with the plastic cap properly installed to protect the CPU pins. Shipment without the CPU plastic cap properly installed will void the warranty.

Installation and Removal of the Heatsink

Installing a Passive Heatsink

1. Do not apply any thermal grease to the heatsink or the CPU die; the required amount has already been applied.
2. Place the heatsink on top of the CPU so that the four mounting holes are aligned with those on the retention mechanism.
3. Screw in two diagonal screws (ie the #1 and the #2 screws) until just snug (-do not over-tighten the screws to avoid possible damage to the CPU.)
4. Finish the installation by fully tightening all four screws.

Passive Heatsink

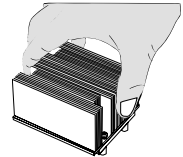
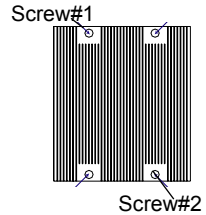
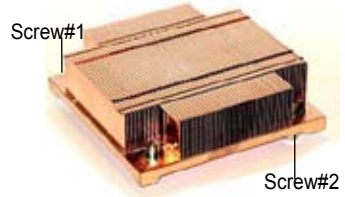

To Un-install a Passive Heatsink



Warning: We do not recommend that the CPU or the heatsink be removed. However, if you do need to uninstall the heatsink, please follow the instructions below to uninstall the heatsink to prevent damage done to the CPU or the CPU socket.

1. Unscrew and remove the heatsink screws from the motherboard in the sequence as show in the picture on the right.
2. Hold the heatsink as shown in the picture on the right and gently wriggle the heatsink to loosen it from the CPU. (Do not use excessive force when wriggling the heatsink.)
3. Once the CPU is loosened, remove the heatsink from the CPU socket.
4. Clean the surface of the CPU and the heatsink to get rid of the old thermal grease. Reapply the proper amount of thermal grease on the surface before you re-install the CPU and the heatsink.

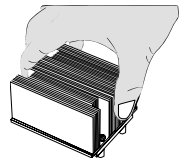
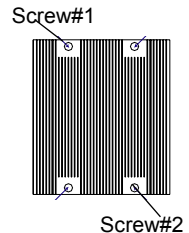

2-4 Installing DDR2 Memory

Memory Module Installation (See Figure 2-1)



Exercise extreme care when installing or removing memory modules to prevent any possible damage.

Support

The X7SBA supports up to 8 GB of Dual channel, unbuffered ECC DDR2 800/667 SDRAM in 4 DIMM slots. Both interleaved and non-interleaved memory are supported, so you may populate any number of DIMM slots.

Note: Populating DIMM#1A, DIMM#2A, and/or DIMM#1B, DIMM#2B with memory modules of the same size and of the same type will result in dual channel, two-way interleaved memory which is faster than the single channel, non-interleaved memory. When ECC memory is used, it may take 25-40 seconds for the VGA to display.

Notes:

1. Due to chipset limitation, 8GB Memory can only be supported by the following operating systems: 32-Bit: Windows 2000 Advanced Server/2003 Enterprise; 64-Bit: Windows Server 2003 Standard/Enterprise/Windows XP Professional x64 Edition.
2. Some old-version of DDR2-667 may not match Intel's On-Die-Temperature requirement and will automatically be down-graded to run @ 533 MHz, If this occurs, contact your memory vendor to check the ODT value.
3. Due to memory allocation to system devices, memory remaining available for operational use will be reduced when 4 GB of RAM is used. The reduction in memory availability is disproportional. (Refer to the Table below.)

System Device	Size	Physical Memory Remaining (-Available) (4 GB Total System Memory)
Firmware Hub flash memory (System BIOS)	1 MB	3.99
Local APIC	4 KB	3.99
Area Reserved for the chipset	2 MB	3.99
I/O APIC (4 Kbytes)	4 KB	3.99
PCI Enumeration Area 1	256 MB	3.76
PCI Express (256 MB)	256 MB	3.51
PCI Enumeration Area 2 (if needed) -Aligned on 256-MB boundary-	512 MB	3.01
VGA Memory	16 MB	2.85
TSEG	1 MB	2.84
Memory available to OS and other applications		2.84

Note to Microsoft Users:

Microsoft implemented a design change in Windows XP with Service Pack 2 (SP2) and Windows Vista. This change is specific to the Physical Address Extension (PAE) mode behavior which improves driver compatibility. For more information, please read the following article at Microsoft's Knowledge Base website at: <http://support.microsoft.com/kb/888137>.

Figure 2-1. Installing DIMM into Slot

To Install:
Insert module vertically and press it down until it snaps into place. Pay attention to the notch.

To Remove:
Use your thumbs to gently push each release tab outward to release the DIMM from the slot.

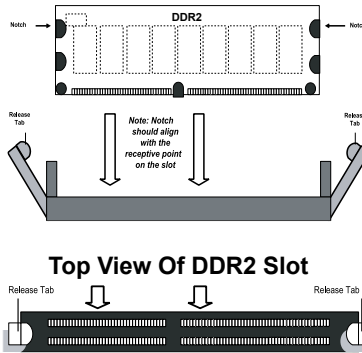

2-5 Control Panel Connectors/IO Ports

The I/O ports are color coded in conformance with the PC 99 specification. See Figure 2-2 below for the colors and locations of the various I/O ports.

Back Panel Connectors/IO Ports

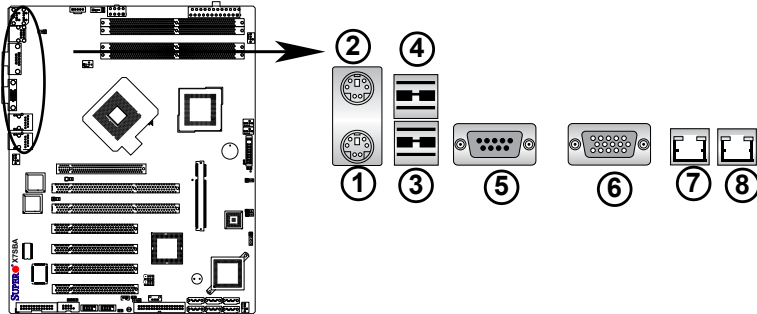

Figure 2-2. Back Panel I/O Port Locations and Definitions

Back Panel Connectors

1. Keyboard (Purple)
2. PS/2 Mouse (Green)
3. Back Panel USB Port 0
4. Back Panel USB Port 1
5. COM Port 1 (Turquoise)
6. VGA Port (Blue)
7. Gigabit LAN 1
8. Gigabit LAN 2

(See Section 2-5 for details.)

Front Control Panel

JF1 contains header pins for various buttons and indicators that are normally located on a control panel at the front of the chassis. These connectors are designed specifically for use with Supermicro server chassis. See Figure 2-4 for the descriptions of the various control panel buttons and LED indicators. Refer to the following section for descriptions and pin definitions.

JF1 Header Pins

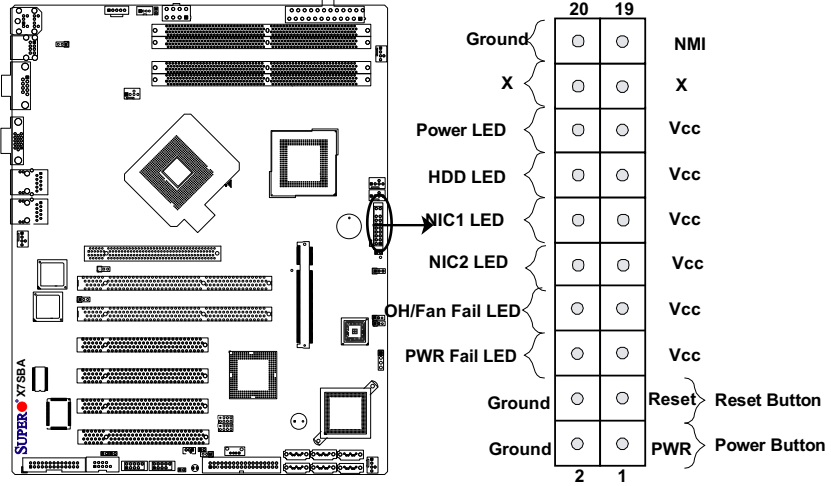

Front Control Panel Pin Definitions

NMI Button

The non-maskable interrupt button header is located on pins 19 and 20 of JF1. Refer to the table on the right for pin definitions.

NMI Button Pin Definitions (JF1)	
Pin#	Definition
19	Control
20	Ground

Power LED

The Power LED connection is located on pins 15 and 16 of JF1. Refer to the table on the right for pin definitions.

Power LED Pin Definitions (JF1)	
Pin#	Definition
15	+5V
16	Ground

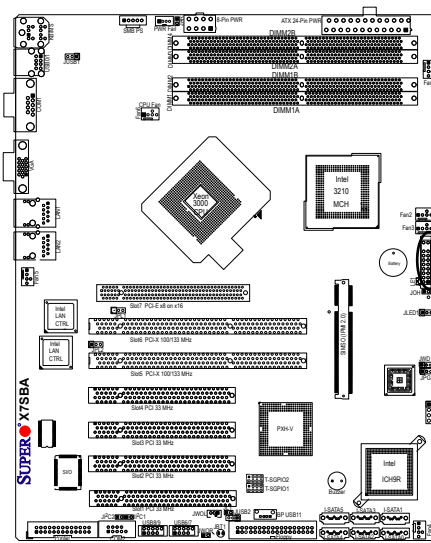

A. NMI

B. PWR LED

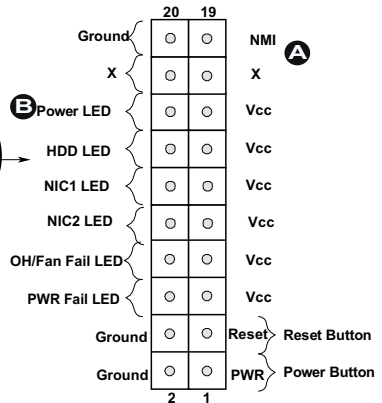

HDD LED

The HDD LED connection is located on pins 13 and 14 of JF1. Attach a hard drive LED cable here to display disk activities (for any hard drives on the system, including Serial ATA and IDE). See the table on the right for pin definitions.

HDD LED Pin Definitions (JF1)	
Pin#	Definition
13	+5V
14	HD Active

NIC1/NIC2 LED Indicators

The NIC (Network Interface Controller) LED connection for GLAN port1 is located on pins 11 and 12 of JF1 and the LED connection for GLAN Port2 is on Pins 9 and 10. Attach the NIC LED cables to display network activity status. Refer to the table on the right for pin definitions.

GLAN1/2 LED Pin Definitions (JF1)	
Pin#	Definition
9/11	Vcc
10/12	Ground

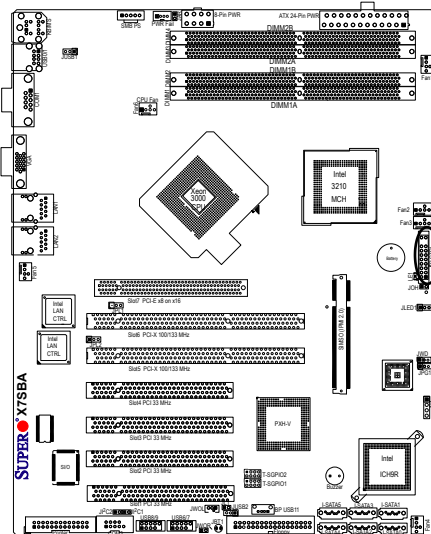

- A. HDD LED
- B. NIC1 LED
- C. NIC2 LED

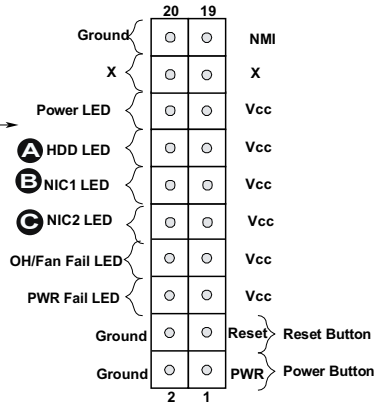

Overheat/Fan Fail LED (OH)

Connect an LED cable to the OH/Fan Fail connection on pins 7 and 8 of JF1 to provide advanced warnings of chassis overheating or fan failure. Refer to the table on the right for pin definitions.

OH/Fan Fail LED Pin Definitions (JF1)	
Pin#	Definition
7	Vcc
8	Ground

OH/Fan Fail Indicator Status	
State	Definition
Off	Normal
On	Overheat
Flashing	Fan Fail

Power Failure LED

The Power Failure LED connection is located on pins 5 and 6 of JF1. Refer to the table on the right for pin definitions.

PWR Fail LED Pin Definitions (JF1)	
Pin#	Definition
5	Vcc
6	Ground

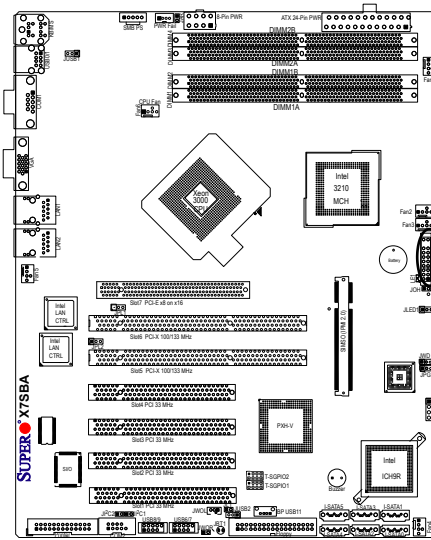

A. OH/Fan Fail LED

B. PWR Supply Fail

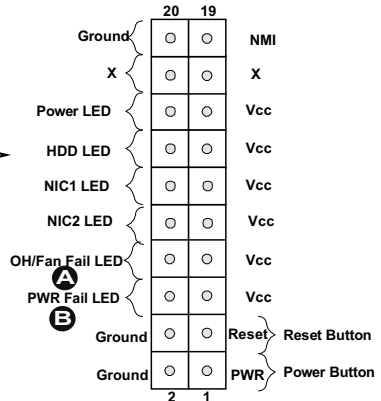

Reset Button

The Reset Button connection is located on pins 3 and 4 of JF1. Attach it to the hardware reset switch on the computer case. Refer to the table on the right for pin definitions.

Reset Button Pin Definitions (JF1)	
Pin#	Definition
3	Reset
4	Ground

Power Button

The Power Button connection is located on pins 1 and 2 of JF1. Momentarily contacting both pins will power on/off the system. This button can also be configured to function as a suspend button (with a setting in the BIOS - see Chapter 4). To turn off the power when set to suspend mode, press the button for at least 4 seconds. Refer to the table on the right for pin definitions.

Power Button Pin Definitions (JF1)	
Pin#	Definition
1	Signal
2	+3V Standby

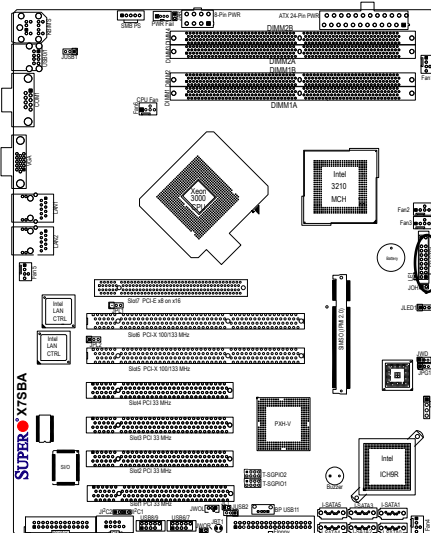

A. Reset Button

B. PWR Button

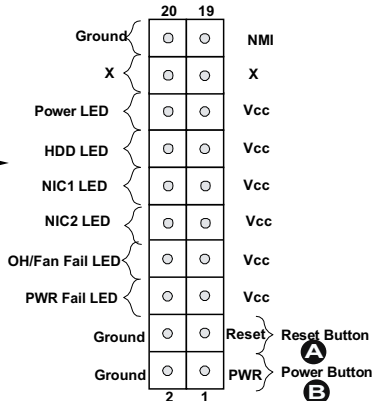

2-6 Connecting Cables

ATX Power Connector

The main power supply connector (JPW1) on the X7SBA meets the SSI (Superset ATX) specification. You can only use a 24-pin power supply cable on the motherboard. Make sure that the orientation of the connector is correct. You must also use the 8-pin (JPW2) processor power connector for adequate power supply to the system. See the table on the right for pin definitions.

ATX Power 24-pin Connector Pin Definitions			
Pin#	Definition	Pin #	Definition
13	+3.3V	1	+3.3V
14	-12V	2	+3.3V
15	COM	3	COM
16	PS_ON	4	+5V
17	COM	5	COM
18	COM	6	+5V
19	COM	7	COM
20	Res (NC)	8	PWR_OK
21	+5V	9	5VSB
22	+5V	10	+12V
23	+5V	11	+12V
24	COM	12	+3.3V

Processor Power Connector

In addition to the Primary ATX power connector (above), the 12V 8-pin Processor connector at JPW2 must also be connected to your power supply to provide adequate power supply to the system.

Secondary Power Connector Pin Definitions	
Pins	Definition
1 through 4	Ground
5 through 8	+12V

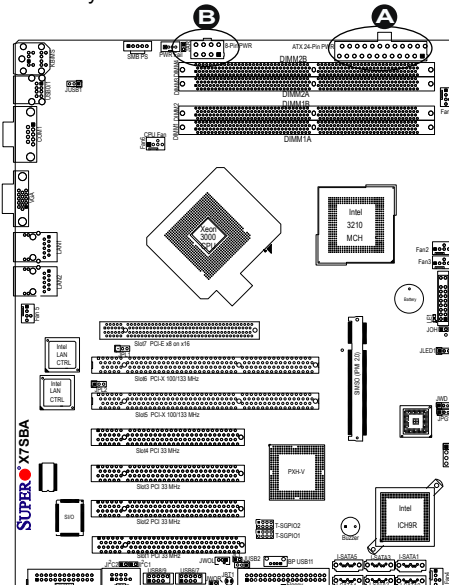

A. 24-Pin ATX PWR

B. 8-Pin 12V PWR

Overheat LED/Fan Failure

The JOH header is used to connect an LED to indicate chassis overheating. This LED blinks when there is a fan failure. Refer to the table on right for pin definitions.

Overheat LED Pin Definitions	
Pin#	Definition
1	5VDC
2	OH Active

OH/Fan Fail LED	
State	Message
Solid	Overheat
Blinking	Fan Fail

Chassis Intrusion

A Chassis Intrusion header is located at JL1. Attach the appropriate cable to inform you of a chassis intrusion.

Chassis Intrusion Pin Definitions (JL1)	
Pin#	Definition
1	Intrusion Input
2	Ground

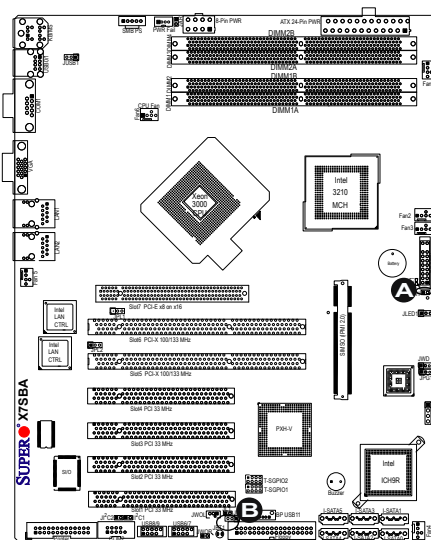

A. Overheat LED/Fan Failure

B. Chassis Intrusion

Alarm Reset

If three power supplies are installed and Alarm Reset (JAR) is enabled, the system will notify you when any of the three power modules fails. Connect JAR to a micro-switch to turn off the alarm that is activated when a power module fails. See the table on the right for pin definitions.

Alarm Reset	
Pin Setting	Definition
Pin 1	Ground
Pin 2	+5V

Power LED

The Power LED connector is designated JLED1. When this LED is on, it indicates that power is being supplied to the system. See the table on the right for pin definitions.

PWR LED Pin Definitions	
Pin#	Definition
1	+5V
2	Key
3	Ground

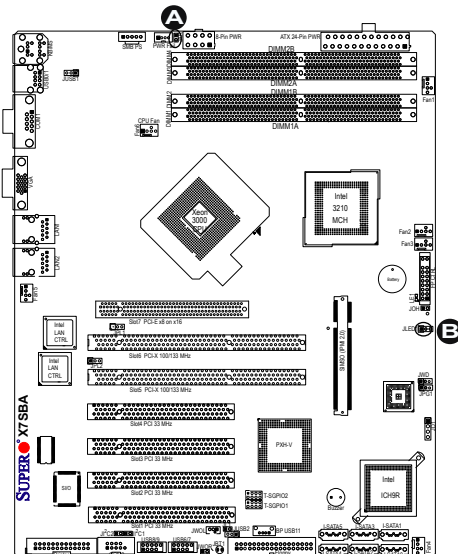

A. Alarm Reset

B. PWR LED

Universal Serial Bus (USB)

Two Back Panel Universal Serial Bus ports: USB0 and USB1 are located at J11 on the I/O back panel. USB Ports #6/7 (J44), and USB Ports 8/9 (J45) are designated Front Panel USB Headers. In addition, USB 11 (JUSB48) can also be used to provide front USB access. See the tables on the right for pin definitions.

Back Panel USB (USB0/1)	
Pin#	Definitions
1	+5V
2	PO-
3	PO+
4	Ground
5	N/A

Front Panel USB (USB11)	
Pin#	Definition
1	Vcc
2	PO-
3	PO+
4	Ground
5	Key

Front-Accessible USB Headers Pin Definitions (USB 6/7/8/9)			
Pin #	Definition	Pin #	Definition
1	+5V	1	+5V
2	PO-	2	PO-
3	PO+	3	PO+
4	Ground	4	Ground
5	N/A	5	Key

GLAN (Giga-bit Ethernet Ports)

Two G-bit Ethernet ports (GLAN) are located next to the VGA port on the IO backplane. These ports accept RJ45 type cables.

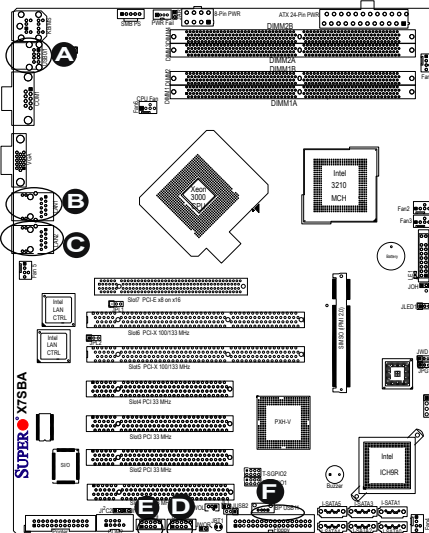

- A. (BP) USB 0/1
- B. GLAN1
- C. GLAN2
- D. (FP) USB 6/7
- E. FP USB 8/9
- F. USB 11

ATX PS/2 Keyboard and Mouse Ports

The ATX PS/2 keyboard and PS/2 mouse are located at J28 on the Back Panel USB ports on the motherboard. See the table at right for pin definitions.

PS/2 Keyboard and Mouse Port Pin Definitions	
Pin#	Definition
1	Data
2	NC
3	Ground
4	VCC
5	Clock
6	NC

Note: NC=No connection.

Speaker Connector

The speaker connector, located at JD1, allows you to choose between using the internal or an external speaker. For the internal speaker, short pins 3 and 4. To use an external speaker, place the speaker cable header on all four pins. See the table on the right.

Speaker Connector	
Pin Setting	Definition
Pins 3-4	Internal Speaker
Pins 1-4	External Speaker

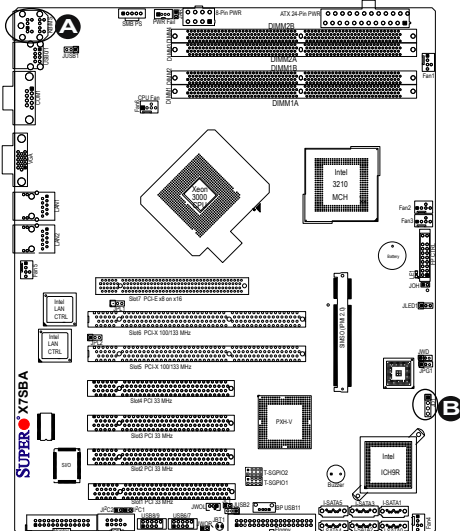

A. KB/Mouse

B. Speaker Connector

Fan Headers

The X7SBA has six fan connections (Fan1 to Fan6). Fan6 is designated the CPU Cooling Fan. **Note:** all these fans are 4-pin fans. However, Pins 1-3 of the fan headers are backward compatible with the traditional 3-pin fans. The onboard fan speeds are controlled by Thermal Management under Hardware Monitoring in the BIOS. When using Thermal Management settings, please use all 3-pin fans or all 4-pin fans on the motherboard. Please do not use 3-pin fans and 4-pin fans on the same board. The default setting is "Disabled" which will allow the onboard fans to run at full speed. See the table on the right for pin definitions.

Fan Header Pin Definitions	
Pin#	Definition
1	Ground (Black)
2	+12V (Red)
3	Tachometer
4	PWM_Control

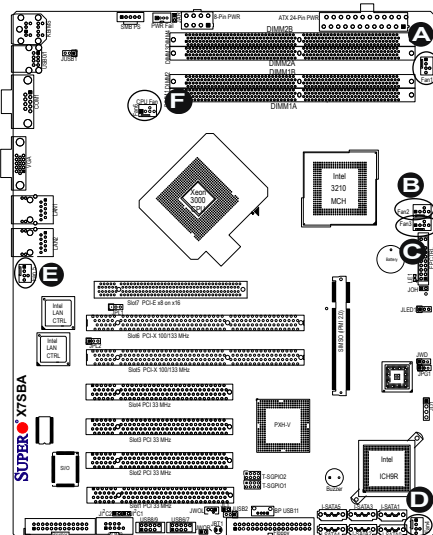

- A. Fan 1
- B. Fan 2
- C. Fan 3
- D. Fan 4
- E. Fan 5
- F. Fan 6 (CPU Fan)

Wake-On-Ring

The Wake-On-Ring header is located at JWOR. This function allows your computer to be "awakened" by an incoming call to the modem when in suspend state. See the table on the right for pin definitions. You must have a Wake-On-Ring card and cable to use this feature.

Wake-On-Ring Pin Definitions (JWOR)	
Pin#	Definition
1	Ground (Black)
2	Wake-up

Wake-On-LAN

The Wake-On-LAN header is located at WOL. See the table on the right for pin definitions. You must enable the LAN Wake-Up function in the BIOS and have a LAN card with a Wake-on-LAN connector and cable to use this feature.

Wake-On-LAN Pin Definitions (WOL)	
Pin#	Definition
1	+5V Standby
2	Ground
3	Wake-up

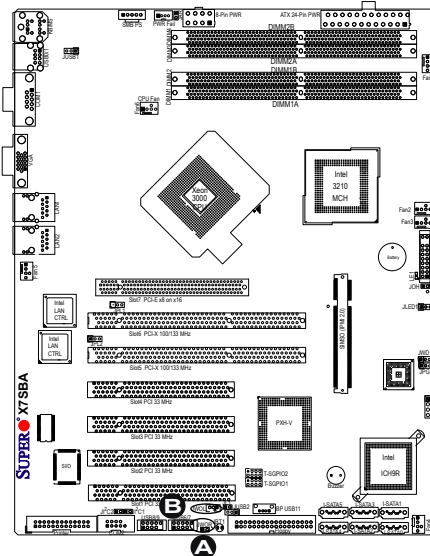

A. WOR

B. WOL

VGA Connector

A VGA connector (J7) is located next to the COM1 port on the IO backplane. Refer to the board layout below for the location.

SMB_PS (I²C) Connector

SMB_Power Supply (I²C) Connector monitors onboard power supply, fan and system temperature conditions. See the table on the right for pin definitions.

PWR SMB Pin Definitions	
Pin#	Definition
1	Clock
2	Data
3	PWR Fail
4	Ground
5	+3.3V

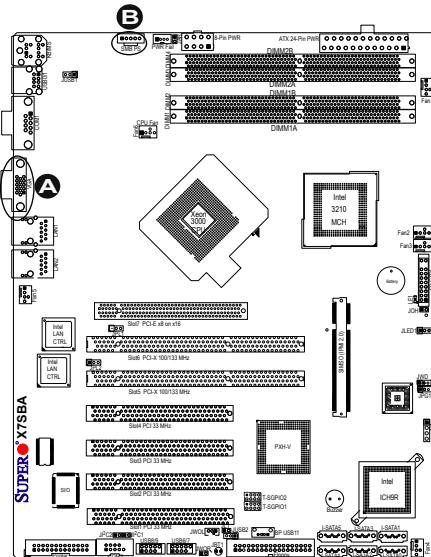

A. VGA

B. SMB Ps

T-SGPIO Headers

Two SGPIO (Serial General Purpose Input/Output) headers are located at J29 and J30 on the motherboard. These headers provide serial link interfacing connections for the onboard SATA connectors. See the table on the right for pin definitions. Refer to the board layout below for the location.

SGPIO Pin Definitions			
Pin#	Definition	Pin	Definition
1	NC	2	NC
3	Ground	4	DATA Out
5	Load	6	Ground
7	Clock	8	NC

Note: NC= No Connections

Power Fault (PWR Supply Failure)

Connect a cable from your power supply to the Power Fail header (JPWF) to provide warnings of power supply failure. This warning signal is passed through the PWR_LED pin to indicate of a power failure on the chassis. See the table on the right for pin definitions.

PWR Supply Fail LED Pin Definitions	
Pin#	Definition
1	PWR 1: Fail
2	PWR 2: Fail
3	PWR 3: Fail
4	Signal: Alarm Reset

Note: This feature is only available when using Supermicro redundant power supplies.

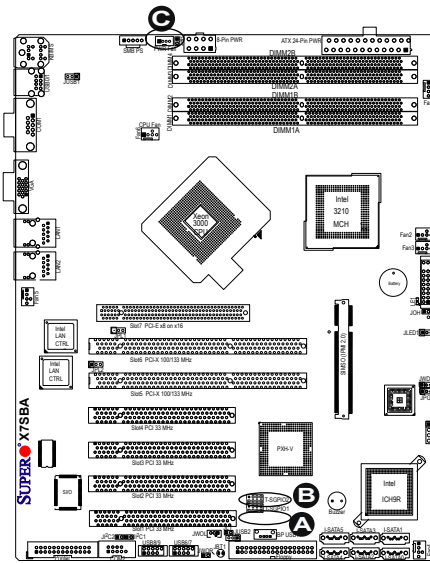

A. T-SGPIO1

B. T-SGPIO2

C. PWR Fault

2-7 Jumper Settings

Explanation of Jumpers

To modify the operation of the motherboard, jumpers can be used to choose between optional settings. Jumpers create shorts between two pins to change the function of the connector. Pin 1 is identified with a square solder pad on the printed circuit board. See the motherboard layout pages for jumper locations.

Note: On two pin jumpers, "Closed" means the jumper is on and "Open" means the jumper is off the pins.

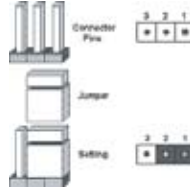

GLAN Enable/Disable

JPL1 enables or disables GLAN 1 Port, and JPL2 enables or disables GLAN 2 Port on the motherboard. See the table on the right for jumper settings. The default setting is **Enabled**.

GLAN 1/2 Enable Jumper Settings	
Jumper Setting	Definition
1-2	Enabled
2-3	Disabled

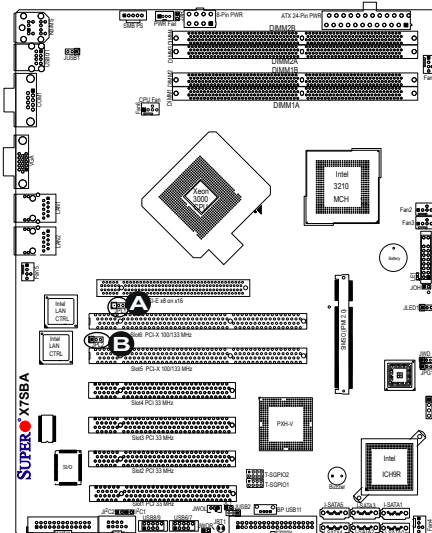

A. GLAN1 Enable

B. GLAN2 Enable

CMOS Clear

JBT1 is used to clear CMOS. Instead of pins, this "jumper" consists of contact pads to prevent accidental clearing of CMOS. To clear CMOS, use a metal object such as a small screwdriver to touch both pads at the same time to short the connection. Always remove the AC power cord from the system before clearing CMOS.

Note: For an ATX power supply, you must completely shut down the system, remove the AC power cord and then short JBT1 to clear CMOS.



SMBus to PCI/PCI-Exp. Slots

Jumpers J1²C1 and J1²C2 allow you to connect PCI/PCI-E slots to the System Management Bus. The default setting is "Open" to disable the connection. See the table on the right for jumper settings.

**SMBus to PCI/PCI-Exp
Jumper Settings**

Jumper Setting	Definition
Closed	Enabled
Open	Disabled (Default)

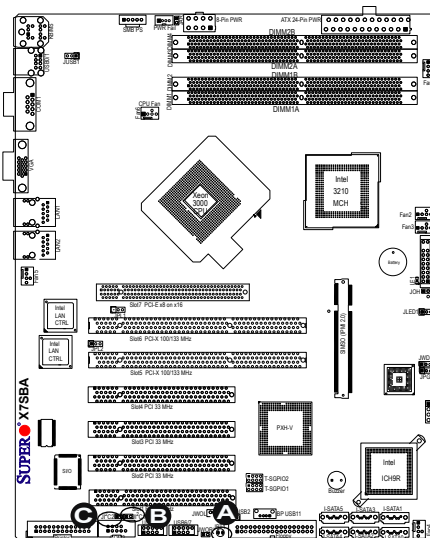

A. Clear CMOS

B. J1²C1

C. J1²C2

Watch Dog Enable

JWD controls Watch Dog, a system monitor that takes action when a software application hangs. Close Pins 1-2 to reset the system if a program hangs. Close Pins 2-3 to generate a non-maskable interrupt for the program that hangs. (This function requires software support). Watch Dog must also be enabled in BIOS.

Watch Dog Jumper Settings (JWD)	
Jumper Setting	Definition
Pins 1-2	Reset
Pins 2-3	NMI
Open	Disabled

VGA Enable/Disable

JPG1 enables or disables the onboard VGA Connector on the motherboard. See the table on the right for jumper settings. The default setting is enabled.

VGA Enable/Disable Jumper Settings	
Jumper Setting	Definition
Pins 1-2	Enabled
Pins 2-3	Disabled

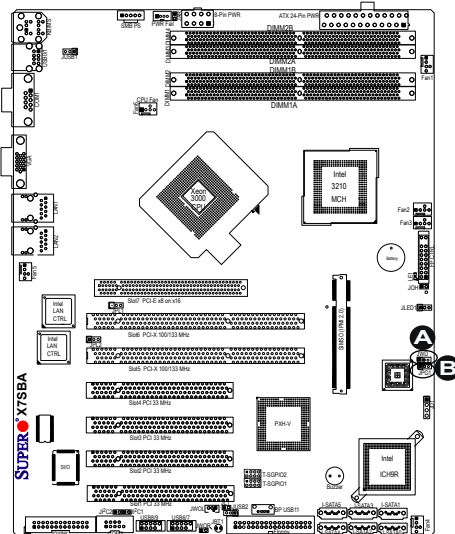

A. Watch Dog Enable

B. VGA Enable

USB Wake-Up

Use JPUSB jumpers to enable the function of "System Waking-Up via USB devices". These jumpers allow you to "wake-up" the system by pressing a key on the USB keyboard or by clicking the USB mouse of your system. The JPUSB jumpers are used together with the USB Wake-Up function in the BIOS. Enable both the jumpers and the BIOS setting to enable this function. See the tables on the right for jumper settings and jumper connections.

USB Wake-Up (JPUSB1) Jumper Settings	
Jumper Setting	Definition
Pins 1-2	Enabled (Default)
Pins 2-3	Disabled

USB Wake-Up (JPUSB2) Jumper Settings	
Jumper Setting	Definition
Pins 1-2	Enabled
Pins 2-3	Disabled (Default)

Notes:

1. JPUSB1 is for Back Panel USB ports: 0/1, and JPUSB2 is for Front Panel USB ports: 6/7, 8/9, 11. (Default: JPUSB1: Enabled, JPUSB2: Disabled.)
2. When the "USB Wake-Up" function is enabled in the BIOS and the selected USB ports are also enabled via the JPUSB jumpers, please be sure to remove all other USB devices from the USB ports whose USB jumpers are set to "Disabled" before the system goes into the standby mode.

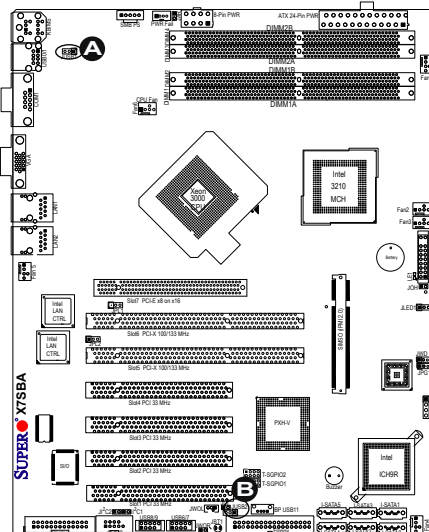

A. JPUSB1

B. JPUSB2

2-8 Onboard Indicators

GLAN LEDs

There are two GLAN ports on the motherboard. Each Gigabit Ethernet LAN port has two LEDs. The yellow (right) LED indicates activity while the other LED may be green, amber or off to indicate the speed of the connection. See the table at right for the functions associated with the second LED.

Onboard Power LED

LE1 is an Onboard Power LED located on the motherboard. When this LED is lit, the onboard power is on. Be sure to turn off the system and unplug the power cord before removing or installing components. See the layout below for the LED location.



Rear View

(When viewing from the back of the system)

GLAN Yellow LED (Right) Activity LED Indicator	
LED Color	Definition
Yellow	Flashing: Active, running @10Mbps, 100Mbps or 1 Gbps

GLAN Link LED (Left) Speed Indicator	
LED Color	Definition
Off	10Mbps or No Connection
Green	100 Mbps
Amber	1 Gbps

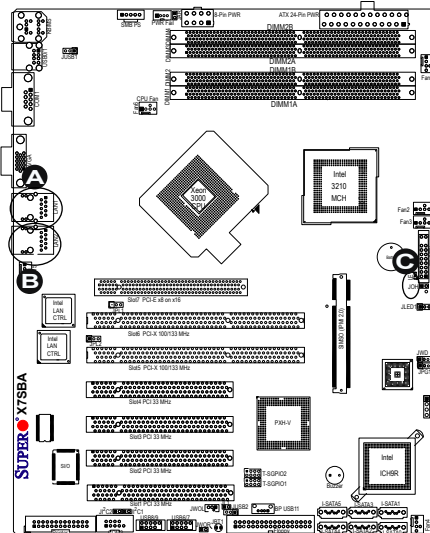

- A. GLAN1 Port**
- B. GLAN2 Port**
- C. Onboard LED**

2-9 Floppy, Parallel Port and SIMSO IPMI Connections

Note the following when connecting the floppy and hard disk drive cables:

- The floppy disk drive cable has seven twisted wires.
- A red mark on a wire typically designates the location of pin 1.
- A single floppy disk drive ribbon cable has two connectors to provide for two floppy disk drives. The connector with twisted wires always connects to drive A, and the connector that does not have twisted wires always connects to drive B.

Floppy Connector

The floppy connector is located at J1. See the table below for pin definitions.

Floppy Drive Connector Pin Definitions			
Pin#	Definition	Pin #	Definition
1	Ground	2	FDHDIN
3	Ground	4	Reserved
5	Key	6	FDEDIN
7	Ground	8	Index
9	Ground	10	Motor Enable
11	Ground	12	Drive Select B
13	Ground	14	Drive Select B
15	Ground	16	Motor Enable
17	Ground	18	DIR
19	Ground	20	STEP
21	Ground	22	Write Data
23	Ground	24	Write Gate
25	Ground	26	Track 00
27	Ground	28	Write Protect
29	Ground	30	Read Data
31	Ground	32	Side 1 Select
33	Ground	34	Diskette

A. Floppy

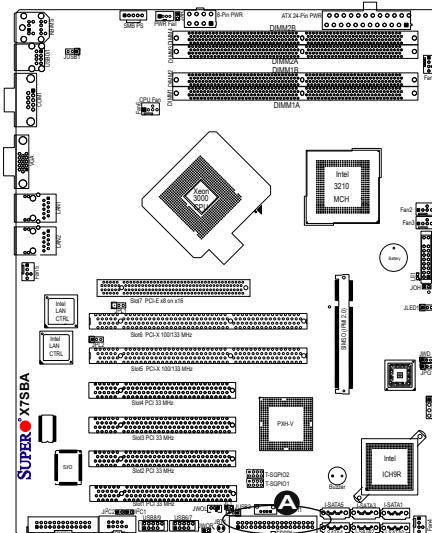

Parallel Port Connector

The parallel port is located next to COM2 header. See the table on the right for pin definitions.

Parallel (Printer) Port Connector Pin Definitions			
Pin#	Definition	Pin #	Definition
1	Strobe-	2	Auto Feed-
3	Data Bit 0	4	Error-
5	Data Bit 1	6	Init-
7	Data Bit 2	8	SLCT IN-
9	Data Bit 3	10	GND
11	Data Bit 4	12	GND
13	Data Bit 5	14	GND
15	Data Bit 6	16	GND
17	Data Bit 7	18	GND
19	ACK	20	GND
21	BUSY	22	Write Data
23	---	24	Write Gate
25	SLCT	26	NC

SIMSO IPMI

A SIMSO IPMI (Intelligent Platform Management Interfaces) is located on the motherboard. Refer to the layout below for the location of the SIMSO Socket.

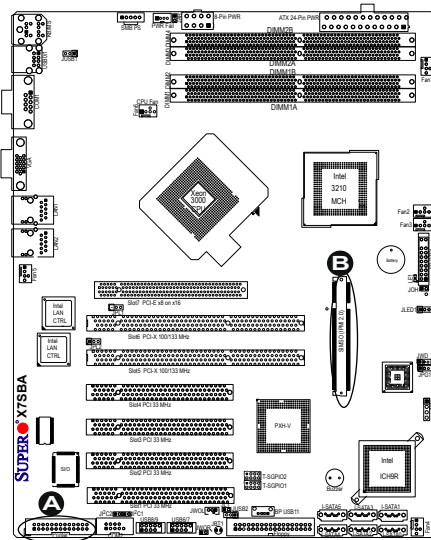

A. Printer

B. SIMSO IPMI 2.0

Chapter 3

Troubleshooting

3-1 Troubleshooting Procedures

Use the following procedures to troubleshoot your system. If you have followed all of the procedures below and still need assistance, refer to the 'Technical Support Procedures' and/or 'Returning Merchandise for Service' section(s) in this chapter. Always disconnect the AC power cord before adding, changing or installing any hardware components.

Before Power On

1. Make sure that the Standby PWR LED (LE1) is not lit.
2. Make sure that the 8-pin 12v power connector at JPW2 is connected.
3. Make sure that there are no short circuits between the motherboard and the chassis.
4. Disconnect all ribbon/wire cables from the motherboard, including those for the keyboard and mouse. Also, remove all add-on cards.
5. Install a CPU and heatsink (Be sure that it is fully seated,) and then, connect the chassis speaker and the power LED to the motherboard. Check all jumper settings as well.

No Power

1. Make sure that there are no short circuits between the motherboard and chassis.
2. Make sure that all jumpers are set to their default positions.
3. Check if the 115V/230V switch on the power supply is properly set.
4. Turn the power switch on and off to test the system.
5. The battery on your motherboard may be old. Check to make sure that it still supplies ~3VDC. If it does not, replace it with a new one.

No Video

1. If the power is on, but you have no video--in this case, you will need to remove all the add-on cards and cables first.
2. Use the speaker to determine if any beep codes exist. (Refer to Appendix A for details on beep codes.)
3. Remove all memory modules and turn on the system. (If the alarm is on, check the specs of memory modules, reset the memory or try a different one.)

NOTE

If you are a system integrator, VAR or OEM, a POST diagnostics card is recommended. For I/O port 80h codes, refer to App. B.

Memory Errors

1. Make sure that the DIMM modules are properly installed and fully seated in the slots.
2. You should be using unbuffered, ECC DDR2-800/677 memory (see the next page). Also, it is recommended that you use the memory modules of the same type and speed for all DIMMs in the system. See Section 2-4 for memory limitations.
3. Check for bad DIMM modules or slots by swapping modules between slots to see if you can locate the faulty modules.
4. Check the power supply voltage 115V/230V switch.

Losing the System's Setup Configuration

1. Please be sure to use a high quality power supply. A poor quality power supply may cause the system to lose the CMOS setup information. Refer to Section 1-6 for details on recommended power supplies.
2. The battery on your motherboard may be old. Check to verify that it still supplies ~3VDC. If it does not, replace it with a new one.
3. If the above steps do not fix the Setup Configuration problem, contact your vendor for repairs.

3-2 Technical Support Procedures

Before contacting Technical Support, please make sure that you have followed all the steps listed below. Also, note that as a motherboard manufacturer, Supermicro does not sell directly to end users, so it is best to first check with your distributor or reseller for troubleshooting services. They should know of any possible problem(s) with the specific system configuration that was sold to you.

1. Please go through the 'Troubleshooting Procedures' and 'Frequently Asked Question' (FAQ) sections in this chapter or see the FAQs on our web site (<http://www.supermicro.com/support/faqs/>) before contacting Technical Support.
2. BIOS upgrades can be downloaded from our web site at (<http://www.supermicro.com/support/bios/>).

Note: Not all BIOS can be flashed. Some cannot be flashed; it depends on

the modifications to the boot block code.

3. If you've followed the instructions above to troubleshoot your system, and still cannot resolve the problem, then contact Supermicro's technical support and provide them with the following information:

- Motherboard model and PCB revision number
- BIOS release date/version (this can be seen on the initial display when your system first boots up)
- System configuration

An example of a Technical Support form is on our web site at (<http://www.supermicro.com/support/contact.cfm>).

4. Distributors: For immediate assistance, please have your account number ready when placing a call to our technical support department. We can be reached by e-mail at support@supermicro.com, by phone at: (408) 503-8000, option 2, or by fax at (408)503-8019.

3-3 Frequently Asked Questions

Question: What type of memory does my motherboard support?

Answer: The X7SBA supports up to 8 GB of **unbuffered**, ECC, DDR2-800/677, two-way interleaved or non-interleaved SDRAM. See Section 2-4 for details on installing memory.

Question: Why does Microsoft Windows XP (SP2) and Windows Vista show less memory than what is physically installed?

Answer: Microsoft implemented a design change in Windows XP with Service Pack 2 (SP2) and Windows Vista. This change is specific to the Physical Address Extension (PAE) mode behavior which improves driver compatibility. For more information, please read the following article at Microsoft's Knowledge Base website at: <http://support.microsoft.com/kb/888137>.

Question: How do I update my BIOS?

Answer: It is recommended that you **do not** upgrade your BIOS if you are not experiencing any problems with your system. Updated BIOS files are located on our web site at <http://www.supermicro.com/support/bios/>. Please check our BIOS warning message and the information on how to update your BIOS on our web site. Select your motherboard model and download the BIOS (.rom) file to your computer. Also, check the current BIOS revision and make sure that it is newer than your BIOS before downloading. You may choose the zip file or the .exe file. If you choose the zipped BIOS file, please unzip the BIOS file onto a bootable device or a USB pen/thumb drive. To flash the BIOS, run the batch

file named "flash.bat" with the new BIOS .rom file from your bootable device or USB pen/thumb drive. Use the following format:

```
F:\> flash xxxxxxxx.rom <Enter>
```



Note: Be sure to insert a space immediately after "flash" and use only the file named "flash.bat" to update the BIOS.

When completed, your system will automatically reboot. If you choose the .exe file, please run the .exe file under Windows to create the BIOS flash floppy disk. Insert the floppy disk into the system you wish to flash the BIOS. Then, boot the system to the floppy disk. The BIOS utility will automatically flash the BIOS without any prompts. Please note that this process may take a few minutes to complete. Do not be concerned if the screen is paused for a few minutes.



Warning: Do not shut down or reset the system while updating the BIOS to prevent possible system boot failure!

When the BIOS flashing screen is completed, the system will reboot and will show "Press F1 or F2". At this point, you will need to load the BIOS defaults. Press <F1> to go to the BIOS setup screen, and press <F9> to load the default settings. Next, press <F10> to save and exit. The system will then reboot.



Note: The SPI BIOS chip installed on this motherboard is not removable. To repair or replace a damaged BIOS chip, please send your motherboard to RMA at Supermicro for service.

Question: What's on the CD that came with my motherboard?

Answer: The supplied compact disc has quite a few drivers and programs that will greatly enhance your system. We recommend that you review the CD and install the applications you need. Applications on the CD include chipset drivers for the Windows OS, security and audio drivers.

3-4 Returning Merchandise for Service

A receipt or copy of your invoice marked with the date of purchase is required before any warranty service will be rendered. You can obtain service by calling your vendor for a Returned Merchandise Authorization (RMA) number. When returning to the manufacturer, the RMA number should be prominently displayed on the outside of the shipping carton, and mailed prepaid or hand-carried. Shipping and handling charges will be applied for all orders that must be mailed when service is complete.

For faster service, RMA authorizations may be requested online (<http://www.supermicro.com/support/rma/>).

This warranty only covers normal consumer use and does not cover damage incurred in shipping or from failure due to the alteration, misuse, abuse or improper maintenance of products.

During the warranty period, contact your distributor first for any product problems.

Notes

Chapter 4

BIOS

4-1 Introduction

This chapter describes the Phoenix BIOS™ Setup utility for the X7SBA. The Phoenix ROM BIOS is stored in a flash chip and can be easily upgraded using a floppy disk-based program.

Note: Due to periodic changes to the BIOS, some settings may have been added or deleted and might not yet be recorded in this manual. Please refer to the Manual Download area of the Supermicro web site <<http://www.supermicro.com>> for any changes to the BIOS that may not be reflected in this manual.

System BIOS

BIOS is the Basic Input Output System used in all IBM® PC, XT™, AT®, and PS/2® compatible computers. The Phoenix BIOS stores the system parameters, types of disk drives, video displays, etc. in the CMOS. The CMOS memory requires very little electrical power. When the computer is turned off, a backup battery provides power to the CMOS logic, enabling it to retain system parameters. Each time the computer is powered on the computer is configured with the values stored in the CMOS logic by the system BIOS, which gains control at boot up.

How To Change the Configuration Data

The CMOS information that determines the system parameters may be changed by entering the BIOS Setup utility. This Setup utility can be accessed by pressing the <Delete> key at the appropriate time during system boot. (See below.)

Starting the Setup Utility

Normally, the only visible POST (Power On Self Test) routine is the memory test. As the memory is being tested, press the <Delete> key to enter the main menu of the BIOS Setup utility. From the main menu, you can access the other setup screens, such as the Security and Power menus. Beginning with Section 4-3, detailed descriptions are given for each parameter setting in the Setup utility.



Warning: Do not shut down or reset the system while updating BIOS to prevent possible boot failure.

Note: The SPI BIOS chip used in the X7SBA is not removable. To replace a damaged SPI BIOS chip, please send the motherboard to Supermicro for repair.

4-2 Running Setup

Default settings are in bold text unless otherwise noted.

The BIOS setup options described in this section are selected by choosing the appropriate text from the main BIOS Setup screen. All displayed text is described in this section, although the screen display is often all you need to understand how to set the options (See the next page).

When you first power on the computer, the Phoenix BIOS™ is immediately activated.

While the BIOS is in control, the Setup program can be activated in one of two ways:

1. By pressing <Delete> immediately after turning the system on, or
2. When the message shown below appears briefly at the bottom of the screen during the POST (Power On Self-Test), press the <Delete> key to activate the main Setup menu:

Press the <Delete> key to enter Setup

4-3 Main BIOS Setup

All main Setup options are described in this section. The main BIOS Setup screen is displayed below.

Use the Up/Down arrow keys to move among the different settings in each menu. Use the +/- arrow keys to change the options for each setting.

Press the <Esc> key to exit the CMOS Setup Menu. The next section describes in detail how to navigate through the menus.

Items that use submenus are indicated with the ► icon. With the item highlighted, press the <Enter> key to access the submenu.

Main BIOS Setup Menu

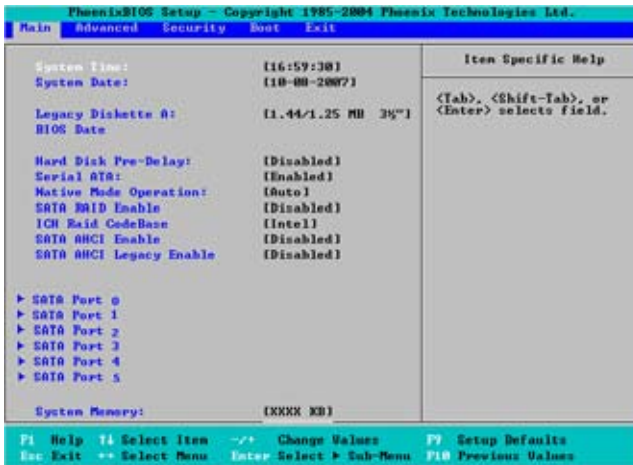

Main Setup Features

System Time

To set the system date and time, key in the correct information in the appropriate fields. Then press the <Enter> key to save the data.

System Date

Using the arrow keys, highlight the month, day and year fields, and enter the correct data. Press the <Enter> key to save the data.

Legacy Diskette A

This setting allows the user to set the type of floppy disk drive installed as diskette A. The options are Disabled, 360Kb 5.25 in, 1.2MB 5.25 in, 720Kb 3.5 in, **1.44/1.25MB**, 3.5 in and 2.88MB 3.5 in.

BIOS Date

This item displays the date that the BIOS was built.

BIOS Revision

This item displays the BIOS revision number.

Hard Disk Pre-Delay

When Enabled, this feature will add a delay to provide time need for HDD self-initialization before the HDD is accessed by the BIOS for the first time. Some HDDs will hang if accessed by the BIOS without proper initialization. The options are **Disabled**, 3 Seconds, 6 Seconds, 9 Seconds, 12 Seconds, 15 Seconds, 21

Seconds, and 30 Seconds.

Serial ATA

This setting allows the user to enable or disable the function of Serial ATA. The options are Disabled and **Enabled**.

Native Mode Operation

Select Serial ATA to use the SATA mode, or select Auto to use the Native Mode for ATA. The options are: Serial ATA and **Auto**.

Serial ATA (SATA) RAID Enable

Select Enable to enable Serial ATA RAID Functions. (For the Windows OS environment, use the RAID driver if this feature is set to Enabled. When this item is set to Enabled, the item: ICH RAID Code Base will be available for you to select either Intel or Adaptec Host RAID firmware to be activated. If this item is set to **Disabled**, the item-SATA AHCI Enable will be available.) The options are Enabled and **Disabled**.

ICH RAID Code Base

Select Intel to enable the Intel SATA RAID firmware. Select Adaptec to use the Adaptec HostRAID firmware. The options are **Intel** and Adaptec.

SATA AHCI Enable

Select Enable to enable the function of Serial ATA Advanced Host Interface. (Take caution when using this function. This feature is for advanced programmers only. The Enhanced AHCI mode is available when the Windows XP-SP1 OS and the IAA Driver is used.) The options are Enabled and **Disabled**.

SATA AHCI Legacy Enable

Select Enable to use Legacy Mode for SATA Advanced Host Interfacing. When this feature is set to Enabled, SATA Port 5 and SATA Port 6 are disabled. (Take caution when using this function. This feature is for advanced programmers only.) The options are Enabled and **Disabled**.

►SATA Port 0, SATA Port 1, SATA Port 2, SATA Port 3,SATA Port 4, and SATA Port 5

These settings allow the user to set the parameters of SATA 0, SATA 1, SATA Port 2, SATA Port 3, SATA 4, and SATA Port 5 connections. Hit <Enter> to activate the following sub-menu screen for detailed options of these items. Set the correct configurations accordingly. The items included in the sub-menu are:

Type

This option allows the user to select the type of an IDE/SATA device. Select

Auto to allow the BIOS to automatically configure the parameters of the SATA device installed on a slot.

Multi-Sector Transfers

This item allows the user to specify the number of sectors per block to be used in multi-sector transfer. The default setting is **Disabled**.

LBA Mode Control

This item determines whether the Phoenix BIOS will access a IDE Device via the LBA mode. The default setting is **Disabled**.

32 Bit I/O

This option allows the user to enable or disable the function of 32-bit data transfer. The options are Enabled and **Disabled**.

Transfer Mode

This option allows the user to set the transfer mode. The default setting is **Standard**.

Ultra DMA Mode

This option allows the user to configure the Ultra DMA Mode setting. The default setting is **Disabled**.

Installed Memory

This display informs you how much total memory installed in the system is detected by the BIOS.

System Memory

This display informs you how much system memory is available in the system.

4-4 Advanced Setup

Choose Advanced from the Phoenix BIOS Setup Utility main menu with the arrow keys. You should see the following display. The items with a triangle beside them have sub menus that can be accessed by highlighting the item and pressing <Enter>.



► Boot Features

Access the submenu to make changes to the following settings.

Quiet Mode

This setting allows you to **Enable** or Disable the graphic logo screen during boot-up.

QuickBoot Mode

If enabled, this feature will speed up the POST (Power On Self Test) routine by skipping certain tests after the computer is turned on. The settings are **Enabled** and Disabled. If Disabled, the POST routine will run at normal speed.

POST Errors

Use the setting to Pause and Display SETUP entry or resume boot prompt if error occurs on boot disabled. The options are **Enabled** and Disabled.

ACPI Mode

Select Yes to **use** the ACPI (Advanced Configuration and Power Interface) power management feature on your system. The options are **Yes** and No.

Power Button Behavior

If set to **Instant-Off**, the system will power on or power off immediately as soon as the user hits the power button. The options are **Instant-Off** and 4-Second

Override.

Resume On Modem Ring

Select On to “wake your system up” when an incoming call is received by your modem. The options are On and **Off**.

Resume On PME#

Select On to “wake your system up” from the PME# of PCI slots. The options are **On** and Off.

PS2 Keyboard (KB)/Mouse Wake Up

Select Enable to “wake your system up” from the S1, S4 or S5 state. The default setting is **Disabled**.

USB Wake Up

Select Enable to allow your system to be “awakened” from the S3 or S4 state with a USB device. If this feature is set to Enabled, you will also need to enable the JPUSB1 or JPUSB2 jumper by closing pins 1-2. (Please refer to Pg. 1-5 and Chapter 2 for more details). The default setting is **Disabled**. **Power Loss Control**

This setting allows you to choose how the system will react when power returns after an unexpected loss of power. The options are Stay Off, Power On, and **Last State**.

Watch Dog

If enabled, this option will automatically reset the system if the system is not active for more than 5 minutes. The options are Enabled and **Disabled**.

Summary Screen

This setting allows you to **Enable** or Disable the summary screen which displays the system configuration during bootup.

► Advanced Processor Options

Access the submenu to make changes to the following settings.

CPU Speed

This is a display that indicates the speed of the installed processor.

Frequency Ratio (Available when supported by the CPU.)

The feature allows the user to set the internal frequency multiplier for the CPU. The default setting is **Default**.

Frequency High Ratio (Available when supported by the CPU.)

The feature allows the user to set high ratio internal frequency multiplier for Intel

SpeedStep CPUs. The default setting is **x12**.

Note: If a wrong ratio that is not supported by the CPU is selected, the system may hang. If this happens, clear CMOS to recover the system.)

Core-Multi-Processing (Available when supported by the CPU.)

Set to Enabled to use a processor's Second Core and beyond. (Please refer to Intel's web site for more information.) The options are Disabled and **Enabled**.

Machine Checking (Available when supported by the CPU.)

Set to Enabled to activate the function of Machine Checking and allow the CPU to detect and report hardware (machine) errors via a set of model-specific registers (MSRs). The options are **Enabled** and Disabled.

Compatible FPU Code (Available when supported by the CPU.)

Set to Enabled to keep the content of the last instruction Operating Code (OP Code) in the floating point (FP) state. The options are **Disabled** and Enabled.

Thermal Management 2 (Available when supported by the CPU.)

Set to **Enabled** to use Thermal Management 2 (TM2) which will lower CPU voltage and frequency when the CPU temperature reaches a predefined overheat threshold. Set to Disabled to use Thermal Manager 1 (TM1), allowing CPU clocking to be regulated via CPU Internal Clock modulation when the CPU temperature reaches the overheat threshold.

Adjacent Cache Line Prefetch (Available when supported by the CPU.)

The CPU fetches the cache line for 64 bytes if this option is set to Disabled. The CPU fetches both cache lines for 128 bytes as comprised if Enabled. The options are Disabled and **Enabled**.

Set Maximum Ext. CPUID=3

When set to Enabled, the Maximum Extended CPUID will be set to 3. The options are **Disabled** and Enabled.

Echo TPR

Set to **Enabled** to prevent xTPR messages from being sent to the system. The options are Disabled and **Enabled**.

C1 Enhanced Mode (Available when supported by the CPU.)

Set to Enabled to enable Enhanced Halt State to lower CPU voltage/frequency to prevent overheat. The options are Enabled and **Disabled**. **Note:** please refer to Intel's web site for detailed information.

Intel® Virtualization Technology (Available when supported by the CPU.)

Select Enabled to use the feature of Virtualization Technology to allow one platform to run multiple operating systems and applications in independent partitions, creating multiple "virtual" systems in one physical computer. The options are Enabled and **Disabled**.

Note: If there is any change to this setting, you will need to power off and restart the system for the change to take effect. Please refer to Intel's web site for detailed information.

Clock Spectrum Feature

If Enabled, the BIOS will monitor the level of Electromagnetic Interference caused by the components and will attempt to decrease the interference whenever needed. The options are Enabled and **Disabled**.

No Execute Mode Memory Protection (Available when supported by the CPU and the OS.)

Set to Enabled to enable Execute Disable Bit and allow the processor to classify areas in memory where an application code can execute and where it cannot, and thus preventing a worm or a virus from inserting and creating a flood of codes to overwhelm the processor or damage the system during an attack.

Note: this feature is available when your OS and your CPU support the function of Execute Disable Bit. The options are Disabled and **Enabled**. **Note:** For more information regarding hardware/software support for this function, please refer to Intel's and Microsoft's web sites.

Enhanced Intel Speed Step Support (Available when supported by the CPU.)

Select Enabled to use the Enhanced Intel SpeedStep Technology and allows the system to automatically adjust processor voltage and core frequency in an effort to reduce power consumption and heat dissipation. The options are Disabled, **GV1/GV3 Only** and Enabled.

►Advanced Chipset Control

Access the submenu to make changes to the following settings.



Warning: Take Caution when changing the Advanced settings. An incorrect value, a very high DRAM frequency, or an incorrect DRAM timing may cause the system to become unstable. When this occurs, reset the setting to the default setting.

Memory Remapping

Select Enable to enable the functionality of Memory Remapping above 4GB. The settings are **Enabled** and Disabled.

Enable VT-d

Select Enable to enable the functionality of the Intel Virtualization Technology for Direct I/O support, which offers fully-protected I/O resource-sharing across the Intel platforms, providing the user with greater reliability, security and availability in networking and data-sharing. The settings are Enabled and **Disabled**.

High Precision Event Time

Select Yes to activate the High Precision Event Timer (HPET), which is capable of producing periodic interrupts at a much higher frequency than a Real-time Clock (RTC) can in synchronizing multimedia streams, providing smooth playback and reducing the dependency on other timestamp calculation devices, such as an x86 RDTSC Instruction embedded in a CPU. The High Precision Event Timer is used to replace the 8254 Programmable Interval Timer. The options for this feature are Yes and **No**.

Route Port 80h Cycles to

This feature allows the user to decide which bus to send debug information to. The options are **PCI** and LPC.

USB Host Controller

This feature allows the user to configure the USB Host Controller setting for the USB Host Controller Functions 0, 1, 2, 3, 7. The settings are **Enabled** and Disabled.

EHCI Controller

This feature enables the onboard Enhanced Host Controller Interface. The options are **Enabled** and Disabled.

Legacy USB Support

This setting allows you to enable support for Legacy USB devices. The settings are **Enabled** and Disabled.

► Memory Cache

Cache System BIOS Area

This setting allows you to designate a reserve area in the system memory to be used as a System BIOS buffer to allow the BIOS to write (cache) data into this reserved memory area. Select **Write Protect** to enable this function, and this area will be reserved for BIOS ROM access only. Select **Uncached** to disable this function and make this area available for other devices.

Cache Video BIOS Area

This setting allows you to designate a reserve area in the system memory to be used as a Video BIOS buffer to allow the BIOS to write (cache) data into this reserved memory area. Select **Write Protect** to enable the function and this area will be reserved for Video BIOS ROM access only. Select **Uncached** to disable this function and make this area available for other devices.

Cache Base 0-512K

If enabled, this feature will allow the data stored in the base memory area: block 0-512K to be cached (written) into a buffer, a storage area in the Static DROM (SDROM) or to be written into the L1, L2 cache inside the CPU to speed up CPU operations. Select **Uncached** to disable this function. Select **Write Through** to allow data to be cached into the buffer and written into the system memory at the same time. Select **Write Protect** to prevent data from being written into the base memory area of Block 0-512K. Select **Write Back** to allow the CPU to write data back directly from the buffer without writing data to the System Memory for fast CPU data processing and operation. The options are **Uncached**, **Write Through**, **Write Protect**, and **Write Back**.

Cache Base 512K-640K

If enabled, this feature will allow the data stored in the memory area: 512K-640K to be cached (written) into a buffer, a storage area in the Static DROM (SDROM) or written into the L1, L2, L3 cache inside the CPU to speed up CPU operations. Select **Uncached** to disable this function. Select **Write Through** to allow data to be cached into the buffer and written into the system memory at the same time. Select **Write Protect** to prevent data from being written into the base memory area of Block 512K-640K. Select **Write Back** to allow the CPU to write data back directly from the buffer without writing data to the System Memory for fast CPU data processing and operation. The options are **Uncached**, **Write Through**, **Write Protect**, and **Write Back**.

Cache Extended Memory

If enabled, this feature will allow the data stored in the extended memory area to be cached (written) into a buffer, a storage area in the Static DROM (SDROM) or written into the L1, L2, L3 cache inside the CPU to speed up CPU operations. Select **Uncached** to disable this function. Select **Write Through** to allow data to be cached into the buffer and written into the system memory at the same time. Select **Write Protect** to prevent data from being written into the extended memory area above 1 MB. Select **Write Back** to allow the CPU to write data back directly from the buffer without writing data to the System Memory for fast CPU data processing and operation. The options are **Uncached**, **Write Through**, **Write Protect**, and **Write Back**.

► PnP Configuration

Access the submenu to make changes to the following settings for PCI devices.

► PCI 32 Slot 1/PCI 32 Slot 2/PCI 32 Slot 3/PCI 32 Slot 4

Access the submenu for each of the settings above to make changes to the following:

Option ROM Scan

When enabled, this setting will initialize the device expansion ROM. The options are **Enabled** and **Disabled**.

Enable Master

This setting allows you to enable the selected device as the PCI bus master. The options are **Enabled** and **Disabled**.

Latency Timer

This setting allows you to set the clock rate for Bus Master. A high-priority, high-throughput device may benefit from a greater clock rate. The options are **Default**, 0020h, 0040h, 0060h, 0080h, 00A0h, 00C0h, and 00E0h. For Unix, Novelle and other Operating Systems, please select the option: other. If a drive fails after the installation of a new software, you might want to change this setting and try again. A different OS requires a different Bus Master clock rate.

PCI-X(s) Frequency

This feature allows the user to set the bus frequency for a PCI-X slot for it to work properly. The options are **Auto**, [PCI 33MHz], [PCI 66MHz], [PCI-X 66MHz], [PCI-X 100MHz], [PCI-X 133MHz].

► PCI-X 133 MHz Slot 5/PCI-X 133 MHz Slot 6

Access the submenu for each of the settings above to make changes to the following:

Option ROM Scan

When enabled, this setting will initialize the device expansion ROM. The options are **Enabled** and Disabled.

Enable Master

This setting allows you to enable the selected device as the PCI bus master. The options are **Enabled** and Disabled.

Latency Timer

This setting allows you to set the clock rate for Bus Master. A high-priority, high-throughput device may benefit from a greater clock rate. The options are **Default**, 0020h, 0040h, 0060h, 0080h, 00A0h, 00C0h, and 00E0h. For Unix, Novelle and other Operating Systems, please select the option: other. If a drive fails after the installation of a new software, you might want to change this setting and try again. A different OS requires a different Bus Master clock rate.

► PCIE X8 Slot 7

Access the submenu for each of the settings above to make changes to the following:

Option ROM Scan

When enabled, this setting will initialize the device expansion ROM. The options are **Enabled** and Disabled.

Enable Master

This setting allows you to enable the selected device as the PCI bus master. The options are **Enabled** and Disabled.

Latency Timer

This setting allows you to set the clock rate for Bus Master. A high-priority, high-throughput device may benefit from a greater clock rate. The options are **Default**, 0020h, 0040h, 0060h, 0080h, 00A0h, 00C0h, and 00E0h. For Unix, Novelle and other Operating Systems, please select the option: other. If a drive fails after the installation of a new software, you might want to change this setting and try again. A different OS requires a different Bus Master clock rate.

► Onboard LAN 1/Onboard LAN 2

Access the submenu for each of the settings above to make changes to the following:

Option ROM Scan

When enabled, this setting will initialize the device expansion ROM. The options are Enabled and **Disabled**.

Enable Master

This setting allows you to enable the selected device as the PCI bus master. The options are **Enabled** and Disabled.

Latency Timer

This setting allows you to set the clock rate for Bus Master. A high-priority, high-throughput device may benefit from a greater clock rate. The options are **Default**, 0020h, 0040h, 0060h, 0080h, 00A0h, 00C0h, and 00E0h. For Unix, Novelle and other Operating Systems, please select the option: other. If a drive fails after the installation of a new software, you might want to change this setting and try again. A different OS requires a different Bus Master clock rate.

► I/O Device Configuration

Access the submenu to make changes to the following settings.

KBC Clock Input

This setting allows you to select clock frequency for the keyboard clock. The options are 6MHz, 8MHz, **12MHz**, and 16MHz.

Serial Port A

This setting allows you to assign control of Serial Port A. The options are **Enabled** (user defined) and Disabled.

Base I/O Address

This setting allows you to select the base I/O address for Serial Port A. The options are **3F8**, 2F8, 3E8, and 2E8.

Interrupt

This setting allows you to select the IRQ (interrupt request) for Serial Port A. The options are IRQ3 and **IRQ4**.

Serial Port B

This setting allows you to assign control of Serial Port B. The options are **Enabled** (user defined) and Disabled.

Mode

This setting allows you to set the type of device that will be connected to Serial Port B. The options are **Normal**, IR (for an infrared device) and ASK_IR.

Base I/O Address

This setting allows you to select the base I/O address for Serial Port B. The options are 3F8, **2F8**, 3E8 and 2E8.

Interrupt

This setting allows you to select the IRQ (interrupt request) for Serial Port B. The options are **IRQ3** and IRQ4.

Parallel Port

This setting allows you to assign control of the parallel port. The options are **Enabled** (user defined) and Disabled.

Base I/O Address

Select the base I/O address for the parallel port. The options are **378**, 278 and 3BC.

Interrupt

This setting allows you to select the IRQ (interrupt request) for the parallel port. The options are IRQ5 and **IRQ7**.

Mode

This feature allows you to specify the parallel port mode. The options are Output only, Bi-Directional, EPP and **ECP**.

DMA Channel

This item allows you to specify the DMA channel for the parallel port. The options are DMA1 and **DMA3**.

Floppy Disk Controller

This setting allows you to assign control of the floppy disk controller. The options are **Enabled** (user defined), Disabled, and Auto (BIOS and OS controlled).

► DMI Event Logging

Access the submenu to make changes to the following settings.

Event Log Validity

This is a display to inform you of the event log validity. It is not a setting.

Event Log Capacity

This is a display to inform you of the event log capacity. It is not a setting.

View DMI Event Log

Highlight this item and press <Enter> to view the contents of the event log.

Event Logging

This setting allows you to **Enable** or Disable event logging.

Mark DMI Events as Read

Highlight this item and press <Enter> to mark the DMI events as read.

Clear All DMI Event Logs

Select Yes and press <Enter> to clear all DMI event logs. The options are Yes and **No**.

► Console Redirection

Access the submenu to make changes to the following settings.

COM Port Address

This item allows you to specify which COM port to direct the remote console to: Onboard COM A or Onboard COM B. This setting can also be **Disabled**.

BAUD Rate

This item allows you to set the BAUD rate for the console redirection. The options are 300, 1200, 2400, 9600, **19.2K**, 38.4K, 57.6K, and 115.2K.

Console Type

This item allows you to set the console redirection type. The options are VT100, VT100/8bit, PC-ANSI/7bit, **PC ANSI**, VT100+, VT-UTF8 and ASCII.

Flow Control

This item allows you to select the flow control option for the console. The options are: None, XON/XOFF, and **CTS/RTS**.

Console Connection

This item allows you to decide how console redirection is to be connected: either **Direct** or Via Modem.

Continue CR after POST

This feature allows you to decide if you want to continue with console redirection after the POST routine. The options are On and **Off**.

► Hardware Monitoring

This feature allows the BIOS to automatically monitor the following components and display the temperature of each component as detected.

CPU Overheat Alarm

This option allows the user to select the CPU Overheat Alarm setting which determines when the CPU OH alarm will be activated to provide warning of possible CPU overheat. Refer to the the next item, **CPU Temperature** for more information regarding PECI, DTS and other thermal features of this motherboard.



Warning: Any temperature that exceeds the CPU threshold temperature predefined by the CPU manufacturer may result in CPU overheat or system instability. When the CPU temperature reaches this predefined threshold, the CPU and system cooling fans will run at full speed.

The options are:

The Default Alarm Setting: Select this setting if you want the CPU overheat alarm (including the LED and the buzzer) to be triggered when the CPU temperature reaches about +5 PECI counts above the threshold temperature as predefined by the CPU manufacturer to give the CPU and system fans additional time needed for CPU and system cooling.

The Early Alarm Setting: Select this setting if you want the CPU overheat alarm (including the LED and the buzzer) to be triggered as soon as the CPU temperature reaches the CPU overheat threshold as predefined by the CPU manufacturer.

CPU Temperature

This item displays the level of CPU temperature (High, Medium, Low) as detected by the BIOS. The information shown in the screen is for your reference only. (See the notes below for more information on DTS and PECI)

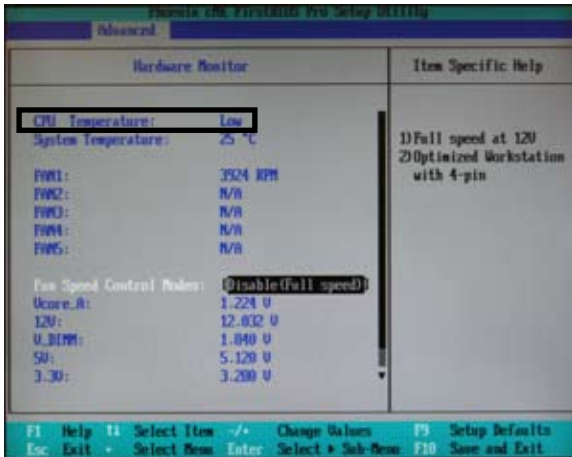

Low – This level is considered as the ‘normal’ operating temperature. No action is required. The PECI count is below or equal to the processor’s DTS thermal throttle point, minus 10 PECI counts.

Medium – The processor is running warmer. This is a ‘caution’ level and generally means that there may be factors contributing to this condition. At this point, the PECI count is above the processor’s DTS thermal throttle point minus 10 PECI counts, but still below or equal to the DTS thermal throttle point.

High – The processor is running hot. Take the necessary steps to correct any heat dissipation problems. Please check the system fans, chassis ventilation and room temperature to correct any problems. At this point, the system fans will run at full speed. The system’s Overheat Alarm will be triggered if the DTS thermal throttle point is reached, plus 5 PECI counts. (This is the ‘Default Alarm Setting’. To set the Overheat Alarm to trigger earlier with the ‘Early Alarm Setting’, refer to ‘CPU Overheat Alarm’ on the previous page.) The system may also shut down to prevent damage to the processor if it is not corrected. At this level, the PECI count is 0 or above the processor’s DTS thermal throttle point.



Notes:

Supermicro does not display CPU absolute temperatures because Intel has changed the processor methodology to PECI (Platform Environment Con-

rol Interface) using DTS (Digital Thermal Sensors). Intel processors only provide PECI counts as references for fan speed controls. So all our Intel processor-based motherboards will be/have been updated to change the CPU temperature display from numbers (absolute temperatures) to text (low, medium, and high).

Each processor has a DTS and every processor's DTS is individually calibrated at the factory. DTS' function is to provide digital data that informs the system of the processor's thermal throttle point. Since this value varies for every processor, it is impossible to assign a particular temperature level at the BIOS level. Instead, Intel developed PECI. PECI reports a negative value expressing the information imbedded in DTS and subtracting from it the current temperature reading. For example, if the assigned DTS thermal throttle point value in a processor is 85 °C and the current temperature reading is 35 °C, the value reported by PECI would be -50 °C. This PECI 'count' is monitored by your Supermicro motherboard and has been configured to display information according to a particular PECI 'count'. These are displayed in the BIOS as Low, Medium and High. A reading of "High" means that the PECI count has exceeded the DTS thermal throttle point (PECI count of zero and above).

The information provided above is for your reference only. For more information on thermal management, please refer to Intel's Web site at www.Intel.com.

System Temperature

This item displays the absolute system temperature as detected by the BIOS.

CPU Fan/Fan 1 to Fan 6

If the feature of Auto Fan Control is enabled, the BIOS will automatically display the status of each fan as specified.

Fan Speed Control Modes

This feature allows you to decide how the system controls the speeds of the onboard fans. The CPU temperature and the fan speed are correlative. When the CPU on-die temperature increases, the fan speed will also increase, and vice versa. If the option is set to "4-pin", the fan speed will be controlled by Pulse Width Modulation (PWM). Select "Workstation" or "Server" if your system is used as a Workstation or Server respectively. Select "Disable" to disable the fan speed control function to allow the onboard fans to constantly run at full speed (12V). The Options are: **1. Disable** and **2. 3-pin (server) 3-pin (worksta-**

tion), 4-pin (server) and 4-pin (workstation). Do not select 4-pin settings if you have a mix of 3-pin and 4-pin fans.

Voltage Monitoring

The following items will be monitored and displayed:

Vcore A, Vcc 1.5V, -12V, VDIMM, +3.3V, +12V, +5Vsb, +5VDD, P_VTT, Vbat

Note: In the Windows OS environment, the Supero Doctor III settings take precedence over the BIOS settings. When first installed, Supero Doctor III adopts the temperature threshold settings previously set in the BIOS. Any subsequent changes to these thresholds must be made within Supero Doctor, since the SD III settings override the BIOS settings. For the Windows OS to adopt the BIOS temperature threshold settings, please change the SDIII settings to be the same as those set in the BIOS.

► **IPMI (The option is available only when an IPMI card is installed in the system.)**

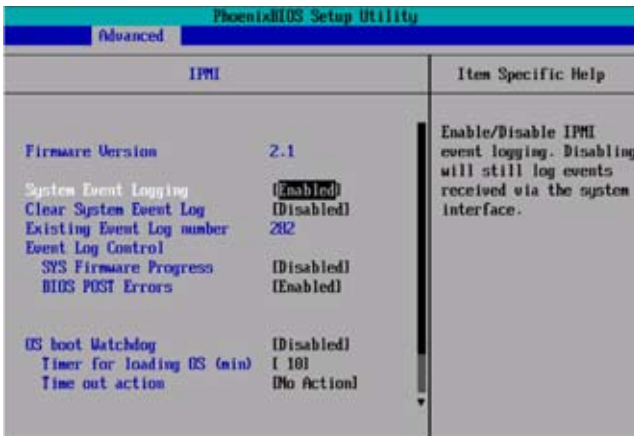

Firmware Version: This item displays the current Firmware Version.

System Event Logging

Select Enabled to enable IPMI Event Logging. When this function is set to Disabled, the system will continue to log events received via system interface. The options are **Enabled** and Disabled.

Clear System Event Logging

Enabling this function to force the BIOS to clear the system event logs during the next cold boot. The options are Enabled and **Disabled**.

Existing Event Log Number

This item displays the number of the existing event log.

Event Log Control

System Firmware Progress

Enabling this function to log POST progress. The options are **Enabled** and **Disabled**.

BIOS POST Errors

Enabling this function to log POST errors. The options are **Enabled** and **Disabled**.

OS Boot Watch Dog

Set to **Enabled** to enable OS Boot Watch Dog. The options are **Enabled** and **Disabled**.

Timer for Loading OS (Minutes)

This feature allows the user to set the time value (in minutes) for the previous item: OS Boot Watch Dog by keying-in a desired number in the blank. The default setting is **10** (minutes.) (Please ignore this option when OS Boot Watch Dog is set to "Disabled".)

Time Out Option

This feature allows the user to determine what action to take in an event of a system boot failure. The options are **No Action**, **Reset**, **Power Off** and **Power Cycle**.

► **System Event Log/System Event Log (List Mode)**

These options display the System Event (SEL) Log and System Event (SEL) Log in List Mode. Items include: SEL (System Event Log) Entry Number, SEL Record ID, SEL Record Type, Time Stamp, Generator ID, SEL Message Revision, Sensor Type, Sensor Number, SEL Event Type, Event Description, and SEL Event Data.



► Realtime Sensor Data

This feature display information from motherboard sensors, such as temperatures, fan speeds and voltages of various components.

Realtime Sensor Data					
Sensor Type	Sensor Name	Sensor Data	Sensor Units	Lower Limit	Upper Limit
Temp	CPU	40.00	degrees C	0.00	75.00
	System	44.00	degrees C	0.00	75.00
Voltage	CPU Core	1.13	Volts	0.97	1.47
	3.30	3.30	Volts	2.95	3.62
	50	4.62	Volts	4.48	5.49
	50sh	4.96	Volts	4.48	5.49
	120	12.00	Volts	10.75	13.24

F1	Help	F4	Select Item	+/=	Change Values	F9	Setup Defaults
Esc	Exit	*	Select Item	Enter	Select ▶ Sub-Item	F10	Save and Exit

► IPMI LAN Configuration

VLAN Tagging

Select Enabled to enable Virtual LAN(s) for IPMI connections and allow the user to configure VLAN settings. The options are Enabled and **Disabled**.

VLAN ID

This item allows the user to change the VLAN ID. The default setting is **1h**.

IP Address Source

This item allows the user to select the IP address source for the connection. The options are **DHCP** and Static.

Update LAN Settings

Select Yes to allow BIOS update LAN setting. The options are Yes and **No**.

4-5 Security Settings

Choose Security from the Phoenix BIOS Setup Utility main menu with the arrow keys. You should see the following display. Security setting options are displayed by highlighting the setting using the arrow keys and pressing <Enter>. All Security BIOS settings are described in this section.

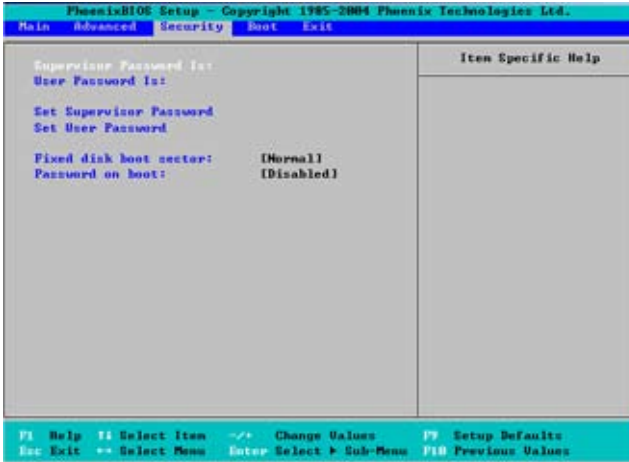

Supervisor Password Is:

This item indicates if a supervisor password has been entered for the system. Clear means such a password has not been used and Set means a supervisor password has been entered for the system.

User Password Is:

This item indicates if a user password has been entered for the system. Clear means such a password has not been used and Set means a user password has been entered for the system.

Set Supervisor Password

When the item "Set Supervisor Password" is highlighted, hit the <Enter> key. When prompted, type the Supervisor's password in the dialogue box to set or to change supervisor's password, which allows access to the BIOS.

Set User Password

When the item "Set User Password" is highlighted, hit the <Enter> key. When prompted, type the user's password in the dialogue box to set or to change the user's password, which allows access to the system at boot-up.

Fixed Disk Boot Sector

Select Write Protect to protect the boot sector on the hard drives from virus intrusion. The options are **Normal** and Write Protect.

Password on Boot

When set to Enabled, a user will need to key-in a password to enter the system at system boot. The options are Enabled (password required) and **Disabled** (password not required).

4-6 Boot Settings

Choose Boot from the Phoenix BIOS Setup Utility main menu with the arrow keys. You should see the following display. See details on how to change the order and specs of boot devices in the Item Specific Help window. All Boot BIOS settings are described in this section.

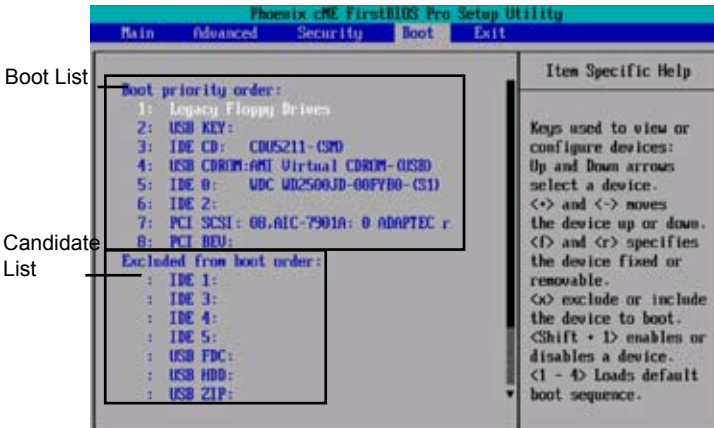

Boot Priority Order/Excluded from Boot Orders

The devices included in the boot list section (above) are bootable devices listed in the sequence of boot order as specified. The boot functions for the devices included in the candidate list (above) are currently disabled. Use a <+> key or a <-> key to move the device up or down. Use the <f> key or the <r> key to specify the type of an USB device, either fixed or removable. You can select one item from the boot list and hit the <x> key to remove it from the list of bootable devices (to make its resource available for other bootable devices). Subsequently, you can select an item from the candidate list and hit the <x> key to remove it from the candidate list and put it in the boot list. This item will then become a bootable device. See details on how to change the priority of boot order of devices in the "Item Specific Help" window.

4-7 Exit

Choose Exit from the Phoenix BIOS Setup Utility main menu with the arrow keys. You should see the following display. All Exit BIOS settings are described in this section.



Exit Saving Changes

Highlight this item and hit <Enter> to save any changes you made and to exit the BIOS Setup utility.

Exit Discarding Changes

Highlight this item and hit <Enter> to exit the BIOS Setup utility without saving any changes you may have made.

Load Setup Defaults

Highlight this item and hit <Enter> to load the default settings for all items in the BIOS Setup. These are the safest settings to use.

Discard Changes

Highlight this item and hit <Enter> to discard (cancel) any changes you made. You will remain in the Setup utility.

Save Changes

Highlight this item and hit <Enter> to save any changes you made. You will remain in the Setup utility.

Notes

Appendix A

POST Error Beep Codes

This section lists POST (Power On Self Test) error beep codes for the Phoenix BIOS. POST error beep codes are divided into two categories: recoverable and terminal. This section lists Beep Codes for recoverable POST errors.

Recoverable POST Error Beep Codes

When a recoverable type of error occurs during POST, BIOS will display a POST code that describes the problem. BIOS may also issue one of the following beep codes:

- 1 long and two short beeps - video configuration error
- 1 repetitive long beep - no memory detected
- 1 continuous beep with the front panel Overheat LED on - system overheat

Notes

Appendix B

Installing the Windows OS

After all hardware components have been installed, you must first configure Intel South Bridge RAID Settings before you install the Windows OS and other software drivers. To configure RAID settings, please refer to RAID Configuration User Guides posted on our website at www.supermicro.com/support/manuals. (**Note:** The current version of ICH9R HostRAID utility does not support the Windows 2000 O.S.)

B-1 Installing the Windows XP/2003 OS for Systems with RAID Functions

1. Insert Microsoft's Windows XP/2003 Setup CD in the CD Driver, and the system will start booting up from CD.
2. Press the <F6> key when the message-" Press F6 if you need to install a third party SCSI or RAID driver" displays.
3. When the Windows XP/2003 Setup screen appears, press "S" to specify additional device(s).
4. Insert the driver diskette-"Intel AA RAID XP/2003 Driver for ICH9R" into Drive A: and press the <Enter> key.
5. Choose the Intel(R) ICH9R *SATA RAID Controller* from the list indicated in the XP/2003 Setup Screen, and press the <Enter> key.
6. Press the <Enter> key to continue the installation process. (If you need to specify any additional devices to be installed, do it at this time.) Once all devices are specified, press the <Enter> key to continue with the installation.
7. From the Windows XP/2003 Setup screen, press the <Enter> key. The XP/2003 Setup will automatically load all device files and then, continue the Windows XP/2003 installation.
8. After the Windows XP/2003 OS Installation is completed, the system will automatically reboot.

B-2 Installing the Windows XP/2003 OS for Systems without RAID Functions

1. Insert Microsoft's Windows XP/2003 Setup CD in the CD Drive, and the system will start booting up from CD.
2. Continue with the OS installation. The Windows OS Setup screen will display.
3. From the Windows XP/2003 Setup screen, press the <Enter> key. The XP/2003 Setup will automatically load all device files and then continue with the Windows XP/2003 installation.
4. After the Windows XP/2003 OS Installation is completed, the system will automatically reboot.
5. Insert the Supermicro Setup CD that came with your motherboard into the CD Drive during system boot, and the main screen as shown on Page C-1 will display. Follow the instructions given in Appendix C to complete other software/driver installation.

Appendix C

Installing Other Software Programs and Drivers

C-1 Installing Drivers other than the Serial ATA RAID Controller Driver

After you've installed the Windows Operating System, a screen as shown below will appear. You are ready to install software programs and drivers that have not yet been installed. To install these software programs and drivers, click the icons to the right of these items.

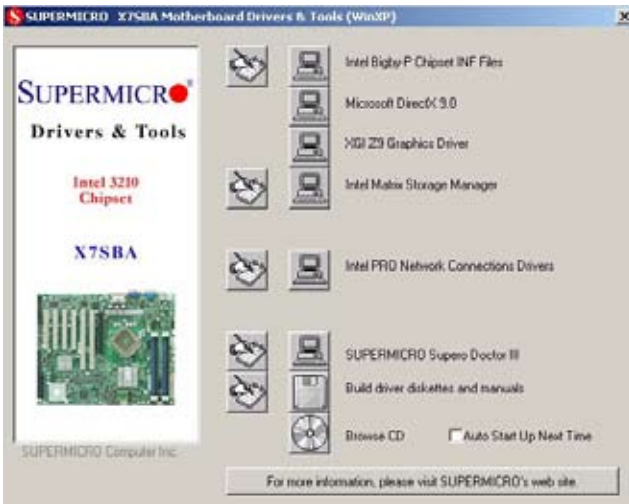

Driver/Tool Installation Display Screen

Note: Click the icons showing a hand writing on the paper to view the readme files for each item. Click a computer icon to the right of an item (from top to the bottom) one at a time. **After installing each item, you must re-boot the system before proceeding with the next item on the list.** The bottom icon with a CD on it allows you to view the entire contents of the CD.

C-2 Configuring Supero Doctor III

The Supero Doctor III program is a Web-base management tool that supports remote management capability. It includes Remote and Local Management tools. The local management is called the SD III Client. The Supero Doctor III program included on the CDROM that came with your motherboard allows you to monitor the environment and operations of your system. Supero Doctor III displays crucial system information such as CPU temperature, system voltages and fan status. See the Figure below for a display of the Supero Doctor III interface.

Note 1: The default user name and password are ADMIN.

Note 2: In the Windows OS environment, the Supero Doctor III settings take precedence over the BIOS settings. When first installed, Supero Doctor III adopts the temperature threshold settings previously set in the BIOS. Any subsequent changes to these thresholds must be made within Supero Doctor, since the SD III settings override the BIOS settings. For the Windows OS to adopt the BIOS temperature threshold settings, please change the SDIII settings to be the same as those set in the BIOS.

Supero Doctor III Interface Display Screen-I (Health Information)



Supero Doctor III Interface Display Screen-II (Remote Control)



Note: SD III Software Revision 1.0 can be downloaded from our Web site at: ftp://ftp.supermicro.com/utility/Supero_Doctor_III/. You can also download SDIII User's Guide at: <http://www.supermicro.com/PRODUCT/Manuals/SDIII/User-Guide.pdf>. For Linux, we will still recommend that you use Supero Doctor II.

Notes

(Disclaimer continued)

The products sold by Supermicro are not intended for and will not be used in life support systems, medical equipment, nuclear facilities or systems, aircraft, aircraft devices, aircraft/emergency communication devices or other critical systems whose failure to perform be reasonably expected to result in significant injury or loss of life or catastrophic property damage. Accordingly, Supermicro disclaims any and all liability, and should buyer use or sell such products for use in such ultra-hazardous applications, it does so entirely at its own risk. Furthermore, buyer agrees to fully indemnify, defend and hold Supermicro harmless for and against any and all claims, demands, actions, litigation, and proceedings of any kind arising out of or related to such ultra-hazardous use or sale.