

SUPER [®]

SUPER  [®] C2SBA+II
SUPER  [®] C2SBA+
SUPER  [®] C2SBA
SUPER  [®] C2SBE

USER'S MANUAL

Revision 1.1c

The information in this User's Manual has been carefully reviewed and is believed to be accurate. The vendor assumes no responsibility for any inaccuracies that may be contained in this document, makes no commitment to update or to keep current the information in this manual, or to notify any person or organization of the updates. **Please Note: For the most up-to-date version of this manual, please see our web site at www.supermicro.com.**

Super Micro Computer, Inc. ("Supermicro") reserves the right to make changes to the product described in this manual at any time and without notice. This product, including software, if any, and documentation may not, in whole or in part, be copied, photocopied, reproduced, translated or reduced to any medium or machine without prior written consent.

IN NO EVENT WILL SUPER MICRO COMPUTER, INC. BE LIABLE FOR DIRECT, INDIRECT, SPECIAL, INCIDENTAL, SPECULATIVE OR CONSEQUENTIAL DAMAGES ARISING FROM THE USE OR INABILITY TO USE THIS PRODUCT OR DOCUMENTATION, EVEN IF ADVISED OF THE POSSIBILITY OF SUCH DAMAGES. IN PARTICULAR, SUPER MICRO COMPUTER, INC. SHALL NOT HAVE LIABILITY FOR ANY HARDWARE, SOFTWARE, OR DATA STORED OR USED WITH THE PRODUCT, INCLUDING THE COSTS OF REPAIRING, REPLACING, INTEGRATING, INSTALLING OR RECOVERING SUCH HARDWARE, SOFTWARE, OR DATA.

Any disputes arising between manufacturer and customer shall be governed by the laws of Santa Clara County in the State of California, USA. The State of California, County of Santa Clara shall be the exclusive venue for the resolution of any such disputes. Super Micro's total liability for all claims will not exceed the price paid for the hardware product.

FCC Statement: This equipment has been tested and found to comply with the limits for a Class B digital device pursuant to Part 15 of the FCC Rules. These limits are designed to provide reasonable protection against harmful interference in a residential installation. This equipment generates, uses, and can radiate radio frequency energy and, if not installed and used in accordance with the manufacturer's instruction manual, may cause interference with radio communications. However, there is no guarantee that interference will not occur in a particular installation. If this equipment does cause harmful interference to radio or television reception, which can be determined by turning the equipment off and on, you are encouraged to try to correct the interference by one or more of the following measures:

Reorient or relocate the receiving antenna.

Increase the separation between the equipment and the receiver.

Connect the equipment into an outlet on a circuit different from that to which the receiver is connected.

Consult the dealer or an experienced radio/television technician for help.

California Best Management Practices Regulations for Perchlorate Materials: This Perchlorate warning applies only to products containing CR (Manganese Dioxide) Lithium coin cells. "Perchlorate Material-special handling may apply. See www.dtsc.ca.gov/hazardouswaste/perchlorate".

WARNING: Handling of lead solder materials used in this product may expose you to lead, a chemical known to the State of California to cause birth defects and other reproductive harm.

Manual Revision: Rev. 1.1c

Release Date: July 20, 2009

Unless you request and receive written permission from Super Micro Computer, Inc., you may not copy any part of this document.

Information in this document is subject to change without notice. Other products and companies referred to herein are trademarks or registered trademarks of their respective companies or mark holders.

Copyright © 2009 by Super Micro Computer, Inc.
All rights reserved.

Printed in the United States of America

Preface

About This Manual

This manual is written for system integrators, PC technicians and knowledgeable PC users. It provides information for the installation and use of the **SUPER** C2SBA+II/C2SBA+/C2SBA/C2SBE motherboard. The C2SBA+II/C2SBA+/C2SBA/C2SBE supports single Intel Xeon 3000 Series/Core 2 Quad/Core 2 Duo Processor with a system bus speed of up to 1.33 GHz. The Intel Core 2 Quad/Core 2 Duo Processor supports the 775-Land Grid Array Package, which interfaces with the motherboard via an LGA775 socket. With the support of the Quad-Core/Dual-Core Technology, Wide Dynamic Execution, FSB Dynamic Bus Inversion (DBI), Advanced Digital Media Boost, Smart Memory Access, and Thermal Management 2 (TM2), the C2SBA+II/C2SBA+/C2SBA/C2SBE delivers unparalleled system performance and great power efficiency in a slim package. Please refer to the motherboard specifications pages on our web site (<http://www.supermicro.com/Products/>) for updates on supported processors. This product is intended to be professionally installed and serviced by a technician.

Manual Organization

Chapter 1 describes the features, specifications and performance of the mainboard and provides detailed information about the chipset.

Chapter 2 provides hardware installation instructions. Read this chapter when installing the processor, memory modules and other hardware components into the system.

If you encounter any problems, see **Chapter 3**, which describes troubleshooting procedures for the video, the memory and the system setup stored in the CMOS.

Chapter 4 includes an introduction to BIOS and provides detailed information on running the CMOS Setup utility.

Appendix A provides BIOS POST Messages.

Appendix B lists BIOS POST Codes.

Appendix C, Appendix D and **Appendix E** list HostRAID Setup Guidelines and Other Software Installation Instructions.

Conventions Used in the Manual:

Special attention should be given to the following symbols for proper installation and to prevent damage done to the components or injury to yourself:



Danger/Caution: Instructions to be strictly followed to prevent catastrophic system failure or to avoid bodily injury.



Warning: Important information given to ensure proper system installation or to prevent damage to the components.

Note: Additional Information given to differentiate various models or to ensure correct system setup.

Table of Contents

About This Manual	iii
Manual Organization	iii
Conventions Used in the Manual.....	iii

Chapter 1: Introduction

1-1 Overview	1-1
Checklist	1-1
Contacting Super Micro	1-2
SUPER [®] C2SBA+II/C2SBA+/C2SBA/C2SBE Image	1-3
SUPER [®] C2SBA+II/C2SBA+/C2SBA/C2SBE Layout.....	1-4
SUPER [®] C2SBA+II/C2SBA+/C2SBA/C2SBE Quick Reference.....	1-5
Motherboard Features	1-7
Intel G33/P35 Chipset: System Block Diagram	1-9
1-2 Chipset Overview	1-10
1-3 Recovery from AC Power Loss	1-11
1-4 PC Health Monitoring	1-11
1-5 ACPI Features	1-11
1-6 Power Supply	1-12
1-7 Versatile Media Capabilities	1-13
1-8 Super I/O	1-13

Chapter 2: Installation

2-1 Static-Sensitive Devices	2-1
2-2 Motherboard Installation	2-1
2-3 Processor and Heatsink Installation	2-2
2-4 Installing DDR2 Memory	2-6
2-5 Control Panel Connectors/IO Ports	2-8
Back Panel Connectors/IO Ports.....	2-8
Front Control Panel	2-9
Front Control Panel Pin Definitions	2-10
PWR LED	2-10
HDD LED.....	2-10
NIC1 LED Indicators	2-11
OH/Fan Fail LED	2-11
Reset Button.....	2-12
PWR Button.....	2-12
2-6 Connecting Cables	2-13
ATX/Auxiliary Power Connectors	2-13
Universal Serial Bus (USB).....	2-14

Chassis Intrusion	2-14
Fan Headers.....	2-15
VGA Connector	2-15
ATX PS/2 Keyboard and PS/2 Mouse Ports.....	2-16
Serial Ports.....	2-16
Wake-On-Ring	2-17
Wake-On-LAN	2-17
GLAN1 Port.....	2-18
Speaker Connector	2-18
High Definition Audio (HDA).....	2-19
CD Header/Auxiliary Audio Header.....	2-19
Front Panel Audio Control.....	2-20
Power LED	2-20
2-7 Jumper Settings	2-21
Explanation of Jumpers	2-21
GLAN Enable/Disable	2-21
CMOS Clear	2-22
Watch Dog Enable	2-22
PCI/PCI-Exp. Slots to SMB Speeds.....	2-23
Keyboard Wake-Up	2-23
IDE Enable/Disable	2-24
TPM Enable.....	2-24
Audio Enable	2-25
USB Wake-Up.....	2-26
2-8 Onboard Indicators	2-27
GLAN LED Indicators.....	2-27
Onboard Power LED	2-28
2-9 Parallel Port, Floppy Drive and IDE Hard Drive Connections	2-29
Parallel Port Connector.....	2-29
Floppy Connector.....	2-30
IDE Connectors	2-31

Chapter 3: Troubleshooting

3-1 Troubleshooting Procedures	3-1
Before Power On.....	3-1
No Power.....	3-1
No Video	3-1
Memory Errors.....	3-2
Losing the System's Setup Configuration	3-2

3-2	Technical Support Procedures	3-2
3-3	Frequently Asked Questions	3-3
3-4	Returning Merchandise for Service	3-5

Chapter 4: BIOS

4-1	Introduction	4-1
4-2	Running Setup	4-2
4-3	Main BIOS Setup	4-3
4-4	Advanced Setup	4-7
4-5	Security Setup	4-22
4-6	TPM State	4-24
4-7	Boot Setup	4-25
4-8	Exit	4-26

Appendices:

Appendix A:	BIOS POST Messages	A-1
Appendix B:	BIOS POST Codes	B-1
Appendix C:	Intel HostRAID Setup Guidelines	C-1
Appendix D:	The Adaptec HostRAID Setup Guidelines	D-1
Appendix E:	Installing Other Software Programs and Drivers	E-1

Chapter 1

Introduction

1-1 Overview

Checklist

Congratulations on purchasing your computer motherboard from an acknowledged leader in the industry. Super Micro boards are designed with the utmost attention to detail to provide you with the highest standards in quality and performance.

Please check that the following items have all been included with your motherboard. If anything listed here is damaged or missing, contact your retailer.

All the following items are included in the retail box only:

One (1) Super Micro Mainboard

One (1) floppy drive ribbon cable (CBL-022L)

Four (4) SATA cables (CBL-0044L) (For C2SBA+/C2SBA/C2SBE)

Six (6) SATA cables (CBL-0044L) (For the C2SBA+II only)

Two (2) IDE hard drive cables (CBL-0036L-3) (C2SBA+II/C2SBA+ Only)

One (1) Super Micro CD containing drivers and utilities

One (1) User's/BIOS Manual

Contacting Super Micro

Headquarters

Address: Super Micro Computer, Inc.
980 Rock Ave.
San Jose, CA 95131 U.S.A.

Tel: +1 (408) 503-8000

Fax: +1 (408) 503-8008

Email: marketing@supermicro.com (General Information)
support@supermicro.com (Technical Support)

Web Site: www.supermicro.com

Europe

Address: Super Micro Computer B.V.
Het Sterrenbeeld 28, 5215 ML
's-Hertogenbosch, The Netherlands

Tel: +31 (0) 73-6400390

Fax: +31 (0) 73-6416525

Email: sales@supermicro.nl (General Information)
support@supermicro.nl (Technical Support)
rma@supermicro.nl (Customer Support)

Asia-Pacific

Address: Super Micro, Taiwan
4F, No. 232-1 Liancheng Road
Chung-Ho 235, Taipei Hsien, Taiwan, R.O.C.

Tel: +886-(2) 8226-3990

Fax: +886-(2) 8226-3991

Web Site: www.supermicro.com.tw

Technical Support:

Email: support@supermicro.com.tw

Tel: 886-2-8228-1366, ext.132 or 139

SUPER C2SBA+II/C2SBA+/C2SBA/C2SBE Image

Note: All pictures and drawings shown in this manual were based upon the latest PCB revision available at the time of publishing of the manual. The motherboard you've received may or may not look exactly the same as those in this manual.

Motherboard Layout

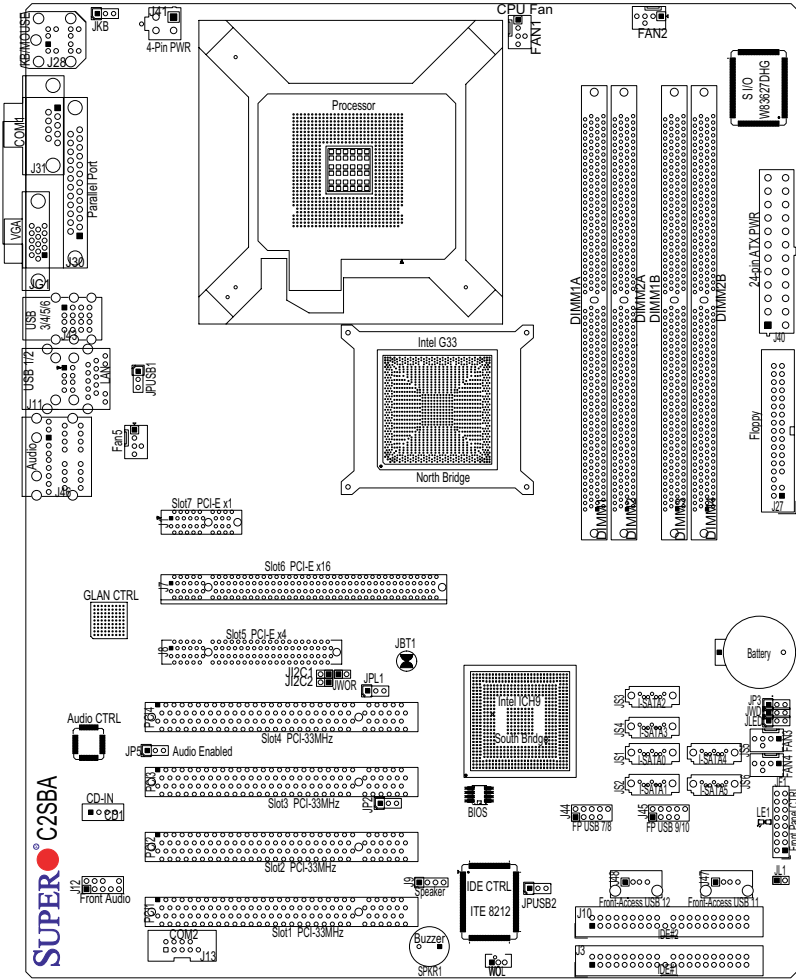

(Please see important notes on Page 1-6.)

C2SBA+II/C2SBA+/C2SBA/C2SBE Quick Reference

Jumpers	Description	Default Setting
JBT1	CMOS Clear	(See Chapter 2)
JKB	Keyboard Enabled	Pins 1-2 (Enabled)
J1 ² C1/J1 ² C2	SMB to PCI Slots	Open/Open (Disabled)
JP2	ITE IDE Enabled	Pins 1-2 (Enabled) (See Note 4)
JP3	TPM Enabled	Pins 1-2 (Enabled) (See Note 6)
JP5	Audio Enabled	Pins 1-2 (Enabled)
JPL1	Giga-bit LAN Enab.	Pins 1-2 (Enabled)
JPUSB1	B/P USB Wake Up	Pins 2-3 (Disabled)
JPUSB2	F/P USB Wake Up	Pins 2-3 (Disabled)
JWD	Watch Dog Enable	Pins 1-2 (Reset)
Connectors	Description	
Audio	Audio Port (J46)	
(FP) Audio	Front Panel Audio Connector (J12)	
CD1	Audio CD Input (CD-In) Header	
COM1/COM2	COM Port/Serial Port 1 & Port 2 Connectors (J31, J13)	
DIMM#1A,#2A,#1B,#2B	Memory (DIMM) Slots (1 through 4)	
Fans 1-5	Fan1: CPU Fan, Fan2-5: System/Chassis Fan Headers	
Floppy	Floppy Disk Connector (J27)	
Front Control Panel	Front Control Panel Header (JF1)	
IDE#1/IDE#2	IDE Hard Drive #1 & Hard Drive #2 (See Note 4)	
J9	Speaker Header	
J40	ATX 24-Pin Power Connector	
J41	12V 4-pin Power Connector (Required connection)	
JL1	Chassis Intrusion Header	
JLED	Onboard Power LED Indicator	
KB/Mouse	PS/2 Keyboard/Mouse (J28)	
LE1	Standby Power LED Indicator	
Parrallel	Parallel Printer Port (J30)	
SATA 0/1/4/5	Intel SATA (#0/1/4/5) Headers (See Note 8)	
Slot 1-Slot 4	PCI 33 MHz (PCI #1-#4) (See Note 5)	
Slots 5-7	PCI-E x4 (Slot5), PCI-E x16 (Slot6), PCI-Ex1 (Slot7)	
(BP) USB 1/2 & GLAN	(Back Panel) Universal Serial Ports 1-2 & G-LAN Port	
(BP) USB 3-6	(Back Panel) Universal Serial Ports 3-6 (J43)	
(FP) USB 7/8, 9/10	(Front Panel) USB ports 7/8 (J44), USB 9/10 (J45)	
(FP) USB 11, 12	Front-Accessible USB ports #11 (J47), USB #12 (J48)	
VGA	Video/Graphics Connector (See Note 7)	
WOL	Wake-On-LAN Header	
WOR	Wake-On-Ring Header	

(All notes indicated above are listed on Page 1-6.)

Important Notes to the User

- 1. Jumpers not indicated are for testing only.
- 2. See Chapter 2 for detailed information on CPU/Heatsink installation, memory population, jumpers, connectors, I/O ports and JF1 front panel connections.
- 3. "■" indicates the location of "Pin 1."
- 4. IDE is available on the C2SBA/C2SBA+/C2SBA+II only.
- 5. PCI Slot 4 is not available on the C2SBA+/C2SBA+II.
- 6. Trusted Platform Module (TPM) support is available on the C2SBA and C2SBA+II/C2SBA+ only.
- 7. VGA is not available on the C2SBE.
- 8. The ICH9R and SATA Ports 2 & 3 (JS3/4) are available on the C2BA+II.
- 9. G33 is available on the C2SBA/C2SBA+II/C2SBA+. P35 is available on the C2SBE only.

Overclocking Considerations



Warning: Please be aware of the following conditions when "overclocking" is used:

Setting a high CPU FSB Speed (overclocking), DRAM Frequency or selecting a high CPU V-Core voltage, memory voltage, chipset voltage, ICH chipset voltage, or the FSB termination voltage may result in system instability. If this occurs, revert the setting to the default setting. In addition, extra fans may be needed for proper system cooling. The C2SBA+II/C2SBA+/C2SBA/C2SBE offers the option of "overclocking"; however, Super Micro is not responsible for any damage caused by the use of overclocking.

Motherboard Features

CPU

- Single Intel Xeon 3000 Series/Core 2 Quad/Core 2 Duo Processor with a system bus speed of 1.33 GHz/1.066 GHz
- Supports Intel Dual Core Technology, Hyper-Threading, Wide Dynamic Execution, FSB Dynamic Bus Inversion (DBI), Advanced Digital Media Boost, Smart Memory Access, and Thermal Management 2 (TM2)

Memory

- Supports unbuffered single or dual channel Non ECC Unbuffered DDR2 up to 8GB/s (DDR2 800/667) for single channel mode or dual-channel Interleaved mode.

Chipset

- Intel G33/P35 GMCH (North Bridge), ICH9/ICH9R (South Bridge)

Expansion Slots

- One (1) PCI-Express x16 (Slot 6)
- One (1) PCI-Express x4 (Slot 5)
- One (1) PCI-Express x1 (Slot 7)
- Four (4) 32-bit PCI 33MHz (Slot 1 to Slot 4) (Slot 4: Not available on the C2SBA+II/C2SBA+)

BIOS

- DMI 2.3, PCI 2.2, ACPI 1.0/2.0, SMBIOS 2.3, and Plug and Play (PnP)

PC Health Monitoring

- Onboard voltage monitors for CPU Core Voltage, Memory Voltage, +1.8V, +3.3V, +3.3V standby, +5V, Vbat (battery voltage) and $\pm 12V$
- Fan status monitor with firmware 4 pin fan speed control
- CPU 3-Phase-switching voltage regulator
- SuperDoctor III, Watch Dog, NMI
- Power-up mode control for recovery from AC power loss
- CPU/System overheat LED and control
- System resource alert via Supero Doctor III
- Auto-switching voltage regulator for the CPU core
- CPU Thermal Trip support
- Thermal Monitor 2 (TM2) support
- Trusted Platform Module (TPM) support

ACPI Features

- Slow blinking LED for suspend state indicator
- BIOS support for USB keyboard
- Main switch override mechanism
- External modem ring-on

Onboard I/O

- Built in ICH9 SATA Controller, 4 connectors for 4 devices (For the C2SBA+/C2SBA/C2SBE)
- Built in ICH9R SATA Controller, 6 connectors for 6 devices (For the C2SBA+II)
- 1 floppy port interface (up to 2.88 MB)
- 1 Fast UART 16550 compatible serial port/header
- Intel 82566 Gigabit Ethernet Controller
- PS/2 mouse and PS/2 keyboard ports
- ITE-8212 IDE controller or ITE-8211 IDE controller (for PCB Rev. 1.2a and above) supports two IDE hard drives (for the C2SBA+II/C2SBA+ only)
- Up to 12 USB (Universal Serial Bus) 2.0 ports for a speed of up to 480Mbps
- Realtek ALC 883 7.1 Channel High Definition Audio (HDA) codec supports 10 DAC Channels
- Built-in GMCH and onboard VGA connector (Not available on C2SBE)

Other

- Trusted Platform Module (TPM) 1.2 support (For the C2SBA/C2SBA+II/C2SBA+ only)
- Wake-on-LAN
- Wake-on-Ring (WOR)
- System Bus Clock Frequency Selection (Overclocking) Support (Note)
- Suspend-to-RAM
- Onboard +3V Standby Power Warning LED ("LE1")
- Pb Free

CD Utilities

- BIOS flash upgrade utility
- Drivers and software for Intel G33/P35 chipset utilities

Dimensions

- ATX form factor, 12.0" x 9.6" (304.8 x 243.8 mm)

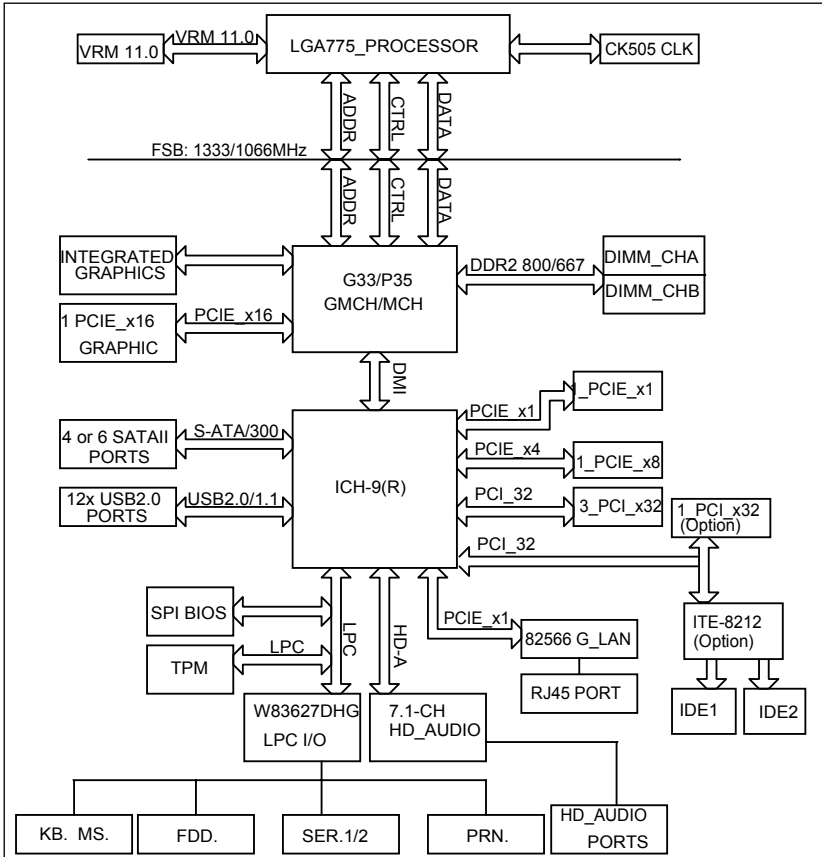

The Intel G33/P35 Chipset: System Block Diagram

Note: This is a general block diagram and may not exactly represent the features on your motherboard. See the following pages for the actual specifications of each motherboard.

Note 1: Integrated Graphics support is not available for the P35 Chipset.

Note 2: ICH9R is available on the C2SBA+II only.

1-2 Chipset Overview

The Intel G33/P35 chipset is specially designed for use with the Intel dual core processors. It consists of two primary components: the Graphic Memory Controller Hub (GMCH) and the I/O Controller Hub (ICH9/ICH9R). The GMCH (North Bridge) manages the data flow between the CPU interface (FSB), the System Memory interface, the External Graphics interface, and the I/O Controller through the DMI (Direct Media) Interface. The ICH9/ICH9R (South Bridge) provides a multitude of I/O related functions.

Graphic Memory Controller Hub (GMCH)

Utilizing a single LGA 775 socket processor, the G33/P35 GMCH supports an FSB frequency of 1.33 GHz/1.06 GHz. Host-initiated I/O cycles are decoded to the PCI-Express, the DMI, or the GMCH configuration space. Host-initiated memory cycles are decoded to PCI-Express, DMI or system memory. The GMCH supports 36-bit host bus addressing and a Cache Line Size of 64 bytes.

The GMCH supports one or two channels of DDR2 memory with up to two DIMMs per channel with a maximum bandwidth of 6.4 GB/s in asymmetric mode or 12.8 GB/s in symmetric mode using DDR2 800 MHz memory. It also supports an opportunistic refresh scheme, a memory thermal management scheme and Partial Writes to Memory using Data Mask (DM) signals.

The GMCH contains one PCI-Express x16 (16-lane) port intended for an external PCI-Express graphics card that is compatible with the PCI Express Base Specification revision 1.1. This PCI-E x16 port runs at a frequency of 2.5 GB/s on each lane and supports a maximum theoretical bandwidth of 40 GB/s in each direction for an aggregate of 8 GB/s @ x16. It supports traditional PCI-/AGP- style traffic and a PCI-Exp. Enhanced Addressing Mechanism with advanced capabilities in automatic discovery, negotiation and training of link out of reset.

Providing the high-speed, chip-to-chip connection between the GMCH and ICH9/ICH9R is the Direct Media Interface (DMI). The DMI integrates advanced priority-based servicing, allowing for concurrent traffic, true isochronous transfer capabilities and permitting current as well as legacy software to function seamlessly.

Intel ICH9/ICH9R System Features

The Intel 9th Generation I/O Controller Hub (ICH9/ICH9R) supports a variety of I/O related functions and PCI devices, including the following:

- DMI-to PCI Bridge
- LPC Controller
- Thermal Subsystem
- SMBus Controller
- USB FS/LS UHCI Controllers #1, #2 and #3

1-3 Recovery from AC Power Loss

BIOS provides a setting for you to determine how the system will respond when AC power is lost and then restored to the system. You can choose for the system to remain powered off (in which case you must hit the power switch to turn it back on) or for it to automatically return to a power on state. See the Power Lost Control setting in the BIOS chapter of this manual to change this setting. The default setting is **Last State**.

1-4 PC Health Monitoring

This section describes the PC health monitoring features of the C2SBA+II/C2SBA+/C2SBA/C2SBE. The motherboard has an onboard System Hardware Monitor chip that supports PC health monitoring.

Onboard Voltage Monitors for the CPU Core, +1.8V, +3.3V, +3.3V standby, +5V, Vbat and $\pm 12V$

The onboard voltage monitor will scan these voltages continuously. Once a voltage becomes unstable, it will give a warning or send an error message to the screen. Users can adjust the voltage thresholds to define the sensitivity of the voltage monitor by using SuperO Doctor III.

1-5 ACPI Features

ACPI stands for Advanced Configuration and Power Interface. The ACPI specification defines a flexible and abstract hardware interface that provides a standard to integrate power management features throughout a PC system, including its hardware, operating system and application software. This enables the system to automatically turn on and off peripherals such as CD-ROMs, network cards, hard disk drives and printers. This also includes consumer devices connected to the PC such as VCRs, TVs, telephones and stereos.

In addition to enabling operating system-directed power management, ACPI provides a generic system event mechanism for Plug and Play and an operating-system-independent interface for configuration control. ACPI leverages the Plug and Play BIOS data structures while providing a processor architecture-independent implementation that is compatible with Windows 2000, Windows XP, Windows 2003, Windows 2003 Servers.

Enhanced Power Management

The onboard ICH9/ICH9R chip provides advanced power management functions that will greatly improve the performance of various low-power (suspend) states and

enhance clock control. A hardware-based component provides software-independent thermal management that is compatible with the ACPI Revision 3.0a.

Slow Blinking LED for Suspend-State Indicator

When the CPU goes into a suspend state, the chassis power LED will start blinking to indicate that the CPU is in suspend mode. When the user presses any key, the CPU will wake-up and the LED will automatically stop blinking and remain on.

BIOS Support for USB Keyboard

If the USB keyboard is the only keyboard in the system, it will function like a normal keyboard during system boot-up.

Wake-On-LAN (WOL)

Wake-On-LAN is defined as the ability of a management application to remotely power up a computer that is powered off. Remote PC setup, up-dates and asset tracking can occur after hours and on weekends so that daily LAN traffic is kept to a minimum and users are not interrupted. The motherboard has a 3-pin header (WOL) to connect to the 3-pin header on a Network Interface Card (NIC) that has WOL capability. In addition, an onboard LAN controller can also support WOL without any connection to the WOL header. The 3-pin WOL header is to be used with a LAN add-on card only.

Note: Wake-On-LAN requires an ATX 2.01 (or above) compliant power supply.

1-6 Power Supply

As with all computer products, a stable power source is necessary for proper and reliable operation. It is even more important for processors that have high CPU clock rates of 1 GHz and faster.

The **SUPER** C2SBA+II/C2SBA+/C2SBA/C2SBE accommodates 12V ATX power supplies. Although most power supplies generally meet the specifications required by the CPU, some are inadequate. A 2-Amp of current supply on a 5V Standby rail is strongly recommended.

It is strongly recommended that you use a high quality power supply that meets 12V ATX power supply Specification 1.1 or above. It is also required that the 12V 4-pin power connection (J41) be used for high-load configurations. In areas where noisy power transmission is present, you may choose to install a line filter to shield the computer from noise. It is recommended that you also install a power surge protector to help avoid problems caused by power surges.

1-7 Versatile Media Capabilities

High Definition Audio

The High Definition Audio Controller embedded in the ICH9/ICH9R delivers up to 4 codecs that can be used for different types of codecs, such as audio and modem codecs. Operating at 3.3V or 1.5V, the embedded Audio Controller supports a multi-channel audio stream, 32-bit sample depth, up to 192 kHz of same rate, and can be used with a variety of microphones for input. With these versatile audio capabilities built in, the C2SBA+II/C2SBA+/C2SBA/C2SBE provides the user with a surreal audio experience that is larger than life.

I/O Virtualization Technology (VT-d)

With the Intel ICH9 built in, the C2SBA+II/C2SBA+/C2SBA/C2SBE supports I/O Virtualization Technology (VT-d) that enables multiple operating systems and applications to run in independent partitions. Each partition uses its own subset of host physical memory, and behaves like a virtual machine (VM), providing isolation and protection across multiple partitions. This feature is available when a processor that supports the virtualization of platforms is installed on the motherboard.

1-8 Super I/O

The disk drive adapter functions of the Super I/O chip include a floppy disk drive controller that is compatible with industry standard 82077/765, a data separator, write pre-compensation circuitry, decode logic, data rate selection, a clock generator, drive interface control logic and interrupt and DMA logic. The wide range of functions integrated onto the Super I/O greatly reduces the number of components required for interfacing with floppy disk drives. The Super I/O supports two 360 K, 720 K, 1.2 M, 1.44 M or 2.88 M disk drives and data transfer rates of 250 Kb/s, 500 Kb/s or 1 Mb/s.

It also provides two high-speed, 16550 compatible serial communication ports (UARTs). Each UART includes a 16-byte send/receive FIFO, a programmable baud rate generator, complete modem control capability and a processor interrupt system. Both UARTs provide legacy speed with baud rate of up to 115.2 Kbps as well as an advanced speed with baud rates of 250 K, 500 K, or 1 Mb/s, which support higher speed modems.

The Super I/O provides functions that comply with the ACPI (Advanced Configuration and Power Interface), which includes support of legacy and ACPI power management through a SMI or SCI function pin. It also features auto power management to reduce power consumption.

Notes

Chapter 2

Installation

2-1 Static-Sensitive Devices

Electro-Static-Discharge (ESD) can damage electronic components. To prevent damage to your system board, it is important to handle it very carefully. The following measures are generally sufficient to protect your equipment from ESD.

Precautions

- Use a grounded wrist strap designed to prevent static discharge. Touch a grounded metal object before removing the board from the antistatic bag.
- Handle the board by its edges only; do not touch its components, peripheral chips, memory modules or gold contacts.
- When handling chips or modules, avoid touching their pins.
- Put the motherboard and peripherals back into their antistatic bags when not in use.
- For grounding purposes, make sure your computer chassis provides excellent conductivity between the power supply, the case, the mounting fasteners and the motherboard.
- Use only the correct type of onboard CMOS battery as specified by the manufacturer. Do not install the onboard battery upside down to avoid possible explosion.

Unpacking

The motherboard is shipped in antistatic packaging to avoid static damage. When unpacking the board, make sure the person handling it is static protected.

2-2 Motherboard Installation

Note: Be sure to mount the motherboard into the chassis before you install the CPU onto the motherboard.

All motherboards have standard mounting holes to fit different types of chassis. Make sure that the locations of all the mounting holes for both motherboard and chassis match. Make sure that the metal standoffs click in or are screwed in tightly. Then use a screwdriver to secure the motherboard onto the motherboard tray. (**Caution:** 1. Please do not use a force greater than 8 lb/inch on each mounting screw during motherboard installation. 2. Some components are very close to the mounting holes. Please take precautionary measures to prevent damage to these components when installing the motherboard to the chassis.)

2-3 Processor and Heatsink Fan Installation



When handling the processor package, avoid placing direct pressure on the label area of the fan.

Notes: 1. Always connect the power cord last and always remove it before adding, removing or changing any hardware components. Make sure that you install the processor into the CPU LGA 775 socket before you install the CPU heatsink.

2. The Intel LGA 775 Processor package contains the CPU fan and heatsink assembly. If you buy a CPU separately, make sure that you use only Intel-certified multi-directional heatsink and fan.

3. Make sure to install the motherboard into the chassis before you install the CPU heatsink and fan.

4. When purchasing an LGA 775 Processor or when receiving a motherboard with an LGA 775 Processor pre-installed, make sure that the CPU plastic cap is in place and none of the CPU pins are bent; otherwise, contact the retailer immediately.

5. Refer to the MB Features Section for more details on CPU support.

Installation of the LGA 775 Processor

1. Press the load lever to release the load plate, which covers the CPU socket, from its locking position.

2. Gently lift the load lever to open the load plate.

Load Lever

PnP Cap on
top of the
Load Plate

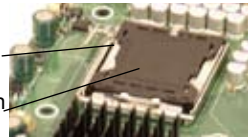

Load Plate
(with PnP Cap
attached)

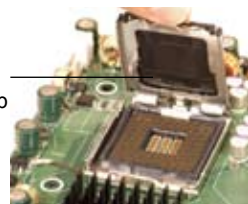

3. Use your thumb and your index finger to hold the CPU at the North Center Edge and the South Center Edge of the CPU.

4. Align CPU Pin1 (the CPU corner marked with a triangle) against the socket corner that is marked with a triangle cutout.

5. Align the CPU key that is the semi-circle cutout below a golden dot against the socket key, the Notch on the same side of the triangle cutout on the socket.

6. Once aligned, carefully lower the CPU straight down to the socket. (**Note:** Do not drop the CPU on the socket. Do not move the CPU horizontally or vertically. Do not rub the CPU against the surface or against any pins of the socket to avoid damage to the CPU or the socket.)

7. With the CPU inside the socket, inspect the four corners of the CPU to make sure that the CPU is properly installed.

8. Use your thumb to gently push the load lever down to the lever lock.

9. If the CPU is properly installed into the socket, the plastic PnP cap will be automatically released from the load plate when the load lever is pushed in the lever lock. Remove the PnP cap from the motherboard.

 (**Warning:** Please save the plastic PnP cap. The motherboard must be shipped with the PnP cap properly installed to protect the CPU socket pins. Shipment without the PnP cap properly installed will cause damage to the socket pins.)

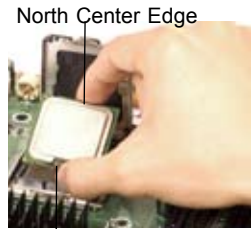

South Center Edge

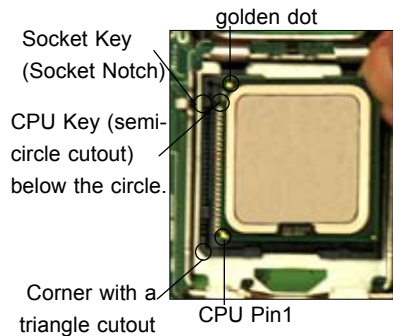

Load Lever

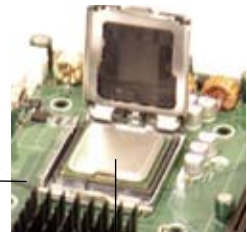

CPU in the CPU socket



Plastic cap is released from the load plate if CPU properly installed.



Installation of the Heatsink

1. Locate the CPU Fan on the motherboard. (Refer to the layout on the right for the CPU Fan location.)
2. Position the heatsink in such a way that the heatsink fan wires are closest to the CPU fan and are not interfered with other components.
3. Inspect the CPU Fan wires to make sure that the wires are routed through the bottom of the heatsink.

4. Remove the thin layer of the protective film from the copper core of the heatsink.

(Warning: CPU overheat may occur if the protective film is not removed from the heatsink.)

5. Apply the proper amount of thermal grease on the CPU. (**Note:** if your heatsink came with a thermal pad, please ignore this step.)

6. If necessary, rearrange the wires to make sure that the wires are not pinched between the heatsink and the CPU. Also make sure to keep clearance between the fan wires and the fins of the heatsink.

7. Align the four heatsink fasteners with the mounting holes on the motherboard. Gently push the pairs of diagonal fasteners (#1 & #2, and #3 & #4) into the mounting holes until you hear a click. (**Note:** Make sure to orient each fastener in a way that the narrow end of the groove is pointing outward.)

Thermal Grease

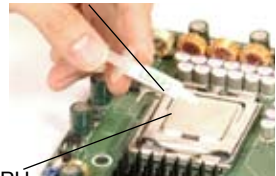

CPU

Fan Wires

Heatsink Fins



Heatsink Fastener

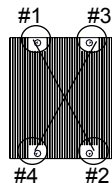

Narrow end of the groove points outward

8. Repeat Step 6 to insert all four heatsink fasteners into the mounting holes.

9. Once all four fasteners are securely inserted into the mounting holes and the heatsink is properly installed on the motherboard, connect the heatsink fan wires to the CPU Fan connector.

Heatsink Removal

1. Unplug the power cord from the power supply.

2. Disconnect the heatsink fan wires from the CPU fan header.

3. Use your finger tips to gently press on the fastener cap and turn it counterclockwise to make a 1/4 (90°) turn, and then pull the fastener upward to loosen it.

4. Repeat Step 3 to loosen all fasteners from the mounting holes.

5. With all fasteners loosened, remove the heatsink from the CPU.



2-4 Installing DIMMs

Note: Check the Super Micro web site for recommended memory modules.



CAUTION

Exercise extreme care when installing or removing DIMM modules to prevent any possible damage. Also note that the memory is interleaved to improve performance (See step 1).

DIMM Installation

1. Insert the desired number of DIMMs into the memory slots, starting with DIMM1A. The memory scheme is interleaved so you must install two modules at a time, beginning with DIMM1A, DIMM1B, then, DIMM2A and DIMM2B
2. Insert each DIMM module vertically into its slot. Pay attention to the notch along the bottom of the module to prevent inserting the DIMM module incorrectly.
3. Gently press down on the DIMM module until it snaps into place in the slot. Repeat for all modules (See step 1 above).

Memory Support

The C2SBA+II/C2SBA+/C2SBA/C2SBE supports up to 8 GB Unbuffered Non-ECC DDR2 800/677 MHz in 4 DIMMs. Populating DIMM#1A, DIMM#1B, and/or DIMM#2A, DIMM#2B with memory modules of the same size and of the same type will result in dual channel, two-way interleaved memory which is faster than the single channel, non-interleaved memory.

Notes:

1. Due to the OS limitations, some operating systems may not show more than 4 GB of memory.
2. Both Unbuffered ECC and Non-ECC memory modules can be installed in the memory slots. However, the functionality of ECC is not supported by the chipset.
3. Due to memory allocation to system devices, memory remaining available for operational use will be reduced when 4 GB of RAM is used. The reduction in memory availability is disproportional. (Refer to the following Memory Availability Table for details.) For Microsoft Windows users: Microsoft implemented a design change in Windows XP with Service Pack 2 (SP2) and Windows Vista. This change is specific to the Physical Address Extension (PAE) mode behavior which improves driver compatibility. For more information, please read the following article at Microsoft's Knowledge Base website at: <http://support.microsoft.com/kb/888137>.

Possible System Memory Allocation & Availability		
System Device	Size	Physical Memory Remaining (-Available) (4 GB Total System Memory)
Firmware Hub flash memory (System BIOS)	1 MB	3.99
Local APIC	4 KB	3.99
Area Reserved for the chipset	2 MB	3.99
I/O APIC (4 Kbytes)	4 KB	3.99
PCI Enumeration Area 1	256 MB	3.76
PCI Express (256 MB)	256 MB	3.51
PCI Enumeration Area 2 (if needed) -Aligned on 256-MB boundary-	512 MB	3.01
VGA Memory	16 MB	2.85
TSEG	1 MB	2.84
Memory available to OS and other applications		2.84

Installing and Removing DIMMs

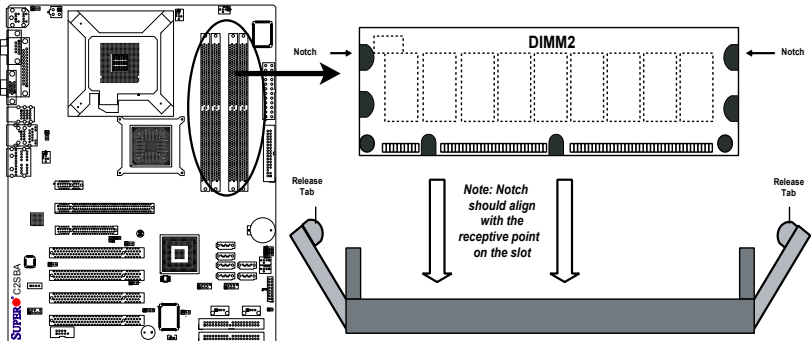

To Install: Insert module vertically and press down until it snaps into place. Pay attention to the alignment notch at the bottom.

To Remove:
Use your thumbs to gently push the release tabs near both ends of the module. This should release it from the slot.

Top View of DDR2 Slot

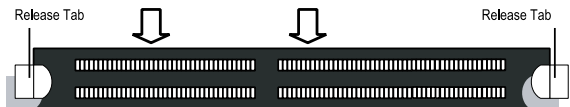

2-5 Control Panel Connectors/IO Ports

The I/O ports are color coded in conformance with the PC 99 specification. See the graphics below for the colors and locations of the various I/O ports.

Back Panel Connectors/IO Ports

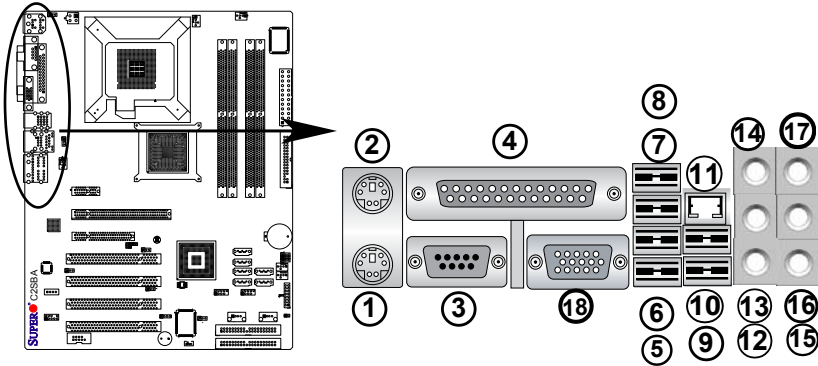

Back Panel I/O Port Locations and Definitions

Back Panel Connectors

1. Keyboard (Purple)
2. PS/2 Mouse (Green)
3. COM Port 1 (Turquoise)
4. Parallel Port (Printer)
5. Back Panel USB Port 3
6. Back Panel USB Port4
7. Back Panel USB Port 5
8. Back Panel USB Port 6
9. Back Panel USB Port 1
10. Back Panel USB Port 2
11. Gigabit LAN 1
12. Side_Surround (Grey)
13. Back_Surround (Black)
14. CEN/LFE (Orange)
15. Microphone-In (Pink)
16. Front (Green)
17. Line-In (Blue)
18. VGA (Not included on the C2SBE)

Front Control Panel

JF1 contains header pins for various buttons and indicators that are normally located on a control panel at the front of the chassis. These connectors are designed specifically for use with Super Micro server chassis. See the pictures below for the descriptions of the various control panel buttons and LED indicators. Refer to the following section for descriptions and pin definitions.

JF1 Header Pins

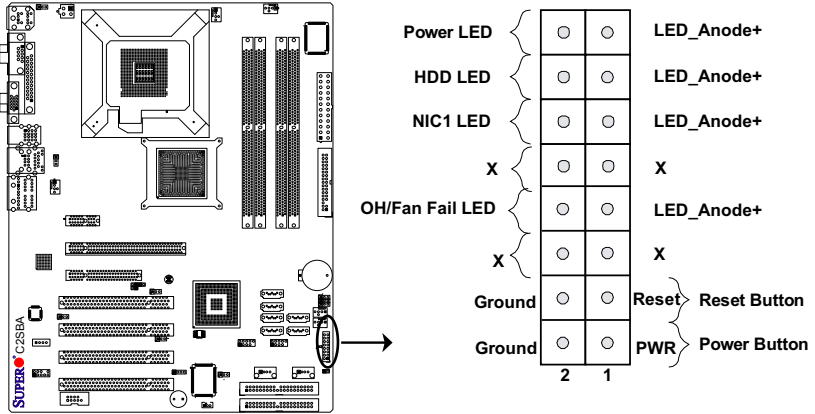

Front Control Panel Pin Definitions

Power LED

The Power LED connection is located on pins 15 and 16 of JF1. Refer to the table on the right for pin definitions.

Power LED Pin Definitions	
Pin#	Definition
15	LED_Anode+
16	PWR LED Signal

HDD LED

The HDD LED connection is located on pins 13 and 14 of JF1. Attach a hard drive LED cable here to display disk activity (for any hard drives on the system, including SAS and Serial ATA). See the table on the right for pin definitions.

HDD LED Pin Definitions	
Pin#	Definition
13	LED_Anode+
14	HD Active

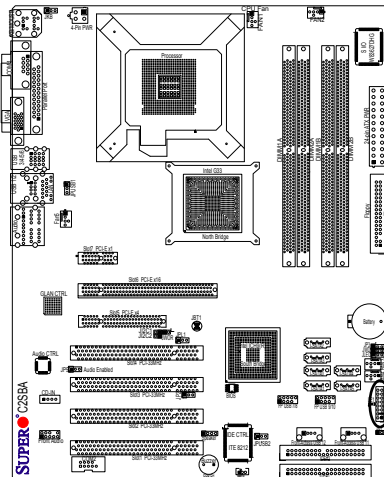

A. PWR LED

B. HDD LED

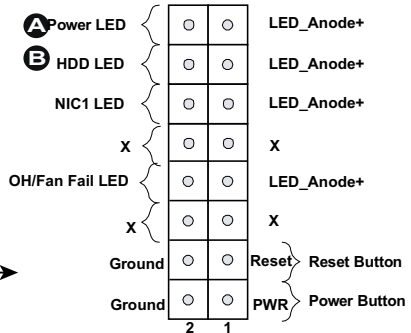

NIC1 Indicator

The NIC (Network Interface Controller) LED connection for the GLAN port is located on pins 11 and 12 of JF1. Attach the NIC LED cables to display network activity. Refer to the table on the right for pin definitions.

GLAN1/2 LED Pin Definitions	
Pin#	Definition
11	LED_Anode+
12	NIC1 LED Signal

Overheat/Fan Fail LED (OH)

Connect an LED to the OH/Fan Fail LED connection on pins 7 and 8 of JF1 to provide advanced warnings of chassis overheating or fan failure. Refer to the table on the right for pin definitions.

OH/Fan Fail LED Pin Definitions	
Pin#	Definition
7	LED_Anode+
8	OH/Fan Fail LED Signal

OH/Fan Fail Indicator Status	
State	Definition
Off	Normal
On	Overheat
Flash- ing	Fan Fail

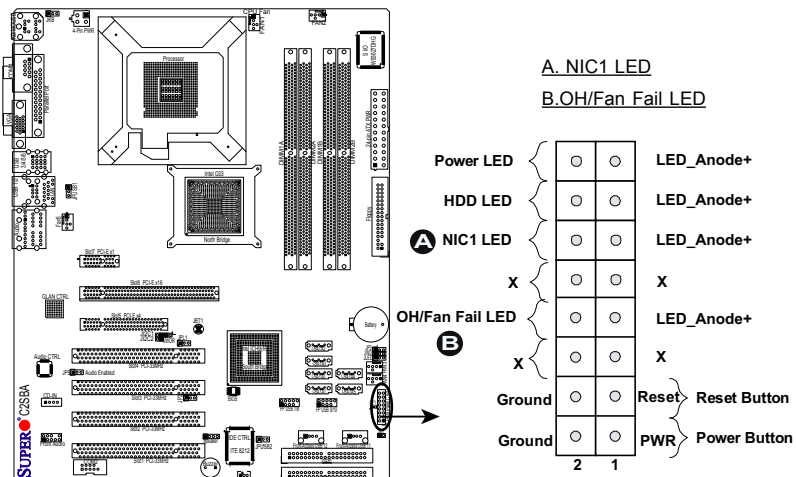

Reset Button

The Reset Button connection is located on pins 3 and 4 of JF1. Attach it to a hardware reset switch on the computer case. Refer to the table on the right for pin definitions.

Reset Button Pin Definitions	
Pin#	Definition
3	Reset
4	Ground

Power Button

The Power Button connection is located on pins 1 and 2 of JF1. Momentarily contacting both pins will power on/off the system. This button can also be configured to function as a suspend button (with a setting in the BIOS - see Chapter 4). To turn off the power when set to suspend mode, press the button for at least 4 seconds. Refer to the table on the right for pin definitions. (**Note:** Do not close or short Pins 1 & 2 since this will cause the system to continuously reboot.)

Power Button Pin Definitions	
Pin#	Definition
1	Power On
2	Ground

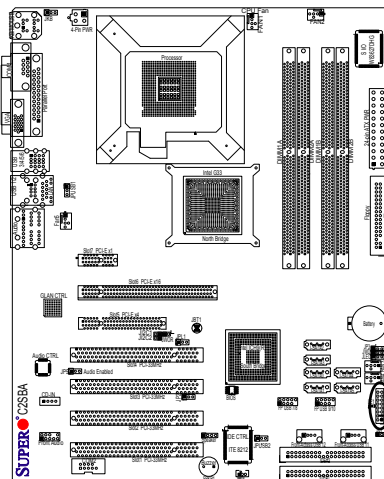

A. Reset
B. PWR Button

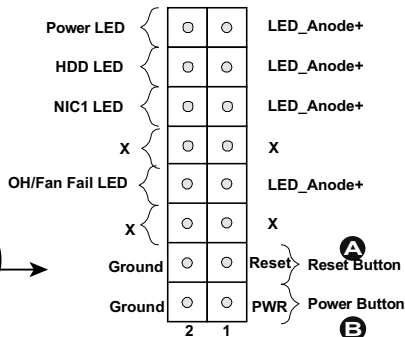

2-6 Connecting Cables

ATX Main Power Connector

A 24-pin main power connector is located at J40. This power connector meets the SSI EPS 12V specification. See the table on the right for pin definitions.

ATX Power 24-pin Connector Pin Definitions			
Pin#	Definition	Pin #	Definition
13	+3.3V	1	+3.3V
14	-12V	2	+3.3V
15	COM	3	COM
16	PS_ON	4	+5V
17	COM	5	COM
18	COM	6	+5V
19	COM	7	COM
20	Res (NC)	8	PWR_OK
21	+5V	9	5VSB
22	+5V	10	+12V
23	+5V	11	+12V
24	COM	12	+3.3V

4-pin CPU Power Connector

A 4-pin 12V power connector is located at J41 on the motherboard. This power connector also meets the SSI EPS 12V specification, and is required to ensure adequate power to the processor. See the table on the right for pin definitions.

12V 4-pin Power Connector Pin Definitions	
Pins	Definition
1 and 2	Ground
3 and 4	+12V

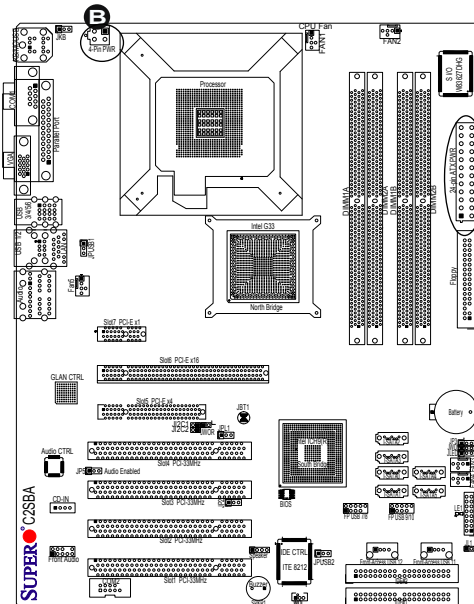

A. 24-pin ATX PWR

B. 4-pin PWR

Universal Serial Bus (USB)

There are 12 USB 2.0 (Universal Serial Bus) ports/headers on the motherboard. Six of them are Back Panel USB ports: USB#1/2 (J11) and USB#3/4/5/6 (J43). USB #7/8 (J44) and USB#9/10 (J45) are headers that can be used for front panel connections. Additionally, USB#11(J47) and USB#12 (J48) are onboard USB connectors that can be accessed from the front side of the chassis. See the tables on the right for pin definitions.

Back Panel USB (1-6) Pin Definitions	
Pin#	Definitions
1	+5V
2	PO-
3	PO+
4	Ground
5	N/A

Front Panel USB (#7/8/9/10) and Front-Accessible Onboard USB (#11/12) Connections			
Pin #	Definition	Pin #	Definition
1	+5V	1	+5V
2	PO-	2	PO-
3	PO+	3	PO+
4	Ground	4	Ground
5	Key	5	No connection

Chassis Intrusion

A Chassis Intrusion header is located at JL1 on the motherboard. Attach an appropriate cable from the chassis to inform you of a chassis intrusion when it is opened.

Chassis Intrusion Pin Definitions	
Pin#	Definition
1	Intrusion Input
2	Ground

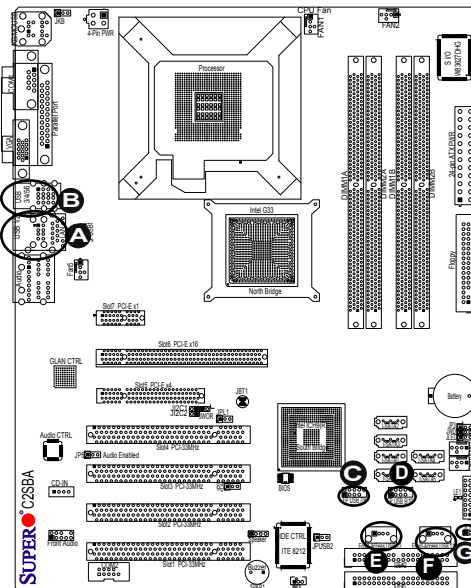

Fan Headers

The C2SBA+II/C2SBA+/C2SBA/C2SBE has five chassis fan headers (Fan 1 to Fan 5). Fan 1 is the CPU Fan. Fan 2 to Fan 5 are system/chassis fans. (**Note:** Pins 1-3 of a 4-pin fan headers are backward compatible with the traditional 3-pin fans.) See the table on the right for pin definitions. The onboard fan speeds are controlled by Thermal Management via BIOS Hardware Monitoring in the Advanced Setting. (**Note:** Default: Disabled. When using Thermal Management settings, please use all 3-pin fans or all 4-pin fans on the motherboard.)

Fan Header Pin Definitions	
Pin#	Definition
1	Ground
2	+12V
3	Tachometer
4	PWR Modulation

VGA Connector (Not available on the C2SBE)

A VGA connector (JG1) is located next to the USB ports on the IO backplane. Refer to the board layout below for the location.

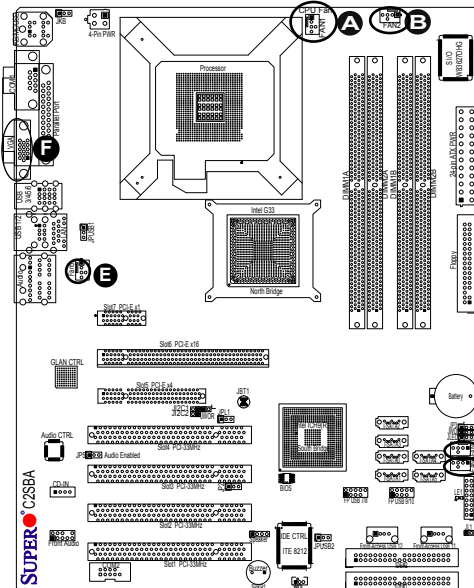

- A. Fan 1 (CPU Fan)
- B. Fan 2
- C. Fan 3
- D. Fan 4
- E. Fan 5
- F. VGA

ATX PS/2 Keyboard and PS/2 Mouse Ports

The ATX PS/2 keyboard and the PS/2 mouse are located at J28. See the table on the right for pin definitions. (The mouse port is above the keyboard port. See the table on the right for pin definitions.)

PS/2 Keyboard and Mouse Port Pin Definitions	
Pin#	Definition
1	Data
2	NC
3	Ground
4	VCC
5	Clock
6	NC

Serial Ports

COM1 (J31) is a connector located on the IO Backpanel and COM2 is a header located at J13. See the table on the right for pin definitions.

Serial Port Pin Definitions			
Pin #	Definition	Pin #	Definition
1	DCD	6	DSR
2	RXD	7	RTS
3	TXD	8	CTS
4	DTR	9	RI
5	Ground	10	NC

(Pin 10 is available on COM2 only. NC: No Connection.)

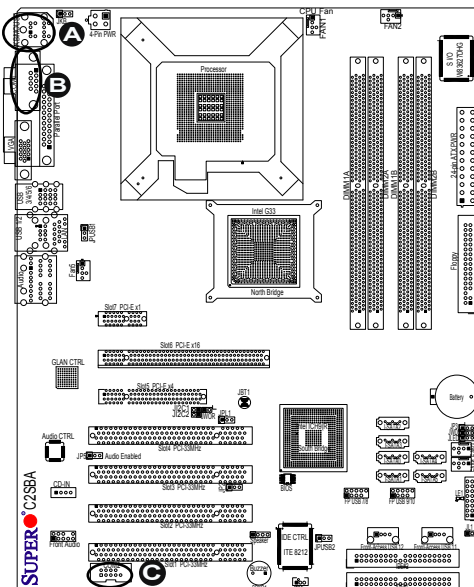

- A. Keyboard/Mouse
- B. COM1
- C. COM2

Wake-On-Ring

The Wake-On-Ring header is designated JWOR. This function allows your computer to receive and be "awakened" by an incoming call when in the suspend state. See the table on the right for pin definitions. You must have a Wake-On-Ring card and cable to use this feature.

Wake-On-Ring Pin Definitions	
Pin#	Definition
1	Ground
2	Wake-up

Wake-On-LAN

The Wake-On-LAN header is located at JWOL on the motherboard. See the table on the right for pin definitions. (You must also have a LAN card with a Wake-On-LAN connector and cable to use this feature.)

Wake-On-LAN Pin Definitions	
Pin#	Definition
1	+5V Standby
2	Ground
3	Wake-up

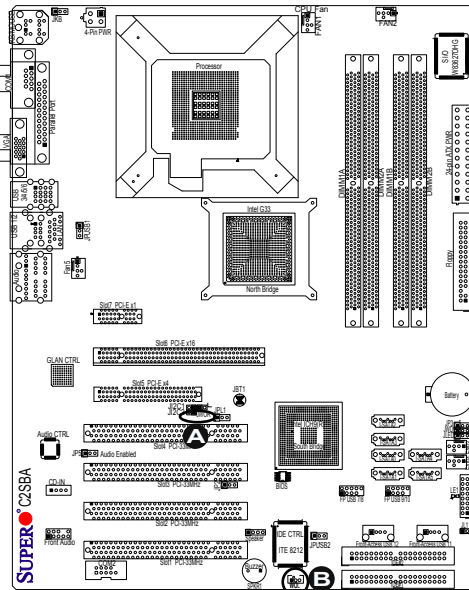

A. WOR

B. WOL

GLAN 1 (Giga-bit Ethernet Port)

A G-bit Ethernet port is located at J11 on the IO backplane. This port accepts RJ45 type cables.



GLAN1

Speaker

A Speaker/Buzzer header (J9) is located on the motherboard. See the table on the right for speaker pin definitions. **Note:** The speaker connector pins are for use with an external speaker. If you wish to use the on-board speaker, you should close pins 3-4 with a jumper.

Speaker Connector Pin Definitions	
Pin Setting	Definition
Pins 3-4	Internal Speaker
Pins 1-4	External Speaker

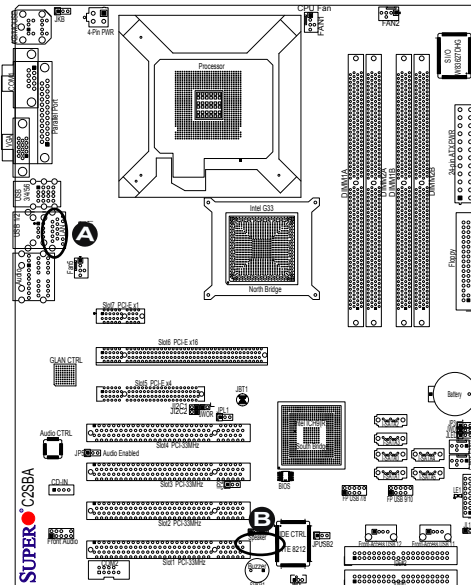

A. GLAN1

B. Speaker/Buzzer

High Definition Audio (HDA)

The C2SBA+II/C2SBA+/C2SBA/C2SBE features a 7.1+2 Channel High Definition Audio (HDA) (J46) codec that provides 10DAC channels, simultaneously supporting 7.1 sound playback and two channels of independent stereo sound output (multiple streaming) through the front panel stereo out for front L&R, rear L&R, center and subwoofer speakers. This feature is activated with the Advanced software in the CD-ROM that came with your motherboard. Sound is then output through the Line In, Line Out and MIC jacks (See at the picture at right).

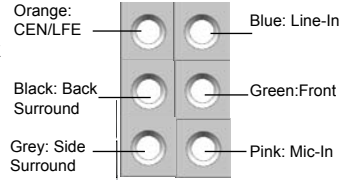

CD Header

A 4-pin CD header is located at CD1, and an Auxiliary header is located at J12 on the motherboard. These headers allow you to use the onboard sound for audio CD playback. Connect an audio cable from your CD drive to the header that fits your cable's connector. Only one CD header can be used at any one time. See the tables at right for pin definitions.

CD1 Pin Definition	
Pin#	Definition
1	Left Stereo Signal
2	Ground
3	Ground
4	Right Stereo Signal

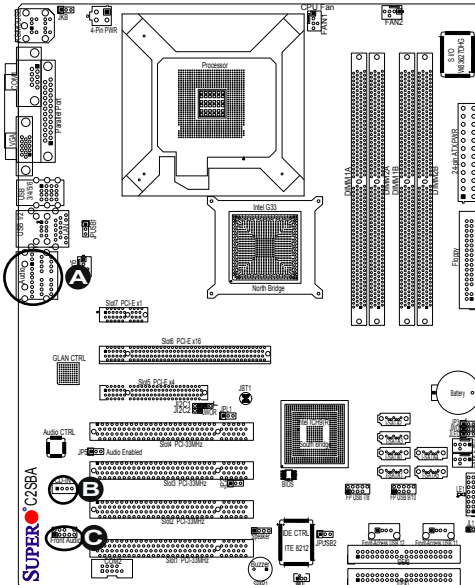

- A. HD Audio
- B. CD-In
- C. Front Panel Audio

Front Panel Audio Control

When front panel headphones are plugged in, the back panel audio output is disabled. This is done through the FP Audio header (J12). If the front panel interface card is not connected to the front panel audio header, jumpers should be installed on the header (J12) pin pairs: 1-2, 5-6, and 9-10. If these jumpers are not installed, the back panel line out connector will be disabled and microphone input Pin 1 will be left floating, which can lead to excessive back panel microphone noise and cross talk. See the table below for pin definitions.

High Definition Front Panel Audio	
Pins#	Signal
1	MIC_L
2	AUD_GND
3	MIC_R
4	FP_Audio-Detect
5	Line_2_R
6	Pull down to Ground
7	FP_Jack-Detect
8	Key
9	Line_2_L
10	Pull down to Ground

Power LED

The Power LED connector is designated JLED. This connection is used to provide LED Indication of power supplied to the system. See the table on the right for pin definitions.

PWR LED Pin Definitions	
Pin#	Definition
1	+5V
2	Key
3	Ground

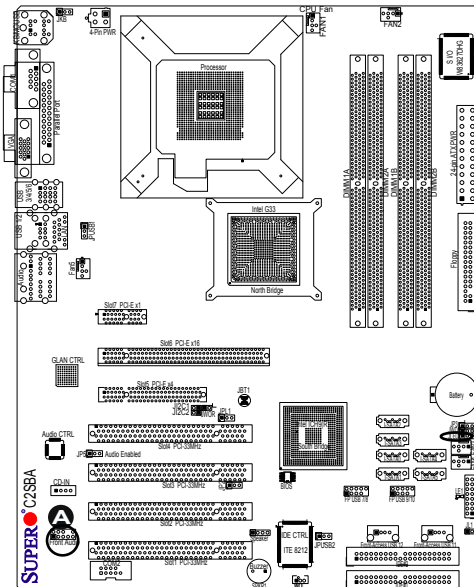

- A. Front Panel Audio
- B. PWR LED

2-7 Jumper Settings

Explanation of Jumpers

To modify the operation of the motherboard, jumpers can be used to choose between optional settings. Jumpers create shorts between two pins to change the function of the connector. Pin 1 is identified with a square solder pad on the printed circuit board. See the motherboard layout pages for jumper locations.

Note: On two pin jumpers, "Closed" means the jumper is on and "Open" means the jumper is off the pins.

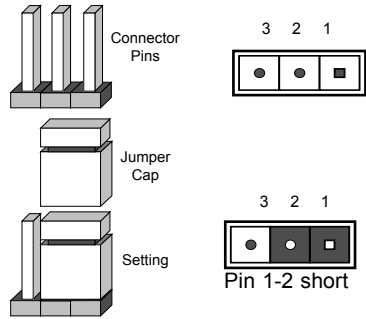

GLAN Enable/Disable

JPL1 enables or disables the GLAN Port on the motherboard. See the table on the right for jumper settings. The default setting is enabled.

GLAN Enable Jumper Settings	
Pin#	Definition
1-2	Enabled (default)
2-3	Disabled

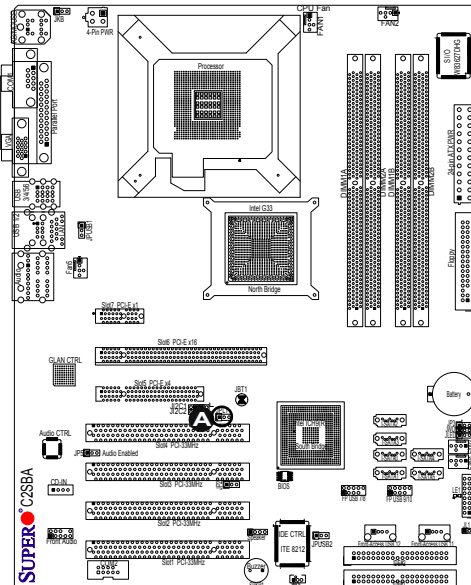

A. GLAN Port1 Enable

CMOS Clear

JBT1 is used to clear CMOS. Instead of pins, this "jumper" consists of contact pads to prevent the accidental clearing of CMOS. To clear CMOS, use a metal object such as a small screwdriver to touch both pads at the same time to short the connection. Always remove the AC power cord from the system before clearing CMOS.

Note: For an ATX power supply, you must completely shut down the system, remove the AC power cord and then short JBT1 to clear CMOS.



Watch Dog Enable/Disable

Watch Dog is a system monitor that can reboot the system when a software application hangs. Close pins 1-2 to reset the system if an application hangs. Close pins 2-3 to generate a non-maskable interrupt signal for the application that hangs. See the table on the right for jumper settings. Watch Dog must also be enabled in the BIOS. (**Note:** When enabled, the user needs to write his/her own application software to disable the Watch Dog Timer.)

Watch Dog Jumper Settings	
Jumper Setting	Definition
Pins 1-2	Reset (default)
Pins 2-3	NMI
Open	Disabled

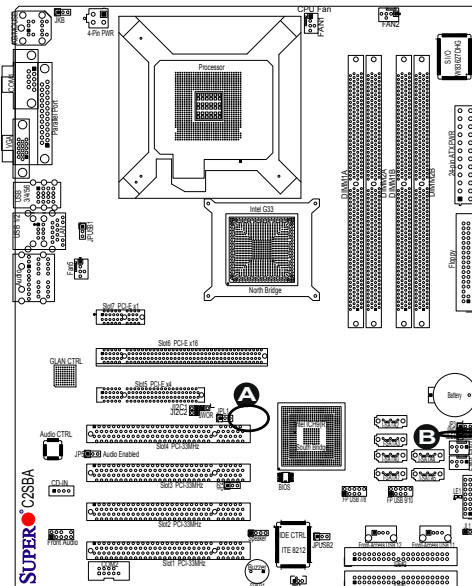

A. Clear CMOS

B. Watch Dog Enable

PCI/PCI-E Slots to SMB Speeds

Jumpers J1²C1/J1²C2 allow you to connect PCI/PCI-Exp. Slots to the System Management Bus. The default setting is open to disable the connection. See the table on the right for jumper settings.

SMBus to PCI-X/PCI-Exp Slots Jumper Settings	
Jumper Setting	Definition
Closed	Enabled
Open	Disabled (Default)

Keyboard Wake-Up

The JKB jumper is used together with the Keyboard Wake-Up function in BIOS. Enable the jumper and the BIOS setting to allow the user to "wake the system up" by hitting a key on the keyboard. See the table on the right for jumper settings. Your power supply must meet ATX specification 2.01 or higher and supply 720 mA of standby power to use this feature.

KB Wake-up Enable Jumper Settings	
Pin#	Definition
1-2	Enabled (default)
2-3	Disabled

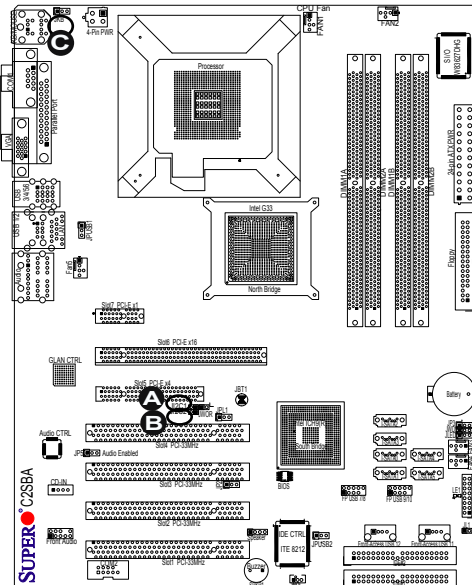

A. J1²C1

B. J1²C2

C. Keyboard Wake-Up

IDE Enable/Disable

JP2 enables or disables IDE#1 and IDE#2 on the C2SBA+II/C2SBA+. See the table on the right for jumper settings. The default setting is enabled.

IDE Enable Jumper Settings	
Pin#	Definition
1-2	Enabled (default)
2-3	Disabled

TPM Enable (For the C2SBA/C2SBA+II/C2SBA+)

Use JP3 to enable or disable Trust Platform Module Management (TPM) on the motherboard. See the table on the right for jumper settings. The default setting is Enabled.

TPM Enable Jumper Settings	
Pin#	Definition
1-2	Enabled (default)
2-3	Disabled

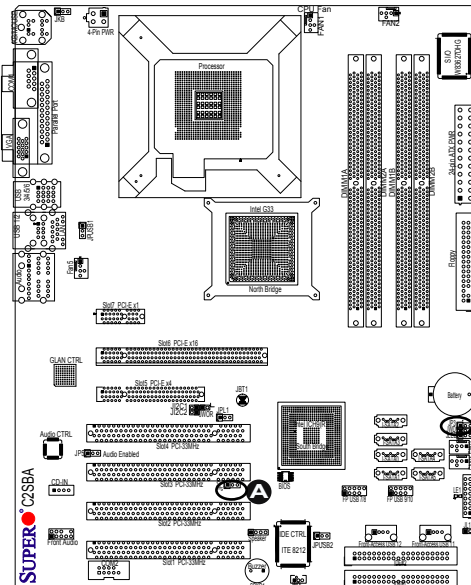

- A. IDE Enable
- B. TPM Enable

Audio Enable

JP5 enables or disables the onboard audio connections. See the table on the right for jumper settings. The default setting is Enabled.

Audio Enable Jumper Settings

Pin#	Definition
1-2	Enabled (default)
2-3	Disabled

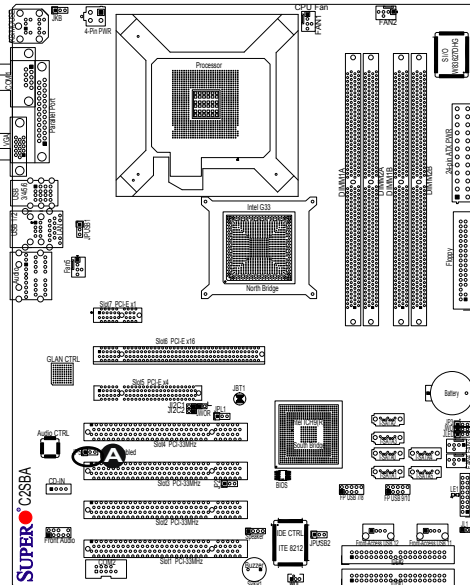

A. Audio Enable

USB Wake-Up

Use JPUSB jumpers (JPUSB1/JPUSB2) to enable the function of "System Wake-Up via USB devices", which allows you to "wake-up" the system by pressing a key on the USB keyboard or by clicking the USB mouse of your system. The JPUSB jumpers are used together with the USB Wake-Up function in the BIOS. Enable both jumpers and the BIOS setting to allow the system to "wake-up via USB Devices". See the table on the right for jumper settings and jumper connections. (Note: JPUSB1 is for Back Panel USB ports:1/2/3/4/5/6, and JPUSB2 is for Front Panel USB ports:7/8/9/10 and Front Accessible USB ports: 11/12.)

USB Wake-up Enable Jumper Settings	
Pin#	Definition
1-2	Enabled
2-3	Disabled

(**Note:** The default jumper setting for the USB ports is "Disabled". However, when the "USB Wake-Up" function is enabled in the BIOS and the desired USB ports are enabled via the JPUSB jumper, please be sure to remove all USB devices from the USB ports whose USB jumpers are set to "Disabled" before the system goes into the standby mode.)

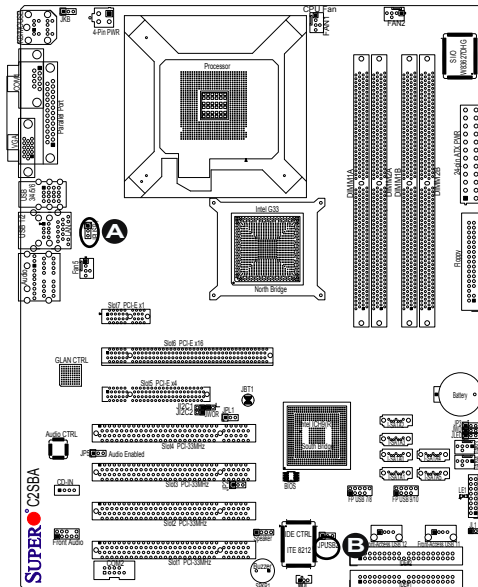

A. JPUSB1

B. JPUSB2

2-8 Onboard Indicators

GLAN LEDs

There is one Gigabit-LAN port (J11). This Gigabit Ethernet LAN port has two LEDs. The yellow GLAN Activity LED (right, see below) indicates activity, while the GLAN Link/Speed LED (left, see below) indicates activity, while the GLAN Link/Speed LED (left) may be green, amber or off to indicate the speed of the connection. See the tables at right for more information.

GLAN Link/Speed LED Indicator	
LED Color	Definition
Off	No Connection or 10 Mbps
Green (On)	100 Mbps
Amber (On)	1 Gbps

GLAN Activity LED Indicator	
Color	Definition
Yellow (Flashing)	ConnectionActive

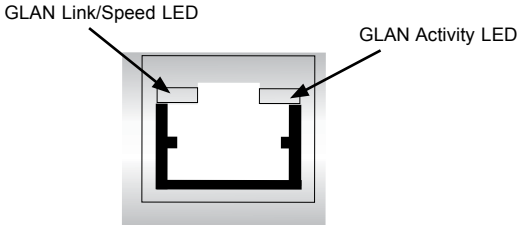

Rear View
(When viewing from the rear side of the chassis.)

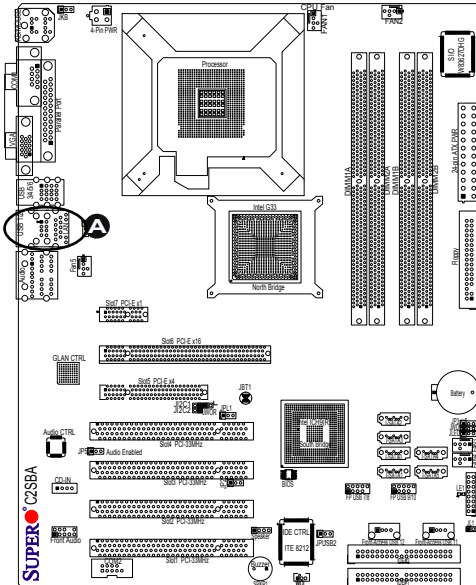

A. GLAN Port1 LEDs

Onboard Power LED (LE1)

The Onboard 3.3V Standby Power LED is located at LE1 on the motherboard. When LE1 is off, the system is off. When the green light is on, the system is on. When the LED is on, the power is on. Unplug the power cable before removing or installing components. See the layout below for the LED location.

Onboard PWR LED Indicator Settings	
LED Color	Definition
Off	System Off
On	Standby Power On
Green	System On

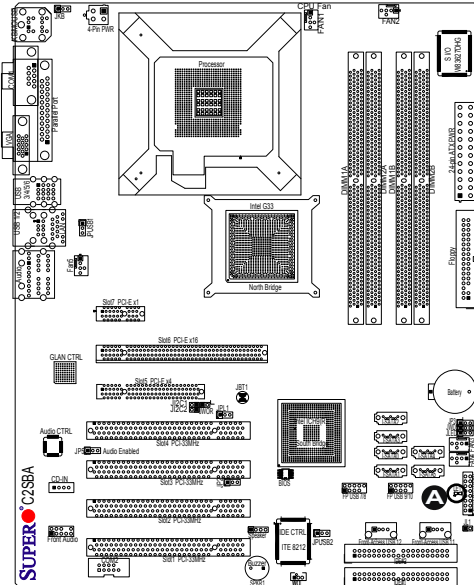

A. Power LED

2-9 Parallel Port, Floppy Drive and IDE Hard Drive Connections

Note the following when connecting the floppy and hard disk drive cables:

- The floppy disk drive cable has seven twisted wires.
- A red mark on a wire typically designates the location of pin 1.
- A single floppy disk drive ribbon cable has two connectors to provide for two floppy disk drives. The connector with twisted wires always connects to drive A, and the connector that does not have twisted wires always connects to drive B.

Parallel (Printer) Port Connector

The parallel (printer) port is located at J30. See the table on the right for pin definitions.

Parallel (Printer) Port Connector Pin Definitions			
Pin#	Definition	Pin #	Definition
1	Strobe-	2	Auto Feed-
3	Data Bit 0	4	Error-
5	Data Bit 1	6	Init-
7	Data Bit 2	8	SLCT IN-
9	Data Bit 3	10	GND
11	Data Bit 4	12	GND
13	Data Bit 5	14	GND
15	Data Bit 6	16	GND
17	Data Bit 7	18	GND
19	ACK	20	GND
21	BUSY	22	Write Data
23	PE	24	Write Gate
25	SLCT	26	NC

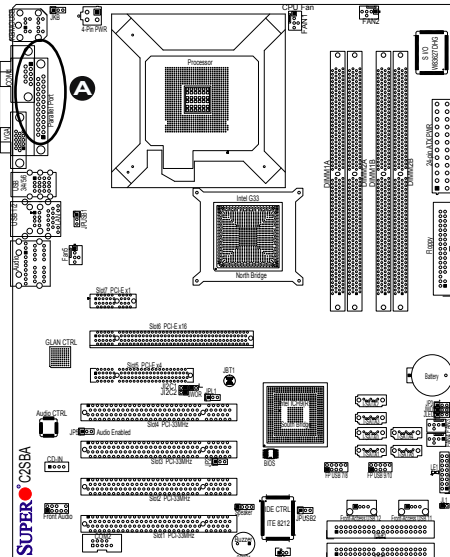

A. Parallel Port

Floppy Connector

The floppy connector is located at J27. See the table on the right for pin definitions.

Floppy Drive Connector Pin Definitions			
Pin#	Definition	Pin #	Definition
1	Ground	2	FDHDIN
3	Ground	4	Reserved
5	Key	6	FDEDIN
7	Ground	8	Index
9	Ground	10	Motor Enable
11	Ground	12	Drive Select B
13	Ground	14	Drive Select B
15	Ground	16	Motor Enable
17	Ground	18	DIR
19	Ground	20	STEP
21	Ground	22	Write Data
23	Ground	24	Write Gate
25	Ground	26	Track 00
27	Ground	28	Write Protect
29	Ground	30	Read Data
31	Ground	32	Side 1 Select
33	Ground	34	Diskette

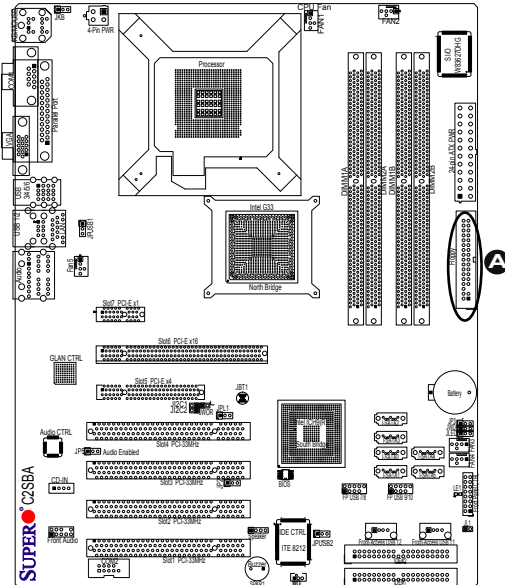

A. Floppy

IDE Connectors (For the C2SBA+II/C2SBA+ only)

There are two IDE connectors on the C2SBA+II/C2SBA+. Be sure to close Pin 1 and Pin 2 of JP2 to enable the IDE connectors before using them. (Please refer to the jumper section for more details.) See the table on the right for pin definitions.

IDE Drive Connectors Pin Definitions			
Pin#	Definition	Pin #	Definition
1	Reset IDE	2	Ground
3	Host Data 7	4	Host Data 8
5	Host Data 6	6	Host Data 9
7	Host Data 5	8	Host Data 10
9	Host Data 4	10	Host Data 11
11	Host Data 3	12	Host Data 12
13	Host Data 2	14	Host Data 13
15	Host Data 1	16	Host Data 14
17	Host Data 0	18	Host Data 15
19	Ground	20	Key
21	DRQ3	22	Ground
23	I/O Write	24	Ground
25	I/O Read	26	Ground
27	IOCHRDY	28	BALE
29	DACK3	30	Ground
31	IRQ14	32	IOCS16
33	Addr1	34	Ground
35	Addr0	36	Addr2
37	Chip Select 0	38	Chip Select 1
39	Activity	40	Ground

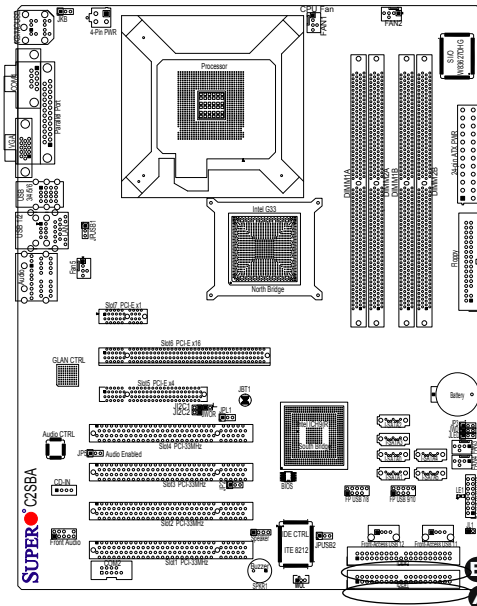

A. IDE#1

B. IDE#2

Notes

Chapter 3

Troubleshooting

3-1 Troubleshooting Procedures

Use the following procedures to troubleshoot your system. If you have followed all of the procedures below and still need assistance, refer to the 'Technical Support Procedures' and/or 'Returning Merchandise for Service' section(s) in this chapter. Always disconnect the AC power cord before adding, changing or installing any hardware components.

Before Power On

1. Make sure that there are no short circuits between the motherboard and chassis.
2. Disconnect all ribbon/wire cables from the motherboard, including those for the keyboard and mouse.
3. Remove all add-on cards.
4. Install a CPU and heatsink (making sure it is fully seated) and connect the chassis speaker and the power LED to the motherboard. Check all jumper settings as well.
5. Use the correct type of onboard CMOS battery as specified by the Manufacturer. Do not install the CMOS battery upside down to avoid possible explosion.
6. Make sure that the 4-pin 12v power connector at J41 is connected to your power supply.

No Power

1. Make sure that there are no short circuits between the motherboard and chassis.
2. Verify that all jumpers are set to their default positions.
3. Check that the 115V/230V switch on the power supply is properly set.
4. Turn the power switch on and off to test the system.
5. The battery on your motherboard may be old. Check to verify that it still supplies ~3VDC. If it does not, replace it with a new one.

No Video

1. If the power is on but you have no video, remove all the add-on cards and cables.
2. Use the speaker to determine if any beep codes exist. Refer to Appendix A for details on beep codes.

NOTE

If you are a system integrator, VAR or OEM, a POST diagnostics card is recommended. For I/O port 80h codes, refer to App. B.

Memory Errors

1. Make sure that the DIMM modules are properly and fully installed.
2. You should be using unbuffered DDR2 memory (see the next page). Also, it is recommended that you use the same memory speed for all DIMMs in the system. See Section 2-4 for memory limitations.
3. Check for bad DIMM modules or slots by swapping modules between slots and noting the results.
4. Check the power supply voltage 115V/230V switch.

Losing the System's Setup Configuration

1. Make sure that you are using a high quality power supply. A poor quality power supply may cause the system to lose the CMOS setup information. Refer to Section 1-6 for details on recommended power supplies.
2. The battery on your motherboard may be old. Check to verify that it still supplies ~3VDC. If it does not, replace it with a new one.
3. If the above steps do not fix the Setup Configuration problem, contact your vendor for repairs.

3-2 Technical Support Procedures

Before contacting Technical Support, please take the following steps. Also, note that as a motherboard manufacturer, Super Micro does not sell directly to end-users, so it is best to first check with your distributor or reseller for troubleshooting services. They should know of any possible problem(s) with the specific system configuration that was sold to you.

1. Please go through the 'Troubleshooting Procedures' and 'Frequently Asked Question' (FAQ) sections in this chapter or see the FAQs on our web site (<http://www.supermicro.com/support/faqs/>) before contacting Technical Support.
2. BIOS upgrades can be downloaded from our web site at (<http://www.supermicro.com/support/bios/>).

Note: Not all BIOS can be flashed; it depends on the modifications to the boot block code.

3. If you still cannot resolve the problem, include the following information when

contacting Super Micro for technical support:

- Motherboard model and PCB revision number
- BIOS release date/version (this can be seen on the initial display when your system first boots up)
- System configuration

An example of a Technical Support form is on our web site at (<http://www.supermicro.com/support/contact.cfm>).

4. Distributors: For immediate assistance, please have your account number ready when placing a call to our technical support department. We can be reached by e-mail at support@supermicro.com, by phone at:(408) 503-8000, option 2, or by fax at (408)503-8019.

3-3 Frequently Asked Questions

Question: What type of memory does my motherboard support?

Answer: The C2SBA+II/C2SBA+/C2SBA/C2SBE supports **unbuffered**, DDR2 667/800 MHz memory modules. See Section 2-4 for details on installing memory.

Question: Why does Microsoft Windows XP (SP2) and Windows Vista show less memory than what is physically installed?

Answer: Microsoft implemented a design change in Windows XP with Service Pack 2 (SP2) and Windows Vista. This change is specific to the Physical Address Extension (PAE) mode behavior which improves driver compatibility. For more information, please read the following article at Microsoft's Knowledge Base website at: <http://support.microsoft.com/kb/888137>.

Question: How do I update my BIOS?

Answer: It is recommended that you **do not** upgrade your BIOS if you are not experiencing any problems with your system. Updated BIOS files are located on our web site at <http://www.supermicro.com/support/bios/>. Please check our BIOS warning message and the information on how to update your BIOS on our web site. Select your motherboard model and download the BIOS (.rom) file to your computer. Also, check the current BIOS revision and make sure that it is newer than your BIOS before downloading. You may choose the zip file or the .exe file. If you choose the zipped BIOS file, please unzip the BIOS file onto a bootable device or a USB pen/thumb drive. To flash the BIOS, run the batch file named "flash.bat" with the new BIOS .rom file from your bootable device or USB pen/thumb drive. Use the following format:

```
F:\> flash xxxxxxxx.rom <Enter>
```

Note: Be sure to insert a space immediately after "flash" and use only the file named "flash.bat" to update the BIOS.

When completed, your system will automatically reboot. If you choose the .exe file, please run the .exe file under Windows to create the BIOS flash floppy disk. Insert the floppy disk into the system you wish to flash the BIOS. Then, boot the system to the floppy disk. The BIOS utility will automatically flash the BIOS without any prompts. Please note that this process may take a few minutes to complete. Do not be concerned if the screen is paused for a few minutes.

Warning: Do not shut down or reset the system while updating the BIOS to prevent possible system boot failure!

When the BIOS flashing screen is completed, the system will reboot and will show "Press F1 or F2". At this point, you will need to load the BIOS defaults. Press <F1> to go to the BIOS setup screen, and press <F9> to load the default settings. Next, press <F10> to save and exit. The system will then reboot.

Note: The SPI BIOS chip installed on this motherboard is not removable. To repair or replace a damaged BIOS chip, please send your motherboard to RMA at Supermicro for service.

Question: What's on the CD that came with my motherboard?

Answer: The supplied compact disc has quite a few drivers and programs that will greatly enhance your system. We recommend that you review the CD and install the applications you need. Applications on the CD include chipset drivers, security and audio drivers.

Question: How do I utilize the onboard HD sound?

Answer: The onboard HD sound available on the C2SBA+II/C2SBA+/C2SBA/C2SBE can be enabled with the audio driver software that was included in your motherboard package. When activated, sound will be routed through the jacks next to the LAN Port according to the audio connection descriptions listed on Page 2-8. You must also set the HD Audio setting to "Auto" in the Advanced Chipset section of the BIOS setup.

Question: I installed my microphone correctly but I can't record any sound. What should I do?

Answer: Go to <Start>, <Programs>, <Accessories>, <Entertainment> and then <Volume Control>. Under the Properties tab, scroll down the list of devices in the menu and check the box beside "Microphone".

Question: After I have installed 4 pieces of 1GB Memory, why does the BIOS only detect about 3.145 GB of memory during POST?

Answer: Because the chipset does not support memory remapping, and PCI-E memory requires a great deal of memory, so there is a memory hole located around the 4GB memory address.

Question: How do I connect the ATA100/66 cable to my IDE device(s)?

Answer: The 80-wire/40-pin high-density ATA100/66 IDE cable that came with your system has two connectors to support two drives. This special cable must be used to take advantage of the speed the ATA100/66 technology offers. **Connect the blue connector to the onboard IDE header and the other connector(s) to your hard drive(s).** Consult the documentation that came with your disk drive for details on actual jumper locations and settings.

Question: Why doesn't my USB devices no longer work correctly after installing the Intel Chipset Software Installation Utility in Windows XP or Windows Server 2003?

Answer: This is a timing conflict between Windows File Protection and the Setup program. This is described in greater detail, and a hotfix is available at Microsoft's website at <http://support.microsoft.com/kb/921411/en-us>

3-4 Returning Merchandise for Service

A receipt or copy of your invoice marked with the date of purchase is required before any warranty service will be rendered. You can obtain service by calling your vendor for a Returned Merchandise Authorization (RMA) number. When returning to the manufacturer, the RMA number should be prominently displayed on the outside of the shipping carton, and mailed prepaid or hand-carried. Shipping and handling charges will be applied for all orders that must be mailed when service is complete.

This warranty only covers normal consumer use and does not cover damages incurred in shipping or from failure due to the alteration, misuse, abuse or improper maintenance of products.

During the warranty period, contact your distributor first for any product problems.

Chapter 4

BIOS

4-1 Introduction

This chapter describes the Phoenix BIOS™ Setup utility for the C2SBA+II/ C2SBA+/C2SBA/C2SBE. The Phoenix ROM BIOS is stored in a flash chip and can be easily upgraded using a floppy disk-based program.

Note: Due to periodic changes to the BIOS, some settings may have been added or deleted and might not yet be recorded in this manual. Please refer to the Manual Download area of the Super Micro web site <<http://www.supermicro.com>> for any changes to the BIOS not reflected in this manual.

System BIOS

The BIOS is the Basic Input Output System used in all IBM® PC, XT™, AT®, and PS/2® compatible computers. The Phoenix BIOS stores the system parameters, types of disk drives, video displays, etc. in the CMOS. The CMOS memory requires very little electrical power. When the computer is turned off, a backup battery provides power to the CMOS logic, enabling it to retain system parameters. Each time the computer is powered on, the computer is configured with the values stored in the CMOS logic by the system BIOS, which gains control at boot-up.

How To Change the Configuration Data

The CMOS information that determines the system parameters may be changed by entering the BIOS Setup utility. This Setup utility can be accessed by pressing the <Delete> key at the appropriate time during system boot. (See below.)

Starting the Setup Utility

Normally, the only visible POST (Power On Self Test) routine is the memory test. As the memory is being tested, press the <Delete> key to enter the main menu of the BIOS Setup utility. From the main menu, you can access the other setup screens, such as the Security and Power menus. Beginning with Section 4-3, detailed descriptions are given for each parameter setting in the Setup utility.



Warning: Do not shut down or reset the system while updating the BIOS to prevent possible boot failure.

4-2 Running Setup

Default settings are in bold text unless otherwise noted.

The BIOS setup options described in this section are selected by choosing the appropriate text from the main BIOS Setup screen. All displayed text is described in this section, although the screen display is often all you need to understand how to set the options (See the next page).

When you first power on the computer, the Phoenix BIOS™ is immediately activated.

While the BIOS is in control, the Setup program can be activated in one of two ways:

1. By pressing <Delete> immediately after turning the system on, or
2. When the message shown below appears briefly at the bottom of the screen during the POST (Power On Self-Test), press the <Delete> key to activate the main Setup menu. **Press the <Delete> key to enter Setup**

4-3 Main BIOS Setup

All main Setup options are described in this section. The main BIOS Setup screen is displayed below.

Use the Up/Down arrow keys to move among the different settings in each menu. Use the Left/Right arrow keys to change the options for each setting.

Press the <Esc> key to exit the CMOS Setup Menu. The next section describes in detail how to navigate through the menus.

Items that use submenus are indicated with the ► icon. With the item highlighted, press the <Enter> key to access the submenu.

Main BIOS Setup Menu



Main Setup Features

System Time

To set the system date and time, key in the correct information in the appropriate fields. Then press the <Enter> key to save the data.

System Date

Using the arrow keys, highlight the month, day and year fields, and enter the correct data. Press the <Enter> key to save the data.

Legacy Diskette A

This setting allows the user to set the type of floppy disk drive installed as diskette A. The options are Disabled, 360Kb 5.25 in, 1.2MB 5.25 in, 720Kb 3.5 in, **1.44/1.25MB**, 3.5 in and 2.88MB 3.5 in.

BIOS Date

The item displays the date that the BIOS was built.

Hard Disk Pre-Delay

Select Enable to allow for the time needed for a hard drive to perform initialization before it is accessed by the BIOS after power-up to prevent possible system boot failure. A boot failure may occur if the BIOS accesses a hard drive that has not been properly initialized. The default setting is **Disabled**.

Serial ATA

This setting allows the user to enable or disable the function of the Serial ATA. The options are Disabled and **Enabled**.

Native Mode Operation

Select Serial ATA for SATA or select Auto (Native Mode) for ATA. The options are: Serial ATA and **Auto**.

Serial ATA (SATA) RAID Enable (C2SBA+II Only)

Select Enable to enable Serial ATA RAID Functions. (For the Windows OS environment, use the RAID driver if this feature is set to Enabled. When this item is set to Enabled, the item: "ICH RAID Code Base" will be available for you to select either Intel or Adaptec Host RAID firmware. If this item is set to **Disabled**, the item-SATA AHCI Enable will be available.) The options are Enabled and **Disabled**.

SATA AHCI Enable

Select Enabled to use the Serial ATA Advanced Host Interfacing. This feature is available when the Windows XP OS, the SPI BIOS Chip, and the IAA Driver are installed in the system. (Take caution when using this function. This feature is for advanced programmers only. The options are Enabled and **Disabled**.)

SATA AHCI Legacy Enable

Select Enabled use the SATA Advanced Host Interface Legacy Mode. When in AHCI Legacy Mode, SATA Port 5 and SATA Port 6 are disabled. (Take caution when using this function. This feature is for advanced programmers only. The options are Enabled and **Disabled**.)

►SATA Port1, SATA Port2, SATA Port3, SATA Port4 and SATA 5

These settings allow the user to set the parameters of slots indicated above. Hit <Enter> to access the following sub-menu screen. Set the correct configurations accordingly.

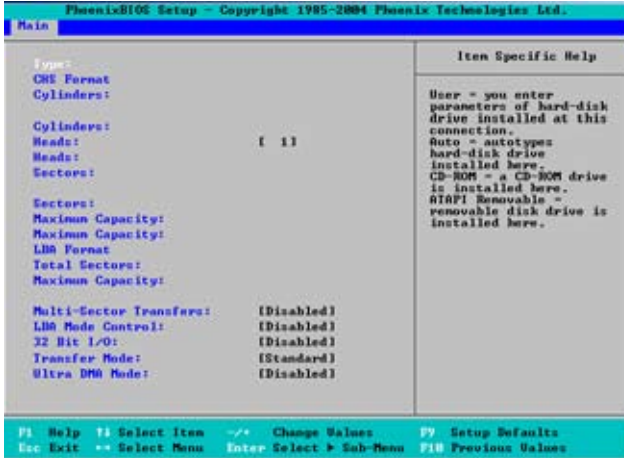

Type

This option allows you to select the type of IDE hard drive. Select **Auto** to allow BIOS to automatically detect the hard drive's capacity, number of heads, etc.). The option **User** allows the user to enter the parameters for the HDD installed at this connection. Enter a number between 1 to 39 to select a predetermined HDD type. Select **CDROM** if a CDROM drive is installed. Select **ATAPI** if a removable disk drive is installed.

CHS Format

The following items will be displayed by the BIOS:

TYPE: This item displays the type of IDE or SATA Device.

Cylinders: This item indicates the status of Cylinders.

Headers: This item indicates the number of headers.

Sectors: This item displays the number of sectors.

Maximum Capacity: This item displays the maximum storage capacity of the system.

LBA Format

The following items will be displayed by the BIOS:

Total Sectors: This item displays the number of total sectors available in the LBA Format.

Maximum Capacity: This item displays the maximum capacity in the LBA Format.

Multi-Sector Transfers

This item allows the user to specify the number of sectors per block to be used in the multi-sector transfer. The options are Disabled, 4 Sectors, 8 Sectors, and **16 Sectors**.

LBA Mode Control

This item determines whether the Phoenix BIOS will access the IDE Channel 0 Master Device via the LBA mode. The options are **Enabled** and Disabled.

32 Bit I/O

This option allows the user to enable or disable the function of a 32-bit data transfer. The options are Enabled and **Disabled**.

Transfer Mode

This option allows the user to set the transfer mode. The options are **Standard**, Fast PIO1, Fast PIO2, Fast PIO3, Fast PIO4, FPIO3/DMA1 and FPIO4/DMA2.

Ultra DMA Mode

This option allows the user to select Ultra DMA Mode. The options are Disabled, Mode 0, Mode 1, Mode 2, Mode 3, Mode 4, and **Mode 5**.

Installed Memory

This display informs you how much system memory is recognized as being present in the system.

System Memory

This display informs you how much memory is available in the system.

4-4 Advanced Setup

Choose Advanced from the Phoenix BIOS Setup Utility main menu with the arrow keys. You should see the following display. The items with a triangle beside them have sub-menus that can be accessed by highlighting the item and pressing <Enter>.



► Boot Features

Floppy Check

Select Enabled to allow the BIOS to verify the type of floppy drive at bootup. Select **Disabled** to speed up the boot process. The settings are Enabled and **Disabled**.

Quiet Boot

This setting allows you to **Enable** or Disable the graphic logo screen display during bootup.

QuickBoot Mode

If enabled, this feature will speed up the POST (Power On Self Test) routine by skipping certain tests after the computer is turned on. The settings are **Enabled** and Disabled. If Disabled, the POST routine will run at normal speed.

POST Errors

Select **Enabled** to stop the POST routine and allow the system to display error messages when an error occurs at bootup. The options are **Enabled** and Disabled.

ACPI Mode

Use this setting to determine whether you want to use the ACPI (Advanced Configuration and Power Interface) power management on your system. The options are **Yes** and No.

ACPI Sleep Mode

This setting allows you to configure the ACPI (Advanced Configuration and Power Interface) Sleep Mode for your system. The options are **S1**, **S3** and **S1S3**.

High Precision Event Time

Select **Yes** to activate the High Precision Event Timer (HPET) that produce periodic interrupts at a much higher frequency than a Real-time Clock (RTC) can in synchronizing multimedia streams, providing smooth playback and reducing the dependency on other timestamp calculation devices, such as an x86 RDTSC Instruction embedded in a CPU. The High Precision Event Timer is used to replace the 8254 Programmable Interval Timer. The default setting is **No**.

Power Button Behavior

If set to **Instant-Off**, the system will power on or power off the system immediately as soon as the user hits the power button. The options are **Instant-Off** and **4-second Override**.

Resume On Modem Ring

Select **On** to “wake your system up” when an incoming call is received by your modem. The options are **On** and **Off**.

Resume On PME#

Select **On** to “wake your system up” from the PME#. The options are **On** and **Off**.

PS2 Keyboard (KB)/Mouse Wake Up

Select **Enable** to “wake your system up” from S3, S4 or S5 state. The options are **Enabled** and **Disabled**. (This feature is available when the jumper-JKB is enabled by closing pin 1 and pin 2. Please refer to Chapter 2.)

USB Wake Up

This feature is used to awaken the system from Standby mode by a Universal Serial Bus (USB) device (such as, a USB mouse or USB keyboard). The options are **Enabled** and **Disabled**.

Power Loss Control

This setting allows you to decide how the system will react when power returns after an unexpected loss of power. The options are **Stay Off**, **Power On**, and **Last State**.

Legacy USB Support

Select **Enabled** to enable Legacy USB Support. The options are **Enabled** and **Disabled**.

Watch Dog

Select Enabled to automatically reset the system if the system is not active for more than 4 minutes. The options are Enabled and **Disabled**.

Summary Screen

This setting allows you to **Enable** or Disable the summary screen which displays the system configuration during bootup.

►Advanced Processor Options

Access the submenu to make changes to the following settings.

CPU Speed

This is a display that indicates the speed of the installed processor.

CPU Overclocking (Available when supported by the CPU)

This feature allows the user to enable and configure Overclocking settings in order to boost system performance. The options are: **Disabled**, +5%, +10%, and +15%. Please note that Supermicro does not recommend CPU Overclocking because it might cause the system to become unstable. The default setting is **Disabled**. If this feature is not set to Disabled, the following two items will display.

CPU OverVoltage (Available when supported by the CPU)

This feature allows the CPU to operate at higher voltage settings than normal settings. The options are: **Disabled**, +5%, +10%, and +15%. Please note that Supermicro does not recommend CPU OverVoltage because it might cause the system to become unstable. The default setting is **Disabled**.

Memory OverVoltage (Available when supported by the CPU)

This feature allows memory modules to operate at higher voltage settings than normal settings. The options are: **Disabled**, +5%, +10%, and +15%. Please note that Supermicro does not recommend Memory OverVoltage because it might cause the system to become unstable. The default setting is **Disabled**.

Core-Multi-Processing (Available when supported by the CPU)

Set to Enabled to use a processor's Second Core and beyond. (Please refer to Intel's web site for more information.) The options are Disabled and **Enabled**.

Machine Checking (Available when supported by the CPU)

Set to Enabled to activate the function of Machine Checking and allow the CPU to detect and report hardware (machine) errors via a set of model-specific registers (MSRs). The options are Disabled and **Enabled**.

Fast String Operations (Available when supported by the CPU)

Set to **Enabled** to enable the fast string operations for special CPU instructions. The options are Disabled and **Enabled**.

Compatible FPU Code (Available when supported by the CPU)

Set to **Enabled** to keep the content of the last instruction Operating Code (OPCode) in the floating point (FP) state. The options are **Disabled** and **Enabled**.

Split Lock Operation

Set to **Enabled** to mask alignment check exceptions for split-lock transactions. The options are Disabled and **Enabled**.

Thermal Management 2 (Available when supported by the CPU)

Set to **Enabled** to use the Thermal Management 2 (TM2) Technology, which will lower the CPU voltage and frequency when the CPU temperature reaches a predefined overheat threshold. Set to Disabled to use Thermal Manager 1 (TM1), and allow CPU clocking to be regulated via the CPU Internal Clock modulation when the CPU temperature reaches the overheat threshold.

Adjacent Cache Line Prefetch (Available when supported by the CPU)

The CPU fetches the cache line for 64 bytes if this option is set to Disabled. The CPU fetches both cache lines for 128 bytes as comprised if Enabled. The options are Disabled and **Enabled**.

Set Maximum Ext. CPUID=3

When set to **Enabled**, the Maximum Extended CPUID will be set to 3. The options are **Disabled** and **Enabled**.

Echo TPR

Set to **Enabled** to prevent xTPR messages from being sent to the system. The options are Disabled and **Enabled**.

C1 Enhanced Mode (Available when supported by the CPU)

Set to **Enabled** to enable the Enhanced Halt State to lower CPU voltage/frequency to prevent overheat. The options are **Enabled** and **Disabled**. (**Note:** Please refer to Intel's web site for detailed information.)

Intel® Virtualization Technology (Available when supported by the CPU)

Select **Enabled** to use the feature of Virtualization Technology to allow one platform to run multiple operating systems and applications in independent partitions,

creating multiple virtual systems in one computer. The options are Enabled and **Disabled**. (**Note:** If there is any change to this setting, you will need to power off and restart the system for the change to take effect.) Please refer to Intel's web site for detailed information.

No Execute Mode Memory Protection (Available when supported by the CPU and the OS)

Set to Enabled to enable Execute Disable Bit and allow the processor to classify areas in memory where an application code can execute and where it cannot, and thus preventing a worm or a virus from inserting and creating a flood of codes to overwhelm the processor or damage the system during an attack. The options are Disabled and **Enabled**. For more information, please visit Intel and Microsoft web sites.

Intel Speed Step Support (Available when supported by the CPU.)

Select Enabled to use the Enhanced Intel SpeedStep Technology and allow the system to automatically adjust the processor voltage and core frequency in an effort to reduce power consumption and heat dissipation. The options are Enabled (-C States, GV1/GV3 are enabled), **GV1/GV3 Only** (C States: Disabled), C-States Only (-G1/G3: Disabled), and Disabled (-C States, GV1/GV3 are disabled). Please refer to Intel's web site for detailed information.

►Advanced Chipset Control

Access the submenu to make changes to the following settings.



Warning: Take caution when changing the Advanced settings. An incorrect setting, a very high DRAM frequency or an incorrect DRAM timing may result in system instability. When this occurs, reset the setting to the default setting.

Clock Spectrum Feature

When set to Enabled, the BIOS will monitor the level of Electromagnetic Interference caused by the components and will attempt to decrease the interference whenever needed. The options are Enabled and **Disabled**.

►Integrated Device Control Sub-menu

USB Host Controller 1

This feature allows the user to configure the control setting for USB Host Controller 1. The default setting is **Enabled**.

USB Host Controller 2

This feature allows the user to configure the control setting for USB Host Controller 2. The default setting is **Enabled**.

Memory Reclaiming

Select Enable to enable the functionality of Memory Remapping above 4GB. The settings are **Enabled** and Disabled.

Enable VT-d

Select Enabled to enable Intel's Virtualization Technology support for Direct I/O VT-d by reporting the I/O device assignments to VMM through the DMAR ACPI Tables. This feature offers fully-protected I/O resource-sharing across the Intel platforms, providing the user with greater reliability, security and availability in networking and data-sharing. The settings are Enabled and **Disabled**.

Default Primary Video Adapter

This feature allows the user to select the video device used by the BIOS during POST. If set to **Auto**, PEG, PCI, IGD (Internal Graphics Device) devices will be selected. If set to IGD (Internal Graphics Device), IGD and PCI devices will be selected. If set to PEG, PEG and PCI devices will be selected. If set to PCI, PCI, PEG and IGD devices will be selected. **IGD-Device 2**

This feature allows the user to enable or disable Internal Graphics Device#2 by entering a specified value.

IGD-Device 2, Function 1

Select Enabled to enable Function#1 of Internal Graphics Device#2, which will allow IGD-Device2 to use a 2nd Adaptor by entering a specified value. The options are **Auto** and Disabled.

DVMT 4.0 Mode

This feature allows the user to configure the DVMT 4.0 Graphics Memory to be used by the Internal Graphics Device. The options are Fixed, **DVMT** and Auto.

Pre-allocated Memory Size

This feature allows the user to set the total amount of Pre-allocated graphics memory to be used by the Internal Graphics Device. The options are **1 MB** and 8 MB.

IGD Memory Size

This feature allows the user to set the total amount of graphics memory to be used by the Internal Graphics Device. The settings are 128 MB, **256 MB** and MAXDVMT.

DVMT Graphics Memory

This feature allows the user to display the DVMT Graphics Memory settings.

Azalia Audio Controller

This option allows the user to enable or disable the onboard Azalia Audio Controller.

Select **Auto** to allow the HD Audio Controller to be automatically enabled when detected by the BIOS. The options are Enable, Disabled and **Auto**.

Route Port 80h Cycles to

This feature allows the user to decide which bus to send debug information to. The options are Disabled, **PCI** and LPC.

►Memory Cache

Cache System BIOS Area

This setting allows you to designate a reserve area in the system memory to be used as a System BIOS buffer and allow BIOS to write (cache) data into this reserved memory area. Select **Write Protect** to enable this function, and this area will be reserved for BIOS ROM access only. Select Uncached to disable this function and make this area available for other devices.

Cache Video BIOS Area

This setting allows you to designate a reserve area in the system memory to be used as a Video BIOS buffer and allow BIOS to write (cache) data into this reserved memory area. Select **Write Protect** to enable the function and this area will be reserved for Video BIOS ROM access only. Select Uncached to disable this function and make this area available for other devices.

Cache Base 0-512K

If enabled, this feature will allow the data stored in the base memory area: block 0-512K to be cached (written) into a buffer, a storage area in the Static DROM (SDROM) or to be written into L1, L2 cache inside the CPU to speed up CPU operations. Select Uncached to disable this function. Select Write Through to allow data to be cached into the buffer and written into the system memory at the same time. Select Write Protect to prevent data from being written into the base memory area of Block 0-512K. Select Write Back to allow the CPU to write data back directly from the buffer without writing data to the System Memory for fast CPU data processing and operation. The options are Uncached, Write Through, Write Protect, and **Write Back**.

Cache Base 512K-640K

If enabled, this feature will allow the data stored in the memory area: 512K-640K to be cached (written) into a buffer, a storage area in the Static DROM (SDROM) or written into L1, L2, L3 cache inside the CPU to speed up CPU operations. Select Uncached to disable this function. Select Write Through to allow data to be cached into the buffer and written into the system memory at the same time. Select Write Protect to prevent data from being written into the base memory area of Block 512K-640K. Select Write Back to allow the CPU to write data back directly from the buffer without writing data to the System Memory for fast CPU

data processing and operation. The options are Uncached, Write Through, Write Protect, and **Write Back**.

Cache Extended Memory Area

If enabled, this feature will allow the data stored in the extended memory area to be cached (written) into a buffer, a storage area in the Static DROM (SDROM) or written into L1, L2, L3 cache inside the CPU to speed up CPU operations. Select Uncached to disable this function. Select Write Through to allow data to be cached into the buffer and written into the system memory at the same time. Select Write Protect to prevent data from being written into the extended memory area above 1 MB. Select Write Back to allow the CPU to write data back directly from the buffer without writing data to the System Memory for fast CPU data processing and operation. The options are Uncached, Write Through, Write Protect, and **Write Back**.

Cache A000-AFFF

Cache B000-BFFF

Cache C800-CBFF

Cache CC00-CFFF

Cache D000-D3FF

Cache D400-D7FF

Cache D800-DBFF

Cache DC00-DFFF

Select Disabled to prevent the data stored in the memory block specified from being cached into a cache area in the CPU or a buffer in the Static DROM. Select USWC Caching to use the Uncached, Speculative and Write Combined Mode for the data in the memory block specified. Select Write Through to allow the data stored in the memory block specified to be cached into a CPU cache area and written into the system memory at the same time. Select Write Protect to prevent data from being written into the memory block specified. Select Write Back to allow the CPU to write data back directly from the buffer to the memory block specified without writing data to the System Memory for fast CPU data processing and operation. The options are **Disabled**, USWC Caching, Write Through, Write Protect, and Write Back.

Cache E000-E3FF

Cache E400-E7FF

Cache E800-EBFF

Cache EC00-EFFF

Select Disabled to prevent the data stored in the memory block specified from being cached into a cache area in the CPU or a buffer in the Static DROM. Select USWC Caching to use the Uncached, Speculative and Write Combined Mode for the data in the memory block specified. Select Write Through to allow the data stored in the

memory block specified to be cached into a CPU cache area and written into the system memory at the same time. Select Write Protect to prevent data from being written into the memory block specified. Select Write Back to allow the CPU to write data back directly from the buffer to the memory block specified without writing data to the System Memory for fast CPU data processing and operation. The options are Disabled, USWC Caching, Write Through, **Write Protect**, and Write Back.

► PNP Configuration

Access the submenu to make changes to the following settings for PNP (Play & Plug) devices.

► PCI Device Slot#1 - PCI Device Slot#4

Access the submenu for each of the settings above to make changes to the following settings:

Option ROM Scan

When enabled, this setting will initialize the device expansion ROM. The options are **Enabled** and Disabled.

Enable Master

This setting allows you to enable the selected device as the PCI bus master. The options are Enabled and **Disabled**.

Latency Timer

This setting allows you to set the clock rate for the bus master. A high-priority, high-throughput device may benefit from a greater clock rate. The options are **Default**, 0020h, 0040h, 0060h, 0080h, 00A0h, 00C0h, and 00E0h. For Unix, Novelle and other Operating Systems, please select the option: other. If a drive fails after the installation of a new software, you might want to change this setting and try again. A different OS requires a different Bus master clock rate.

► Onboard PCI IDE/Onboard LAN (PCI IDE: for C2SBA+II/C2SBA+ only)

Option ROM Scan

When enabled, this setting will initialize the device expansion ROM. The options are **Enabled** and Disabled.

Enable Master

This setting allows you to enable the selected device as the PCI bus master. The options are **Enabled** and Disabled.

Latency Timer

This setting allows you to set the clock rate for the bus master. A high-priority, high-throughput device may benefit from a greater clock rate. The options are **Default**, 0020h, 0040h, 0060h, 0080h, 00A0h, 00C0h, and 00E0h. For Unix, Novelle and other Operating Systems, please select the option: other. If a drive fails after the installation of a new software, you might want to change this setting and try again. A different OS requires a different bus master clock rate.

IDE RAID Mode (Available on the Onboard PCI IDE Submenu.)

This feature allows you to set the IDE RAID Mode. The default setting is **ATA/ATAPI**.

►PCI-E x1 Slot

Access the submenu for each of the settings above to make changes to the following:

PCI Express Port#1

Select Enabled to always enable PCI-Ex1 Port#1. Select Disabled to disable PCI-Ex1 Port#1 and all other PCI-E ports. When set to Auto, PCI-Ex1 Port#1 will be enabled if a PCI add-on card is detected. The options are **Auto**, Enabled and Disabled.

Option ROM Scan

When enabled, this setting will initialize the device expansion ROM. The options are **Enabled** and Disabled.

Enable Master

This setting allows you to enable the selected device as the PCI bus master. The options are Enabled and **Disabled**.

Latency Timer

This setting allows you to set the clock rate for the bus master. A high-priority, high-throughput device may benefit from a greater clock rate. The options are **Default**, 0020h, 0040h, 0060h, 0080h, 00A0h, 00C0h, and 00E0h. For Unix, Novelle and other Operating Systems, please select the option: other. If a drive fails after the installation of a new software, you might want to change this setting and try again. A different OS requires a different bus master clock rate.

►PEG (PCI-Express Graphics) Port Submenu

Access the submenu for each of the settings above to make changes to the following:

PCI-Express Graphics (PEG) Port (This submenu is for debugging only.)

Select **Auto** to automatically enable the PCI-Express Graphics Port if a PCI add-on card is detected. Select Disabled to always disable the PEG Port. Select Enabled to always enable the PEG Port. (Debugging is enabled if a debug card is detected.) The default setting is **Auto**.

When the PCI-Exp. Graphics Port is enabled, the following items will be displayed:

PEG Port Enabled=
PEG Port Number=
PEG Width=
PEG Port Slot Number=
PEG Power Limit=
PEG Slot Card Detect=

► PCI-Express x4 Slot

Access the submenu for each of the settings above to make changes to the following:

PCI Express Port#5

Select Enabled to always enable PCI-Ex4 Port#5. Select Disabled to always disable PCI-Ex4 Port#5. (If PCI-E x1 Port#1 is disabled, PCI-E x4 Port#5 will be disabled as well). When set to **Auto**, PCI-Ex4 Port#5 will be enabled if a PCI add-on card is detected. The options are **Auto**, Enabled and Disabled.

Option ROM Scan

When enabled, this setting will initialize the device expansion ROM. The options are **Enabled** and Disabled.

Enable Master

This setting allows you to enable the selected device as the PCI bus master. The options are Enabled and **Disabled**.

Latency Timer

This setting allows you to set the clock rate for the bus master. A high-priority, high-throughput device may benefit from a greater clock rate. The options are **Default**, 0020h, 0040h, 0060h, 0080h, 00A0h, 00C0h, and 00E0h. For Unix, Novelle and other Operating Systems, please select the option: other. If a drive fails after the installation of a new software, you might want to change this setting and try again. A different OS requires a different bus master clock rate.

► I/O Device Configuration

Access the submenu to make changes to the following settings.

KBC Clock Input

This setting allows you to select the clock frequency for the Keyboard Controller. The options are 6MHz, 8MHz, **12MHz**, and 16MHz.

Serial Port A

This setting allows you to decide how the system controls Serial Port A. The options are **Enabled** (user defined), Disabled, and Auto (BIOS- or OS- controlled).

Base I/O Address

This setting allows you to select the base I/O address for Serial Port A. The options are **3F8**, 2F8, 3E8, and 2E8.

Interrupt

This setting allows you to select the IRQ (interrupt request) for Serial Port A. The options are IRQ3 and **IRQ4**.

Serial Port B

This setting allows you to decide how the system controls Serial Port B. The options are **Enabled** (user defined), Disabled, Auto (BIOS controlled) and OS Controlled.

Mode

This setting allows you to set the type of device that will be connected to Serial Port B. The options are **Normal** and IR (for an infrared device).

Base I/O Address

This setting allows you to select the base I/O address for Serial Port B. The options are 3F8, **2F8**, 3E8 and 2E8.

Interrupt

This setting allows you to select the IRQ (interrupt request) for Serial Port B. The options are **IRQ3** and IRQ4.

Parallel Port

This setting allows you to decide how the system controls the parallel port. The options are **Enabled** (user defined), Disabled and Auto (BIOS-or OS- controlled).

Base I/O Address

Select the base I/O address for the parallel port. The options are **378**, 278 and 3BC.

Interrupt

This setting allows you to select the IRQ (interrupt request) for the parallel port. The options are IRQ5 and **IRQ7**.

Mode

This feature allows you to specify the parallel port mode. The options are Output only, Bi-Directional, EPP and **ECP**.

DMA Channel

This item allows you to specify the DMA channel for the parallel port. The options are DMA1 and **DMA3**.

Floppy Disk Controller

This setting allows you to assign control of the floppy disk controller. The options are **Enabled** (user defined), Disabled, and Auto (BIOS and OS controlled).

► Hardware Monitoring

CPU Overheat Alarm

This option allows the user to select the CPU Overheat Alarm setting which determines when the CPU OH alarm will be activated to provide warning of possible CPU overheat.

Warning: Any temperature that exceeds the CPU threshold temperature predefined by the CPU manufacturer may result in CPU overheat or system instability. When the CPU temperature reaches this predefined threshold, the CPU and system cooling fans will run at full speed.

The options are:

The **Default Alarm Setting:** Select this setting if you want the CPU overheat alarm (including the LED and the buzzer) to be triggered when the CPU temperature reaches about 5°C above the threshold temperature as predefined by the CPU manufacturer to give the CPU and system fans additional time needed for CPU and system cooling.

The **Early Alarm Setting:** Select this setting if you want the CPU overheat alarm (including the LED and the buzzer) to be triggered as soon as the CPU temperature reaches the CPU overheat threshold as predefined by the CPU manufacturer.

CPU1 Temperature

The CPU Temperature feature will display the CPU temperature status as detected by the BIOS:

Low – This level is considered as the 'normal' operating state. The CPU temperature is well below the CPU 'Temperature Tolerance'. The motherboard fans and CPU will run normally as configured in the BIOS (Fan Speed Control).

User intervention: No action required.

Medium – The processor is running warmer. This is a 'precautionary' level and generally means that there may be factors contributing to this condition, but the CPU is still within its normal operating state and below the CPU 'Temperature Tolerance'. The motherboard fans and CPU will run normally as configured in the BIOS. The fans may adjust to a faster speed depending on the Fan Speed Control settings.

User intervention: No action is required. However, consider checking the CPU fans and the chassis ventilation for blockage.

High – The processor is running hot. This is a 'caution' level since the CPU's 'Temperature Tolerance' has been reached (or has been exceeded) and may activate an overheat alarm:

The Default Alarm – the Overheat LED and system buzzer will activate if the High condition continues for some time after it is reached. The CPU fan will run at full speed to bring the CPU temperature down. If the CPU temperature still increases even with the CPU fan running at full speed, the system buzzer will activate and the Overheat LED will turn on.

The Early Alarm – the Overheat LED and system buzzer will be activated exactly when the High level is reached. The CPU fan will run at full speed to bring the CPU temperature down.

Note: In both the alarms above, please take immediate action as shown below. See CPU Overheat Alarm to modify the above alarm settings.

User intervention: If the system buzzer and Overheat LED has activated, take action immediately by checking the system fans, chassis ventilation and room temperature to correct any problems. Note: the system may shut down if it continues for a long period to prevent damage to the CPU.



Notes: The CPU thermal technology that reports absolute temperatures (Celsius/Fahrenheit) has been upgraded to a more advanced feature by Intel in its newer processors. The basic concept is each CPU is embedded by unique temperature information that the motherboard can read. This 'Temperature Threshold' or 'Temperature Tolerance' has been assigned at the factory and is the baseline on which the motherboard takes action during different CPU temperature conditions (i.e., by increasing CPU Fan speed, triggering the Overheat Alarm, etc). Since CPUs can have different 'Temperature Tolerances', the installed CPU can now send information to the motherboard what its 'Temperature Tolerance' is, and not the other way around. This results in better CPU thermal management.

Supermicro has leveraged this feature by assigning a temperature status to certain thermal conditions in the processor (Low, Medium and High). This makes it easier for the user to understand the CPU's temperature status, rather than by just simply seeing a temperature reading (i.e., 25°C).

The information provided above is for your reference only. For more information on thermal management, please refer to Intel's Web site at www.Intel.com.

System Temperature

This displays the system's absolute temperature reading (i.e., 27°C)

Fan1 - Fan 5

If the feature of Auto Fan Control is enabled, the BIOS will automatically display the status of the fan as specified.

Fan Speed Control Modes

This feature allows the user to decide how the system controls the speeds of the onboard fans. The CPU temperature and the fan speed are correlative. When the CPU on-die temperature increases, the fan speed will also increase, and vice versa. If the option is set to "4-pin", the fan speed will be controlled by Pulse Width Modulation (PWM). Select "Workstation" if your system is used as a Workstation. Select "Disable" to disable the fan speed control function to allow the onboard fans to constantly run at full speed (12V). The Options are: **1. Disable** and **2. Optimized for Workstations with 4-pin**.

Note: *In the Windows OS environment, the Supero Doctor III settings take precedence over the BIOS settings. When first installed, Supero Doctor III adopts the temperature threshold settings previously set in the BIOS. Any subsequent changes to these thresholds must be made within Supero Doctor, since the SD III settings override the BIOS settings. For the Windows OS to adopt the BIOS temperature threshold settings, please change the SDIII settings to be the same as those set in the BIOS.*

Voltage Monitoring

The following items will be monitored and displayed:

Vcore A
12V
VDIMM
5V
+3.3V
-12V
3.3Vsb
Vbat

4-5 Security Settings

Choose Security from the Phoenix BIOS Setup Utility main menu with the arrow keys. You should see the following display. Security setting options are displayed by highlighting the setting using the arrow keys and pressing <Enter>. All Security BIOS settings are described in this section.

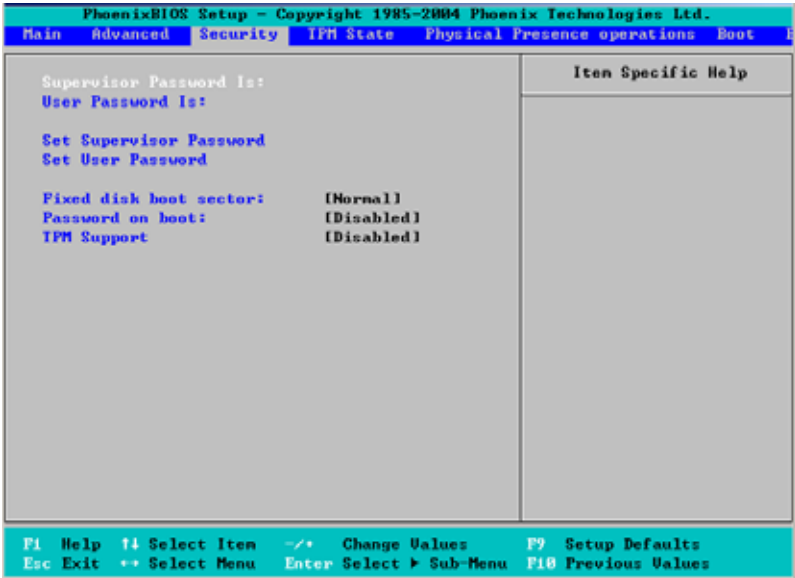

Supervisor Password Is:

This item indicates if a supervisor password has been entered for the system. Clear means such a password has not been used and Set means a supervisor password has been entered for the system.

User Password Is:

This item indicates if a user password has been entered for the system. Clear means such a password has not been used and Set means a user password has been entered for the system.

Set Supervisor Password

When the item Set Supervisor Password is highlighted, hit the <Enter> key. When prompted, type the Supervisor's password in the dialogue box to set or to change supervisor's password, which allows access to the BIOS.

Set User Password

When the item Set User Password is highlighted, hit the <Enter> key. When prompted, type the user's password in the dialogue box to set or to change the user's password, which allows access to the system at boot-up.

Fixed Disk Boot Sector

Select **Normal** to enable the function of Write-Protect to protect the boot sector on the hard drives against viruses.

Password on Boot

When this feature is set to Enabled, a password is required for a user to enter the system at bootup. The options are Enabled (password required) and Disabled (password not required).

TPM (Trusted Platform Modules) Support

Select Enabled to enable support for trusted platforms and allow the BIOS to automatically download the drivers needed to provide support for the platforms specified. The options are Enabled and **Disabled**.

If set to Enabled, the TPM State screen displays. (See the next section.)

4-6 TPM (Trusted Platform Modules) State

Choose the TPM State menu from the Phoenix BIOS Setup Utility with the arrow keys. You should see the following display.



Current TPM State

This item shows the current TPM State only.

Change TPM State

Select "Enabled & Activate" to enable TPM support for the system. Select De-activate & Disabled to disable the function of TPM support. If "No Change" is selected, no changes will be done to the current TPM State. Select Clear to clear or erase all information related to TPM support.

If set to "Clear", the sub-menu: Physical Presence Operations will appear. Select Reject to cancel the selection. Select Execute to proceed with selection. All information related to TPM Support will be erased.

4-7 Boot Settings

Choose Boot from the Phoenix BIOS Setup Utility main menu with the arrow keys. You should see the following display. See details on how to change the order and specs of boot devices in the Item Specific Help window. All Boot BIOS settings are described in this section.

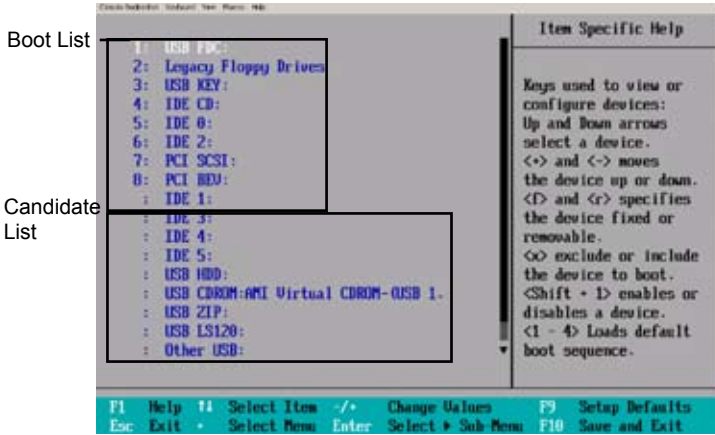

Boot Priority Order/Excluded from Boot Orders

The devices included in the boot list section (above) are bootable devices listed in the sequence of boot order as specified. The boot functions for the devices included in the candidate list (above) are currently disabled. Use a <+> key or a <-> key to move the device up or down. Use the <f> key or the <r> key to specify the type of an USB device, either fixed or removable. You can select one item from the boot list and hit the <x> key to remove it from the list of bootable devices (to make its resource available for other bootable devices). Subsequently, you can select an item from the candidate list and hit the <x> key to remove it from the candidate list and put it in the boot list. This item will then become a bootable device. See details on how to change the priority of boot order of devices in the Item Specific Help window.

4-8 Exit

Choose Exit from the Phoenix BIOS Setup Utility main menu with the arrow keys. You should see the following display. All Exit BIOS settings are described in this section.



Exit Saving Changes

Highlight this item and hit <Enter> to save any changes you made and to exit the BIOS Setup utility.

Exit Discarding Changes

Highlight this item and hit <Enter> to exit the BIOS Setup utility without saving any changes you may have made.

Load Setup Defaults

Highlight this item and hit <Enter> to load the default settings for all items in the BIOS Setup. These are the safest settings to use.

Discard Changes

Highlight this item and hit <Enter> to discard (cancel) any changes you made. You will remain in the Setup utility.

Save Changes

Highlight this item and hit <Enter> to save any changes you made. You will remain in the Setup utility.

Appendix A

BIOS POST Messages

During the Power-On Self-Test (POST), the BIOS will check for problems. If a problem is found, the BIOS will activate an alarm or display a message. The following is a list of such BIOS messages.

Failure Fixed Disk

Fixed disk is not working or not configured properly. Check to see if fixed disk is attached properly. Run Setup. Find out if the fixed-disk type is correctly identified.

Stuck key

Stuck key on keyboard.

Keyboard error

Keyboard not working.

Keyboard Controller Failed

Keyboard controller failed test. May require replacing keyboard controller.

Keyboard locked - Unlock key switch

Unlock the system to proceed.

Monitor type does not match CMOS - Run SETUP

Monitor type not correctly identified in Setup

Shadow Ram Failed at offset: nnnn

Shadow RAM failed at offset **nnnn** of the 64k block at which the error was detected.

System RAM Failed at offset: nnnn

System RAM failed at offset **nnnn** of in the 64k block at which the error was detected.

Extended RAM Failed at offset: nnnn Extended memory not working or not configured properly at offset **nnnn**.

System battery is dead - Replace and run SETUP

The CMOS clock battery indicator shows the battery is dead. Replace the battery and run Setup to reconfigure the system.

System CMOS checksum bad - Default configuration used

System CMOS has been corrupted or modified incorrectly, perhaps by an application program that changes data stored in CMOS. The BIOS installed Default Setup Values. If you do not want these values, enter Setup and enter your own values. If the error persists, check the system battery or contact your dealer.

System timer error

The timer test failed. Requires repair of system board.

Real time clock error

Real-Time Clock fails BIOS hardware test. May require board repair.

Check date and time settings

BIOS found date or time out of range and reset the Real-Time Clock. May require setting legal date (1991-2099).

Previous boot incomplete - Default configuration used

Previous POST did not complete successfully. POST loads default values and offers to run Setup. If the failure was caused by incorrect values and they are not corrected, the next boot will likely fail. On systems with control of **wait states**, improper Setup settings can also terminate POST and cause this error on the next boot. Run Setup and verify that the waitstate configuration is correct. This error is cleared the next time the system is booted.

Memory Size found by POST differed from CMOS

Memory size found by POST differed from CMOS.

Diskette drive A error

Diskette drive B error

Drive A: or B: is present but fails the BIOS POST diskette tests. Check to see that the drive is defined with the proper diskette type in Setup and that the diskette drive is attached correctly.

Incorrect Drive A type - run SETUP

Type of floppy drive A: not correctly identified in Setup.

Incorrect Drive B type - run SETUP

Type of floppy drive B: not correctly identified in Setup.

System cache error - Cache disabled

RAM cache failed and BIOS disabled the cache. On older boards, check the cache jumpers. You may have to replace the cache. See your dealer. A disabled cache slows system performance considerably.

CPU ID:

CPU socket number for Multi-Processor error.

EISA CMOS not writeable

ServerBIOS2 test error: Cannot write to EISA CMOS.

DMA Test Failed

ServerBIOS2 test error: Cannot write to extended **DMA** (Direct Memory Access) registers.

Software NMI Failed

ServerBIOS2 test error: Cannot generate software NMI (Non-Maskable Interrupt).

Fail-Safe Timer NMI Failed

ServerBIOS2 test error: Fail-Safe Timer takes too long.

Device Address Conflict

Address conflict for specified **device**.

Allocation Error for: device

Run ISA or EISA Configuration Utility to resolve resource conflict for the specified **device**.

CD ROM Drive

CD ROM Drive identified.

Entering SETUP ...

Starting Setup program

Failing Bits: nnnn

The hex number **nnnn** is a map of the bits at the RAM address which failed the memory test. Each 1 (one) in the map indicates a failed bit. See errors 230, 231, or 232 above for offset address of the failure in System, Extended, or Shadow memory.

Fixed Disk n

Fixed disk **n** (0-3) identified.

Invalid System Configuration Data

Problem with NVRAM (CMOS) data.

I/O device IRQ conflict

I/O device IRQ conflict error.

PS/2 Mouse Boot Summary Screen:

PS/2 Mouse installed.

nnnn kB Extended RAM Passed

Where **nnnn** is the amount of RAM in kilobytes successfully tested.

nnnn Cache SRAM Passed

Where **nnnn** is the amount of system cache in kilobytes successfully tested.

nnnn kB Shadow RAM Passed

Where **nnnn** is the amount of shadow RAM in kilobytes successfully tested.

nnnn kB System RAM Passed

Where **nnnn** is the amount of system RAM in kilobytes successfully tested.

One or more I2O Block Storage Devices were excluded from the Setup Boot Menu

There was not enough room in the IPL table to display all installed I2O block-storage devices.

Operating system not found

Operating system cannot be located on either drive A: or drive C:. Enter Setup and see if fixed disk and drive A: are properly identified.

Parity Check 1 nnnn

Parity error found in the system bus. BIOS attempts to locate the address and display it on the screen. If it cannot locate the address, it displays ??????. Parity is a method for checking errors in binary data. A parity error indicates that some data has been corrupted.

Parity Check 2 nnnn

Parity error found in the I/O bus. BIOS attempts to locate the address and display it on the screen. If it cannot locate the address, it displays ?????.

Press <F1> to resume, <F2> to Setup, <F3> for previous

Displayed after any recoverable error message. Press <F1> to start the boot process or <F2> to enter Setup and change the settings. Press <F3> to display the previous screen (usually an initialization error of an **Option ROM**, i.e., an add-on card). Write down and follow the information shown on the screen.

Press <F2> to enter Setup

Optional message displayed during POST. Can be turned off in Setup.

PS/2 Mouse:

PS/2 mouse identified.

Run the I2O Configuration Utility

One or more unclaimed block storage devices have the Configuration Request bit set in the LCT. Run an I2O Configuration Utility (e.g. the SAC utility).

System BIOS shadowed

System BIOS copied to shadow RAM.

UMB upper limit segment address: *nnnn*

Displays the address *nnnn* of the upper limit of **Upper Memory Blocks**, indicating released segments of the BIOS which can be reclaimed by a virtual memory manager.

Video BIOS shadowed

Video BIOS successfully copied to shadow RAM.

Notes

Appendix B

BIOS POST Codes

This section lists the POST (Power On Self Test) codes for the Phoenix BIOS. POST codes are divided into two categories: recoverable and terminal.

Recoverable POST Errors

When a recoverable type of error occurs during POST, the BIOS will display an POST code that describes the problem. BIOS may also issue one of the following beep codes:

- 1 long and two short beeps - video configuration error
- 1 repetitive long beep - no memory detected
- 1 continuous beep w/ Front Panel Overheat LED on - system overheat

Terminal POST Errors

If a terminal type of error occurs, BIOS will shut down the system. Before doing so, BIOS will write the error to port 80h, attempt to initialize video and write the error in the top left corner of the screen. The following is a list of codes that may be written to port 80h.

POST Code	Description
02h	Verify Real Mode
03h	Disable Non-Maskable Interrupt (NMI)
04h	Get CPU type
06h	Initialize system hardware
07h	Disable shadow and execute code from the ROM.
08h	Initialize chipset with initial POST values
09h	Set IN POST flag
0Ah	Initialize CPU registers
0Bh	Enable CPU cache
0Ch	Initialize caches to initial POST values
0Eh	Initialize I/O component
0Fh	Initialize the local bus IDE
10h	Initialize Power Management
11h	Load alternate registers with initial POST values
12h	Restore CPU control word during warm boot
13h	Reset PCI Bus Mastering devices
14h	Initialize keyboard controller
16h	1-2-2-3 BIOS ROM checksum
17h	Initialize cache before memory Auto size

POST Code	Description
18h	8254 timer initialization
1Ah	8237 DMA controller initialization
1Ch	Reset Programmable Interrupt Controller
20h	1-3-1-1 Test DRAM refresh
22h	1-3-1-3 Test 8742 Keyboard Controller
24h	Set ES segment register to 4 GB
28h	Auto size DRAM
29h	Initialize POST Memory Manager
2Ah	Clear 512 kB base RAM
2Ch	1-3-4-1 RAM failure on address line xxxx
2Eh	1-3-4-3 RAM failure on data bits xxxx of low byte of memory bus
2Fh	Enable cache before system BIOS shadow
32h	Test CPU bus-clock frequency
33h	Initialize Phoenix Dispatch Manager
36h	Warm start shut down
38h	Shadow system BIOS ROM
3Ah	Auto size cache
3Ch	Advanced configuration of chipset registers
3Dh	Load alternate registers with CMOS values
41h	Initialize extended memory for RomPilot (optional)
42h	Initialize interrupt vectors
45h	POST device initialization
46h	2-1-2-3 Check ROM copyright notice
48h	Check video configuration against CMOS
49h	Initialize PCI bus and devices
4Ah	Initialize all video adapters in system
4Bh	QuietBoot start (optional)
4Ch	Shadow video BIOS ROM
4Eh	Display BIOS copyright notice
4Fh	Initialize MultiBoot
50h	Display CPU type and speed
51h	Initialize EISA board (optional)
52h	Test keyboard
54h	Set key click if enabled
55h	Enable USB devices
58h	2-2-3-1 Test for unexpected interrupts
59h	Initialize POST display service
5Ah	Display prompt "Press <ESC> to enter SETUP"
5Bh	Disable CPU cache

POST Code	Description
5Ch	Test RAM between 512 and 640 kB
60h	Test extended memory
62h	Test extended memory address lines
64h	Jump to UserPatch1
66h	Configure advanced cache registers
67h	Initialize Multi Processor APIC
68h	Enable external and CPU caches
69h	Setup System Management Mode (SMM) area
6Ah	Display external L2 cache size
6Bh	Load custom defaults (optional)
6Ch	Display shadow-area message
70h	Display error messages
72h	Check for configuration errors
76h	Check for keyboard errors
7Ch	Set up hardware interrupt vectors
7Dh	Initialize Intelligent System Monitoring (optional)
7Eh	Initialize coprocessor if present
80h	Disable onboard Super I/O ports and IRQs (optional)
81h	Late POST device initialization
82h	Detect and install external RS232 ports
83h	Configure non-MCD IDE controllers
84h	Detect and install external parallel ports
85h	Initialize PC-compatible PnP ISA devices
86h	Re-initialize onboard I/O ports.
87h	Configure Motherboard Configurable Devices (optional)
88h	Initialize BIOS Data Area
89h	Enable Non-Maskable Interrupts (NMIs)
8Ah	Initialize Extended BIOS Data Area
8Bh	Test and initialize PS/2 mouse
8Ch	Initialize floppy controller
8Fh	Determine number of ATA drives (optional)
90h	Initialize hard-disk controllers
91h	Initialize local-bus hard-disk controllers
92h	Jump to UserPatch2
93h	Build MPTABLE for multi-processor boards
95h	Install CD ROM for boot
96h	Clear huge ES segment register
97h	Fix up Multi Processor table
98h	1-2 Search for option ROMs and shadow if successful. One long, two short beeps on checksum failure

POST Code	Description
99h	Check for SMART Drive (optional)
9Ch	Set up Power Management
9Dh	Initialize security engine (optional)
9Eh	Enable hardware interrupts
9Fh	Determine number of ATA and SCSI drives
A0h	Set time of day
A2h	Check key lock
A4h	Initialize typematic rate
A8h	Erase <ESC> prompt
AAh	Scan for <ESC> key stroke
ACh	Enter SETUP
AEh	Clear Boot flag
B0h	Check for errors
B1h	Inform RomPilot about the end of POST (optional)
B2h	POST done - prepare to boot operating system
B4h	1 One short beep before boot
B5h	Terminate QuietBoot (optional)
B6h	Check password (optional)
B7h	Initialize ACPI BIOS and PPM Structures
B9h	Prepare Boot
BAh	Initialize SMBIOS
BCh	Clear parity checkers
BDh	Display MultiBoot menu
BEh	Clear screen (optional)
BFh	Check virus and backup reminders
C0h	Try to boot with INT 19
C1h	Initialize POST Error Manager (PEM)
C2h	Initialize error logging
C3h	Initialize error display function
C4h	Initialize system error flags
C6h	Console redirection init.
C7h	Unhook INT 10h if console redirection enabled
C8h	Force check (optional)
C9h	Extended ROM checksum (optional)
CDh	Reclaim console redirection vector

POST Code Description

D2h	Unknown interrupt
D4h	Check Intel Branding string
D8h	Alert Standard Format initialization
DEh	Log error if micro-code not updated properly

The following are for boot block in Flash ROM**POST Code Description**

E0h	Initialize the chipset
E1h	Initialize the bridge
E2h	Initialize the CPU
E3h	Initialize system timer
E4h	Initialize system I/O
E5h	Check force recovery boot
E6h	Checksum BIOS ROM
E7h	Go to BIOS
E8h	Set Huge Segment
E9h	Initialize Multi Processor
EAh	Initialize OEM special code
EBh	Initialize PIC and DMA
ECh	Initialize Memory type
EDh	Initialize Memory size
EEh	Shadow Boot Block
EFh	System memory test
F0h	Initialize interrupt vectors
F1h	Initialize Run Time Clock
F2h	Initialize video
F3h	Initialize System Management Manager
F4h	Output one beep
F5h	Clear Huge Segment
F6h	Boot to Mini DOS
F7h	Boot to Full DOS

If the BIOS detects errors on 2C, 2E, or 30 (base 512K RAM error), it displays an additional word-bitmap (**xxxx**) indicating the address line or bits that have failed. For example, "2C 0002" means address line 1 (bit one set) has failed. "2E 1020" means data bits 12 and 5 (bits 12 and 5 set) have failed in the lower 16 bits. The BIOS also sends the bitmap to the port-80 LED display. It first displays the checkpoint code, followed by a delay, the high-order byte, another delay, and then the low-order byte of the error. It repeats this sequence continuously.

Notes

Appendix C

Intel HostRAID Setup Guidelines

(For the C2SBA+II Only)

After all the hardware has been installed, you must first configure SATA HostRAID or SAS HostRAID before you install the Windows Operating System and other software drivers.

Important Notes to the User:

Note 1: This chapter describes RAID Configuration Instructions for the Intel ICH9R Host RAID Controller designed for the Windows OS.

Note 2: If you do not wish to configure onboard SATA or SAS RAID functions, please go directly to Section C-2 and Appendix D for the operating system & other software installation instructions.

C-1 Introduction to Serial ATA and Parallel ATA

To configure the SATA RAID functions, you must first use the Intel ICH9R SATA RAID Utility program to configure the RAID Level that you desire before installing the Windows XP/2003 operating system and other software drivers. (The necessary drivers are all included on the Super Micro CD that came packaged with your motherboard.) **Note:** the current version of the ICH9R SATA RAID Utility can only support Windows XP/2003 Operating Systems.

Serial ATA (SATA)

Serial ATA (SATA) is a physical storage interface that uses a single cable with a minimum of four wires to create a point-to-point connection between devices. It is a serial link, which supports transfer rates up to 3.0 Gbps. Because the serial cables used in SATA are thinner than the traditional cables used in Parallel ATA (PATA), SATA systems have better airflow and can be installed in smaller chassis. In addition, the cables used in PATA are limited to a length of 40cm, while Serial ATA cables can be up to one meter in length. Overall, SATA provides better functionality than PATA.

Introduction to the Intel ICH9R Serial RAID

Located in the South Bridge of the G33 chipset, the I/O Controller Hub (ICH9R) provides the I/O subsystem with access to the rest of the system. It supports 1-channel UltraATA/100 Bus Master IDE controller (PATA) and six Serial ATA (SATA) ports. The ICH9R supports the following PATA and SATA device configurations: Legacy mode and Native mode.

Intel HostRAID Configurations

The following types of Intel's HostRAID configurations are supported:

RAID 0 (Data Striping): this writes data in parallel, interleaved ("striped") sections of two hard drives. Data transfer rate is doubled over using a single disk.

RAID1 (Data Mirroring): an identical data image from one drive is copied to another drive. The second drive must be the same size or larger than the first drive.

RAID 10 (Striping & Mirroring): RAID 0 and 1 schemes are combined (without parity information) to get the benefits of both.

RAID 5: both data and parity information are striped and mirrored across three or more hard drives.

Intel Matrix Storage

The Intel Matrix Storage, supported by the ICH9R, allows the user to create RAID 0, RAID 1, RAID 10 and RAID 5 sets by using only six identical hard disk drives. The Intel Matrix Storage Technology creates two partitions on each hard disk drive and generate a virtual RAID 0, RAID 1, RAID 10 and RAID 5 sets. It also allows you the change the HDD partition size without any data.

Configuring BIOS settings for SATA RAID Functions (in the Native Mode)

1. Press the key during system bootup to enter the BIOS Setup Utility.

Note: If it is the first time powering on the system, we recommend you load the Optimized Default Settings. If you have already done so, please skip to Step 3.

2. Use the arrow keys to select the "Exit" Settings. Once in the "Exit" settings, Scroll down to select "Load Optimized Default Settings" and press the <Enter> key. Select "OK" to confirm the selection. Press the <Enter> key to load the default settings for the BIOS.

3. Use the arrow keys to select the "Main" section in BIOS.

4. Scroll down to "SATA RAID Enabled" and press <Enter>. Then, select "Enabled."

5. Scroll down to "Exit". Select "Save and Exit" from the "Exit" menu. Press the <Enter> key to save the changes and exit the BIOS.

6. Once you've exited the BIOS Utility, the system will re-boot.

7. During the system boot-up, press the <Ctrl> and <I> keys simultaneously to run the Intel RAID Configuration Utility when prompted by the following message: *Press <Ctrl> <I> for the Intel RAID Configuration Utility.*

(Note: The Intel RAID Configuration Utility is only available for systems with two or more drives installed. The Intel RAID Utility screen will not display in systems with one drive installed.)

Using the Intel ICH9R SATA RAID Utility Program

1. Creating, Deleting and Resetting RAID Volumes:

a. After the system exits from the BIOS Setup Utility, the system will automatically reboot. The following screen appears after Power-On Self Test.

```

RAID Volumes:
None defined.

Physical Disks:
Port Drive Model Serial # Size Type/Status(Vol ID)
0 HDC WD2580SD-81K WD-WMA9L728349771 232.9GB Non-RAID Disk
1 HDC WD2580SD-81K WD-WMA9L72834599 232.9GB Non-RAID Disk
2 HDC WD2580JD-80F WD-WMA9H1376109 232.9GB Non-RAID Disk
3 HDC WD2580JD-80F WD-WMA9H1449527 232.9GB Non-RAID Disk

Press <Ctrl><I> to enter Configuration Utility...

Adaptec SCSI BIOS v4.30.8
Copyright 2003 Adaptec, Inc. All Rights Reserved.

*** Press <Ctrl><R> for SCSISelect(TM) Utility! ***

Slot Ch ID LUN Vendor Product Size Bus Status
-----
04 0 1B 0

```

b. When you see the above screen, press the <Ctrl> and the <I> keys simultaneously to access the main menu of the SATA RAID Utility.

c. Use the Up and Down arrow keys to select Create RAID Volume, Delete RAID Volume, Reset Disks to Non-RAID or Exit.

Note: All graphics and screen shots shown in the manual are for reference only. The screen shots shown in the manual do not imply Super Micro's endorsement or non-endorsement on any 3rd party's product. Your screens may or many not look exactly the same as the graphics shown in this manual.

Creating a RAID 0 Volume:

a. Select "Create RAID Volume" from the main menu and press the <Enter> key. The following screen will appear:

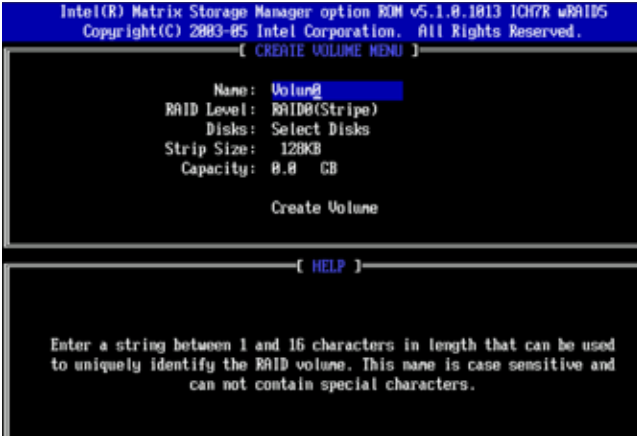

- b. Specify a name for the RAID 0 set and press the <Tab> key or the <Enter> key to go to the next field. (You can use the <Esc> key to select the previous menu.)
- c. When RAID Level item is highlighted, press the <Up Arrow>, <Down Arrow> keys to select RAID 0 (Stripe) and hit <Enter>.
- d. When the Select Disks item is highlighted, press <Enter> to select the HDD to configure as RAID. The following pop-up screen displays: (See the note on Page C-3)

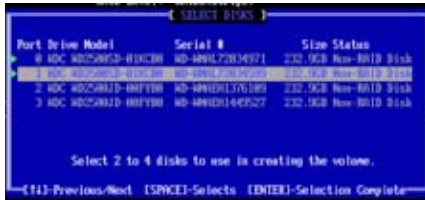

- e. Use the <Up Arrow>, <Down Arrow> keys to highlight a drive and press <Space> to select it. A triangle appears to confirm the selection of the drive. When all RAID drives for this volume have been selected, hit <Enter>.
- f. Use the <Up Arrow>, <Down Arrow> keys to select the stripe size, ranging from 4 KB to 128 KB for the RAID 0 array, and hit <Enter>. (**Note:** For a server, please use a lower stripe size, and for a multimedia system, use a higher stripe size. The default stripe size is 128 KB.)
- g. Press <Enter> when the Create Volume item is highlighted. A warning message displays.
- h. When asked "Are you sure you want to create this volume (Y/N), press "Y" to create the RAID volume, or type "N" to go back to the Create Volume menu.

Creating a RAID 1 Volume:

a. Select "Create RAID Volume" from the main menu and press the <Enter> key. The following screen will appear:

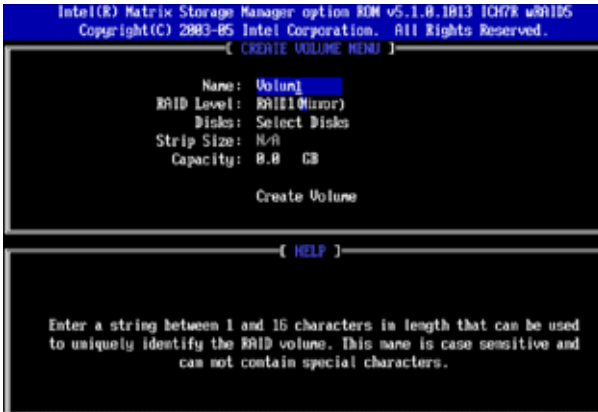

b. Specify a name for the RAID 1 set and press the <Tab> key or the <Enter> key to go to the next field. (You can use the <Esc> key to select the previous menu.)

c. When RAID Level item is highlighted, press the <Up Arrow>, <Down Arrow> keys to select RAID 1 (Mirror) and hit <Enter>.

d. When Select Disks Item is highlighted, press <Enter> to select the HDD to configure as RAID. The following pop-up screen displays: (See the note on Page C-3)

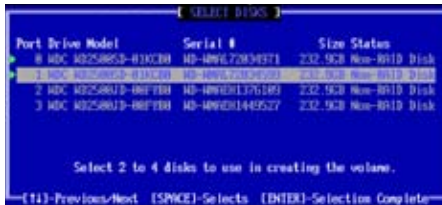

e. Use the <Up Arrow>, <Down Arrow> keys to highlight a drive and press <Space> to select it. A triangle appears to confirm the selection of the drive. When all RAID drives for this volume have been selected, hit <Enter>.

f. When the Capacity item is highlighted, enter your RAID volume capacity and hit <Enter>. The default setting is the maximum capacity allowed.

g. Press <Enter> when the Create Volume item is highlighted. A warning message displays.

h. When asked "Are you sure you want to create this volume (Y/N), press "Y" to create the RAID volume, or type "N" to go back to the Create Volume menu.

Creating a RAID 10 (RAID 1+ RAID 0):

a. Select "Create RAID Volume" from the main menu and press the <Enter> key. The following screen will appear:

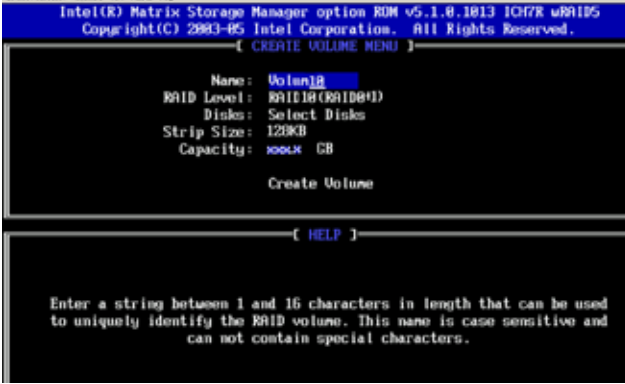

- b. Specify a name for the RAID 10 set and press <Enter>.
- c. When RAID Level item is highlighted, use the <Up Arrow>, <Down Arrow> keys to select RAID 10 (RAID1 + RAID0) and hit <Enter>.
- d. When Select Disks Item is height lighted, press <Enter> to select the HDD to configure as RAID. The following pop-up screen displays: (See the note on Page C-3)



- e. Use the <Up Arrow>, <Down Arrow> keys to highlight a drive and press <Space> to select it. A triangle appears to confirm the selection of the drive. When all RAID drives for this volume have been selected, hit <Enter>.
- f. When the Stripe Size is highlighted, use the <Up Arrow>, <Down Arrow> keys to select the stripe size from 4 KB to 128 KB for your RAID 10 and hit <Enter>. The default setting is 64 KB. (Note: For a server, please use a lower stripe size, and for a multimedia system, use a higher stripe size.)
- g. When the RAID Volume Capacity item is highlighted, enter your RAID volume capacity and hit <Enter>. The default setting is the maximum capacity allowed.
- h. Press <Enter> when the Create Volume item is highlighted. A warning message displays.
- i. When asked "Are you sure you want to create this volume (Y/N), press "Y" to create the RAID volume, or type "N" to go back to the Create Volume menu.

Creating a RAID 5 Set (Parity):

- a. Select "Create RAID Volume" from the main menu and press the <Enter> key. The following screen will appear:

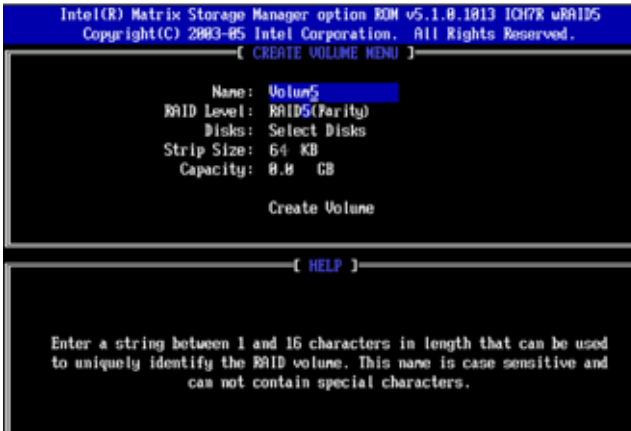

- b. Specify a name for the RAID 5 set and press <Enter>.
- c. When the Raid Level is highlighted, use the <Up Arrow>, <Down Arrow> keys to select RAID 5 (Parity) and hit <Enter>.
- d. When the Disk item is highlighted, press <Enter> to select the HDD to configure as RAID. The following pop-up screen displays: (See the note on Page C-3)

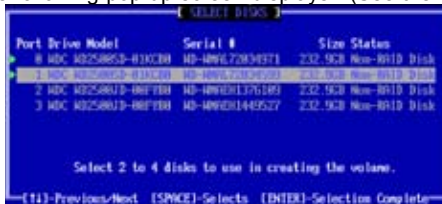

- e. Use the <Up Arrow>, <Down Arrow> keys to highlight a drive and press <Space> to select it. A triangle appears to confirm the selection of the drive. When all RAID drives for this volume have been selected, hit <Enter>.
- f. Use the <Up Arrow>, <Down Arrow> keys to select the stripe size, ranging from 4 KB to 128 KB for the RAID 5 array, and hit <Enter>. (**Note:** For a server, please use a lower stripe size, and for a multimedia system, use a higher stripe size. The default stripe size is 128 KB.)
- g. Enter your desired RAID volume capacity and press <Enter> when the capacity item is highlighted. The default setting is the maximum capacity allowed.
- h. Press Enter when the Create Volume item is highlighted. A warning message displays.
- i. When asked "Are you sure you want to create this volume (Y/N), press "Y" to create the RAID volume, or type "N" to go back to the Create Volume menu.

Deleting a RAID Volume:



(**Warning:** Be sure to back up your data before deleting a RAID set.
You will lose all data on the disk drives when deleting a RAID set.)

- a. From the main menu, select item2-Delete RAID Volume, and press <Enter>.
- b. Use the <Up Arrow>, <Down Arrow> keys to select the RAID set you want to delete and press . A Warning message displays.
- c. When asked "Are you sure you want to delete this volume (Y/N), press "Y" to delete the RAID volume, or type "N" to go back to the Delete Volume menu.

Resetting to Non-RAID and Resetting a RAID HDD



(Warning: Be cautious when you reset a RAID volume HDD to non-RAID or Resetting a RAID HDD. Resetting a RAID volume HDD or Resetting a RAID HDD will reformat the HDD and delete the internal RAID structure on the drive.)

- a. From the main menu, select item3-Reset Disks to Non- RAID, and press <Enter>. The following screen will appear:



- b. Use the <Up Arrow>, <Down Arrow> keys to highlight the RAID set drive to reset and press <Space> to select. (For this feature to work properly, you must select all drives within a RAID volume.)
- c. Press <Enter> to reset the RAID set drive. A Warning message displays.
- d. Press "Y" to reset the drive, or type "N" to go back to the main menu.

Exiting the Intel Matrix Storage Manager Utility:

- a. From the main menu, select item4-Exit, and press <Enter>. A warning message will appear.
- b. Press "Y" to reset the drive, or type "N" to go back to the main menu.

C-2 Installing the Windows XP/2003 OS for Systems with RAID Functions (For C2SBA+II only)

Note 1. Your motherboard may come with the ITE-8212 IDE Controller chip or the ITE-8211 Controller chip. For proper OS installation, please obtain your ITE IDE Controller model and other driver information before starting the OS installation. To obtain your ITE Controller model# or other driver information, you can either reboot the system and obtain your controller/driver Information displayed on the Option ROM screen at bootup or identify your ITE IDE Controller and other controller chips (if available) on the motherboard by referring to the board layout on Page 1-4 in Chapter 1. **Note 2.** The Intel ICH9R SATA RAID does not support the Windows 2000.

1. Insert Microsoft's Windows XP/2003 Setup CD in the CD Drive, and the system will start booting up from CD. (See **Note 1** above.)
2. Press the <F6> key when the message-" Press F6 if you need to install a third party SCSI or RAID driver" displays.
3. When the Windows XP/2003 Setup screen appears, press "S" to specify additional device(s).
4. Insert the Driver Diskette-"ITE 8212 ATA RAID Controller for Windows" or the Driver Diskette-"ITE 8211 ATA ATAPI Controller for Windows" into Drive A: and press <Enter>. (See **Note 1** above.)
5. When the Windows XP/2003 Setup screen appears, press "S" to specify additional device(s).
6. Insert the driver diskette-"Intel AA RAID XP/2003 Driver for ICH9R" into Drive A: and press the <Enter> key.
7. Choose the Intel(R) ICH9R SATA RAID Controller from the list indicated in the XP/2003 Setup Screen, and press the <Enter> key.
8. Press the <Enter> key to continue the installation process. (If you need to specify any additional devices to be installed, do it at this time.) Once all devices are specified, press the <Enter> key to continue with the installation.
9. From the Windows XP/2003 Setup screen, press the <Enter> key. The XP/2003 Setup will automatically load all device files and then, continue the Windows XP/2003 installation.
10. After the Windows XP/2003 OS Installation is completed, the system will automatically reboot.

C-3 Installing the Windows XP/2000/2003 OS for Systems without RAID Functions

1. Insert Microsoft's Windows XP/2000/2003 Setup CD in the CD Drive, and the system will start booting up from CD.
2. Press the <F6> key when the message-" Press F6 if you need to install a third party SCSI or RAID driver" displays.
3. When the Windows XP/2000/2003 Setup screen appears, press "S" to specify additional device(s).
4. Insert the driver diskette-"ITE RAID XP/2000/2003 Driver for IDE" into Drive A: and press the <Enter> key.
5. Press the <Enter> key to proceed with the installation process. (If you need to specify any additional devices to be installed, do it at this time.) Once all devices are specified, press the <Enter> key to continue with the installation.
6. From the Windows XP/2000/2003 Setup screen, press the <Enter> key. The XP/2000/2003 Setup will automatically load all device files and then continue with the Windows XP/2000/2003 installation.
7. After the Windows XP/2000/2003 OS Installation is completed, the system will automatically reboot.
8. Insert the Supermicro Setup CD that came with your motherboard into the CD Drive during system boot, and the main screen will display.

Notes

Appendix D

Adaptec HostRAID Setup Guidelines (For the C2SBA+II Only)

After all the hardware has been installed, you must first configure the Adaptec Embedded Serial ATA RAID before you install the Windows operating system. The necessary drivers are all included on the Supermicro bootable CDs that came packaged with your motherboard. **Note 1:** The following section provides information on the Adaptec SATA RAID Driver based on the Intel ICH9R Controller.

D-1 Introduction to the Adaptec Embedded SATA RAID Controller Driver

Serial ATA (SATA)

Serial ATA(SATA) is a physical storage interface. It uses a single cable with a minimum of four wires to create a point-to-point connection between devices. It is a serial link which supports SATA Transfer rates up to 3.0 Gbps. Because the serial cables used in SATA are thinner than the traditional cables used in Parallel ATA(PATA), SATA systems have better airflow and can be installed in smaller chassis than Parallel ATA. In addition, the cables used in PATA can only extend to 40cm long, while Serial ATA cables can extend up to one meter. Overall, Serial ATA provides better functionality than Parallel ATA.

Introduction to the Intel ICH9R Controller Hub

Located in the South Bridge of the Intel G33 Chipset, the ICH9R Controller Hub provides the I/O subsystem with access to the rest of the system. It supports the Adaptec's firmware, which support up to six Serial ATA drives, up to two RAID volumes and up to six drives in RAID Configurations.

* Adaptec's SATA HostRAID Controller Firmware supports:	
Drives supported	Four
Number of RAID Volumes supported	Two
Total Drives in RAID Configurations	Four
Examples of Valid RAID Configurations:	
Two drives of RAID 1 + two drives of RAID 0	
Two drives of RAID 1 + two drives of RAID 1	
Three drives of RAID 0	
Four drives of RAID 0	
Examples of Invalid RAID Configurations:	
Three drives of RAID 0 + two drives of RAID 1	
(*Note: this table is applicable to Adaptec's HostRAID Controller Firmware only.)	

To configure the Adaptec SATA RAID for Operating Systems that support RAID functions(--Windows, Red Hat & SuSe, Linux)

1. Press the key during system bootup to enter the BIOS Setup Utility.

Note: If it is the first time powering on the system, we recommend you load the Optimized Default Settings. If you have already done so, please skip to Step 3.

2. Use the arrow keys to select the "Exit" Settings. Once in the "Exit" settings, Scroll down to select "Load Optimized Default Settings" and press the <Enter> key. Select "OK" to confirm the selection. Press the <Enter> key to load the default settings for the BIOS.

3. Use the arrow keys to select the "Main" section in BIOS.

4. Scroll down to "SATA Control Mode" and press the <Enter> key to select "Enhanced"

5. Scroll down to "SATA RAID Enabled" and press <Enter>. Then, select "Enabled."

6. Scroll down to "ICH RAID Codebase" and select "Adaptec". Then press <Enter>. (For ICH RAID Codebase: Change the setting from Intel to Adaptec.)

7. Scroll down to "Exit". Select "Exit Saving Changes" from the "Exit" menu. Press the <Enter> key to save the changes and exit the BIOS.

8. Once you've exited the BIOS Utility, the system will re-boot.

9. During the system boot-up, press the <Ctrl> and <A> keys simultaneously to run the Intel RAID Configuration Utility when prompted by the following message:
Press <Ctrl> <A> for Intel RAID Configuration Utility.

The Adaptec Embedded Serial ATA with HostRAID Controller Driver

The Adaptec Embedded Serial ATA RAID Controller adds SATA/RAID functionality and performance enhancements to a motherboard. RAID striping (RAID 0) allows data to be written across multiple drives, greatly improving hard disk I/O performance. RAID mirroring (RAID 1) allows data to be simultaneously written to two drives, improving data security even if a single hard disk fails. A Stripe of Mirrors (RAID 10) provides multiple RAID 1 mirrors and a RAID 0 stripe, maximizing data security and system efficiency. By incorporating the Adaptec Embedded Serial ATA into the motherboard design, Supermicro's C2SBA+II offers the user the benefits of SATARAID without the high costs associated with hardware RAID applications.

Using the Adaptec RAID Configuration Utility (ARC)

The Adaptec RAID Configuration Utility, an embedded BIOS Utility, includes the following:

Array Configuration Utility: Use this utility to create, configure and manage arrays.

Disk Utilities: Use this option to format or verify disks.

To run the Adaptec RAID Configuration Utility, you will need to do the following:

1. Enable RAID functions in the system BIOS. (Refer to Chapter 4 for System BIOS Configurations).
2. Press the <Ctrl> and <A> keys simultaneously when prompted to do so during system boot. (Refer to the previous page for detailed instructions.)

A. Using the Array Configuration Utility (ACU)

When you press <Ctrl> and <A> keys simultaneously at the prompt during system bootup, the main menu will appear.

Note: To select an option, use the arrow keys to highlight the item and then press the <Enter> key to select it. To return to the previous menu, press the <ESC> key. Press the <Insert> key to select a drive. When a drive is highlighted (selected), press the <Delete> key to de-select it.

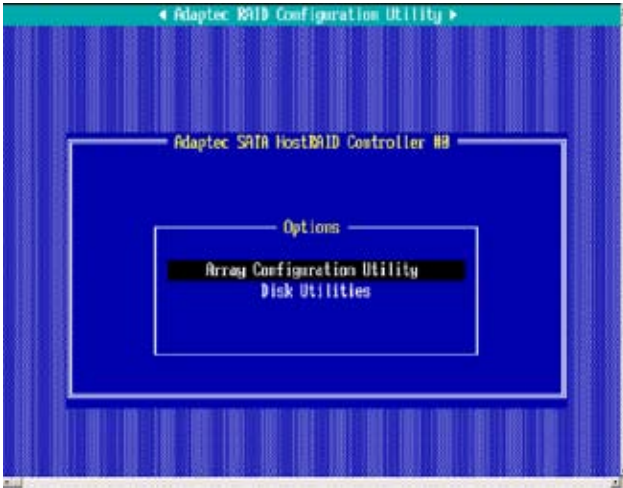

Managing Arrays

Select this option to view array properties, and configure array settings.

To select this option, using the arrow keys and the <enter> key, select "Managing Arrays" from the main menu as shown above.



Configuring Disk Drives

You may need to configure a disk drive before you can use it.

Caution: Configuring a disk may overwrite the partition table on the disk and may make any data on the disk inaccessible. If the drive is used in an array, you may not be able to use the array again.

Do not configure a disk that is part of a boot array. To determine which disks are associated with a particular array, please refer to [Viewing Array Properties](#).

To configure a disk drive:

1. From the main menu (shown on Page D-4), select Configure Drives and hit <Enter> (as shown below.)

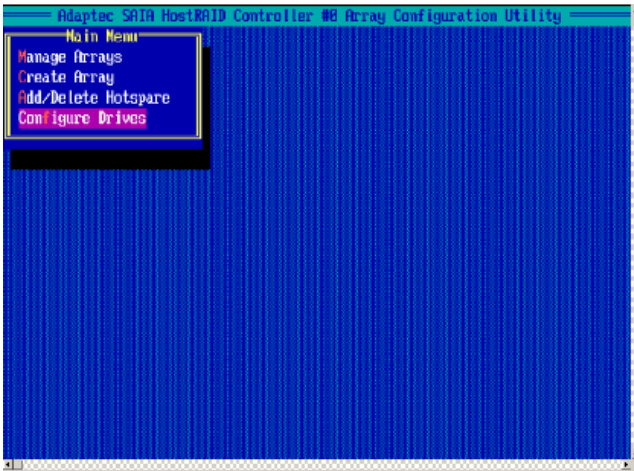

2. From the "Select Drives for Configuring" List (shown below,) select the drives you want to configure and press <Insert>.



3. The drive you've selected will appear in the "Selected Drives Dialog Box" on the right (as shown below.) Repeat the same steps until all drives that you want to configure appear in the selected drives box.

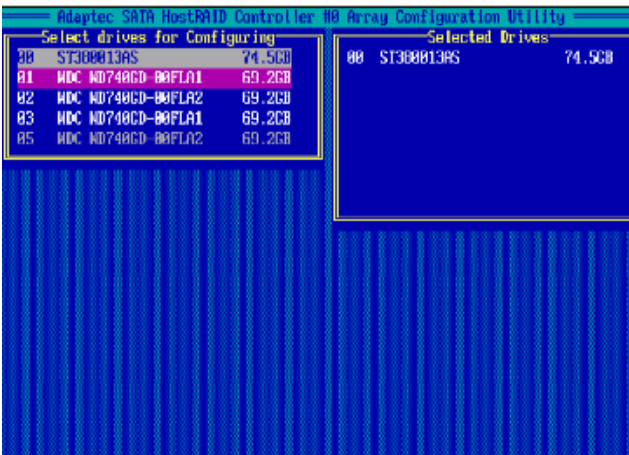

4. Once both drives display in the selected drive box, press <Enter>

5. Read the warning message as shown in the screen below.

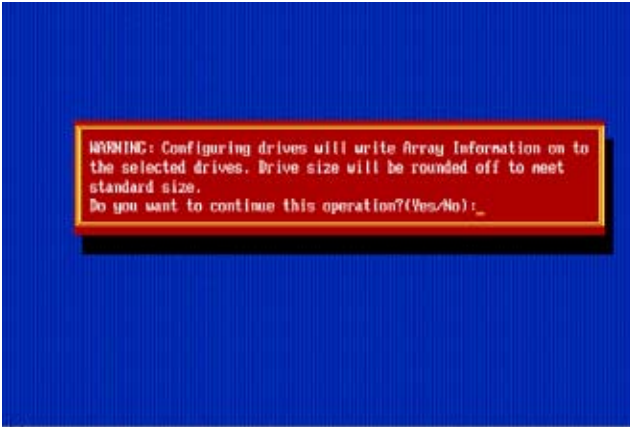

6. Make sure that you have selected the correct disk drives to configure. If correct, type Y to continue.

Creating Arrays

Before you create arrays, make sure that the disks for the array are connected and installed in your system. Note that disks with no usable space, or disks that are un-initialized or not formatted are shown in gray and cannot be used. **Note:** It is recommended that you configure devices before you create arrays.

To create an array:

1. From the main menu (shown on page D-4), select Create Array.
2. Select the disks for the new array and press Insert (as the screen shown below).
Note: To de-select any disk, highlight the disk and press Delete.

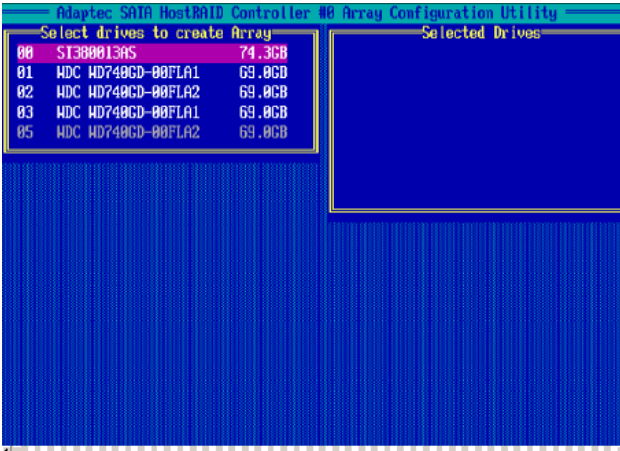

3. The arrays you have selected will appear on the Selected Drives dialog box on the right (as shown below.)
- 4 Press Enter when both disks for the new array are selected. The Array Properties menu displays.

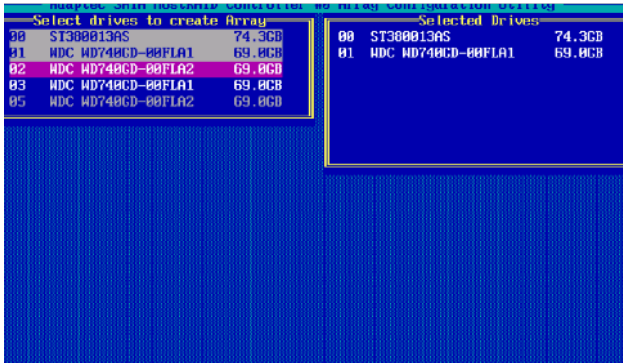

Assigning Array Properties

Once a new array is completed, you can assign properties to the array.

Caution: Once the array is created and its properties are assigned, and you cannot change the array properties using this utility.

To assign properties to the new array:

1. In the Array Properties menu (as shown in the screen below), select an array type and press Enter. Only the available array types will be displayed on the screen. (RAID 0 or RAID 1 requires two drives.)

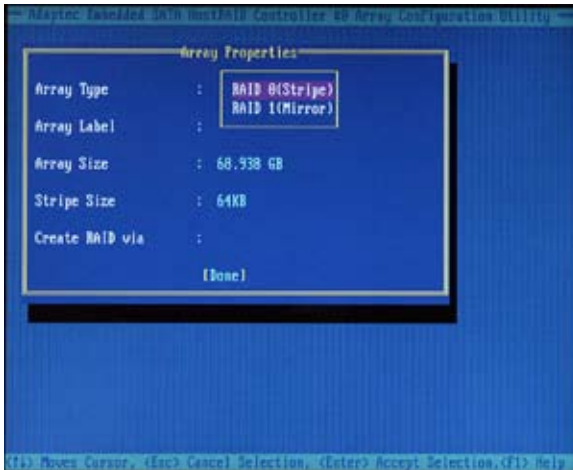

2. Under the item "Arrays Label", type in a label and press <Enter>. **Note:** The label shall not be more than 15 characters.)
3. For RAID 0, select the desired stripe size. Note: Available stripe sizes are 16, 32, and 64 KB. 64K is default. Please do not change the default setting.)
4. The item: "Create RAID via" allows you to select between the different ways of creating methods for RAID 0 and RAID 1.

The following table gives examples of when each is appropriate.

Raid Level	Create Via	When Appropriate
RAID 0	No Init	Creating a RAID 0 on new drives
RAID 0	Migrate (*Note)	Creating a RAID 0 from one new drive and one drive with data you wish to preserve
RAID 1	Build1	Any time you wish to create a RAID 1, but especially if you have data on one drive that you wish to preserve
RAID 1	Clear	Creating a RAID 1 on new drives, or when you want to ensure that the array contains no data after creation.
RAID 1	Quick	Fastest way to create a RAID 1. Appropriate when using new drives
RAID 1	Init	

Note: If you select Migrate for RAID 0, or Build for RAID 1, you will be asked to select the source drive. The contents of the source drive will be preserved. However, the data on the new drive will be lost.

5. When you are finished, press <Done> (as the screen shown below).

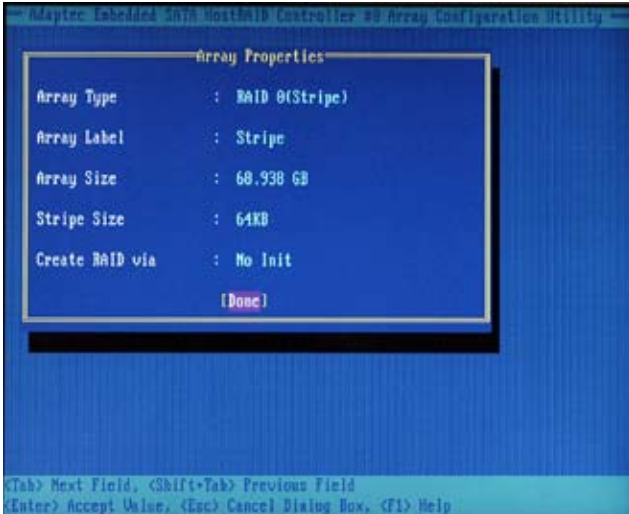

Notes:

1. Before adding a new drive to an array, be sure to back up any data stored on the new drive; otherwise, all data will be lost.
2. If you stop the Build or Clear process on a RAID 1, you can restart it by pressing <Ctrl> and <R>.
3. If you've used the Quick Init option to create a RAID1, it may return some data mis-comparison when you run a consistency check at a later time. This is normal.
4. The Adaptec Host RAID allows you to use drives of different sizes in a RAID. However, you can only select a smaller drive as the source or first drive during a build operation.
5. When migrating from single volume to RAID 0, migrating from a larger drive to a smaller drive is allowed. However, the destination drive must be at least half the capacity of the source drive.
6. It is not recommended that you migrate or build an array on Windows dynamic disks (volumes) because it will result in data loss.

Warning: Do not interrupt the process when you create a RAID 0 using the Migrate option. If you do, you will not be able to restart the system, or to recover the data that was on the source drive.

Adding a Bootable Array

To make an array bootable:

1. From the Main menu, select Manage Arrays.
2. From the List of Arrays, select the array you want to make bootable, and press <Ctrl> and .
3. Enter Y to create a bootable array when the following message is displayed: "This will make all other existing bootable array non-bootable. Do you want to make this array bootable? (Yes/No):" Then, a bootable array will be created. An asterisk (*) will appear next to the bootable array (as shown in the picture below:)

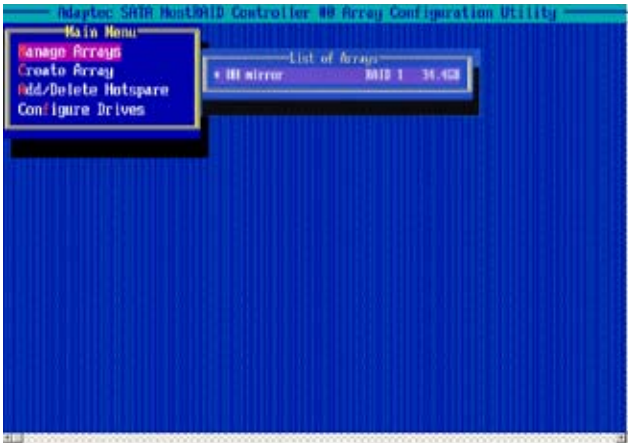

Deleting a Bootable Array

To delete a bootable array:

1. From the Main menu, select Manage Arrays.
2. From the List of Arrays, select the bootable array you want to delete, and press <Ctrl> and . Note: a bootable array is the array marked with an asterisk (as shown in the picture above.)
3. When the following message is displayed: "The array is already marked bootable. Do you want to make this array as not bootable? (Yes/No)," Enter Y to delete a bootable array. The bootable array will be deleted and the asterisk will disappear.

Note: Do not use the delete key to delete the bootable array.

Adding/Deleting Hotspares

To add a Hotspare:

Note: In order to rebuild a RAID (RAID 0 or RAID 1), you would need to add a new HDD as a hotspare.

1. From the main menu (shown on Page D-4), select Add/Delete Hotspares.
2. Use the up and down arrow keys to highlight and select the disk you want to designate as a hotspare, and press <Insert>, and then, press <Enter>.
3. Press Yes when the following prompt is displayed:

"Do you want to create spare?" (Yes/No?)

The spare you have selected will appear in the Selected drives Menu.

To delete a Hotspare:

1. From the main menu (shown on Page D-4), select Add/Delete Hotspares.
2. Use the up and down arrow keys to highlight and select the Hotspare you want to delete, and press <delete>, and then, press <Enter>.
3. When the following warning is displayed: "Do you want to delete the hot spare?" (Yes/No?), press Yes to delete the hotspare you have selected.

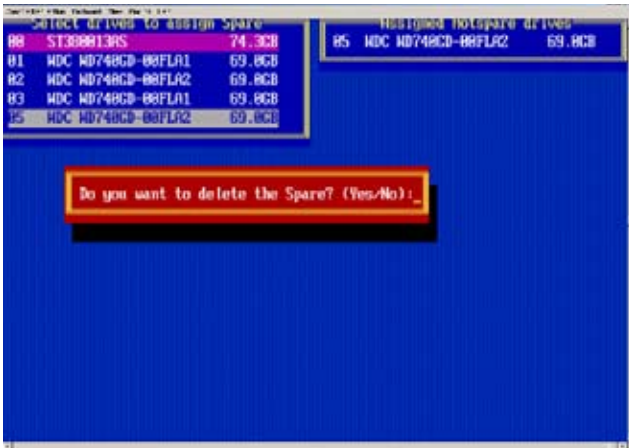

Viewing Array Properties

To view the properties of an existing array:

1. From the main menu, select Manage Arrays and hit <Enter> (as shown on the previous page.)
2. From the List of Arrays dialog box (shown below), select the array you want to view and press Enter.

The Array Properties dialog box appears (as shown below), showing detailed information on the array. The physical disks associated with the array are displayed here.

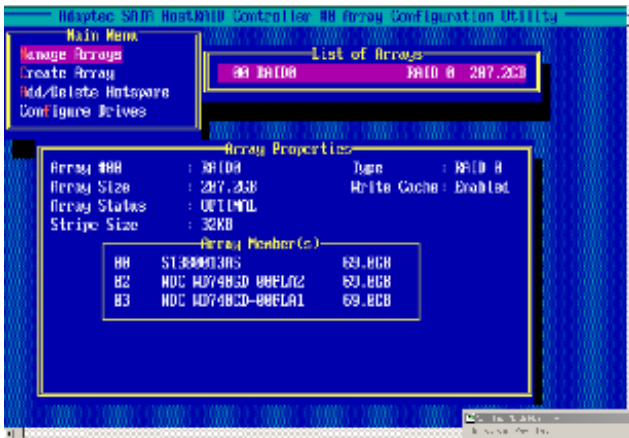

3. Press Esc to return to the previous menu.

Rebuilding Arrays

Note 1: Rebuilding applies to Fault Tolerant array (RAID 1) only.

If an array Build process is interrupted or when one critical member is missing, you must perform a Rebuild to restore its functionality. For a critical array rebuild operation, the optimal drive is the source drive.

Note 2: If no spare array exists and a hard disk drive fails, you need to create a spare before you can rebuild an array.

To Rebuild an array:

1 From the Main Menu, select Manage Arrays (as shown in the screen below). From the List of Arrays, select the array you want to rebuild.

2 Press <Ctrl> and <R> to rebuild.

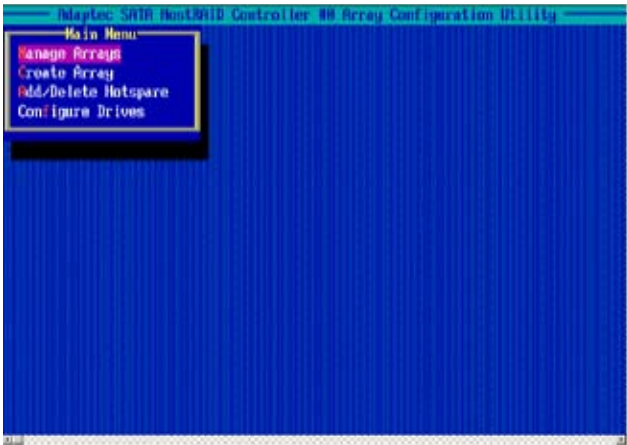

Deleting Arrays

Warning!! Back up the data on an array before you delete it to prevent data loss
Deleted arrays cannot be restored.

To delete an existing array:

1. From the main menu (shown on Page D-4), select Manage Arrays.
2. Select the array you wish to delete and press <delete>.
3. In the Array Properties dialog box, select Delete and press <Enter>. The following prompt is displayed:

Warning!! Deleting the array will render array unusable. Do you want to delete the array? (Yes/No):

RAID 1 only—the following prompt is also displayed:

Deleting the partition will result in data loss! Do you also want to delete the partition? (Yes/No):

4. Press Yes to delete the array and partition or No to return to the previous menu.
5. Press Esc to return to the previous menu.

Using the Disk Utilities

The Disk Utilities enable you to format or verify the media of your Serial ATA hard disks.

To access the disk utilities:



1. From the Adaptec RAID Configuration Utility Menu, select Disk Utilities (as shown above) and press <Enter>. The following screen appears.

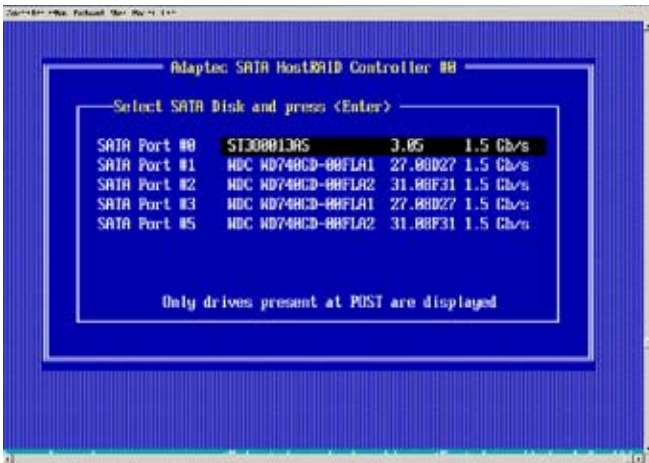

2. Select the desired disk and press <Enter>. The following screen appears:

To format a disk:

Note: The operation of Formatting Disk allows you to perform a low-level formatting of a hard drive by writing zeros to the entire disk. Serial ATA drives are low-level formatted at the factory and do not need to be low-level formatted again.

3. When the screen shown below displays, select Format Disk and press <Enter>. The following screen appears:

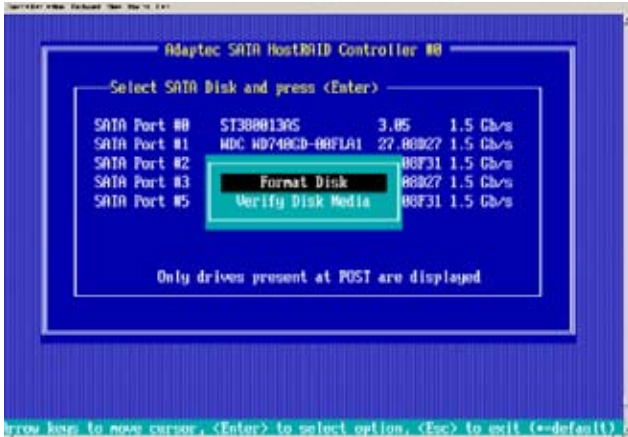

4. Read the warning message when it appears in the screen as shown below. To continue with disk formatting, select Yes and hit <Enter>. Otherwise, select No and press <Enter>.

Caution: Formatting a disk destroys all data on the drive. Be sure to back up your data before formatting a disk.

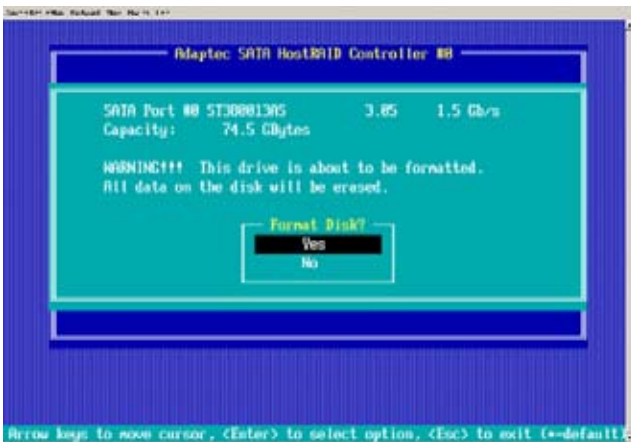

To verify disk media:

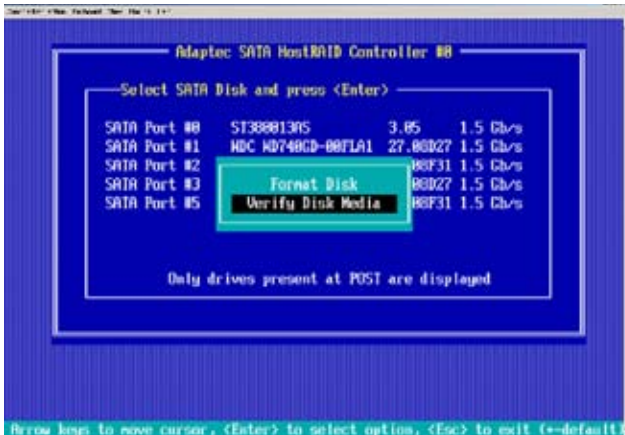

3. When the screen shown above displays, select Verify Disk Media and press <Enter>.

4. A message will display, indicating that the selected drive will be scanned for media defects. Select Yes and hit <Enter> to proceed with disk verifying; otherwise, select No and hit <Enter>.



To Exit Adaptec RAID Configuration Utility

1. Once you have completed RAID array configurations, press ESC to exit. The following screen will appear.
2. Press Yes to exit the Utility.



D-2 Installing the Intel ICH9R Driver by Adaptec and the OS

- a. Insert Supermicro's bootable CD that came with the package into the CD Drive during the system reboot, and the screen: "Supermicro Driver Diskette Maker" will appear.
- b. Choose from the list the item: "Intel ICH9R Driver by 3rd Party (Adaptec)" and press <Enter>.
- c. From the next screen displayed, choose the OS driver you want to install and press <Enter>.
- d. Insert a formatted diskette into drive A: and press <Enter> as prompted.
- e. Exit the program after the process is completed. Then, reboot the system.
- f. Insert the Microsoft Windows OS Setup CD in the CD Driver, and the system will start to boot up from CD.
- g. Press the <F6> key when the message-"Press F6 if you need to install a third party SCSI or RAID driver" displays.
- h. When the Windows OS Setup screen appears, press "S" to specify additional device(s).
- i. Insert the driver diskette-"Adaptec Embedded Serial ATA Raid Controller Driver" into Drive A: and press the <Enter> key.
- j. Choose the Adaptec Embedded Host Serial ATA Raid Controller from the list indicated in the Windows OS Setup Screen, and press the <Enter> key.
- k. Press the <Enter> key to continue the installation process. (If you need to specify any additional devices to be installed, do it at this time.) Once all devices are specified, press the <Enter> key to continue with the installation.
- l. From the Windows OS Setup screen, press <Enter>. The OS Setup will automatically load all device files, and, then, continue with the Windows OS installation.
- m. After the Windows OS Installation is completed, the system will automatically reboot.

Appendix E

Software Installation Instructions

E-1 Installing Drivers

After you've installed the Windows Operating System, a screen as shown below will appear. You are ready to install software programs and drivers that have not yet been installed. To install these software programs and drivers, click the icons to the right of these items.



Driver/Tool Installation Display Screen

Note: Click the icons showing a hand writing on the paper to view the readme files for each item. Click a computer icon to the right of an item (from top to the bottom) one at a time. **After installing each item, you must re-boot the system before proceeding with the next item on the list.** The bottom icon with a CD on it allows you to view the entire contents of the CD.

E-2 Configuring Supero Doctor III

The Supero Doctor III program is a Web-base management tool that supports remote management capability. It includes Remote and Local Management tools. The local management is called the SD III Client. The Supero Doctor III program included on the CDROM that came with your motherboard allows you to monitor the environment and operations of your system. Supero Doctor III displays crucial system information such as CPU temperature, system voltages and fan status. See the Figure below for a display of the Supero Doctor III interface.

Note 1: Both default user name and password are ADMIN.

Note 2: In the Windows OS environment, the Supero Doctor III settings take precedence over the BIOS settings. When first installed, Supero Doctor III adopts the temperature threshold settings previously set in the BIOS. Any subsequent changes to these thresholds must be made within Supero Doctor, since the SD III settings override the BIOS settings. For the Windows OS to adopt the BIOS temperature threshold settings, please change the SDIII settings to be the same as those set in the BIOS.

Supero Doctor III Interface Display Screen-I (Health Information)



Supero Doctor III Interface Display Screen-II (Remote Control)

Note: SD III Software Revision 1.0 can be downloaded from our Web site at: ftp://ftp.supermicro.com/utility/Supero_Doctor_III/. You can also download SDIII User's Guide at: <http://www.supermicro.com/PRODUCT/Manuals/SDIII/UserGuide.pdf>. For Linux, we will still recommend that you use Supero Doctor II.

Notes

(Disclaimer Continued)

The products sold by Supermicro are not intended for and will not be used in life support systems, medical equipment, nuclear facilities or systems, aircraft, aircraft devices, aircraft/emergency communication devices or other critical systems whose failure to perform be reasonably expected to result in significant injury or loss of life or catastrophic property damage. Accordingly, Supermicro disclaims any and all liability, and should buyer use or sell such products for use in such ultra-hazardous applications, it does so entirely at its own risk. Furthermore, buyer agrees to fully indemnify, defend and hold Supermicro harmless for and against any and all claims, demands, actions, litigation, and proceedings of any kind arising out of or related to such ultra-hazardous use or sale.