

MI5VMT
MVP4 Micro ATX Motherboard

User's Manual

Version 1.0

Copyright Notice

This publication is protected by copyright and all rights are reserved. No part of it may be reproduced or transmitted by any means or in any form, without prior consent of the original manufacturer.

The information in this document has been carefully checked and is believed to be accurate. However, the original manufacturer assumes no responsibility for any inaccuracies that may appear in this manual. In no event will the original manufacturer be liable for direct, indirect, special, exemplary, incidental, incidental or consequential damages resulting from any defect or omission in this manual, even if advised of possibility of such damages. The material contained herein is for informational purposes only.

Acknowledgments

Award is a registered trademark of Award Software International, Inc.

PS/2 is a trademark of International Business Machines Corporation.

Intel and Pentium are registered trademarks of Intel Corporation.

MVP4 is a trademark of VIA Technologies.

Microsoft Windows is a registered trademark of Microsoft Corporation.

All other product names or trademarks are properties of their respective owners.

Contents

Chapter 1 Introduction.....	1
Chapter 2 Specifications.....	3
Chapter 3 Hardware Description.....	5
3.1 Processor.....	7
3.2 L2 Cache.....	7
3.3 Main Memory.....	7
3.4 BIOS.....	9
3.5 Onboard VGA.....	9
3.6 Hardware Monitoring.....	9
3.7 Onboard Multi-I/O.....	9
3.8 Interrupt Request (IRQ) Lines.....	10
3.9 Onboard PCI-IDE.....	10
3.10 DMA Channels.....	10
3.11 I/O Port Address Map.....	11
3.12 Onboard Audio.....	11
3.13 AMR Slot.....	11
Chapter 4 Configuring the Motherboard.....	13
4.1 SW1(4-8): CPU Voltage Setting.....	15
4.2 SW2(1-4): CPU Bus Speed/FSB Selector.....	16
SW1(1-3): CPU Bus Speed Multiplier.....	16
4.3 JP2: Clear CMOS Select.....	20
Chapter 5 Installation.....	21
5.1 I/O Connectors.....	23
5.2 J1: PS/2 Keyboard and PS/2 Mouse Connectors.....	23
5.3 J2: USB Connector.....	24
5.4 J3, J12: Serial Ports.....	24
5.5 J4: Parallel Port Connector.....	25
5.6 J5: VGA Port Connector.....	25
5.7 J6, J7, J8, J9: Line Out, Line In, Mic In, Game Port.....	26
5.8 J10: CPU Fan Power Connector.....	26
5.9 J11: ATX Power Supply Connector.....	26
5.10 J14, J16: CD-ROM Audio In Connectors.....	27

5.11 J17: Wake on LAN Connector.....27
5.12 J18: IrDA Connector.....28
5.13 J19: Chassis Fan Power Connector.....28
5.14 J20: Front Bezel Connectors.....29
5.15 J21: Floppy Drive Connector.....31
5.16 J23, J22: EIDE Connectors.....32

Chapter 6 BIOS Configuration.....33

6.1 BIOS Introduction.....36
6.2 BIOS Setup.....36
6.3 Standard CMOS Setup.....38
6.4 BIOS Features Setup.....41
6.5 Chipset Features Setup.....44
6.6 Power Management Setup.....47
6.7 PNP/PCI Configuration.....50
6.8 Load BIOS Defaults.....52
6.9 Load Setup Defaults.....52
6.10 CPU Features Setup.....53
6.10 Integrated Peripherals.....54
6.11 Supervisor / User Password.....56
6.12 IDE HDD Auto Detection.....57
6.13 Save & Exit Setup.....58
6.14 Exit Without Saving.....58

Chapter 7 VIA Drivers Installation Guide.....59

7.1 Windows 98 4-in-1 Driver Installation.....59
7.2 Windows 98/95 DirectX Installation.....62
7.3 Windows 98 VGA Driver Installation.....64
7.4 Windows 98 Audio Driver Installation.....66
7.5 Windows 98SE 4-in-1 Driver Installation.....67
7.6 Windows 98SE VGA Driver Installation.....69
7.7 Windows 98SE Audio Driver Installation.....70
7.8 Windows 95 4-in-1 Driver Installation.....71
7.9 Windows 95 VGA Driver Installation.....76
7.10 Windows 95 Audio Driver Installation.....77
7.11 Windows NT 4.0 VGA Driver Installation.....78
7.12 Windows NT 4.0 Audio Driver Installation.....79

Chapter 8 System Monitor Installation.....83

Appendix.....86

A. Additions & Errata.....86

Chapter 1 Introduction

This manual is designed to give you information on the MI5VMT motherboard. It is divided into the following sections:

- **Introduction**
- **Specifications**
- **Hardware Description**
- **Configuring the Motherboard**
- **Installation**
- **BIOS Configuration**
- **VIA Drivers Installation Guide**
- **System Monitor Installation**

Checklist

Please check that your package is complete and contains the items below. If you discover damaged or missing items, please contact your dealer.

- The MI5VMT Motherboard
- 1 IDE ribbon cable
- 1 floppy ribbon cable
- 1 COM port ribbon cable
- 1 CD containing a system monitoring utility, drivers for the onchip VGA, onchip audio and Bus Master IDE driver and utilities.

Note: The ATA-66 IDE cable that is used in conjunction with Ultra DMA/66 hard disks is optional. Refer to the figure below on how to connect the cable.



This page was intentionally left blank.

Chapter 2 Specifications

The MI5VMT is a high-performance Micro ATX MVP4 motherboard with a Socket 7 connector for Socket 7-level processors. The VT82C686A chip that comes with the MVP4 chipset has built-in multi I/O, VGA, and hardware monitoring functions. The motherboard also has an AMR slot that supports an optional modem riser card. The main features of the motherboard consist of the following:

CPU Socket

Socket 7

System Speed

120~550MHz

Bus Speed

60~124MHz

Processor

Intel Pentium 120/133/150/166/200

Intel Pentium MMX (P55C) 120/133/150/166/200/233

Cyrix 6x86/6x86L P150+/P166+/P200+

Cyrix 6x86MX PR166/PR200/PR233/PR266

Cyrix 6x86MII PR266/PR300/PR333/PR366

AMD K5 PR100/PR133/PR166

AMD K6 166/200/233/266/300

AMD K6-2/300/333/350/400/450/500

AMD K6-2+/400

AMD K6-3/400/450/500/550

IDT WinChip C6 180/200/225MHz

IDT WinChip2-3D C6 200/225/266/300MHz

L2 Cache

1MB or 2MB

Main Memory

Three 168-pin DIMM sockets

Memory types: Extended Data Output (EDO) DRAM, SDRAM (Synchronous DRAM)

Memory size: 32MB, 64MB, 128MB

Chipset

VIA's VT82C686A chipset with built-in PCI-IDE

Super I/O

Built-in VIA's VT82C686A chip

- Two 16550 UART compatible serial ports
- One parallel port (ECP/EPP compatible)
- One floppy controller (2.88MB compatible)
- One IrDA port

PCI Bus Master IDE Controller (Ultra DMA/66)

The onboard VIA chipset's PCI Bus Master IDE (Ultra DMA/66) controller with two connectors for up to four IDE devices in two channels, supporting enhanced IDE devices such as tape backup and CD-ROM drives, PIO Mode 3/4 and Bus Mastering Ultra DMA/66

NOTE: A UDMA66 cable should be used for UDMA66 interface. Under Windows NT 4.0, you need to install Windows NT Service Pack 4.)

BIOS

Award BIOS with ISA Plug and Play (PnP) extension, DMI, bootable CD-ROM and power-management features. The BIOS is Y2K (Year 2000) compliant.

Keyboard and Mouse Connectors

PS/2 type

USB Connector

2 ports on board

Windows 95/98-shut-off

Allows shut-off control from within Windows 95/98

Expansion Slots

Three 32-bit PCI slots

One 16-bit ISA slots

One AMR slot (supports an optional modem riser card)

Form Factor

Micro ATX, 9.45" x 8.27 (24cm x 21cm)

Chapter 3 Hardware Description

This chapter briefly describes each of the major features of the MI5VMT motherboard. The layout of the board in Figure 1 shows the location of the key components. The topics covered in this chapter are as follows:

3.1 Processor.....	7
3.2 L2 Cache.....	7
3.3 Main Memory.....	7
3.4 BIOS.....	9
3.5 Onboard VGA.....	9
3.6 Hardware Monitoring.....	9
3.7 Onboard Multi-I/O.....	9
3.8 Interrupt Request (IRQ) Lines.....	10
3.9 Onboard PCI-IDE.....	10
3.10 DMA Channels.....	10
3.11 I/O Port Address Map.....	11
3.12 Onboard Audio.....	11
3.13 AMR Slot.....	11

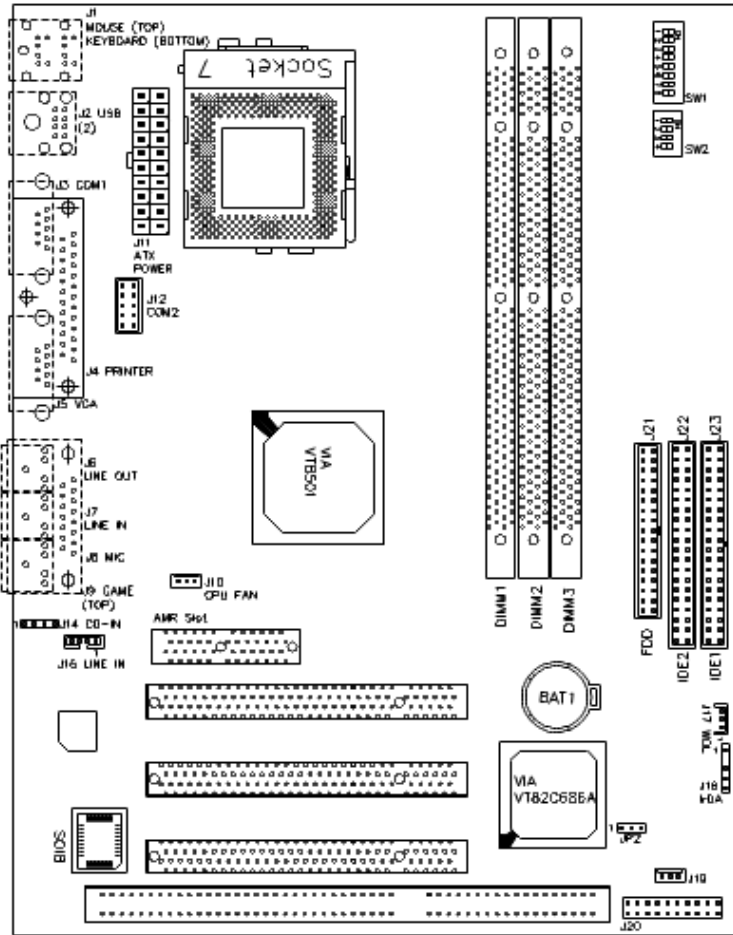

Figure 1: Layout of the MI5VMT Motherboard

3.1 Processor

The MI5VMT motherboard is designed to take Socket 7 processors with system speed of 120MHz to 550MHz at a bus speed of 60MHz to 124MHz. To be able to use the your processor with the motherboard properly, DIP switches on the motherboard should be configured correctly. Two DIP switches are available to configure the CPU voltage, bus speed (front side bus), and bus speed multiplier. Please refer to the following chapter on how to configure the CPU frequency.

3.2 L2 Cache

The L2 cache is integrated in the processor.

3.3 Main Memory

The MI5VMT motherboard supports three 168-pin DIMM (Dual In-line Memory Module) sockets to form a memory configuration from 32MB to 384MB. DIMM modules can be 32MB, 64M and 128MB in SDRAM. In populating the DIMM sockets, any socket can be populated first. Refer to the following table on how to do the memory configuration.

***NOTE:** Use SDRAM modules with PC100 specification when running 100MHz CPU bus speed. With 66MHz CPU bus speed, SDRAM modules with PC66 or PC100 specification can be used.*

Installing and Removing DIMMs

To install the DIMMs, locate the memory slots on the motherboard and perform the following steps:

1. Hold the DIMM so that the two keys of the DIMM align with those on the memory slot.
2. Gently push the DIMM in an upright position until the clips of the slot close to hold the DIMM in place when the DIMM touches the bottom of the slot.
3. To remove the DIMM, press the clips with both hands.

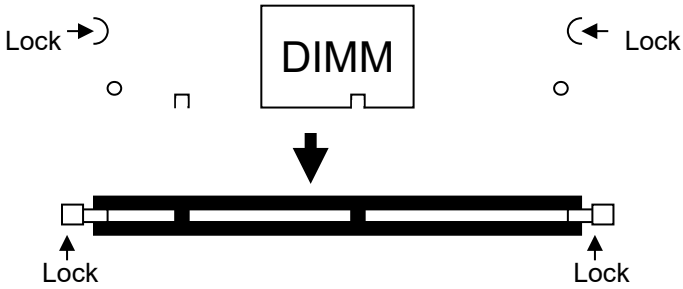

Top View of DIMM Socket

Memory Configuration for the Three 168-pin DIMM Memory Slots

(DIMM1)	(DIMM2)	(DIMM3)	Total Memory
32MB	-----	-----	32MB
64MB	-----	-----	64MB
128MB	-----	-----	128MB
32MB	32MB	-----	64MB
64MB	32MB	-----	96MB
128MB	32MB	-----	160MB
32MB	32MB	32MB	96MB
64MB	32MB	32MB	128MB
128MB	32MB	32MB	192MB
64MB	64MB	-----	128MB
128MB	64MB	-----	192MB
64MB	64MB	32MB	160MB
128MB	64MB	32MB	224MB
64MB	64MB	64MB	192MB
128MB	64MB	64MB	256MB
128MB	128MB	128MB	384MB

3.4 BIOS

The BIOS on the MI5VMT motherboard provides the standard BIOS functions plus the following additional features:

1. ISA Plug and Play (PnP) Extension

Unlike PCI cards that are Plug and Play, ISA cards require setting jumpers to resolve hardware conflicts. To make a computer system PnP, an ISA PnP standard is established and supported by new operating systems, such as Windows 95. Under Windows 95, the motherboard BIOS must have an ISA PnP extension to support new ISA PnP cards.

2. Power Management

The power management feature provides power savings by slowing down the CPU clock, turning off the monitor screen and stopping the HDD spindle motor. The BIOS fully conforms to ACPI (Advanced Configuration and Power Interface) specification.

3.5 Onboard VGA

The Apollo MVP4 Graphics Controller is a highly integrated display control device that incorporates a 64-bit 3D/2D graphic engine and video accelerator with advanced DVD video capability. It provides a flexible and high performance solution for graphics and video playback acceleration for various color depth and resolution modes. It supports a full AGP implementation that include direct access of the system memory by the 3D engine to provide increased texture memory.

3.6 Hardware Monitoring

The VIA VT82C686A chip has a built-in hardware status monitoring function that monitor several hardware parameters including power supply voltages, fan speeds, and temperatures, which are very important for a high-end computer system to work stable and properly. This function is used together with System Monitor utility or the optional Intel LANdesk Client Manager utility.

3.7 Onboard Multi-I/O

The multi-I/O function is built in the VIA VT82C686A chip supports a keyboard controller, two serial ports, one parallel port, one floppy controller and one IrDA port. The serial ports are 16550 UART compatible. The parallel port features high-speed EPP/ECP mode. The floppy controller supports up to 2.88MB format.

3.8 Interrupt Request (IRQ) Lines

There is a total of 15 IRQ lines available on the motherboard. Peripheral devices use an interrupt request to notify the CPU for the service required. The following table shows the IRQ lines used by the devices on the motherboard:

<u>Level</u>	<u>Function</u>
IRQ0	System Timer Output
IRQ1	Keyboard
IRQ2	Interrupt Cascade
IRQ8	Real Time Clock
IRQ9	Software Redirected to Int 0Ah
IRQ10	Reserved
IRQ11	Reserved
IRQ12	Reserved
IRQ13	Co-Processor
IRQ14	Primary IDE
IRQ15	Secondary IDE
IRQ3	Interrupt
IRQ4	Serial Port #1
IRQ5	Interrupt
IRQ6	Floppy Disk Controller
IRQ7	Parallel Port #1

3.9 Onboard PCI-IDE

The VIA VT82C686A chip built-in's PCI-IDE controller supports PIO mode 3/4 and bus mastering Ultra DMA 33/66. The peak transfer rate of PIO mode 3/4 can be as high as 17MB/sec. Using HDDs that support Ultra DMA66, the peak transfer rate can reach 66MB/sec. There are two IDE connectors - primary IDE and secondary IDE. With two devices per connector, up to four IDE devices can be supported.

3.10 DMA Channels

There are seven DMA channels available on the motherboard; only DMA2 is used by the floppy controller. In the case that ECP mode on the parallel port is utilized, DMA1 or DMA3 will be used.

3.11 I/O Port Address Map

Each peripheral device in the system is assigned a set of I/O port addresses which also becomes the identity of the device. There is a total of 1K port address space available. The following table lists the I/O port addresses used on the motherboard.

Address	Device Description
000h - 01Fh	DMA Controller #1
020h - 03Fh	Interrupt Controller #1
040h - 05Fh	Timer
060h - 06Fh	Keyboard Controller
070h - 07Fh	Real Time Clock,, NMI
080h - 09Fh	DMA Page Register
0A0h - 0BFh	Interrupt Controller #2
0C0h - 0DFh	DMA Controller #2
0F0h	Clear Math Coprocessor Busy Signal
0F1h	Reset Math Coprocessor
1F0h - 1F7h	IDE Interface
2F8h - 2FFh	Serial Port #2(COM2)
378h - 3FFh	Parallel Port #1(LPT1)
3F0h - 3F7h	Floppy Disk Controller
3F8h - 3FFh	Serial Port #1(COM1)

3.12 Onboard Audio

The onboard audio is built in the VIA VT82C686A chip. It is fully compatible with Sound Blaster Pro standards.

3.13 AMR Slot

The onboard AMR slot supports an optional modem riser card.



This page was intentionally left blank.

Chapter 4 Configuring the Motherboard

The following sections describe the necessary procedures and proper jumper settings to configure the MI5VMT motherboard. For the locations of the jumpers, refer to Figure 2.

4.1 SW1(4-8): CPU Voltage Setting.....	15
4.2 SW2(1-4): CPU Bus Speed/FSB Selector.....	16
SW1(1-3): CPU Bus Speed Multiplier.....	16
4.3 JP2: Clear CMOS Select.....	20

The following examples show the conventions used in this chapter.

	Jumper Open
	Jumper Closed/Short

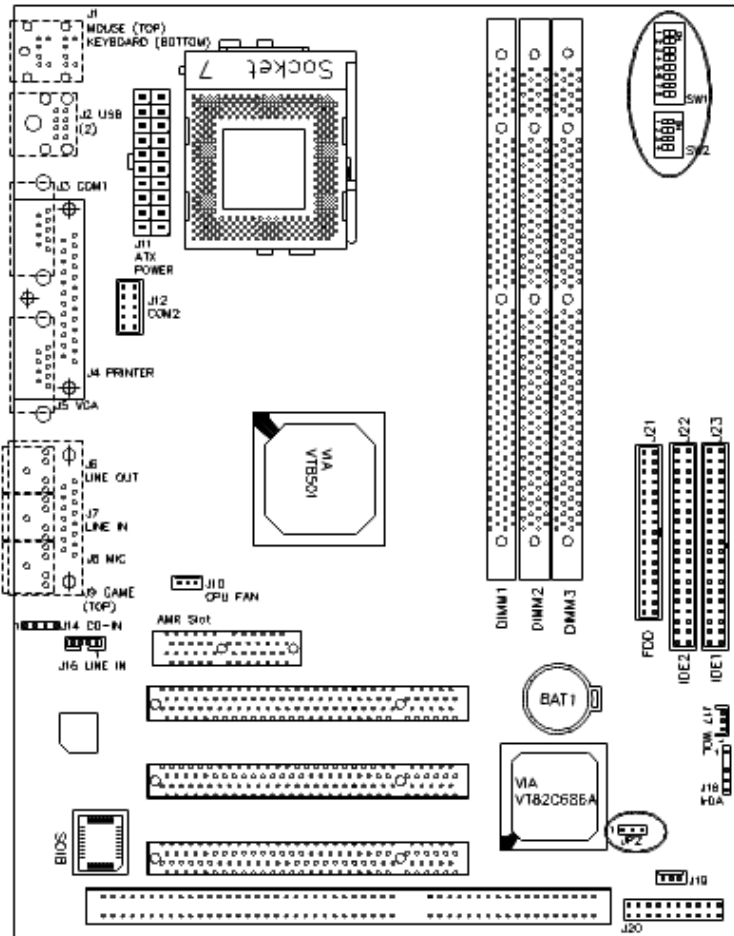

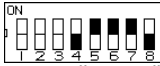
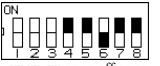

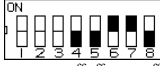

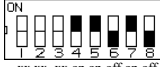



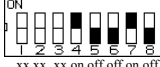
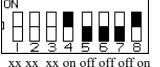





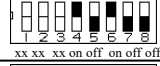

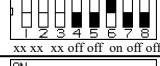
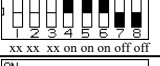
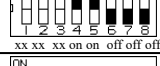
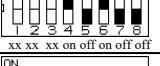
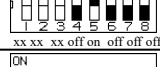
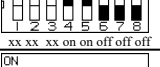
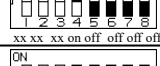
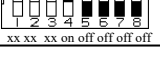
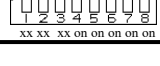

Figure 2: Jumper Location on the MI5VMT





4.1 SW1(4-8): CPU Voltage Setting

SW1	V _{CORE}	SW1	V _{CORE}
 xx xx xx on on on on off	3.5V	 xx xx xx on off on on on	2.0V
 xx xx xx off on on on off	3.4V	 xx xx xx on on on on on on	1.95V
 xx xx xx on off on on on off	3.3V	 xx xx xx on off off on on on	1.9V
 xx xx xx off off on on on off	3.2V*	 xx xx xx on on on on on on	1.85V
 xx xx xx on on on on on off	3.1V	 xx xx xx on on on on on on	1.8V
 xx xx xx on on on on on off	3.0V	 xx xx xx on on on on on on	1.75V
 xx xx xx on off on on on off	2.9V	 xx xx xx on on on on on on	1.7V
 xx xx xx off off on on on off	2.8V*	 xx xx xx on on on on on on	1.65V
 xx xx xx on on on on on off	2.7V	 xx xx xx on on on on on on	1.6V
 xx xx xx on on on on on off	2.6V	 xx xx xx on on on on on on	1.55V
 xx xx xx on off on on on off	2.5V	 xx xx xx on on on on on on	1.5V
 xx xx xx off off on on on off	2.4V*	 xx xx xx on on on on on on	1.45V
 xx xx xx on on on on on off	2.3V	 xx xx xx on on on on on on	1.40V
 xx xx xx on off on on on off	2.2V*	 xx xx xx on on on on on on	1.35V
 xx xx xx on on on on on off	2.1V	 xx xx xx on on on on on on	1.30V
 xx xx xx on on on on on on	2.05V		

* The CPUs supported by these voltages are shown in the table below.

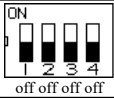
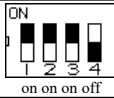
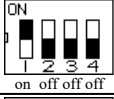
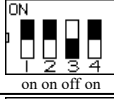
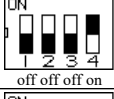
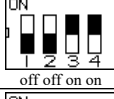
Voltage	CPU
2.2V	K6 266/300, K6-2 266/300/333/350/366/380/400
2.4V	K6-2 450/475/500, K6-3 400/450/500/550
2.8V	IDT Winchip3, Pentium w/ MMX
3.2V	K6 233

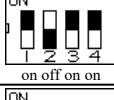
4.2 SW2(1-4): CPU Bus Speed/FSB Selector
 SW1(1-3): CPU Bus Speed Multiplier

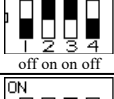
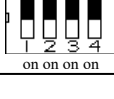
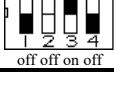









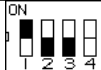

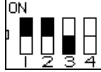

SW2(1-4)	Bus Speed	SW2(1-4)	Bus Speed
 off off off off	60MHz	 on on on off	100MHz
 on off off off	66MHz	 on on on off	105MHz
 off off off on	75MHz	 off off on on	110MHz
 on off on off	83MHz	 on on on on	115Hz
 on on off off	90MHz	 off on on on	120MHz
 off on on on	95MHz	 on on on on	124MHz
 off off on off	97MHz		

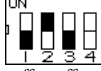
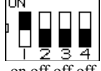
SW1(1-3)	Multiplier	SW1(1-3)	Multiplier
<p>off off off xx xx xx xx xx</p>	1.5x/3.5x	<p>on off on xx xx xx xx xx</p>	4x
<p>on off off xx xx xx xx xx</p>	2x	<p>on on on xx xx xx xx xx</p>	4.5x
<p>on on off xx xx xx xx xx</p>	2.5x	<p>off on on xx xx xx xx xx</p>	5x
<p>off off off xx xx xx xx xx</p>	3x	<p>off off on xx xx xx xx xx</p>	5.5x

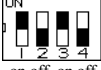
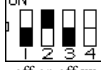
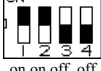
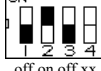
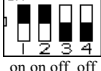



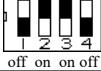





















For Intel / IDT CPUs

SW2(1-4)	SW1(1-3)	CPU
<p>on off off off</p>	<p>off on off xx</p>	Pentium with MMX 200MHz Winchip2-3D/C6-200 (66MHz x 3)
<p>on off off off</p>	<p>off off off xx</p>	Pentium with MMX 233MHz (66MHz x 3.5)
<p>off off off on</p>	<p>off on off xx</p>	Winchip2-3D/C6-225 (75MHz x 3X)
<p>on off off off</p>	<p>on off on xx</p>	Winchip-3D/C6-233 (66MHz x 3.5)
<p>on on on off</p>	<p>off on on xx</p>	Winchip-3D/C6-266 (100MHz x 2.33)
<p>on on on off</p>	<p>on on off xx</p>	Winchip2-3D/C6-300 (100MHz x 2.5)

For Cyrix MII CPUs



SW2(1-4)	SW1(1-3)	CPU
 <p>on on on off</p>	 <p>on off off xx</p>	Cyrix MII-266 (100MHz x 2)
 <p>on off on off</p>	 <p>on on off xx</p>	Cyrix MII-300 (83MHz x 2.5)
 <p>on on off off</p>	 <p>on on off xx</p>	Cyrix MII-300 (90MHz x 2.5)
 <p>off off off on</p>	 <p>off on off xx</p>	Cyrix MII-300 (75MHz x 3)
 <p>on off off off</p>	 <p>off off off xx</p>	Cyrix MII-300 (66MHz x 3.5)
 <p>on off on off</p>	 <p>off on off xx</p>	Cyrix MII-333 (83MHz x 3)
 <p>on on off off</p>	 <p>off on off xx</p>	Cyrix MII-350 (90MHz x 3)
 <p>on on off off</p>	 <p>off off off xx</p>	Cyrix MII-366 (90MHz x 3.5)
 <p>on on on off</p>	 <p>off on off xx</p>	Cyrix MII-380 (100MHz x 3)
 <p>off on on off</p>	 <p>off off off xx</p>	Cyrix MII-400 (95MHz x 3.5)

For AMD K6, K6-2, K6-3 CPUs

SW2(1-4)	SW1(1-3)	CPU
 on off off off	 off off off xx	K6-233 (66MHz x 3.5)
 on off off off	 on on on xx	K6-266 (66MHz x 4)
 on off off off	 on on on xx	K6-300 / K6-2/300 (66MHz x 4.5)
 on off off off	 off on on xx	K6-2-333 (66MHz x 5)
 on off off off	 off off on xx	K6-2/366 (66MHz x 5.5)
 on on on off	 off on on xx	K6-2/380 (95MHz x 4)
 on on on off	 off on on xx	K6-2/475 / K6/3-475 (95MHz x 5)
 on on on off	 off on off xx	K6-2/300 (100MHz x 3)
 on on on off	 off off off xx	K6-2/350 (100MHz x 3.5)
 on on on off	 on off on xx	K6-2/400 / K6-2+/400 / K6-3-400 (100MHz x 4)
 on on on off	 on on on xx	K6-2/450 / K6/3-450 (100MHz x 4.5)
 on on on off	 on on on xx	K6-2/500 / K6-3/500 (100MHz x 5)
 on on on off	 on on on xx	K6-2/550 / K6-3/550 (100MHz x 5.5)

4.3 JP2: Clear CMOS Select

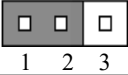
Use JP2, a 3-pin header, to clear the contents of the CMOS RAM. Do not clear the CMOS RAM unless it is absolutely necessary. You will lose your password, etc. *To clear CMOS, the ATX-power connector should be disconnected from the motherboard.*

JP2	Jumper Setting	Function
 1 2 3	pin 1-2: short	Normal
 1 2 3	pin 2-3: short	Clear CMOS

Chapter 5 Installation

This chapter describes the interface that the MI5VMT provides for creating a working system. Refer to Figure 3 for the location of the connectors.

The following items are covered in this chapter:

5.1 I/O Connectors.....	23
5.2 J1: PS/2 Keyboard and PS/2 Mouse Connectors.....	23
5.3 J2: USB Connector.....	24
5.4 J3, J12: Serial Ports.....	24
5.5 J4: Parallel Port Connector.....	25
5.6 J5: VGA Port Connector.....	25
5.7 J6, J7, J8, J9: Line Out, Line In, Mic In, Game Port.....	26
5.8 J10: CPU Fan Power Connector.....	26
5.9 J11: ATX Power Supply Connector.....	26
5.10 J14, J16: CD-ROM Audio In Connectors.....	27
5.11 J17: Wake on LAN Connector.....	27
5.12 J18: IrDA Connector.....	28
5.13 J19: Chassis Fan Power Connector.....	28
5.14 J20: Front Bezel Connectors.....	29
5.15 J21: Floppy Drive Connector.....	31
5.16 J23, J22: EIDE Connectors.....	32

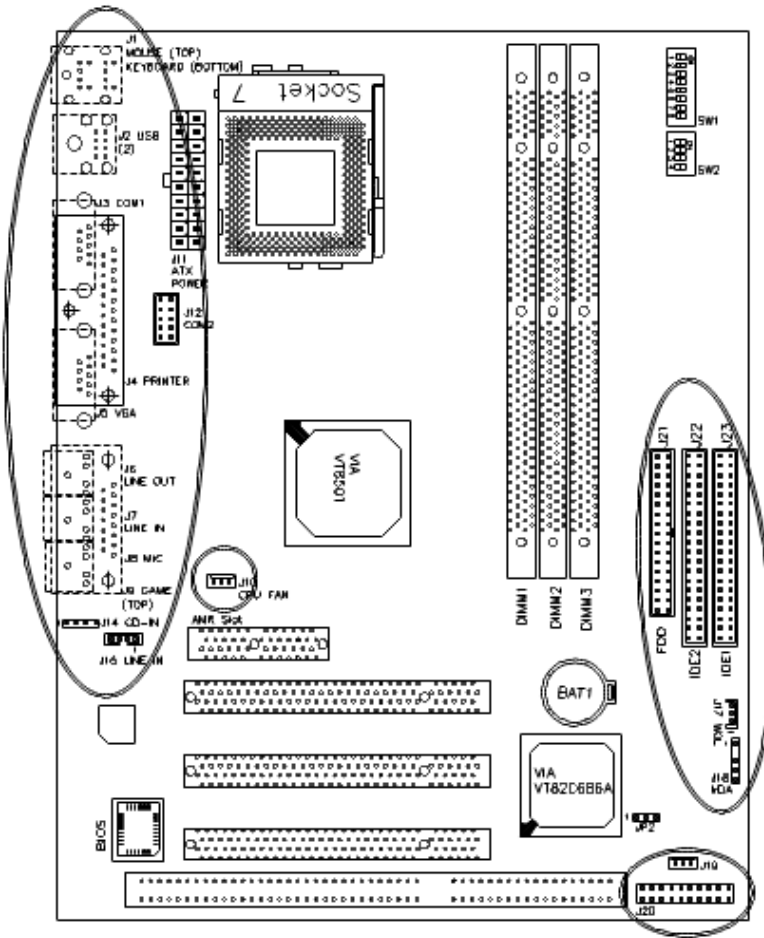

Figure 3: Connector Location on the MI5VMT

5.1 I/O Connectors

The I/O connectors connect the MI5VMT to the most common peripherals. To attach cables to these connectors, carefully align Pin 1 of the cables to that of the connectors. Refer to Figure 4 for the location and orientation of the connectors.

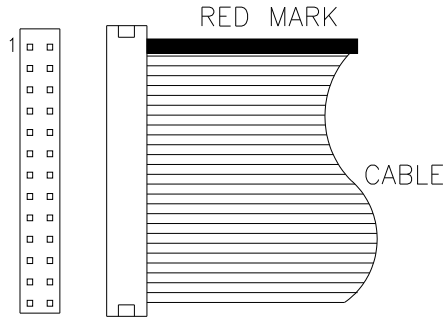
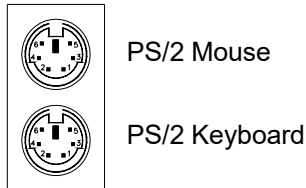

Figure 4: Orientation of the I/O Connector

5.2 J1: PS/2 Keyboard and PS/2 Mouse Connectors



Below are the pin-out assignments of the connectors.

Signal Name	Keyboard	Mouse	Signal Name
Keyboard data	1	1	Mouse data
N.C.	2	2	N.C.
GND	3	3	GND
5V	4	4	5V
Keyboard clock	5	5	Mouse clock
N.C.	6	6	N.C.

5.3 J2: USB Connector

J2 is the standard USB external connector consisting of two ports. USB support allows connections of up to 64 plug and play external peripherals per channel. The following table shows the pin outs of these ports.

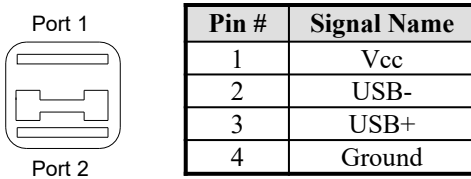

5.4 J3, J12: Serial Ports

The onboard serial ports are J3, a DB-9 connector which is COM1 and J12, a 10-pin header connector which is COM2. The following table shows the pin-out assignments of these connectors.

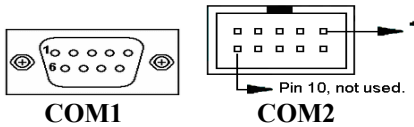

Signal Name	Pin #	Pin #	Signal Name
DCD, Data carrier detect	1	6	DSR, Data set ready
RXD, Receive data	2	7	RTS, Request to send
TXD, Transmit data	3	8	CTS, Clear to send
DTR, Data terminal ready	4	9	RI, Ring indicator
GND, ground	5	10	Not Used

5.5 J4: Parallel Port Connector

J4 is a DB-25 external connector as seen in the previous figure. The following table describes the pin-out assignments of this connector.

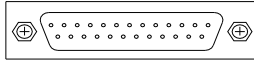

Signal Name	Pin #	Pin #	Signal Name
Line printer strobe	1	14	AutoFeed
PD0, parallel data 0	2	15	Error
PD1, parallel data 1	3	16	Initialize
PD2, parallel data 2	4	17	Select
PD3, parallel data 3	5	18	Ground
PD4, parallel data 4	6	19	Ground
PD5, parallel data 5	7	20	Ground
PD6, parallel data 6	8	21	Ground
PD7, parallel data 7	9	22	Ground
ACK, acknowledge	10	23	Ground
Busy	11	24	Ground
Paper empty	12	25	Ground
Select	13	N/A	N/A

5.6 J5: VGA Port Connector

J5 is a DB-15 VGA connector. The following table shows the pin-out assignments of this connector.

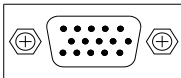

Signal Name	Pin #	Pin #	Signal Name
Red	1	2	Green
Blue	3	4	N.C.
GND	5	6	GND
GND	7	8	GND
N.C.	9	10	GND
N.C.	11	12	N.C.
HSYNC	13	14	VSYNC
NC	15		

5.7 J6, J7, J8, J9: Line Out, Line In, Mic In, Game Port

J6, J7, J8 and J9 are the connectors for audio line out, audio line in, microphone and game port respectively.

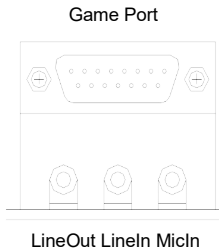

5.8 J10: CPU Fan Power Connector

J10 CPU fan power connector is a 3-pin header supporting a 12V fan.

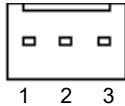

Pin #	Signal Name
1	Rotation
2	+12V
3	Ground

5.9 J11: ATX Power Supply Connector

J11 is a 20-pin ATX power supply connector. Refer to the following table for the pin out assignments.

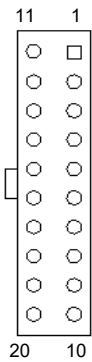

Signal Name	Pin #	Pin #	Signal Name
3.3V	11	1	3.3V
-12V	12	2	3.3V
Ground	13	3	Ground
PS-ON	14	4	+5V
Ground	15	5	Ground
Ground	16	6	+5V
Ground	17	7	Ground
-5V	18	8	Power good
+5V	19	9	5VSB
+5V	20	10	+12V

5.10 J14, J16: CD-ROM Audio In Connectors

J14 and J16 are the onboard CD-ROM audio in connectors. Below are their pin assignments.

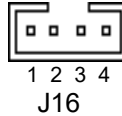
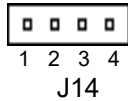

Signal Name	Pin #	Pin #	Signal Name
Left	1	1	Ground
Ground	2	2	Left
Ground	3	3	Ground
Right	4	4	Right

5.11 J17: Wake on LAN Connector

J17 is a 3-pin header for the Wake on LAN function on the motherboard. The following table shows the pin out assignments of this connector. Wake on LAN will function properly only with an ATX power supply with 5VSB that has 200mA.

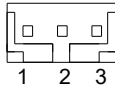

Pin #	Signal Name
1	+5VSB
2	Ground
3	Wake on LAN

5.12 J18: IrDA Connector

This connector is used for an IrDA connector that supports infrared wireless communication.

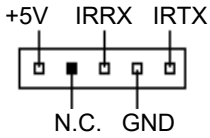

Pin #	Signal Name
1	+5V
2	No connect
3	Ir RX
4	Ground
5	Ir TX

5.13 J19: Chassis Fan Power Connector

J19 Chassis fan power connector is a 3-pin header supporting a 12V fan.

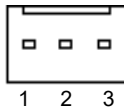

Pin #	Signal Name
1	Rotation
2	+12V
3	Ground

5.14 J20: Front Bezel Connectors

The front bezel of the case has a control panel which provides light indication of the computer activities and switches to change the computer status. J20 is a 20-pin header that provides interfaces for the following functions.

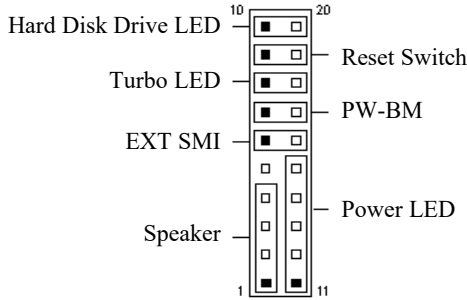

Speaker: Pins 1 - 4

This connector provides an interface to a speaker for audio tone generation. An 8-ohm speaker is recommended.

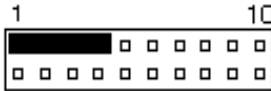

Pin #	Signal Name
1	Speaker out
2	No connect
3	Ground
4	+5V

Power LED: Pins 11 - 15

The power LED indicates the status of the main power switch.



Pin #	Signal Name
11	Power LED
12	No connect
13	Ground
14	No connect
15	Ground

EXT SMI: Pins 6 and 16

This 2-pin connector is for the “Green Switch” on the control panel, which, when pressed, will force the system immediately into the power saving (sleep) mode.

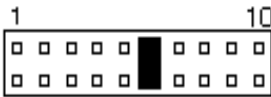

Pin #	Signal Name
7	Sleep
17	Ground

PW-BM: Pins 7 and 17

This 2-pin connector is an “ATX Power Supply On/Off Switch” on the motherboard that connects to the power switch on the case. When pressed, the power switch will force the motherboard to power on. When pressed again, it will force the motherboard to power off.

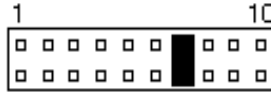

Reset Switch: Pins 9 and 19

The reset switch allows the user to reset the system without turning the main power switch off and then on again. Orientation is not required when making a connection to this header.

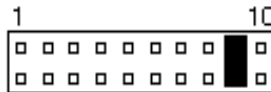

Hard Disk Drive LED Connector: Pins 10 and 20

This connector connects to the hard drive activity LED on control panel. This LED will flash when the HDD is being accessed.

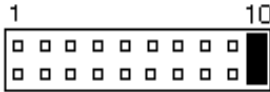

Pin #	Signal Name
10	HDD LED
20	5V

5.15 J21: Floppy Drive Connector

J21 of the MI5VMT is a 34-pin header and will support up to 2.88MB floppy drives. The following table shows its pin-out assignments.

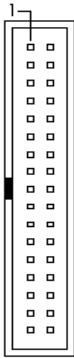

Signal Name	Pin #	Pin #	Signal Name
Ground	1	2	RM/LC
Ground	3	4	No connect
Ground	5	6	No connect
Ground	7	8	Index
Ground	9	10	Motor enable 0
Ground	11	12	Drive select 1
Ground	13	14	Drive select 0
Ground	15	16	Motor enable 1
Ground	17	18	Direction
Ground	19	20	Step
Ground	21	22	Write data
Ground	23	24	Write gate
Ground	25	26	Track 00
Ground	27	28	Write protect
Ground	29	30	Read data
Ground	31	32	Side 1 select
Ground	33	34	Diskette change

5.16 J23, J22: EIDE Connectors

J23: Primary IDE Connector

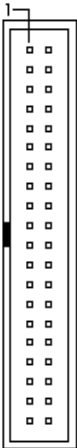

Signal Name	Pin #	Pin #	Signal Name
Reset IDE	1	2	Ground
Host data 7	3	4	Host data 8
Host data 6	5	6	Host data 9
Host data 5	7	8	Host data 10
Host data 4	9	10	Host data 11
Host data 3	11	12	Host data 12
Host data 2	13	14	Host data 13
Host data 1	15	16	Host data 14
Host data 0	17	18	Host data 15
Ground	19	20	Key
DRQ0	21	22	Ground
Host IOW	23	24	Ground
Host IOR	25	26	Ground
IOCHRDY	27	28	Host ALE
DACK0	29	30	Ground
IRQ14	31	32	No connect
Address 1	33	34	UDMA66 Enable
Address 0	35	36	Address 2
Chip select 0	37	38	Chip select 1
Activity	39	40	Ground

J22: Secondary IDE Connector

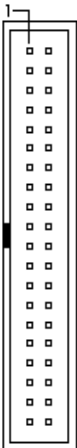

Signal Name	Pin #	Pin #	Signal Name
Reset IDE	1	2	Ground
Host data 7	3	4	Host data 8
Host data 6	5	6	Host data 9
Host data 5	7	8	Host data 10
Host data 4	9	10	Host data 11
Host data 3	11	12	Host data 12
Host data 2	13	14	Host data 13
Host data 1	15	16	Host data 14
Host data 0	17	18	Host data 15
Ground	19	20	Key
DRQ0	21	22	Ground
Host IOW	23	24	Ground
Host IOR	25	26	Ground
IOCHRDY	27	28	Host ALE
DACK1	29	30	Ground
MIRQ0	31	32	No connect
Address 1	33	34	UDMA66 Enable
Address 0	35	36	Address 2
Chip select 0	37	38	Chip select 1
Activity	39	40	Ground

Chapter 6 BIOS Configuration

This chapter describes the different settings available in the Award BIOS. The topics covered in this chapter are as follows:

6.1	BIOS Introduction.....	36
6.2	BIOS Setup.....	36
6.3	Standard CMOS Setup.....	38
	Date.....	38
	Time.....	39
	Primary HDDs / Secondary HDDs.....	39
	Drive A / Drive B.....	40
	Video.....	40
	Halt On.....	40
6.4	BIOS Features Setup.....	41
	Virus Warning.....	41
	CPU Internal Cache / External Cache.....	41
	Quick Power On Self Test.....	42
	Boot Sequence.....	42
	Swap Floppy Drive.....	42
	Boot Up Floppy Seek.....	42
	Boot Up NumLock Status.....	42
	Boot Up System Speed.....	42
	Gate A20 Option.....	42
	Memory Parity/ECC Check.....	42
	Typematic Rate Setting.....	42
	Typematic Rate (Chars/Sec).....	44
	Typematic Delay (Msec).....	44
	Security Option.....	44
	PCI/VGA Palette Snoop.....	44
	OS Select for DRAM > 64MB.....	44
	Video BIOS Shadow.....	44
	C8000 - CBFFF Shadow/DC000 - DFFFF Shadow.....	44
	Cyrix 6x86/MII CPUID.....	44
6.5	Chipset Features Setup.....	45
	DRAM Timing.....	45
	SDRAM Cycle Length.....	45
	DRAM Read Pipeline.....	45
	Sustained 3T Write.....	45
	Cache R/CPU W Pipeline.....	45

Cache Timing.....	46
Video BIOS Cacheable.....	46
System BIOS Cacheable.....	46
Memory Hole.....	46
Init AGP Display First.....	46
Frame Buffer Size.....	46
AGP Aperture Size.....	46
Auto Detect DIMM/PCI Clk.....	46
Spread Spectrum.....	47
OnChip USB.....	47
USB Keyboard Support.....	47
OnChip Sound.....	47
OnChip Modem.....	46
6.6 Power Management Setup.....	48
ACPI Function.....	48
Power Management.....	48
PM Control by APM.....	49
Video Off Method.....	49
Doze Mode.....	49
Suspend Mode.....	49
HDD Power Down.....	49
Soft-Off by PWRBTN.....	49
PWRON After PW-Fail.....	51
PM Events.....	51
PWR-ON By Modem/LAN.....	51
6.7 PNP/PCI Configuration.....	52
PNP OS Installed.....	52
Resources Controlled by.....	52
Reset Configuration Data.....	52
IRQ3/4/5/7/9/10/11/12/14/15, DMA0/1/3/5/6/7 assigned to. .	52
CPU to PCI Write Buffer.....	53
PCI Dynamic Bursting.....	53
PCI Master 0 WS Write.....	53
PCI Delay Transaction.....	53
PCI#2 Access #1 Retry.....	53
AGP Master 1 WS Write.....	53
AGP Master 1 WS Read.....	53
Assign IRQ for USB/VGA.....	53
6.8 Load BIOS Defaults.....	54
6.9 Load Setup Defaults.....	54

6.10 CPU Features Setup.....	55
Current CPU / System Temp.....	55
Current CPU Fan Speed / Chassis Fan Speed.....	55
VCORE / VCC3 / +12V / VCC2 / +5V.....	55
6.10 Integrated Peripherals.....	56
OnChip IDE Channel0/1.....	56
IDE Prefetch Mode.....	56
IDE HDD Block Mode.....	56
Primary/Secondary Master/Slave PIO.....	56
Primary/Secondary Master/Slave UDMA.....	57
Init AGP Display First.....	57
Onboard FDD Controller.....	57
Onboard Serial/Parallel Port.....	57
UART 2 Mode.....	57
Parallel Port Mode.....	57
Onboard Legacy Audio.....	57
6.11 Supervisor / User Password.....	58
6.12 IDE HDD Auto Detection.....	59
6.13 Save & Exit Setup.....	60
6.14 Exit Without Saving.....	60

6.1 BIOS Introduction

The Award BIOS (Basic Input/Output System) installed in your computer system's ROM supports Intel Celeron processors. The BIOS provides critical low-level support for a standard device such as disk drives, serial and parallel ports. It also adds virus and password protection as well as special support for detailed fine-tuning of the chipset controlling the entire system.

6.2 BIOS Setup

The Award BIOS provides a Setup utility program for specifying the system configurations and settings. The BIOS ROM of the system stores the Setup utility. When you turn on the computer, the Award BIOS is immediately activated. Pressing the key immediately allows you to enter the Setup utility. If you are a little bit late pressing the key, POST(Power On Self Test) will continue with its test routines, thus preventing you from invoking the Setup. If you still wish to enter Setup, restart the system by pressing the "Reset" button or simultaneously pressing the <Ctrl>, <Alt> and <Delete> keys. You can also restart by turning the system Off and back On again. The following message will appear on the screen:

Press to Enter Setup

In general, you press the arrow keys to highlight items, <Enter> to select, the <PgUp> and <PgDn> keys to change entries, <F1> for help and <Esc> to quit.

When you enter the Setup utility, the Main Menu screen will appear on the screen. The Main Menu allows you to select from various setup functions and exit choices.

ROM PCI/ISA BIOS
 CMOS SETUP UTILITY
 AWARD SOFTWARE, INC.

STANDARD CMOS SETUP	CPU FEATURES SETUP
BIOS FEATURES SETUP	INTEGRATED PERIPHERALS
CHIPSET FEATURES SETUP	SUPERVISOR PASSWORD
POWER MANAGEMENT SETUP	USER PASSWORD
PNP/PCI CONFIGURATION	IDE HDD AUTO DETECTION
LOAD BIOS DEFAULTS	SAVE & EXIT SETUP
LOAD SETUP DEFAULTS	EXIT WITHOUT SAVING
ESC : Quit	↑ ↓ → ← : Select Item
F10 : Save & Exit Setup	(Shift) F2 : Change Color
Time, Date, Hard Disk Type	

The section below the setup items of the Main Menu displays the control keys for this menu. At the bottom of the Main Menu just below the control keys section, there is another section which displays information on the currently highlighted item in the list.

NOTE: *If your computer cannot boot after making and saving system changes with Setup, the Award BIOS supports an override to the CMOS settings that resets your system to its default.*

We strongly recommend that you avoid making any changes to the chipset defaults. These defaults have been carefully chosen by both Award and your system manufacturer to provide the absolute maximum performance and reliability.

6.3 Standard CMOS Setup

“Standard CMOS Setup” choice allows you to record some basic hardware configurations in your computer system and set the system clock and error handling. If the motherboard is already installed in a working system, you will not need to select this option. You will need to run the Standard CMOS option, however, if you change your system hardware configurations, the onboard battery fails, or the configuration stored in the CMOS memory was lost or damaged.

ROM PCI/ISA BIOS
STANDARD CMOS SETUP
AWARD SOFTWARE, INC.

Date (mm:dd:yy) : Wed, Mar 4 1998								
Time (hh:mm:ss) : 00 : 00 : 00								
HARD DISKS	TYPE	SIZE	CYLS	HEAD	PRECOMP	LANDZ	SECTOR	MODE
Primary Master	Auto	0	0	0	0	0	0	Auto
Primary Slave	Auto	0	0	0	0	0	0	Auto
Secondary Master	Auto	0	0	0	0	0	0	Auto
Secondary Slave	Auto	0	0	0	0	0	0	Auto
Drive A	: 1.44M, 3.5in				Base Memory		: 640K	
Drive B	: None				Extended Memory		: 15360K	
Video	: EGA / VGA				Other Memory		: 384K	
Halt On	: All Errors				Total Memory		: 16384K	
ESC : Quit			↑ ↓ → ← : Select Item			PU / PD / + / - : Modify		
F1 : Help			(Shift) F2 : Change Color					

At the bottom of the menu are the control keys for use on this menu. If you need any help in each item field, you can press the <F1> key. It will display the relevant information to help you. The memory display at the lower right-hand side of the menu is read-only. It will adjust automatically according to the memory changed. The following describes each item of this menu.

Date

The date format is:

Day : Sun to Sat
Month : 1 to 12
Date : 1 to 31
Year : 1994 to 2079

To set the date, highlight the “Date” field and use the PageUp/ PageDown or +/- keys to set the current time.

Time

The time format is: **Hour : 00 to 23**
Minute : 00 to 59
Second : 00 to 59

To set the time, highlight the “Time” field and use the <PgUp>/<PgDn> or +/- keys to set the current time.

Primary HDDs / Secondary HDDs

The onboard PCI IDE connectors provide Primary and Secondary channels for connecting up to four IDE hard disks or other IDE devices. Each channel can support up to two hard disks; the first is the “Master” and the second is the “Slave”.

To enter the specifications for a hard disk drive, you must select first a “Type”. There are 45 predefined types and 4 user definable types are for Enhanced IDE BIOS. Type 1 to 45 are predefined. Type “User” is user-definable. For the Primary Master/Slave as well as Secondary Master/Slave, you can select “Auto” under the TYPE and MODE fields. This will enable auto detection of your IDE drives and CD-ROM drive during POST.

Press <PgUp>/<PgDn> to select a numbered hard disk type or type the number and press the <Enter> key. The hard disk will not work properly if you enter incorrect information for this field. If your hard disk drive type is not matched or listed, you can use Type User to define your own drive type manually. If you select Type User, related information is asked to be entered to the following items.

CYLS : Number of cylinders
HEAD : Number of read/write heads
PRECOMP : Write precompensation
LANDZ : Landing zone
SECTOR : Number of sectors
SIZE : Automatically adjust according to the configuration
MODE (for IDE HDD only) : Auto
 Normal (HD < 528MB)
 Large (for MS-DOS only)
 LBA (HD > 528MB and
 supports Logical Block
 Addressing)

NOTE: *The specifications of your drive must match with the drive table. The hard disk will not work properly if you enter incorrect information in these fields. If your hard disk drive type is not matched or listed, you can use Type User to define your own drive type manually.*

Drive A / Drive B

These fields identify the types of floppy disk drive A or drive B that has been installed in the computer. The available specifications are:

360KB	1.	2MB	720KB	1.	44M	2.	88M
5.25 in.		5.25 in.	3.5 in.		B		B
					3.5 in.		3.5 in.

Video

This field selects the type of video display card installed in your system. You can choose the following video display cards:

EGA/VGA	For EGA, VGA, SEGA, SVGA or PGA monitor adapters. (default)
CGA 40	Power up in 40 column mode.
CGA 80	Power up in 80 column mode.
MONO	For Hercules or MDA adapters.

Halt On

This field determines whether or not the system will halt if an error is detected during power up.

No errors	The system boot will not be halted for any error that may be detected.
All errors	Whenever the BIOS detects a non-fatal error, the system will stop and you will be prompted.
All, But Keyboard	The system boot will not be halted for a keyboard error; it will stop for all other errors
All, But Diskette	The system boot will not be halted for a disk error; it will stop for all other errors.
All, But Disk/Key	The system boot will not be halted for a keyboard or disk error; it will stop for all others.

6.4 BIOS Features Setup

This section allows you to configure and improve your system and allows you to set up some system features according to your preference.

ROM / PCI ISA BIOS
BIOS FEATURES SETUP
AWARD SOFTWARE, INC.

Virus Warning	: Disabled	Video BIOS Shadow	: Enabled
CPU Internal Cache	: Enabled	C8000-CBFFF Shadow	: Disabled
External Cache	: Enabled	CC000-CFFFF Shadow	: Disabled
Quick Power On Self Test	: Enabled	D0000-D3FFF Shadow	: Disabled
Boot Sequence	: A, C, SCSI	D4000-D7FFF Shadow	: Disabled
Swap Floppy Drive	: Disabled	D8000-DBFFF Shadow	: Disabled
Boot Up Floppy Seek	: Enabled	DC000-DFFF Shadow	: Disabled
Boot Up Numlock Status	: On	Cyrix 6x86/MII CPUID	: Enabled
Gate A20 Option	: Fast		
Memory Parity/ECC Check	: Disabled		
Typematic Rate Setting	: Disabled		
Typematic Rate (chars/Sec)	: 6		
Typematic Delay (Msec)	: 250		
Security Option	: Setup		
PCI /VGA Palette Snoop	: Disabled	ESC : Quit	↑ ↓ → ← : Select Item
OS Select For DRAM>64MB	: Non-OS2	F1 : Help	PU/PD/+/- : Modify
		F5 : Old Values	(Shift) F2 : Color
		F6 : Load BIOS Defaults	
		F7 : Load Setup Defaults	

Virus Warning

This item protects the boot sector and partition table of your hard disk against accidental modifications. If an attempt is made, the BIOS will halt the system and display a warning message. If this occurs, you can either allow the operation to continue or run an anti-virus program to locate and remove the problem.

NOTE: Many disk diagnostic programs, which attempt to access the boot sector table, can cause the virus warning. If you will run such a program, disable the Virus Warning feature.

CPU Internal Cache / External Cache

Cache memory is additional memory that is much faster than conventional DRAM (system memory). CPUs from 486-type on up contain internal cache memory, and most, but not all, modern PCs have additional (external) cache memory. When the CPU requests data, the system transfers the requested data from the main DRAM into cache memory, for even faster access by the CPU. These items allow you to enable (speed up memory access) or disable the cache function. By default, these items are **Enabled**.

Quick Power On Self Test

When enabled, this field speeds up the Power On Self Test (POST). If it is set to *Enabled*, BIOS will skip some items.

Boot Sequence

This field determines the drive that the system searches first for an operating system. The default value is **A, C, SCSI**. The options are :

A, C, SCSI	D, A, SCSI	SCSI, C, A
C, A, SCSI	E, A, SCSI	C only
C, CDROM, A	F, A, SCSI	LS/ZIP, C
CDROM, C, A	SCSI, A, C	

Swap Floppy Drive

This item allows you to determine whether or not to enable Swap Floppy Drive. When enabled, the BIOS swaps floppy drive assignments so that Drive A becomes Drive B, and Drive B becomes Drive A. By default, this field is set to *Disabled*.

Boot Up Floppy Seek

When enabled, the BIOS will seek whether or not the floppy drive installed has 40 or 80 tracks. 360K type has 40 tracks while 760K, 1.2M and 1.44M all have 80 tracks. By default, this field is set to *Enabled*.

Boot Up NumLock Status

This allows you to activate the NumLock function after you power up the system. By default, the system boots up with *NumLock* On.

Boot Up System Speed

This has no function and selects the default system speed (*High*).

Gate A20 Option

This field allows you to select how Gate A20 is worked. Gate A20 is a device used to address memory above 1 MB. The default setting is *Fast*.

Memory Parity/ECC Check

This field allows you to enable the parity/ECC checking function of the memory module if it is supported. By default, this field is set to *Disabled*.

Typematic Rate Setting

When disabled, continually holding down a key on your keyboard will generate only one instance. When enabled, you can set the two

typematic controls listed next. By default, this field is set to *Disabled*.

Typematic Rate (Chars/Sec)

When the typematic rate is enabled, the system registers repeated keystrokes speeds. Settings are from 6 to 30 characters per second.

Typematic Delay (Msec)

When the typematic rate is enabled, this item allows you to set the time interval for displaying the first and second characters. By default, this item is set to *250msec*.

Security Option

This field allows you to limit access to the System and Setup. The default value is *Setup*. When you select *System*, the system prompts for the User Password every time you boot up. When you select *Setup*, the system always boots up and prompts for the Supervisor Password only when the Setup utility is called up.

PCI/VGA Palette Snoop

Some non-standard VGA display cards may not show colors properly. This field allows you to set whether or not MPEG ISA/VESA VGA Cards can work with PCI/VGA. When this field is enabled, a PCI/VGA can work with an MPEG ISA/VESA VGA card. When this field is disabled, a PCI/VGA cannot work with an MPEG ISA/VESA Card.

OS Select for DRAM > 64MB

This option allows the system to access greater than 64MB of DRAM memory when used with OS/2 that depends on certain BIOS calls to access memory. The default setting is *Non-OS/2*.

Video BIOS Shadow

This item allows you to change the Video BIOS location from ROM to RAM. Video Shadow will increase the video speed.

C8000 - CBFFF Shadow/DC000 - DFFFF Shadow

Shadowing a ROM reduces the memory available between 640KB to 1024KB. These fields determine whether or not optional ROM will be copied to RAM.

Cyrix 6x86/MII CPUID

This field should be enabled when running Windows 2000 in order for the OS to recognize Cyrix 6x86/MII processors.

6.5 Chipset Features Setup

This Setup menu controls the configuration of the motherboard chipset.

ROM PCI/ISA BIOS CHIPSET FEATURES SETUP AWARD SOFTWARE INC.			
Bank 0/1 DRAM Timing	: SDRAM 8ns	OnChip USB	: Enabled
Bank 2/3 DRAM Timing	: SDRAM 8ns	USB Keyboard Support	: Disabled
Bank 4/5 DRAM Timing	: SDRAM 8ns		
SDRAM Cycle Length	: 3	OnChip Sound	: Enabled
DRAM Read Pipeline	: Enabled	OnChip Modem	: Disabled
Sustained 3T Write	: Enabled		
Cache Rd+CPU Wt Pipeline	: Enabled		
Cache Timing	: Fast		
Video BIOS Cacheable	: Enabled		
System BIOS Cacheable	: Enabled		
Memory Hole	: Disabled		
Init Display First	: AGP		
Frame Buffer Size	: 8M		
AGP Aperture Size (MB)	: 64		
Auto Detect DIMM/PCI Clk	: Disabled	ESC : Quit	↑ ↓ → ← : Select Item
Spread Spectrum	: Disabled	F1 : Help	PU/PD/+/- : Modify
		F5 : Old Values	(Shift) F2 : Color
		F6 : Load BIOS Defaults	
		F7 : Load Setup Defaults	

DRAM Timing

The DRAM timing is controlled by the DRAM Timing Registers. The timing type is dependent on the system design. Slower rates may be required in some system designs to support loose layouts or slower memory.

SDRAM Cycle Length

This field sets the SDRAM cycle length to either 2 or 3. The default setting is 3.

DRAM Read Pipeline

When enabled, this field supports pipelining of DRAM reads. The default setting is *Enabled*.

Sustained 3T Write

This field allows support for PBSRAM sustained 3T write. By default, this field is set *Enabled*.

Cache R/CPU W Pipeline

When enabled, this item allows pipelining of cache reads and CPU writes. The default setting is *Enabled*.

Cache Timing

This field sets the timing of the cache in the system. The options are *Fast* and *Fastest*. By default, this field is set to *Fast*.

Video BIOS Cacheable

When enabled, access to video BIOS addressed at C0000H to C7FFFH are cached, provided that the cache controller is enabled.

System BIOS Cacheable

When enabled, access to the system BIOS ROM addressed at F0000H-FFFFFH are cached, provided that the cache controller is enabled.

Memory Hole

In order to improve performance, certain space in memory can be reserved for ISA cards. This field allows you to reserve 15MB to 16MB memory address space to ISA expansion cards. This makes memory from 15MB and up unavailable to the system. Expansion cards can only access memory up to 16MB. By default, this field is set to *Disabled*.

Init AGP Display First

This field allows the system to initialize first the AGP VGA display on the motherboard when system is turned on.

Frame Buffer Size

The frame buffer memory size has a default setting of *4M*. The other option is *8M*.

AGP Aperture Size

The field sets aperture size of the graphics. The aperture is a portion of the PCI memory address range dedicated for graphics memory address space. Host cycles that hit the aperture range are forwarded to the AGP without any translation. The options available are *4M*, *8M*, *16M*, *32M*, *64M*, *128M* and *256M*. The default setting is *64M*.

Auto Detect DIMM/PCI Clk

When enabled, the system automatically shuts off clocks of unused DIMM/PCI slots. The default setting is *Disabled*. This field is for CE testing use only.

Spread Spectrum

This field sets the value of the spread spectrum. Options are Disabled, and 0.25% (DOWN). The default setting is **Disabled**. This field is for CE testing use only.

OnChip USB

This field allows you either to enable or disable the USB function. By default, this field is set to **Disabled**.

USB Keyboard Support

Enable this field if your system supports a USB keyboard.

OnChip Sound

This field enables or disables the sound function that built in the VIA chipset.

OnChip Modem

This field enables or disables the modem function that is available on an optional AMR card.

6.6 Power Management Setup

The Power Management Setup allows you to save energy of your system effectively. It will shut down the hard disk and turn off video display after a period of inactivity.

ROM PCI/ISA BIOS
POWER MANAGEMENT SETUP
AWARD SOFTWARE, INC.

ACPI Function	: Enabled	Primary INTR	: ON
Power Management	: User Define	IRQ3 (COM2)	: Primary
PM Control by APM	: Yes	IRQ4 (COM1)	: Primary
Video Off Method	: V/H SYNC +Blank	IRQ5 (LPT 2)	: Primary
Video Off After	: Suspend	IRQ6 (Floppy Disk)	: Primary
Modem Use IRQ	: 3	IRQ7 (LPT 1)	: Primary
Doze Mode	: Disabled	IRQ8 (RTC Alarm)	: Disabled
Suspend Mode	: Disabled	IRQ9 (IRQ2 Redir)	: Secondary
HDD Power Down	: Disabled	IRQ10 (Reserved)	: Secondary
Soft-Off by PWRBTN	: Instant-Off	IRQ11 (Reserved)	: Secondary
PWON After PW-Fail	: Off	IRQ12 (PS/2 Mouse)	: Primary
** PM Events **		IRQ13 (Coprocessor)	: Primary
VGA	: OFF	IRQ14 (Hard Disk)	: Primary
LPT & COM	: LPT / COM	IRQ15 (Reserved)	: Primary
HDD & FDD	: ON	ESC : Quit	↑ ↓ → ← : Select Item
DMA / master	: OFF	F1 : Help	PU/PD/+/- : Modify
RTC Alarm Resume	: Disabled	F5 : Old Values	(Shift) F2 : Color
PWR-ON By Modem/LAN	: Disabled	F6 : Load BIOS Defaults	
		F7 : Load Setup Defaults	

ACPI Function

This field allows you to enabled or disable the ACPI function on the motherboard. By default, this field is set to **Disabled**.

Power Management

This field allows you to select the type of power saving management modes. There are four selections for Power Management.

Min. Power Saving	Minimum power management
Max. Power Saving	Maximum power management.
User Define	Each of the ranges are from 1 min. to 1hr. Except for HDD Power Down which ranges from 1 min. to 15 min. (Default)

NOTE: In order to enable the CPU overheat protection feature, the Power Management field should not be set to Disabled.

PM Control by APM

This field allows you to use the Advanced Power Management device to enhance the Max. Power Saving mode and stop the CPU's internal clock. If the Max. Power Saving is not enabled, this will be preset to NO.

Video Off Method

This field defines the Video Off features. There are three options.

- | | |
|------------------|--|
| V/H SYNC + Blank | Default setting, blank the screen and turn off vertical and horizontal scanning. |
| DPMS | Allows the BIOS to control the video display card if it supports the DPMS feature. |
| Blank Screen | This option only writes blanks to the video buffer. |

Video Off After

This field specifies the mode after which the Video Off feature is enabled. The options are *Doze*, *Standby*, *Suspend*, and *N/A*.

Modem Use IRQ

This field specifies IRQ used by the Modem. The default setting is IRQ3.

Doze Mode

When enabled, and after the set time of system inactivity, the CPU clock will run at a slower speed while all other devices operate at full speed.

Suspend Mode

When enabled, and after the set time of system inactivity, all devices except the CPU will be shut off.

HDD Power Down

When enabled, and after the set time of system inactivity, the hard disk drive will be powered down while all other devices remain active.

Soft-Off by PWRBTN

This field defines the power-off mode when using an ATX power supply. The *Instant Off* mode allows powering off immediately upon pressing the power button. In the *Delay 4 Sec* mode, the system powers off when the power button is pressed for more than four seconds or enters the suspend mode when pressed for less than 4 seconds. The default value is *Instant Off*.

PWRON After PW-Fail

In case of power failure, the system can be configured to power on or to remain off when the power returns. These two settings are *Former-Sts* and *Off* respectively. The default setting for this field is *Off*.

PM Events

The VGA, LPT & COM, HDD & FDD, DMA /master, GPI Resume, Modem Ring Resume, RTC Alarm Resume and Primary INTR section are I/O events which can prevent the system from entering a power saving mode or can awaken the system from such a mode. When an I/O device wants to gain the attention of the operating system, it signals this by causing an IRQ to occur. When the operating system is ready to respond to the request, it interrupts itself and performs the service. The default value is *Off*. When set On, activity will neither prevent the system from going into a power management mode nor awaken it. The IRQ section sets the wake-up call of the system. If activity is detected from any enabled IRQ channels in the left-hand group, the system wakes up from suspended mode.

PWR-ON By Modem/LAN

This field allows powering on the system through a modem connected in one of the serial ports or by network.

6.7 PNP/PCI Configuration

This option configures the PCI bus system. All PCI bus systems on the system use INT#, thus all installed PCI cards must be set to this value.

ROM PCI/ISA BIOS
PNP/PCI CONFIGURATION
AWARD SOFTWARE INC.

PNP OS Installed	: No	CPU to PCI Write Buffer	: Enabled
Resources Controlled by	: Manual	PCI Dynamic Bursting	: Enabled
Reset Configuration Data	: Disabled	PCI Master 0 WS Write	: Disabled
		PCI Delay Transaction	: Enabled
IRQ-3 assigned to	: Legacy ISA	PCI#2 Access #1 Retry	: Disabled
IRQ-4 assigned to	: Legacy ISA	AGP Master 1 WS Write	: Enabled
IRQ-5 assigned to	: PCI/ISA PnP	AGP Master 1 WS Read	: Enabled
IRQ-7 assigned to	: Legacy ISA		
IRQ-9 assigned to	: PCI/ISA PnP	Assign IRQ For USB	: Enabled
IRQ-10 assigned to	: PCI/ISA PnP	Assign IRQ For VGA	: Enabled
IRQ-11 assigned to	: PCI/ISA PnP		
IRQ-12 assigned to	: PCI/ISA PnP		
IRQ-14 assigned to	: PCI/ISA PnP		
IRQ-15 assigned to	: PCI/ISA PnP		
DMA-0 assigned to	: PCI/ISA PnP		
DMA-1 assigned to	: PCI/ISA PnP	ESC : Quit	↑ ↓ ← : Select Item
DMA-3 assigned to	: PCI/ISA PnP	F1 : Help	PU/PD/+/- : Modify
DMA-5 assigned to	: PCI/ISA PnP	F5 : Old Values	(Shift) F2 : Color
DMA-6 assigned to	: PCI/ISA PnP	F6 : Load BIOS Defaults	
DMA-7 assigned to	: PCI/ISA PnP	F7 : Load Setup Defaults	

PNP OS Installed

This field allows you to specify if the operating system installed in your system is plug and play aware.

NOTE: Operating systems such as DOS, OS/2, and Windows 3.x do not use PnP.

Resources Controlled by

This PnP BIOS can configure all of the boot and compatible devices automatically. However, this capability needs you to use a PnP operating system such as Windows 95. The default value is **Manual**.

Reset Configuration Data

This field allows you to determine whether to reset the configuration data or not. The default value is **Disabled**.

IRQ3/4/5/7/9/10/11/12/14/15, DMA0/1/3/5/6/7 assigned to

These fields allow you to determine the IRQ/DMA assigned to the ISA bus and is not available to any PCI slot.

CPU to PCI Write Buffer

When enabled, this option increase the efficiency of the PCI bus to and speed up the execution in the processor. By default, this field is set to *Enabled*.

PCI Dynamic Bursting

When enabled, this option combines several PCI cycles into one. By default, this field is set to *Disabled*.

PCI Master 0 WS Write

When enabled, this option increases the write cycle speed. By default, this field is set to *Disabled*.

PCI Delay Transaction

When enabled, this option delays PCI data transaction. By default, this field is set to *Enabled*.

PCI#2 Access #1 Retry

This item enables PC#2 Access #1 attempts. By default, this field is set to *Disabled*.

AGP Master 1 WS Write

When enabled, writes to the AGP bus are executed with 1 wait states. By default, this field is set to *Enabled*.

AGP Master 1 WS Read

When enabled, reads to the AGP bus are executed with 1 wait states. By default, this field is set to *Enabled*.

Assign IRQ for USB/VGA

These fields allow you to enable or disable the IRQ for USB and VGA. By default, these fields are enabled.

6.8 Load BIOS Defaults

This option allows you to load the troubleshooting default values permanently stored in the BIOS ROM. These default settings are non-optimal and disable all high-performance features.

ROM PCI/ISA BIOS
CMOS SETUP UTILITY
AWARD SOFTWARE, INC.

STANDARD CMOS SETUP BIOS FEATURES SETUP CHIPSET FEATURES SETUP POWER MANAGE PNP/PCI CONF LOAD BIOS DEF LOAD SETUP D	CPU FEATURES SETUP INTEGRATED PERIPHERALS SUPERVISOR PASSWORD DETECTION UP SAVING
<div style="border: 2px solid black; padding: 5px; display: inline-block;"> Load BIOS Defaults (Y/N)? N </div>	
ESC : Quit F10 : Save & Exit Setup	↑ ↓ → ← : Select Item (Shift) F2 : Change Color
Load BIOS Defaults except Standard CMOS Setup	

To load BIOS defaults value to CMOS SRAM, enter “Y”. If not, enter “N”.

6.9 Load Setup Defaults

This option allows you to load the default values to your system configuration. These default settings are optimal and enable all high performance features.

ROM PCI/ISA BIOS
CMOS SETUP UTILITY
AWARD SOFTWARE, INC.

STANDARD CMOS SETUP BIOS FEATURES SETUP CHIPSET FEATURES SETUP POWER MANAGE PNP/PCI CONF LOAD BIOS DEF LOAD SETUP DEF	CPU FEATURES SETUP INTEGRATED PERIPHERALS SUPERVISOR PASSWORD DETECTION UP SAVING
<div style="border: 2px solid black; padding: 5px; display: inline-block;"> Load Setup Defaults (Y/N)? N </div>	
ESC : Quit F10 : Save & Exit Setup	↑ ↓ → ← : Select Item (Shift) F2 : Change Color
Load BIOS Defaults except Standard CMOS Setup	

To load SETUP defaults value to CMOS SRAM, enter “Y”. If not, enter “N”.

6.10 CPU Features Setup

This Setup menu controls the configuration pertaining to the CPU and system temperature.

ROM PCI/ISA BIOS																																
CPU FEATURES SETUP																																
AWARD	SOFTWARE INC.																															
<table style="width: 100%; border-collapse: collapse;"> <tr> <td style="width: 40%;">Current CPU Temp.</td> <td style="width: 20%;">: 41°C/ 105°F</td> <td style="width: 40%;"></td> </tr> <tr> <td>Current System Temp.</td> <td>: 34°C/ 93°F</td> <td></td> </tr> <tr> <td>Current CPU Fan Speed</td> <td>: 2789 RPM</td> <td></td> </tr> <tr> <td>Current Chassis Fan Speed</td> <td>: 2045 RPM</td> <td></td> </tr> <tr> <td>VCORE : 2.06 V</td> <td>VCC2 : 2.56 V</td> <td></td> </tr> <tr> <td>VCC3 : 3.41 V</td> <td>+5 V : 5.27 V</td> <td></td> </tr> <tr> <td>+12 V : 12.46 V</td> <td></td> <td></td> </tr> </table>	Current CPU Temp.	: 41°C/ 105°F		Current System Temp.	: 34°C/ 93°F		Current CPU Fan Speed	: 2789 RPM		Current Chassis Fan Speed	: 2045 RPM		VCORE : 2.06 V	VCC2 : 2.56 V		VCC3 : 3.41 V	+5 V : 5.27 V		+12 V : 12.46 V			<table style="width: 100%; border-collapse: collapse;"> <tr> <td>ESC : Quit</td> <td>↑ ↓ → ← : Select Item</td> </tr> <tr> <td>F1 : Help</td> <td>PU/PD/+/- : Modify</td> </tr> <tr> <td>F5 : Old Values</td> <td>(Shift) F2 : Color</td> </tr> <tr> <td>F6 : Load BIOS Defaults</td> <td></td> </tr> <tr> <td>F7 : Load Setup Defaults</td> <td></td> </tr> </table>	ESC : Quit	↑ ↓ → ← : Select Item	F1 : Help	PU/PD/+/- : Modify	F5 : Old Values	(Shift) F2 : Color	F6 : Load BIOS Defaults		F7 : Load Setup Defaults	
Current CPU Temp.	: 41°C/ 105°F																															
Current System Temp.	: 34°C/ 93°F																															
Current CPU Fan Speed	: 2789 RPM																															
Current Chassis Fan Speed	: 2045 RPM																															
VCORE : 2.06 V	VCC2 : 2.56 V																															
VCC3 : 3.41 V	+5 V : 5.27 V																															
+12 V : 12.46 V																																
ESC : Quit	↑ ↓ → ← : Select Item																															
F1 : Help	PU/PD/+/- : Modify																															
F5 : Old Values	(Shift) F2 : Color																															
F6 : Load BIOS Defaults																																
F7 : Load Setup Defaults																																

Current CPU / System Temp.

These read-only fields reflect the functions of the hardware thermal sensor that monitors the chip blocks and system temperatures to ensure the system is stable.

Current CPU Fan Speed / Chassis Fan Speed

These read-only fields show the current speeds in RPM (revolution per minute) for the CPU fan and chassis fan as monitored by the hardware monitoring IC.

VCORE / VCC3 / +12V / VCC2 / +5V

These read-only fields show the current voltages in the voltage regulators and power supply as monitored by the hardware monitoring IC.

6.10 Integrated Peripherals

This option sets your hard disk configuration, mode and port.

ROM PCI/ISA BIOS
INTEGRATED PERIPHERALS
AWARD SOFTWARE INC.

On-Chip IDE Channel 0	: Enabled	Onboard Parallel Port	: 378/IRQ7
On-Chip IDE Channel 1	: Enabled	Parallel Port Mode	: Normal
IDE Prefetch Mode	: Disabled		
IDE HDD Block Mode	: Enabled		
Primary Master PIO	: Auto		
Primary Slave PIO	: Auto	Onboard legacy Audio	: Enabled
Secondary Master PIO	: Auto	Sound Blaster	: Enabled
Secondary Slave PIO	: Auto	SB I/O Base Address	: 220H
Primary Master UDMA	: Auto	SB IRQ Select	: IRQ 5
Primary Slave UDMA	: Auto	SB DMA Select	: DMA 1
Secondary Master UDMA	: Auto	MPU-401	: Enabled
Secondary Slave UDMA	: Auto	MPU-401 I/O Address	: 330-333H
		Game Port (200-270H)	: Enabled
Onboard FDD Controller	: Enabled		
Onboard Serial Port 1	: 3F8/IRQ4	Parallel Port Mode	: Normal
Onboard Serial Port 2	: 2F8/IRQ3	F1 : Help	PU/PD/+/- : Modify
UART 2 Mode	: Standard	F5 : Old Values	(Shift) F2 : Color
		F6 : Load BIOS Defaults	
		F7 : Load Setup Defaults	

OnChip IDE Channel0/1

The integrated peripheral controller contains an IDE interface with support for two IDE channels. Select *Enabled* to activate each channel separately.

IDE Prefetch Mode

This field allows your hard disk controller to use prefetch mode to transfer data to increase the performance.

IDE HDD Block Mode

This field allows your hard disk controller to use the fast block mode to transfer data to and from your hard disk drive.

Primary/Secondary Master/Slave PIO

These fields allow your system hard disk controller to work faster. Rather than have the BIOS issue a series of commands that transfer to or from the disk drive, PIO (Programmed Input/Output) allows the BIOS to communicate with the controller and CPU directly.

The system supports five modes, numbered from 0 (default) to 4, which primarily differ in timing. When Auto is selected, the BIOS will select the best available mode.

Primary/Secondary Master/Slave UDMA

These fields allow your system to improve disk I/O throughput by enabling the Ultra DMA/33 or Ultra DMA/66 feature of your hard disks. The options are *Auto* and *Disabled*.

Init AGP Display First

This field allows the system to initialize first the VGA card in the AGP slot on the motherboard when system is turned on.

Onboard FDD Controller

Select *Enabled* if your system has a floppy disk controller (FDC) installed on the motherboard and you wish to use it. If you install an add-in FDC or the system has no floppy drive, select *Disabled* in this field. This option allows you to select the onboard FDD port.

Onboard Serial/Parallel Port

These fields allow you to select the onboard serial and parallel ports and their addresses. The default values for these ports are:

Serial Port 1	3F8/IRQ4
Serial Port 2	2F8/IRQ3
Parallel Port	378H/IRQ7

UART 2 Mode

This field determines the UART 2 mode in your computer. The default value is *Standard*.

Parallel Port Mode

This field allows you to determine parallel port mode function.

SPP	Normal Printer Port
EPP	Enhanced Parallel Port
ECP	Extended Capabilities Port

Onboard Legacy Audio

When this field is enabled, other options of the on board audio in this setup can be configured. These options included Sound Blaster, SB I/O Base Address, SB IRQ Select, SB DMA Select, MPU-401, MPU-401 I/O Address and Game Port.

6.11 Supervisor / User Password

These two options set the system password. Supervisor Password sets a password that will be used to protect the system and Setup utility. User Password sets a password that will be used exclusively on the system. To specify a password, highlight the type you want and press <Enter>. The Enter Password: message prompts on the screen. Type the password, up to eight characters in length, and press <Enter>. The system confirms your password by asking you to type it again. After setting a password, the screen automatically returns to the main screen.

To disable a password, just press the <Enter> key when you are prompted to enter the password. A message will confirm the password to be disabled. Once the password is disabled, the system will boot and you can enter Setup freely.

ROM PCI/ISA BIOS
CMOS SETUP UTILITY
AWARD SOFTWARE, INC.

STANDARD CMOS SETUP	CPU FEATURES SETUP
BIOS FEATURES SETUP	INTEGRATED PERIPHERALS
CHIPSET FEATURES SETUP	SUPERVISOR PASSWORD
POWER MANAGE	D
PNP/PCI CONF	TECTION
LOAD BIOS DEF	UP
LOAD SETUP D	AVING
ESC : Quit	↑ ↓ → ← : Select Item
F10 : Save & Exit Setup	(Shift) F2 : Change Color
Change / Set / Disable Password	

6.12 IDE HDD Auto Detection

This option detects the parameters of an IDE hard disk drive, and automatically enters them into the Standard CMOS Setup screen.

ROM PCI/ISA BIOS
STANDARD CMOS SETUP
AWARD SOFTWARE, INC.

HARD DISKS	TYPE	SIZE	CYLS	HEAD	PRECOMP	LANDZ	SECTOR	MODE
Primary Master:								
Select Primary Master Option (N=SKIP) : N								
OPTIONS	TYPE	SIZE	CYLS	HEAD	PRECOMP	LANDZ	SECTOR	MODE
1 (Y)	0	0	0	0	0	0	0	NORMAL

NOTE: Some OSes (like SCO-UNIX) must use "NORMAL" for installation

ESC: SKIP

Up to four IDE drives can be detected, with parameters for each appearing in sequence inside a box. To accept the displayed entries, press the “Y” key; to skip to the next drive, press the “N” key. If you accept the values, the parameters will appear listed beside the drive letter on the screen.

6.13 Save & Exit Setup

This option allows you to determine whether or not to accept the modifications. If you type “Y”, you will quit the setup utility and save all changes into the CMOS memory. If you type “N”, you will return to Setup utility.

ROM PCI/ISA BIOS
CMOS SETUP UTILITY
AWARD SOFTWARE, INC.

STANDARD CMOS SETUP	CPU FEATURES SETUP
BIOS FEATURES SETUP	INTEGRATED PERIPHERALS
CHIPSET FEATURES SETUP	SUPERVISOR PASSWORD
POWER MANAGE...	D
PNP/PCI CONF...	TECTION
LOAD BIOS DEF...	UP
LOAD SETUP DEFAULTS	EXIT WITHOUT SAVING
ESC : Quit	↑ ↓ → ← : Select Item
F10 : Save & Exit Setup	(Shift) F2 : Change Color
Save to CMOS and Exit(Y/N)? N	
Save Data to CMOS & Exit Setup	

6.14 Exit Without Saving

Select this option to exit the Setup utility without saving the changes you have made in this session. Typing “Y” will quit the Setup utility without saving the modifications. Typing “N” will return you to Setup utility.

ROM PCI/ISA BIOS
CMOS SETUP UTILITY
AWARD SOFTWARE, INC.

STANDARD CMOS SETUP	CPU FEATURES SETUP
BIOS FEATURES SETUP	INTEGRATED PERIPHERALS
CHIPSET FEATURES SETUP	SUPERVISOR PASSWORD
POWER MANAGE...	D
PNP/PCI CONF...	TECTION
LOAD BIOS DEF...	UP
LOAD SETUP DEFAULTS	EXIT WITHOUT SAVING
ESC : Quit	↑ ↓ → ← : Select Item
F10 : Save & Exit Setup	(Shift) F2 : Change Color
Quit Without Saving (Y/N)? N	
Abandon all Data & Exit Setup	

Chapter 7 VIA Drivers Installation Guide

This chapter describes the installation procedure for the drivers from VIA including 4-in-1 driver, DirectX, VXD driver, audio driver and VGA driver.

NOTE: *If you are using Windows 95, please install USB supplement to OSR2 from the original Windows 95 CD or download it from Microsoft's web site after you have installed Windows 95 (even before you have started to install the drivers mentioned in this chapter.)*

7.1 Windows 98 4-in-1 Driver Installation

1. Insert the driver CD disc to the CD-ROM drive. The CD-ROM autoruns and displays the selection for Intel drivers and VIA drivers. Click on **VIA M/B Drivers** and the following window will appear. Click **VIA 4 IN 1 Drivers**.

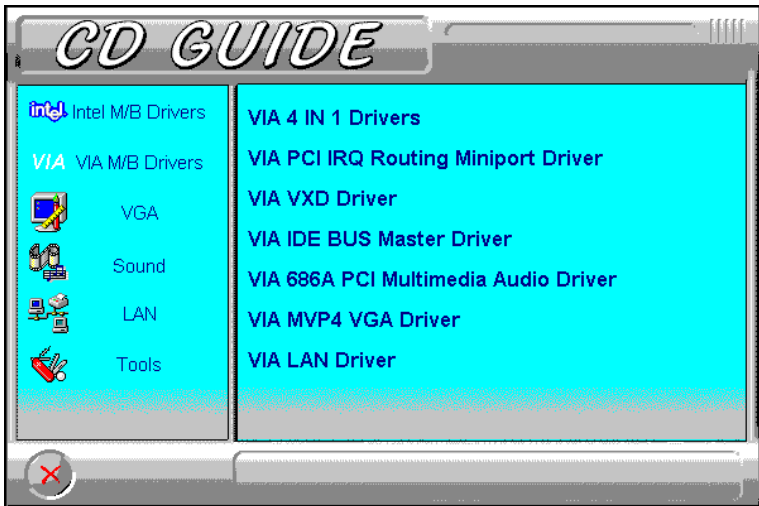

- When the **Welcome** screen appears, click **Next** to continue with the Setup program.
- To accept the VIA Service Pack license agreement, click **Yes**.
- Click **Next** for the setup program to install the drivers for Bus Master PCI IDE, AGP VxD, VIA Chipset Functions' Registry and IRQ Routing Miniport Drivers.

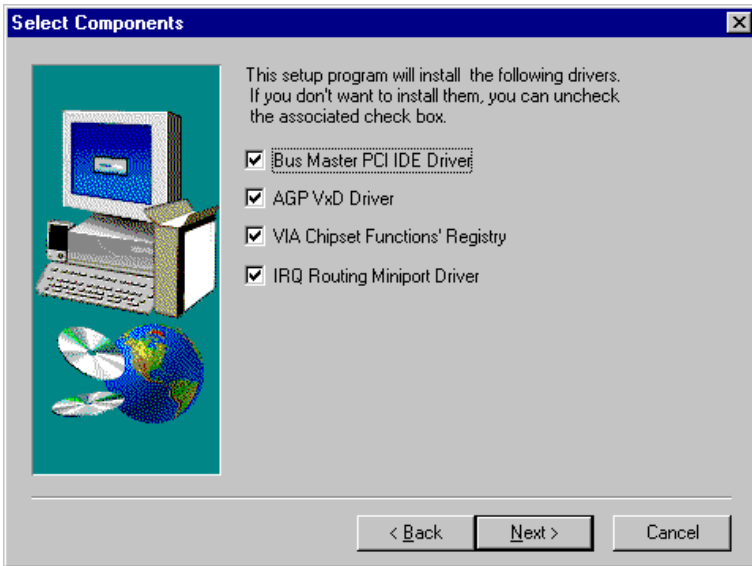

- Click **Next** to install (Ultra) DMA for IDE driver.
- Click on the **Enable/Disable (Ultra) DMA** checkbox, and then click **Next** to continue the installation process.
- When the **Choose Destination Location** window appears, click **Next** to install **VIA Service Pack** in the folder name shown.

8. When the **Select Program Folder** window appears, click **Next** for Setup to add the program icons to the **VIADMATOOL** program folder. You may, however, type a new folder name or select one from the existing Folders list.

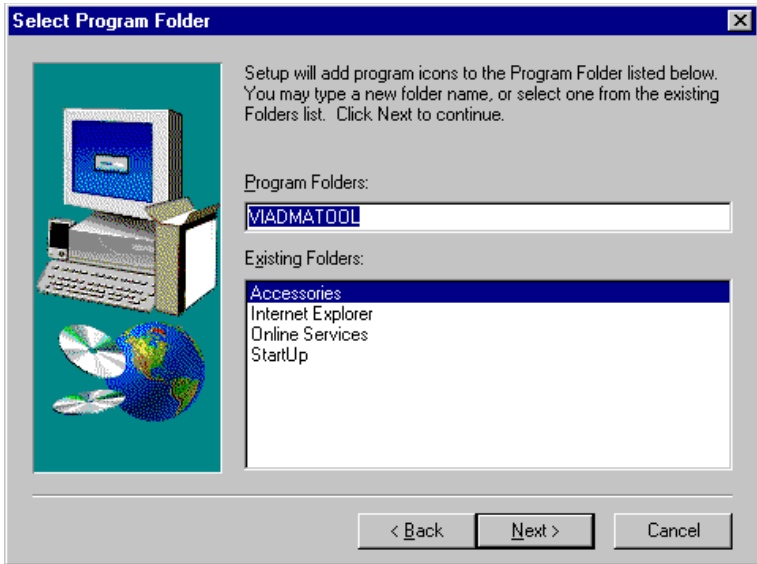

9. When the **VIA_GART AGP Driver 3.55** window appears, click **Next** to install **VIA AGP VxD in turbo mode**.

10. When the **IRQ Routing Driver 1.30** window appears, click **Next** to install the **VIA IRQ Routing Miniport Driver**.

11. When the **VIA Chipset Functions' Registry** window appears, click **Next** to install the VIA Chipset Functions' Registry.

12. When Setup has finished copying files to your computer, click **Finish** to restart your computer and for changes to take effect.

7.2 Windows 98/95 DirectX Installation

1. Insert the driver CD disc to the CD-ROM drive. The CD-ROM autoruns and displays the selections available. Click on **Tools** and the following window will appear. Click **DirectX 6.1 Core**.

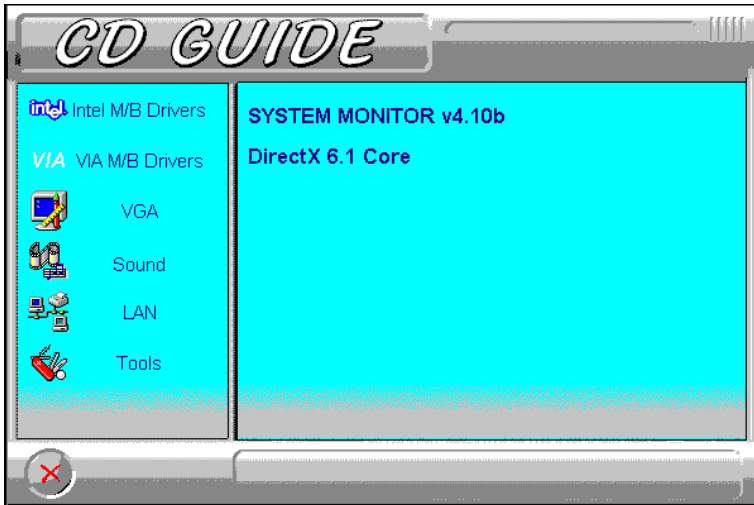

2. Click **Yes** to install Microsoft DirectX 6.1 Runtime.

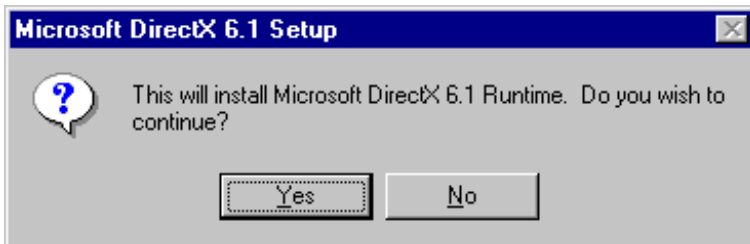

3. Click **Yes** to continue.

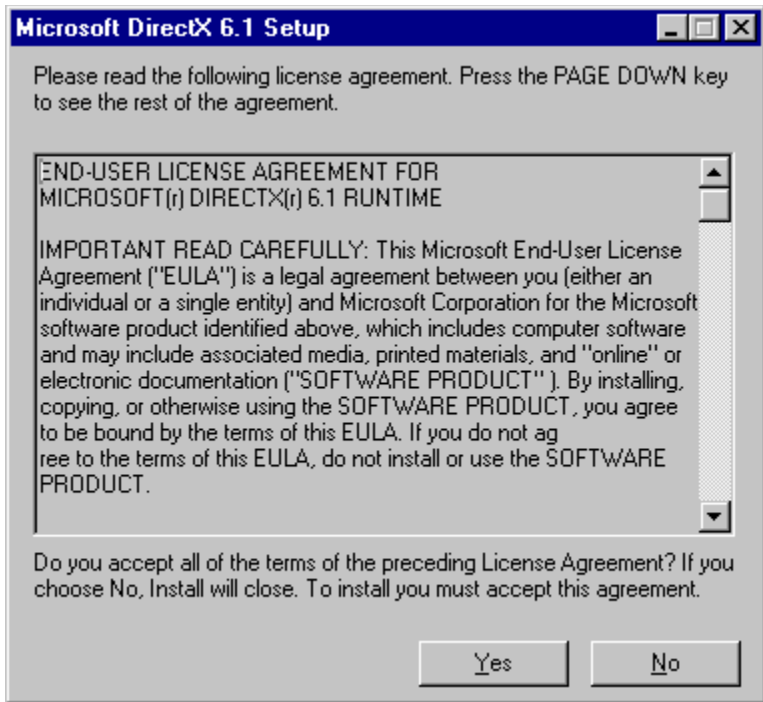

4. When the necessary files have been copied, press **OK** to restart the computer and changes to take affect.

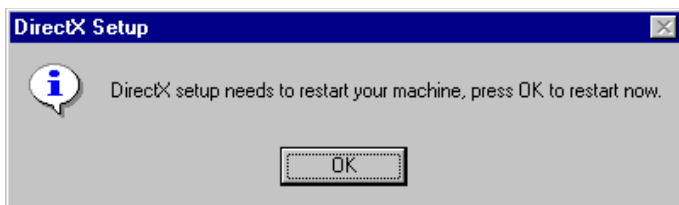

7.3 Windows 98 VGA Driver Installation

1. Insert the driver CD disc to the CD-ROM drive. The CD-ROM autoruns and displays the selections available. Click on **VIA M/B Drivers** and the window below appears. Click **VIA MVP4 VGA Driver**.

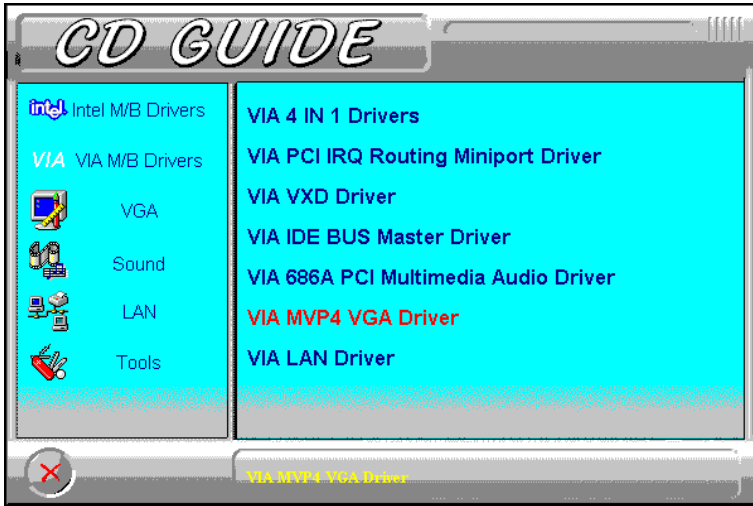

2. Click **Next** to continue the Setup program.

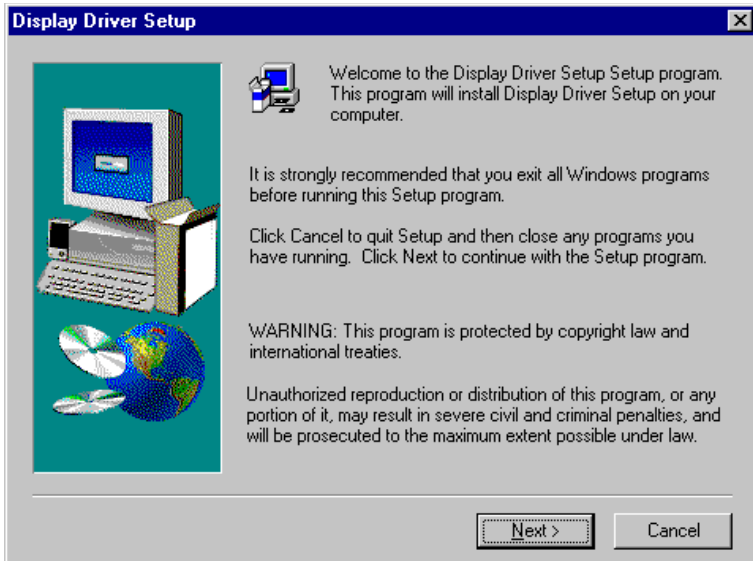

3. Select the components to install and click **Next**.

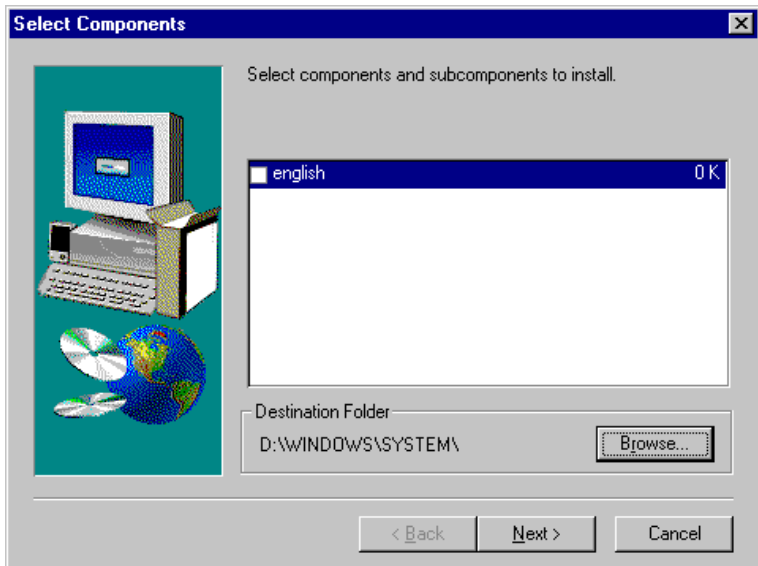

3. Click **Finish** to restart the computer and for changes to take effect.



7.4 Windows 98 Audio Driver Installation

1. Insert the driver CD disc to the CD-ROM drive. The CD-ROM autoruns and displays the selections available. Click on **VIA M/B Drivers** and the following window appears. Click **VIA 686A PCI Multimedia Audio Driver**.



2. When the **Welcome** screen appears, click **Next** to proceed with the audio driver installation.
3. The **Select Components** window will appear. Click **Next** to install the audio driver.
4. After the necessary files are copied, click **Finish** for the computer the restart.
5. When Windows has restarted, a message will appear prompting you to insert the Windows 98 CDROM. Insert the Windows 98 CD-ROM and click **OK**.

7.5 Windows 98SE 4-in-1 Driver Installation

1. Insert the driver CD disc to the CD-ROM drive. The CD-ROM autoruns and displays the selection for Intel drivers and VIA drivers. Click on **VIA M/B Drivers** and the following window will appear. Click **VIA 4 IN 1 Drivers**.

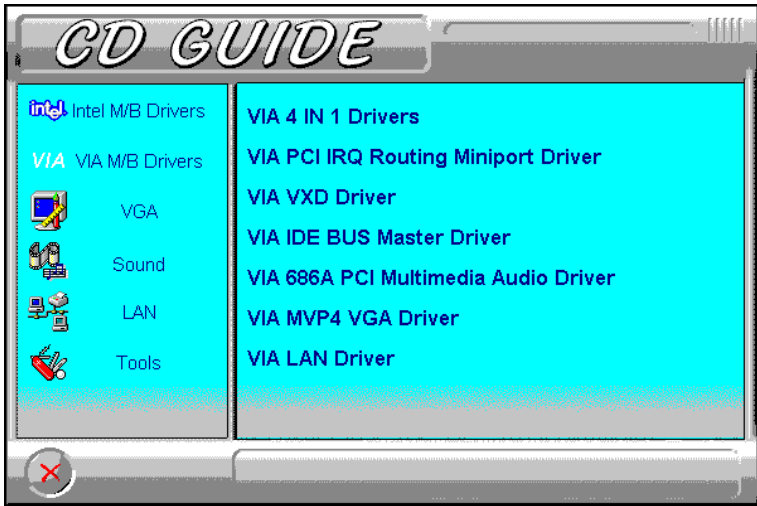

2. When the **Welcome** screen appears, click **Next** to continue with the Setup program.
3. To accept the VIA Service Pack license agreement, click **Yes**.

4. Click **Next** for the setup program to install the AGP VxD Driver. Please note that there are no check box for the Bus Master PCI IDE drivers, VIA Chipset Functions' Registry and IRQ Routing Miniport Drivers (unlike Windows 98 and Windows 95), because these drivers are already supported by Windows 98SE.



5. When the **VIA_GART AGP Driver 3.55** window appears, click **Next** to install **VIA AGP VxD in turbo mode**.

6. When Setup has finished copying files to your computer, click **Finish** to restart your computer and for changes to take effect.

7.6 Windows 98SE VGA Driver Installation

1. Insert the driver CD disc to the CD-ROM drive. The CD-ROM autoruns and displays the selections available. Click on **VIA M/B Drivers** and the following window appears. Click **VIA MVP4 VGA Driver**.

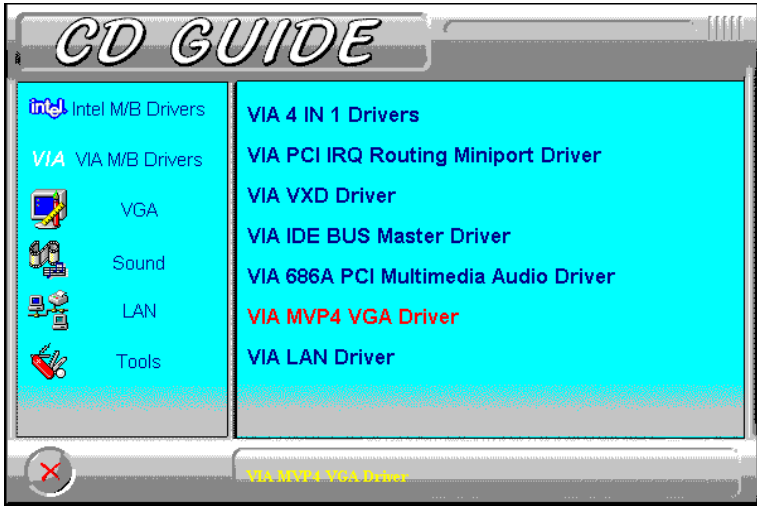

2. When the **Welcome** screen appears, click **Next** to proceed with the VGA driver installation.
3. The **Select Components** window will appear. Click **Next** to install the VGA driver.
4. After the necessary files are copied, click **Finish** to restart the computer for changes to take effect.

7.7 Windows 98SE Audio Driver Installation

1. Insert the driver CD disc to the CD-ROM drive. The CD-ROM autoruns and displays the selections available. Click on **VIA M/B Drivers** and the following window appears. Click **VIA 686A PCI Multimedia Audio Driver**.

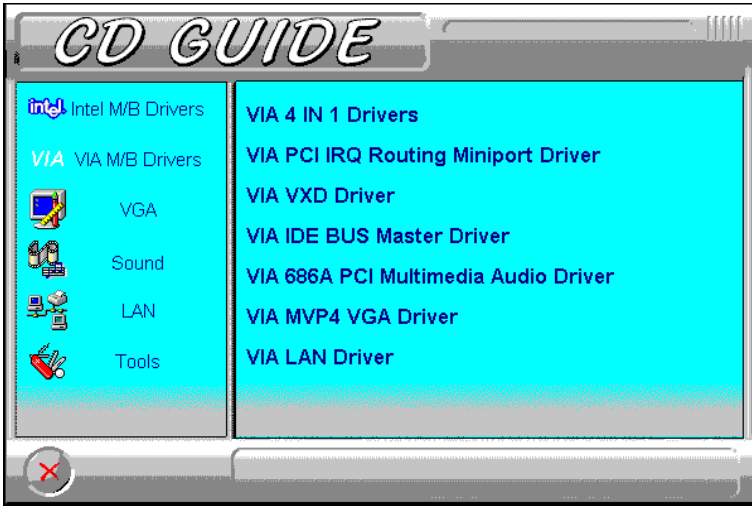

2. When the **Welcome** screen appears, click **Next** to proceed with the audio driver installation.
3. The **Select Components** window will appear. Click **Next** to install the audio driver.
4. After the necessary files are copied, click **Finish**.
5. When Windows has restarted, a message will appear prompting you to insert the Windows 98 Second Edition CDROM. Insert the CDROM and click **OK**. After the necessary files are copied, restart your computer for changes to take effect.

7.8 Windows 95 4-in-1 Driver Installation

1. Insert the driver CD disc to the CD-ROM drive. The CD-ROM autoruns and displays the selection for Intel drivers and VIA drivers. Click on **VIA M/B Drivers** and the following window will appear. Click **VIA 4 IN 1 Drivers**.

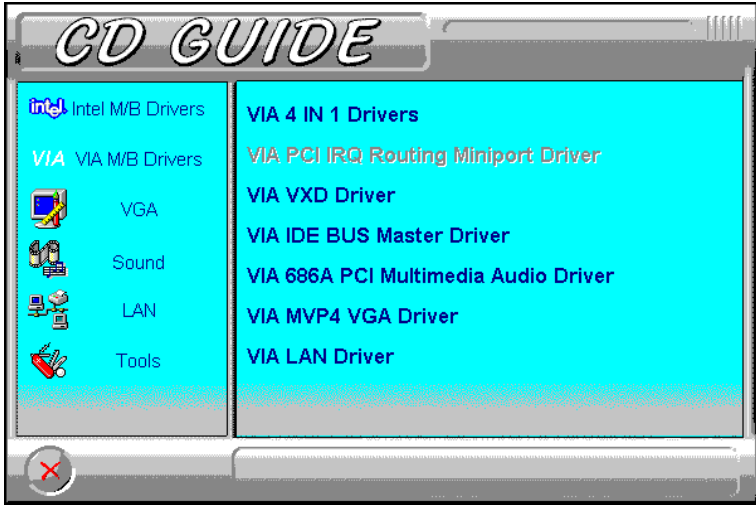

2. Click **Next**. to continue the installation process, and then click **Yes** to agree with the license agreement.

3. Click **Next** to install all the drivers shown below.

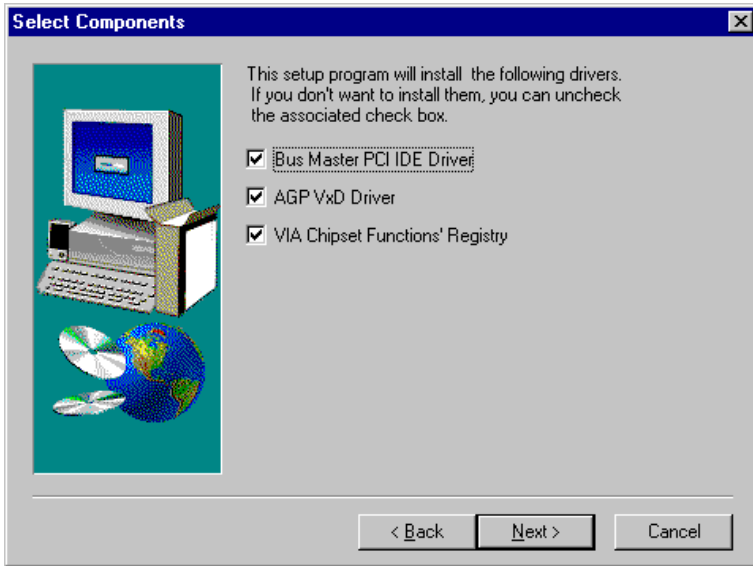

4. Click **Next** to install the (Ultra) DMA for IDE driver.

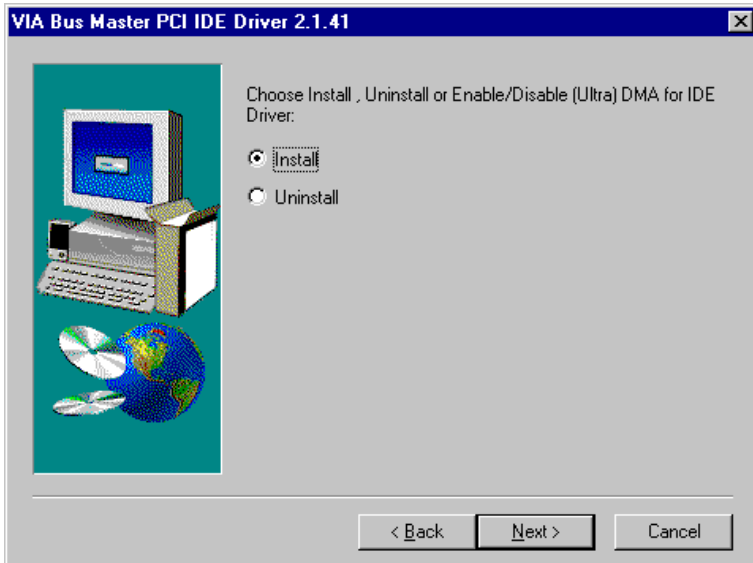

5. Click on the **Enable/Disable (Ultra) DMA** checkbox, and click **Next** to enable (Ultra) DMA.

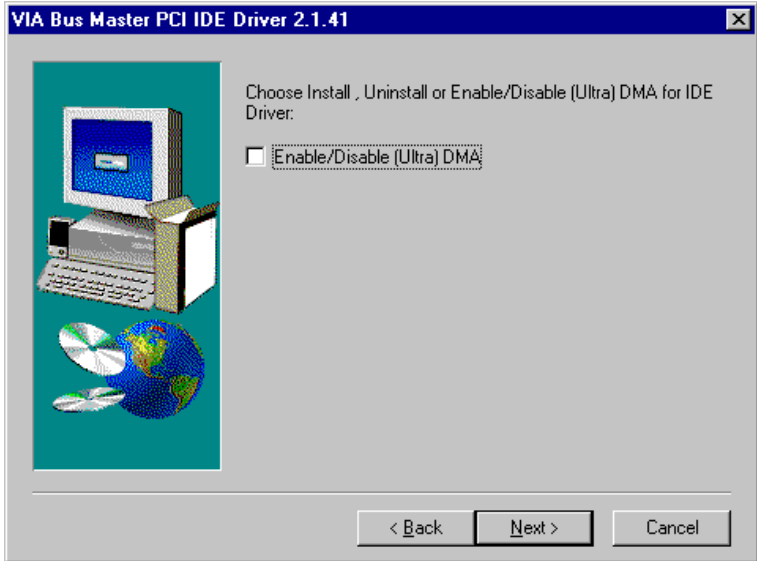

6. To install **VIA Service Pack**, click **Next**.

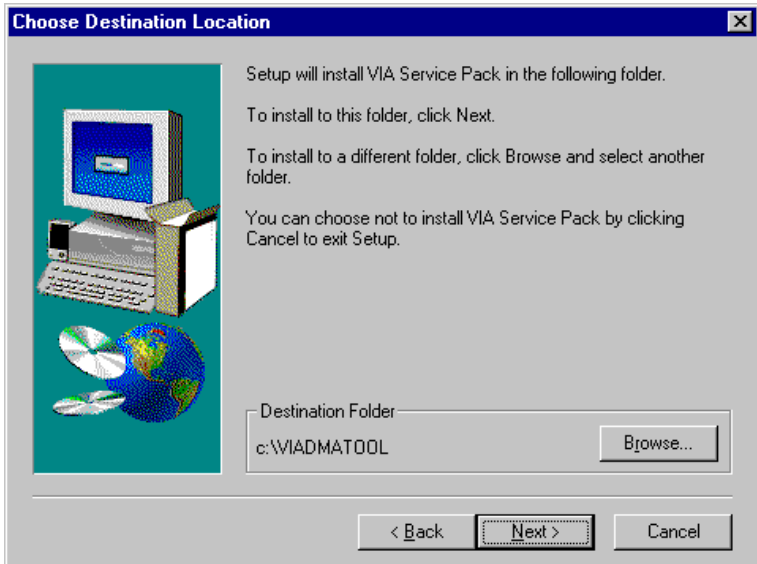

7. Click **Next** to accept the listed folder name or select from the existing folders list, then click **Next**.



8. Click **Next** to install the VIA AGP driver.

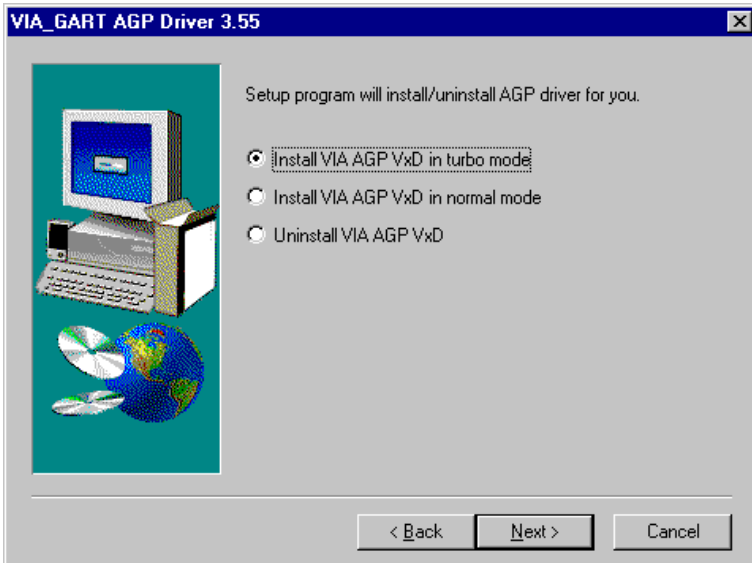

9. Click **Next** to install the VIA Chipset Functions' Registry.

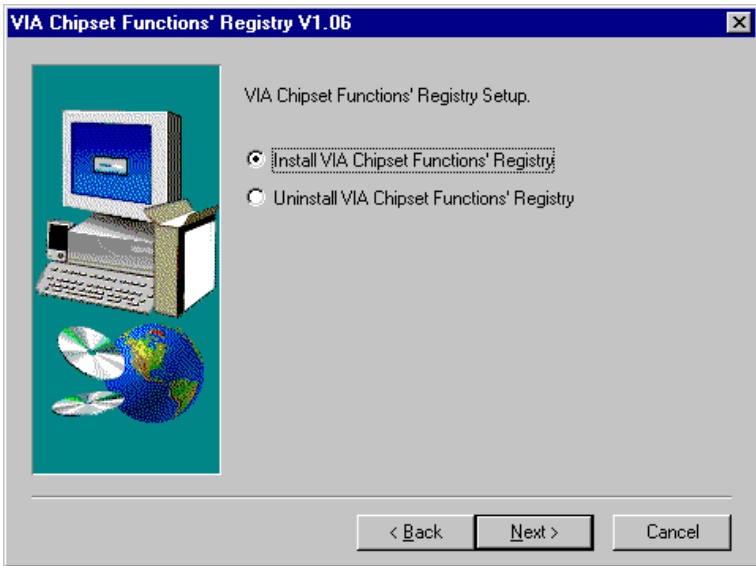

10. When Setup has finished copying files to your computer, you must restart Windows or your computer before you can use the program. Remove any disks from their drives, and then click **Finish** to complete setup.

7.9 Windows 95 VGA Driver Installation

1. Click **Start**. Select **Settings**, then click the **Control Panel** icon.
2. Double click **Display**.
3. Click **Settings**.
4. Click **Advanced**.
5. Click **Adapter**.
6. Click **Change....**
7. Select **Display a list of all the drivers in a specific location**, then click **Next**.
8. Click **Have Disk....**
9. Assuming "D:" is your CDROM drive, type **d:\via\mvp4vga\win95**.
10. Select **Trident CyberBlade i7 AGP (v6.50.5495-7ICD)**.
11. Click **Close**, and then **Close** again.
12. Click **Yes** to restart your computer and for the new settings to take effect.

7.10 Windows 95 Audio Driver Installation

1. Insert the driver CD disc to the CD-ROM drive. The CD-ROM autoruns and displays the selections available. Click on **VIA M/B Drivers** and the following window appears. Click **VIA 686A PCI Multimedia Audio Driver**.

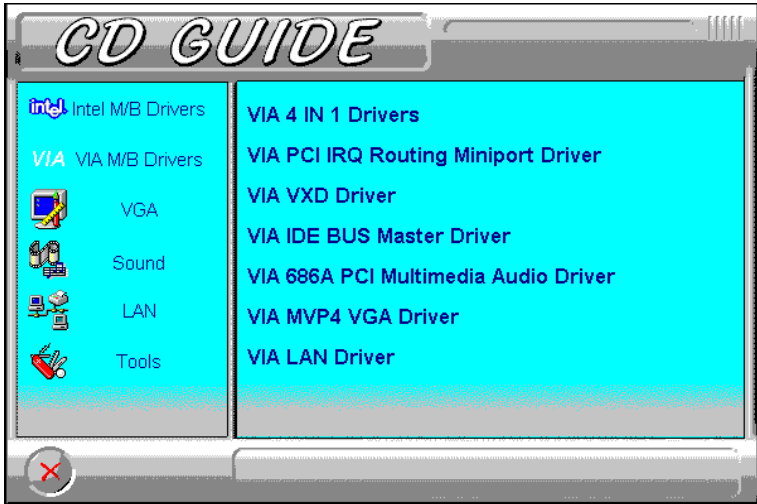

2. The next screen will ask you to remove the Audio Device from the Device Manager. If you have already removed the audio device, click **Yes** to continue the audio driver installation. (If you have not, click **No** and exit the installation process and remove the audio device before installing the audio drivers.)

3. To continue with the VIA PCI Audio Driver Installation, click **Next** to agree with the license agreement.

4. When the **Select Components** window appears, click **Next** to install the audio driver.

5. After the necessary files are copied, click **Finish** for the computer the restart.

6. When Windows has restarted, it will be able to detect the VIA PCI Audio Controller. Click **Next** and then **Finish**. When prompted to insert the Windows 95 CD-ROM, do so accordingly and then click **OK**.

7.11 Windows NT 4.0 VGA Driver Installation

1. Insert the driver CD disc to the CD-ROM drive. The CD-ROM autoruns and displays the selections available. Click on **VIA M/B Drivers** and the following window appears. Click **VIA MVP4 VGA Driver**.

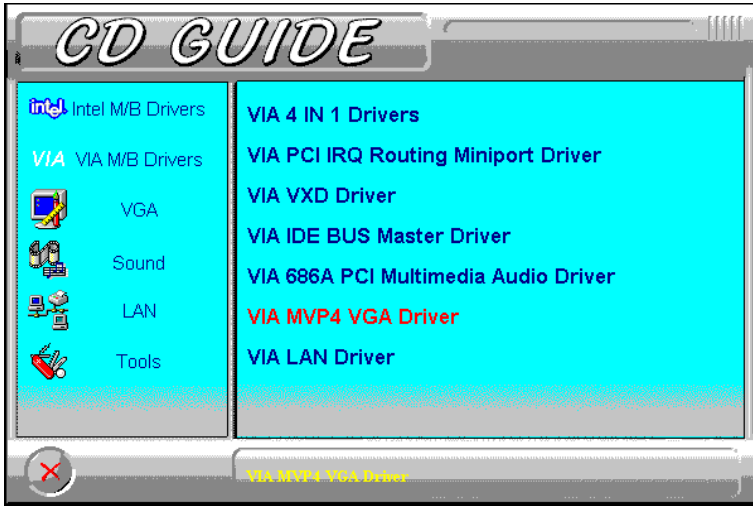

2. When the **Welcome** screen appears, click **Next** to proceed with the VGA driver installation.
3. The **Select Components** window will appear. Click **Next** to install the VGA driver.
4. After the necessary files are copied, click **Finish** to restart the computer for changes to take effect.

7.12 Windows NT 4.0 Audio Driver Installation

IMPORTANT: You should install the Windows NT 4.0 Service Pack 4 or higher first before installing the VIA 686A PCI multimedia audio device drivers. If you don't have Windows NT 4.0 Service Pack 4 or higher, please contact your software vendor or download it from Microsoft's web site.

1. Insert the driver CD disc to the CD-ROM drive. The CD-ROM autoruns and displays the selections available. Click on **VIA M/B Drivers** and the following window appears. Click **VIA 686A PCI Multimedia Audio Driver**.

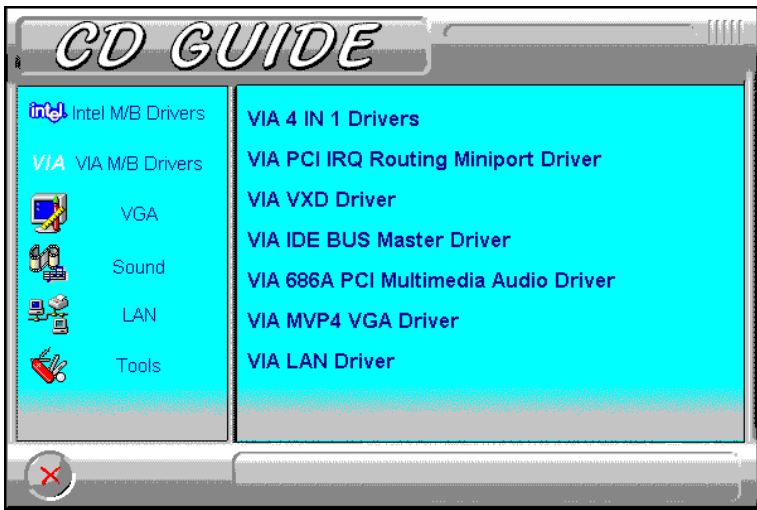

2. When the **Welcome** screen appears, click **Next** to proceed with the audio driver installation.
3. The **Select Components** window will appear. Click **Next** to install the audio driver.

4. When the **Information** window appears, click **OK**. Please choose **“Add...”** from the next window and add the following device: VIA PCI Audio Controller and VIA MIDI External Port.

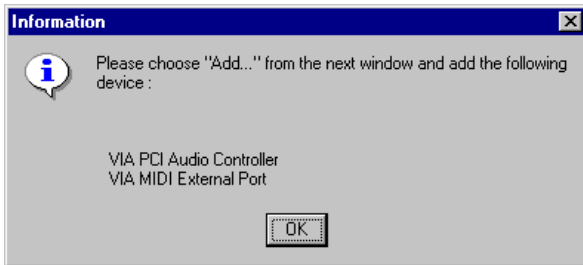

5. After the VIA PCI Audio Controller and VIA MIDI External Port devices are added, you will be asked whether to install the driver for the Microsoft Sidewinder 3D Pro Joystick. Click **Yes**. You will be prompted to press **“Add...”** from the next window and select **“Microsoft Side winder 3D Pro Joystick”** to install the joystick’s driver. Refer to the following figures.

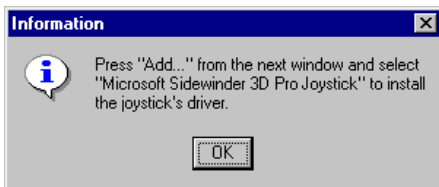
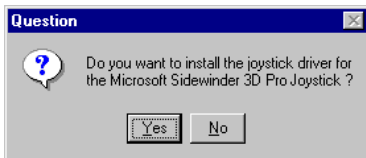

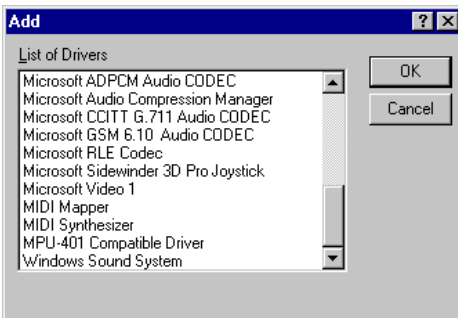

6. Upon adding the **Microsoft Side winder 3D Pro Joystick**, insert the Windows NT CD-ROM or the disk with the updated `sidewndr.dll` driver.

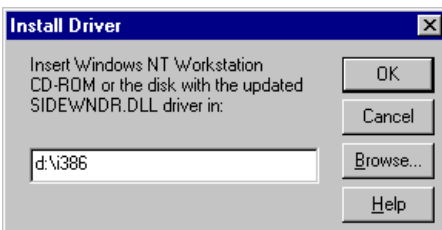

7. When the **Microsoft SideWinder Joystick Configuration** window appears, click **OK** to accept the default configuration. Then, restart the computer for changes to take effect.

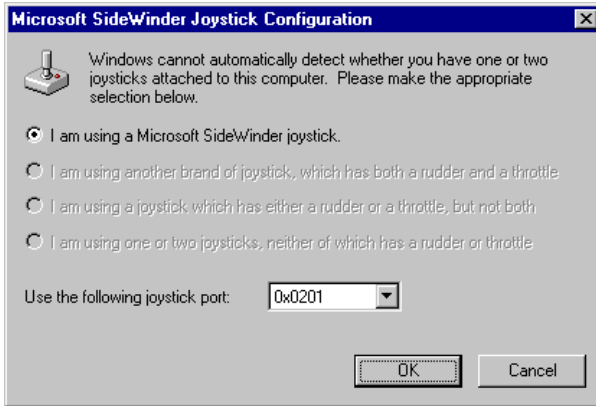

Chapter 8 System Monitor Installation

This chapter shows the installation procedure of the System Monitor Utility. The software comes in the CD with the motherboard and is used in conjunction with the onboard hardware monitoring function.

System Monitor is a software utility that oversees the general performance of systems, covering areas like system temperature, system voltage, CPU and system fan rotational speeds. If conditions become adverse, that is, when voltages are erratic or CPU temperature exceeds the safe limits, an alarm will be sounded; thereby preventing system crashing and ensuring overall stability.

Please follow the procedure below on how to install System Monitor.

1. Insert the driver CD disc to the CD-ROM drive. The CD-ROM autoruns and displays the selections available. Click on **Tools** and the following window appears. Click **SYSTEM MONITOR**, then **YES** to proceed with the installation.

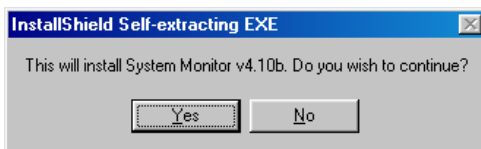

2. When the **Welcome** screen appears, click **Next** to continue with the Setup program.

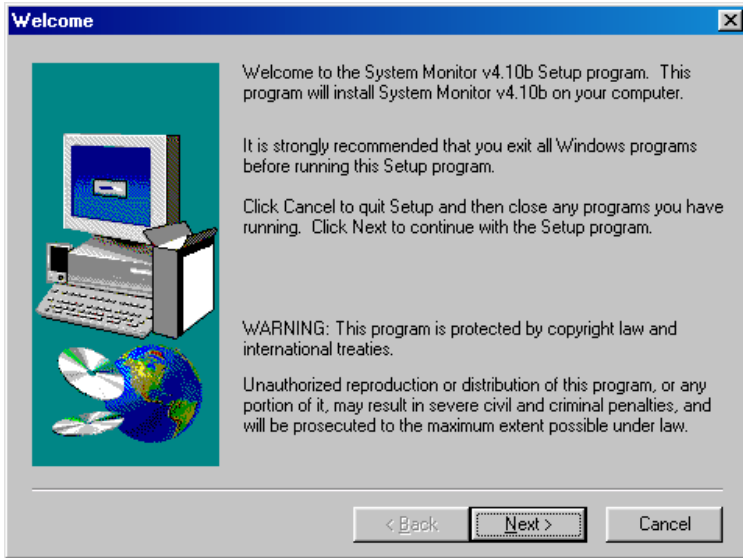

3. Choose the destination location where System Monitor will be installed. Click **Next** to continue Setup.



4. Click **Next** to agree with the settings shown and to begin copying files.

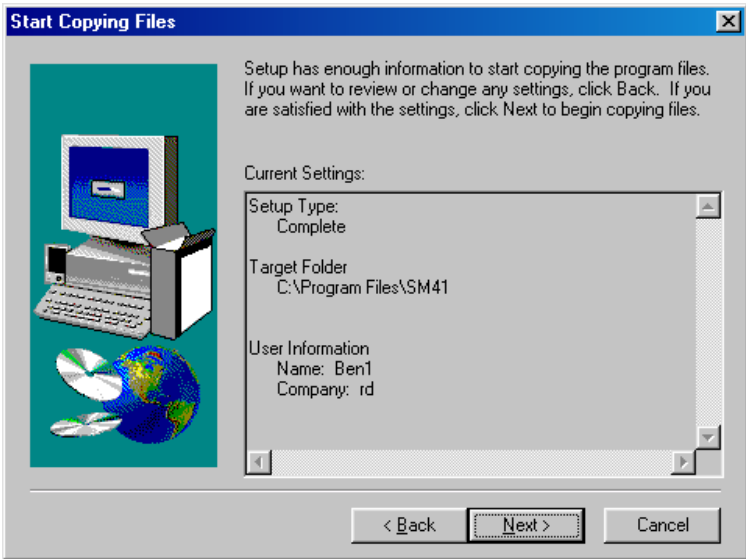

5. Click **Yes** to restart your computer to be able to use the program.

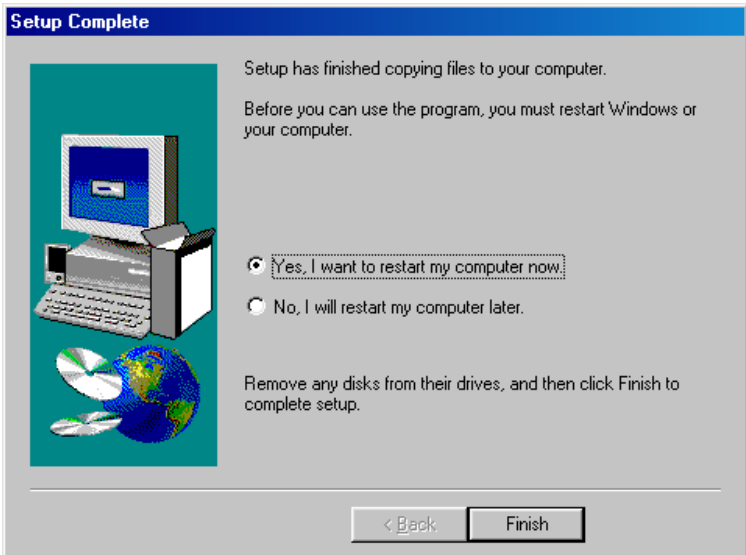

Appendix

A. Additions & Errata

The manufacturer sees to it that the most up-to-date and accurate information are contained in this manual. This section would contain page insert(s) of additional information, updates or corrections that the user should know to ensure that proper configuration and setup of the motherboard is made.