

ASUS[®] MES-N
Socket 370 NLX Motherboard

USER'S MANUAL

USER'S NOTICE

No part of this manual, including the products and software described in it, may be reproduced, transmitted, transcribed, stored in a retrieval system, or translated into any language in any form or by any means, except documentation kept by the purchaser for backup purposes, without the express written permission of ASUSTeK COMPUTER INC. ("ASUS").

ASUS PROVIDES THIS MANUAL "AS IS" WITHOUT WARRANTY OF ANY KIND, EITHER EXPRESS OR IMPLIED, INCLUDING BUT NOT LIMITED TO THE IMPLIED WARRANTIES OR CONDITIONS OF MERCHANTABILITY OR FITNESS FOR A PARTICULAR PURPOSE. IN NO EVENT SHALL ASUS, ITS DIRECTORS, OFFICERS, EMPLOYEES OR AGENTS BE LIABLE FOR ANY INDIRECT, SPECIAL, INCIDENTAL, OR CONSEQUENTIAL DAMAGES (INCLUDING DAMAGES FOR LOSS OF PROFITS, LOSS OF BUSINESS, LOSS OF USE OR DATA, INTERRUPTION OF BUSINESS AND THE LIKE), EVEN IF ASUS HAS BEEN ADVISED OF THE POSSIBILITY OF SUCH DAMAGES ARISING FROM ANY DEFECT OR ERROR IN THIS MANUAL OR PRODUCT.

Product warranty or service will not be extended if: (1) the product is repaired, modified or altered, unless such repair, modification or alteration is authorized in writing by ASUS; or (2) the serial number of the product is defaced or missing.

Products and corporate names appearing in this manual may or may not be registered trademarks or copyrights of their respective companies, and are used only for identification or explanation and to the owners' benefit, without intent to infringe.

- SiS is a trademark of Silicon Integrated Corporation.
- Intel, Celeron, LANDesk, and Pentium are trademarks of Intel Corporation.
- IBM and OS/2 are registered trademarks of International Business Machines.
- Symbios is a registered trademark of Symbios Logic Corporation.
- Windows and MS-DOS are registered trademarks of Microsoft Corporation.
- Adobe and Acrobat are registered trademarks of Adobe Systems Incorporated.
- YAMAHA, DS-XG, XGstudio, Ystation32 are trademarks of Yamaha Corporation.

The product name and revision number are both printed on the product itself. Manual revisions are released for each product design represented by the digit before and after the period of the manual revision number. Manual updates are represented by the third digit in the manual revision number.

For previous or updated manuals, BIOS, drivers, or product release information, contact ASUS at <http://www.asus.com.tw> or through any of the means indicated on the following page.

SPECIFICATIONS AND INFORMATION CONTAINED IN THIS MANUAL ARE FURNISHED FOR INFORMATIONAL USE ONLY, AND ARE SUBJECT TO CHANGE AT ANY TIME WITHOUT NOTICE, AND SHOULD NOT BE CONSTRUED AS A COMMITMENT BY ASUS. ASUS ASSUMES NO RESPONSIBILITY OR LIABILITY FOR ANY ERRORS OR INACCURACIES THAT MAY APPEAR IN THIS MANUAL, INCLUDING THE PRODUCTS AND SOFTWARE DESCRIBED IN IT.

Copyright © 1999 ASUSTeK COMPUTER INC. All Rights Reserved.

Product Name:	ASUS MES-N
Manual Revision:	1.01 E392
Release Date:	July 1999

ASUS CONTACT INFORMATION

ASUSTeK COMPUTER INC. (Asia-Pacific)

Marketing

Address: 150 Li-Te Road, Peitou, Taipei, Taiwan 112
Telephone: +886-2-2894-3447
Fax: +886-2-2894-3449
Email: info@asus.com.tw

Technical Support

Tel (English): +886-2-2894-3447 ext. 706
Tel (Chinese): +886-2-2894-3447 ext. 111
Fax: +886-2-2895-9254
Email: tsd@asus.com.tw
Newsgroup: news2.asus.com.tw
WWW: www.asus.com.tw
FTP: ftp.asus.com.tw/pub/ASUS

ASUS COMPUTER INTERNATIONAL (America)

Marketing

Address: 6737 Mowry Avenue, Mowry Business Center, Building 2
Newark, CA 94560, USA
Fax: +1-510-608-4555
Email: info-usa@asus.com.tw

Technical Support

Fax: +1-510-608-4555
BBS: +1-510-739-3774
Email: tsd-usa@asus.com.tw
WWW: www.asus.com
FTP: ftp.asus.com.tw/pub/ASUS

ASUS COMPUTER GmbH (Europe)

Marketing

Address: Harkort Str. 25, 40880 Ratingen, BRD, Germany
Telephone: 49-2102-445011
Fax: 49-2102-442066
Email: sales@asuscom.de

Technical Support

Hotline: 49-2102-499712
BBS: 49-2102-448690
Email: tsd@asuscom.de
WWW: www.asuscom.de
FTP: ftp.asuscom.de/pub/ASUSCOM

CONTENTS

1. INTRODUCTION	7
1.1 How This Manual Is Organized	7
1.2 Item Checklist	7
2. FEATURES	8
2.1 The ASUS MES-N Motherboard	8
2.1.1 Specifications	8
2.1.2 Performance	9
2.1.3 Intelligence	10
2.2 Motherboard Parts	11
3. HARDWARE SETUP	12
3.1 Motherboard Layout	12
3.2 Riser Card Parts & Layout	14
3.3 Hardware Setup Procedure	17
3.4 Motherboard Settings	17
3.5 System Memory (DIMM)	24
3.5.1 General DIMM Notes	24
3.5.2 DIMM Memory Installation	25
3.6 Central Processing Unit (CPU)	26
3.7 Expansion Cards	27
3.7.1 Expansion Card Installation Procedure	27
3.7.2 Assigning IRQs for Expansion Cards	27
3.7.3 Assigning DMA Channels for ISA Cards	28
3.8 External Connectors	29
3.8.1 Back Panel Connectors	29
3.8.2 Midboard Connectors	32
3.8.3 Riser Card Connectors	35
3.9 Power Connection Procedures	41
4. BIOS SETUP	42
4.1 Flash Memory Writer Utility	42
4.1.1 Main Menu	42
4.1.2 Managing and Updating Your BIOS	44
4.2 BIOS Setup Program	45
4.2.1 BIOS Menu Bar	46
4.2.2 Legend Bar	46
4.3 Main Menu	48

CONTENTS

4.3.1 Primary & Secondary Master/Slave	49
4.4 Advanced	54
4.4.1 Chip Configuration	55
4.4.2 I/O Device Configuration	57
4.4.3 PCI Configuration	59
4.4.4 Shadow Configuration	62
4.5 Power Menu	63
4.5.1 Power Up Control	65
4.5.2 Hardware Monitor	66
4.6 Boot Menu	67
4.7 Exit Menu	69
5. SOFTWARE SETUP	71
5.1 Operating Systems	71
5.1.1 Windows 98 First Time Installation	71
5.2 MES-N Support CD	72
5.2.1 Installation Menu	72
5.3 Install ASUS PC Probe Vx.xx	73
5.4 Install Bus Master IDE Driver	74
5.5 Install VGA Driver	75
For Windows 95	76
5.6 Install Audio Driver (only with onboard audio option)	76
5.7 Install YAMAHA XG-STUDIO	77
5.8 Install YAMAHA YSTATION32	78
5.9 Install Network Driver	79
5.10 Install PC-Cillin 98 Vx.xx	80
5.11 Install ADOBE AcroBat Reader Vx.x	81
5.12 Uninstalling Programs	82
6. SOFTWARE REFERENCE	83
6.1 ASUS PC Probe	83
6.2 SiS 620 Display Properties	89
6.3 Using YAMAHA XGstudio Player	93
6.4 Using YAMAHA XGstudio Mixer	95
6.5 YSTATION32	97
7. APPENDIX	103
7.1 ASUS PCI-L101 Fast Ethernet Card	103

FCC & DOC COMPLIANCE

Federal Communications Commission Statement

This device complies with FCC Rules Part 15. Operation is subject to the following two conditions:

- This device may not cause harmful interference, and
- This device must accept any interference received, including interference that may cause undesired operation.

This equipment has been tested and found to comply with the limits for a Class B digital device, pursuant to Part 15 of the FCC Rules. These limits are designed to provide reasonable protection against harmful interference in a residential installation. This equipment generates, uses and can radiate radio frequency energy and, if not installed and used in accordance with manufacturer's instructions, may cause harmful interference to radio communications. However, there is no guarantee that interference will not occur in a particular installation. If this equipment does cause harmful interference to radio or television reception, which can be determined by turning the equipment off and on, the user is encouraged to try to correct the interference by one or more of the following measures:

- Re-orient or relocate the receiving antenna.
- Increase the separation between the equipment and receiver.
- Connect the equipment to an outlet on a circuit different from that to which the receiver is connected.
- Consult the dealer or an experienced radio/TV technician for help.

WARNING! Any changes or modifications to this product not expressly approved by the manufacturer could void any assurances of safety or performance and could result in violation of Part 15 of the FCC Rules.

Canadian Department of Communications Statement

This digital apparatus does not exceed the Class B limits for radio noise emissions from digital apparatus set out in the Radio Interference Regulations of the Canadian Department of Communications.

This Class B digital apparatus complies with Canadian ICES-003.

Cet appareil numérique de la classe B est conforme à la norme NMB-003 du Canada.

1. INTRODUCTION

1.1 How This Manual Is Organized

This manual is divided into the following sections:

- | | |
|------------------------------|--|
| 1) INTRODUCTION | Manual information and checklist |
| 2) FEATURES | Product information and specifications |
| 3) HARDWARE SETUP | Instructions on setting up the motherboard |
| 4) BIOS SETUP | Instructions on setting up the BIOS software |
| 5) SOFTWARE SETUP | Instructions on setting up the included software |
| 6) SOFTWARE REFERENCE | Reference material for the included software |
| 7) APPENDIX | Optional items and general reference |

1.2 Item Checklist

Check that your package is complete. If you discover damaged or missing items, please contact your retailer.

1.2.1 Motherboard

- (1) ASUS Motherboard
- (1) Support CD with drivers and utilities
- (1) This Motherboard User's Manual

- (1) NLX form-factor system housing, riser card, and power supply
- ASUS slim CD-ROM (optional)
- LCD panel connector with bracket (for LCD model only)
- ASUS IrDA-compliant infrared module (optional)
- ASUS PCI-L101 Wake-On-LAN 10/100 Fast Ethernet Card (optional)

NOTE: This motherboard only works with ASUS riser cards. See your dealer for more information.

1.2.2 Riser Card

- (1) ASUS Riser Card
- (1) Ribbon cable for master and slave UltraDMA/33 & UltraDMA/66 IDE drives
- (1) Ribbon cable for (1) 3.5" floppy disk drive
- (1) FDC slim CD-ROM cable
- (1) Bag of spare jumper caps

2. FEATURES

2.1 The ASUS MES-N Motherboard

The ASUS MES-N motherboard is carefully designed for the demanding PC user who wants many intelligent features in a small package.

2.1.1 Specifications

- **Intel Processor Support:** Supports Intel's Celeron processor designed for the Socket 370 and packaged in **Plastic Pin Grid Array (PPGA)**.
- **SiS AGPset:** SiS 620 AGPset with built-in 6326 AGP 2X graphics controller supports a 100MHz Front Side Bus (FSB) and UltraDMA/66, which allows burst mode data transfer rates of up to 66.6MB/sec.
- **Enhanced ACPI & Anti-Boot Virus BIOS:** Programmable BIOS (Flash EEPROM), offering enhanced ACPI for Windows 98 compatibility, built-in firmware-based virus protection, and autodetection of most devices for virtually automatic setup.
- **PC100 Memory Support:** Equipped with two DIMM sockets to support Intel PC100-compliant SDRAMs (up to 512MB).
- **100/10Mbps LAN:** Features an onboard Intel 82559 Ethernet LAN Controller (fully integrated 10BASE-T/100BASE-TX) and a LAN Activity LED for monitoring network conditions.
- **Integrated Graphics:** Integrated AGP 2X graphics controller can use shared system memory or optional dedicated onboard VGA memory (up to 8MB SDRAM).
- **Onboard PCI Audio with AC'97 CODEC (optional):** Features Yamaha's PCI audio chip with 3D surround and positioning capability and connected to an audio CODEC that enhances DAC, ADC, and analog mixing quality.
- **Riser Card:** Provides NLX power, IDE, floppy disk drive, LAN wake-up connectors, PCI/ISA slots, and USB/infrared support.
- **Wake-On-LAN Connector:** Supports Wake-On-LAN activity through an optional Ethernet card (see *7.1 ASUS PCI-L101 Fast Ethernet Card*).
- **Super Multi-I/O:** Provides two high-speed UART compatible serial ports and one parallel port with EPP and ECP capabilities.
- **Desktop Management Interface (DMI):** Supports DMI through BIOS, which allows hardware to communicate within a standard protocol creating a higher level of compatibility. (Requires DMI-enabled components.)
- **IrDA:** Supports an optional infrared port module on the riser card for wireless interface.
- **Slim CD-ROM:** Supports an optional ASUS slim CD-ROM drive for ASUS' custom designed NLX form factor.

2. FEATURES

- **UltraDMA/66 & UltraDMA/33:** Comes with an onboard PCI Bus Master IDE controller with two connectors that support four IDE devices on two channels. Supports UltraDMA/66, UltraDMA/33, PIO Modes 3 & 4 and Bus Master IDE DMA Mode 2, and Enhanced IDE devices, such as Tape Backup, CD-ROM, CD-R/RW, and LS-120 drives.

2.1.2 Performance

- **66/100MHz Asynchronous & 100/100MHz Synchronous Host/DRAM Clock Support:** CPU frequency can operate at 66MHz or 100MHz while system memory operates at 100MHz or 66MHz. This can optimize the VGA performance under shared memory configuration.
- **High-Speed Data Transfer Interface:** This motherboard with its chipset and support for Ultra DMA/66 doubles the Ultra DMA/33 burst transfer rate to 66.6MB/s. Ultra DMA/66 is backward compatible with both DMA/33 and DMA and with existing DMA devices and systems so there is no need to upgrade current EIDE/IDE drives and host systems. (Ultra DMA/66 requires a 40-pin 80-conductor cable to be enabled and/or for Ultra DMA Mode 4.)
- **Concurrent PCI:** Concurrent PCI allows multiple PCI transfers from PCI master buses to memory to CPU.
- **SDRAM Optimized Performance:** ASUS smart series motherboards support the new generation memory, Synchronous Dynamic Random Access Memory (SDRAM), which increases the data transfer rate to 800MB/s max using PC100-compliant SDRAM.
- **ACPI Ready:** ACPI (Advanced Configuration and Power Interface) is also implemented on all ASUS smart series motherboards. ACPI provides more Energy Saving Features for future operating systems (OS) supporting OS Direct Power Management (OSPM) functionality. With these features implemented in the OS, PCs can be ready around the clock, yet satisfy all the energy saving standards. To fully utilize the benefits of ACPI, an ACPI-supported OS, such as Windows 98, must be used.
- **PC'98 Compliant:** Both the BIOS and hardware levels of the motherboard meets PC'98 compliancy. The new PC'98 requirements for systems and components are based on the following high-level goals: Support for Plug and Play compatibility and power management for configuring and managing all system components, and 32-bit device drivers and installation procedures for Windows 95/98/NT.

2. FEATURES

2.1.3 Intelligence

- **Fan Status Monitoring and Alarm:** To prevent system overheat and system damage, the CPU, power supply, and system fans can be monitored for RPM and failure. All the fans are set for its normal RPM range and alarm thresholds.
- **Temperature Monitoring and Alert:** To prevent system overheat and system damage, this motherboard supports Socket 370 processor thermal sensing.
- **Voltage Monitoring and Alert:** System voltage levels are monitored to ensure stable current to critical motherboard components. Voltage specifications are more critical for future processors, so monitoring is necessary to ensure proper system configuration and management.
- **System Resources Alert:** Today's operating systems such as Windows 95/98/NT, and OS/2, require much more memory and hard drive space to present enormous user interfaces and run large applications. The system resource monitor will warn the user before the system resources are used up to prevent possible application crashes. Suggestions will give the user information on managing their limited resources more efficiently.
- **Auto Fan Off:** The system fans will power off automatically **even in sleep mode**. This function reduces both energy consumption and **system noise**, and is an important feature to implement silent PC systems.
- **Remote Ring On (requires modem):** This allows a computer with this motherboard to be turned on remotely through an internal or external modem. With this feature, users can access their computer from anywhere in the world!
- **Message LED (requires ACPI OS support):** Chassis LEDs now act as information providers. Through the way a particular LED illuminates, the user can determine the stage the computer is in. A simple glimpse provides useful information to the user.
- **Keyboard Wake Up:** Keyboard Wake Up can be enabled or disabled to allow the computer to be powered ON using your keyboard.

2. FEATURES

2.2 Motherboard Parts

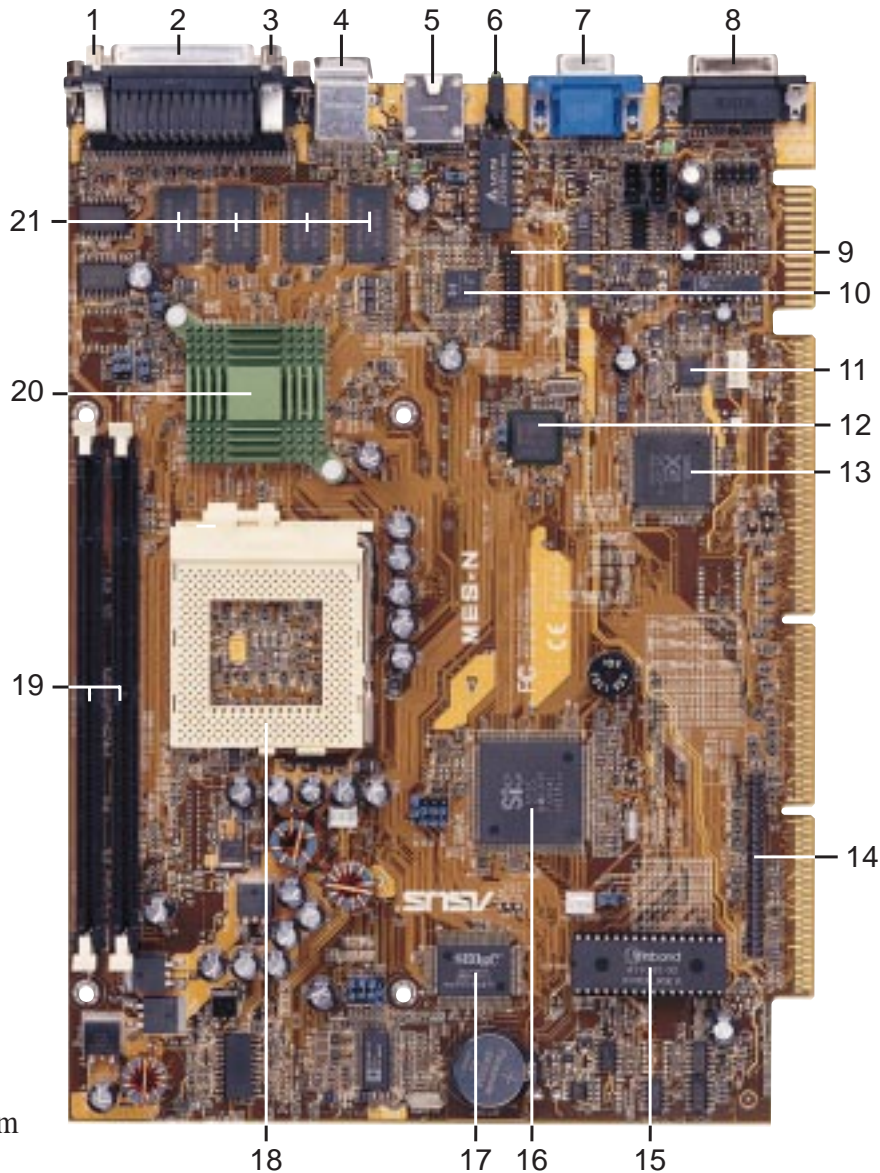

T: Top
B: Bottom

- | | |
|---|--|
| 1 COM1 Connector (B) | 12 LAN Controller Chip (optional) |
| 2 Parallel Connector (T) | 13 Yamaha Audio Chip (on audio model only) |
| 3 COM2 Connector (B) | 14 Slim CD-ROM Connector |
| 4 PS/2 Mouse (T)/Keyboard (B) Connector | 15 Programmable Flash EEPROM |
| 5 RJ-45 Connector | 16 SiS South Bridge
with Integrated Hardware Monitoring |
| 6 LAN LED | 17 Multi-I/O Chip |
| 7 VGA Connector | 18 CPU ZIF Socket 370 |
| 8 Joystick/MIDI Connector | 19 DIMM Sockets |
| 9 LCD Header (w/ LCD Chip onboard) | 20 SiS Chipset with Heatsink |
| 10 LCD Chip (optional) | 21 Optional VGA Memory (up to 8MB) |
| 11 Audio CODEC (optional) | |

3. HARDWARE SETUP

3.1 Motherboard Layout

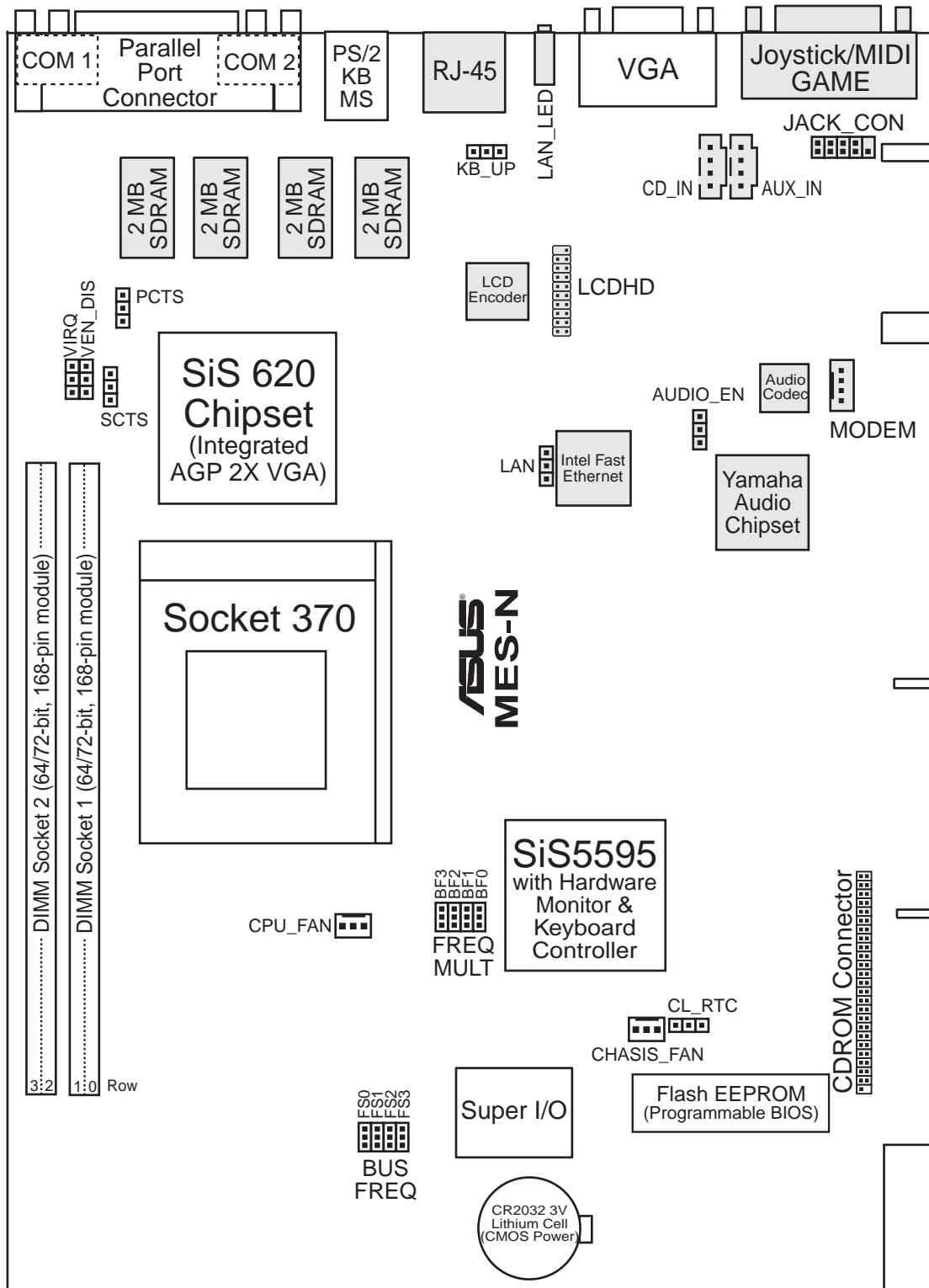

Grayed items are optional at the time of purchase.

3. HW SETUP
Motherboard Layout

3. HARDWARE SETUP

Motherboard Settings

- | | |
|-----------------------|---|
| 1) KB_UP | p.18 Keyboard Wake Up Setting (Enable/Disable) |
| 2) VEN_DIS | p.18 Onboard VGA Setting (Enable/Disable) |
| 3) VIRQ | p.19 VGA IRQ Setting (Enable/Disable) |
| 4) AUDIOEN | p.19 Onboard Audio Setting (Enable/Disable) |
| 5) LAN | p.20 Onboard LAN Setting (Enable/Disable) |
| 6) PCTS | p.20 Primary Cable Type Status (80 pin/40 pin) |
| 7) SCTS | p.21 Secondary Cable Type Status (80 pin/40 pin) |
| 8) FS0, FS1, FS2, FS3 | p.22 CPU External Frequency Setting |
| 9) BF0, BF1, BF2, BF3 | p.23 CPU Core:External Frequency Multiple Setting |
| 10) CL_RTC | p.53 CMOS RTC RAM Setting |

Sockets

- | | |
|-----------------|---|
| 1) DIMM1, DIMM2 | p.24 168-Pin DIMM Memory Support |
| 2) Socket 370 | p.26 Central Processing Unit (CPU) Socket |

Back Panel Connectors

- | | |
|--------------|---|
| 1) PARALLEL | p.29 Parallel Port Connector (25-pin female) |
| 2) COM1/COM2 | p.29 Serial Port Connector (Two 9-pin male) |
| 3) PS2KBMS | p.30 PS/2 Mouse Port Connector (6-pin female) |
| 4) PS2KBMS | p.30 PS/2 Keyboard Port Connector (6-pin female) |
| 5) RJ-45 | p.30 Fast-Ethernet Port Connector (optional) |
| 6) LAN_LED | p.30 LAN Diagnostic LEDs |
| 7) VGA | p.31 Monitor (VGA) Output Connector (15-pin female) |
| 8) GAME | p.31 Joystick/MIDI Connector (15-pin female) (optional) |

Midboard Connectors

- | | |
|--------------------------|--|
| 1) CHASIS_, CPU_FAN | p.32 Chassis & CPU Fan Connectors (Two 3 pins) |
| 2) CDROM | p.32 CDROM Connector (50-1 pins) |
| 3) CD_IN/AUX_IN/MODEM_IN | p.33 Internal Audio Connectors (Four 4 pins) |
| 4) JACK_CON | p.33 Audio Jack Connector (10-1 pins) |
| 5) LCDHD | p.34 LCD Output Header (20-1 pins) |

3. HARDWARE SETUP

3.2 Riser Card Layout

3.2.1 NLX-R

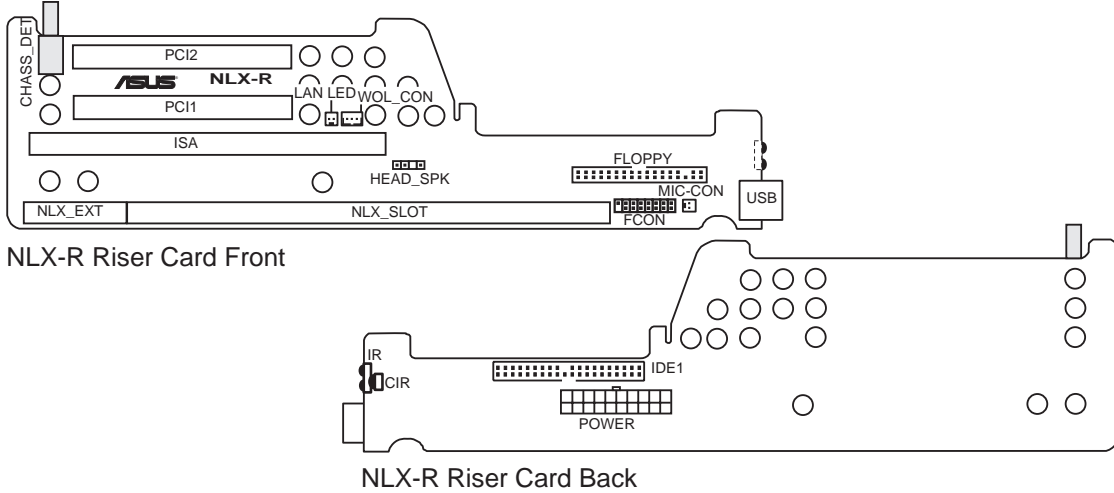

3.2.2 B9-N

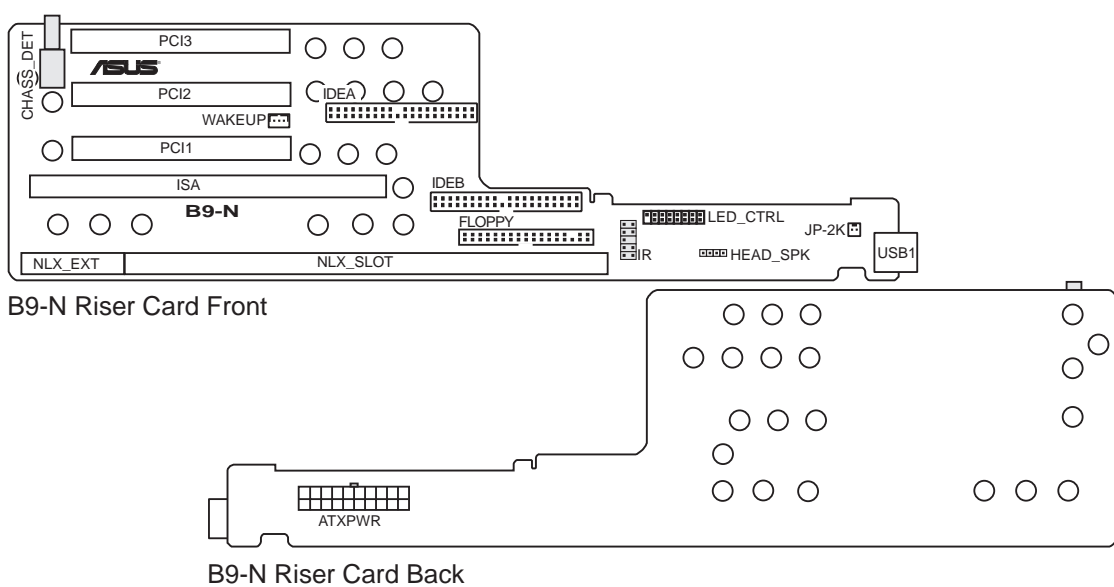

3.2.3 Yeong-Yang

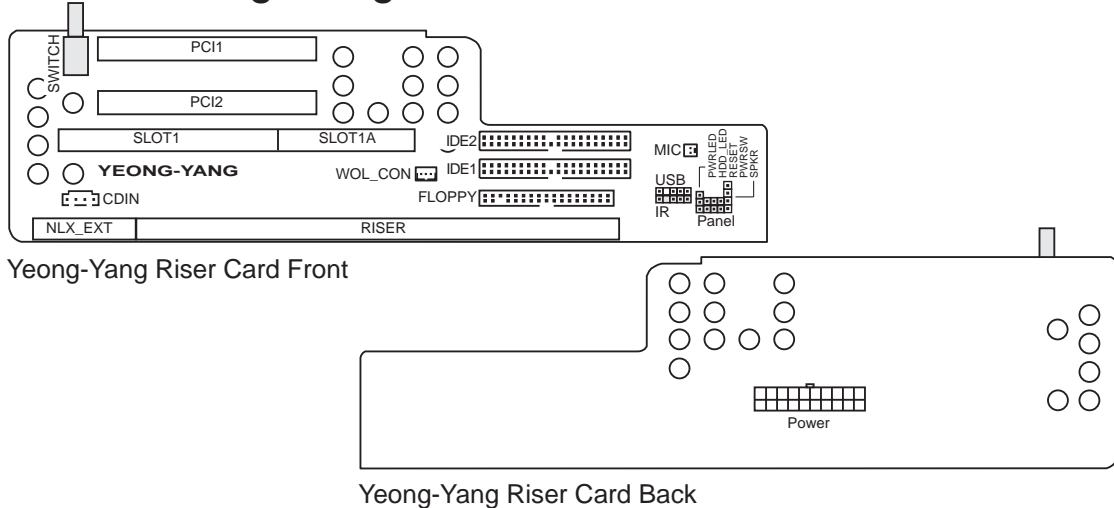

3. HW SETUP
Riser Card Parts & Layout

3. HARDWARE SETUP

Expansion Slots

- | | | |
|-------------------------|------|--------------------------------|
| 1) ISA (NLX-R) | p.27 | 16-bit ISA Bus Expansion Slot |
| ISA (B9-N) | | 16-bit ISA Bus Expansion Slot |
| SLOT1/1A (Yeong-Yang) | | 16-bit ISA Bus Expansion Slot |
| 2) PCI1, PCI2 (NLX-R) | p.27 | 32-bit PCI Bus Expansion Slots |
| PCI1, PCI2, PCI3 (B9-N) | | 32-bit PCI Bus Expansion Slots |
| PCI1, PCI2 (Yeong-Yang) | | 32-bit PCI Bus Expansion Slots |

Connectors

- | | | |
|--------------------------|------|--|
| 1) LAN_LED (NLX-R) | p.35 | LAN Activity Connector (2 pins) |
| WOL_CON (NLX-R) | | LAN Activity Connector (3 pins) |
| WAKEUP (B9-N) | | LAN Activity Connector (3 pins) |
| WOL_CON (Yeong-Yang) | | LAN Activity Connector (3 pins) |
| 2) MIC-CON (NLX-R) | p.35 | Front Panel Microphone Connector (2 pins) |
| JP-2K (B9-N) | | Front Panel Microphone Connector (2 pins) |
| MIC (Yeong-Yang) | | Front Panel Microphone Connector (2 pins) |
| 3) POWER (NLX-R) | p.36 | NLX Power Supply Connector (20 pins) |
| ATXPWR (B9-N) | | NLX Power Supply Connector (20 pins) |
| Power (Yeong-Yang) | | NLX Power Supply Connector (20 pins) |
| 4) IDE1 (NLX-R) | p.36 | IDE Connector (40-1 pins) |
| IDEA, IDEB (B9-N) | | IDE Connectors (40-1 pins) |
| IDE1, IDE2 (Yeong-Yang) | | IDE Connectors (40-1 pins) |
| 5) FLOPPY (NLX-R) | p.37 | 3.5" Floppy Disk Drive Connector (34-1 pins) |
| FLOPPY (B9-N) | | 3.5" Floppy Disk Drive Connector (34-1 pins) |
| FLOPPY (Yeong-Yang) | | 3.5" Floppy Disk Drive Connector (34-1 pins) |
| 6) USB (NLX-R) | p.37 | Universal Serial Bus (USB) Ports (Two 4-pin sockets) |
| USB1 (B9-N) | | Universal Serial Bus (USB) Ports (Two 4-pin sockets) |
| USB (Yeong-Yang) | | USB Module Connector (5-1 pins) |
| 7) IR, CIR (NLX-R) | p.38 | IrDA-Compliant Infrared Module (Lenses) |
| IR (B9-N) | | Infrared Module Connector (10-1 pins) |
| IR (Yeong-Yang) | | Infrared Module Connector (5-1 pins) |
| 8) CDIN (Yeong-Yang) | p.39 | Stereo Audio In Connector (4 pins) |
| 9) FCON/HEAD_SPK (NLX-R) | p.39 | Front Panel Connector (16-1 pins) |
| LED_CIRLHEAD_SPK (B9-N) | | Front Panel Connector (16-1 pins) |
| Panel (Yeong-Yang) | | Front Panel Connectors (13 pins) |

(This page was intentionally left blank.)

3. HARDWARE SETUP

3.3 Hardware Setup Procedure

NOTE: The following procedure assumes that you have already installed the motherboards in an appropriate housing or case.

Before using your computer, you must complete the following steps:

1. **Check Motherboard Settings**
2. **Install Memory Modules**
3. **Install the Central Processing Unit (CPU)**
4. **Install Expansion Cards**
5. **Connect Ribbon Cables, Panel Wires, and Power Supply**

3.4 Motherboard Settings

This section explains in detail how to change your motherboard's function settings through the use of switches and/or jumpers.

WARNING! Computer motherboards and expansion cards contain very delicate Integrated Circuit (IC) chips. To protect them against damage from static electricity, you should follow some precautions whenever you work on your computer.

1. Unplug your computer when working on the inside.
2. Use a grounded wrist strap before handling computer components. If you do not have one, touch both of your hands to a safely grounded object or to a metal object, such as the power supply case.
3. Hold components by the edges and try not to touch the IC chips, leads or connectors, or other components.
4. Place components on a grounded antistatic pad or on the bag that came with the component whenever the components are separated from the system.

3. HARDWARE SETUP

1) Keyboard Power Up Setting (3-pin KB_UP)

This allows you to disable or enable the keyboard power up function. Set this jumper to *Enable* if you wish to use your keyboard (by pressing any key or the spacebar depending on your motherboard) to power up your computer. This feature requires an NLX power supply that can supply at least 300mA on the +5VSB lead. The default is set to *Disable* because not all computers have the appropriate NLX power supply. Your computer will not power ON if you set this to *Enable* and do not have the appropriate NLX power supply.

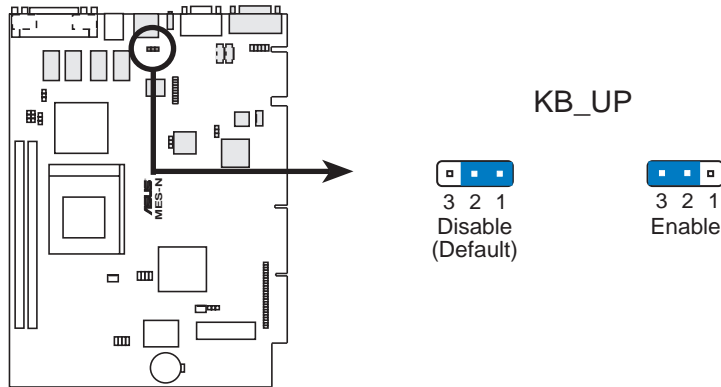

MES-N Keyboard Wake Up

2) Onboard VGA Setting (VEN_DIS)

The onboard AGP VGA may be enabled or disabled using this switch. Disable the onboard VGA if you are using a VGA card on the expansion slot.

Setting	VEN_DIS
Enable	[2-3] (default)
Disable	[1-2]

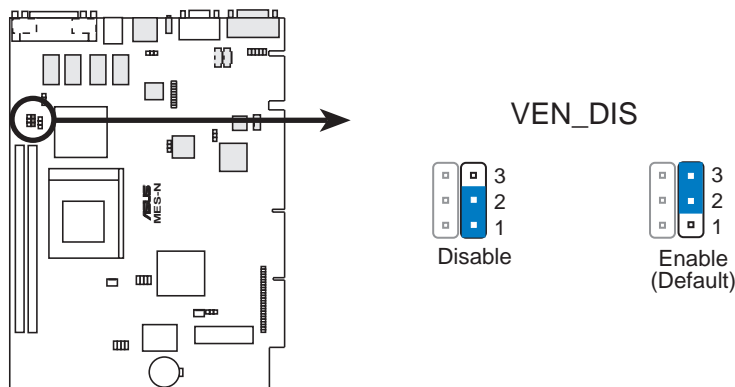

MES-N Onboard VGA Setting

3. HARDWARE SETUP

3) VGA IRQ Setting (VIRQ)

VIRQ allows you to set the VGA interrupt method. Some TV tuners or MPEG cards may require the interrupt to be assigned by the onboard chipset, in which case VIRQ must be enabled (default setting). The default enables the chipset's internal interrupt routing.

<u>Setting</u>	<u>VIRQ</u>
Enable	[2-3] (default)
Disable	[1-2]

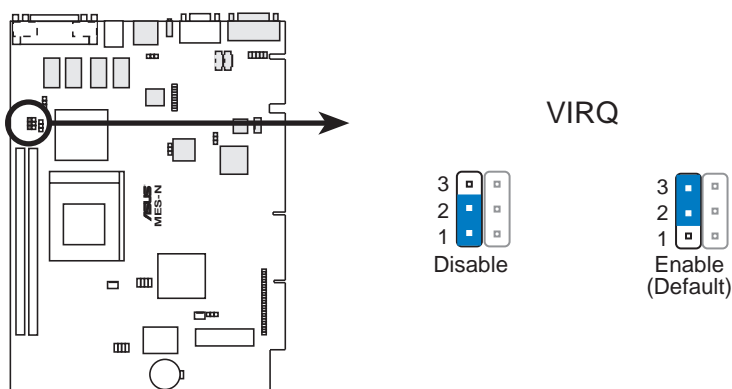

MES-N Onboard VGA IRQ Setting

4) Onboard Audio Setting (AUDIOEN)

The onboard 32-bit PCI audio may be enabled or disabled using this jumper. Disable the onboard audio if you are using an audio card on the expansion slot. **NOTE:** This setting is available only on motherboards with the onboard audio option.

<u>Setting</u>	<u>AUDIOEN</u>
Enable	[2-3] (default)
Disable	[1-2]

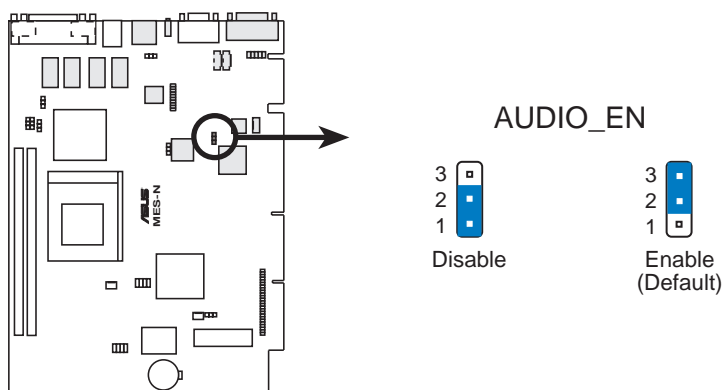

MES-N Onboard Audio Setting

3. HARDWARE SETUP

5) Onboard LAN Setting (LAN_EN) available on LAN model only

The onboard LAN may be enabled or disabled by this jumper.

<u>Setting</u>	<u>LAN_EN</u>
Enable	[1-2] (default)
Disable	[2-3]

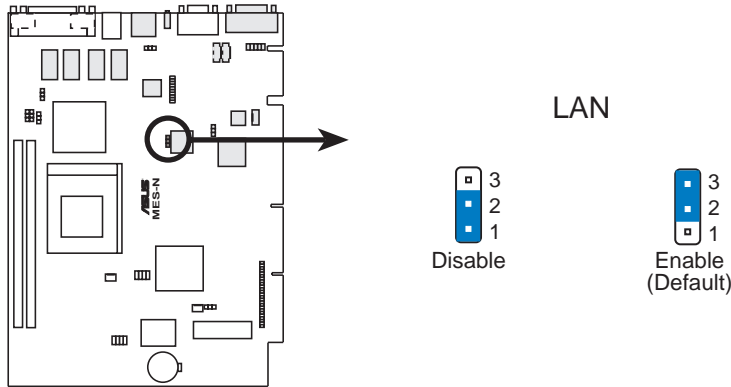

MES-N Onboard LAN Setting

6) Primary Cable Type Status (PCTS)

Setting this jumper to 80-pin will allow an UltraDMA/66 IDE device that is connected to the primary IDE connector with a 40-pin 80-conductor IDE cable to handle transfer rates up to 66MB/s.

<u>Setting</u>	<u>PCTS</u>
40 pin	[2-3] (default)
80 pin	[1-2]

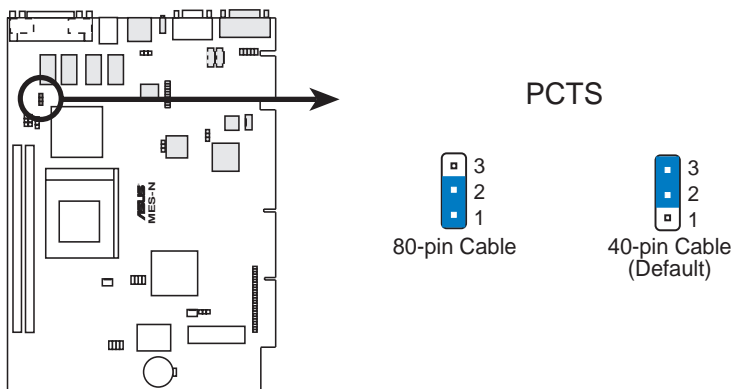

MES-N Primary Cable Type Status

3. HARDWARE SETUP

7) Secondary Cable Type Status (SCTS)

Setting this jumper to *80-pin* will allow an UltraDMA/66 IDE device that is connected to the secondary IDE connector with a 40-pin 80-conductor IDE cable to handle transfer rates up to 66MB/s.

<u>Setting</u>	<u>SCTS</u>
40 pin	[2-3] (default)
80 pin	[1-2]

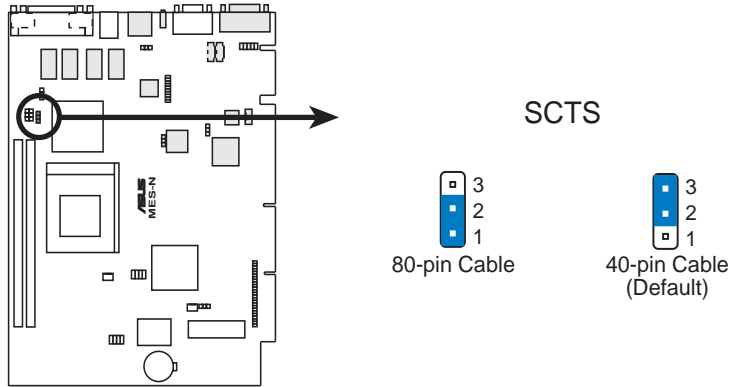

MES-N Secondary Cable Type Status

3. HARDWARE SETUP

8) CPU External Frequency Setting (FS0, FS1, FS2, FS3)

This option tells the clock generator what frequency to send to the CPU, DRAM, and the AGPset. This allows the selection of the CPU's *External* frequency. The CPU external frequency multiplied by the Frequency Multiple equals the CPU's *Internal* frequency (the advertised CPU speed). **NOTE:** You may set the memory speed independently from the CPU external frequency. Depending on your memory type PC66 (66MHz) or PC100 (100MHz), select the appropriate "RAM" speed along with the appropriate "CPU" speed.

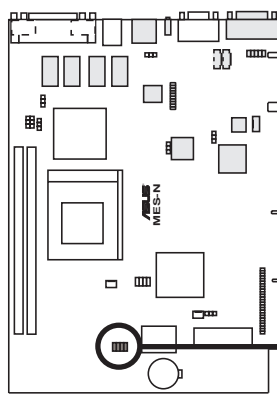

MES-N CPU External Frequency Setting

Mode	FS0	FS1	FS2	FS3
Sync	HOST → 66.6MHz	75.0MHz	83.3MHz	95.0MHz
	SDRAM → 66.6MHz	75.0MHz	83.3MHz	95.0MHz
	PCI → 33.0MHz	30.0MHz	33.0MHz	31.7MHz
Sync	HOST → 100.0MHz	112MHz	124MHz	133MHz
	SDRAM → 100.0MHz	112MHz	124MHz	133MHz
	PCI → 33.3MHz	37.3MHz	31MHz	33MHz
Async	HOST → 66.7MHz	90MHz	95.0MHz	100.0MHz
	SDRAM → 100.0MHz	90MHz	63.3MHz	75.0MHz
	PCI → 33.3MHz	30MHz	31.7MHz	30.0MHz
Async	HOST → 100.0MHz	112.0MHz	124.0MHz	133.0MHz
	SDRAM → 66.7MHz	74.7MHz	82.7MHz	88.9MHz
	PCI → 33.3MHz	37.3MHz	31.0MHz	33.0MHz

3. HARDWARE SETUP

9) CPU Core:External Frequency Multiple Setting (BF0, BF1, BF2, BF3)

This option sets the frequency multiple between the *Internal* frequency of the CPU and the CPU's *External* frequency. These must be set in conjunction with the *CPU External frequency*.

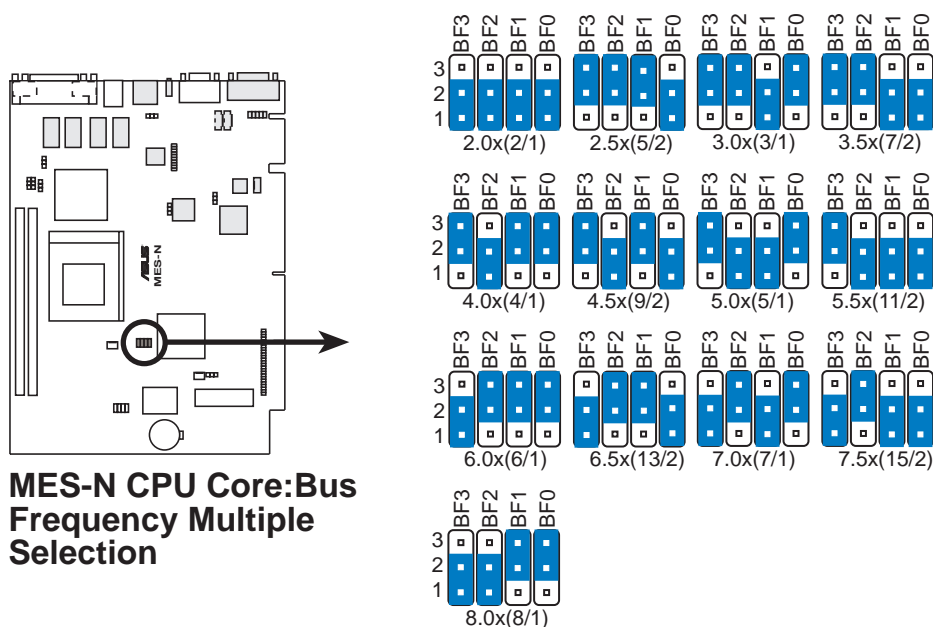

MES-N CPU Core:Bus Frequency Multiple Selection

Set the jumpers by the Internal speed of your processor as follows:

Intel CPU Model	Speed	Mult	Freq.	(CPU External Frequency)				(Frequency Multiple)			
				FS0	FS1	FS2	FS3	BF3	BF2	BF1	BF0
Celeron (PPGA)	500MHz	7.5x	66MHz	[1-2]	[2-3]	[2-3]	[2-3]	[1-2]	[2-3]	[1-2]	[1-2]
Celeron (PPGA)	466MHz	7.0x	66MHz	[1-2]	[2-3]	[2-3]	[2-3]	[1-2]	[2-3]	[1-2]	[2-3]
Celeron (PPGA)	433MHz	6.5x	66MHz	[1-2]	[2-3]	[2-3]	[2-3]	[1-2]	[2-3]	[2-3]	[1-2]
Celeron (PPGA)	400MHz	6.0x	66MHz	[1-2]	[2-3]	[2-3]	[2-3]	[1-2]	[2-3]	[2-3]	[2-3]
Celeron (PPGA)	366MHz	5.5x	66MHz	[1-2]	[2-3]	[2-3]	[2-3]	[2-3]	[1-2]	[1-2]	[1-2]
Celeron (PPGA)	333MHz	5.0x	66MHz	[1-2]	[2-3]	[2-3]	[2-3]	[2-3]	[1-2]	[1-2]	[2-3]
Celeron (PPGA)	300MHz	4.5x	66MHz	[1-2]	[2-3]	[2-3]	[2-3]	[2-3]	[1-2]	[2-3]	[1-2]

WARNING! Frequencies above 100MHz exceed the specifications for the on-board chipset and are not guaranteed to be stable. PCI frequencies above 33MHz exceed the specifications for PCI cards and are not guaranteed to be stable.

For updated processor settings, visit the ASUS web site (see ASUS CONTACT INFORMATION)

3. HARDWARE SETUP

3.5 System Memory (DIMM)

NOTE: No hardware or BIOS setup is required after adding or removing memory. This motherboard uses only Dual Inline Memory Modules (DIMMs). Sockets are available for **3.3Volt** (power level) unbuffered Synchronous Dynamic Random Access Memory (SDRAM).

The SiS chipset does not support ECC. However, ECC memory modules may still be used, but the ECC function will not be available.

Memory speed setup is recommended through **SDRAM Configuration** in **4.4.1 Chip Configuration**.

Install memory in any combination as follows:

DIMM Location	168-pin DIMM		Total Memory
Socket 1 (Rows 0&1)	SDRAM 8, 16, 32, 64, 128, 256MB	x1	
Socket 2 (Rows 2&3)	SDRAM 8, 16, 32, 64, 128, 256MB	x1	
	Total System Memory (Max 512MB)	=	

3.5.1 General DIMM Notes

- **VGA shared memory with one DIMM:** When using only one DIMM as shared memory for the onboard VGA, it must be inserted into Socket 1, leaving Socket 2 empty.
- At the time this User's Manual was written, 256MB DIMMs are either available as registered memory or 128Mbit DIMMs.
- **For the system CPU bus to operate at 100MHz, use only PC100-compliant DIMMs.** When this motherboard operates at 100MHz, most system will not even boot if non-compliant modules are used because of the strict timing issues involved under this speed. If your DIMMs are not PC100-compliant, set the CPU external frequency to 66MHz RAM to ensure system stability. **NOTE:** If your motherboard supports asynchronous mode, set the memory clock frequency to 66MHz.
- ASUS motherboards support SPD (Serial Presence Detect) DIMMs. This is the memory of choice for best performance vs. stability.
- SDRAM chips are generally thinner with higher pin density than EDO (Extended Data Output) chips.
- BIOS shows SDRAM memory on bootup screen.

3. HARDWARE SETUP

3.5.2 DIMM Memory Installation

Insert the module(s) as shown. Because the number of pins are different on either side of the breaks, the module will only fit in the orientation as shown. DIMM modules are longer and have different pin contact on each side and therefore have a higher pin density. SIMM modules have the same pin contact on both sides.

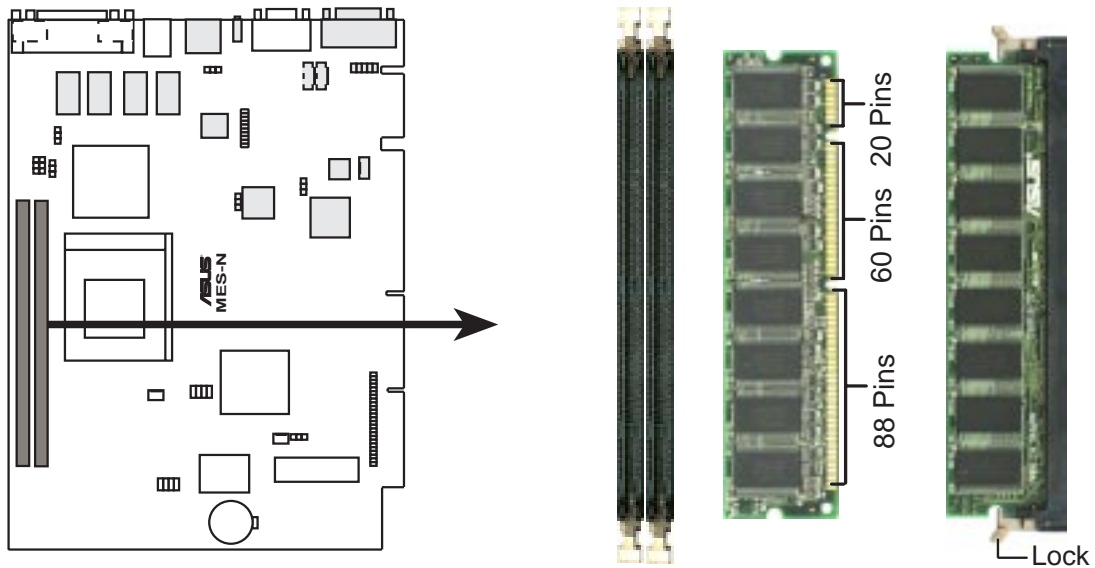

MES-N 168-pin DIMM Memory Sockets

3. HW SETUP
System Memory

The DIMMs must be **3.3V Unbuffered** for this motherboard. To determine the DIMM type, check the notches on the DIMMs (see figure below).

168-Pin DIMM Notch Key Definitions (3.3V)

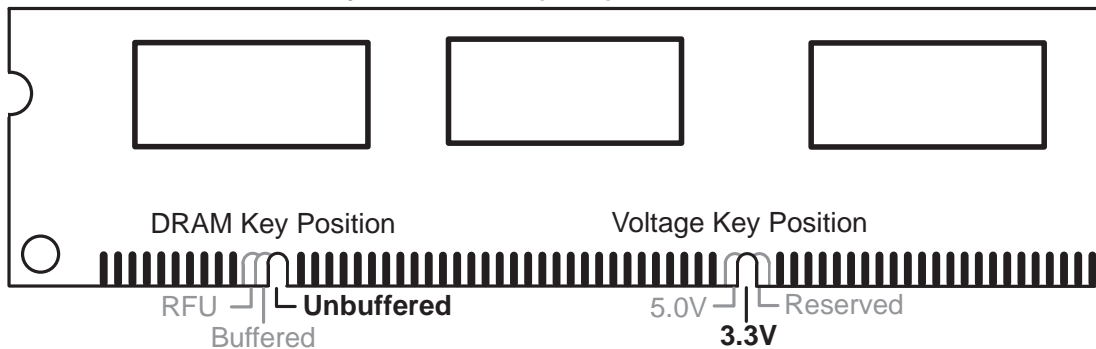

The notches on the DIMM module will shift between left, center, or right to identify the type and also to prevent the wrong type from being inserted into the DIMM slot on the motherboard. You must ask your retailer the correct DIMM type before purchasing. This motherboard supports four clock signals.

3. HARDWARE SETUP

3.6 Central Processing Unit (CPU)

This motherboard provides a ZIF (Zero Insertion Force) Socket 370. The CPU for your motherboard should have a fan attached to it to prevent overheating. If this is not the case, then purchase a fan before you turn on your system.

WARNING! Be sure that there is sufficient air circulation across the processor's heatsink by regularly checking that your CPU fan is working. Without sufficient circulation, the processor could overheat and damage both the processor and the motherboard. You may install an auxiliary fan, if necessary.

To install a CPU, first turn off your system and remove its cover. Locate the ZIF socket and open it by first pulling the lever sideways away from the socket then upwards to a 90-degree angle. Insert the CPU with the correct orientation as shown. The notched corner should point toward the end of the lever. Because the CPU has a corner pin for two of the four corners, the CPU will only fit in the orientation as shown. The picture below is for reference only; you should have a CPU fan that covers the face of the CPU. With the added weight of the CPU fan, no force is required to insert the CPU. Once completely inserted, push the socket's lever down while holding down the CPU.

NOTE: Do not forget to set the correct Bus Frequency and Multiple for your Socket 370 processor or else your system may start. Socket 370 processors provide internal thermal sensing so that a socket mounted thermal resistor is not needed.

CAUTION! Be careful not to scrape the motherboard when mounting a clamp-style processor fan or else damage may occur to the motherboard.

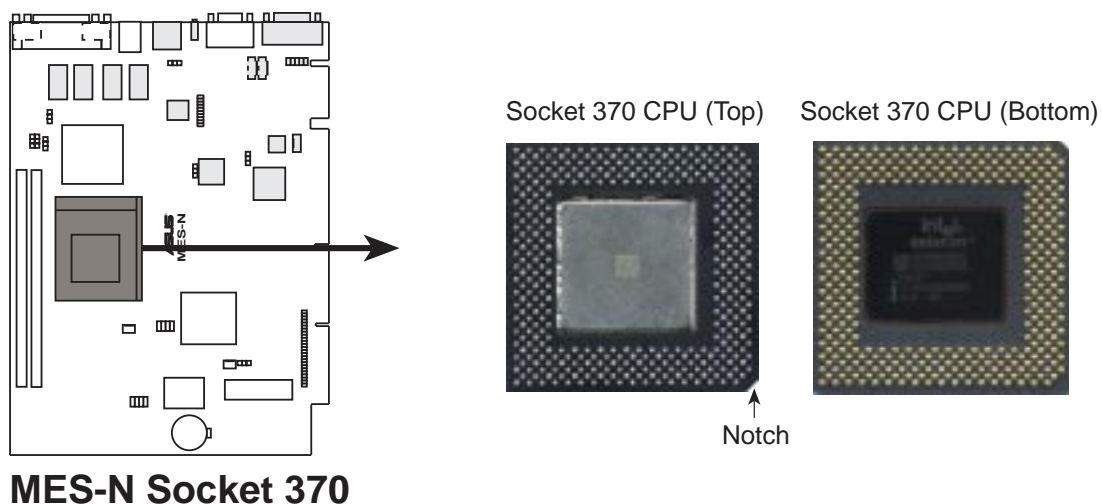

3. HARDWARE SETUP

3.7 Expansion Cards

WARNING! Make sure that you unplug your power supply when adding or removing expansion cards or other system components. Failure to do so may cause severe damage to both your motherboard and expansion cards.

3.7.1 Expansion Card Installation Procedure

1. Read the documentation for your expansion card and make any necessary hardware settings for your expansion card, such as jumpers or switches.
2. Remove your computer system's cover and the bracket plate on the slot you intend to use. Keep the bracket for possible future use.
3. Carefully align the card's connectors and press firmly.
4. Secure the card on the slot with the screw you removed above.
5. Replace the computer system's cover.
6. Set up the BIOS if necessary
(such as *IRQ xx Used By ISA: Yes*)
7. Install the necessary software drivers for your expansion card.

3.7.2 Assigning IRQs for Expansion Cards

Some expansion cards need to use an IRQ to operate. Generally, an IRQ must be exclusively assigned to one use. In a standard design, there are 16 IRQs available but most of them are already in use, leaving 6 IRQs free for expansion cards. If your motherboard has **PCI** audio onboard, an extra IRQ will be used, leaving 5 IRQs free. If your motherboard has **ISA** audio onboard, an extra 3 IRQs will be used, leaving 3 IRQs free.

Both ISA and PCI expansion cards may require IRQs. System IRQs are available to cards installed in the ISA expansion bus first, then any remaining IRQs are available to PCI cards. Currently, there are two types of ISA cards.

The original ISA expansion card design, now referred to as "Legacy" ISA cards, requires that you configure the card's jumpers manually and then install it in any available slot on the ISA bus. To see a map of your used and free IRQs in Windows 98, the Control Panel icon in My Computer, contains a System icon, which gives you a Device Manager tab. Double-clicking on a specific hardware device gives you the Resources tab which shows the Interrupt number and address. Make sure that no two devices use the same IRQ or your computer will experience problems when those two devices are in use at the same time.

3. HARDWARE SETUP

To simplify this process, this motherboard complies with the Plug and Play (PnP) specification, which was developed to allow automatic system configuration whenever a PnP-compliant card is added to the system. For PnP cards, IRQs are assigned automatically from those available.

If the system has both Legacy and PnP ISA cards installed, IRQs are assigned to PnP cards from those not used by Legacy cards. The PCI and PnP configuration of the BIOS setup utility can be used to indicate which IRQs are being used by Legacy cards. For older Legacy cards that do not work with the BIOS, you can contact your vendor for an ISA Configuration Utility.

An IRQ number is automatically assigned to PCI expansion cards after those used by Legacy and PnP ISA cards. In the PCI bus design, the BIOS automatically assigns an IRQ to a PCI slot that has a card in it that requires an IRQ. To install a PCI card, you need to set something called the INT (interrupt) assignment. Since all the PCI slots on this motherboard use an INTA #, be sure that the jumpers on your PCI cards are set to INT A.

3.7.3 Assigning DMA Channels for ISA Cards

Some ISA cards, both legacy and PnP, may also need to use a DMA (Direct Memory Access) channel. DMA assignments for this motherboard are handled the same way as the IRQ assignment process described earlier. To select a DMA channel, see **PCI/PNP ISA DMA Resource Exclusion** in *4.4.3 PCI Configuration*. **NOTE:** The on-board audio by default uses DMA1.

IMPORTANT: To avoid conflicts, reserve the necessary IRQs and DMAs for legacy ISA cards (see **PCI/PNP ISA IRQ Resource Exclusion** and **PCI/PNP DMA IRQ Resource Exclusion** in *4.4.3 PCI Configuration*). Choose *Yes* in **IRQ xx Used By ISA** and **DMA x Used By ISA** for those IRQs and DMAs you want to reserve).

3. HARDWARE SETUP

3.8 External Connectors

WARNING! Some pins are used for connectors or power sources. These are clearly distinguished from jumpers in *3.1 Motherboard Layout*. Placing jumper caps over these connector pins will cause damage to your motherboard.

IMPORTANT: Ribbon cables should always be connected with the red stripe to Pin 1 on the connectors. Pin 1 is usually on the side closest to the power connector on hard drives and CD-ROM drives, but may be on the opposite side on floppy disk drives. Check the connectors before installation because there may be exceptions. IDE ribbon cables must be less than 46 cm (18 in.), with the second drive connector no more than 15 cm (6 in.) from the first connector.

3.8.1 Back Panel Connectors

1) Parallel Connector (25-pin PRINTER)

You can enable the parallel port and choose the IRQ through **Onboard Parallel Port** (see *4.4.2 I/O Device Configuration*). **NOTE:** Serial printers must be connected to the serial port.

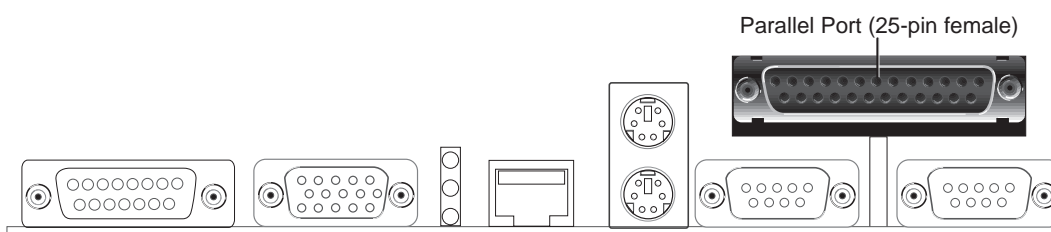

2) Serial Port Connectors (Two 9-pin COM1 and COM2)

The two serial ports can be used for pointing devices or other serial devices. See **Onboard Serial Port 1** and **Onboard Serial Port 2** in *4.2.2 I/O Device Configuration* for settings.

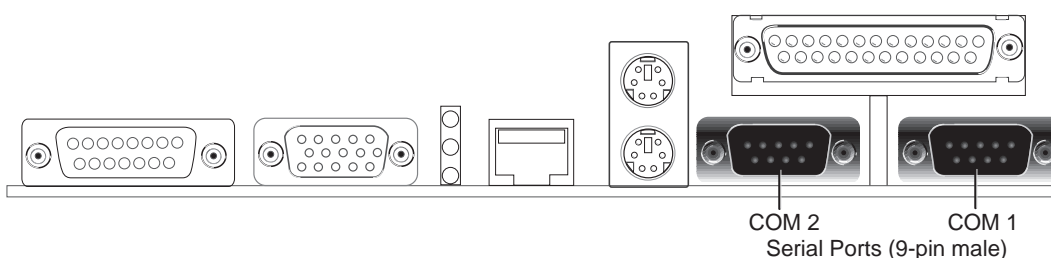

3. HARDWARE SETUP

3) PS/2 Mouse Connector

The system will direct IRQ12 to the PS/2 mouse if one is detected. If not detected, expansion cards can use IRQ12. See **PS/2 Mouse Function Control** in *4.4 Advanced Menu*.

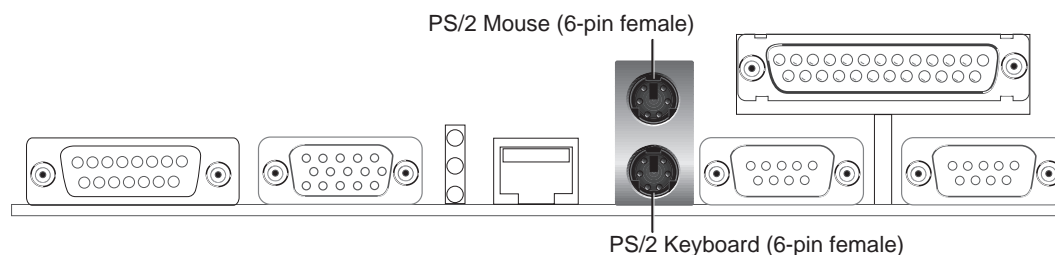

4) PS/2 Keyboard Connector (6-pin PS2KBMS)

This connector is for a standard keyboard using a PS/2 plug (mini DIN). **This connector will not allow standard AT size (large DIN) keyboard plugs. You may use a DIN to mini DIN adapter on standard AT keyboards.**

5) Fast-Ethernet Port Connector (RJ-45)

The RJ-45 connector is optional at the time of purchase. This connector allows the motherboard to connect to a **Local Area Network (LAN)** through a network hub.

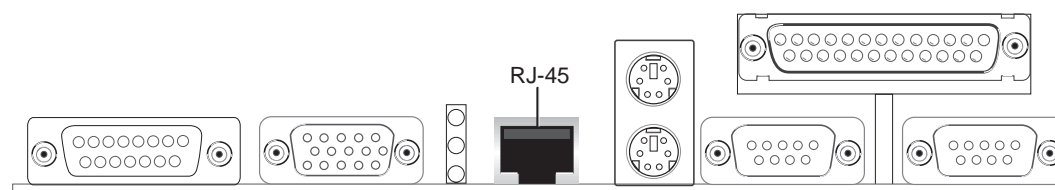

6) LAN Diagnostic LEDs (LAN_LED)

These diagnostic LEDs help indicate if there is a problem with the network connector, cable, or hub.

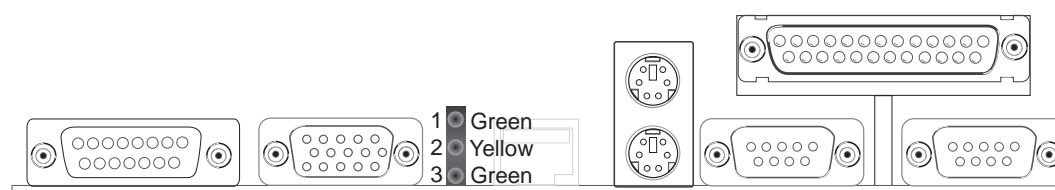

		LED on	LED off
1	Speed	10Mbps	100Mbps
2	Activity	No data	Data transfer
3	Link	Bad connection	Good connection

3. HARDWARE SETUP

7) Monitor Connector (15-pin VGA)

This connector is for output to a VGA-compatible device.

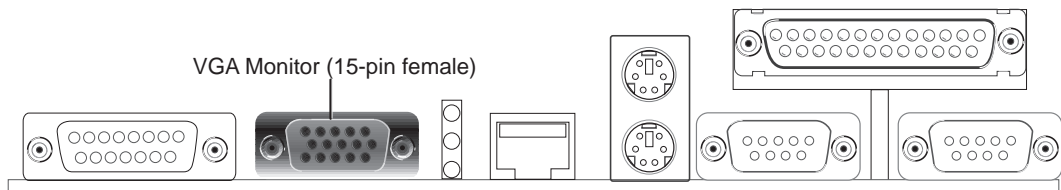

8) Joystick/MIDI Connector (15-pin GAME)

You may connect game joysticks or game pades to this connector for playing games. Connect MIDI devices for playing or editing professional audio.

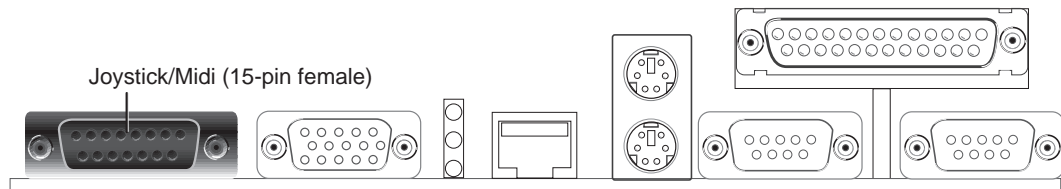

3. HARDWARE SETUP

3.8.2 Midboard Connectors

1) Chassis & CPU Fan Connectors (3-pin CHASIS_, CPU_FAN)

These connectors support cooling fans of 500mA (6 Watts) or less. Orientate the fans so that the heat sink fins allow airflow to go across the onboard heat sink(s) instead of the expansion slots. Depending on the fan manufacturer, the wiring and plug may be different. The red wire should be positive, while the black should be ground. Connect the fan's plug to the board taking into consideration the polarity of the connector. **NOTE: The "Rotation" signal is to be used only by a specially designed fan with rotation signal.**

WARNING! The CPU and/or motherboard will overheat if there is no airflow across the CPU and onboard heatsinks. Damage may occur to the motherboard and/or the CPU fan if these pins are incorrectly used. **These are not jumpers, do not place jumper caps over these pins.**

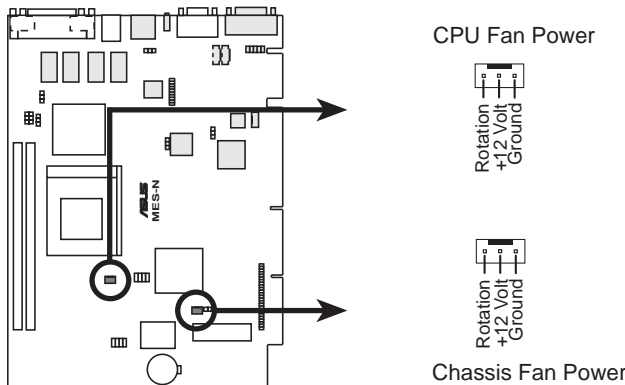

MES-N 12-Volt Cooling Fan Power

2) CD-ROM Connector (50-1 pin CDR0M)

This is a proprietary CD-ROM connector which requires a converter in order to attach to a slim CD-ROM. Only a slim CD-ROM will fit into the NLX system housing.

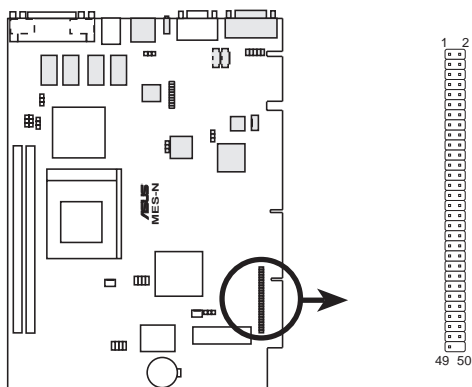

MES-N CD-ROM Drive Connector

3. HARDWARE SETUP

3) Internal Audio Connectors (4-pin CD_IN / AUX_IN)

These connectors allow you to receive stereo audio input from such sound sources as a CD-ROM, TV tuner, or MPEG card.

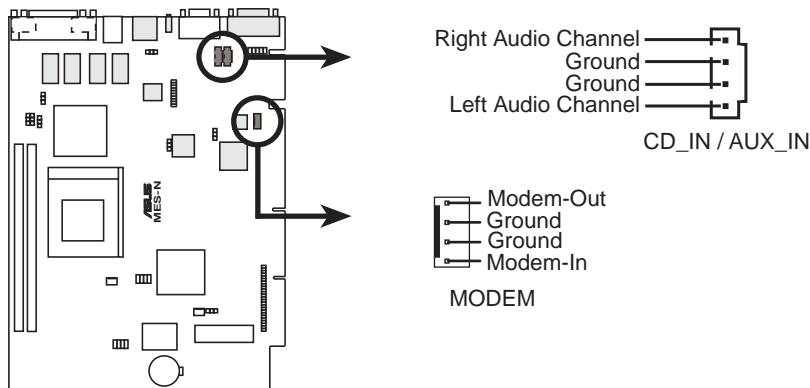

MES-N Internal Audio Connectors

4) Audio Jack Connector (10-1 pin JACK_CON)

This header is provided for audio input and output signals.

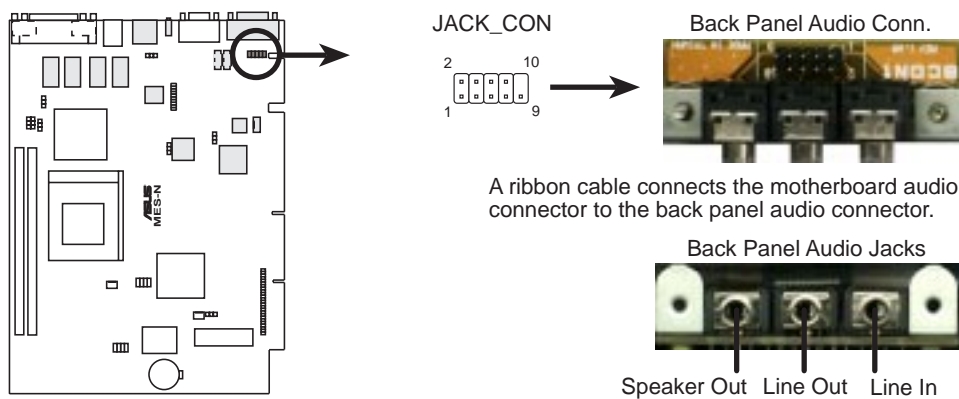

MES-N Audio Jack Connector

3. HARDWARE SETUP

5) LCD Header (20-1 pin LCDHD)

This header requires a digital LCD cable connector. Connect the digital LCD cable to the LCD header and mount the bracket to the chassis on a free expansion slot. **NOTE:** If both CRT and digital LCD monitors are used, the CRT will take precedence. This header is for a digital LCD panel; an analog LCD panel comes with a 15-pin VGA cable connector to be used on the monitor connector. **NOTE:** This connector is available only on motherboards with optional Digital Flat Panel (DFP) interface support.

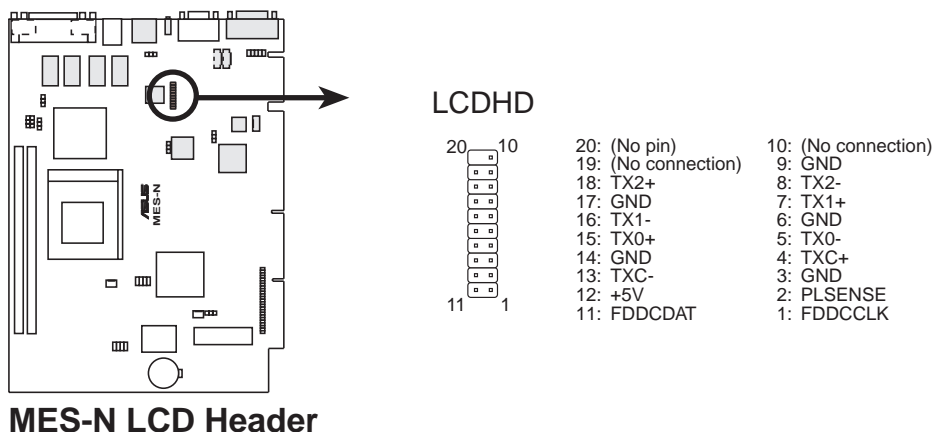

3. HARDWARE SETUP

3.8.3 Riser Card Connectors

1) LAN Activity Connectors

These connectors support Local Area Network (LAN) cards such as the ASUS PCI-L101 (see **7.1 ASUS PCI-L101 Fast Ethernet Card**) with output signals for data transfer activity. The LAN_LED connector allows the front panel LED to flash during transfer activity between the network and the computer. The WOL_CON connector allows the system to power up when there is a wakeup package (signal) received from the network.

IMPORTANT: This feature requires that **Wake On LAN** is set to *Enabled* (see **4.5.1 Power Up Control**) and that your system has an NLX power supply with at least 720mA +5V standby power.

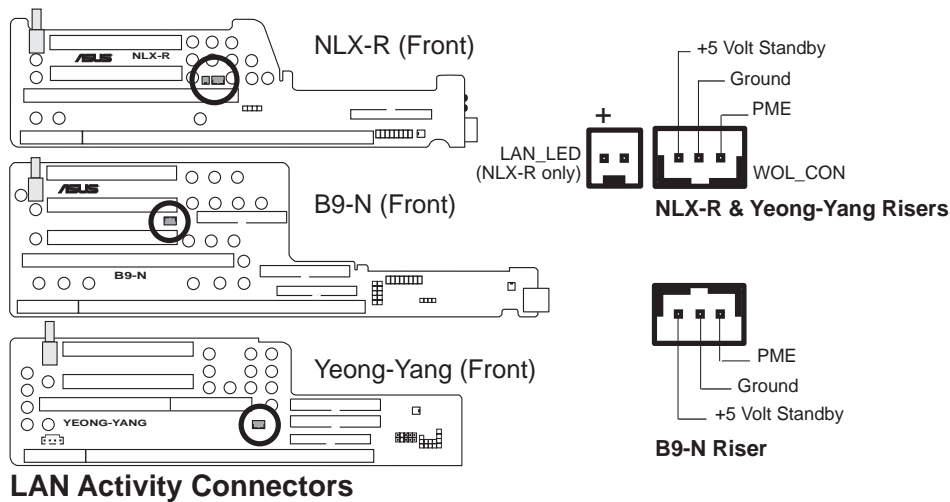

3. HW SETUP
Connectors

2) Front Panel Microphone Connector

This connector is used to connect the front panel microphone jack to the motherboard through a ribbon cable.

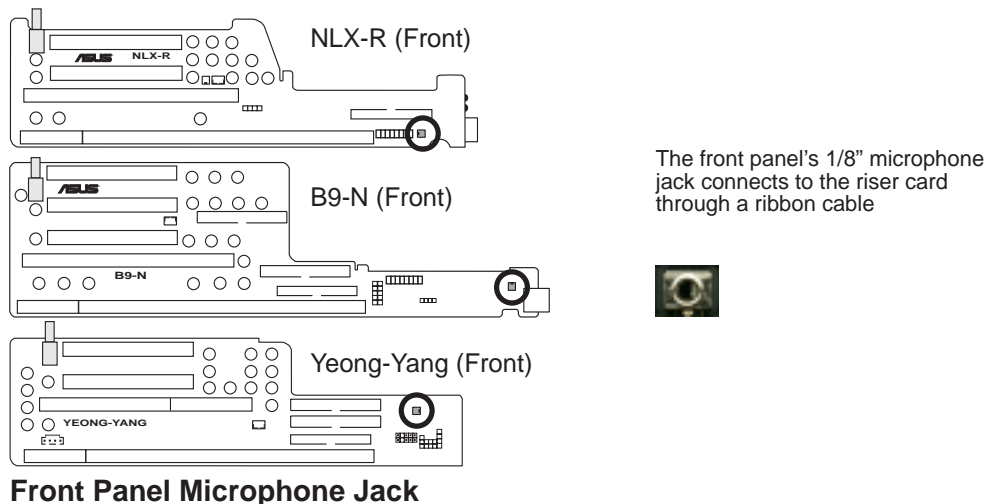

3. HARDWARE SETUP

3) NLX Power Supply Connector

This connector connects to an NLX power supply. The plug from the power supply will only insert in one orientation because of the different size holes. Find the proper orientation and push down firmly making sure that the pins are aligned.

IMPORTANT: Make sure that the NLX power supply can deliver at least 720mA on the 5volt standby lead (+5VSB). You may experience difficulty in powering on your system if your power supply cannot support the load. For Wake-On-LAN support, your NLX power supply must supply at least 720mA +5VSB.

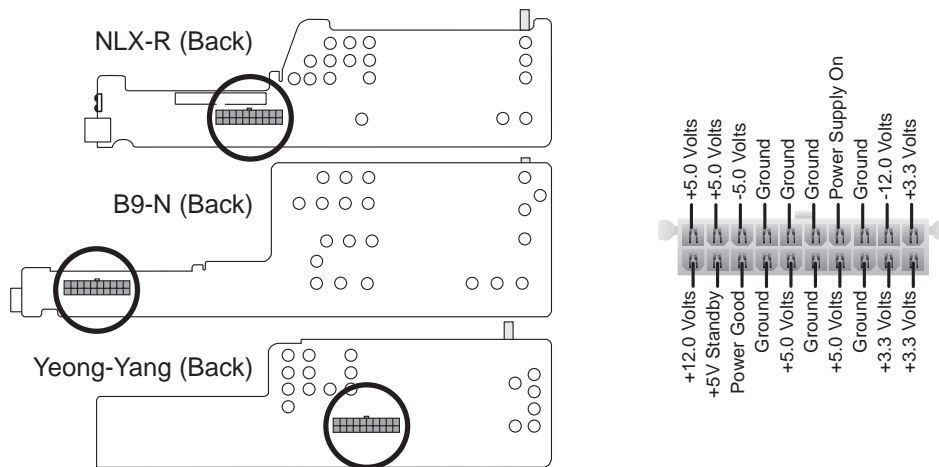

NLX Power Supply Connector

4) IDE Connectors

This connector supports the provided IDE hard disk drive ribbon cable. After connecting one end to the riser card, connect the other end to a hard disk drive. The primary IDE channel supports both a master and a slave IDE device but the system housing size only permits a standard IDE hard drive to be installed.

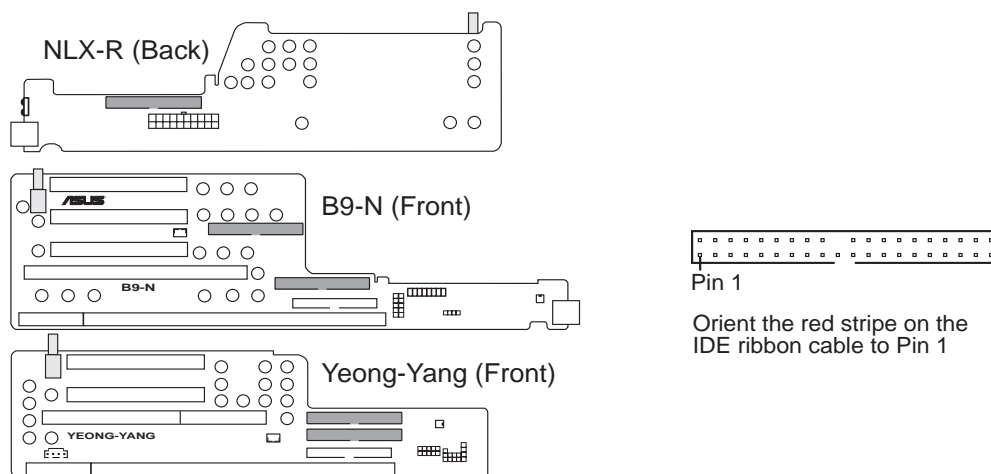

IDE Connectors

IMPORTANT: Ultra DMA/66 devices require a 40-pin 80-conductor cable to be enabled and/or for Ultra DMA Mode 4.

3. HARDWARE SETUP

5) 3.5" Floppy Disk Drive Connector

This connector supports the provided floppy drive ribbon cable. After connecting the single end to the riser card, connect the other end to a 3.5" floppy disk drive. **(Pin 5 is removed to prevent inserting in the wrong orientation when using ribbon cables with pin 5 plugged).**

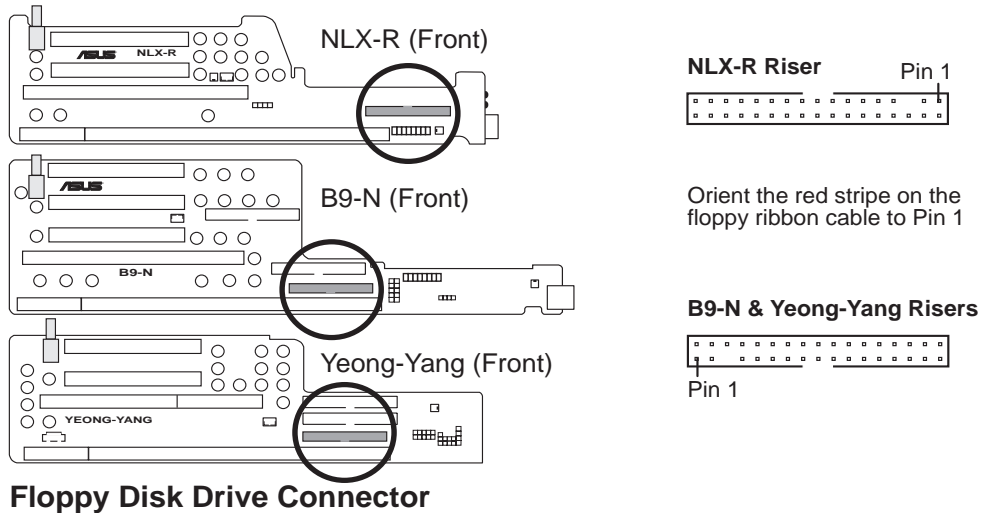

6) Universal Serial Bus (USB) Ports / USB Module Connector

If you have the NLX-R or B9-N risers, two Universal Serial Bus (USB) ports are available for connecting USB devices. If you have the Yeong-Yang riser, a 5-pin block is available for connecting an external connector set. This connector set can be mounted to an open slot on your computer's chassis. **USB Function** must be set to *Enabled* and **USB IRQ** to *Auto* in **4.4.3 PCI Configuration** to use USB features.

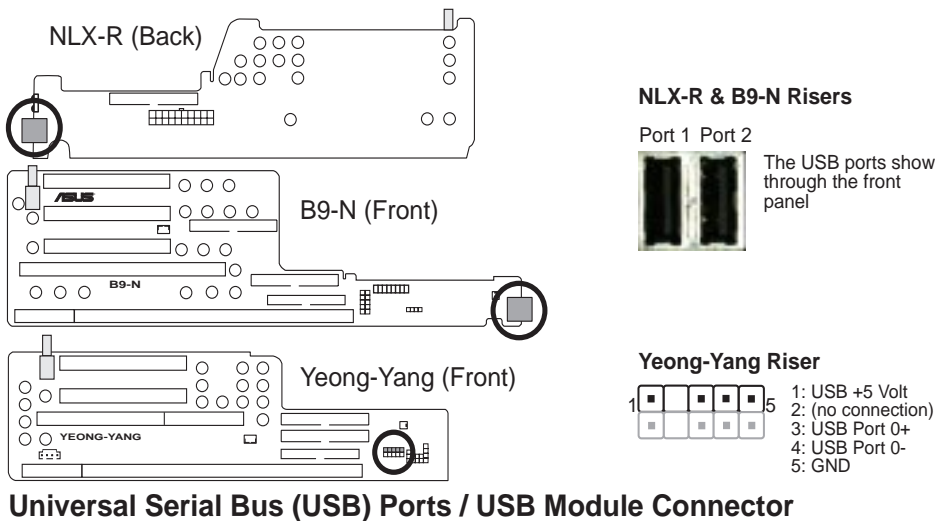

3. HW SETUP
Connectors

3. HARDWARE SETUP

7) IrDA-Compliant Infrared Module / Infrared Module Connectors

The NLX-R riser includes an onboard infrared module for wireless transmitting and receiving of data through the front panel infrared lense. The B9-N and Yeong-Yang risers include an infrared module connector that supports an optional wireless transmitting and receiving infrared module. This module mounts to a small opening on system cases that support this feature. You must also configure the setting through **UART2 Use Infrared** (see **4.4.2 I/O Device Configuration**) to select whether UART2 is directed for use with COM2 or IrDA. Use the five pins as shown in Back View and connect an appropriate ribbon cable from the module to the motherboard's IR connector according to the pin definitions. An optional consumer infrared (CIR) set connects to the CIR and IR connectors simultaneously for both wireless transmitting and remote control functions through one external infrared module.

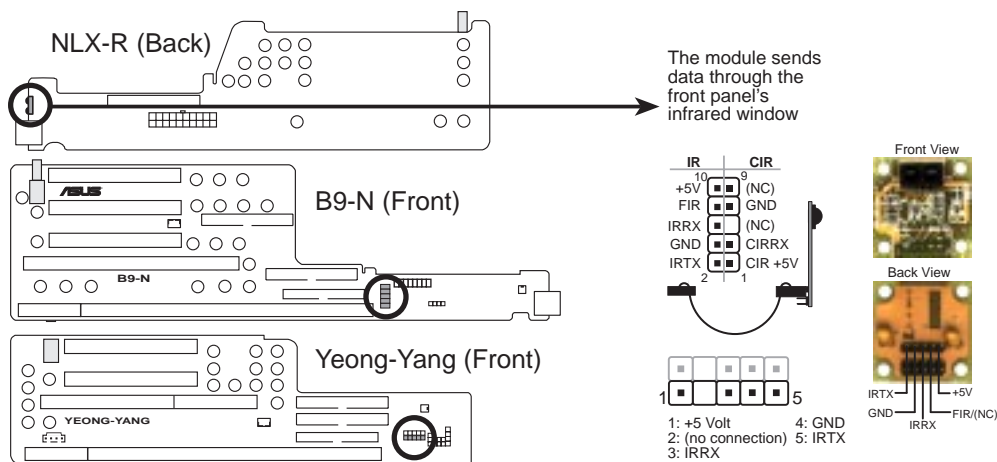

Infrared Module / Infrared Module Connector

3. HARDWARE SETUP

8) Stereo Audio In Connector

This connector lets you receive stereo audio input from an internal CD-ROM drive or other sound sources, such as a TV tuner or MPEG card.

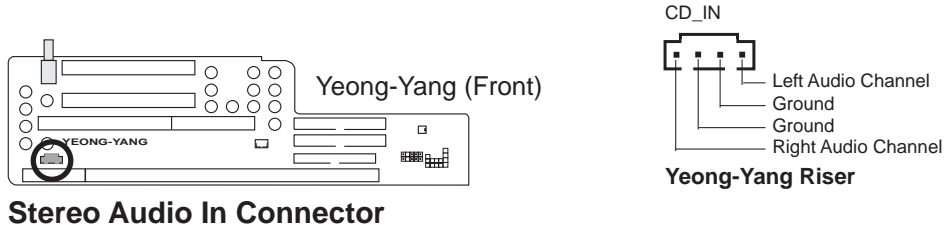

9) Front Panel Connector

This connector is used to connect the front panel display LEDs and buttons to the motherboard through a ribbon cable.

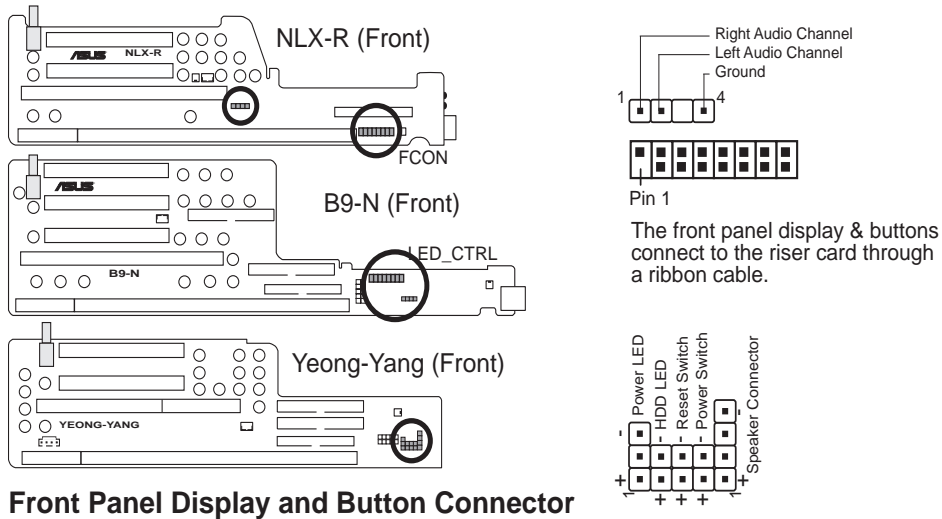

3. HW SETUP
Connectors

(This page was intentionally left blank.)

3. HARDWARE SETUP

3.9 Power Connection Procedures

1. After all connections are made, close the system case cover.
2. Be sure that all switches are off (in some systems, marked with ○).
3. Connect the power supply cord to the power supply located on the back of your system case according to your system user's manual.
4. Connect the power cord to a power outlet that is equipped with a surge protector.
5. You may then turn on your devices in the following order:
 - a. Your monitor
 - b. External SCSI devices (starting with the last device on the chain)
 - c. Your system power

For ATX power supplies, you need to switch ON the power supply if a switch is provided as well as press the ATX power switch on the front of the case.

6. The power LED on the front panel of the system case will light. For ATX power supplies, the system LED will light when the ATX power switch is pressed. The LED on the monitor may light up or switch between orange and green after the system's if it complies with "green" standards or if it has a power standby feature. The system will then run power-on tests. While the tests are running, additional messages will appear on the screen. If you do not see anything within 30 seconds from the time you turn on the power, the system may have failed a power-on test. Check your jumper settings and connections again or call your retailer for assistance.
 7. During power-on, hold down <Delete> to enter BIOS setup. Follow the instructions in **4. BIOS SETUP**.
- * **Powering Off your computer:** You must first exit or shut down your operating system before switching off the power switch. For ATX power supplies, you can press the ATX power switch after exiting or shutting down your operating system. If you use Windows 95/98, click the **Start** button, click **Shut Down**, and then click **Shut down the computer?**. The power supply should turn off after Windows shuts down.

NOTE: The message "You can now safely turn off your computer" will not appear when shutting down with ATX power supplies.

4. BIOS SETUP

4.1 Flash Memory Writer Utility

AFLASH.EXE: This is the Flash Memory Writer utility that updates the BIOS by uploading a new BIOS file to the programmable flash ROM chip on the motherboard. To determine the BIOS version of your motherboard, check the last four numbers of the code displayed on the upper left-hand corner of your screen during bootup. Larger numbers represent a newer BIOS file. This file works only in DOS mode.

NOTE: The following screen displays are provided as examples only and may not reflect the screen contents displayed on your system.

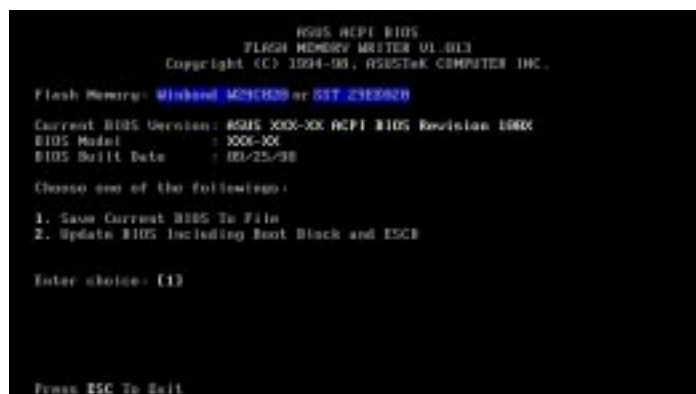

IMPORTANT: If “unknown” is displayed after **Flash Memory:**, the memory chip is either not programmable or is not supported by the ACPI BIOS and therefore, cannot be programmed by the Flash Memory Writer utility.

4.1.1 Main Menu

1. Save Current BIOS To File

This option allows you to save a copy of the original motherboard BIOS in case you need to reinstall it. It is recommended that you save **AFLASH.EXE** and the BIOS file to a bootable floppy disk.

To save your current BIOS, type [1] at the **Main Menu** and then press <Enter>. The **Save Current BIOS To File** screen appears. Type a filename and the path, for example, **A:\XXX-XX.XXX** and then press <Enter>.

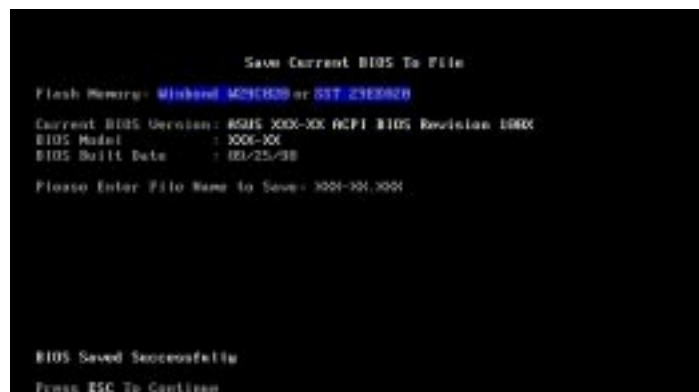

4. BIOS SETUP

2. Update BIOS Including Boot Block and ESCD

This option updates the boot block, the baseboard BIOS, and the ACPI extended system configuration data (ESCD) parameter block from a new BIOS file. See the next page for procedures on downloading an updated BIOS file.

To update your current BIOS, type [2] at the **Main Menu** and then press <Enter>. The **Update BIOS Including Boot Block and ESCD** screen appears. Type the filename of your new BIOS and the path, for example, **A:\XXX-XX.XXX**, and then press <Enter>.

When prompted to confirm the BIOS update, press **Y** to start the update.

The utility starts to program the new BIOS information into the flash ROM. When the programming is finished, **Flashed Successfully** will be displayed.

Follow the onscreen instructions to continue.

```
Update BIOS Including Boot Block and ESCD
Flash Memory: Winbond W29C020 or SST 29E020
Current BIOS Version: ASUS X00-XX ACPI BIOS Revision 1000
BIOS Model : X00-XX
BIOS Built Date : 00/25/98
Please Enter File Name for NEW BIOS: A:\X00-XX.XXX
```

```
Update BIOS Including Boot Block and ESCD
Flash Memory: Winbond W29C020 or SST 29E020
BIOS Version
CURRENT 3 ASUS X00-XX ACPI BIOS Revision 1000
Flash.umd3 ASUS X00-XX ACPI BIOS Revision 1000
BIOS Model
CURRENT 3 X00-XX
Flash.umd3 X00-XX
Date of BIOS Built
CURRENT 3 00/25/98
D0000.X0013 00/25/98
Check sum of X000.X000 is C370.
Are you sure (Y/N) ? Y
Press ESC To Return to Main Menu
```

```
Update BIOS Including Boot Block and ESCD
Flash Memory: Winbond W29C020 or SST 29E020
BIOS Version
CURRENT 3 ASUS X00-XX ACPI BIOS Revision 1000
Flash.umd3 ASUS X00-XX ACPI BIOS Revision 1000
BIOS Model
CURRENT 3 X00-XX
Flash.umd3 X00-XX
Date of BIOS Built
CURRENT 3 00/25/98
D0000.X0013 00/25/98
Check sum of X000.X000 is C370.
Are you sure (Y/N) ? Y
Programming -- 3FFFF
Flashed Successfully
Press ESC To Return to Main Menu
```

```
ASUS ACPI BIOS
FLASH MEMORY WRITER V1.013
Copyright (C) 1994-98, ASUSTEK COMPUTER INC.
Flash Memory: Winbond W29C020 or SST 29E020
Current BIOS Version: ASUS X00-XX ACPI BIOS Revision 1000
BIOS Model : X00-XX
BIOS Built Date : 00/25/98
Choose one of the following:
1. Save Current BIOS To File
2. Update BIOS Including Boot Block and ESCD
Enter choice: [2]
You have flashed the EPROM! It is recommended that you turn off
the power, enter SETUP and Load Setup Defaults to have CMOS
updated with new BIOS when exits.
Press ESC To Exit
```

4. BIOS SETUP

4.1.2 Managing and Updating Your BIOS

Upon First Use of the Computer System

1. Create a bootable system floppy disk by typing [FORMAT A:/S] from the DOS prompt.
2. Copy AFLASH.EXE to the just created boot disk.
3. Run AFLASH.EXE from this new disk and select option **1. Save Current BIOS to File**. See **1. Save Current BIOS To File** on the previous page for more details and the rest of the steps.

Updating BIOS Procedures (only when necessary)

1. Download an updated ASUS BIOS file from the Internet (WWW or FTP) or a BBS (Bulletin Board Service) (see ASUS CONTACT INFORMATION on page 3 for details) and save to the disk you created earlier.
2. Boot from the disk you created earlier.
3. At the "A:\>" prompt, type **AFLASH** and then press <Enter>.
4. At the **Main Menu**, type **2** and then press <Enter>. See **2. Update BIOS Including Boot Block and ESCD** on the previous page for more details and the rest of the steps.

WARNING! If you encounter problems while updating the new BIOS, DO NOT turn off your system since this might prevent your system from booting up. Just repeat the process, and if the problem still persists, update the original BIOS file you saved to disk above. If the Flash Memory Writer utility was not able to successfully update a complete BIOS file, your system may not be able to boot up. If this happens, your system will need service.

4. BIOS SETUP

4.2 BIOS Setup Program

This motherboard supports a programmable EEPROM that can be updated using the provided utility as described in *4.1 Flash Memory Writer Utility*.

The utility is used if you are installing a motherboard, reconfiguring your system, or prompted to “**Run Setup**”. This section describes how to configure your system using this utility.

Even if you are not prompted to use the Setup program, at some time in the future you may want to change the configuration of your computer. For example, you may want to enable the Security Password Feature or make changes to the power management settings. It will then be necessary to reconfigure your system using the BIOS Setup program so that the computer can recognize these changes and record them in the CMOS RAM of the EEPROM.

The EEPROM on the motherboard stores the Setup utility. When you turn on the computer, the system provides you with the opportunity to run this program. This appears during the Power-On Self Test (POST). Press <Delete> to call up the Setup utility. If you are a little bit late pressing the mentioned key(s), POST will continue with its test routines, thus preventing you from calling up Setup. If you still need to call Setup, reset the system by pressing <Ctrl> + <Alt> + <Delete>, or by pressing the Reset button on the system chassis. You can also restart by turning the system off and then back on again. But do so only if the first two methods fail.

The Setup program has been designed to make it as easy to use as possible. It is a menu driven program, which means you can scroll through the various sub-menus and make your selections among the various predetermined choices. If you accidentally change a setting and do not know which one to switch back to, the Setup program has a hot key that allows you to return to the previous value. The hot keys are discussed in more detail later in this Section.

To access the BIOS Setup program, press the <Delete> key after the computer has booted through its POST.

NOTE: Because the BIOS software is constantly being updated, the following BIOS screens and descriptions are for reference purposes only and may not exactly reflect your BIOS screens.

4. BIOS SETUP

4.2.1 BIOS Menu Bar

The top of the screen has a menu bar with the following selections:

- MAIN** Use this menu to make changes to the basic system configuration.
- ADVANCED** Use this menu to enable and make changes to the advanced features.
- POWER** Use this menu to configure and enable Power Management features.
- BOOT** Use this menu to configure the default system device used to locate and load the Operating System.
- EXIT** Use this menu to exit the current menu or specify how to exit the Setup program.

To access the menu bar items, press the right or left arrow key on the keyboard until the desired item is highlighted.

4.2.2 Legend Bar

At the bottom of the Setup screen you will notice a legend bar. The keys in the legend bar allow you to navigate through the various setup menus. The following table lists the keys found in the legend bar with their corresponding alternates and functions.

Navigation Key(s)	Function Description
<F1> or <Alt + H>	Displays the General Help screen from anywhere in the BIOS Setup
<Esc> or <Alt + X>	Jumps to the Exit menu or returns to the main menu from a sub-menu
← or → (keypad arrow)	Selects the menu item to the left or right
↑ or ↓ (keypad arrows)	Moves the cursor up or down between fields
- (minus key)	Scrolls backward through the values for the highlighted field
+ (plus key) or spacebar	Scrolls forward through the values for the highlighted field
<Enter>	Brings up a selection menu for the highlighted field
<Home> or <PgUp>	Moves the cursor to the first field
<End> or <PgDn>	Moves the cursor to the last field
<F5>	Resets the current screen to its Setup Defaults
<F10>	Saves changes and exits Setup

4. BIOS SETUP

General Help

In addition to the Item Specific Help window, the BIOS setup program also provides a General Help screen. This screen can be called up from any menu by simply pressing <F1> or the <Alt> + <H> combination. The General Help screen lists the legend keys with their corresponding alternates and functions.

Saving Changes and Exiting the Setup Program

See *4.7 Exit Menu* for detailed information on saving changes and exiting the setup program.

Scroll Bar

When a scroll bar appears to the right of a help window, this indicates that there is more information to be displayed that will not fit in the window. Use the <PgUp> and <PgDn> keys or the up and down arrow keys to scroll through the entire help document. Press the <Home> key to display the first page, press <End> to go to the last page. To exit the help window, press the <Enter> or the <Esc> key.

Sub-Menu

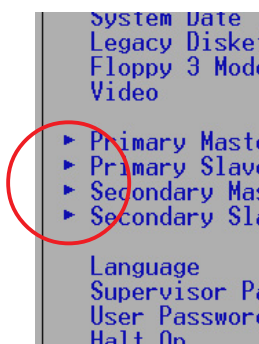

Note that a right pointer symbol appears to the left of certain fields. This pointer indicates that a sub-menu can be launched from this field. A sub-menu contains additional options for a field parameter. To call up a sub-menu, simply move the cursor to highlight the field and press <Enter>. The sub-menu will then immediately appear. Use the legend keys to enter values and move from field to field within a sub-menu just as you would within a menu. Use the <Esc> key to return to the main menu.

Take some time to familiarize yourself with each of the legend keys and their corresponding functions. Practice navigating through the various menus and sub-menus. If you accidentally make unwanted changes to any of the fields, use the set default hot key. While moving around through the Setup program, note that explanations appear in the Item Specific Help window located to the right of each menu. This window displays the help text for the currently highlighted field.

NOTE: The item heading in square brackets represents the default setting for that field.

4. BIOS SETUP

4.3 Main Menu

When the Setup program is accessed, the following screen appears:

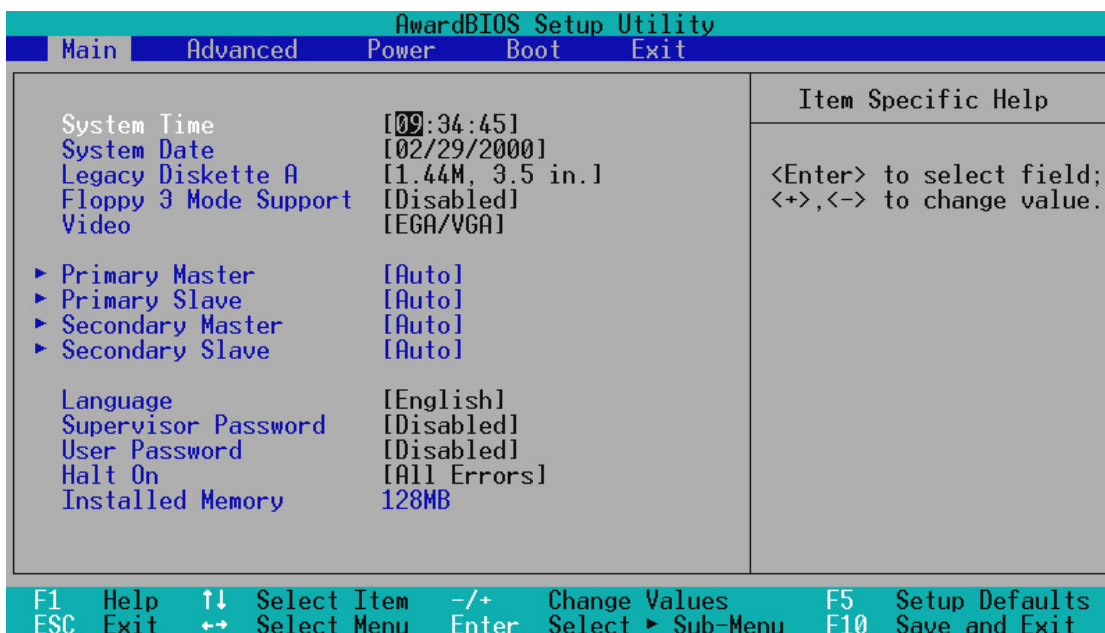

System Time [XX:XX:XX]

Sets your system to the time that you specify (usually the current time). The format is hour, minute, second. Follow the hour, minute and second format. Valid values for hour, minute and second are **Hour: (00 to 23)**, **Minute: (00 to 59)**, and **Second: (00 to 59)**. Use the <Tab> or <Shift> + <Tab> keys to move between the hour, minute, and second fields.

System Date [XX/XX/XXXX]

Sets your system to the date that you specify (usually the current date). The format is month, day, year. Follow the month, day and year format. Valid values for month, day and year are **Month: (1 to 12)**, **Day: (1 to 31)**, and **Year: (100 year range)**. Use the <Tab> or <Shift> + <Tab> keys to move between the month, day, and year fields.

Legacy Diskette A [1.44M, 3.5 in.]

Sets the type of floppy drive installed. Configuration options: [None] [360K , 5.25 in.] [1.2M , 5.25 in.] [720K , 3.5 in.] [1.44M, 3.5 in.] [2.88M, 3.5 in.]

Floppy 3 Mode Support [Disabled]

This is required to support older Japanese floppy drives. Floppy 3 Mode support will allow reading and writing of 1.2MB (opposed to 1.44MB) in a 3.5-inch diskette. Configuration options: [Disabled] [Drive A] [Drive B] [Both]

Video [EGA/VGA]

This field allows setting of display type. Use [MONO] for black and white monitors; otherwise, use the [EGA/VGA] setting. Configuration options: [EGA/VGA] [MONO]

4. BIOS SETUP

4.3.1 Primary & Secondary Master/Slave

These fields are used to configure IDE devices. The arrow head icon indicates that this field contains a sub-menu. Move the cursor to highlight the field representing the appropriate channel you wish to setup and press the <Enter> key to enter the sub-menu.

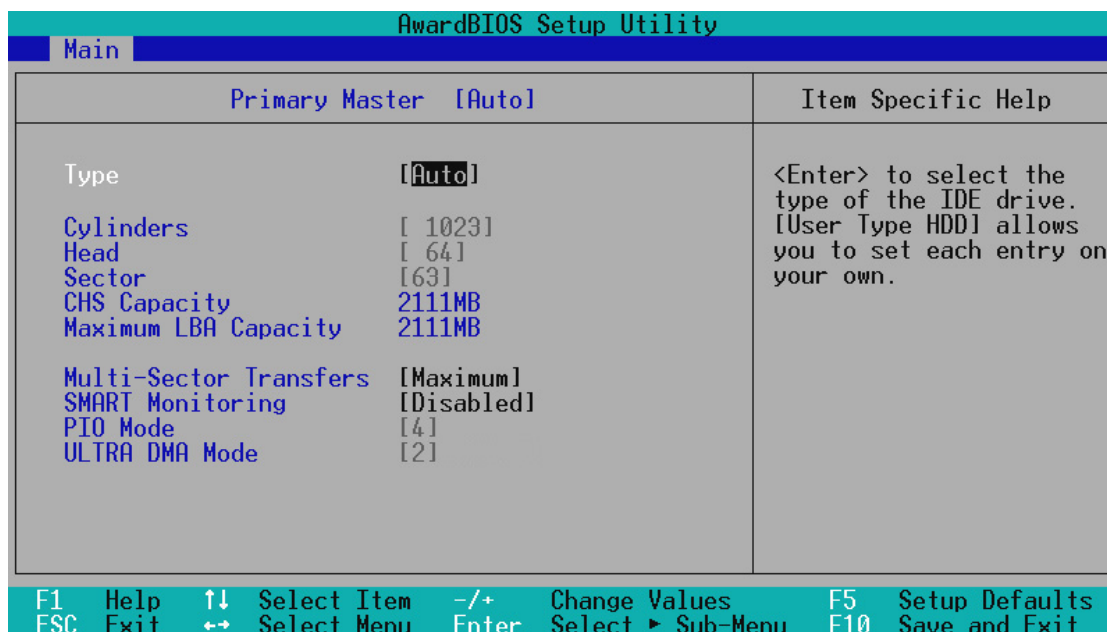

NOTE: Before attempting to configure a hard disk drive, make sure you have the configuration information supplied by the manufacturer of the drive. Incorrect settings may cause your system to not recognize the installed hard disk. To allow the BIOS to detect the drive type automatically, select [Auto].

Type [Auto]

Select [Auto] to automatically detect an IDE hard disk drive. If automatic detection is successful, the correct values will be filled in for the remaining fields on this sub-menu. If automatic detection fails, your hard disk drive may be too old or too new. You can try updating your BIOS or enter the IDE hard disk drive parameters manually.

NOTE: After the IDE hard disk drive information has been entered into BIOS, new IDE hard disk drives must be partitioned (such as with FDISK) and then formatted before data can be read from and write on. Primary IDE hard disk drives must have its partition set to *active* (also possible with FDISK).

Other options for the **Type** field are:

[None] - to disable IDE devices

4. BIOS SETUP

IMPORTANT: If your hard disk was already formatted on an older previous system, incorrect parameters may be detected. You will need to enter the correct parameters manually or use low-level format if you do not need the data stored on the hard disk. If the parameters listed differ from the ones used when the disk was formatted, the disk will not be readable. If the auto-detected parameters do not match the ones that should be used for your disk, you should enter the correct ones manually by setting [User Type HDD].

[User Type HDD]

AwardBIOS Setup Utility		
Main		
Primary Master	[User Type HDD]	Item Specific Help
Type	[User Type HDD]	<Enter> to select the type of the IDE drive. [User Type HDD] allows you to set each entry on your own.
Translation Method	[LBA]	
Cylinders	[1023]	
Head	[64]	
Sector	[63]	
CHS Capacity	2111MB	
Maximum LBA Capacity	2111MB	
Multi-Sector Transfers	[Maximum]	
SMART Monitoring	[Disabled]	
PIO Mode	[4]	
ULTRA DMA Mode	[2]	

F1 Help ↑↓ Select Item -/+ Change Values F5 Setup Defaults
ESC Exit ↔ Select Menu Enter Select ► Sub-Menu F10 Save and Exit

Manually enter the number of cylinders, heads and sectors per track for your drive. Refer to your drive documentation or look on the drive for this information. If no drive is installed or if you are removing a drive and not replacing it, select [None].

Translation Method [LBA]

Select the hard disk drive type in this field. When Logical Block Addressing is enabled, 28-bit addressing of the hard drive is used without regard for cylinders, heads, or sectors. Note that Logical Block Access may decrease the access speed of the hard disk. However, LBA Mode is necessary for drives with greater than 504MB in storage capacity. Configuration options: [LBA] [LARGE] [Normal] [Match Partition Table] [Manual]

Cylinders

This field configures the number of cylinders. Refer to your drive documentation to determine the correct value to enter into this field. **NOTE:** To make changes to this field, the **Type** field must be set to [User Type HDD] and the **Translation Method** field must be set to [Manual].

4. BIOS SETUP

Head

This field configures the number of read/write heads. Refer to your drive documentation to determine the correct value to enter into this field. **NOTE:** To make changes to this field, the **Type** field must be set to [User Type HDD] and the **Translation Method** field must be set to [Manual].

Sector

This field configures the number of sectors per track. Refer to your drive documentation to determine the correct value to enter into this field. **NOTE:** To make changes to this field, the **Type** field must be set to [User Type HDD] and the **Translation Method** field must be set to [Manual].

CHS Capacity

This field shows the drive's maximum CHS capacity calculated automatically by the BIOS from the drive information you entered.

Maximum LBA Capacity

This field shows the drive's maximum LBA capacity calculated automatically by the BIOS from the drive information you entered.

Multi-Sector Transfers [Maximum]

This option automatically sets the number of sectors per block to the highest number supported by the drive. This field can also be configured manually. Note that when this field is automatically configured, the set value may not always be the fastest value for the drive. Refer to the documentation that came with your hard drive to determine the optimal value and set it manually. **NOTE:** To make changes to this field, the **Type** field must be set to [User Type HDD]. Configuration options: [Disabled] [2 Sectors] [4 Sectors] [8 Sectors] [16 Sectors] [32 Sectors] [Maximum]

SMART Monitoring [Disabled]

This allows the enabling or disabling of the S.M.A.R.T. (Self-Monitoring, Analysis and Reporting Technology) system which utilizes internal hard disk drive monitoring technology. This feature is normally disabled because system resources used in this feature may decrease system performance. Configuration options: [Disabled] [Enabled]

PIO Mode [4]

This option lets you set a PIO (Programmed Input/Output) mode for the IDE device. Modes 0 through 4 provide successively increased performance. Configuration options: [0] [1] [2] [3] [4]

Ultra DMA Mode [Disabled]

Ultra DMA capability allows improved transfer speeds and data integrity for compatible IDE devices. Set to [Disabled] to suppress Ultra DMA capability. **NOTE:** To make changes to this field, the **Type** field must be set to [User Type HDD]. Configuration options: [0] [1] [2] [3] [4] [Disabled]

4. BIOS SETUP

Other options for “Type:” are:

[CD-ROM] - for IDE CD-ROM drives

[LS-120] - for LS-120 compatible floppy disk drives

[ZIP-100] - for ZIP-100 compatible disk drives

[MO] - for IDE magneto optical disk drives

[Other ATAPI Device] - for IDE devices not listed here

After using the legend keys to make your selections on this sub-menu, press the [Esc] key to exit back to the Main menu. When the Main menu appears, you will notice that the drive size appear in the field for the hard disk drive that you just configured.

Language [English]

This allows selection of the BIOS' displayed language. Currently only English is available.

Supervisor Password [Disabled] / User Password [Disabled]

This field allows you to set the password. To set the password, highlight the appropriate field and press <Enter>.

Type in a password and press <Enter>. You can type up to eight alphanumeric characters. Symbols and other keys are ignored. To confirm the password, type the password again and press the <Enter>. The password is now set to [Enabled]. This password allows full access to the BIOS Setup menus.

To clear the password, highlight this field and press <Enter>. The same dialog box as above will appear. Press <Enter> and the password will be set to [Disabled].

A Note about Passwords

The BIOS Setup program allows you to specify passwords in the Main menu. The passwords control access to the BIOS and certain Security menu options during system startup. The passwords are not case sensitive. In other words, it makes no difference whether you enter a password using upper or lowercase letters.

The BIOS Setup program allows you to specify two separate passwords: a Supervisor password and a User password. When disabled, anyone may access all BIOS Setup program functions. When enabled, the Supervisor password is required for entering the BIOS Setup program and having full access to all Security menu options.

4. BIOS SETUP

Forgot the password?

If you forgot the password, you can clear the password by erasing the CMOS Real Time Clock (RTC) RAM. The RAM data containing the password information is powered by the onboard button cell battery. To erase the RTC RAM: (1) Unplug your computer, (2) Set the CLR CMOS/PWD jumper to Clear, (3) Turn ON your computer, (4) Hold down <Delete> during bootup and enter BIOS setup to re-enter user preferences.

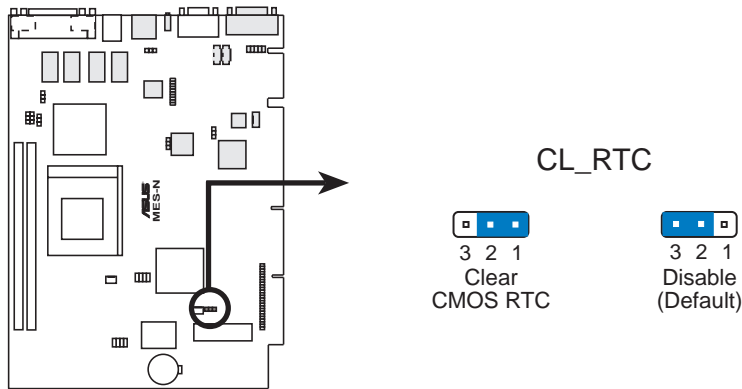

MES-N Clear RTC RAM

Halt On [All Errors]

This field determines which types of errors will cause the system to halt. Configuration options: [All Errors] [No Errors] [All,But Keyboard] [All,But Diskette] [All,But Disk/Key]

Installed Memory [XXX MB]

This field displays the amount of conventional memory detected by the system during bootup. You do not need to make changes to this field. This is a display only field.

4. BIOS SETUP

4.4 Advanced

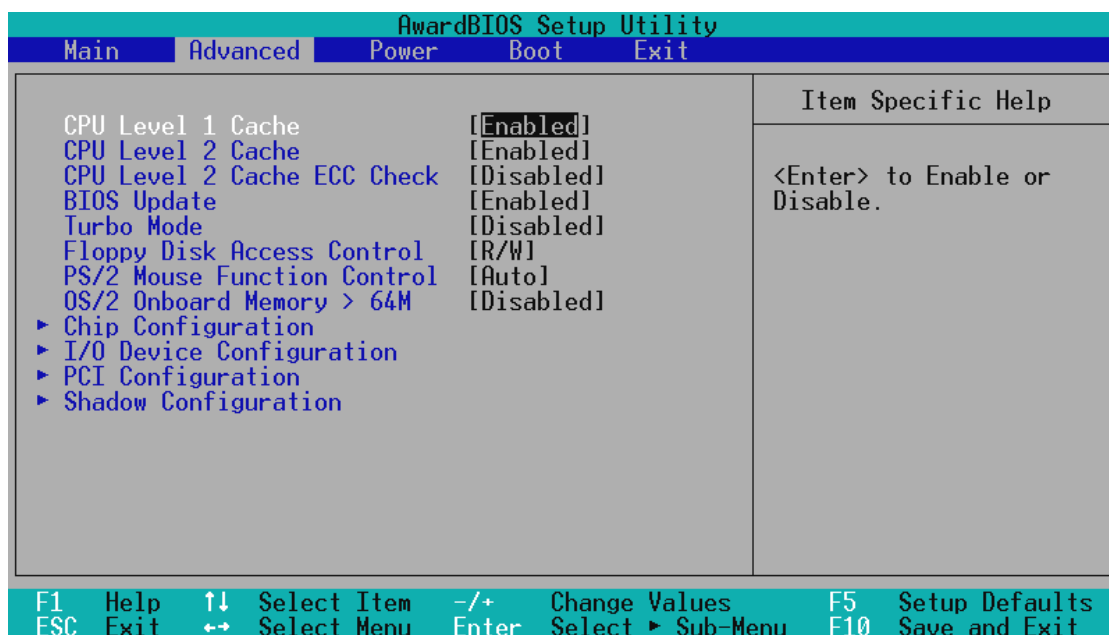

CPU Level 1 Cache, CPU Level 2 Cache [Enabled]

These fields allow you to choose from the default of [Enabled] or choose [Disabled] to turn on or off the CPU's Level 1 and Level 2 built-in cache.

CPU Level 2 Cache ECC Check [Disabled]

This function controls the ECC capability in the CPU level 2 cache.

BIOS Update [Enabled]

This functions as an update loader integrated into the BIOS to supply the processor with the required data. The BIOS will load the update on all processors during system bootup in the default position of [Enabled].

Turbo Mode [Disabled]

Configuration options: [Disabled] [Enabled]

Floppy Disk Access Control [R/W]

This allows protection of files from the computer system to be copied to floppy disks by allowing the setting of [Read Only] to only allow reads from the floppy disk drive but not writes. The setup default [R/W] allows both reads and writes. Configuration options: [R/W] [Read Only]

PS/2 Mouse Function Control [Auto]

The default of [Auto] allows the system to detect a PS/2 mouse on bootup. If detected, IRQ12 will be used for the PS/2 mouse. IRQ12 will be reserved for expansion cards if a PS/2 mouse is not detected. [Enabled] will always reserve IRQ12, whether on bootup a PS/2 mouse is detected or not.

OS/2 Onboard Memory > 64M [Disabled]

When using OS/2 operating systems with installed DRAM of greater than 64MB, you need to set this option to [Enabled]; otherwise, leave this on [Disabled].

4. BIOS SETUP

4.4.1 Chip Configuration

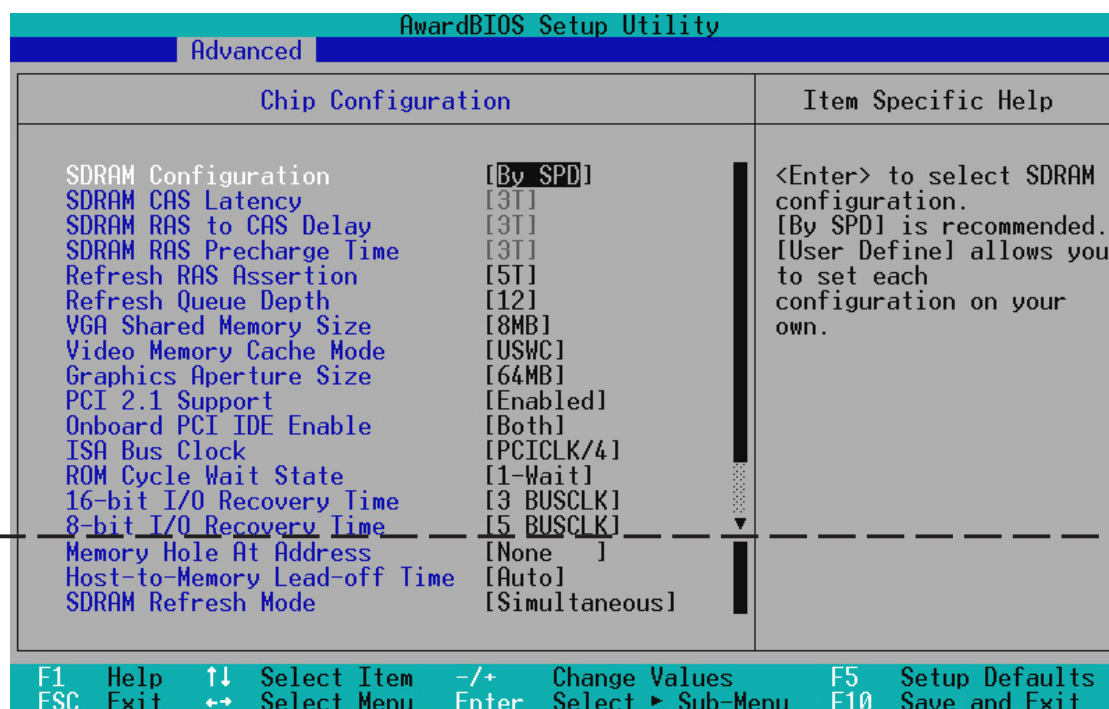

SDRAM Configuration [By SPD]

This sets the optimal timings of settings for items 2–4, depending on the memory modules that you are using. The default setting is [By SPD], which configures items 2–4 by reading the contents in the SPD (Serial Presence Detect) device. The EEPROM on the memory module stores critical parameter information about the module, such as memory type, size, speed, voltage interface, and module banks. Configuration options: [User Define] [7ns (143MHz)] [8ns (125MHz)] [By SPD]

SDRAM CAS Latency

This controls the latency between SDRAM read command and the time that the data actually becomes available. **NOTE:** To make changes to this field, the **SDRAM Configuration** field must be set to [User Define].

SDRAM RAS to CAS Delay

This controls the latency between SDRAM active command and the read/write command. **NOTE:** To make changes to this field, the **SDRAM Configuration** field must be set to [User Define].

SDRAM RAS Precharge Time

This controls the idle clocks after issuing a precharge command to SDRAM. **NOTE:** To make changes to this field, the **SDRAM Configuration** field must be set to [User Define].

Refresh RAS Assertion [5T]

Configuration options: [4T] [5T] [6T] [7T]

4. BIOS SETUP

Refresh Queue Depth [12]

Configuration options: [0] [4] [8] [12]

VGA Shared Memory Size [8MB]

You can choose the amount of user-installed DIMM memory to allocate to the on-board VGA. This option is relevant only to motherboards with onboard VGA but no VGA memory onboard. Configuration options: [2MB] [4MB] [8MB]

Video Memory Cache Mode [USWC]

USWC (uncacheable, speculative write combining) is a new cache technology for the video memory of the processor. It can greatly improve the display speed by caching the display data. You must set this to UC (uncacheable) if your display card cannot support this feature, otherwise your system may not boot. Configuration options: [UC] [USWC]

Graphics Aperture Size [64MB]

Memory-mapped, graphics data structures can reside in a Graphics Aperture. Configuration options: [4MB] [8MB]...[64MB] [128MB] [256MB]

PCI 2.1 Support [Enabled]

This function allows you to enable or disable PCI 2.1 features including passive release and delayed transaction. Configuration options: [Disabled] [Enabled]

Onboard PCI IDE Enable [Both]

You can select to enable the primary IDE channel, secondary IDE channel, both, or disable both channels. Configuration options: [Both] [Primary] [Secondary] [Disable]

ISA Bus Clock [PCICLK/4]

Configuration options: [7.159MHz] [PCICLK/4] [PCICLK/3]

ROM Cycle Wait State [1-Wait]

Configuration options: [4-Wait] [1-Wait]

16-bit I/O Recovery Time, 8-bit I/O Recovery Time

Leave on default settings.

Memory Hole At Address [None]

This field allows you to reserve an address space for ISA expansion cards that require it. Configuration options: [None] [15M-16M] [14M-16M] [12M-16M].

Host-to-Memory Lead-off Time [Auto]

Configuration options: [9T] [Auto]

SDRAM Refresh Mode [Simultaneous]

Configuration options: [Stagger] [Simultaneous]

4. BIOS SETUP

4.4.2 I/O Device Configuration

AwardBIOS Setup Utility	
Advanced	
I/O Device Configuration	Item Specific Help
Onboard FDC Controller [Enabled]	<Enter> to Enable or Disable the onboard floppy disk controller.
Onboard Serial Port 1 [3F8H/IRQ4]	
Onboard Serial Port 2 [2F8H/IRQ3]	
UART2 Use Infrared [Disabled]	
Onboard Parallel Port [378H/IRQ7]	
Parallel Port Mode [ECP+EPP]	
ECP DMA Select [3]	

F1 Help ↑↓ Select Item -/+ Change Values F5 Setup Defaults
ESC Exit ↔ Select Menu Enter Select ▶ Sub-Menu F10 Save and Exit

Onboard FDC Controller [Enabled]

When [Enabled], this field allows you to connect your floppy disk drives to the onboard floppy disk drive connector instead of a separate controller card. If you want to use a different controller card to connect the floppy disk drives, set this field to [Disabled]. Configuration options: [Disabled] [Enabled]

Onboard Serial Port 1 [3F8H/IRQ4]

This allows you to set the address for the onboard serial connector. Serial Port 1 and Serial Port 2 must have different addresses. Configuration options: [3F8H/IRQ4] [2F8H/IRQ3] [3E8H/IRQ4] [2E8H/IRQ10] [Disabled]

Onboard Serial Port 2 [2F8H/IRQ3]

This allows you to set the address for the onboard serial connector. Serial Port 1 and Serial Port 2 must have different addresses. Configuration options: [3F8H/IRQ4] [2F8H/IRQ3] [3E8H/IRQ4] [2E8H/IRQ10] [Disabled]

UART2 Use Infrared [Disabled]

When enabled, this field activates the onboard infrared feature and sets the second serial UART to support the infrared module connector on the motherboard. If your system already has a second serial port connected to the onboard COM2 connector, it will no longer work if you enable the infrared feature. By default, this field is set to [Disabled], which leaves the second serial port UART to support the COM2 serial port connector. See **IrDA-Compliant Infrared Module Connector** in *3.8.3 External Connectors*. Configuration options: [Disable] [Enabled]

4. BIOS SETUP

Onboard Parallel Port [378H/IRQ7]

This field sets the address of the onboard parallel port connector. If you install an I/O card with a parallel port, ensure that there is no conflict in the address assignments. The PC can support up to three parallel ports as long as there are no conflicts for each port. Configuration options: [Disabled] [3BCH/IRQ7] [378H/IRQ7] [278H/IRQ5]

Parallel Port Mode [ECP+EPP]

The port is both software and hardware compatible with existing parallel ports so that it may be used as a standard printer mode if ECP is not required. ECP mode provides an automatic high burst-bandwidth channel that supports DMA for ECP in both the forward (host to peripheral) and reverse (peripheral to host) direction. This field allows you to set the operation mode of the parallel port. The setting [Normal], allows normal-speed operation but in one direction only; [EPP] allows bidirectional parallel port operation at maximum speed; [ECP] allows the parallel port to operate in bidirectional mode and at a speed faster than the maximum unidirectional data transfer rate; [ECP+EPP] allows normal speed operation in a two-way mode. Configuration options: [Normal] [EPP] [ECP] [ECP+EPP]

ECP DMA Select [3]

This field allows you to configure the parallel port DMA channel for the selected **ECP** mode. This selection is available only if you select [ECP] or [ECP+EPP] in **Parallel Port Mode** above. Configuration options: [1] [3] [Disabled]

4. BIOS SETUP

4.4.3 PCI Configuration

AwardBIOS Setup Utility	
Advanced	
PCI Configuration	Item Specific Help
Slot 1 IRQ [Auto]	<Enter> to select an IRQ.
Slot 2 IRQ [Auto]	
Slot 3 IRQ [Auto]	
PCI/VGA Palette Snoop [Disabled]	
PCI Latency Timer [32]	
SYMBIOS SCSI BIOS [Auto]	
USB Function [Disabled]	
USB IRQ [Auto]	
ONB VGA BIOS First [No]	
▶ PCI/PNP ISA IRQ Resource Exclusion	
▶ PCI/PNP ISA DMA Resource Exclusion	
▶ PCI/PNP ISA UMB Resource Exclusion	

F1 Help ↑↓ Select Item -/+ Change Values F5 Setup Defaults
ESC Exit ↔ Select Menu Enter Select ▶ Sub-Menu F10 Save and Exit

Slot 1 IRQ, Slot 2 IRQ, Slot 3 IRQ [Auto]

Each PCI slot must have a unique IRQ number to operate. Make sure you do not choose an IRQ number used by another device. Configuration options: [Auto] [NA] [3] [4] [5] [7] [9] [10] [11] [12] [14] [15]

PCI/VGA Palette Snoop [Disabled]

Some display cards that are nonstandard VGA such as graphics accelerators or MPEG Video Cards may not show colors properly. The setting [Enabled] should correct this problem. Otherwise, leave this on the setup default setting of [Disabled]. Configuration options: [Disabled] [Enabled]

PCI Latency Timer [32]

Leave on default setting for best performance vs. stability.

Symbios SCSI BIOS [Auto]

[Auto] allows the motherboard's BIOS to detect whether you have a Symbios SCSI card. If the Symbios SCSI card is detected, the motherboard's Symbios BIOS will be enabled; if no Symbios SCSI card is detected, the onboard Symbios SCSI BIOS will be disabled.

[Disabled] will disable the motherboard's Symbios SCSI BIOS so that the BIOS on an external Symbios SCSI card can be used. If your Symbios SCSI card does not have a BIOS, the Symbios SCSI card will not function. Configuration options: [Auto] [Disabled]

4. BIOS SETUP

USB Function [Disabled]

The USB ports can be activated or deactivated using this field. Configuration options: [Disabled] [Enabled]

USB IRQ [Auto]

[Auto] reserves an IRQ# for the USB to work. If you are not using any USB devices, you may set this feature to [NA] to save an extra IRQ# for expansion cards. Make sure you do not choose an IRQ number used by another device. Configuration options: [Auto] [NA] [3] [4] [5] [7] [9] [10] [11] [12] [14] [15]

ONB VGA BIOS First [No]

This field, when set to [Yes], gives priority to the onboard VGA BIOS over other VGA controllers. Configuration options: [No] [Yes]

PCI/PNP ISA IRQ Resource Exclusion

AwardBIOS Setup Utility	
Advanced	
PCI/PNP ISA IRQ Resource Exclusion	Item Specific Help
IRQ 3 Used By ISA: [No/ICU]	Select 'Yes' if this IRQ is required by a legacy ISA card and you are not using ICU, else select 'No/ICU'.
IRQ 4 Used By ISA: [No/ICU]	
IRQ 5 Used By ISA: [Yes]	
IRQ 7 Used By ISA: [No/ICU]	
IRQ 9 Used By ISA: [No/ICU]	
IRQ 10 Used By ISA: [No/ICU]	
IRQ 11 Used By ISA: [No/ICU]	
IRQ 12 Used By ISA: [No/ICU]	
IRQ 14 Used By ISA: [No/ICU]	
IRQ 15 Used By ISA: [No/ICU]	

F1 Help ↑↓ Select Item -/+ Change Values F5 Setup Defaults
ESC Exit ↔ Select Menu Enter Select ▶ Sub-Menu F10 Save and Exit

IRQ XX Used By ISA: [No/ICU] / IRQ 5 Used By ISA: [Yes]

These fields indicate whether or not the displayed IRQ for each field is being used by a legacy (non-PnP) ISA card. [No/ICU] indicates either that the displayed IRQ is not used or an ISA Configuration Utility (ICU) is being used to determine if an ISA card is using that IRQ. If you install a legacy ISA card that requires a unique IRQ, and you are not using an ICU, you must set the field for that IRQ to [Yes]. For example: If you install a legacy ISA card that requires IRQ 10, then set **IRQ10 Used By ISA** to [Yes]. Configuration options are: [No/ICU] [Yes]

4. BIOS SETUP

PCI/PNP ISA DMA Resource Exclusion

AwardBIOS Setup Utility	
Advanced	
PCI/PNP ISA DMA Resource Exclusion	Item Specific Help
DMA 1 Used By ISA [No/ICU] DMA 3 Used By ISA [No/ICU] DMA 5 Used By ISA [No/ICU]	Select [Yes] if this DMA channel is required by a legacy ISA card and you are not using ICU; otherwise, select [No/ICU].

F1 Help ↑↓ Select Item -/+ Change Values F5 Setup Defaults
ESC Exit ↔ Select Menu Enter Select ► Sub-Menu F10 Save and Exit

DMA x Used By ISA: [No/ICU]

These fields indicate whether or not the displayed DMA channel for each field is being used by a legacy (non-PnP) ISA card. The default setting indicates either that the displayed DMA channel is not used or an ICU is being used to determine if an ISA card is using that channel. If you install a legacy ISA card that requires a unique DMA channel, and you are not using an ICU, you must set the field for that channel to [Yes]. Configuration options are: [No/ICU] [Yes]

PCI/PNP ISA UMB Resource Exclusion

AwardBIOS Setup Utility	
Advanced	
PCI/PNP ISA UMB Resource Exclusion	Item Specific Help
ISA MEM Block BASE [No/ICU]	This is for some ISA add-on cards whose UMB can't be auto-detected.

F1 Help ↑↓ Select Item -/+ Change Values F5 Setup Defaults
ESC Exit ↔ Select Menu Enter Select ► Sub-Menu F10 Save and Exit

4. BIOS SETUP

ISA MEM Block BASE [No/ICU]

This field allows you to set the base address and block size of a legacy ISA card that uses any memory segment within the C800 and DC00 address range. If you have such a card, and you are not using an ICU to specify its address range, select a base address from the six available options; the **ISA MEM Block SIZE** field will then appear for selecting the block size. If you have more than one legacy ISA card in your system that requires to use this address range, you can increase the block size to either 8K, 16K, 32K, or 64K. If you are using an ICU to accomplish this task, leave **ISA MEM Block BASE** to its default setting of [No/ICU]. Configuration options are: [No/ICU] [C800] [CC00] [D000] [D400] [D800] [DC00]

4.4.4 Shadow Configuration

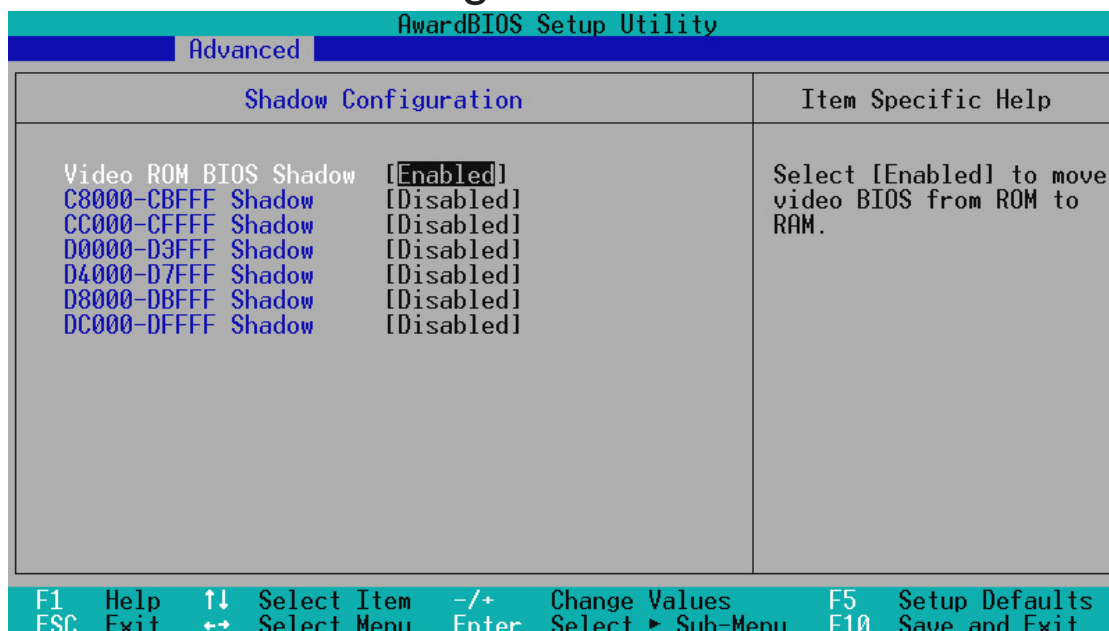

Video ROM BIOS Shadow: [Enabled]

This field allows you to change the video BIOS location from ROM to RAM. Relocating to RAM enhances system performance, as information access is faster than the ROM. Configuration options: [Disabled] [Enabled]

C8000-CBFFF to DC000-DFFFF: [Disabled]

These fields are used for shadowing other expansion card ROMs. If you install other expansion cards with ROMs on them, you will need to know which addresses the ROMs use to shadow them specifically. Shadowing a ROM reduces the memory available between 640K and 1024K by the amount used for this purpose. Configuration options: [Disabled] [Enabled]

4. BIOS SETUP

4.5 Power Menu

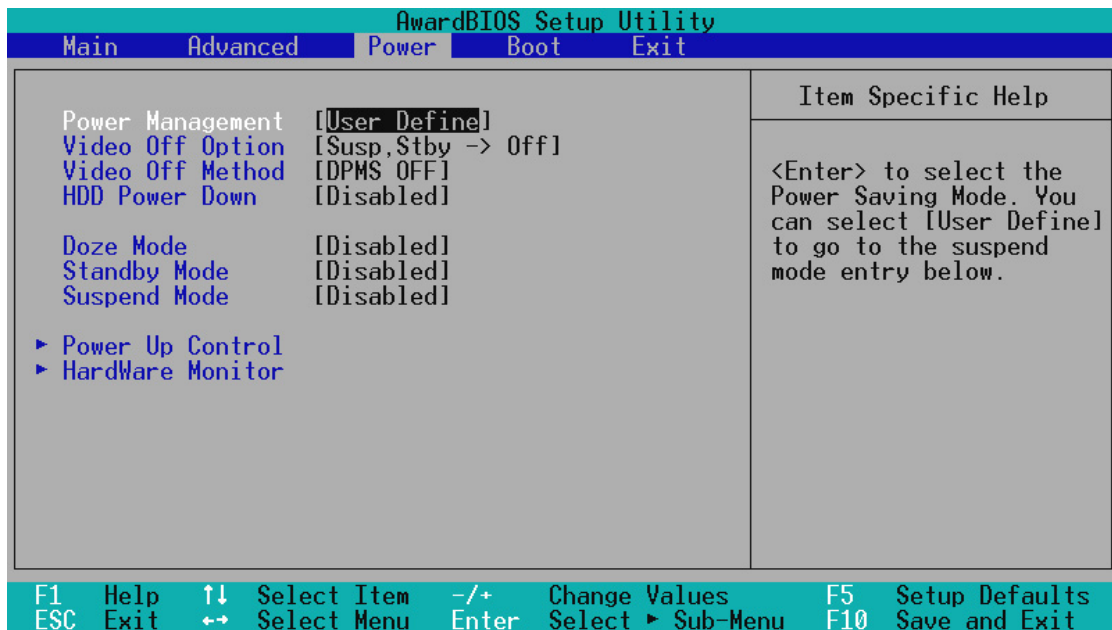

Power Management: [User Define]

This option must be enabled to use any of the automatic power saving features. If this menu item is set to [Disabled], power management features will not function regardless of other field settings on this menu. The [User Define] option allows you to make your own selections in the Power menu. When set to [Max Saving], system power will be conserved to its greatest amount. The **Doze, Standby, and Suspend Mode** fields will then be set to predefined values that ensure maximum power savings.

This field acts as the master control for the power management modes. [Max Saving] puts the system into power saving mode after a brief period of system inactivity; [Min Saving] is almost the same as [Max Saving] except that this time the system inactivity period is longer; [Disable] disables the power saving features; [User Define] allows you to set power saving options according to your preference. Configuration options: [User Define] [Disabled] [Min Saving] [Max Saving]

IMPORTANT: Advanced Power Management (APM) should be installed to keep the system time updated when the computer enters suspend mode activated by the BIOS Power Management. For DOS environments, you need to add the statement, `DEVICE=C:\DOS\POWER.EXE`, in your `CONFIG.SYS`. For Windows 3.x and Windows 95, you need to install Windows with the APM feature. For Windows 98 and later, APM is automatically installed. A battery and power cord icon labeled “Power Management” will appear in the Control Panel. Choose “Advanced” in the Power Management Field.

4. BIOS SETUP

Video Off Option [Susp,Stby -> Off]

This field determines when to activate the video off feature for monitor power management. Configuration options: [Always On] [Suspend -> Off] [Susp,Stby -> Off] [All Modes -> Off]

Video Off Method [DPMS OFF]

This field defines the video off features. The DPMS (Display Power Management System) feature allows the BIOS to control the video display card if it supports the DPMS feature. [Blank Screen] only blanks the screen (use this for monitors without power management or “green” features. If set up in your system, your screen saver will not display with [Blank Screen] selected). [V/H SYNC+Blank] blanks the screen and turns off vertical and horizontal scanning. Configuration options: [Blank Screen] [V/H SYNC+Blank] [DPMS Standby] [DPMS Suspend] [DPMS OFF] [DPMS Reduce ON]

HDD Power Down [Disabled]

Shuts down any IDE hard disk drives in the system after a period of inactivity as set in this user-configurable field. This feature does not affect SCSI hard drives. Configuration options: [Disabled] [1 Min] [2 Min] [3 Min]...[15 Min]

Doze Mode [Disabled]

Sets the time period for the system to go into doze (or sleep) mode. Configuration options: [Disabled] [20 Sec] [1 Min] [5 Min] [10 Min] [15 Min]...[40 Min]

Standby Mode [Disabled]

Sets the time period for the system to go into standby mode. Configuration options: [Disabled] [20 Sec] [1 Min] [5 Min] [10 Min] [15 Min]...[40 Min]

Suspend Mode [Disabled]

Sets the time period for the system to go into suspend mode. Configuration options: [Disabled] [20 Sec] [1 Min] [5 Min] [10 Min] [15 Min]...[40 Min]

4. BIOS SETUP

4.5.1 Power Up Control

AwardBIOS Setup Utility	
Power	
Power Up Control	Item Specific Help
AC PWR Loss Restart [Disabled]	<Enter> to select whether or not to restart the system after AC power loss.
PWR Up On Modem Act [Enabled]	
Wake On LAN [Disabled]	
Automatic Power Up [Disabled]	

F1 Help ↑↓ Select Item -/+ Change Values F5 Setup Defaults
ESC Exit ↔ Select Menu Enter Select F10 Save and Exit

AC PWR Loss Restart: [Disabled]

This allows you to set whether you want your system to boot up after the power has been interrupted. [Disabled] leaves your system off after reapplying power and [Enabled] boots up your system after reapplying power. Configuration options: [Disabled] [Enabled]

PWR Up On Modem Act: [Enabled]

This allows either settings of [Enabled] or [Disabled] for powering up the computer (turning the ATX power supply on) when the modem receives a call while the computer is in Soft-off. Configuration options: [Disabled] [Enabled]

NOTE: The computer cannot receive or transmit data until the computer and applications are fully running, thus connection cannot be made on the first try. Turning an external modem off and then back on while the computer is off causes an initialization string that will also cause the system to power on.

Wake On LAN: [Enabled]

Wake-On-LAN allows your computer to be booted from another computer via a network by sending a wake-up frame or signal. With this feature, network administrators can remotely boot an entire network of computer systems during off-peak hours for software updating or maintenance. Configuration options: [Disabled] [Enabled]

IMPORTANT: This feature requires an optional network interface with Wake-On-LAN and an ATX power supply with at least 720mA +5V standby power.

Automatic Power Up: [Disabled]

This allows automatic system power up. Configuration options: [Disabled] [Enabled]

4. BIOS SETUP

4.5.2 Hardware Monitor

AwardBIOS Setup Utility	
Power	
HardWare Monitor	Item Specific Help
CPU Temperature 61°C/141°F	<Enter> to switch between monitoring or ignoring.
CPU Fan Speed 4560RPM	
Chassis Fan Speed N/A	
VCORE Voltage 2.0V	
+3.3V Voltage 3.3V	
+5V Voltage 5.0V	
+12V Voltage 12.0V	
F1 Help ↑↓ Select Item -/+ Change Values F5 Setup Defaults	
ESC Exit ↔ Select Menu Enter Select ▶ Sub-Menu F10 Save and Exit	

CPU Temperature [xxx°C/xxx°F]

The onboard hardware monitor is able to detect the CPU and MB (motherboard) temperatures. Set to [Ignore] only if necessary.

CPU Fan, Chassis Fan Speed [xxxxRPM]

The onboard hardware monitor is able to detect the CPU fan speed and chassis fan speed in revolutions per minute (RPM). The presence of this fan is automatically detected. Set to [Ignore] only if necessary.

VCORE Voltage/+3.3V Voltage/+5V Voltage/+12V Voltage [xx.xV]

The onboard hardware monitor is able to detect the voltage output by the onboard voltage regulators. Set to [Ignore] only if necessary.

NOTE: If any of the monitored items is out of range, an error message will appear: “Hardware Monitor found an error. Enter Power setup menu for details”. You will then be prompted to “Press **F1** to continue, **DEL** to enter SETUP”.

4. BIOS SETUP

4.6 Boot Menu

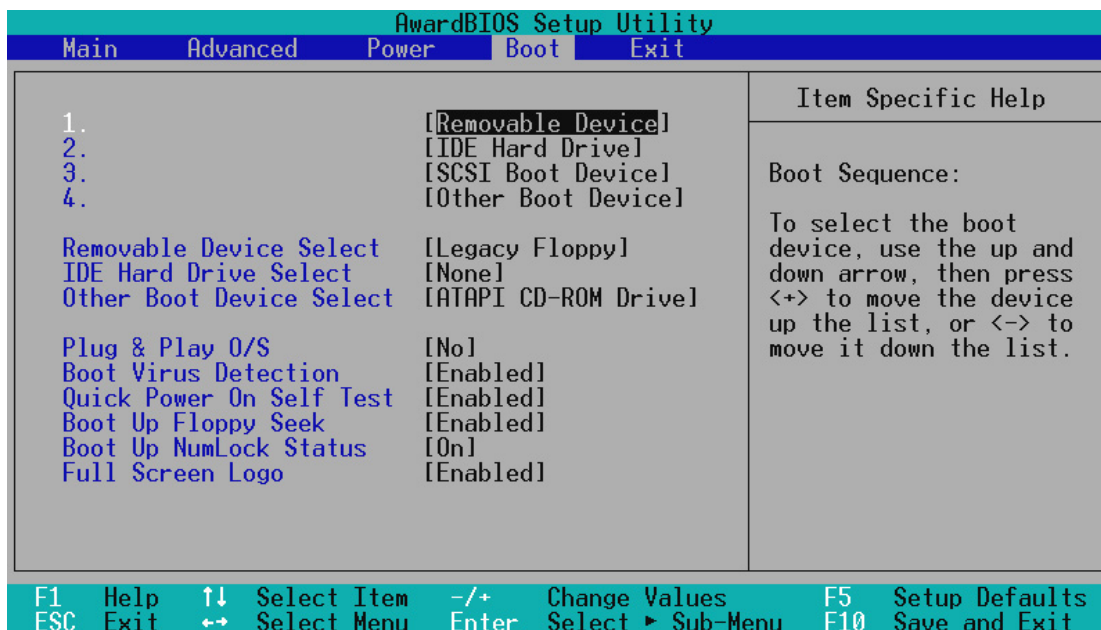

Boot Sequence

The Boot menu allows you to select among the three possible boot devices listed using the up and down arrow keys. By using the <+> or <Space> key, you can promote devices and by using the <-> key, you can demote devices. Promotion or demotion of devices alters the priority which the system uses to search for a boot device on system power up. Configuration options: [Removable Devices] [IDE Hard Drive] [SCSI Boot Device] [Other Boot Device]

Removable Device Select [Legacy Floppy]

Configuration options: [Legacy Floppy] [LS120] [ZIP-100] [ATAPI MO]

IDE Hard Drive Select

This field allows you to select the IDE hard disk drive included in the boot sequence. Pressing [Enter] will show the product IDs of all your connected IDE hard disk drives.

Other Boot Device Select [ATAPI CD-ROM Drive]

Configuration options: [ATAPI CD-ROM Drive] [Network]

Plug & Play O/S [No]

This field allows you to use a Plug-and-Play (PnP) operating system to configure the PCI bus slots instead of using the BIOS. Thus interrupts may be reassigned by the OS when [Yes] is selected. When a non-PnP OS is installed or to prevent reassigning of interrupt settings, select the default setting of [No]. Configuration options: [No] [Yes]

4. BIOS SETUP

Boot Virus Detection: [Enabled]

Configuration options: [Disabled] [Enabled]

Quick Power On Self Test: [Enabled]

Configuration options: [Disabled] [Enabled]

Boot Up Floppy Seek: [Enabled]

Configuration options: [Disabled] [Enabled]

Boot Up NumLock Status: [On]

Configuration options: [Off] [On]

Full Screen Logo: [Enabled]

Configuration options: [Disabled] [Enabled]

4. BIOS SETUP

4.7 Exit Menu

Once you have made all of your selections from the various menus in the Setup program, you should save your changes and exit Setup. Select **Exit** from the menu bar to display the following menu:

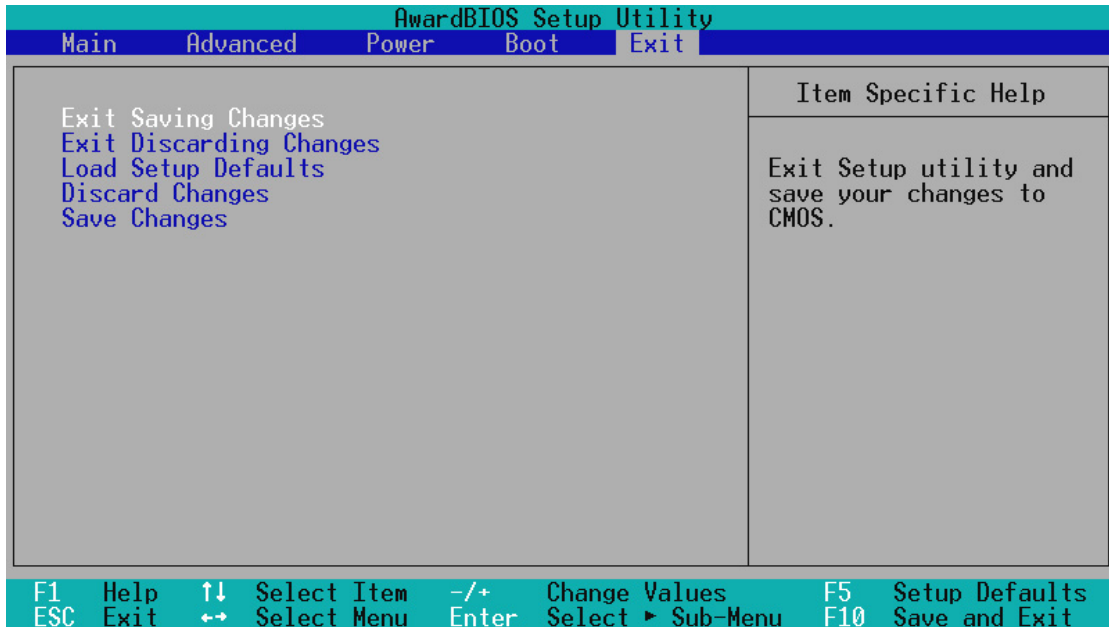

NOTE: Pressing the <Esc> key does not exit this menu. You must select one of the options from this menu or a menu bar item to exit this menu.

Exit Saving Changes

Once you are finished making your selections, choose this option from the Exit menu to ensure the values you selected are saved to the CMOS RAM. The CMOS RAM is sustained by an onboard backup battery and stays on even when the PC is turned off. Once this option is selected, a confirmation is asked. Select [Yes] to save changes and exit.

NOTE: If you attempt to exit the Setup program without saving your changes, the program will prompt you with a message asking if you want to save your changes before exiting. Pressing the <Enter> key will then save changes while exiting.

Exit Discarding Changes

This option should only be used if you do not want to save the changes you have made to the Setup program. If you have made changes to the fields other than system date, system time and password, the system will ask for confirmation before exiting.

4. BIOS SETUP

Load Setup Defaults

This option allows you to load the default values for each of the parameters on the Setup menus. When this option is selected or if <F5> is pressed, a confirmation is requested. Select [Yes] to load default values. You can now select **Exit Saving Changes** or make other changes before saving the values to the non-volatile RAM.

Discard Changes

This option allows you to discard the selections you made and restore the values you previously saved. After selecting this option, all selections are updated and a confirmation is requested. Select [Yes] to discard any changes and load the previously saved values.

Save Changes

This option saves your selections without exiting the Setup program. You can then return to other menus and make changes. After selecting this option, all selections are saved and a confirmation is requested. Select [Yes] to save any changes to the non-volatile RAM.

5. SOFTWARE SETUP

5.1 Operating Systems

You should always use the latest operating system and updates when using new hardware to ensure full compliancy. For Windows 95, you must use OSR 2.0 or later. For Windows NT 4.0, you must use Service Pack 3.0 or later.

5.1.1 Windows 98 First Time Installation

When you start Windows for the first time after the installation of your motherboard, Windows 98 will detect the onboard audio and video chips and may attempt to install a driver from its system registry. When prompted to restart, select **No** and then follow the normal setup procedures later in this section.

IMPORTANT: Selecting **No** for the initial restart prompt is a necessary step because Windows may load an older display driver that is incompatible with the onboard VGA chip. Always use the driver available on the ASUS Support CD or an applicable driver update from your ASUS vendor or from the ASUS web site.

NOTE: The screen displays in this and the following section may not reflect exactly the screen contents displayed on your screen.

5. SOFTWARE SETUP

5.2 MES-N Support CD

NOTE: The support CD contents are subject to change at any time without notice.

To begin using your support CD disc, just insert it into your CD-ROM drive and the support CD installation menu should appear. If the menu does not appear, double-click or run **D:\ASSETUP.EXE** (assuming that your CD-ROM drive is drive **D:**).

5.2.1 Installation Menu



- **Install ASUS PC Probe Vx.xx:** Installs the ASUS PC Probe utility to monitor your computer's fan, temperature, and voltages.
 - **Install Bus Master IDE Driver:** Installs SiS5595 Bus Master IDE Driver for improved performance. See README.TXT for more details.
 - **Install VGA Driver:** Installs the necessary VGA drivers and utilities to access the features of the integrated VGA controller.
 - **Install Audio Driver (Optional):** Installs the necessary audio drivers and utilities to access the features of the built-in PCI audio chipset.
 - **Install YAMAHA XG-STUDIO (Optional):** Installs the YAMAHA XGstudio Player and Mixer for playing and mixing MIDI files, respectively. Refer to the online help for more information.
 - **Install YAMAHA YSTATION32 (Optional):** Installs the YAMAHA Ystation32 audio utilities for CD, MIDI, and WAVE playback and recording (WAVE component only).
 - **Install Network Driver:** Installs the network driver for the onboard Intel® PCI Ethernet adapter. Refer to the online help for more information.
 - **Install PCCillin 98 Vx.xx:** Installs the PC-cillin virus protection software. View the online help for more information.
 - **Install ADOBE Acrobat Reader Vx.x:** Installs the Adobe Acrobat Reader software necessary to view user's manuals saved in PDF format. Updated or other language versions of this motherboard's manual is available in PDF format at any of our web sites.
 - **Show Motherboard Information:** Allows you to view information about your motherboard, such as product name, BIOS version, and CPU.
- (To see the following items, click RIGHT ARROW on the lower-right corner of the main menu.)
- **Browse Support CD:** Allows you to view the contents of the CD.
 - **ReadMe:** Displays the filelist for the included support software.
 - **Exit:** Exits the CD installation menu.

Additional CD Contents: Flash BIOS writer in the **AFLASH** folder, IDE Bus Master driver for improved performance under Windows NT in the **BUSMASTR** folder, USB patch to fix problems when using the USB driver under Windows 95 OSR 2.1 in the **USBPATCH** folder.

5. SOFTWARE SETUP

5.3 Install ASUS PC Probe Vx.xx

Insert the Support CD that came with your motherboard into your CD-ROM drive or double-click the CD drive icon in **My Computer** to bring up the setup screen.

NOTE: ASUS PC Probe will not run if another hardware monitoring utility is installed. To uninstall any program, see *5.12 Uninstalling Programs*.

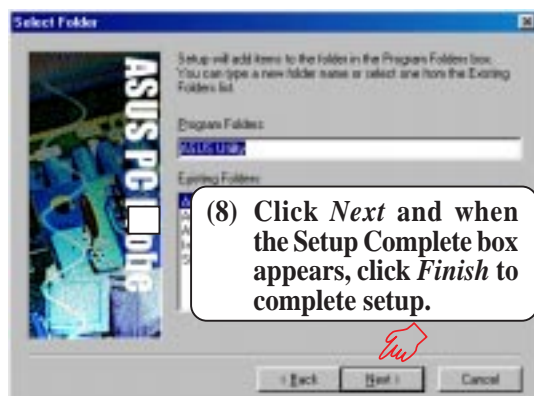
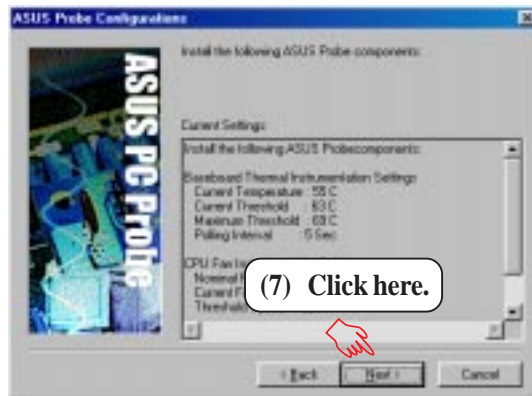
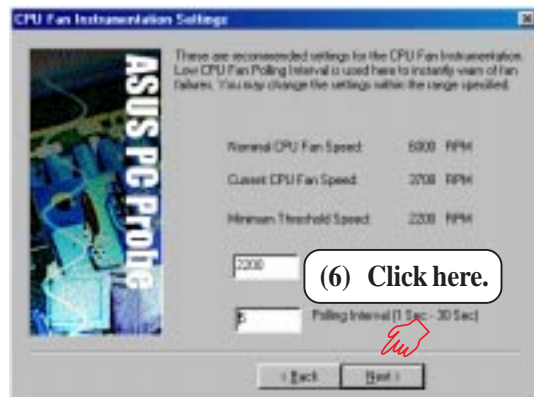
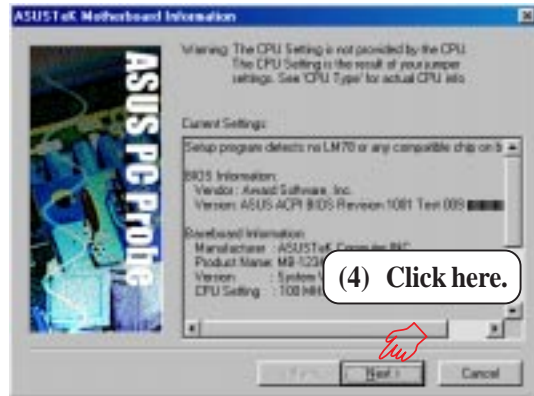
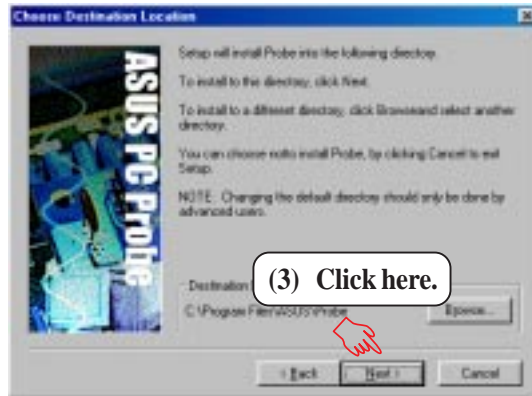

5. S/W SETUP
Windows 98

5. SOFTWARE SETUP

5.4 Install Bus Master IDE Driver

Insert the Support CD that came with your motherboard into your CD-ROM drive or double-click the CD drive icon in **My Computer** to bring up the setup screen.

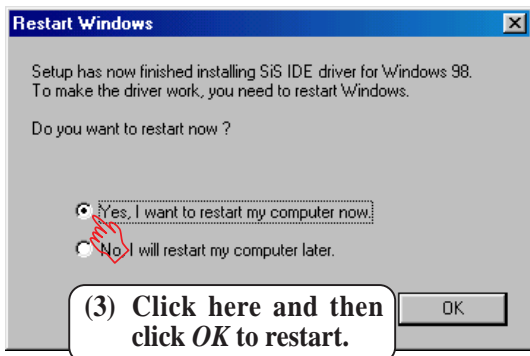
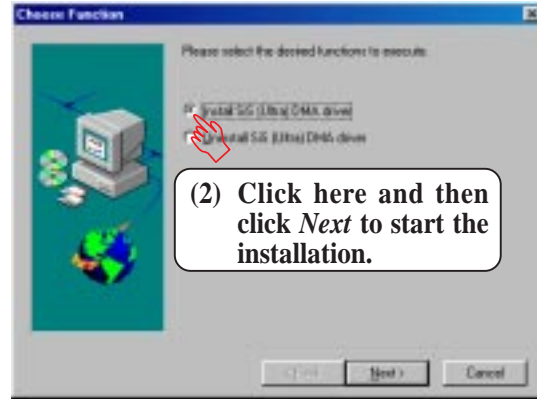

NOTE: You may choose to restart your computer later when this option is offered, especially if you still want to install other drivers and/or software. You may not, however, be able to use immediately the devices associated with the drivers or software because these drivers need to be enabled. These drivers are enabled when Windows starts/restarts.

5. SOFTWARE SETUP

5.5 Install VGA Driver

Insert the Support CD that came with your motherboard into your CD-ROM drive or double-click the CD drive icon in **My Computer** to bring up the setup screen.

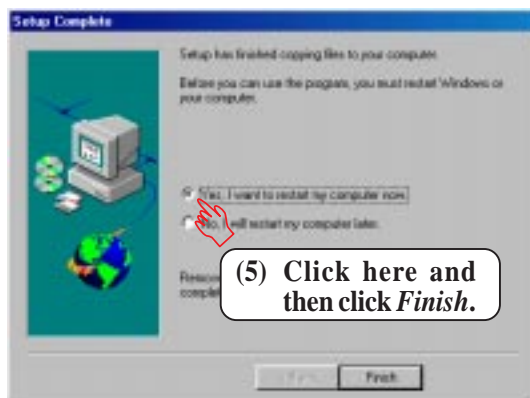
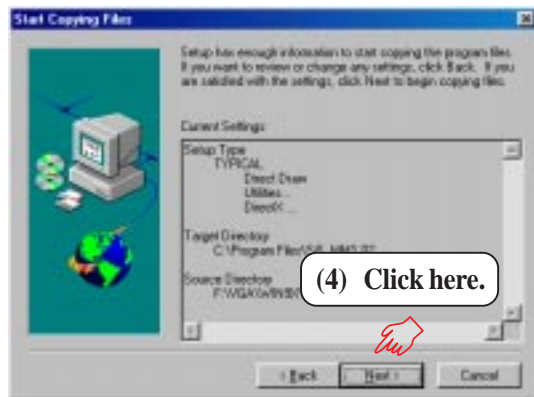
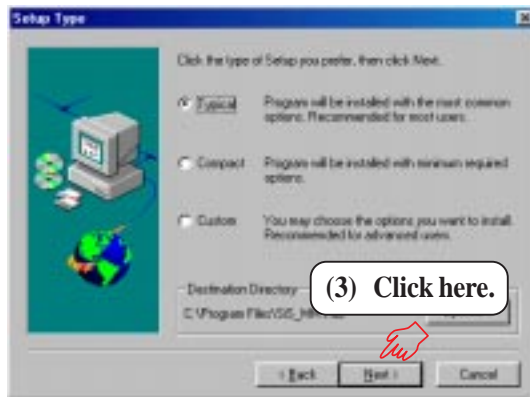
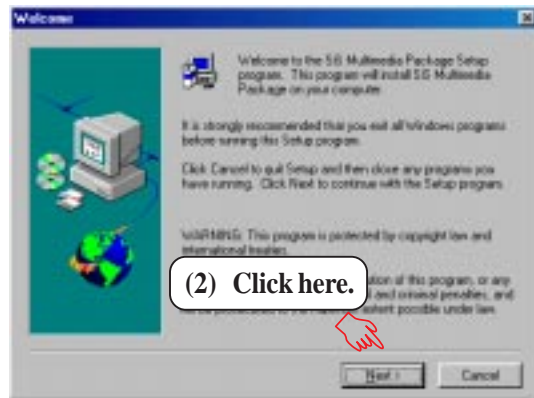

5. SOFTWARE SETUP

5.6 Install Audio Driver (only with onboard audio option)

Insert the Support CD that came with your motherboard into your CD-ROM drive or double-click the CD drive icon in **My Computer** to bring up the setup screen.

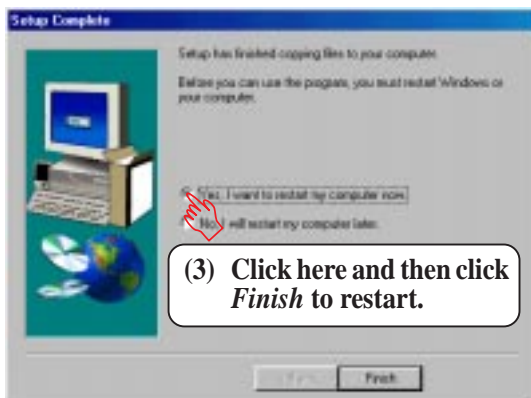

For Windows 95

1. When the *New Hardware Found* screen prompts for a driver, select **Driver from disk provided by hardware manufacturer** and insert the ASUS Support CD into your CD-ROM drive.
2. Click **OK**.
3. Click **Browse**.
4. Locate the **D:\Audio\Yamaha\Win9X** folder (where D is your CD-ROM Drive) and click **OK**.
5. Click **OK** again and the driver files will be copied.
6. Click **Yes** to restart the computer.

5. SOFTWARE SETUP

5.7 Install YAMAHA XG-STUDIO

(only with onboard audio option)

Insert the Support CD that came with your motherboard into your CD-ROM drive or double-click the CD drive icon in **My Computer** to bring up the setup screen.

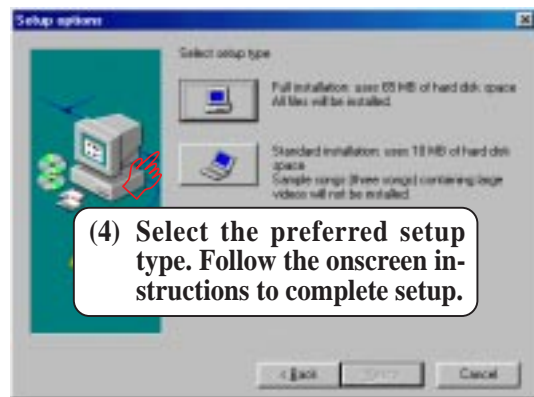
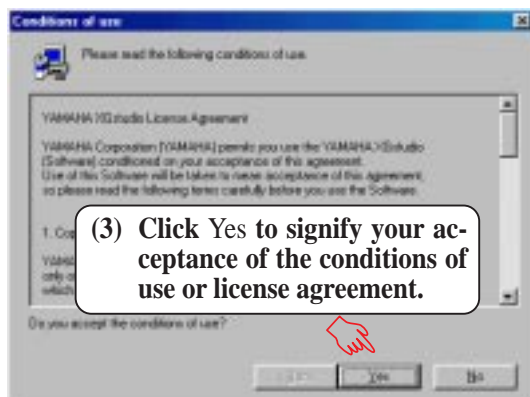

5. SOFTWARE SETUP

5.8 Install YAMAHA YSTATION32

(only with onboard audio)

Insert the Support CD that came with your motherboard into your CD-ROM drive or double-click the CD drive icon in **My Computer** to bring up the setup screen.

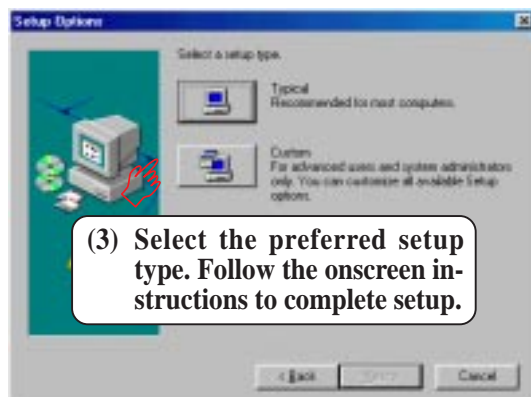

5. SOFTWARE SETUP

5.9 Install Network Driver

Insert the Support CD that came with your motherboard into your CD-ROM drive or double-click the CD drive icon in **My Computer** to bring up the setup screen.



NOTE: In some systems, the auto-installer may fail. If this occurs, you will be presented with a set of instructions on how to manually install the LAN drivers. To manually open this set of instructions, double-click SETUP.TXT in the **LAN** folder of your support CD.

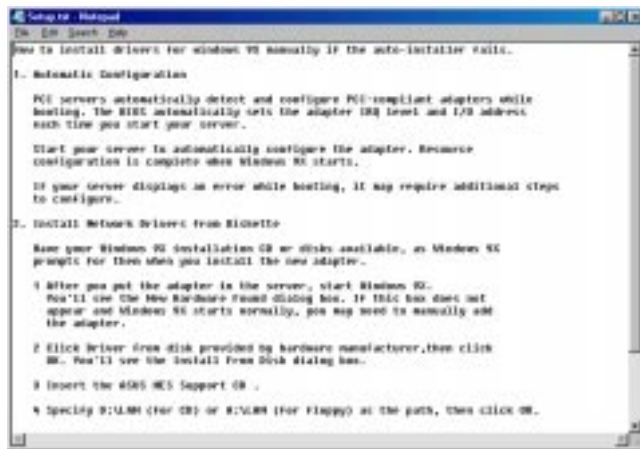

5. SOFTWARE SETUP

5.10 Install PC-Cillin 98 Vx.xx

Insert the Support CD that came with your motherboard into your CD-ROM drive or double-click the CD drive icon in **My Computer** to bring up the setup screen.

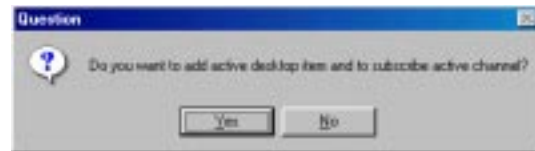
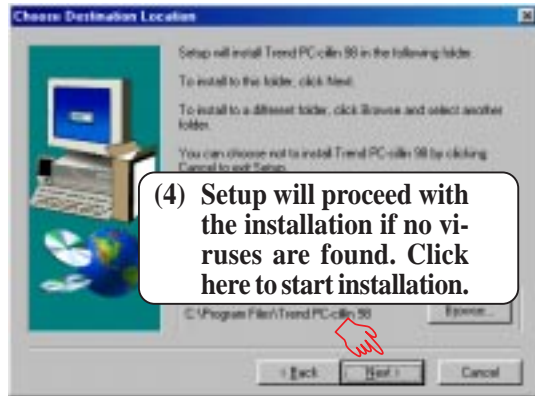

(6) & (7) Select the preferred features by clicking the appropriate buttons.

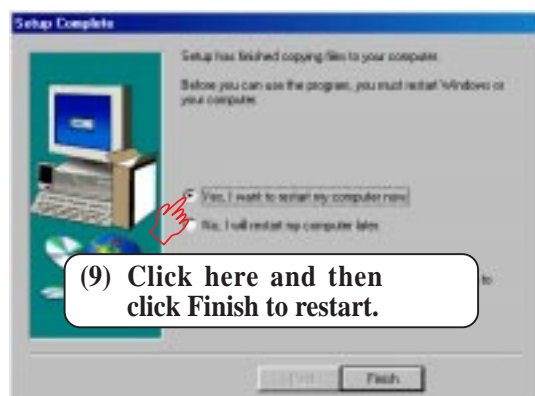
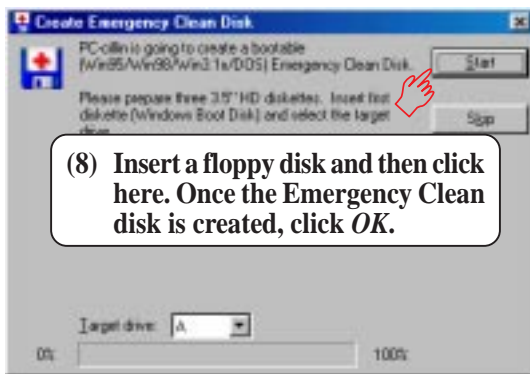

5. SOFTWARE SETUP

5.11 Install ADOBE Acrobat Reader Vx.x

Insert the Support CD that came with your motherboard into your CD-ROM drive or double-click the CD drive icon in **My Computer** to bring up the setup screen.

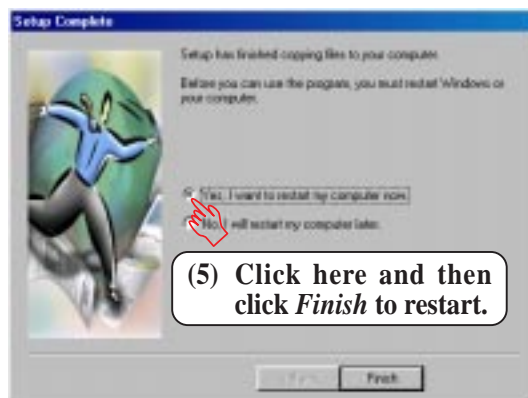
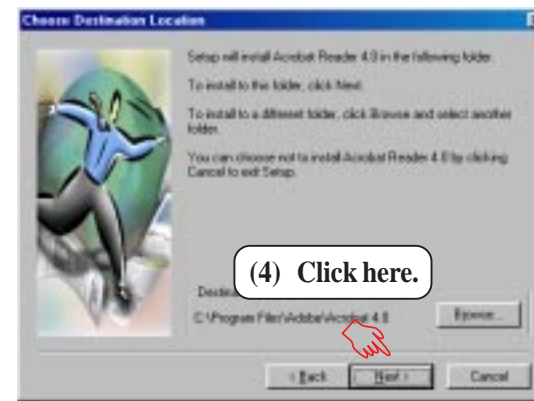
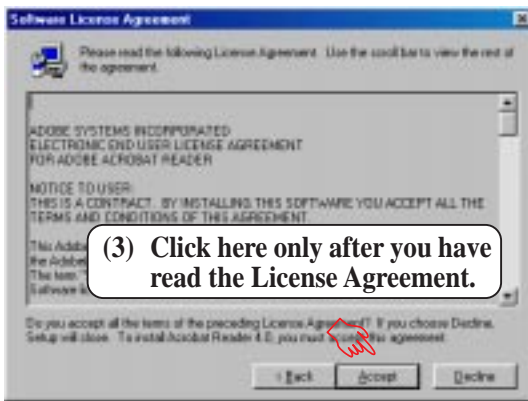
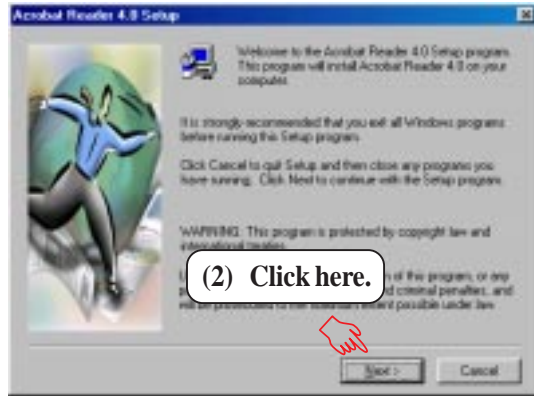

5. SOFTWARE SETUP

5.12 Uninstalling Programs

Add/Remove Programs is a basic component within Windows. You may use this function if a program does not provide its own uninstallation program.

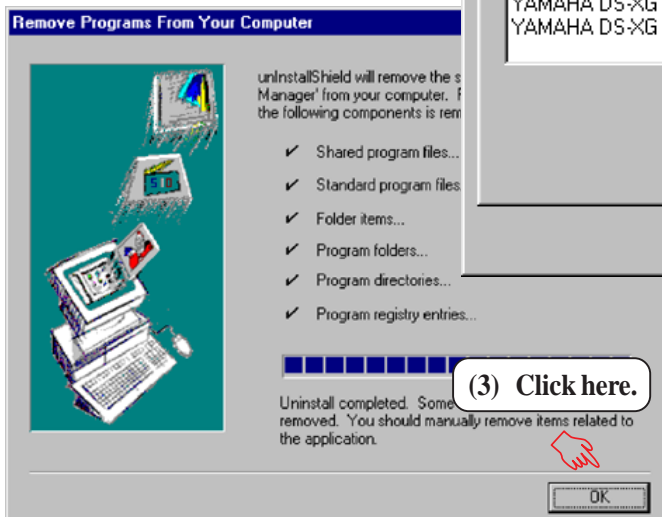
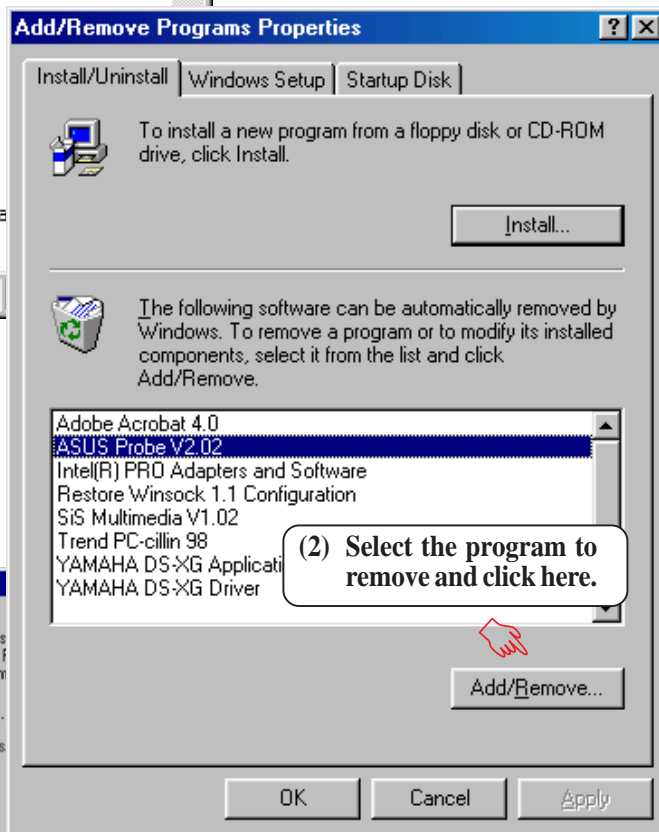
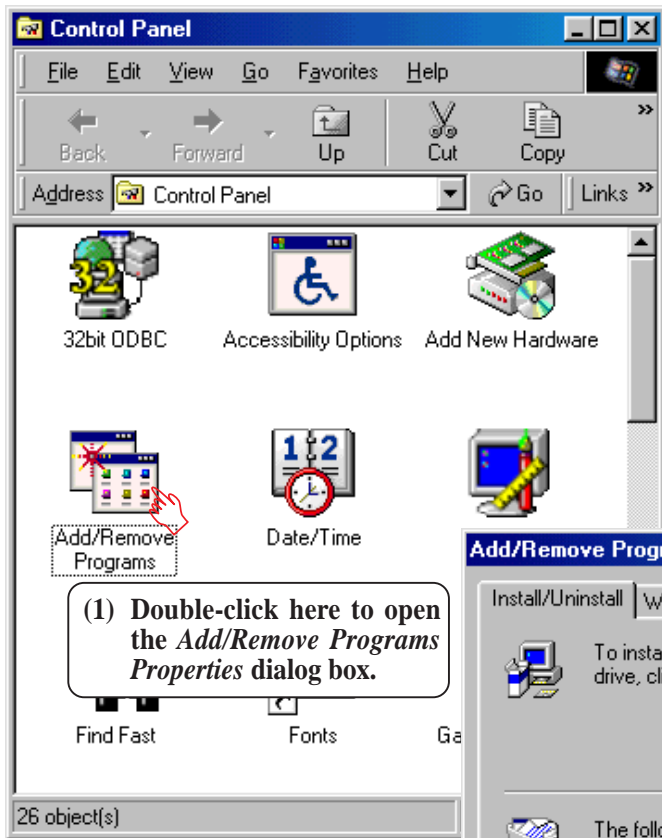

(1) Double-click here to open the *Add/Remove Programs Properties* dialog box.

(2) Select the program to remove and click here.

(3) Click here.

6. SOFTWARE REFERENCE

6.1 ASUS PC Probe

ASUS PC Probe is a convenient utility to continuously monitor your computer system's vital components, such as fan rotations, voltages, and temperatures. It also has a utility that lets you review useful information about your computer, such as hard disk space, memory usage, and CPU type, CPU speed, and internal/external frequencies through the DMI Explorer.

6.1.1 Starting ASUS PC Probe

When ASUS PC Probe starts, a splash screen appears allowing you to select whether to show the screen again when you open PC Probe or not. To bypass this startup screen, clear the **Show up in next execution** check box.

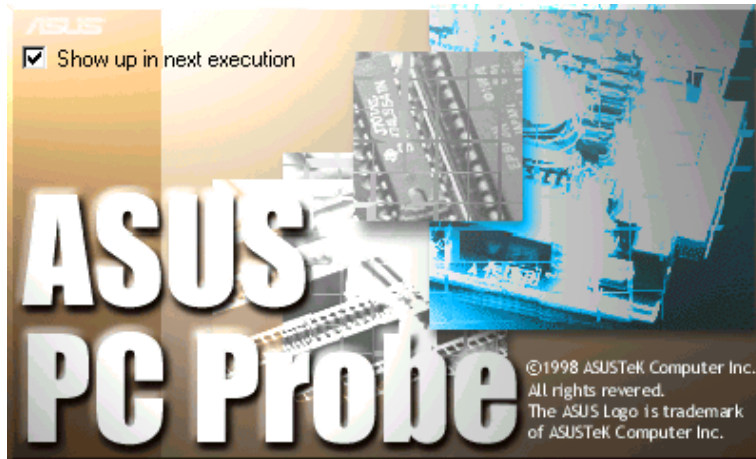

To open **ASUS PC Probe**, click the Windows **Start** button, point to **Programs**, and then **ASUS Utility**, and then click **Probe Vx.xx**.

The PC Probe icon  will appear on the taskbar's system tray indicating that ASUS PC Probe is running. Clicking the icon will allow you to see the status of your PC.

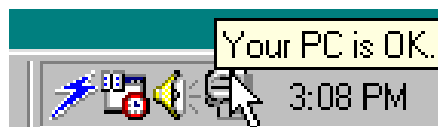

6. SOFTWARE REFERENCE

6.1.2 Using ASUS PC Probe

Monitoring

Monitor Summary

Shows a summary of the items being monitored.



Temperature Monitor

Shows the PC's temperature.

Temperature Warning threshold adjustment
(Move the slider up to increase the threshold level or down to decrease the threshold level)



Fan Monitor

Shows the PC's fan rotation.

Fan Warning threshold adjustment
(Move the slider up to increase the threshold level or down to decrease the threshold level)

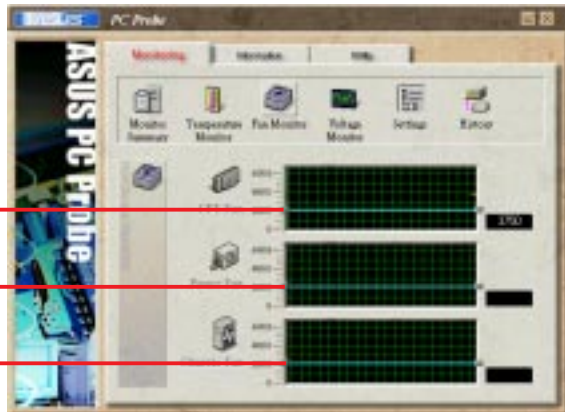

Voltage Monitor

Shows the PC's voltages.

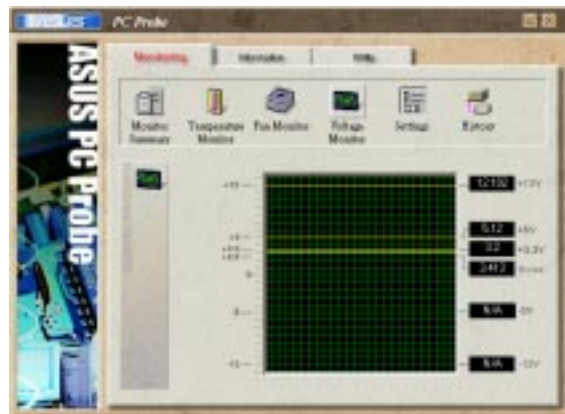

6. SOFTWARE REFERENCE

Settings

Lets you set threshold levels and polling intervals or refresh times of the PC's temperature, fan rotation, and voltages.



History

Lets you record the monitoring activity of a certain component of your PC by date, time, and target history.



Information

Hard Drives

Shows the used and free space of the PC's hard disk drives and the file allocation table or file system used.



Memory

Shows the PC's memory load, memory usage, and paging file usage.



6. SW REFERENCE
ASUS PC Probe

6. SOFTWARE REFERENCE

Device Summary

Shows a summary of devices in your PC.



DMI Explorer

Shows information pertinent to the PC, such as CPU type, CPU speed, and internal/external frequencies, and memory size.



Utility

Lets you run programs outside of the ASUS Probe modules. To run a program, click **Execute Program**.



6. SOFTWARE REFERENCE

6.1.3 ASUS PC Probe Task Bar Icon

Right clicking the PC Probe icon will bring up a menu to open or exit ASUS PC Probe and pause or resume all system monitoring.

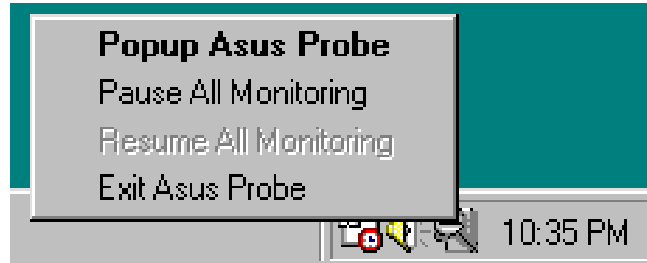

When the ASUS PC Probe senses a problem with your PC, portions of the ASUS PC Probe icon changes to red, the PC speaker beeps, and the ASUS PC Probe monitor is displayed.

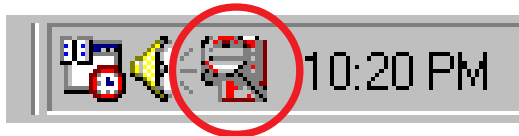

6. SOFTWARE REFERENCE

(This page was intentionally left blank)

6. SOFTWARE REFERENCE

6.2 SiS 620 Display Properties

The built-in 2D/3D AGP VGA on the SiS 620 AGPset supports professional graphics design, gaming, learning, and business applications.

To open the **SiS 620 Properties** dialog box, click **Start**, point to **Settings**, click **Control Panel**, double-click **Display**, click the **Settings** tab, and then the **Advanced** button.

6.2.1 General

The **Display** box displays the current font size of the selected monitor. To use a different font size, click the arrow, and then click the font size you want.

The **Compatibility** box lets you specify that you want your computer to apply changes to system color settings without restarting. **NOTE:** Some programs might not display colors correctly without being restarted after you make changes. To avoid this problem, close the program, change the color settings, and then open the program again.



6.2.2 Adapter

Shows what type of display adapter you are currently using. To install the software for a new display adapter, click **Change**.



NOTE: Your system may not show all of the settings here.

6. SOFTWARE REFERENCE

6.2.3 Monitor

Shows what type of monitor you are currently using. To install the software for a new monitor, click **Change**.



6.2.4 Performance

Specifies the degree of acceleration you want for your graphics hardware. Full acceleration is the fastest and is recommended for most computers. If your computer is having problems and you suspect graphics acceleration to be the cause, use the highest setting at which you do not have problems.



6.2.5 Color Management

Lists all the color profile currently associated with your monitor. Click a profile to make it the active profile. Otherwise, the default profile is the active profile.

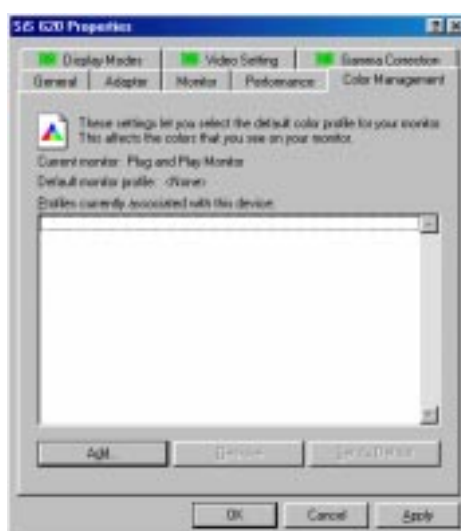

6. SOFTWARE REFERENCE

6.2.6 Display Modes

Lets you adjust the size of your screen. This function also allows you to manipulate the screen refresh rate, color depth, and font size.

Colors

Your color depth choice affects possible maximum resolution and refresh rate.

Desktop area

Use the slider to adjust screen resolution.

Font size

Click the **Custom** button to open the Custom Font Size dialog box to create your own font sizes for your display.

Refresh rate

Use refresh rates of at least 72Hz to avoid flickering

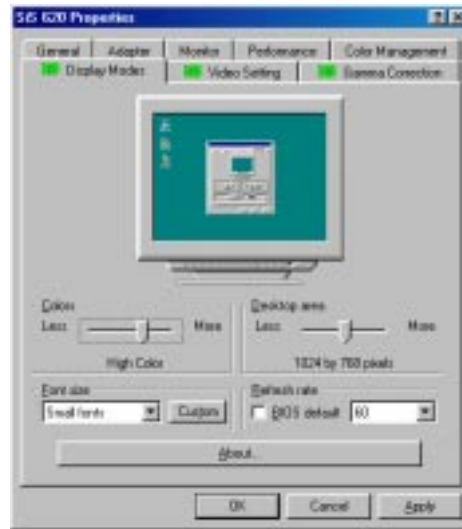

When you have finished making adjustments, click **OK**. You will see the following prompt.

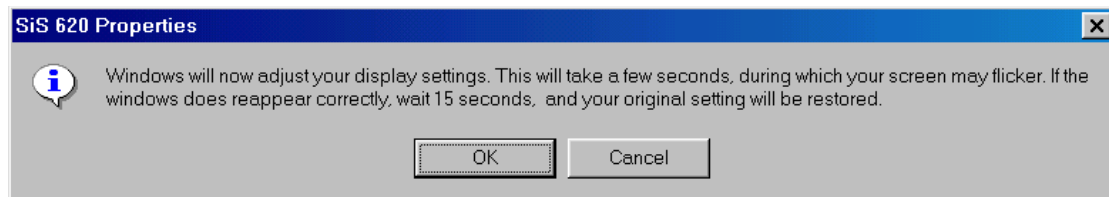

If you do not answer the prompt within 15 seconds, your original settings will be restored. You may also press <ESC> to abort the settings changes. **NOTE:** Some settings require you to restart the computer for the settings to take effect.

6.2.7 Video Setting

Allows you to adjust the brightness and contrast of the screen output. This function is available only in 16-bit color (high color, 65K-color) and 32-bit (true color plus 8 bits for an alpha channel, 16.7M-color) color depths.



6. SOFTWARE REFERENCE

6.2.8 Gamma Correction

Allows you to adjust the quality of your display according to your preference. Gamma correction is available only in 16-bit color and 24-bit color (true color, 16.7M-color) modes. In 16-bit color and 8-bit color (standard color, 256-color) modes, gamma correction function is not supported.

TINT

Lets you set the tint of your display.

Change Bitmap

Lets you change the default preview picture (flower).

Setting Gamma

Lets you set the color mapping of your monitor or display. **NOTE:** The sliders to the right allow you to adjust the individual channels.

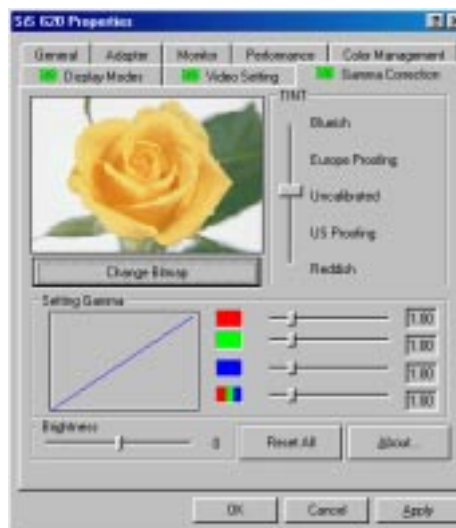

6. SOFTWARE REFERENCE

6.3 Using YAMAHA XGstudio Player

To start the YAMAHA XGstudio, click **Start**, point to **Programs**, point to **YAMAHA XGstudio**, and then click **XGstudio Player**.

6.3.1 YAMAHA XGstudio Player Control Panel



Closes the player. **NOTE:** You can also close the player by pressing <Alt>+<F4>.



Minimizes the player to an icon.



Displays the *Set Play List* dialog box where you can create a list of songs to play automatically. **NOTE:** You can also display the Set Play List dialog box by pressing <Ctrl>+<O>.



Loads and plays the MIDO file currently selected in *Play List*. When all the songs in the Play List have finished, playing stops automatically and the song at the beginning of the list is designated as the current-play song.



Pauses the playing of a song. Click this button again or click  to resume playing.



Stops the playing of a song and returns the start-play location to the beginning of the song.



Designates the first song in the Play List as the new current-play song.



Designates the song just before the currently playing song as the new current-play song.



Designates the song after the song currently playing as the new current-play song.



Designates the last song in the Play List as the new current-play song.



Speeds up the tempo of the song being played.



Slows down the tempo of the song being played.

NOTE: The tempo is reset to 0 for each new song.



Displays the *Set Sound Source* dialog box.



Displays Help. **NOTE:** You can also display Help by pressing <F1>.



Increases/decreases the volume level of the song being played by dragging the slider up/down.

6. SOFTWARE REFERENCE

6.3.2 Troubleshooting

Cannot install

- Do you have the required hardware, such as hard disk and memory?
- Do you have the required software, such as MS-DOS and Windows?
- Installation may not be possible if you have insufficient space on your hard disk. Delete unneeded files to increase the free space on your disk.

Does not start

- Do you have the required hardware, such as hard disk and memory?
- Do you have the required software, such as MS-DOS and Windows?
- Were you able to install using the specified procedure?

No sound

- Is the MIDI driver correctly installed?
- Is the tone generator set correctly?
- Is volume set to zero in the XGstudio Player or XGstudio Mixer panels?
- If you are using an external tone generator, is the serial or MIDI cable and the audio cables connected correctly?
- Are the volumes of your tone generator, audio playback system, and application raised?
- If you have connected an external tone generator via a serial cable, is the rear panel select switch set correctly? (For the name of the select switch, refer to the owner's manual for your external tone generator.)
- If you are using a Soft Synthesizer, is it set so that the computer sound output is heard correctly?

6.3.3 About the driver

In order to use XGstudio, the driver must be correctly set and selected. The driver you use will differ depending on the type of your tone generator.

If you are using an external MIDI tone generator whose HOST connector is connected to the serial port of your computer, you must install the YAMAHA CBX Driver.

Tone generator used	Driver to select and set
Soft Synthesizer S-YG20	Select the YAMAHA SGMP Driver
Soft Synthesizer S-YG50	Select the YAMAHA SXG50 Driver
External YAMAHA tone generator (MU80 or MU50 etc.)	Select the YAMAHA CBX Driver
External tone generator of another manufacturer	Refer to the owner's manual for your tone generator.

6. SOFTWARE REFERENCE

6.4 Using YAMAHA XGstudio Mixer

To start the YAMAHA XGstudio, click **Start**, point to **Programs**, point to **YAMAHA XGstudio**, and then click **XGstudio Mixer**.

6.4.1 YAMAHA XGstudio Mixer Control Panel

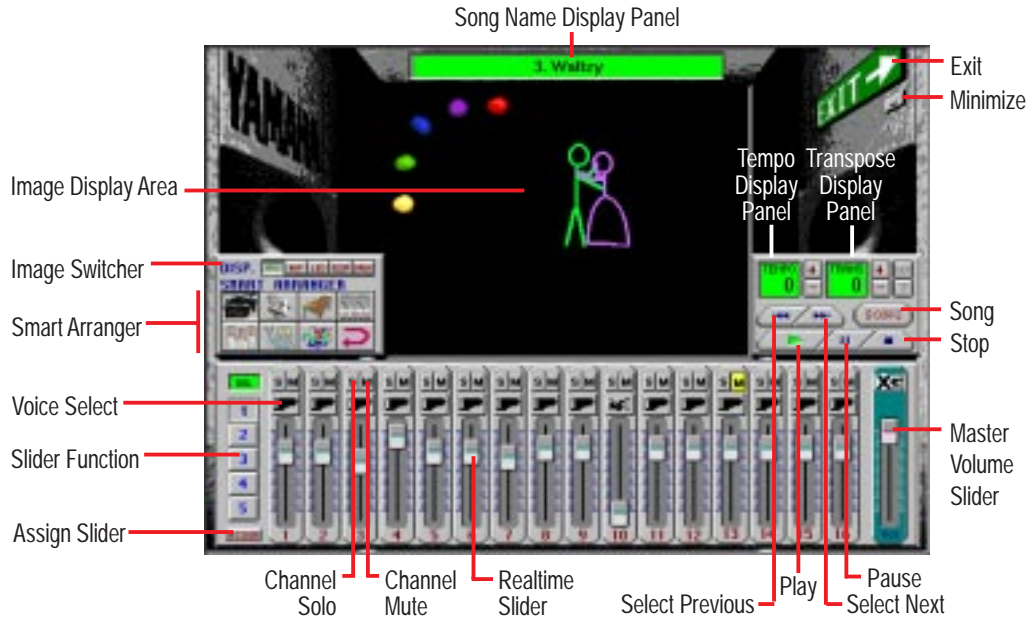

Image Switcher



(AVI file): Video image

Displays the AVI file with the same name as the MIDI file being played. If one is not available, the preset **DEFAULT.AVI** file is played.



(BMP file): Still image

Displays the BMP file with the same name as the MIDI file being played. If one is not available, the preset **DEFAULT.BMP** file is played.



(LED velocity meter): Animation

Displays the volume (amount of velocity) of each MIDI channel.



(SCOPE velocity meter): Animation

Displays the volume (amount of velocity) of each MIDI channel graphically in a radio chart.





(drum and percussion): Animation

Displays animation with lights that match the drums and percussion used in the drum channel (10ch).

6. SOFTWARE REFERENCE

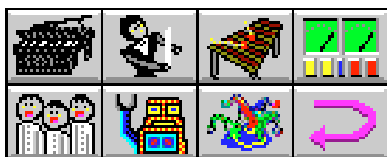
Smart Arranger



The Smart Arranger allows you to easily change the mood of a song. You can switch between seven ensemble voice sets with these buttons. To return to the original voice set, click .



6.4.2 About the video display screen

If an AVI file (a file containing motion video data) or a BMP file (a file containing still image data) with the same name as the MIDI file is placed in the same folder as the MIDI file, the motion video or still image will be automatically loaded and displayed in the screen when the MIDI file is played.

If there is no AVI file or BMP file with the same name as the MIDI file, the DEFAULT.AVI or DEFAULT.BMP file found in the same folder as CSMIXER.EXT will be displayed. Sample files are included, but you may provide your own favorite AVI file or BMP file. To select a file, click the display screen to bring up the BMP Setup or AVI Setup popup menus.

NOTE: The BMP file should not exceed 320 x 240 pixels.

6. SOFTWARE REFERENCE

6.5 YSTATION32

The YSTATION32 consists of CD, MIDI, and WAVE players. The WAVE component can record and playback WAV format files.

There are six components: Power Control, CD, MIDI, WAVE, Multi, and Mixer. They can be arranged in any order, and it is not necessary for all components to be open all the time.

You can play WAVE and MIDI (.WAV and .MID) files simply by dragging and dropping them from the File Manager.

6.5.1 System requirements

- At least 1MB of available hard disk space
- Windows 95, Windows NT 4.0
- Onboard audio option

6.5.2 Using YAMAHA Ystation Player

To start the YAMAHA Ystation Player, click **Start**, point to **Programs**, point to **YAMAHA DS-XG**, and then click **YSTATION32**.



6. SOFTWARE REFERENCE

Power Control Component

This component manages and launches the other components.



WAVE Component

This component plays and records WAVE format files. The recording source can be CD(AUX), MIC or LINE. The window display shows the file name, format, and time.



MIDI Component

This component plays Standard MIDI Files (SMF). The window display shows the file name, tempo, and time.



CD Component

This component plays audio CDs. The window display shows the track, title, song name, and time.



MIXER Component

This component controls playback and recording of your sound card.

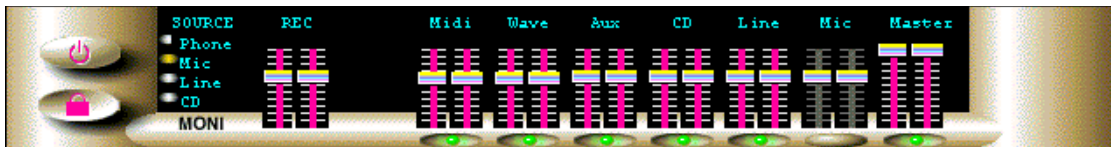

MULTI Component

This component controls simultaneous playback of the CD, MIDI, and WAVE components.

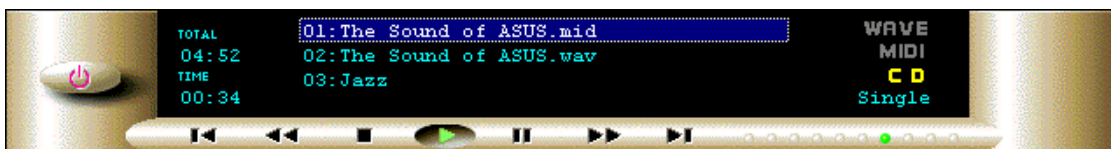

6. SOFTWARE REFERENCE











How to Play

Common operations of the CD, MIDI, WAVE, and MULTI player. Each component has the following basic functions:

Play, Stop, Pause, Fast Forward, Rewind.

The CD player also has Next and Previous functions.

Component buttons are marked with symbols commonly found on audio players. So if you've ever used an audio player, you'll find YSTATION32 operation quite straightforward.

-  Stop
-  Pause
-  Play
-  Scan backward
-  Scan forward
-  Go to beginning of previous song
-  Go to beginning of next song
-  Show/remove component
-  Open *File Open* dialog box.
-  Open/close the CD-ROM drive (CD player only)
-  Repeat playback indefinitely (CD player only)

If your CD-ROM drive does not support the Eject function, nothing will happen when you click the **Eject** button.

Titling CDs

Clicking the **Name** button on the CD Component accesses the *Name CD* dialog box shown below. This allows you to enter the CD title and track names. The CD title can be up to 25 characters long. Track names can be up to 25 characters long, although, only the first 22 characters are displayed on the CD Component's display.



Click the buttons, and experiment with the YSTATION32!

6. SOFTWARE REFERENCE

Playlist

The Playlist allows you to arrange CD tracks, MIDI songs, and WAVE sound files into a program of your choice. Playback starts with the first item in the playlist and continues until all items have been played. The Play Mode can be set to **Repeat** so that the playlist items are played repeatedly.

Click the **LIST** button on the Power Control component.

In the *Playlist* dialog box, shown below, arrange your CD, MIDI, and WAVE data as desired.

You can enter the title of your CD.

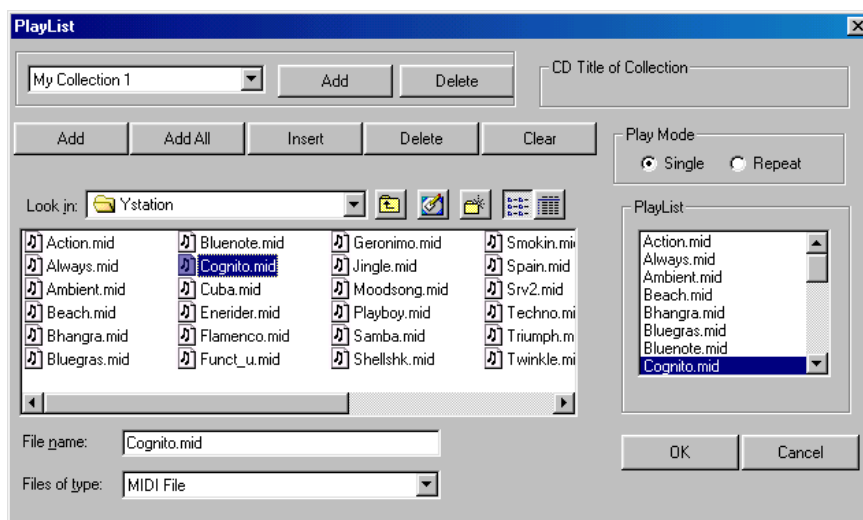

Play Mode

When set to **Single**, the data in the play list is played once. When set to **Repeat**, the data in the play list is played repeatedly.

Clicking the **OK** button saves the play list in the \Windows\Ystation.ini file. If the currently loaded CD is different from the one specified in the play list, an error message appears. This means that the song name on the CD does not match that in the play list. In this case you should edit the play list. Otherwise the error message will appear repeatedly.

6. SOFTWARE REFERENCE

Configuration

Click the **CONFIG** button on the Power Control component. In the *Config* dialog box you can configure the YSTATION32.

Auto Play

When Auto Play is OFF, the WAVE, MIDI, CD, and MIX components open when the YSTATION32 is started. When Auto Play is ON, data registered in the play list plays sequentially when the YSTATION32 is started.

If Play Mode on the PlayList dialog box is set to **Repeat** and Auto Play is ON, data registered in the play list plays repeatedly when the YSTATION32 is started.

Display mode

When Auto Play is ON, you can decide which components are displayed. When set to **Select**, components whose box in the Component Select section are checked are displayed. When set to **Now Playing**, only the component currently playing is displayed.

Component Select

The Component Select check boxes allow you to select which components are used for Auto Play. Components whose box is checked are used for Auto Play. These settings are active only when the Display mode is set to Select.

Recording Mode

- | | |
|-----------|-----------------------------|
| New | Create a new file |
| Overwrite | Overwrite the existing file |
| Add | Append to the current file |

Sampling Rate

These buttons allow you to set the sampling rate for recording Wave files.

Type

These buttons allow you choose either mono or stereo Wave file recording.

Data Format

These buttons allow you to set the data format to either 8 or 16 bit.

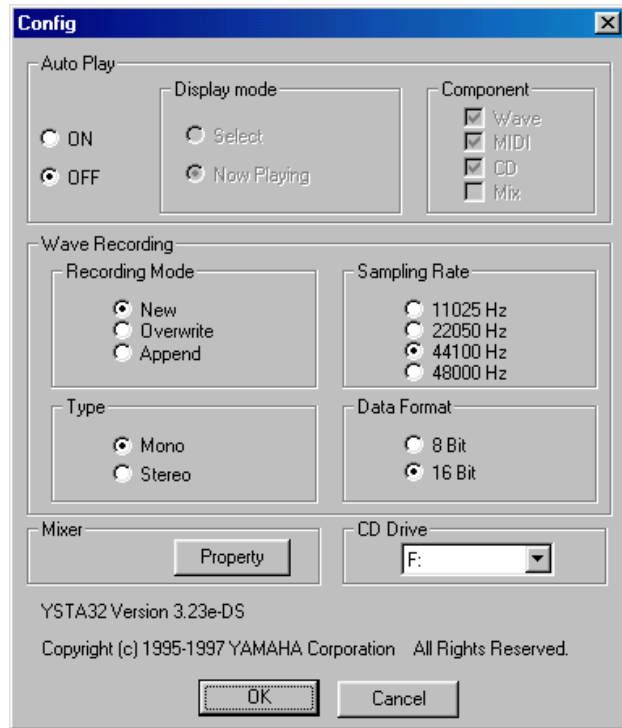

6. SOFTWARE REFERENCE

Property

Output

The playback volume controls whose check boxes are checked will be displayed as mixer components. Up to seven volume controls may be selected.

Input

The recording volume controls whose check boxes are checked will be displayed as mixer components. Up to four volume controls may be selected.

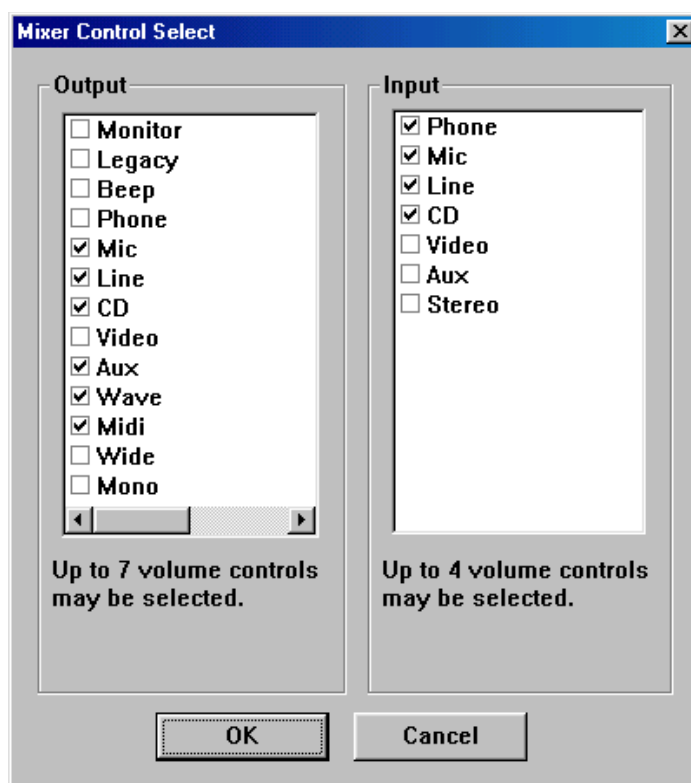

6.5.3 Error Messages

The following is a list of YSTATION32 error messages.

“Can’t open window”

This message appears if a window cannot be opened when YSTATION32 is started.

“Disc not loaded”

This message appears if you click the NAME button on the CD Component and no CD is loaded.

“The Wave data has changed. Save current changes?”

This message appears if you attempt to quit with unsaved changes.

“A Wave file with this name already exists. Overwrite?”

This message appears if you attempt to save a Wave file using a name that is already used.

“Can’t get timer”

This message appears during playback if the Timer resources are insufficient.

“The CD loaded is different to that in the Playlist”

This message appears when you click the LIST button on the Power Component and the currently loaded CD is different to that specified in the Playlist.

7. APPENDIX

7.1 ASUS PCI-L101 Fast Ethernet Card

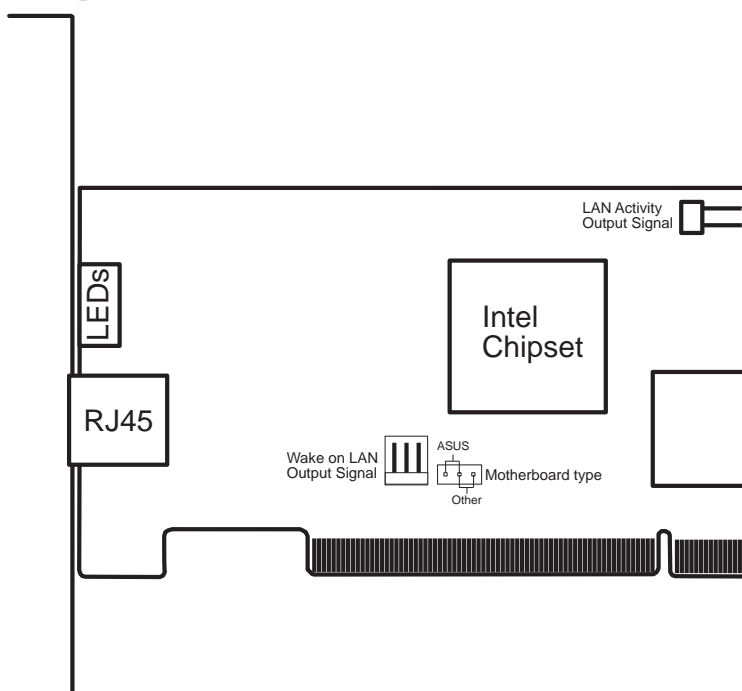
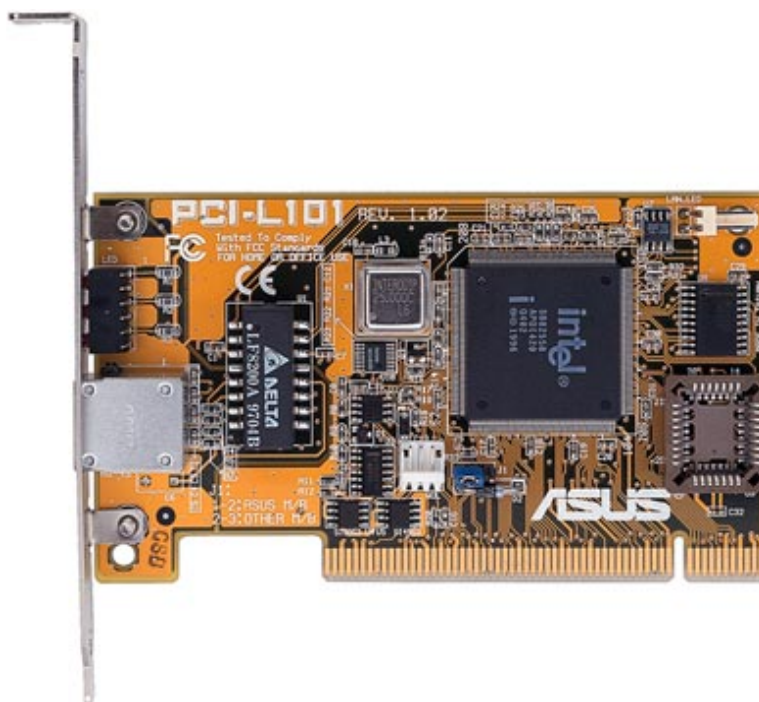

If you are using the ASUS PCI-L101 on an ASUS motherboard, leave the jumper on its default setting of “ASUS.” If you are using another brand of motherboard, set the jumper to “Other.” Connect the Wake on LAN (WOL) output signal to the motherboard’s WOL_CON to utilize the Wake-On-LAN feature of the motherboard. Connect the LAN activity output signal (LAN_LED) to the system cabinet’s front panel LAN_LED to display LAN data activity.

7. APPENDIX

7.1.1 Features

- Intel 82558 Ethernet LAN Controller (Fully integrated 10BASE-T/100BASE-TX)
- Wake-On-LAN Remote Control Function Supported
- PCI Bus Master Complies with PCI Local Bus Rev. 2.1 specifications
- Consists of MAC & PHY (10/100Mbps) interfaces
- Complies with IEEE 802.3 10BASE-T and IEEE 802.3u 100BASE-TX interfaces
- Fully supports 10BASE-T & 100BASE-TX operations through a single RJ45 port
- Supports 32-bit Bus Master Technology / PCI Rev. 2.1
- Enhancements on ACPI & APM
- Adheres to PCI Bus Power Management Interface Rev. 1.0, ACPI Rev. 1.0, and Device Class Power Management Rev. 1.0
- IEEE 802.3u auto-negotiation for 10Mbps/100Mbps Network Data Transfer Rates.
- Provides LED indicators for monitoring network conditions
- Plug and Play

7.1.2 Software Driver Support

- **NetWare ODI Drivers** - Novell Netware 3.x, 4.x, DOS, OS/2 Client
- **NDIS 2.01 Drivers** - Microsoft LAN Manager, Microsoft Windows 3.11, IBM LAN Server
- **NDIS 3.0 Drivers** - Microsoft Windows NT, Microsoft Windows 95, Microsoft Windows 3.11

7.1.3 Question and Answer

Q: What is Wake-On-LAN?

A: The Wake-On-LAN feature provides the capability to remotely power on systems supporting Wake-On-LAN by simply sending a wake-up frame. With this feature, remotely uploading/downloading data to/from systems during off-peak hours will be feasible.

Q: What can Wake-On-LAN do for you?

A: Wake-On-LAN is a remote management tool with advantages that can reduce system management workload, provide flexibility to the system administrator's job, and then of course save you time-consuming efforts and costs.

Q: What components are required for Wake-On-LAN to function?

A: To enable Wake-On-LAN function, your system requires an Ethernet LAN adapter card that can activate Wake-On-LAN function, a client with Wake-On-LAN capability, and software such as LDCM Rev. 3.10 or up that can trigger wake-up frame.