

## **Mainboard User's Manual**

This publication, including all photographs, illustrations and software, is protected under international copyright laws, with all rights reserved. Neither this manual, nor any of the material contained herein, may be reproduced without written consent of the author.

The information in this document is subject to change without notice. The manufacturer makes no representations or warranties with respect to the contents hereof and specifically disclaims any implied warranties of merchantability or fitness for any particular purpose. Further, the manufacturer reserves the right to revise this publication and to make changes from time to time in the content hereof without obligation of the manufacturer to notify any person of such revision or changes.

### **Trademarks**

IBM, VGA, and PS/2 are registered trademarks of International Business Machines.

Intel, Pentium/II/III, Pentium 4, Celeron and MMX are registered trademarks of Intel Corporation.

Microsoft, MS-DOS and Windows 98/ME/NT/2000/XP are registered trademarks of Microsoft Corporation.

PC-cillin is a registered trademark of Trend Micro Inc.

AMI is a registered trademark of American Megatrends Inc.

A3D is a registered trademark of Aureal Inc.

MediaRing Talk is a registered trademark of MediaRing Inc.

3Deep is a registered trademark of E-Color Inc.

SiS is a trademark of Silicon Integrated System Corporation.

Other names used in this publication may be trademarks and are acknowledged.

**Copyright © 2002  
All Rights Reserved  
M930 Series, V5.1A  
S645XD/April 2002**

## Mainboard User's Manual

### Notice:

1. Owing to Microsoft's certifying schedule is various to every supplier, we might have some drivers not certified yet by Microsoft. Therefore, it might happen under Windows XP that a dialogue box (shown as below) pop out warning you this software has not passed Windows Logo testing to verify its compatibility with Windows XP. Please rest assured that our RD department has already tested and verified these drivers. Just click the "Continue Anyway" button and go ahead the installation.



### 2. DDR333 SUPPORT LIST

Type	Brand	Chip	Total	Result	Note
DDR	NANYA	NT5DS16MBAT-6	128MB	PASS	
	NANYA	NT5DS16MBAT-6	256MB	PASS	
	KINGMAX	KDL684T4A2A-06	128MB	PASS	
	KINGMAX	KDL684T4A2A-06	256MB	PASS	
	Twin MOS	Hynix HY5DU28822AT-K	256MB	PASS	

## Mainboard User's Manual

### Table of Contents

Chapter 1: Introduction.....	1
Key Features.....	2
Package Contents.....	6
Static Electricity Precautions.....	7
Pre-Installation Inspection.....	7
Chapter 2: Mainboard Installation.....	9
Mainboard Components.....	10
I/O Ports.....	11
Install A CPU.....	12
Installing Memory Modules.....	13
Setting Jumper Switches.....	15
Install the Mainboard.....	16
Optional Extension Brackets.....	17
Install Other Devices.....	19
Expansion Slots .....	22
Chapter 3: BIOS Setup Utility.....	23
Introduction.....	23
Running the Setup Utility.....	24
Standard CMOS Setup Page.....	25
Advanced Setup Page.....	26
Power Management Setup Page.....	29
PCI/Plug and Play Setup Page.....	30
Load Optimal Settings.....	31
Load Best Performance Settings.....	31
Features Setup Page.....	32
CPU PnP Setup Page.....	34
Hardware Monitor Page.....	35
Change Password.....	36
Exit.....	36
Chapter 4: Software & Applications.....	37
Introduction.....	37
Installing Support Software.....	38
Bundled Software Installation.....	40

**Mainboard User's Manual**

---

## Chapter 1

### Introduction

---

This mainboard has a **Socket-478** processor socket for **Intel Pentium 4** type of processors supporting front side bus (FSB) speeds up to **400/533 MHz**.

This mainboard integrates the **SiS 645/DX** Northbridge along with **961A/961B/962** Southbridge chipsets that supports built-in **AC97 Codec** support 4-channel speak-out, **2 DDR + 2 SDR** modules up to 2GB system memory. These chipsets' function is detailed as the Chipset description in next section. This mainboard has one **4X AGP** slot for highly graphics display, one **AMR** (Audio Modem Riser) slot to support Audio and Modem application, and built-in **10BaseT/100BaseTX Network Interface**. There is a full set of I/O ports including two PS/2 ports for mouse and keyboard, two serial ports, one parallel port, one MIDI/game port and four USB ports -- two backpanel ports and onboard USB header USB1 providing two extra ports (they will support USB 2.0 if SiS 962 SB installed on the mainboard). By means of the Extended USB Module connected to the mainboard, you can make two extra USB ports.

This mainboard is an ATX mainboard that uses a 4-layer printed circuit board and measures 305 x 244mm.

## Mainboard User's Manual

### Key Features

The key features of this mainboard include:

#### Socket-478 Processor

- ◆ The PGA Socket 478
- ◆ Supports **Intel Pentium 4 series** CPUs
- ◆ Supports up to 400/**533** MHz Front-Side Bus(**only SiS 645DX NB supports 533MHz**)

#### Chipset

There are **SiS 645/DX Northbridge** and **SiS961/962 Southbridge** in this chipset in accordance with an innovative and scalable architecture with proven reliability and performance. Here is a list of the chipset arrangement and their respective features:

Northbridge	Southbridge	Function
SiS 645/ <b>DX</b>	961A	CPU FSB: 400/ <b>533</b> MHz Ultra DMA ATA100
SiS 645/ <b>DX</b>	961B	CPU FSB: 400/ <b>533</b> MHz Ultra DMA ATA133
SiS 645 <b>DX</b>	962	CPU FSB: <b>533</b> MHz Ultra DMA ATA133 USB2.0 and IEEE1394(optional)

*Notice: The SiS645 Northbridge has been verified to support CPU FSB 400MHz and run **DDR333**. You might try it up to **533MHz**, and only running **DDR266(not DDR333)** based on an overclocking technique; nevertheless, overclocking perhaps comes with some risks that we do not guarantee an absolutely normal operation while working up to 533MHz.*

#### Memory Support

- ◆ Two 168-pin DIMM slots for SDRAM memory modules
- ◆ Two 184-pin DIMM slots for DDR memory modules
- ◆ Support SDRAM up to 133 MHz /DDR up to 333 MHz memory bus
- ◆ Maximum installed memory is 2GB

*Notice: You can NOT use SDRAM and DDR simultaneously.*

#### Expansion Slots

- ◆ One AMR slot for a special audio/modem riser card

## 1: Introduction

- ◆ One 4xAGP slot for AGP 2.0-compliant interface
- ◆ Five 32-bit PCI slots for PCI 2.2-compliant bus interface

### Onboard IDE channels

- ◆ Primary and Secondary PCI IDE channels
- ◆ Support for PIO (programmable input/output) modes
- ◆ Support for Multiword DMA modes
- ◆ Support for Bus Mastering and Ultra DMA ATA 100/133 modes

### Power Supply and Power Management

- ◆ ATX power supply connector
- ◆ Meets ACPI 1.0b and APM 1.2 requirements, keyboard power on/off
- ◆ Supports RTC Alarm, Wake On Modem, AC97 Wake-Up and USB Wake-Up

### VGA

- ◆ This mainboard includes a 4xAGP slot that provides four times the bandwidth of the original AGP specification. AGP technology provides a direct connection between the graphics sub-system and memory so that the graphics do not have to compete for processor time with other devices on the PCI bus.

### AC97 Audio Codec: CMI9738

- ◆ Compliant with AC'97 2.2 specification
- ◆ Full-duplex Codec with independent and variable sampling rate
- ◆ Earphone Buffer Built-In, SNR up to 90db
- ◆ 4Ch DAC, support 4-channel speak-out
- ◆ Advanced power management support

### Onboard I/O Ports

The mainboard has a full set of I/O ports and connectors:

- ◆ Two PS/2 ports for mouse and keyboard
- ◆ Two serial ports

## Mainboard User's Manual

- ◆ One parallel port
- ◆ One MIDI/game port
- ◆ Four USB ports (two backpanel ports, onboard USB headers providing two extra ports)
- ◆ Audio jacks for microphone, line-in and line-out

## Hardware Monitoring

- ◆ Built-in hardware monitoring for CPU & System temperatures, fan speeds and mainboard voltages.

## Onboard Flash ROM

- ◆ Supports Plug and Play configuration of peripheral devices and expansion cards

## Built-in Ethernet LAN

- ◆ Built-in **10BaseT/100BaseTX Ethernet LAN**
- ◆ SiS961 Embedded Fast Ethernet MAC and onboard Realtek RTL8201 LAN PHY compliant with IEEE802.3u 100BASE-TX, 10BASE-T and ANSI X3.263 TP-PMD standards
- ◆ Compliant with ACPI 1.0 and the Network Device Class Power Management 1.0
- ◆ High Performance provided by 100Mbps clock generator and data recovery circuit for 100Mbps receiver

## USB 2.0 (for SiS962 SB only)

- ◆ Compliant with Universal Serial Bus Specification Revision 2.0
- ◆ Compliant with Intel's Enhanced Host Controller Interface Specification Revision 0.95
- ◆ Compliant with Universal Host Controller Interface Specification Revision 1.1
- ◆ PCI multi-function device consists of two **UHCI Host Controller** cores for full-/low-speed signaling and one **EHCI Host Controller** core for high-speed signaling
- ◆ Root hub consists 4 downstream facing ports with integrated physical layer transceivers shared by **UHCI** and **EHCI** Host Controller



## 1: Introduction

- ◆ Support PCI-Bus Power Management Interface Specification release 1.1
- ◆ Legacy support for all downstream facing ports

### IEEE 1394 (for SiS962 SB only)

- ◆ Fully supports provisions of IEEE1394-1995 for high-performance serial bus and the P1394a draft 2.0 standard
- ◆ Provides three fully compliant cables ports at 100/200/400 Mbits/s and available with one, two or three ports
- ◆ Supports optional 1394 Annex J electrical isolation barrier at PHY-link interface
- ◆ Supports power-down feature to conserve energy in battery powered application
- ◆ Node power-class information signaling for system power management

### Bundled Software

- ◆ **PC-Cillin2000** provides automatic virus protection under Windows 98/ME/NT/2000/XP
- ◆ **MediaRing Talk** provides PC to PC or PC to Phone internet phone communication
- ◆ **3Deep** delivers the precise imagery and displays accurate color in your monitor
- ◆ **Recovery Genius 21<sup>st</sup> V5.0** provides the function to recover, reserve and transfer hard disk data.
- ◆ **CD Ghost** is the software stimulating a real CD-ROM to perform equivalent function.
- ◆ **Language Genius 21<sup>st</sup>** is the software to provide learning tools of language and singing.
- ◆ **PC DJ** is a dual-MP3 player that enables users to actually mix music right on their own personal computers.
- ◆ **Adobe Acrobat Reader V5.0** is the software to help users read .PDF files.

### Dimensions

- ◆ ATX form factor 305 x 244mm

## Mainboard User's Manual

### Package Contents

**Attention:** This mainboard serial has four models, M930DAFULR(DIP, SiS645DX NB+962 SB, LAN Ready), M930DALR(DIP, SiS645DX NB+961B SB, LAN Ready), M930DLR(DIP, LAN Ready) and M930D(without LAN). Please contact your local supplier for more information about your purchased model. Each model will support different specification listed as below:

Model	Specification
M930DAFULR	Onboard LAN PHY chip (U12), USB 2.0+RJ-45 LAN connector, and optional IEEE1394 PHY(U20) with installed SiS645DX NB+SiS962 SB
M930DALR	Onboard LAN PHY chip (U12), USB+RJ-45 LAN connector, with installed SiS645DX NB+SiS961B SB
M930DLR	Onboard LAN PHY chip (U12), USB+RJ-45 LAN connector
M930D	USB connector only

Your mainboard package contains the following items:

- The mainboard
- The User's Manual
- One diskette drive ribbon cable and bracket
- One IDE drive ribbon cable and bracket
- Software support CD

### Optional Accessories

You can purchase the following optional accessories for this mainboard.

- Extended USB module
- AMR v.90 56K Fax/Modem card

## 1: Introduction

### **Static Electricity Precautions**

Static electricity could damage components on this mainboard. Take the following precautions while unpacking this mainboard and installing it in a system.

1. Don't take this mainboard and components out of their original static-proof package until you are ready to install them.
2. While installing, please wear a grounded wrist strap if possible. If you don't have a wrist strap, discharge static electricity by touching the bare metal of the system chassis.
3. Carefully hold this mainboard by its edges. Do not touch those components unless it is absolutely necessary. Put this mainboard on the top of static-protection package with component side facing up while installing.

### **Pre-Installation Inspection**

1. Inspect this mainboard whether there are any damages to components and connectors on the board.
2. If you suspect this mainboard has been damaged, do not connect power to the system. Contact your mainboard vendor about those damages.

**Mainboard User's Manual**

## Chapter 2

# Mainboard Installation

---

To install this mainboard in a system, please follow the instructions in this chapter:

- ❑ Identify the mainboard components
- ❑ Install a CPU
- ❑ Install one or more system memory modules
- ❑ Verify that all jumpers or switches are set correctly
- ❑ Install the mainboard in a system chassis (case)
- ❑ Connect any extension brackets or cables to connecting headers on the mainboard
- ❑ Install other devices and make the appropriate connections to the mainboard connecting headers.

**Note:**

1. Before installing this mainboard, make sure jumper JP4 is under Normal setting. See this chapter for information about locating JP4 and the setting options.
2. Never connect power to the system during installation; otherwise, it may damage the mainboard.

## Mainboard User's Manual

### Mainboard Components

Identify major components on the mainboard via this diagram underneath.

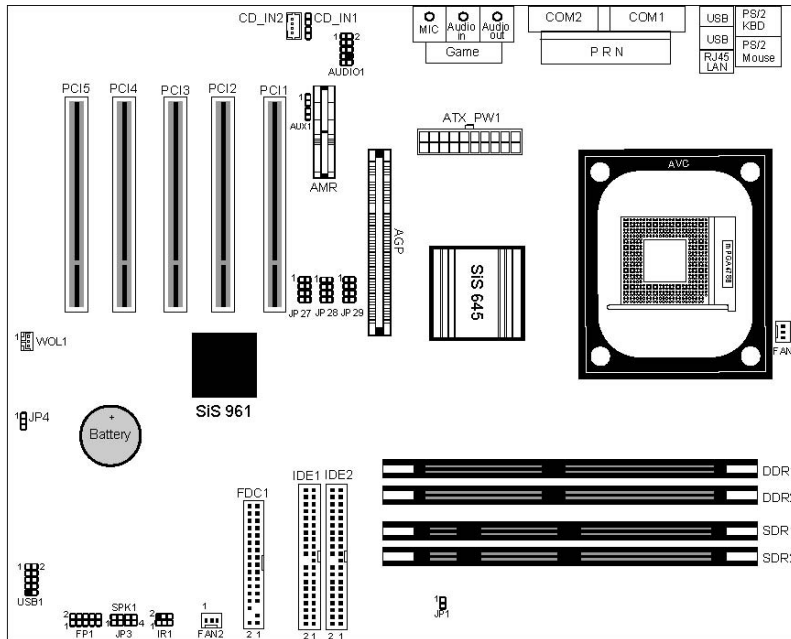

**Note:** Any jumpers on your mainboard that do not appear in the illustration above are for testing only.

## 2: Mainboard Installation

### I/O Ports

The illustration below shows a side view of the built-in I/O ports on the mainboard.

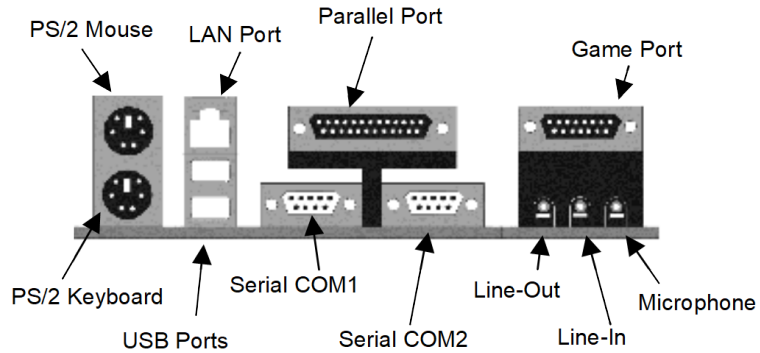

1. Upper PS/2 port connects a PS/2 pointing device.
2. Lower PS/2 port connects a PS/2 keyboard.
3. USB ports connect USB devices.
4. LPT1 connects printers or other parallel communications devices.
5. COM ports connect serial devices such as mice or fax/modems. COM1 is identified by the system as COM1/3. COM2 is identified by the system as COM2/4.
6. Game port connects a joystick or a MIDI device.
7. Three audio ports connect audio devices. The left side jack is for a stereo line-out signal. The middle jack is for a stereo line-in signal. The right side jack is for a microphone.
8. LAN port connects the network.

## Mainboard User's Manual

### Install A CPU

This mainboard has a Socket-478 supporting Intel Pentium 4 series processors.

**To ensure reliability, ensure that your processor has a heatsink/cooling fan assembly.**

Do neither try to install a Socket 370 processor nor a Socket423 in the Socket-478. A Socket 370 processor such as the Pentium III, or Celeron, does not fit in the Socket 478.

The following processor is currently supported by this mainboard.

**Intel P4 478:** 1.4GHz ~ 2.2GHz, FSB: 400MHz

#### Installing a Socket-478 Processor

A processor installs into the ZIF (Zero Insertion Force) Socket-478 on the mainboard.

1. Locate the Socket-478 and CPU FAN1. Pull the locking lever out slightly from the socket and raise it to the upright position.

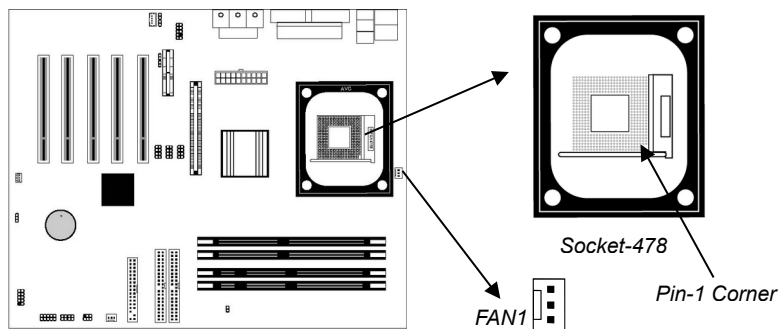

2. On the processor, identify the Pin-1 corner by its beveled edge.
3. On the Socket-478, identify the Pin-1 corner. The Pin-1 corner is at the end of the locking lever when locked.
4. Match the Pin-1 corners and insert the processor into the socket. No force is required and the processor should drop into place freely.



## 2: Mainboard Installation

5. Push down the locking lever and hook it under the catch on the side of the socket. This secures the CPU in the socket.
6. All processors should be installed with a combination heatsink/cooling fan, connect the cable from the fan to the CPU fan power connector CPU FAN1.

### Installing Memory Modules

This mainboard accommodates 168-pin 3.3V/184-pin 2.5V unbuffered SDRAM memory modules. The memory chips must be standard or registered SDRAM (Synchronous Dynamic Random Access Memory).

The CPU supports 100MHz system bus. The SDRAM DIMMs and DDRs can synchronously work with 100 MHz or operates over a 333 MHz system bus.

You must install at least one memory module in order to use the mainboard, **either SDRAM or DDR SDRAM, but you cannot use them simultaneously.**

SDRAM provides 800 MB/s or 1 GB/s data transfer rate corresponding with the bus 100 MHz or 133 MHz. It doubles the rate to 1.6 GB/s and 2.1 GB/s by transferring data on both the rising and falling edges of the clock. DDR SDRAM uses additional power and ground lines and requires 184-pin 2.5V unbuffered DIMM module rather than the 168-pin 3.3V unbuffered DIMMs used by SDRAM.

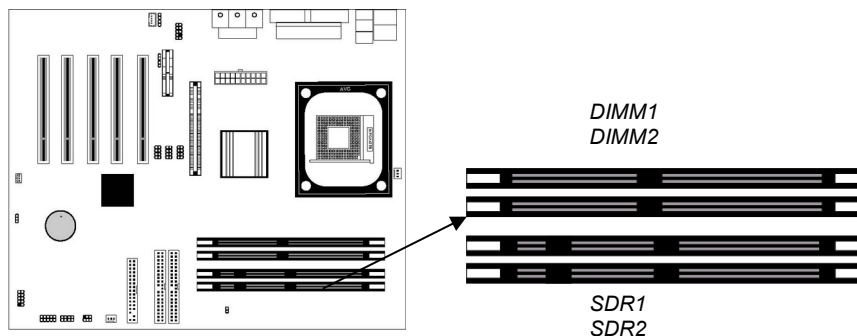

## Mainboard User's Manual

### Installation Procedure

The mainboard accommodates two memory modules. You must install at least one module in any of the three slots. Each module can be installed with up to 2GB system memory.

Refer to the following to install the memory modules.

1. Push the latches on each side of the DIMM slot down.
2. Align the memory module with the slot. The DIMM slots are keyed with notches and the DIMMs are keyed with cutouts so that they can only be installed correctly.
3. Check that the cutouts on the DIMM module edge connector match the notches in the DIMM slot.
4. Install the DIMM module into the slot and press it firmly down until it seats correctly. The slot latches are levered upwards and latch on to the edges of the DIMM.
5. Install any remaining DIMM modules.

## 2: Mainboard Installation

### Setting Jumper Switches

Jumpers are sets of pins connected together with jumper caps. The jumper caps change the way the mainboard operates by changing the electronic circuits on the mainboard. If a jumper cap connects two pins, we say the pins are SHORT. If a jumper cap is removed from two pins, the pins are OPEN.

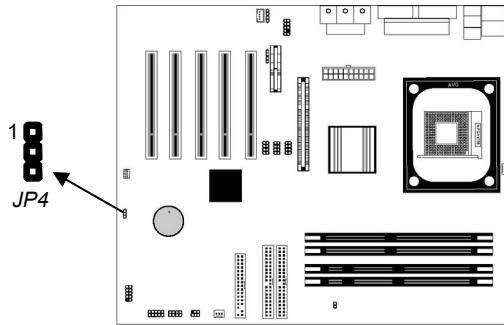

### Jumper JP4: Clear CMOS Memory

Use this jumper to clear the contents of the CMOS memory. You may need to clear the CMOS memory if the settings in the Setup Utility are incorrect and prevent your mainboard from operating. To clear the CMOS memory, disconnect all the power cables from the mainboard and then move the jumper cap into the CLEAR setting for a few seconds.

Function	Jumper Setting
Clear CMOS	Short Pins 1-2
Normal Mode	Short Pins 2-3

## Mainboard User's Manual

### Install the Mainboard

Install the mainboard in a system chassis (case). The board is an ATX size mainboard with a twin-tier of I/O ports. You can install this mainboard in an ATX case. Ensure that your case has an I/O cover plate that matches the ports on this mainboard.

Install the mainboard in a case. Follow the case manufacturer's instructions to use hardware's and internal mounting points on the chassis.

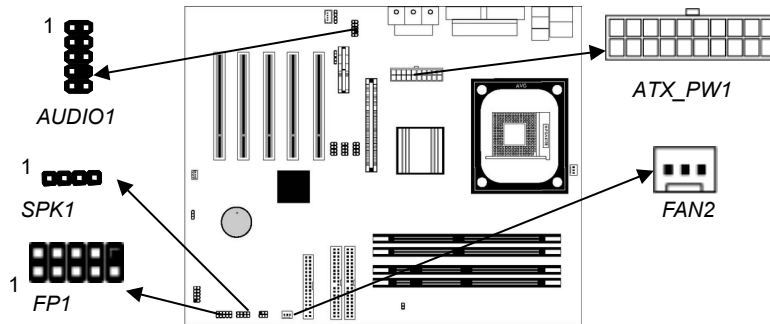

Connect power supply to the **ATX\_PW1** connector on the mainboard.

If there is a cooling fan in the system chassis, connect the cooling fan cable to the **FAN2** fan power connector on the mainboard.

Connect the PC speaker cable to the **SPK1** header on the mainboard.

Pin	Signal	Pin	Signal
1	SPKR	2	NC
3	GND	4	+5V

Connect case switches and indicator LEDs to the **FP1** header. Here is a list of FP1 header's pin assignments.

Pin	Signal	Pin	Signal
1	HDD LED P	2	PWR/ACPI LED
3	HDD LED N	4	PWR/ACPI LED
5	RESET SW N	6	POWER
7	RESET SW P	8	POWER
9	KEY	10	KEY

## 2: Mainboard Installation

If there are a headphone jack or/and a microphone jack on the front panel, connect cables to the **AUDIO1** header on the mainboard. Here is a list of FP1 header's pin assignment.

Pin	Signal	Pin	Signal
1	AUD MIC	2	AUD GND
3	AUD MIC P	4	AUD VCC
5	AUD FPOUT R	6	AUD RET R
7	NC	8	KEY
9	AUD FPOUT L	10	AUD RET L

### Optional Extension Brackets

For this mainboard, you can also obtain a USB module extension bracket for more USB ports. Install them by following the steps below.

*Note: All the ribbon cables used on the extension brackets have a red stripe on the Pin-1 side of the cable.*

### Extended USB Module

This module bracket has two USB ports for more USB devices (USB port 3-4).

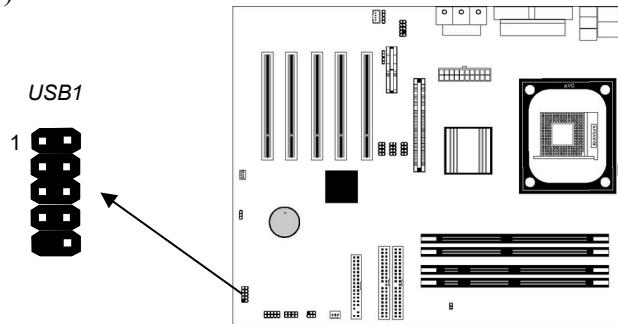

Pin	Signal	Pin	Signal
1	VCC	2	VCC
3	DATA1-	4	DATA2-
5	DATA1+	6	DATA2+
7	GND	8	GND
9	KEY	10	KEY

## Mainboard User's Manual

1. Locate the USB1 header on the mainboard.
2. Plug the bracket cable onto the USB1 header.
3. In the system chassis, remove the blanking plate from the corresponding expansion slot you want to use, and install an extension bracket in there. Secure the extension bracket in the chassis with a screw.

### Extended IEEE1394 Headers (for SiS962 SB only)

You can obtain three optional IEEE1394 headers for SiS962 SB only. Install them by following the steps below.

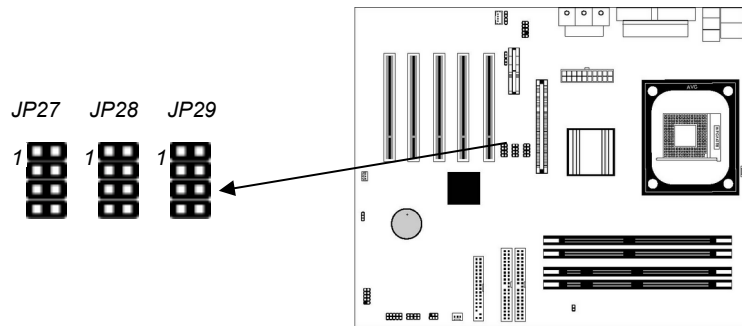

#### JP27

Pin	Signal	Pin	Signal
1	VCC BUS	2	GND
3	TPB-0	4	TPB+0
5	TPA-0	6	TPA+0
7	SHIELD	8	NC

#### JP28

Pin	Signal	Pin	Signal
1	VCC BUS	2	GND
3	TPB-1	4	TPB+1
5	TPA-1	6	TPA+1
7	SHIELD	8	NC

#### JP29

Pin	Signal	Pin	Signal
1	VCC BUS	2	GND
3	TPB-2	4	TPB+2
5	TPA-2	6	TPA+2
7	SHIELD	8	NC

## 2: Mainboard Installation

1. Locate the JP27/JP28/JP29 header on the mainboard.
2. Plug the bracket cable onto the JP27/JP28/JP29 header.
3. In the system chassis, remove the blanking plate from the corresponding expansion slot you want to use, and install an extension bracket in there. Secure the extension bracket in the chassis with a screw.

### Install Other Devices

Install and connect other devices in the system as steps below.

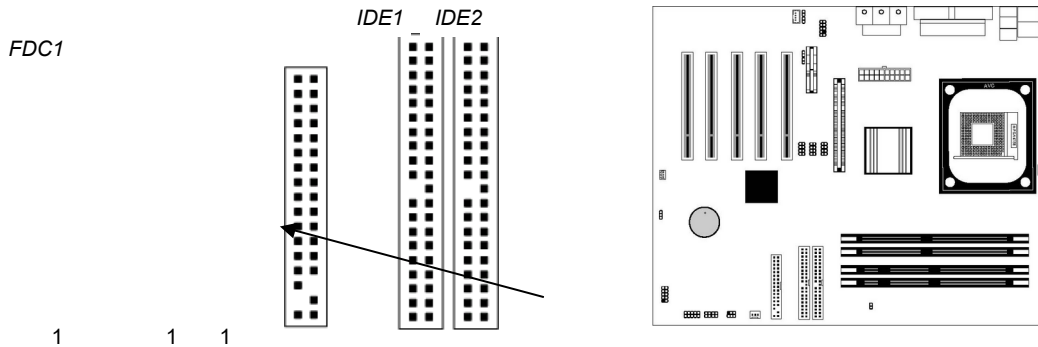

### Floppy Disk Drive

The mainboard ships with a floppy disk drive cable that can support one or two drives. Drives can be 3.5" or 5.25" wide, with capacities of 360K, 720K, 1.2MB, 1.44MB, or 2.88MB.

Install your drives and connect power from the system power supply. Use the cable provided to connect the drives to the floppy disk drive connector **FDC1**.

### IDE Devices

IDE devices include hard disk drives, high-density diskette drives, and CD-ROM or DVD-ROM drives, among others.

The mainboard ships with an IDE cable that can support one or two IDE devices. If you connect two devices to a single cable, you must configure one of the drives as Master and one of the drives as Slave. The documentation of the IDE device will tell you how to configure the device as a Master or Slave device. The Master device connects to the end of the cable.

## Mainboard User's Manual

Install the device(s) and connect power from the system power supply. Use the cable provided to connect the device(s) to the Primary IDE channel connector **IDE1** on the mainboard.

If you want to install more IDE devices, you can purchase a second IDE cable and connect one or two devices to the Secondary IDE channel connector **IDE2** on the mainboard. If you have two devices on the cable, one must be Master and one must be Slave.

### Internal Sound Connections

If you have installed a CD-ROM drive or DVD-ROM drive, you can connect the drive audio cable to the onboard sound system.

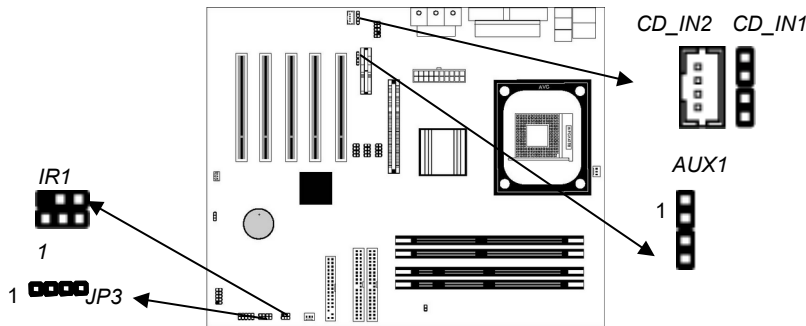

On the mainboard, locate the two 4-pin connectors **CD\_IN1** and **CD\_IN2**. There are two kinds of connector because different brands of CD-ROM drive have different kinds of audio cable connectors. Connect the cable to the appropriate connector.

#### CD\_IN1

Pin	Signal
1	CD IN L
2	GND
3	GND
4	CD IN R

#### CD\_IN2

Pin	Signal
1	GND
2	CD IN R
3	GND
4	CD IN L



## 2: Mainboard Installation

If you have installed a secondary CD-ROM drive or DVD-ROM drive, you can connect the drive audio cable to the onboard sound system. On the mainboard, locate the 4-pin Aux-In header AUX1, connect the cable to the connector.

Pin	Signal	Pin	Signal
1	AUX L	2	AUD GND
3	AUD GND	4	AUX R

### Infrared Port

You can connect an infrared port to the mainboard. You can purchase this option from third-party vendors.

Pin	Signal	Pin	Signal
1	FIR	2	KEY
3	+5V	4	GND
5	IRTX	6	IRRX

1. Locate the infrared port **IR1** header on the mainboard.
2. If you are adding an infrared port, connect the ribbon cable from the port to the IR header and then secure the port to an appropriate place in your system chassis.

### Onboard LAN LED Connections

If you have a set indicator LEDs for the onboard LAN communication, you can connect the LED cable to the header **JP3**. Pins 1-2 are for Link LED. Pins 3-4 are for 10/100 Mbps mode LED, the onboard LAN run in 100 Mbps mode when the LED lit.

Pin	Signal	Pin	Signal
1	Link LED	2	VCC
3	GND	4	10/100 Mbps mode LED

## Mainboard User's Manual

### Expansion Slots

This mainboard has five 32-bit PCI slots, one AGP slot and one AMR slot.

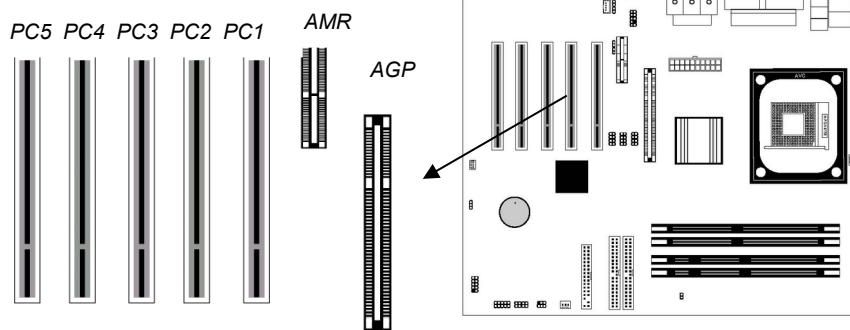

Follow the steps below to install a PCI/AGP/AMR expansion card.

1. Locate the AMR, AGP or PCI slots on the mainboard.
2. Remove the slot cover from the system chassis.
3. Insert the expansion card edge connector into the slot and press it firmly down until fully inserted.
4. Secure the expansion card bracket in the system chassis with a screw.

#### AMR Slot

The AMR (Audio Modem Riser) slot is an industry standard slot that allows for the installation of a special audio/modem riser card. Different territories have different regulations regarding the specifications of a modem card. You can purchase an AMR card that is approved in your area and install it directly into the AMR slot.

## Chapter 3

# BIOS Setup Utility

---

### Introduction

The BIOS Setup Utility records settings and information about your computer such as the date and time, the kind of hardware installed, and various configuration settings. Your computer uses this information to initialize all the components when booting up and functions as the basis for coordination between system components.

If the Setup Utility configuration is incorrect, it may cause the system to malfunction. It can even stop your computer from booting properly. If this happens, you can use the clear CMOS jumper to clear the CMOS memory used to store the configuration information.

You can run the setup utility and manually make changes to the configuration. You might need to do this to configure some of the hardware that you install on or connect to the mainboard, such as the CPU, system memory, disk drives, etc.



### 3: BIOS Setup Utility

#### Standard CMOS Setup Page

This page sets up basic information such as the date, the time, the IDE devices, and the diskette drives. If you press the F3 key, the system will automatically detect and configure the hard disks on the IDE channels.

AMIBIOS SETUP – STANDARD CMOS SETUP										
(C) 2000 American Megatrends, Inc. All Rights Reserved										
Date (mm/dd/yy) : Mon March 4, 2002										
Time (hh/mm/ss) : 14:23:12										
	Type	Size	Cyln	Head	WPcom	Sec	LBA Mode	Blk Mode	PIO Mode	32Bit Mode
Pri Master	: Auto									On
Pri Slave	: Auto									On
Sec Master	: Auto									On
Sec Slave	: Auto									On
Floppy Drive A : 1.44 MB 3 1/2										
Floppy Drive B : Not Installed										
Month : Jan – Dec							ESC : Exit			
Day : 01 – 31							↑↓ : Select Item			
Year : 1901 – 2099							PU/PD/+/- : Modify			
							(Shift)F2 : Color			
							F3 : Detect All HDD			

<b>Date &amp; Time</b>	Use these items to set the system date and time
<b>Pri Master</b>	Use these items to configure devices connected to the Primary and Secondary IDE channels. To configure an IDE hard disk drive, choose <i>Auto</i> . If the <i>Auto</i> setting fails to find a hard disk drive, set it to <i>User</i> , and then fill in the hard disk characteristics (Size, Cyls, etc.) manually. If you have a CD-ROM drive, select the setting <i>CDROM</i> . If you have an ATAPI device with removable media (e.g. a ZIP drive or an LS-120) select <i>Floptical</i> .
<b>Pri Slave</b>	
<b>Sec Master</b>	
<b>Sec Slave</b>	
<b>Floppy Drive A</b>	Use these items to set the size and capacity of the floppy diskette drive(s) installed in the system.
<b>Floppy Drive B</b>	

## Mainboard User's Manual

### Advanced Setup Page

This page sets up more advanced information about your system. Take care of this page with more caution. Any changes can affect the operation of your computer.

AMIBIOS SETUP – ADVANCED SETUP			
(C) 2000 American Megatrends, Inc. All Rights Reserved			
Quick Boot	Enabled	Spread Spectrum	Disabled
1 <sup>st</sup> Boot Device	IDE-0	DOS Flat Mode	Disabled
2 <sup>nd</sup> Boot Device	Floppy		
3 <sup>rd</sup> Boot Device	CDROM		
Try Other Boot Devices	Yes		
S.M.A.R.T. for Hard Disks	Disabled		
BootUp Num-Lock	On		
Floppy Drive Swap	Disabled		
Floppy Drive Seek	Disabled		
Password Check	Setup	ESC : Quit	↑↓←→ : Select Item
Boot To OS/2 > 64MB	No	F1 : Help	PU/PD/+/- : Modify
L2 Cache	Enabled	F5 : Old Values (Shift)	F2 : Color
System BIOS Cacheable	Disabled	F6 : Load BIOS Defaults	
Graphic Win Size	4M	F7 : Load Setup Defaults	
DRAM CAS# Latency	3T		
Timing Setting Mode	Normal		
MA 1T/2T Select	Auto		
Advanced Read Prefetch	Enabled		
Auto Detect DIMM/PCI Clk	Enabled		

### 3: BIOS Setup Utility

<b>Quick Boot</b>	If you enable this item, the system starts up more quickly by elimination of some of the power on test routines.
<b>1<sup>st</sup> Boot Device</b> <b>2<sup>nd</sup> Boot Device</b> <b>3<sup>rd</sup> Boot Device</b>	Use these items to determine the device order the computer uses to look for an operating system to load at start-up time.
<b>Try Other Boot Device</b>	If you enable this item, the system will also search for other boot devices if it fails to find an operating system from the first two locations.
<b>S.M.A.R.T. for Hard Disks</b>	Enable this item if any IDE hard disks support the S.M.A.R.T. (Self-Monitoring, Analysis and Reporting Technology) feature.
<b>BootUp Num-Lock</b>	This item determines if the Num Lock key is active or inactive at system start-up time.
<b>Floppy Drive Swap</b>	If you have two diskette drives installed and you enable this item, drive A becomes drive B and drive B becomes drive A.
<b>Floppy Drive Seek</b>	If you enable this item, your system will check all floppy disk drives at start up. Disable this item unless you are using an old 360KB drive.
<b>Password Check</b>	If you have entered a password for the system, use this item to determine, if the password is required to enter the Setup Utility ( <i>Setup</i> ) or required both at start-up and to enter the Setup Utility ( <i>Always</i> ).
<b>Boot to OS/2 &gt; 64MB</b>	Enable this item if you are booting the OS/2 operating system and you have more than 64MB of system memory installed.
<b>L2 Cache</b>	Leave these items enabled since all the processors that can be installed on this board have internal L2 cache memory.
<b>System BIOS Cacheable</b>	If you enable this item, a segment of the system BIOS will be copied to main memory for faster execution.
<b>Graphic Win Size</b>	This item defines the size of aperture if you use a graphic adapter.

## Mainboard User's Manual

<b>DRAM CAS# Latency</b>	This item determines the operation of DRAM memory CAS (column address strobe). It is recommended that you leave this item at the default value. The 3T setting requires faster memory that specifically supports this mode.
<b>Timing Setting Mode</b>	This item determines the timing setting mode of the memory. We recommend you leave this item at the default value.
<b>MA 1T/2T Select</b>	This item adjusts timing 1T/2T latency. We recommend you to leave this item at the default value.
<b>Advanced Read Prefetch</b>	This item enables prefetching for reading data. We recommend you to leave this item at the default value.
<b>Auto detect DIMM/PCI Clk</b>	When this item is enabled, BIOS will disable the clock signal of free DIMM/PCI slots.
<b>Spread Spectrum</b>	If you enable spread spectrum, it can significantly reduce the EMI(Electro-Magnetic Interference) generated by the system.
<b>DOS Flat Mode</b>	This item enables BIOS to enter the DOS protected mode without other software supporting under the DOS operating system. We recommend you leave this item at the default value.



### 3: BIOS Setup Utility

## Power Management Setup Page

This page sets some of the parameters for system power management operation.

AMIBIOS SETUP – POWER MANAGEMENT SETUP (C) 2000 American Megatrends, Inc. All Rights Reserved		
ACPI Aware O/S	Yes	
Power Management	Enabled	
Suspend Time out	Disabled	
Hard Disk Time out	Disabled	
Resume On RTC Alarm	Disabled	
RTC Alarm Date	15	ESC : Quit      ↑↓←→ : Select Item
RTC Alarm Hour	12	F1 : Help      PU/PD/+/- : Modify
RTC Alarm Minute	30	F5 : Old Values (Shift)F2 : Color
RTC Alarm Second	30	
LAN/Ring Power On	Disabled	F6 : Load BIOS Defaults
Keyboard Power On	Disabled	F7 : Load Setup Defaults

<b>ACPI Aware O/S</b>	Enable this item if you are using an O/S that supports ACPI function such as Windows 98/ME / 2000.
<b>Power Management</b>	Use this item to select a power management scheme. Both APM and ACPI are supported.
<b>Suspend Time Out</b>	This sets the timeout for Suspend mode in minutes. If the time selected passes without any system activity, the computer will enter power-saving Suspend mode.
<b>Hard Disk Time Out</b>	This sets the timeout to power down the hard disk drive, if the time selected passes without any hard disk activity.
<b>Resume On RTC Alarm Date / Hour / Minute / Second</b>	The system can be turned off with a software command. If you enable this item, the system can automatically resume at a fixed time based on the system's RTC (realtime clock). Use the items below this one to set the date and time of the wake-up alarm. You must use an ATX power supply in order to use this feature.
<b>LAN/Ring Power On</b>	The system can be turned off with a software command. If you enable this item, the system can automatically resume if there is an incoming call on the Modem. You must use an ATX power supply in order to use this feature.

## Mainboard User's Manual

---

<b>Keyboard Power On</b>	If you enable this item, you can turn the system on and off by pressing hot keys on the keyboard. You must enable the Keyboard Power On jumper and use an ATX power supply in order to use this feature.
--------------------------	--

---

## PCI / Plug and Play Setup Page

This page sets some of the parameters for devices installed on the PCI bus and devices that use the system plug and play capability.

AMIBIOS SETUP – PCI / PLUG AND PLAY SETUP (C) 2000 American Megatrends, Inc. All Rights Reserved	
Plug and Play Aware O/S	Yes
Primary Graphics Adapter	PCI
Allocate IRQ for PCI VGA	Yes
ESC : Quit      ↑↓←→ : Select Item F1 : Help      PU/PD/+/- : Modify F5 : Old Values (Shift)F2 : Color F6 : Load BIOS Defaults F7 : Load Setup Defaults	

---

<b>Plug and Play Aware O/S</b>	Enable this item if you are using an O/S that supports Plug and Play such as Windows 95/98/ME.
<b>Primary Graphics Adapter</b>	This item indicates if the primary graphics adapter uses the PCI or the AGP bus. The default PCI setting still lets the onboard display work and allows the use of a second display card installed in a PCI slot.
<b>Allocate IRQ to PCI VGA</b>	If this item is enabled, an IRQ will be assigned to the PCI VGA graphics system. You set this value to No to free up an IRQ.

---

### 3: BIOS Setup Utility

#### **Load Optimal Settings**

If you select this item and press **Enter** a dialog box appears. If you press **Y**, and then **Enter**, the Setup Utility loads a set of fail-safe default values. These default values are not very demanding and they should allow your system to function with most kinds of hardware and memory chips.

*Note: It is highly recommended that users enter this option to load optimal values for accessing the best performance.*

#### **Load Best Performance Settings**

If you select this item and press **Enter** a dialog box appears. If you press **Y**, and then **Enter**, the Setup Utility loads a set of best-performance default values. These default values are quite demanding and your system might not function properly if you are using slower memory chips or other low-performance components.

## Mainboard User's Manual

### Features Setup Page

This page sets some of the parameters for peripheral devices connected to the system.

AMIBIOS SETUP – FEATURES SETUP (C) 2000 American Megatrends, Inc. All Rights Reserved		
OnBoard FDC	Enabled	ESC : Quit      ↑↓←→ : Select Item F1 : Help        PU/PD/+/- : Modify F5 : Old Values (Shift)F2 : Color F6 : Load BIOS Defaults F7 : Load Setup Defaults
OnBoard Serial PortA	3F8h/COM1	
OnBoard Serial PortB	2F8h/COM2	
Serial Port2 Mode	Normal	
OnBoard Parallel Port	378h	
Parallel Port Mode	ECP	
Parallel Port IRQ	7	
Parallel Port DMA	3	
OnBoard Game Port	201h	
OnBoard MIDI Port	300h	
MIDI Port IRQ	10	
OnBoard PCI IDE	Both	
Audio Device	Enabled	
Modem Device	Enabled	
Ethernet Device	Enabled	
Onboard USB Function	Enabled	
USB Function for DOS	Disabled	
ThumbDrive for DOS	Disabled	

<b>OnBoard FDC</b>	Use this item to enable or disable the onboard floppy disk drive interface.
<b>OnBoard Serial PortA/B</b>	Use these items to enable or disable the onboard COM1/2 serial port, and to assign a port address.
<b>Serial Port2 Mode</b>	Use this item to allocate the resources of the second serial port. Under Normal, the resources are allocated to the onboard serial port. Under ASKIR or IrDA, the resources are allocated to the onboard IR port.
<b>Onboard Parallel Port</b>	Use this item to enable or disable the onboard LPT1 parallel port, and to assign a port address. The Auto setting will detect and available address.

### 3: BIOS Setup Utility

<b>Parallel Port Mode</b>	Use this item to set the parallel port mode. You can select SPP (Standard Parallel Port), ECP (Extended Capabilities Port), EPP (Enhanced Parallel Port), or ECP + EPP.
<b>Parallel Port IRQ</b>	Use this item to assign either IRQ 5 or 7 to the parallel port.
<b>Parallel Port DMA</b>	Use this item to assign a DMA channel to the parallel port. The options are 0, 1 and 3.
<b>OnBoard Game Port</b>	Use this item to enable or disable the onboard Game port.
<b>OnBoard MIDI Port</b>	Use this item to enable or disable the onboard MIDI port, and to assign a port address.
<b>MIDI Port IRQ</b>	Use this item to assign an IRQ to the MIDI port.
<b>Onboard PCI IDE</b>	Use this item to enable or disable either or both of the onboard Primary and Secondary IDE channels.
<b>Audio Device</b>	This item enables or disables the onboard AC'97 audio chip.
<b>Modem Device</b>	This item enables or disables the onboard AC'97 modem chip.
<b>Ethernet Device</b>	This item enables or disables the onboard Ethernet LAN.
<b>Onboard USB Function</b>	Enable this item if you plan to use the USB ports on this mainboard.
<b>USB Function for DOS</b>	Enable this item if you plan to use the USB ports on this mainboard in a DOS environment.
<b>ThumbDrive for DOS</b>	Enable this item to make a small portion of memory storage device for the USB ports.

## Mainboard User's Manual

### CPU PnP Setup Page

This page lets you manually configure the mainboard for the CPU. The system will automatically detect the kind of CPU that you have installed and make the appropriate adjustments to the items on this page.

AMIBIOS SETUP – CPU PnP SETUP		
©2000 American Megatrends, Inc. All Rights Reserved		
CPU Type	Intel P4	
CPU/DRAM Speed	100/100 MHz	
CPU Core Voltage	1.632V	
CPU Ratio	H/W Trap	
CPU Frequency	100 MHz	
DRAM Frequency	100 MHz	
		ESC : Quit      ↑↓←→ : Select Item F1 : Help      PU/PD/+/- : Modify F5 : Old Values (Shift)F2 : Color F6 : Load Optimal values F7 : Load Best performance values

---

<b>CPU Type/Core Voltage/Ratio/Frequency</b>	These items show the type, core voltage, ratio and frequency of CPU installed in your system.
--	---

---

<b>CPU/DRAM Speed/Frequency</b>	These items decide CPU/DRAM speed/frequency installed in your system.
---------------------------------	---

---

### 3: BIOS Setup Utility

#### Hardware Monitor Page

This page sets some of the parameters for the hardware monitoring function of this mainboard.

AMIBIOS SETUP – HARDWARE MONITOR (C) 2000 American Megatrends, Inc. All Rights Reserved		
*** System Hardware ***		
Vcore	1.632V	
Vcc 2.5V/Vcc3.3V	2.496V	
Vcc 3.3V	3.392V	
Vcc	4.972V	
+12V	11.968V	
SB3V	3.488V	
-12V	-11.721V	
SB5V	5.053V	
VBAT	3.488V	ESC : Quit      ↑↓←→ : Select Item
SYSTEM Fan Speed	0 RPM	F1 : Help      PU/PD/+/- : Modify
CPU Fan Speed	4500 RPM	F5 : Old Values (Shift)F2 : Color
Power Temperature	62°C/143°F	F6 : Load BIOS Defaults
SYSTEM Temperature	40°C/104°F	F7 : Load Setup Defaults
CPU Temperature	33°C/91°F	

<b>CPU / System Temperature</b>	These items display CPU and system temperature measurement.
<b>FANs &amp; Voltage Measurements</b>	These items indicate cooling fan speeds in RPM and the various system voltage measurements.

## Mainboard User's Manual

### **Change Password**

If you highlight this item and press **Enter**, a dialog box appears which lets you enter a Supervisor password. You can enter no more than six letters or numbers. Press **Enter** after you have typed in the password. A second dialog box asks you to retype the password for confirmation. Press **Enter** after you have retyped it correctly. The password is then required to access the Setup Utility or for that and at start-up, depending on the setting of the Password Check item in Advanced Setup.

### **Change or Remove the Password**

Highlight this item, press **Enter** and type in the current password. At the next dialog box, type in the new password, or just press **Enter** to disable password protection.

### **Exit**

Highlight this item and press **Enter** to save the changes that you have made in the Setup Utility configuration and exit the program. When the Save and Exit dialog box appears, press **Y** to save and exit, or press **N** to exit without saving.



## Chapter 4

# Software & Applications

---

### Introduction

This chapter describes the contents of the support CD-ROM that comes with the mainboard package.

The support CD-ROM contains all useful software, necessary drivers and utility programs to properly run our products. More program information is available in a README file, located in the same directory as the software.

To run the support CD, simply insert the CD into your CD-ROM drive. An Auto Setup screen automatically pops out, and then you can go on the auto-installing or manual installation depending on your operating system.

If your operating system is Windows 98/ME/2000/XP, it will automatically install all the drivers and utilities for your mainboard; if Windows NT or manual installation, please follow the instructions described as the Installing under Windows NT or Manual Installation section.

## Mainboard User's Manual

### Installing Support Software

1. Insert the support CD-ROM disc in the CD-ROM drive.
2. When you insert the CD-ROM disc in the system CD-ROM drive, the CD automatically displays an Auto Setup screen.
3. The screen displays three buttons of **Setup**, **Browse CD** and **Exit** on the right side, and three others **Setup**, **Application** and **ReadMe** at the bottom. Please see the following illustration.



The **Setup** button runs the software auto-installing program as explained in next section.

The **Browse CD** button is a standard Windows command that you can check the contents of the disc with the Windows 98 file browsing interface.

The **Exit** button closes the Auto Setup window. To run the program again, reinsert the CD-ROM disc in the drive; or click the CD-ROM driver from the Windows Explorer, and click the Setup icon.

The **Application** button brings up a software menu. It shows the bundled software that this mainboard supports.

The **ReadMe** brings you to the Install Path where you can find out path names of software driver.

## 4: Software & Applications

### Auto-Installing under Windows 98/ME/2000/XP

If you are under Windows 98/ME/2000/XP, please click the **Setup** button to run the software auto-installing program while the Auto Setup screen pops out after inserting the support CD-ROM:

1. The installation program loads and displays the following screen. Click the **Next** button.



2. Select the items that you want to setup by clicking on it (the default options are recommended). Click the **Next** button to proceed.

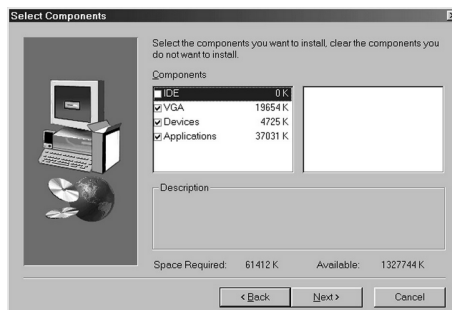

3. The support software will automatically install.

Once any of the installation procedures start, software is automatically installed in sequence. You need to follow the onscreen instructions, confirm commands and allow the computer to restart as few times as needed to complete installing whatever software you selected. When the process is finished, all the support software will be installed and start working.

## Mainboard User's Manual

### Installing under Windows NT or Manual Installation

If you are under Windows NT, the auto-installing program doesn't work out; or you have to do the manual installation, please follow this procedure while the Auto Setup screen pops out after inserting the support CD-ROM:

1. Click the **Browse CD** button to bring up a file browser window. You can find out the **PATH.HTML**; or click the **ReadMe** to bring up a screen, and then click the Install Path at the bottom of the screen to find out the **PATH.HTML**, too.
2. Find out your mainboard model name from the **PATH.HTML**. Click the model name and obtain its correct driver directory.
3. Install each software in accordance with the corresponding driver path.

### Bundled Software Installation

All bundled software available on the CD-ROM is for users' convenience. You can install bundled software as follows:

1. Click the **Application** button while the Auto Setup screen pops out after inserting the support CD-ROM.
2. A software menu appears. Click the software you want to install.
3. Follow onscreen instructions to install the software program step by step until finished.