

Mainboard User's Manual

This publication, photographs, illustrations and software are under the protection of international copyright laws and all rights reserved. It does not allow any reproduction of this manual, content and any materials contained herein without the written consent of the authentic manufacturer.

The information in this manual is subject to change without notice. The manufacturer does neither represent nor warrant the contents hereof; and specifically disclaims any implied warranties of merchantability or fitness for any particular purpose. Furthermore, the manufacturer reserves the right to revise and change this publication from time to time, without the obligation of notifying any person of such revision or changes.

Trademarks

IBM, VGA, and PS/2 are registered trademarks of International Business Machines.

Intel, Pentium, Pentium-II, Pentium-III, Pentium-IV, MMX, Celeron and Tualatin are registered trademarks of Intel Corporation.

Microsoft, MS-DOS and Windows 95/98/NT/2000 are registered trademarks of Microsoft Corporation.

PC-cillin is a trademark of Trend Micro Inc.

AMI is a trademark of American Megatrends Inc.

MediaRing Talk is a registered trademark of MediaRing Inc.

3Deep is a registered trademark of E-Color Inc.

It has been acknowledged that all mentioned brands or product names are trademarks or registered trademarks of their respective holders.

**Copyright © 2001
All Rights Reserved
M925 Series, V1.1A
VT8751/November 2001**

Mainboard User's Manual

Notice:

Owing to Microsoft's certifying schedule is various to every supplier, we might have some drivers not certified yet by Microsoft. Therefore, it might happen under Windows XP that a dialogue box (shown as below) pop out warning you this software has not passed Windows Logo testing to verify its compatibility with Windows XP. Please rest assured that our RD department has already tested and verified these drivers. Just click the "Continue Anyway" button and go ahead the installation.

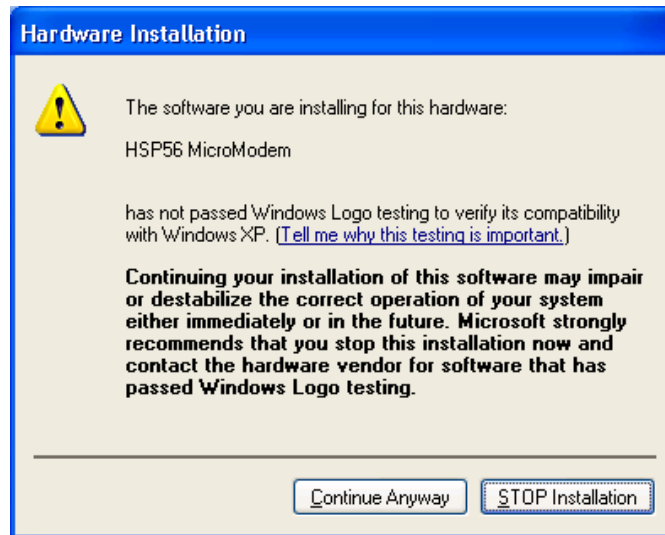

Mainboard User's Manual

Table of Contents

Chapter 1: Introduction.....	1
Key Features.....	2
Package Contents.....	5
Static Electricity Precautions.....	6
Pre-Installation Inspection.....	6
Chapter 2: Mainboard Installation.....	7
Mainboard Components.....	8
I/O Ports.....	9
Installing the Processor.....	10
Installing Memory Modules.....	11
Jumper Settings.....	13
The Panel Connectors.....	15
Other Devices Installation.....	17
Expansion Slots Installation.....	18
Connecting Optional Devices	19
Chapter 3: BIOS Setup Utility.....	23
Introduction.....	23
Running the Setup Utility.....	24
Standard CMOS Setup Page.....	25
Advanced Setup Page.....	26
Power Management Setup Page.....	29
PCI/Plug and Play Setup Page.....	31
Load Optimal Settings.....	32
Load Best Performance Settings.....	32
Features Setup Page.....	33
CPU PnP Setup Page.....	35
Hardware Monitor Page.....	36
Change Password.....	37
Exit.....	37
Chapter 4: Software & Applications.....	39
Introduction.....	39
Installing Support Software.....	39
Auto-installing under Windows 98.....	41

Mainboard User's Manual

Chapter 1

Introduction

This mainboard has a **Socket 478** for the **Intel Pentium 4** type of processors supporting front side bus (FSB) speeds up to **400 MHz**.

This mainboard has the **VIA VT8751(P4M266)** Northbridge and **VT8233** Southbridge chipsets that support **AC 97 audio codec**, and provide **Ultra DMA 33/66/100** function. This mainboard has two 32-bit **PCI** slots, one **4xAGP** slot, one **CNR** (Communications and Networking Riser) slot, and an onboard **10BaseT/100BaseTX Network** interface (optional). In addition, this mainboard has a full set of I/O ports including two PS/2 ports for mouse and keyboard, one serial port, one VGA port, one parallel port, one MIDI/game port and six USB ports (two backpanel ports, onboard USB headers providing four extra ports). By means of the Extended USB Module connected to the mainboard, you can make four extra USB ports.

This mainboard is a **Micro ATX size** mainboard and has power connectors for an ATX power supply.

Mainboard User's Manual

Key Features

This mainboard has these key features:

Socket 478 Processor

- ◆ The PGA Socket 478
- ◆ Accommodates Intel Pentium 4 CPUs
- ◆ Supports a front-side bus (FSB) of 400 MHz

Chipset

There are VT8751 Northbridge and VT8233 Southbridge in this chipset in accordance with an innovative and scalable architecture with proven reliability and performance. A few of the chipset's advanced features are:

- ◆ An advanced V-Link memory controller architecture that provides the bandwidth up to 266 MB/s and performance necessary for even the most demanding Internet and 3D graphics
- ◆ Support for an 4xAGP interface providing vivid 3D graphics and video performance
- ◆ An ATA 100 interface on the chipset, which helps boost system performance by providing a high-speed connection to ATA 100 Hard Disk Drives, delivering maximum sustained data transfer rates of 100 MB/sec

Additional key features include support for six USB ports, an AC 97 link for audio and modem, hardware monitoring, and ACPI/OnNow power management.

Memory Support

- ◆ The mainboard accommodates 2 DDR + 2 SDR 168 pin, 3.3V DIMM sockets with a total capacity of 2 GB system memory.

1: Introduction

Built-in Graphics System

- ◆ P4M266 integrates S3®'s Savag4™ graphics accelerator into a single chip. P4M266 brings mainstream graphics performance to the Value PC with leading-edge 2D, 3D and DVD video acceleration into a cost effective package. Based on its capabilities, P4M266 is an ideal solution for the consumer, corporate mobile users and entry level professionals.
- ◆ Maximum shared memory size is 32 MB.

VGA

- ◆ This mainboard includes a 4xAGP slot that provides eight times the bandwidth of the original AGP specification. AGP technology provides a direct connection between the graphics sub-system and memory so that the graphics do not have to compete for processor time with other devices on the PCI bus.

AC 97 Audio Codec

- ◆ The AC 97 Audio codec is compliant with the AC 97 2.2 specification, and supports 18-bit ADC (Analog Digital Converter) and DAC (Digital Analog Converter) resolution as well as 18-bit stereo full-duplex codec with independent and variable sampling rates. Further features include support for four analog line-level stereo inputs.

Expansion Options

The mainboard comes with the following expansion options:

- ◆ Two 32-bit PCI slots capable of Ultra DMA bus mastering with transfer rates of 33/66/100 MB/sec
- ◆ An 4xAGP slot
- ◆ A CNR (Communications and Networking Riser) slot

Onboard I/O Ports

The mainboard has a full set of I/O ports and connectors:

- ◆ Two PS/2 ports for mouse and keyboard
- ◆ One serial port

Mainboard User's Manual

- ◆ One VGA port
- ◆ One parallel port
- ◆ One MIDI/game port
- ◆ Six USB ports (two backpanel ports, onboard USB headers providing four extra ports)
- ◆ Audio jacks for microphone, line-in and line-out

BIOS Firmware

This mainboard uses AMI BIOS that enables users to configure many system features including the following:

- ◆ Power management
- ◆ Wake-up alarms
- ◆ CPU parameters and memory timing
- ◆ CPU and memory timing

The firmware can also be used to set parameters for different processor clock speeds.

Built-in Ethernet LAN

- ◆ Built-in **10BaseT/100BaseTX Ethernet LAN**
- ◆ VT8233 integrates Fast Ethernet MAC and VT6103 LAN PHY in compliance with IEEE802.3u 100BASE-TX, 10BASE-T and ANSI X3.263 TP-PMD standards
- ◆ In compliance with ACPI 1.0 and the Network Device Class Power Management 1.0
- ◆ High Performance achieved by 100Mbps clock generator and data recovery circuit for 100Mbps receiver

Bundled Software

- ◆ **PC-Cillin 2000** provides automatic virus protection under Windows 95/98/NT/2000
- ◆ **MediaRing Talk** provides PC to PC or PC to Phone internet phone communication
- ◆ **3Deep** delivers the precise imagery and displays accurate color in your monitor
- ◆ **WinDVD2000** is a DVD playback application (optional)
- ◆ **Recovery Genius 21st V5.0** provides the function to recover, reserve and transfer hard disk data.

1: Introduction

- ◆ **CD Ghost** is the software stimulating a real CD-ROM to perform equivalent function.
- ◆ **Language Genius 21st** is the software to provides learning tools of language and singing.

Dimensions

- ◆ Micro ATX form factor of 244 x 244 mm

Package Contents

Attention: This mainboard serial has two models, M925LR(LAN Ready) and M925(without LAN). Please contact your local supplier for more information about your purchased model. Each model will support different specification listed as below:

Model	Specification
M925LR	Onboard LAN PHY chip (U15), USB + RJ-45 LAN connector
M925	USB connector only

Your mainboard package contains the following items:

- The mainboard
- The User's Manual
- One diskette drive ribbon cable
- One IDE drive ribbon cable
- Software support CD
- Module Retention damp

Optional Accessories

You can purchase the following optional accessories for this mainboard.

- Extended USB module
- CNR v.90 56K Fax/Modem card

Mainboard User's Manual

Static Electricity Precautions

Static electricity could damage components on this mainboard. Take the following precautions while unpacking this mainboard and installing it in a system.

1. Don't take this mainboard and components out of their original static-proof package until you are ready to install them.
2. While installing, please wear a grounded wrist strap if possible. If you don't have a wrist strap, discharge static electricity by touching the bare metal of the system chassis.
3. Carefully hold this mainboard by its edges. Do not touch those components unless it is absolutely necessary. Put this mainboard on the top of static-protection package with component side facing up while installing.

Pre-Installation Inspection

1. Inspect this mainboard whether there are any damages to components and connectors on the board.
2. If you suspect this mainboard has been damaged, do not connect power to the system. Contact your mainboard vendor about those damages.

Chapter 2

Mainboard Installation

To install this mainboard in a system, please follow these instructions in this chapter:

- ❑ Identify the mainboard components
- ❑ Install a CPU
- ❑ Install one or more system memory modules
- ❑ Make sure all jumpers and switches are set correctly
- ❑ Install this mainboard in a system chassis (case)
- ❑ Connect any extension brackets or cables to connecting headers on the mainboard
- ❑ Install other devices and make the appropriate connections to the mainboard connecting headers.

Note:

1. Before installing this mainboard, make sure jumper JBAT1 is under Normal setting. See this chapter for information about locating JBAT1 and the setting options.
2. Never connect power to the system during installation; otherwise, it may damage the mainboard.

Mainboard User's Manual

Mainboard Components

Identify major components on the mainboard via this diagram underneath.

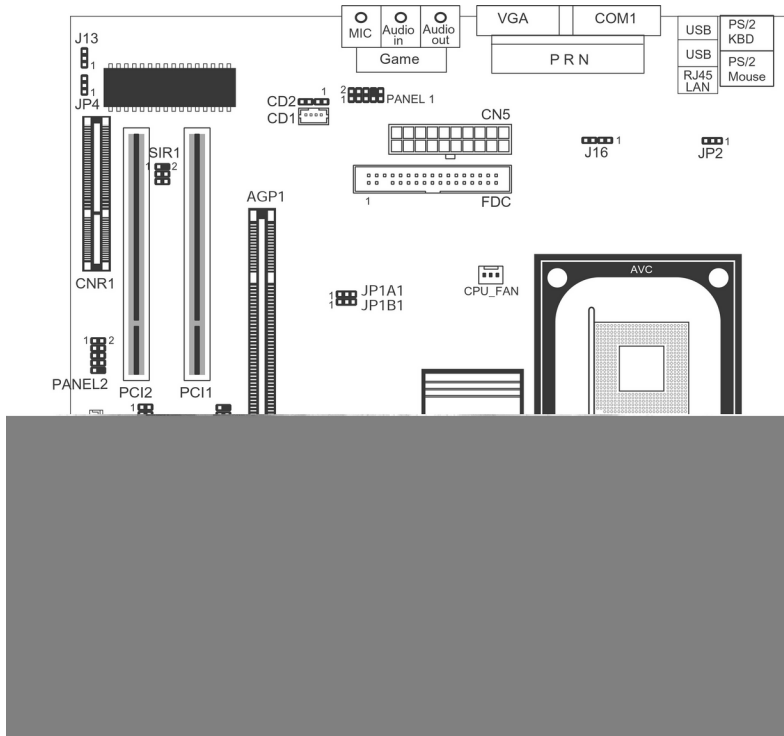

Note: Those jumpers of mainboard not appearing in this illustration are for testing only.

2: Mainboard Installation

I/O Ports

The illustration below shows a side view of the built-in I/O ports on the mainboard.

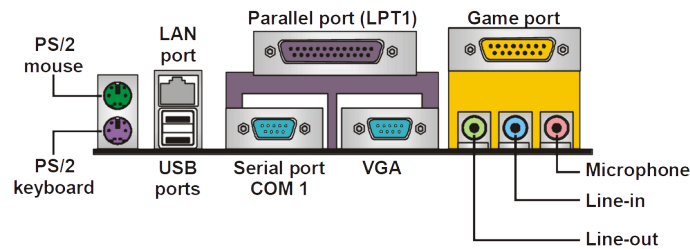

1. Use the upper PS/2 port to connect a PS/2 pointing device.
2. Use the lower PS/2 port to connect a PS/2 keyboard.
3. Use the USB ports to connect USB devices.
4. Use LPT1 to connect printers or other parallel communications devices.
5. Use the COM1 port to connect serial devices such as mice or fax/modems; the VGA port to connect graphic display devices.
6. Use the game port to connect a joystick or a MIDI device.
7. Use the three audio ports to connect audio devices. The left side jack is for a stereo line-out signal. The middle jack is for a stereo line-in signal. The right side jack is for a microphone.
8. Use this port to connect to the network.

Mainboard User's Manual

Installing the Processor

This mainboard has a Socket 478 processor socket. When choosing a processor, consider the performance requirements of the system. Performance is based on the processor design, the clock speed and system bus frequency of the processor, and the quantity of internal cache memory and external cache memory.

CPU Installation Procedure

Follow these instructions to install the CPU:

1. Unhook the CPU socket's locking lever by pulling it away from socket and raising it to the upright position.
2. Match the pin 1 corner of CPU socket to the one of processor, and insert the processor into the socket. Do not use force.
3. Push the locking lever down and hook it under the latch on the edge of socket.
4. Apply thermal grease to the top of the CPU.
5. Lower the CPU fan/heatsink unit onto the CPU and CPU socket, and then use the retention module clamps to snap the fan/heatsink into place.
6. Plug the CPU fan power cable into the CPU cooling fan power supply (CPU_FAN) on the mainboard.

2: Mainboard Installation

Installing Memory Modules

This mainboard accommodates 168-pin 3.3V/184-pin 2.5V unbuffered SDRAM memory modules. The memory chips must be standard or registered SDRAM (Synchronous Dynamic Random Access Memory).

The CPU supports 100MHz system bus. The SDRAM DIMMs and DDRs can synchronously work with 100 MHz or operates over a 266 MHz system bus.

You must install at least one memory module in order to work out this mainboard, **either SDRAM or DDR SDRAM, but you can't use them simultaneously.**

DDR SDRAM provides 800 MBps or 1 GBps data transfer depending on whether the bus is 100 MHz or 266 MHz. It doubles the rate to 1.0 GBps and 2.1 GBps by transferring data on both the rising and falling edges of the clock. DDR SDRAM uses additional power and ground lines and requires 184-pin 2.5V unbuffered DIMM module rather than the 168-pin 3.3V unbuffered DIMMs used by SDRAM.

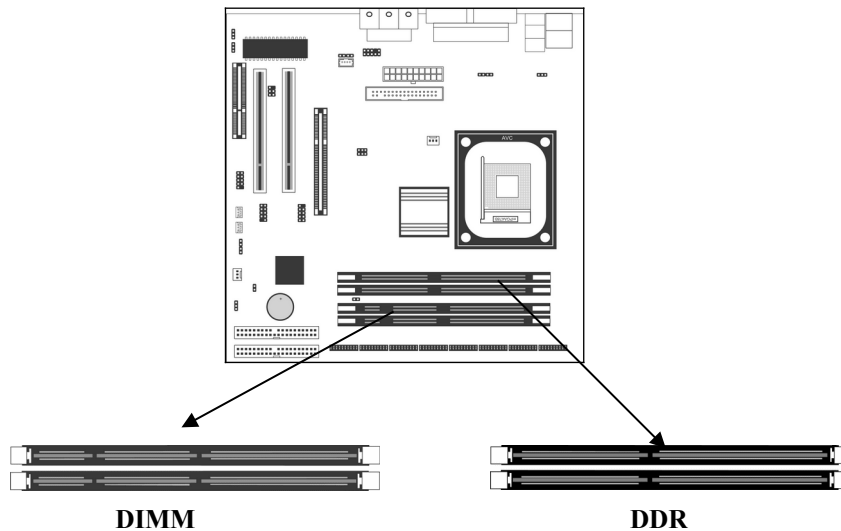

Mainboard User's Manual

Installation Procedure

The mainboard accommodates two memory modules. You must install at least one module in any of the three slots. Each module can be installed with up to 2GB system memory.

Refer to the following to install the memory modules.

1. Push the latches on each side of the DIMM slot down.
2. Align the memory module with the slot. The DIMM slots are keyed with notches and the DIMMs are keyed with cutouts so that they can only be installed correctly.
3. Check that the cutouts on the DIMM module edge connector match the notches in the DIMM slot.
4. Install the DIMM module into the slot and press it firmly down until it seats correctly. The slot latches are levered upwards and latch on to the edges of the DIMM.
5. Install any remaining DIMM modules.

2: Mainboard Installation

Jumper Settings

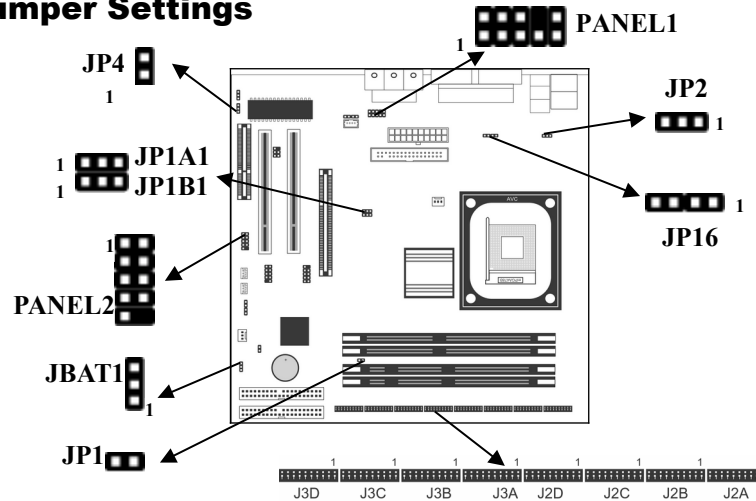

JBAT1: Clear CMOS Jumper

This jumper is to clear the contents of CMOS memory. You may need to clear the CMOS memory if the settings in the Setup Utility are incorrect that prevents your mainboard from operating. To clear the CMOS memory, disconnect all the power cables from the mainboard and then move the jumper cap into the CLEAR setting for a few seconds.

Function	Jumper Setting
Normal	Short Pins 1-2
Clear CMOS	Short Pins 2-3

JP1A1, JP1B1: CPU Clock

This jumper enables to select CPU frequency.

CPU Clock	JP1A1	JP1B1
100M	Short Pins 1-2	Short Pins 2-3
133M	Short Pins 2-3	Short Pins 1-2

Mainboard User's Manual

JP1: DRAM Voltage (VCC)

This jumper enables to select voltage of DRAM.

Function	Jumper Setting
2.5V (DDR)	Open Pins 1-2
3V (SDR)	Short Pins 1-2

J2A/B/C/D, J3A/B/C/D: DDR/SDR DRAM Type Selector

This jumper enables to select the type of DDR or SDR DRAM.

Function	Jumper Setting
DDR1,DDR2	Short all J2A/B/C/D and J3A/B/C/D pins
DIMM1, DIMM2	Open all J2A/B/C/D and J3A/B/C/D pins

JP2: Keyboard Power On

This jumper enables any keyboard activity to power up a system previously in a standby or sleep state.

Function	Jumper Setting
5V	Short Pins 1-2
5VSB	Short Pins 2-3

J13: Flash ROM Voltage (VCC)

This jumper enables to select voltage of flash ROM.

Function	Jumper Setting
5V	Short Pins 1-2
3V	Short Pins 2-3

JP4: Flash ROM Size

This jumper enables to select size of flash ROM.

Function	Jumper Setting
2M	Short Pins 1-2
4M	Short Pins 2-3

2: Mainboard Installation

The Panel Connector

PANEL1

If there are a headphone jack or/and a microphone jack on the front panel, connect the cables to the PANEL1 on the mainboard.

Device	Pins
Line Out (L)	9, 10
Line Out (R)	5, 6
MIC In	1, 2

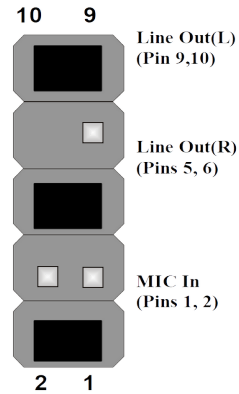

PANEL2

This panel connector provides a set of switch and LED connectors found on ATX case. Refer to the table below for information.

Device	Pins
Empty	10
N/C	9
Power ON/OFF	6, 8
Reset Switch	5, 7
SPD-LED Indicator	+2, 4
HDD LED	+1, -3

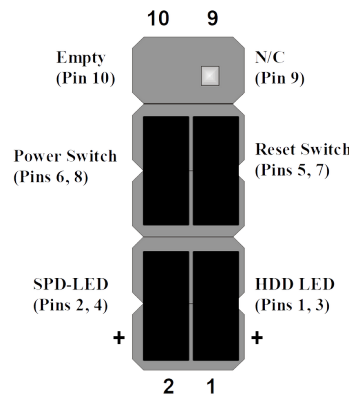

Mainboard User's Manual

J16: LAN LED Indicator

This connector is attached to LAN device that needs a LED indicator.

Device	Pins
Link LED	1, +2
ACT LED	+3, 4

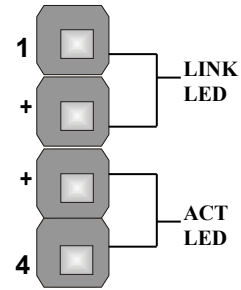

Note: The plus sign (+) indicates a pin which must be connected to a positive voltage.

2: Mainboard Installation

Other Devices Installation

Floppy Diskette Drive Installation

The mainboard has a floppy diskette drive (FDD) interface and ships with a diskette drive ribbon cable that supports one or two floppy diskette drives. You can install a 5.25-inch drive and a 3.5-inch drive with various capacities. The floppy diskette drive cable has one type of connector for a 5.25-inch drive and another type of connector for a 3.5-inch drive.

IDE Devices

Your mainboard has a primary and secondary IDE channel interface (IDE1 and IDE2). An IDE ribbon cable supporting two IDE devices is bundled with the mainboard.

If you want to install more than two IDE devices, get a second IDE cable and you can add two more devices to the secondary IDE channel.

IDE devices have jumpers or switches to set the IDE device as MASTER or SLAVE. When installing two IDE devices on one cable, ensure that one device is set to MASTER and the other one to SLAVE.

This mainboard supports Ultra DMA 66/100. UDMA is a technology to accelerate devices' performance in the IDE channel. To maximize performance, install IDE devices that support UDMA and use 80-pin IDE cables supporting UDMA 66/100.

Mainboard User's Manual

Expansion Slots Installation

This mainboard has two 32-bit PCI (Peripheral Components Interconnect) expansion slots, one 4xAGP slot, and one CNR slot.

PCI Slots

PCI slots are used to install expansion cards that have the 32-bit PCI interface.

4 x AGP Slot

The 4xAGP slot is used to install a graphics adapter that supports the 4xAGP specification and has a 4xAGP edge connector.

CNR Slot

The Communications Networking Riser (CNR) slot can be used to insert a CNR card.

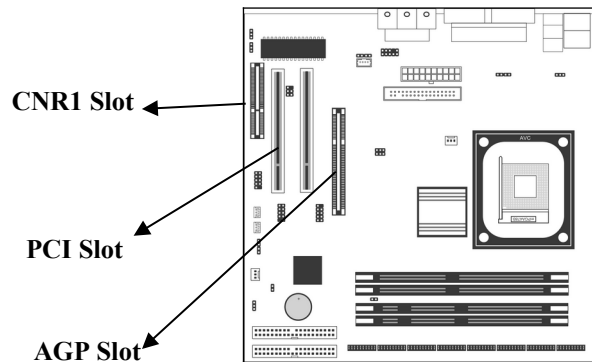

1. Remove a blanking plate from the system case corresponding to the slot you are going to use.
2. Install the edge connector of the expansion card into the expansion slot. Ensure that the edge connector is correctly seated in the slot.
3. Secure the metal bracket of the card to the system case with a screw.

2: Mainboard Installation

Connecting Optional Devices

Refer to the following for information on connecting the mainboard's optional devices:

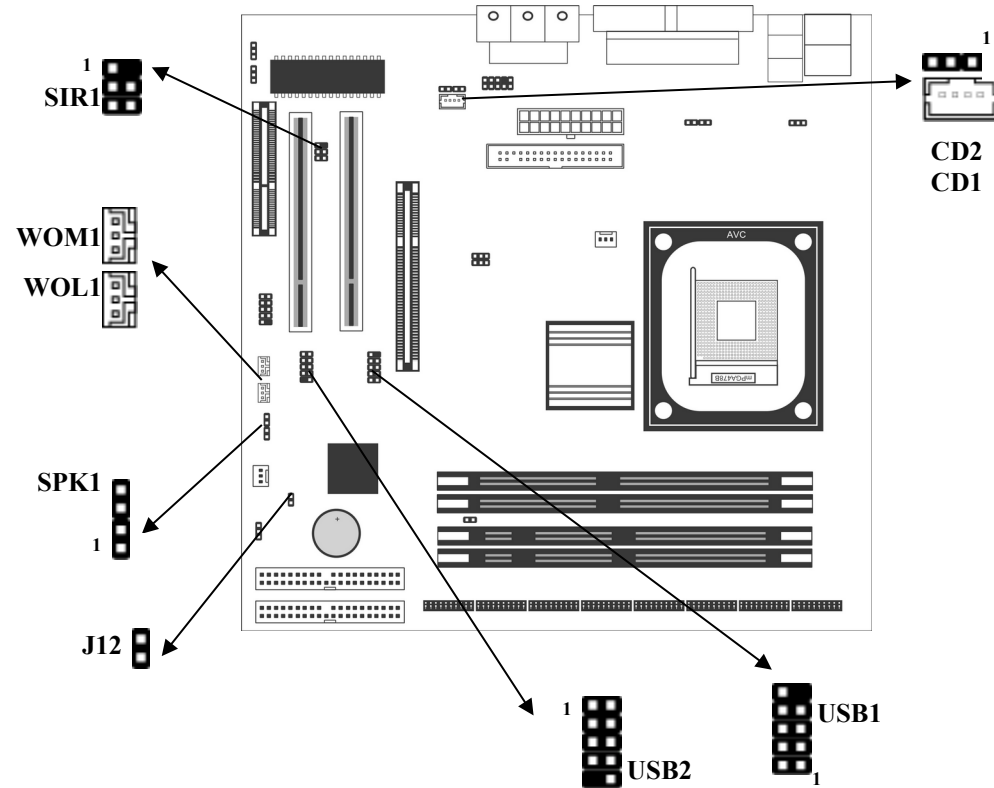

Mainboard User's Manual

J12: Sleep Switch

This header is connected to the sleep button for suspending the computer's activity if pushing the button. Or, the computer is automatically suspended after passing a period of time.

SPK1: Speaker Connector

Connect the cable from the PC speaker to the SPK1 header on the mainboard.

USB1/USB2: Front panel USB headers

The mainboard has USB ports installed on the rear edge I/O port array. Some computer cases have a special module that mounts USB ports at the front of the case. If you have this kind of case, use auxiliary USB connectors USB1 and USB2 to connect the front-mounted ports to the mainboard.

WOL1/WOM1: Wake On LAN/Wake On Modem

If you have installed a LAN card, use the cable provided with the card to plug into the mainboard WOL1 connector. This enables the Wake On LAN (WOL1) feature. When your system is in a power-saving mode, any LAN signal automatically resumes the system. You must enable this item using the Power Management page of the Setup Utility.

If you have installed a modem, use the cable provided with the modem to plug into the mainboard WOM1 connector. This enables the Wake On Modem (WOM1) feature. When your system is in a power-saving mode, any modem signal automatically resumes the system. You must enable this item using the Power Management page of the Setup Utility. See Chapter 3 for more information.

CD1/2:CD-ROM/DVD Audio Input Connector

If you have installed a CD-ROM drive or DVD-ROM drive, you can connect the drive audio cable to the onboard sound system. On the mainboard, locate the two 4-pin connectors **CD1** and **CD2**. There are two kinds of connector because different brands of CD-ROM drive have different kinds of audio cable connectors. Connect the cable to the appropriate connector.

2: Mainboard Installation

SIR1: Serial infrared port

The mainboard supports a Serial Infrared (SIR1) data port. Infrared ports allow the wireless exchange of information between your computer and similarly equipped devices such as printers, laptops, Personal Digital Assistants (PDAs), and other computers.

Mainboard User's Manual

Chapter 3

BIOS Setup Utility

Introduction

The BIOS Setup Utility records settings and information of your computer, such as date and time, the type of hardware installed, and various configuration settings. Your computer applies those information to initialize all the components when booting up and basic functions of coordination between system components.

If the Setup Utility configuration is incorrect, it may cause the system to malfunction. It can even stop your computer booting properly. If it happens, you can use the clear CMOS jumper to clear the CMOS memory which has stored the configuration information; or you can hold down the **Page Up** key while rebooting your computer. Holding down the **Page Up** key also clears the setup information.

You can run the setup utility and manually change the configuration. You might need to do this to configure some hardware installed in or connected to the mainboard, such as the CPU, system memory, disk drives, etc.

Mainboard User's Manual

Running the Setup Utility

Every time you start your computer, a message appears on the screen before the operating system loading that prompts you to “Hit if you want to run SETUP”. Whenever you see this message, press the **Delete** key, and the Main menu page of the Setup Utility appears on your monitor.

AMIBIOS SIMPLE SETUP UTILITY – VERSION 1.21.06
(C) 2000 American Megatrends, Inc. All Rights Reserved

Standard CMOS Setup	Features Setup
Advanced Setup	CPU PnP Setup
Power Management Setup	Hardware Monitor
PCI / Plug and Play Setup	Change Password
Load Optimal Settings	Exit
Load Best Performance Settings	
Esc : Quit ↑ ↓ ← → : Select Item (Shift)F2 : Change Color F5 : Old Values F6 : Optimal values F7 : Best performance values F10 : Save&Exit	
Standards CMOS setup for changing time, date, hard disk type, etc.	

You can use cursor arrow keys to highlight anyone of options on the main menu page. Press **Enter** to select the highlighted option. Press the **Escape** key to leave the setup utility. Hold down the **Shift** key and press **F2** to cycle through the Setup Utility's optional color schemes.

Some options on the main menu page lead to tables of items with installed values that you can use cursor arrow keys to highlight one item, and press **PgUp** and **PgDn** keys to cycle through alternative values of that item. The other options on the main menu page lead to dialog boxes that require your answer Yes or No by hitting the **Y** or **N** keys.

If you have already changed the setup utility, press **F10** to save those changes and exit the utility. Press **F5** to reset the changes to the original values. Press **F6** to install the setup utility with a set of default values. Press **F7** to install the setup utility with a set of high-performance values.

3: BIOS Setup Utility

Standard CMOS Setup Page

This page helps you set up basic information such as the date and time, the IDE devices, and the diskette drives.

AMIBIOS SETUP – STANDARD CMOS SETUP										
(C) 2000 American Megatrends, Inc. All Rights Reserved										
Date (mm/dd/yy) : Mon Nov 12, 2001										
Time (hh/mm/ss) : 11:14:00										
	Type	Size	Cyln	Head	WPcom	Sec	LBA Mode	Blk Mode	PIO Mode	32Bit Mode
Pri Master	: Auto									On
Pri Slave	: Auto									On
Sec Master	: Auto									On
Sec Slave	: Auto									On
Floppy Drive A : 1.44 MB 31/2										
Floppy Drive B : Not Installed										
Month : Jan – Dec							ESC : Exit			
Day : 01 – 31							↑↓ : Select Item			
Year : 1901 – 2099							PU/PD/+/- : Modify			
							(Shift)F2 : Color			
							F3 : Detect All HDD			

Date & Time	Use these items to set up system date and time
IDE Pri Master	Use these items to configure devices connected to the Primary and Secondary IDE channels. To configure an IDE hard disk drive, choose <i>Auto</i> . If the <i>Auto</i> setting fails to find a hard disk drive, set it to <i>User</i> , and then fill in the hard disk characteristics (Size, Cyls, etc.) manually. If you have a CD-ROM drive, select the setting <i>CDROM</i> . If you have an ATAPI device with removable media (e.g. a ZIP drive or an LS-120), select <i>Floptical</i> .
Pri Slave	
Sec Master	
Sec Slave	
Floppy Drive A	Use these items to set up size and capacity of the floppy diskette drive(s) installed in the system.
Floppy Drive B	

Mainboard User's Manual

3: BIOS Setup Utility

Advanced Setup Page

This page sets up more advanced information about your system. Be more careful to this page. Any changes can affect the operation of your computer.

AMIBIOS SETUP – ADVANCED SETUP			
(C) 2000 American Megatrends, Inc. All Rights Reserved			
Quick Boot	Enabled	AGP Comp. Driving	Auto
1 st Boot Device	IDE-0	Manual AGP Comp. Driving	CB
2 nd Boot Device	Floppy	AGP Aperture Size	64MB
3 rd Boot Device	CDROM	Auto detect DIMM/PCI Clk	Disabled
Try Other Boot Devices	Yes	CLK Gen Spread Spectrum	Disabled
S.M.A.R.T. for Hard Disks	Disabled		
BootUp Num-Lock	On		
Floppy Drive Swap	Disabled		
Floppy Drive Seek	Disabled		
PS/2 Mouse Support	Disabled		
Password Check	Setup	ESC : Quit	↑↓←→ : Select Item
Boot To OS/2 > 64MB	No	F1 : Help	PU/PD/+/- : Modify
L1 Cache	Reserved	F5 : Old Values (Shift)	F2 : Color
L2 Cache	Enabled	F6 : Load BIOS Defaults	
System BIOS Cacheable	Enabled	F7 : Load Setup Defaults	
SDRAM Timing by SPD	Disables		
SDRAM Frequency	100MHz		
SDRAM CAS# Latency	2.5		
SDRAM Bank Interleave	Disabled		
AGP Mode	4X		

Quick Boot	If you enable this item, the system starts up more quickly by elimination of some of the power on test routines.
1st Boot Device	Use these items to determine the device order the computer uses to look for an operating system to load at start-up time.
2nd Boot Device	
3rd Boot Device	
Try Other Boot Device	If you enable this item, the system will also search for other boot devices if it fails to find an operating system from the first two locations.

Mainboard User's Manual

S.M.A.R.T. for Hard Disks	Enable this item if any IDE hard disks support the S.M.A.R.T. (Self-Monitoring, Analysis and Reporting Technology) feature.
BootUp Num-Lock	This item determines if the Num Lock key is active or inactive at system start-up time.
Floppy Drive Swap	If you have two diskette drives installed and you enable this item, drive A becomes drive B and drive B becomes drive A.
Floppy Drive Seek	If you enable this item, your system will check all floppy disk drives at start up. Disable this item unless you are using an old 360KB drive.
PS/2 Mouse Support	Enable this item if you plan to use a PS/2 mouse.
Password Check	If you have entered a password for the system, use this item to determine, if the password is required to enter the Setup Utility (<i>Setup</i>) or required both at start-up and to enter the Setup Utility (<i>Always</i>).
Boot to OS/2 > 64MB	Enable this item if you are booting the OS/2 operating system and you have more than 64MB of system memory installed.
L1/L2 Cache	Leave these items enabled since all the processors that can be installed on this board have internal L1/L2 cache memory.
System BIOS Cacheable	If you enable this item, a segment of the system BIOS will be copied to main memory for faster execution.
SDRAM Timing By SPD	This item allows you to enable or disable the SDRAM timing defined by the Serial Presence Detect electrical.
SDRAM Frequency	This item determines frequency of SDRAM memory.

3: BIOS Setup Utility

SDRAM CAS# Latency	This item determines the operation of SDRAM memory CAS (column address strobe). It is recommended that you leave this item at the default value. The 2T setting requires faster memory that specifically supports this mode.
SDRAM Bank Interleave	Enable this item to increase SDRAM memory speed. When enabled, separate memory banks are set for odd and even addresses and the next byte of memory can be accessed while the current byte is being refreshed.
AGP Comp. Driving	Use this item to signal driving current on AGP cards to auto or manual. Some AGP cards need stronger than normal driving current in order to operate. We recommend that you set this item to the default.
Manual AGP Comp. Driving	When AGP Driving is set to Manual, use this item to set the AGP current driving value.
AGP Mode	This item provides the OnBoard VGA mode with three options of 1,2, 4 multiplied frequency.
AGP Aperture Size	This item defines an AGP for the graphics. Leave this item at the default value 64MB.
Auto detect DIMM/PCI Clock	When this item is enabled, BIOS will disable the clock signal of free DIMM/PCI slots.
CLK Spread Spectrum	Use this item to set the system bus spread spectrum for the installed processor.

Mainboard User's Manual

Power Management Setup Page

This page sets up some parameters of system power management operation.

AMIBIOS SETUP – POWER MANAGEMENT SETUP (C) 2000 American Megatrends, Inc. All Rights Reserved		
ACPI Aware O/S	Yes	
Power Management/APM	Disabled	
Video Power Down Mode	Suspend	
Hard Disk Power Down Mode	Standby	
Standby Time Out(Minute)	Disabled	
Suspend Time Out(Minute)	Disabled	
PowerOn by LAN/Ring	Disabled	
PowerOn by Onchip LAN	Disabled	
PowerOn by KBC	Disabled	ESC : Quit ↑↓←→ : Select Item
Wake up key	Any key	F1 : Help PU/PD/+/- : Modify
Wake up password	N/A	F5 : Old Values (Shift)F2 : Color
PowerOn by RTC Alarm	Disabled	F6 : Load BIOS Defaults
RTC Alarm Date	15	F7 : Load Setup Defaults
RTC Alarm Hour	12	
RTC Alarm Minute	30	
RTC Alarm Second	30	

3: BIOS Setup Utility

ACPI Aware O/S	This item supports ACPI (Advanced Configuration and Power management Interface). Use this item to enable or disable the ACPI feature.
Power Management	Use this item to enable or disable a power management scheme. If you enable power management, you can use the items below to set the power management operation. Both APM and ACPI are supported.
Video Power Down Mode	Use this item to determine which power-saving mode is required to power down the graphics sub-system. You can force the graphics to power down in Stand By or Suspend modes, or you can disable the powerdown.
Hard Disk Power Down Mode	Use this item to determine which power-saving mode is required to power down the hard disk drive(s). You can force the hard disk to power down in Stand By or Suspend modes, or you can disable the powerdown.
Standby Time Out (Minute)	This sets the timeout for Standby mode in minutes. If the time selected passes without any system activity, the computer will enter power-saving Standby mode.
Suspend Time Out (Minute)	This sets the timeout for Suspend mode in minutes. If the time selected passes without any system activity, the computer will enter power-saving Suspend mode.
PowerOn by LAN/Ring	The system can be turned off with a software command. If you enable this item, the system can automatically resume if there is an incoming call on the Modem. You must use an ATX power supply in order to use this feature.
PowerOn by OnChip LAN	The system can be turned off with a software command. If you enable this item, the system can automatically resume on OnChip LAN. You must use an ATX power supply in order to use this feature.

Mainboard User's Manual

PowerOn by KBC Wake up key Wake up password	If you enable this item, system can automatically resume by pressing hot keys on the keyboard or typing in the password. You must enable the Keyboard Power On jumper and use an ATX power supply in order to use this feature.
PowerOn by RTC Alarm / Date / Hour / Minute / Second	The system can be turned off with a software command. If you enable this item, the system can automatically resume at a fixed time based on the system's RTC (realtime clock). Use the items below this one to set the date and time of the wake-up alarm. You must use an ATX power supply in order to use this feature.

3: BIOS Setup Utility

PCI / Plug and Play Setup Page

This page sets up some parameters for devices installed on the PCI bus and those utilizing the system plug and play capability.

AMIBIOS SETUP – PCI / PLUG AND PLAY SETUP (C) 2000 American Megatrends, Inc. All Rights Reserved	
Plug and Play Aware O/S	Yes
Share Memory Size	32MB
Primary Graphics Adapter	PCI
Allocate IRQ for PCI VGA	Yes
ESC : Quit ↑↓←→ : Select Item F1 : Help PU/PD/+/- : Modify F5 : Old Values (Shift)F2 : Color F6 : Load BIOS Defaults F7 : Load Setup Defaults	

Plug and Play Aware O/S Enable this item if you are using an O/S that supports Plug and Play such as Windows 95 or 98.

Share Memory Size This item lets you allocate a portion of the main memory for the onboard VGA display application with three options of 8/16/32MB.

Primary Graphics Adapter This item indicates if the primary graphics adapter uses the PCI or the AGP bus. The default AGP setting still lets the onboard display work and allows the use of a second display card installed in an AGP slot.

Allocate IRQ for PCI VGA If this item is enabled, an IRQ will be assigned to the PCI VGA graphics system. You set this value to No to free up an IRQ.

Mainboard User's Manual

Load Optimal Settings

If you select this item and press **Enter** a dialog box appears. If you press **Y**, and then **Enter**, the Setup Utility loads a set of fail-safe default values. These default values are not very demanding and they should allow your system to function with most kinds of hardware and memory chips.

Note: It is highly recommended that users enter this option to load optimal values for accessing the best performance.

Load Best Performance Settings

If you select this item and press **Enter** a dialog box appears. If you press **Y**, and then **Enter**, the Setup Utility loads a set of best-performance default values. These default values are quite demanding and your system might not function properly if you are using slower memory chips or other low-performance components.

3: BIOS Setup Utility

Features Setup Page

This page sets up some parameters for those peripheral devices connected to the system.

AMIBIOS SETUP – FEATURES SETUP (C) 2000 American Megatrends, Inc. All Rights Reserved		
OnBoard FDC	Disabled	
OnBoard Serial PortA	3F8h/COM1	
OnBoard IR Port	Disabled	
OnBoard Parallel Port	378h	
Parallel Port Mode	SPP	
Parallel Port IRQ	7	ESC : Quit ↑↓←→ : Select Item
Parallel Port DMA	N/A	F1 : Help PU/PD/+/- : Modify
OnBoard Game Port	201h	F5 : Old Values (Shift)F2 : Color
OnBoard MIDI Port	300h	F6 : Load BIOS Defaults
MIDI Port IRQ	10	F7 : Load Setup Defaults
OnBoard IDE	Both	
OnChip LAN	Disabled	
OnBoard AC'97 Audio	Disabled	
OnBoard MC'97 Modem	Auto	
USB Controller	All USB Port	
USB Device Legacy Support	Disabled	

Mainboard User's Manual

OnBoard FDC	Use this item to enable or disable the onboard floppy disk drive interface.
OnBoard Serial PortA	Use this item to enable or disable the onboard COM1 serial port, and to assign a port address.
OnBoard IR Port	Use this item to enable or disable the onboard infrared port, and to assign a port address.
Parallel Port Mode	Use this item to set the parallel port mode. You can select SPP (Standard Parallel Port), ECP (Extended Capabilities Port), EPP (Enhanced Parallel Port), or ECP + EPP.
Parallel Port IRQ	Use this item to assign IRQ to the parallel port.
Parallel Port DMA	Use this item to assign a DMA channel to the parallel port.
OnBoard Game Port	This item enables or disables the I/O address for the game port.
OnBoard MIDI Port	Use this item to enable or disable the onboard MIDI port, and to assign a port address.
MIDI Port IRQ	Use this item to assign IRQ 7 to the parallel port.
OnBoard IDE	Use this item to enable or disable the onboard IDE channel.
OnChip LAN	Use this item to enable or disable the OnChip LAN.
OnBoard AC'97 Audio	This item enables or disables the AC'97 audio chip.
OnBoard MC'97 Modem	This item enables or disables the MC'97 modem chip.
USB Controller	Use this item to select the USB ports or disabled.
USB Device Legacy	This item allows you to enable the USB device, if you have installed a USB device

3: BIOS Setup Utility

Support on the system board.

Mainboard User's Manual

CPU PnP Setup Page

This page helps you manually configure the mainboard for the CPU. The system will automatically detect the type of installed CPU and make the appropriate adjustments to the items on this page.

AMIBIOS SETUP – CPU PnP SETUP	
©2000 American Megatrends, Inc. All Rights Reserved	
CPU BRAND	INTEL
CPU Type	Pentium 4
CPU Speed	800 MHz
CPU Ratio Selection	8.0x
CPU Frequency	100 MHz
ESC : Quit ↑↓←→ : Select Item	
F1 : Help PU/PD/+/- : Modify	
F5 : Old Values (Shift)F2 : Color	
F6 : Load Optimal values	
F7 : Load Best performance values	

CPU BRAND/ Type/ Core Voltage/ Ratio / Frequency These items show the type, core voltage, ratio and frequency of CPU installed in your system.

CPU Speed This item decides CPU speed installed in your system.

3: BIOS Setup Utility

Hardware Monitor Page

This page sets up some parameters for the hardware monitoring function of this mainboard.

AMIBIOS SETUP – HARDWARE MONITOR		
(C) 2000 American Megatrends, Inc. All Rights Reserved		
*** System Hardware ***		
Vcore	1.632V	
Vcc 2.5V	2.496V	
Vcc 3.3V	3.392V	
Vcc 5V	4.972V	
+12V	11.968V	
-12V	-0.907V	
SB5V	5.053V	
VBAT	3.488V	
SYSTEM Fan Speed	0 RPM	
CPU Fan Speed	1350 RPM	
Power Temperature	33°C/91°F	
SYSTEM Temperature	39°C/102°F	
CPU Temperature	55°C/131°F	
		ESC : Quit ↑↓←→ : Select Item
		F1 : Help PU/PD/+/- : Modify
		F5 : Old Values (Shift) F2 : Color
		F6 : Load BIOS Defaults
		F7 : Load Setup Defaults

CPU / System Temperature	These items display CPU and system temperature measurement.
FANs & Voltage Measurements	These items indicate cooling fan speeds in RPM and the various system voltage measurements.

Mainboard User's Manual

Change Password

If you highlight this item and press Enter, a dialog box appears that you can enter a Supervisor password. You can enter no more than six letters or numbers. Press Enter after you have typed in the password. There will be the second dialog box asking you to retype the password for confirmation. Press Enter after you have retyped it correctly. Then, the password is required for the access to the Setup Utility or for it at start-up, depending on the setting of the Password Check item in Advanced Setup.

Exit

Highlight this item and press Enter to save the changes that you have made in the Setup Utility configuration and exit the program. When the Save and Exit dialog box appears, press Y to save and exit, or press N to exit without saving.

3: BIOS Setup Utility

Chapter 4

Software & Applications

Introduction

The support software CD-ROM attached to this mainboard package contains all necessary drivers and utility programs for properly running our products. You can find out a brief description of each software program and the location for your mainboard version as below. More information on some programs is available in a README file located in the same directory as the software.

If the operating system of your system is Windows 98, it will automatically install all drivers and utilities for your board.

See the Auto-Installing under Windows 98 section.

Installing Support Software

The software on this support CD-ROM is for Windows 95/NT/2000 and Windows 98. The installation procedure differs depending on which Operating System you have, but the automatic installation is now for Win98/WinME/Win2000.

Installing under Windows 95/NT

To install support software for Windows 95/NT follow this general procedure:

1. Insert the support CD-ROM disc in the CD-ROM drive.
(The system might get an error message from the PnP function. Don't care the message. You don't really need that file to install the drivers)
2. Use My Computer or Windows Explorer to look at the directory structure. You must use the Open command in the right-button menu. Double-clicking on the drive icon will result in an error message because the disc's AutoRun feature doesn't work in Windows 95/NT.
3. Execute the EXE file name given in the description below.

Mainboard User's Manual

*Note: The correct path name for each software driver is provided, where **D:** identifies the CD-ROM drive letter – modify if necessary.*

Bus Master IDE Driver

The IDE Bus Master Drivers allows the system to properly manage the IDE channels on the mainboard. You need to install two drivers if you are running Windows 9x.

- ◆ Windows 9x – D:\VIA\IDE\

Display Drivers and Software

Find the Display drivers and software here:

- ◆ D:\VGA\P4M266\

USB Driver

The USB Driver allows the system to recognize the USB ports on the mainboard. You need to install this driver if you are running Windows 95. Windows 95 OSR2 does not require this driver.

This driver is available for:

- ◆ Win95 – D:\USB\EUSBSUPP\USBSUPP.EXE
- ◆ Win95 (Chinese) – D:\USB\CUSBSUPP\CUSBSUPP.EXE

3Deep Software

Find the software here:

- ◆ D:\3Deep\3Deep 3.3\Setup.EXE

Sound Driver

Find the software here:

- ◆ D:\Sound\Driver\VIA8233

Lan Driver

Find the software here:

- ◆ D:\Lan\VIA8233

4: Software & Applications

BIOS Update Utility

The BIOS Update utility allows you to update the BIOS file on the mainboard to a newer version. You can download the latest version of the BIOS setup available for your mainboard from the website.

- ◆ D:\UTILITY\AMINFXXX.EXE

PC-Cillin Software

The PC-cillin software program provides anti-virus protection for your system.

This program is available for:

- ◆ Win9x – D:\PC-CILLIN\

Auto-installing under Windows 98

The support software CD-ROM disc loads automatically under Windows 98. When you insert the CD-ROM disc in the system CD-ROM drive the Autorun feature will automatically bring up the install screen. The screen has three buttons on it, Setup, Browse CD and Exit. See the following screen illustration.

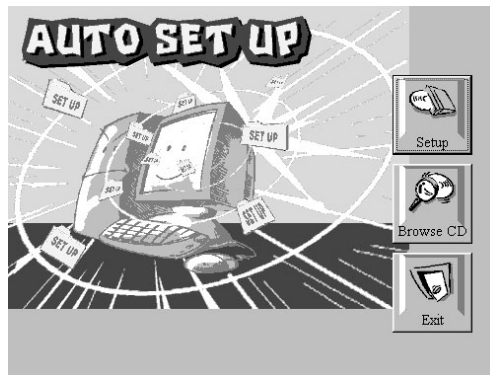

When you click on the **Setup** button the software installation program will run and you can select what kind of installation you want to do, as explained later in this section.

The **Browse CD** button is the standard Windows command that allows you to examine the contents of the disc using the Windows 98 file browsing interface.

Mainboard User's Manual

The **Exit** button closes the Auto Setup window. To run the program again, reinsert the CD-ROM disc in the drive or click on AutoRun in the context sensitive menu for the CD-ROM drive icon in a file browser window.

Installing Software with Auto Setup

To install support software for the system board follow this procedure:

1. Click on the **Setup** button. The install program will load and display the following screen. Click the **Next** button.



2. Select the items that you want to setup by clicking on it (the default options are recommended). Click the **Next** button to proceed.

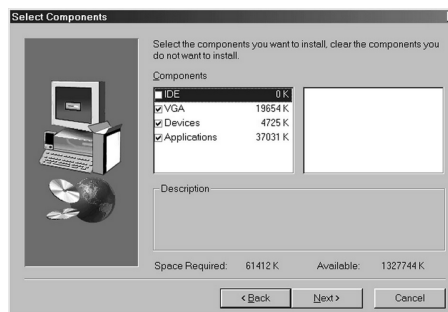

4: Software & Applications

3. The support software will automatically install.

Once any of the installation procedures start, software is automatically installed in sequence. You will need to follow the onscreen instructions, confirm commands and allow the computer to restart as few times as is needed to complete installing whatever software you selected to install. When the process is finished, all the support software will be installed and working.

There are some utilities that you have to manually install if you need, check to the above section.