

## **Mainboard User's Manual**

This publication, including all photographs, illustrations and software, is protected under international copyright laws, with all rights reserved. Neither this manual, nor any of the material contained herein, may be reproduced without the express written consent of the manufacturer.

The information in this document is subject to change without notice. The manufacturer makes no representations or warranties with respect to the contents hereof and specifically disclaims any implied warranties of merchantability or fitness for any particular purpose. Further, the manufacturer reserves the right to revise this publication and to make changes from time to time in the content hereof without obligation of the manufacturer to notify any person of such revision or changes.

### **Trademarks**

IBM, VGA, and PS/2 are registered trademarks of International Business Machines.

AMD and Athlon are registered trademarks of Advanced Micro Devices Inc.

Intel, Pentium, Pentium-II, and MMX are registered trademarks of Intel Corporation.

Microsoft, MS-DOS and Windows 95/98/NT/2000 are registered trademarks of Microsoft Corporation.

Sound Blaster is a trademark of Creative Technology Ltd.

PC-cillin and ChipAwayVirus are trademarks of Trend Micro Inc.

Award is a trademark of Award Software Inc.

A3D is a registered trademark of Aureal Inc.

MediaRing Talk is a registered trademark of MediaRing Inc.

3Deep is a registered trademark of E-Color Inc.

Other names used in this publication may be trademarks and are acknowledged.

**Copyright © 2001  
All Rights Reserved  
M807 Series, V1.0D  
V83X/January 2001**

## **M807 Mainboard User's Manual**

### **Information:**

This mainboard may support 266MHz FSB (KT133A chip only) for specification, but AMD can NOT provide this kind of K7 CPU to verify it.

## M807 Mainboard User's Manual

### Table of Contents

Chapter 1: Introduction	1
Key Features.....	2
Package Contents.....	4
Static Electricity Precautions.....	4
Pre-Installation Inspection.....	4
Chapter 2: Mainboard Installation	5
Mainboard Components.....	6
I/O Ports.....	7
Install A CPU.....	7
Install Memory.....	9
Setting Jumper Switches.....	10
Install the Mainboard.....	12
Optional Extension Brackets.....	14
Install Other Devices.....	15
Expansion Slots.....	17
Chapter 3: BIOS Setup Utility	19
Introduction.....	19
Running the Setup Utility.....	20
Standard CMOS Features Page.....	21
Advanced BIOS Features Page.....	22
Advanced Chipset Features Page.....	25
Integrated Peripherals Page.....	28
Power Management Setup Page.....	31
PnP/PCI Configurations Page.....	33
Hardware Monitor Page.....	35
Frequency/Voltage Control.....	36
Load Best Performance Defaults.....	37
Load Optimized Defaults.....	37
Set Password.....	37
Save & Exit Setup.....	38
Exit Without Saving.....	38
Chapter 4: Software & Applications	39
Introduction.....	39
Installing Support Software.....	39
Auto-installing under Windows 98.....	41

**M807 Mainboard User's Manual**

---

Appendix A: Corel WordPerfect Suite 8 A1  
    Welcome to Corel WordPerfect Suite 8 .....A2  
    Installing Corel WordPerfect Suite 8 .....A6  
    Learning how to use Corel WordPerfect Suite 8 .....A9  
    Support and Services .....A13

## Chapter 1

### Introduction

---

This mainboard has a **Socket-462** processor socket for an **AMD K7** type CPUs. You can install any one of these processors on the mainboard.

The mainboard supports Socket-462 processor front-side bus speeds of **200MHz** or **266MHz** (KT133A chip only).

This mainboard uses the **VIA VT8363** chipset which provides a **4X AGP** slot for highly graphics display, **CPU Plug & Play** through firmware and **Ultra DMA 33/66/100** (VT82C686B chip only) function. The mainboard has a built-in **AC97 Codec**, and provides an **AMR** (Audio Modem Riser) slot to support Audio and Modem application. In addition, the mainboard has an extended set of **ATX I/O Ports** including PS/2 keyboard and mouse ports, two USB ports, a parallel port, and two serial ports. Two extra USB ports can be added using the Extended USB Module that connects to the mainboard.

This mainboard has all the features you need to develop a powerful multimedia workstation. The board is **ATX size** and has power connectors for an **ATX** power supply.

## M807 Mainboard User's Manual

### Key Features

The key features of this mainboard include:

#### Socket-462 Processor Support

- ◆ Supports AMD **Athlon/Duron** processors
- ◆ Supports 200/266 (KT133A chip only) MHz FSB

All processors are automatically configured using firmware and a synchronous/asynchronous Host/DRAM Clock Scheme.

#### Memory Support

- ◆ Three DIMM slots for 168-pin SDRAM memory modules
- ◆ Support for 100/133 MHz memory bus
- ◆ Maximum installed memory is 2 x 512MB = 1.0GB

#### Expansion Slots

- ◆ One AMR slot for a special audio/modem riser card
- ◆ One AGP4X slot for AGP 2.0-compliant interface.
- ◆ Five 32-bit PCI slots for PCI 2.2-compliant bus interface.

#### Onboard IDE channels

- ◆ Primary and Secondary PCI IDE channels
- ◆ Support PIO (programmable input/output) modes and Multiword DMA modes
- ◆ Support Bus Mastering and Ultra DMA 33/66/100 (optional VT82C686B) modes

#### Power Supply and Power Management

- ◆ ATX power supply connector
- ◆ ACPI and previous PMU support, suspend switch
- ◆ Supports Wake on Modem/LAN and Wake on Alarm

#### AC97 Codec

- ◆ Compliant PC97 2.1 specification
- ◆ Supports 18-bit ADC (Analog Digital Converter) and DAC (Digital Analog Converter) as well as 18-bit stereo full-duplex codec

#### Onboard I/O Ports

- ◆ Provides PC99 Color Connectors for easy peripheral device connections

## 1: Introduction

- ◆ Floppy disk drive connector with 1Mb/s transfer rate
- ◆ Two serial ports with 16550-compatible fast UART
- ◆ One parallel port with ECP and EPP support
- ◆ Two USB ports, and optional two USB ports module
- ◆ Two PS/2 ports for keyboard and mouse
- ◆ One infrared port connector for optional module

### Hardware Monitoring

- ◆ Built-in hardware monitoring for CPU & System temperatures, fan speeds and mainboard voltages

### Onboard Flash ROM

- ◆ Automatic CPU and board configuration
- ◆ Supports Plug and Play configuration of peripheral devices and expansion cards
- ◆ Built-in virus protection using **Trend's ChipAwayVirus** provides boot process virus protection.

### Bundled Software

- ◆ **PC-Cillin2000** provides automatic virus protection under Windows 95/98/NT/2000
- ◆ **MediaRing Talk** provides PC to PC or PC to Phone internet phone communication
- ◆ **3Deep** delivers the precise imagery and displays accurate color in your monitor
- ◆ **Corel WordPerfect Suite 8** is a Microsoft Windows® office application suite (optional)

### Dimensions

- ◆ ATX form factor (30.5cm x 22cm)

### Package Contents

**Attention:** This mainboard series includes two different models. They are M807MR (Modem Ready) and M807 (without Modem). Please contact your local supplier for your purchase model. Each model will support different specification, list as below:

Model	Specification
M807MR	Support an AMR v.90 56K Fax/Modem card

## M807 Mainboard User's Manual

M807	---
------	-----

Your mainboard package ships with the following items:

- The mainboard
- This User's Guide
- 1 UDMA/66 IDE cable
- 1 Floppy disk drive cable
- Support software on CD-ROM disk

### Optional Accessories

You can purchase the following optional accessories for this mainboard.

- Extended USB module

### Static Electricity Precautions

Components on this mainboard can be damaged by static electricity. Take the following precautions when unpacking the mainboard and installing it in a system.

1. Keep the mainboard and other components in their original static-proof packaging until you are ready to install them.
2. During installation, wear a grounded wrist strap if possible. If you don't have a wrist strap, discharge static electricity by touching the bare metal of the system chassis.
3. Handle the mainboard carefully by the edges. Avoid touching the components unless it is absolutely necessary. During installation put the mainboard on top of the static-protection packaging it came in with the component side facing up.

### Pre-Installation Inspection

1. Inspect the mainboard for damage to the components and connectors on the board.
2. If you suspect that the mainboard has been damaged, do not connect power to the system. Contact your mainboard vendor and report the damage.



## Chapter 2

# Mainboard Installation

---

To install this mainboard in a system, follow the procedures in this chapter:

Identify the mainboard components

Install a CPU

Install one or more system memory modules

Verify that any jumpers or switches are set correctly

Install the mainboard in a system chassis (case)

Connect any extension brackets or cables to the mainboard connector headers

Install any other devices and make the appropriate connections to the mainboard connector headers.

**Note:**

1. Before installing this mainboard, make sure jumper JP1 is set to Normal setting. See this chapter for information on locating JP1 and the setting options.
2. Never connect power to the system during installation. Doing so may damage the mainboard.

### Mainboard Components

Use the diagram below to identify the major components on the mainboard.

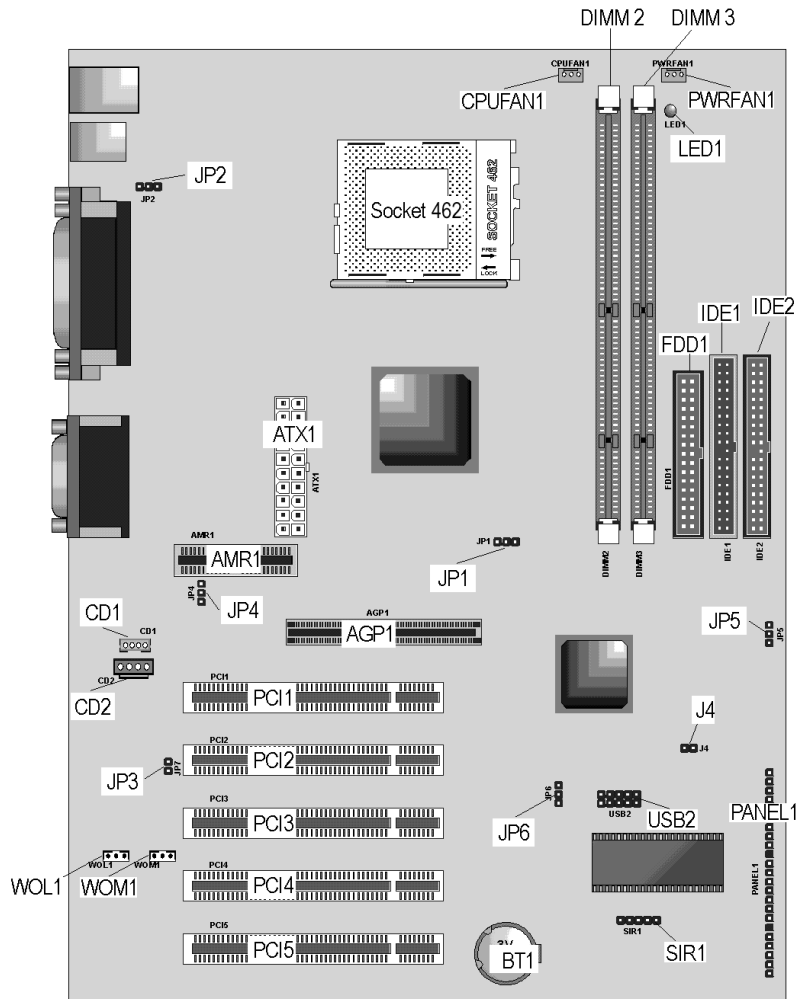

**Note:** Any jumpers on your mainboard that do not appear in this illustration are for testing only.

## 2: Mainboard Installation

### I/O Ports

The illustration below shows a side view of the built-in I/O ports on the mainboard.

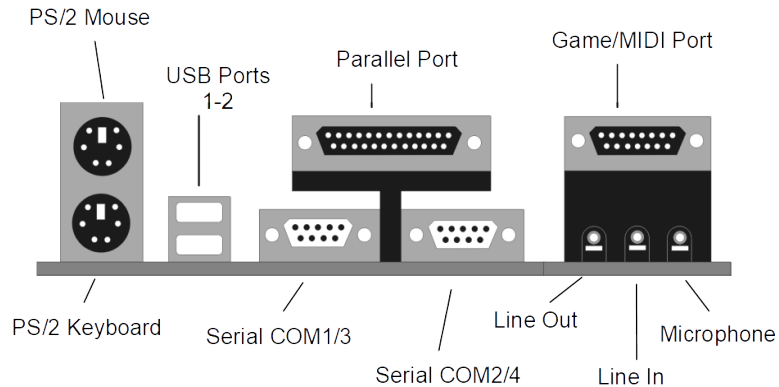

### Install A CPU

This mainboard has a Socket-462 CPU socket for AMD K7 processors.

**To ensure reliability, ensure that your processor has a original heatsink/cooling fan assembly.**

Do not try to install a Socket-370/Socket-7 processor in the Socket-462. A Socket-370/Socket-7 processor such as the PPGA Celeron, FCPGA Pentium-III, Pentium-MMX, or the AMD K5/K6 does not fit in the Socket-462.

The following list notes the processors that are currently supported by this mainboard.

**Athlon:** 650 MHz~Unlimited, FSB: 200 MHz

**Duron:** 550 MHz~Unlimited, FSB: 200 MHz

## M807 Mainboard User's Manual

### Installing a Socket-462 Processor

A processor installs into the ZIF (Zero Insertion Force) Socket-462 on the mainboard.

1. Locate the Socket-462 and CPUFAN1. Pull the locking lever out slightly from the socket and raise it to the upright position.

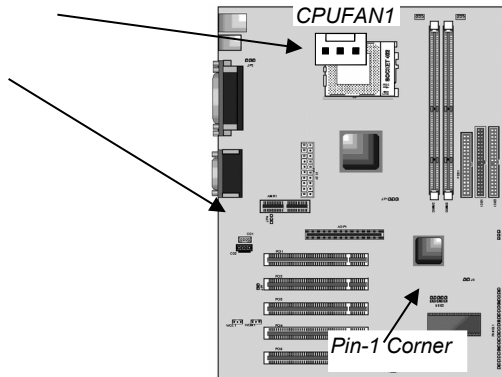

2. On the processor, identify the Pin-1 corner by its beveled edge.
3. On the Socket-462, identify the Pin-1 corner. The Pin-1 corner is at the top of the locking lever when it is locked.
4. Match the Pin-1 corners and insert the processor into the socket. No force is required and the processor should drop into place freely.
5. Swing the locking lever down and hook it under the catch on the side of the socket. This secures the CPU in the socket.
6. All processors should be installed with a combination heatsink/cooling fan (the original fan is recommended, the others' fan is not), connect the cable from the fan to the CPU fan power connector CPUFAN1.

## 2: Mainboard Installation

### Install Memory

The mainboard has two DIMM sockets for system memory modules. You must install at least one memory module in order to use the mainboard.

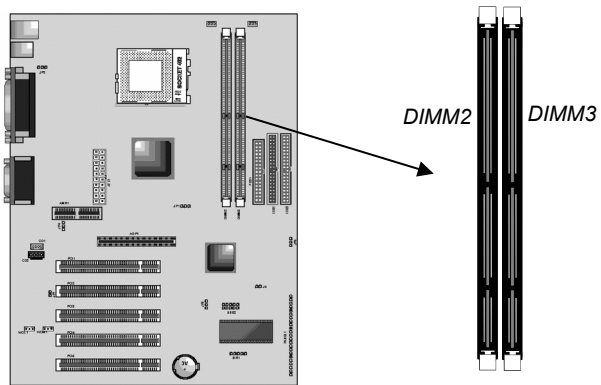

For this mainboard, you must use 168-pin, 3.3V unbuffered PC100 or PC133 SDRAM memory modules. You can install any size memory module from 32 MB to 512MB, so the maximum memory size is  $2 \times 512\text{MB} = 1\text{GB}$ .

The edge connectors on the memory modules have cut outs, which coincide with spacers in the DIMM sockets so that memory modules can only be installed in the correct orientation.

To install a module, push the retaining latches at either end of the socket outwards. Position the memory module correctly and insert it into the DIMM socket. Press the module down into the socket so that the retaining latches rotate up and secure the module in place by fitting into notches on the edge of the module.

## Setting Jumper Switches

Jumpers are sets of pins which can be connected together with jumper caps. The jumper caps change the way the mainboard operates by changing the electronic circuits on the mainboard. If a jumper cap connects two pins, we say the pins are **SHORT**. If a jumper cap is removed from two pins, the pins are **OPEN**.

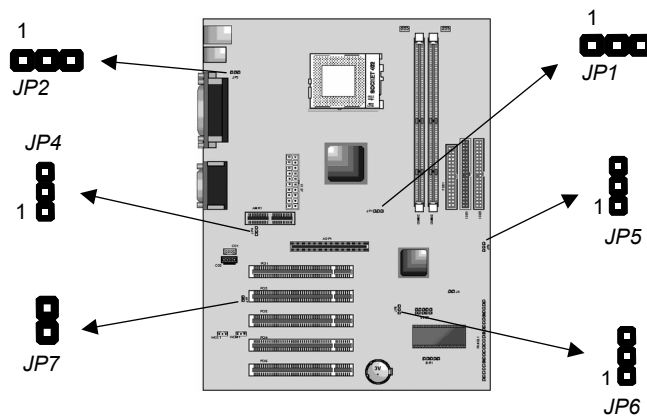

### Jumper JP1: Clear CMOS Memory

Use this jumper to clear the contents of the CMOS memory. You may need to clear the CMOS memory if the settings in the Setup Utility are incorrect and prevent your mainboard from operating. To clear the CMOS memory, disconnect all the power cables from the mainboard and then move the jumper cap into the **CLEAR** setting for a few seconds.

Function	Jumper Setting
Normal Operation	Short Pins 1-2
Clear CMOS Memory	Short Pins 2-3

### Jumper JP2: Enable USB port 1-2 wake-up

Use this jumper to enable device activity on USB ports 1-2 to power on the computer.

Function	Jumper Setting
Disable	Short Pins 1-2
Enable	Short Pins 2-3

## 2: Mainboard Installation

### Jumper JP4: Codec Selector

Use this jumper to select the onboard audio codec or Audio Modem Riser (AMR) slot.

Function	Jumper Setting
Use onboard codec	Short Pins 1-2
Use AMR slot codec	Short Pins 2-3

### Jumper JP5: BIOS Write Protect Selector

Use this jumper to make the BIOS read-only.

Function	Jumper Setting
Disable	Short Pins 1-2
Enable (read only)	Short Pins 2-3

### Jumper JP6: Enable USB port 3-4 wake-up

Use this jumper to enable device activity on USB ports 3-4 to power on the computer.

Function	Jumper Setting
Disable	Short Pins 1-2
Enable	Short Pins 2-3

### Jumper JP7: Onboard Codec Mode Selector

Use this jumper to define the onboard codec mode function.

Function	Jumper Setting
Master	Open Pins 1-2
Slave	Short Pins 1-2

## M807 Mainboard User's Manual

### Install the Mainboard

Install the mainboard in a system chassis (case). The board is an ATX size mainboard with a twin-tier of I/O ports. You can install this mainboard in an ATX case. Ensure that your case has an I/O cover plate that matches the ports on this mainboard.

Install the mainboard in a case. Follow the instructions provided by the case manufacturer using the hardware and internal mounting points on the chassis.

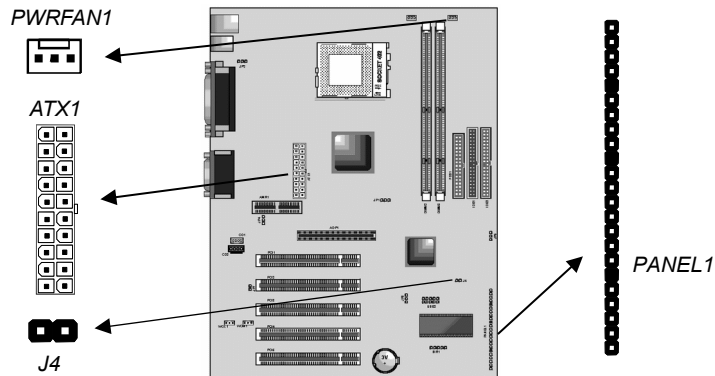

Connect the power connector from the power supply to the **ATX1** connector on the mainboard.

If there is a cooling fan installed in the system chassis, connect the cable from the cooling fan to the **PWRFAN1** fan power connector on the mainboard.

The **J4** header is for plug-in-the Dual Color LED (for example, red and green) which can be bought by the customers themselves. It can indicate several conditions as shown in the following tables. S1(POS) - Software power down. S3(STR) - Suspend to RAM. S4 - Suspend to Disk. S5 - Soft off. The header is not defined, but we suggest that “red” stands for Color 1 (S1/S3), “green” stands for Color 2 (Normal).

5VSB	Dark
Power On	Color 2 light on
S1/S3 mode	Color 1 Blinking
S4/S5 mode	Dark



## 2: Mainboard Installation

Connect the case switches and indicator LEDs to the **PANEL1** switch and LED connector header. See the illustration below for a guide to the header pin assignments.

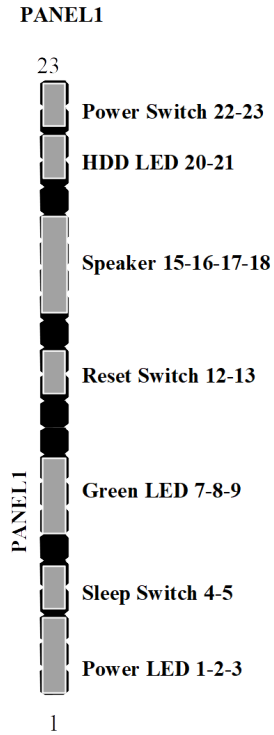

## M807 Mainboard User's Manual

### Optional Extension Brackets

For this mainboard, you can also obtain a USB module extension bracket. Install them by following the steps below.

#### Extended USB Module

This module bracket has two USB ports for more USB devices (USB port 3-4).

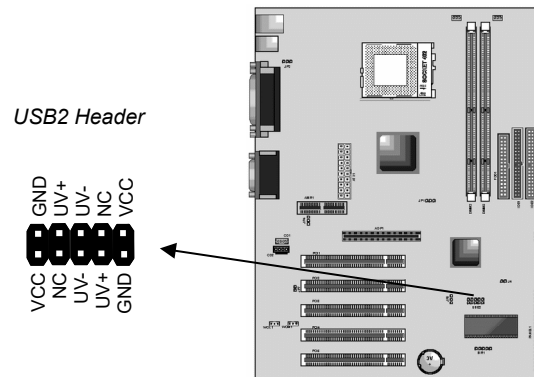

1. Locate the USB2 header on the mainboard.
2. Plug the bracket cable onto the USB2 header.
3. In the system chassis, remove a slot cover from one of the expansion slots and install the extension bracket in the opening. Use the screw that held the slot cover in place to secure the extension bracket to the chassis.

## 2: Mainboard Installation

### Install Other Devices

Install and connect any other devices in the system following the steps below.

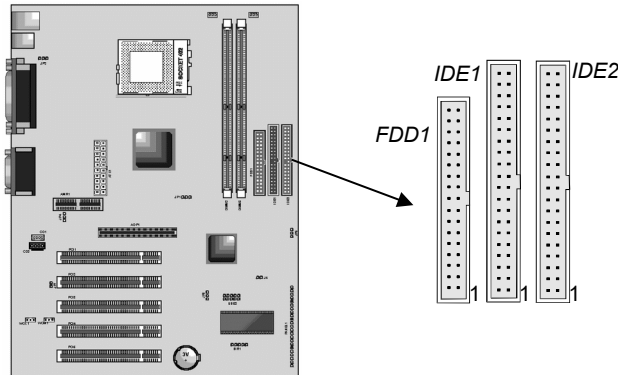

### Floppy Disk Drive

The mainboard ships with a floppy disk drive cable that can support one or two drives. Drives can be 3.5" or 5.25" wide, with capacities of 360K, 720K, 1.2MB, 1.44MB, or 2.88MB.

Install your drives and connect power from the system power supply. Use the cable provided to connect the drives to the floppy disk drive header **FDD1**.

### IDE Devices

IDE devices include hard disk drives, high-density diskette drives, and CD-ROM or DVD-ROM drives, among others.

The mainboard ships with an IDE cable that can support one or two IDE devices. If you connect two devices to a single cable, you must configure one of the drives as Master and one of the drives as Slave. The documentation of the IDE device will tell you how to configure the device as a Master or Slave device. The Master device connects to the end of the cable.

Install the device(s) and connect power from the system power supply. Use the cable provided to connect the device(s) to the Primary IDE channel connector **IDE1** on the mainboard.

If you want to install more IDE devices, you can purchase a second IDE cable and connect one or two devices to the Secondary IDE

## M807 Mainboard User's Manual

channel connector **IDE2** on the mainboard. If you have two devices on the cable, one must be Master and one must be Slave.

### Internal Sound Connections

If you have installed a CD-ROM drive or DVD-ROM drive, you can connect the drive audio cable to the onboard sound system. On the mainboard, locate the two 4-pin connectors **CD1** and **CD2**. There are two kinds of connector because different brands of CD-ROM drive have different kinds of audio cable connectors. Connect the cable to the appropriate connector.

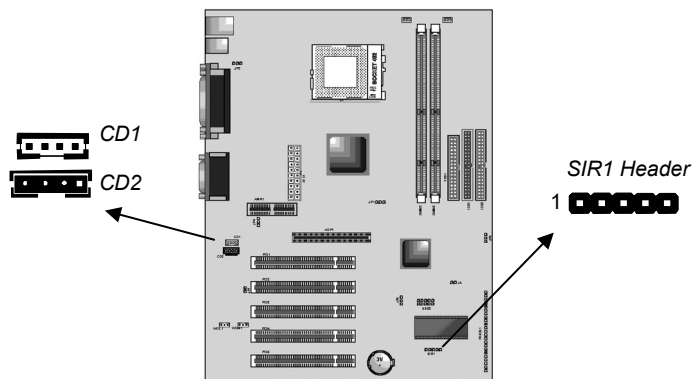

### Infrared Port

You can connect an infrared port to the mainboard. You can purchase this option from third-party vendors.

1. Locate the infrared port SIR1 header on the mainboard.
2. If you are adding an infrared port, connect the ribbon cable from the port to the SIR1 header and then secure the port to an appropriate place in your system chassis.

## 2: Mainboard Installation

### Expansion Slots

This mainboard has five 32-bit PCI expansion slots, one AMR slot and one AGP slot.

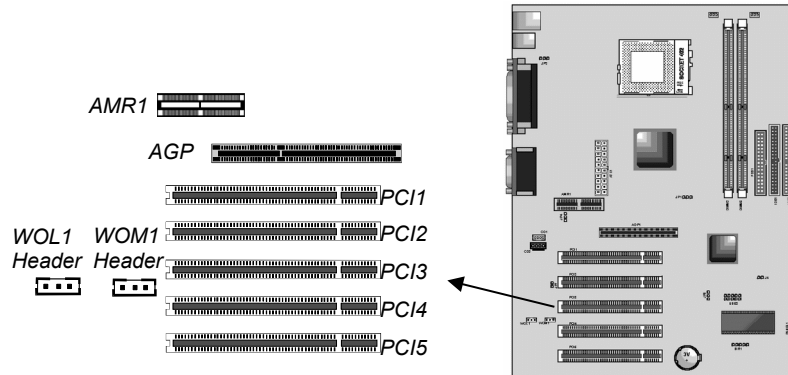

Follow the steps below to install a PCI/AMR/AGP expansion card.

1. Locate the AGP, AMR or PCI slots on the mainboard.
2. Remove the slot cover for this slot from the system chassis.
3. Insert the expansion card edge connector into the slot and press it firmly down into it so that it is fully inserted.
4. Secure the expansion card bracket to the system chassis using the screw that held the slot cover in place.

### AMR Slot

The AMR (Audio Modem Riser) slot is an industry standard slot that allows for the installation of a special audio/modem riser card. Different territories have different regulations regarding the specifications of a modem card. You can purchase an AMR card that is approved in your area and install it directly into the AMR slot.

### Wake On LAN

You can configure your system so that it powers down by software and can be resumed by alarms. If you have installed a LAN adapter expansion card, connect the card to the Wake On LAN header **WOL1**. This allows incoming traffic to resume the system from a software power down. You need to enable this feature in the system setup utility.

## **M807 Mainboard User's Manual**

### **Wake On Modem**

If you have installed a fax/modem card, connect the fax/modem to the Wake On Modem connector **WOM1**. You can then use the setup utility to program your computer to resume from a power saving mode whenever there is an incoming call to the fax/modem.

## Chapter 3

# BIOS Setup Utility

---

### Introduction

The BIOS Setup Utility records settings and information about your computer such as the date and time, the kind of hardware installed, and various configuration settings. Your computer uses this information to initialize all the components when booting up and functions as the basis for coordination between system components.

If the Setup Utility configuration is incorrect, it may cause the system to malfunction. It can even stop your computer from booting properly. If this happens, you can use the clear CMOS jumper to clear the CMOS memory used to store the configuration information, or you can hold down the **Page Up** key while you reboot your computer. Holding down the **Page Up** key also clears the setup information.

You can run the setup utility and manually make changes to the configuration. You might need to do this to configure some of the hardware that you install on or connect to the mainboard, such as the CPU, system memory, disk drives, etc.

## M807 Mainboard User's Manual

### Running the Setup Utility

Each time your computer starts, before the operating system loads, a message appears on the screen that prompts you to “*Press <DEL> to enter SETUP*”. When you see this message, press the **Delete** key and the Main menu page of the Setup Utility appears on your monitor.

CMOS Setup Utility – Copyright (C) 1984 – 2000 Award Software	
<ul style="list-style-type: none"><li>▶ <b>Standard CMOS Features</b></li><li>▶ Advanced BIOS Features</li><li>▶ Advanced Chipset Features</li><li>▶ Integrated Peripherals</li><li>▶ Power Management Setup</li><li>▶ PnP/PCI Configurations</li><li>▶ Hardware Monitor</li></ul>	<ul style="list-style-type: none"><li>▶ Frequency/Voltage Control<ul style="list-style-type: none"><li>Load Best Performance Defaults</li><li>Load Optimized Defaults</li><li>Set Password</li><li>Save &amp; Exit Setup</li><li>Exit Without Saving</li></ul></li></ul>
Esc : Quit      F9: Menu in BIOS      ↑ ↓ → ← : Select Item F10 : Save & Exit Setup	
Time, Date, Hard Disk Type . . .	

Listed below are explanations of the keys displayed at the bottom of the screens:

Key	Function
Esc	<b>Escape key:</b> Exits the current menu
← ↓ ↑ →	<b>Cursor keys:</b> Scroll through the items on a menu
+/-/PU/	<b>Plus, minus, Page Up and Page Down keys:</b>
PD	Modify the selected field's values
F10	<b>F10 key:</b> Saves the current configuration and exits setup
F1	<b>F1 key:</b> Displays a screen that explains all key functions
F5	<b>F5 key:</b> Loads previously saved values to CMOS
F6	<b>F6 key:</b> Loads a best performance configuration for the normal system.
F7	<b>F7 key:</b> Loads an optimum set of values for peak performance



### 3: BIOS Setup Utility

#### Standard CMOS Features Page

Use this page to set basic information such as the date and time, the IDE devices, and the diskette drives.

CMOS Setup Utility – Copyright (C) 1984 – 2000 Award Software  
Standard CMOS Features

Date (mm:dd:yy)	Tue, May 15 2000	Item Help
Time (hh:mm:ss)	12 : 8 : 59	
▶ IDE Primary Master	Press Enter 4303 MB	Menu Level ▶ Change the day, month, year and century.
▶ IDE Primary Slave	Press Enter None	
▶ IDE Secondary Master	Press Enter None	
▶ IDE Secondary Slave	Press Enter None	
Drive A	1.44M, 3.5 in.	
Drive B	None	
Floppy 3 Mode Support	Disabled	
Video	EGA/VGA	
Halt On	All Errors	

↑↓ →← : Move    Enter : Select    +/-/PU/PD:Value:    F10: Save    ESC: Exit    F1:General  
Help    F5:Previous Values    F6:Fail-Safe Defaults    F7:Optimized Defaults

<b>Date &amp; Time</b>	Use these items to set the system date and time
<b>IDE Devices</b>	Your computer has two IDE channels (Primary and Secondary) and each channel can be installed with one or two devices (Master and Slave). Use these items to configure each device on the IDE channel. Press <b>Enter</b> to display the IDE sub-menu. Press <b>Esc</b> to close the IDE device sub-menu and return to the Standard CMOS Features page.
<b>Floppy Drive A Floppy Drive B</b>	Use these items to set the size and capacity of the floppy diskette drive(s) installed in the system.
<b>Floppy 3 Mode Support</b>	Floppy 3 mode refers to a 3.5-inch diskette with a capacity of 1.2 MB. Floppy 3 mode is sometimes used in Japan.
<b>Video</b>	This item defines the video mode of the system. This mainboard has a built-in VGA graphics system; you must leave this item at the default value.
<b>Halt On</b>	This item defines the operation of the system POST (Power On Self Test) routine. You can use this item to select which types of errors in the POST are sufficient to halt the system.

## M807 Mainboard User's Manual

### Advanced BIOS Features Page

Use this page to set more advanced information about your system. Take some care with this page. Making changes can affect the operation of your computer.

CMOS Setup Utility – Copyright (C) 1984 – 2000 Award Software  
Advanced BIOS Features

Trend ChipAway Virus	Disabled	▲ ▼	Item Help															
Y2K Monitor	Disabled		▲ ▼	Menu Level ►														
H/W Reset Function	Disabled			▲ ▼	Allows you to choose the VIRUS warning feature for IDE Hard Disk boot sector protection. If this function is enabled and someone attempts to write data into this area, BIOS will show a warning message on screen and alarm beep													
CPU Internal Cache	Enabled				▲ ▼													
External Cache	Enabled					▲ ▼												
CPU L2 Cache ECC Checking	Enabled						▲ ▼											
Quick Power On Self Test	Enabled							▲ ▼										
First Boot Device	HDD-0								▲ ▼									
Second Boot Device	Floppy									▲ ▼								
Third Boot Device	CDROM										▲ ▼							
Boot Other Device	Enabled											▲ ▼						
Swap Floppy Drive	Disabled												▲ ▼					
Boot Up Floppy Seek	Disabled													▲ ▼				
Boot Up NumLock Status	On														▲ ▼			
Gate A20 Option	Normal															▲ ▼		
Typematic Rate Setting	Disabled																▲ ▼	
x Typematic Rate (Chars/Sec)	6																	▲ ▼
x Typematic Delay (Msec)	250	▲ ▼																
Security Option	Setup		▲ ▼															

↑↓→←: Move    Enter : Select    +/-/PU/PD: Value:    F10: Save    ESC: Exit    F1: General  
Help    F5: Previous Values    F6: Fail-Safe Defaults    F7: Optimized Defaults

<b>Trend ChipAway Virus</b>	This mainboard has built-in virus protection in the firmware. Use this item to enable or disable the built-in virus protection.
<b>Y2K Monitor</b>	If you enable this item, the system will monitor for errors generated by the year 2000 bug.
<b>H/W Reset Function</b>	Enables or disables the computer's hardware reset button.
<b>CPU Internal Cache</b>	All the processors that can be installed in this mainboard use internal (level 1) cache memory to improve performance. Leave this item at the default value <i>Enabled</i> for better performance.
<b>External Cache</b>	Most processors that can be installed in this system use external (L2) cache memory to improve performance. The exceptions are older SEPP Celeron CPUs running at 266 or 300 MHz. Enable this item for all but these two processors.
<b>CPU L2 Cache</b>	This item enables or disables ECC (Error Correction

### 3: BIOS Setup Utility

<b>ECC Checking</b>	Code) error checking on the CPU cache memory. We recommend that you leave this item at the default value.
<b>Quick Power On Self Test</b>	You can enable this item to shorten the power on testing (POST) and have your system start up a little faster. You might like to enable this item after you are confident that your system hardware is operating smoothly.
<b>1st/2nd/3rd Boot Device</b>	Use these three items to select the priority and order of the devices that your system searches for an operating system at start-up time.
<b>Boot Other Device</b>	If you enable this item, the system will search all other possible locations for an operating system if it fails to find one in the devices specified under the first, second, and third boot devices.
<b>Swap Floppy Drive</b>	If you have two floppy diskette drives in your system, this item allows you to swap the assigned drive letters so that drive A becomes drive B, and drive B becomes drive A.
<b>Boot Up Floppy Seek</b>	If this item is enabled, it checks the geometry of the floppy disk drives at start-up time. You don't need to enable this item unless you have an old diskette drive with 360K capacity.
<b>Boot Up NumLock Status</b>	This item defines if the keyboard Num Lock key is active when your system is started.
<b>Gate A20 Option</b>	This item defines how the system handles legacy software that was written for an earlier generation of processors. Leave this item at the default value.
<b>Typematic Rate Setting</b>	If this item is enabled, you can use the following two items to set the typematic rate and the typematic delay settings for your keyboard.
<b>Typematic Rate (Chars/Sec)/ Delay (Msec)</b>	If the item Typematic Rate Setting is enabled, you can use these items to define how many characters per second are generated by a held-down key and how many milliseconds must elapse before a held-down key begins generating repeat characters.
<b>Security Option</b>	If you have installed password protection, this item defines if the password is required at system start up, or if it is only required when a user tries to enter the Setup Utility.
<b>OS Select For DRAM &gt; 64 MB</b>	This item is only required if you have installed more than 64 MB of memory and you are running the OS/2 operating system. Otherwise, leave this item at the default Non-OS2.

## M807 Mainboard User's Manual

<b>HDD S.M.A.R.T. Capability</b>	Enable this item if your hard disk(s) supports SMART (Self-Monitoring, Analysis and Reporting Technology)
<b>Video BIOS Shadow</b>	When enabled this item copies the VGA BIOS into system DRAM.
<b>C8000-CBFFF to DC000-DFFFF Shadow</b>	When enabled, the ROM with the specified address is copied into system DRAM. It will also reduce the size of memory available to the system.

### 3: BIOS Setup Utility

#### Advanced Chipset Features Page

This page sets some of the parameters of the mainboard components including the memory, and the system logic.

CMOS Setup Utility – Copyright (C) 1984 – 2000 Award Software  
Advanced Chipset Features

Bank 0/1 DRAM Timing	SDRAM 8/10ns	▲   ▼	Item Help
Bank 2/3 DRAM Timing	SDRAM 8/10ns		Menu Level ▶
Bank 4/5 DRAM Timing	SDRAM 8/10ns		
SDRAM Cycle Length	3		
DRAM Clock	Host CLK		
PCI Master Pipeline Req	Enabled		
P2C/C2P Concurrency	Enabled		
Fast R-W Turn Around	Disabled		
System BIOS Cacheable	Enabled		
Video RAM Cacheable	Enabled		
AGP Aperture Size	64M		
AGP 4X Mode	Enabled		
AGP Driving Control	Auto		
X AGP Driving Value	DA		
K7 CLK_CTL Select	Optimal		
OnChip USB	Enabled		
OnChip USB 2	Disabled		
USB Keyboard Support	Disabled		
USB Mouse Support	Disabled		

↑↓→←: Move    Enter: Select    +/-/PU/PD: Value:    F10: Save    ESC: Exit    F1: General  
Help    F5: Previous Values    F6: Fail-Safe Defaults    F7: Optimized Defaults

<b>Bank 0/1 2/3 4/5 DRAM Timing</b>	This item allows you to select the timing for the DRAM slots, depending on whether the board has paged SDRAMs.
<b>SDRAM Cycle Length</b>	This field enables you to set the CAS latency time in HCLKs of 2/2 or 3/3. The system board designer should have set the values in this field, depending on the DRAM installed. Do not change the values in this field unless you change specifications of the installed DRAM or the installed CPU.
<b>DRAM Clock</b>	Enables the user to select the DRAM Clock.
<b>PCI Master Pipeline Req</b>	When this is enabled, the system allows the PCI Master pipeline request.

## M807 Mainboard User's Manual

<b>P2C/C2P Concurrency</b>	When disabled, the CPU bus is occupied during the entire PCI operation period.
<b>Fast R-W Turn Around</b>	When this is enabled, the chipset will insert one extra clock to the turn-around of back-to-back DRAM cycles.
<b>System BIOS Cacheable</b>	When enabled, the System BIOS will be cached for faster execution.
<b>Video RAM Cacheable</b>	When enabled, the graphics card's local memory will be cached for faster execution. However, if any program writes to this memory area, a system error may result.
<b>AGP Aperture Size</b>	This option determines the effective size of the AGP Graphic <i>Aperture</i> , where memory-mapped graphic data structures are located.
<b>AGP 4X Mode</b>	This item allows you to enable or disable the caching of display data for the video memory of the processor. Enabling can greatly improve the display speed. If your graphics display card does not support this feature, you need to disable this item.
<b>AGP Driving Control</b>	This item can be used to signal driving current on AGP cards to auto or Manual. Some AGP cards need stronger than normal driving current in order to operate. We recommend that you set this item to Auto by default.
<b>AGP Driving Value</b>	When the previous item AGP Driving Control is set to Manual, you can use this item to set the AGP current driving value.
<b>K7 CLK_CTL Select</b>	This item adjusts the CPU clock to match the internal clock.
<b>OnChip USB, 2</b>	This item allows you to enable the USB port and the USB 2 port, if you have installed a or more USB device on the system board.
<b>USB Keyboard Support</b>	Enables function when the USB keyboard is being used. Disabled (default) when an AT keyboard is used.
<b>OnChip Sound</b>	Disabling this function turns off the onboard audio chip.
<b>OnChip Modem</b>	This should be enabled if your system has a modem installed on the system board and you wish to use it.
<b>Onboard PCI LAN</b>	This should be enabled if your system is connected to a Local Area Network (LAN).

### 3: BIOS Setup Utility

<b>CPU to PCI Write Buffer</b>	When enabled, up to four words of data can be written to the PCI bus without interrupting the CPU. When disabled, a write buffer is not used and the CPU read cycle will not be completed until the PCI bus signals that it is ready to receive the data.
<b>PCI Dynamic Bursting</b>	When enabled, every write transaction goes to the write buffer. "Burstable" transactions then burst on the PCI bus and "nonburstable" transactions do not.
<b>PCI Master 0 WS Write</b>	When enabled, writes to the PCI bus are executed with zero wait states.
<b>PCI Delay Transaction</b>	The chipset has an embedded 32-bit posted write buffer to support delay transactions cycles. Enable to support compliance with PCI specification version 2.1.
<b>PCI#2 Access #1 Retry</b>	When enabled, the AGP Bus (PCI#1) access to PCI Bus (PCI#2) is executed with the error retry feature.
<b>AGP Master 1 WS Write</b>	This implements a single delay when writing to the AGP Bus. By default, two-wait states are used by the system, allowing for greater stability.
<b>AGP Master 1 WS Read</b>	This implements a single delay when reading to the AGP Bus. By default, two-wait states are used by the system, allowing for greater stability.
<b>Memory Parity/ECC Check</b>	Enable this item to allow BIOS to perform a parity/ECC check to the POST memory tests. Enable only if the system DRAM supports parity/ECC checking.

## M807 Mainboard User's Manual

### Integrated Peripherals Page

This page sets some of the parameters for peripheral devices connected to the system.

CMOS Setup Utility – Copyright (C) 1984 – 2000 Award Software  
Integrated Peripherals

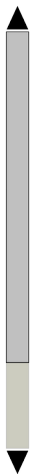
On-Chip IDE Channel0	Enabled			Item Help
On-Chip IDE Channel1	Enabled			Menu Level ▶
IDE Prefetch Mode	Enabled			
Primary Master	PIO	Auto		
Primary Slave	PIO	Auto		
Secondary Master	PIO	Auto		
Secondary Slave	PIO	Auto		
Primary Master	UDMA	Auto		
Primary Slave	UDMA	Auto		
Secondary Master	UDMA	Auto		
Secondary Slave	UDMA	Auto		
Init Display First		PCI Slot		
Onboard FDD Controller		Enabled		
Onboard Serial Port 1		3F8/IRQ4		
Onboard Serial Port 2		2F8/IRQ3		
UART 2 Mode		Standard		
x IR Function Duplex		Half		
x TX,RX inverting enable		No, Yes		
Onboard Parallel Port		378/IRQ7		

↑↓→← : Move    Enter : Select    +/-/PU/PD:Value:    F10: Save    ESC: Exit    F1:General  
Help    F5:Previous Values    F6:Fail-Safe Defaults    F7:Optimized Defaults

<b>On-Chip IDE Channel 0,1</b>	Use these items to enable or disable the PCI IDE channels that are integrated on the mainboard.
<b>Primary/Secondary Master/Slave PIO</b>	Each channel supports a master device and a slave device. These four items let you assign which kind of PIO (Programmed Input/Output) is used by IDE devices. You can choose Auto, to let the system auto detect which PIO mode is best, or you can install a PIO mode from 0-4.
<b>Primary/Secondary Master/Slave UDMA</b>	Each channel supports a master device and a slave device. This motherboard supports UltraDMA and provides faster access to IDE devices. If you install a device that supports UltraDMA, change the appropriate item on this list to Auto. You may have to install the UltraDMA driver.
<b>Init Display First</b>	Use this item to define if your graphics adapter is installed in one of the PCI slots or select Onboard



### 3: BIOS Setup Utility

	if you have a graphics system integrated on the mainboard.
<b>Onboard FDD Controller</b>	This option enables the onboard floppy disk drive controller.
<b>Onboard Serial Port 1, 2</b>	This option is used to assign the I/O address for the onboard serial ports.
<b>UART2 Mode</b>	This field is available if the Onboard Serial Port 2 field is set to any option but "Disabled." UART Mode enables you to select the infrared communication protocol—Standard (default), HPSIR or ASKIR. HPSIR is Hewlett Packard's infrared communication protocol with a maximum baud rate up to 115.2 Kbps. ASKIR is Sharp's infrared communication protocol with a maximum baud rate up to 57.6 Kbps.
<b>IR Function Duplex</b>	This field is available when UART 2 Mode is set to either ASKIR or HPSIR. This item determines the infrared (IR) function of the onboard infrared chip. Full-duplex means that you can transmit and send information simultaneously. Half duplex is the transmission of data in both directions, but only one direction at a time.
<b>TX, RX inverting enable</b>	Defines the voltage level for Infrared module RxD (receive) mode and TxD (transmit) mode. This setting has to match the requirements of the infrared module used in the system.
<b>Onboard Parallel Port</b>	This option is used to assign the I/O address for the onboard parallel port.
<b>Onboard Parallel Mode</b>	This feature enables you to set the data transfer protocol for your parallel port. Normal allows data output only. Extended Capabilities Port (ECP) and Enhanced Parallel Port (EPP) are bi-directional modes, allowing both data input and output. ECP and EPP modes are only supported with EPP and ECP aware peripherals.
<b>ECP Mode Use DMA</b>	When the onboard parallel port is set to ECP mode, the parallel port has the option to use DMA "3" or DMA "1."
<b>Parallel Port EPP Type</b>	This option sets the Enhanced Parallel Port (EPP) specification.
<b>Onboard Legacy Audio</b>	This option enables the onboard legacy audio function. When enabled the following items become available.

## M807 Mainboard User's Manual

<b>Sound Blaster</b>	This feature is used to enable or disable a Sound Blaster card if installed.
<b>SB I/O Base Address</b>	This item lets you set the I/O base address for the Sound Blaster card.
<b>SB IRQ Select</b>	This item lets you set the Interrupt Request (IRQ) for the Sound Blaster card.
<b>SB DMA Select</b>	This item lets you select the Direct Memory Access (DMA) for the Sound Blaster card.
<b>MPU-401, MPU-401 I/O Address</b>	Use the two items to enable the MPU-401 function and set the I/O address for the game port.
<b>Game Port (200-207H)</b>	This item shows the I/O address for the game port.

### 3: BIOS Setup Utility

#### Power Management Setup Page

This page sets some of the parameters for system power management operation.

CMOS Setup Utility – Copyright (C) 1984 – 2000 Award Software  
Power Management Setup

▶ Power Management	Press Enter	Item Help
ACPI Suspend Type	S1(POS)	Menu Level ▶
PM Control by APM	Yes	
Video Off Option	Suspend --> Off	
Video Off Method	DPMS Support	
MODEM Use IRQ	3	
Soft-Off by PWRBTN	Delay 4 Sec	
State After Power Failure	Off	
▶ Wake Up Events	Press Enter	

↑↓→← : Move    Enter : Select    +/-/PU/PD:Value:    F10: Save    ESC: Exit    F1:General  
Help    F5:Previous Values    F6:Fail-Safe Defaults    F7:Optimized Defaults

**Power Management**      This item acts like a master switch for the power-saving modes and hard disk timeouts. If this item is set to Max Saving, power-saving modes occur after a short timeout. If this item is set to Min Saving, power-saving modes occur after a longer timeout. If the item is set to User Define, you can insert your own timeouts for the power-saving modes.

**ACPI Suspend Type**      This item defines how your system suspends. S1(POS), the suspend mode is equivalent to a software power down. If you select S3 (STR), the suspend mode is a suspend to RAM – the system shuts down with the exception of a refresh current to the system memory.

**PM Control by APM**      This field allows you to control the PC Monitor's power management features via Intel-Microsoft Advanced Power Management software. Once you have enabled the APM interface, some settings made in the BIOS Setup program may be overridden by APM.

**Video Off Option**      This option defines if the video is powered

## M807 Mainboard User's Manual

---

	down when the system is put into suspend mode.
<b>Video Off Method</b>	This item defines how the video is powered down to save power.
<b>MODEM Use IRQ</b>	If you want an incoming call on a modem to automatically resume the system from a power-saving mode, use this item to specify the interrupt request line (IRQ) that is used by the modem. You might have to connect the fax/modem to the mainboard Wake On Modem connector for this feature to work.
<b>Soft-Off by PWRBTN</b>	Under ACPI (Advanced Configuration and Power management Interface) you can create a software power down. In a software power down, the system can be resumed by Wake Up Alarms. This item lets you install a software power down that is controlled by the normal power button on your system. If the item is set to Instant-Off, then the power button causes a software power down. If the item is set to "Delay 4 Sec." then you have to hold the power button down for four seconds to cause a software power down.
<b>State After Power Failure</b>	Use this item to set a system power state when power restores after sudden AC power loss.
<b>Wake Up Events</b>	This item opens a submenu that enables you to set events that will resume the system from a power saving mode. Select Wake Up Events and press <b>Enter</b> to display the following items: VGA, LPT & COM, HDD & FDD, PCI Master, PowerOn by PCI Card, Wake Up On LAN/Ring, RTC Alarm Resume, Primary INTR, and IRQs Activity Monitoring.

---

### 3: BIOS Setup Utility

#### PnP/PCI Configurations Page

This page sets some of the parameters for devices installed on the PCI bus and devices that use the system plug and play capability.

CMOS Setup Utility – Copyright (C) 1984 – 2000 Award Software  
PnP/PCI Configurations

PNP OS Installed	Yes	Item Help
Reset Configuration Data	Disabled	
Resources Controlled by	Auto(ESCD)	Menu Level ► Default is Disabled. Select Enabled to reset Extended System Configuration Data (ESCD) when you exit Setup if you have installed a new add-on and the system reconfiguration has caused such a serious conflict that the OS cannot boot.
x IRQ Resources	Press Enter	
x DMA Resources	Press Enter	
PCI/VGA Palette Snoop	Disabled	
Assign IRQ For VGA	Enabled	
Assign IRQ For USB	Enabled	
INT Pin 1 Assignment	Auto	
INT Pin 2 Assignment	Auto	
INT Pin 3 Assignment	Auto	
INT Pin 4 Assignment	Auto	

↑↓→←: Move    Enter : Select    +/-/PU/PD:Value:    F10: Save    ESC: Exit    F1:General  
Help    F5:Previous Values    F6:Fail-Safe Defaults    F7:Optimized Defaults

<b>PNP OS Installed</b>	Setting this option to “Yes” allows the PnP OS (instead of BIOS) to assign the system resources such as IRQ and I/O address to the ISA PnP device.
<b>Reset Configuration Data</b>	If you enable this item and restart the system, any PnP configuration data stored in the BIOS setup is cleared from memory. New updated data is created.
<b>Resources Controlled By</b>	<p>You should leave this item at the default Auto (ESCD). Under this setting, the system dynamically allocates resources to plug and play devices as they are required. If you cannot get a legacy ISA (Industry Standard Architecture) expansion card to work properly, you might be able to solve the problem by changing this item to Manual, and then opening up the <i>IRQ Resources</i> and <i>Memory Resources</i> sub-menus.</p> <p>In the <i>IRQ Resources</i> sub-menu, if you change any of the IRQ assignments to Legacy ISA, then</p>

## M807 Mainboard User's Manual

---

	that Interrupt Request Line is reserved for a legacy ISA expansion card. Press <b>Esc</b> to close the IRQ Resources sub-menu.
<b>PCI/VGA Palette Snoop</b>	This item is designed to overcome some problems that can be caused by some non-standard VGA cards. This board includes a built-in VGA system that does not require palette snooping so you must leave this item disabled.
<b>Assign IRQ For VGA</b>	Names the interrupt request (IRQ) line assigned to the VGA (if any) on your system. Activity of the selected IRQ always awakens the system.
<b>Assign IRQ For USB</b>	Names the interrupt request (IRQ) line assigned to the USB (if any) on your system. Activity of the selected IRQ always awakens the system.
<b>INT Pin 1,2,3,4 Assignment</b>	You should leave these items at the default Auto. Under these settings, the system assigns resources for the PCI INT-A/B/C/D Router as they are required.

---

### 3: BIOS Setup Utility

#### Hardware Monitor Page

This page sets some of the parameters for the hardware monitoring function of this mainboard.

CMOS Setup Utility – Copyright (C) 1984 – 2000 Award Software  
Hardware Monitor

<b>Shutdown Temperature</b> Current CPU Temp. Current System Temp. Current CPUFAN1 speed Current CPUFAN2 speed Vcore 3.3V 5V 12V	<b>Disabled</b>	<b>Item Help</b> Menu Level ►
--	-----------------	----------------------------------

↑↓→← : Move    Enter : Select    +/-/PU/PD:Value:    F10: Save    ESC: Exit    F1:General  
 Help    F5:Previous Values    F6:Fail-Safe Defaults    F7:Optimized Defaults

<b>Shutdown Temperature</b>	Enables you to set the maximum temperature the system can reach before powering down.
<b>System Component Characteristics</b>	These fields provide you with information about the systems current operating status. You cannot make changes to these fields. The following information is displayed:  CPU Temperature System Temperature CPU FAN (in RPMs) System FAN (in RPMs) Vcore (CPU Core voltage) 3.3V (onboard 3.3 volt) 5V (power supply's 5 volt) 12V (power supply's 12 volt).

## M807 Mainboard User's Manual

### Frequency/Voltage Control

This page sets some of the parameters for the Frequency/Voltages of this mainboard.

CMOS Setup Utility – Copyright (C) 1984 – 2000 Award Software  
CPU Plug and Play

Auto Detect DIMM/PCI Clk	Enabled	Item Help
CPU Host/PCI Clock/Spread Spec.	Default	Menu Level ▶

↑↓→← : Move    Enter : Select    +/-/PU/PD:Value:    F10: Save    ESC: Exit    F1:General  
Help    F5:Previous Values    F6:Fail-Safe Defaults    F7:Optimized Defaults

<b>Auto Detect DIMM/PCI Clk</b>	When this item is enabled, BIOS will disabled the clock signal of free DIMM and PCI slots.
<b>CPU Host/PCI Clock/Spread Spec.</b>	Use the <i>DIMM/PCI Clock</i> to set the system bus frequency/PCI clock/spread spectrum for the installed processor.



### 3: BIOS Setup Utility

#### **Load Best Performance Defaults**

If you select this item and press **Enter** a dialog box appears. If you press **Y**, and then **Enter**, the Setup Utility loads a set of best-performance default values. These defaults are quite demanding and your system might not function properly if you are using slower memory chips or other low-performance components.

#### **Load Optimized Defaults**

If you select this item and press **Enter**, a dialog box appears. If you press **Y**, and then **Enter**, the Setup Utility loads a set of fail-safe default values. These default values are not very demanding and they should allow your system to function with most kinds of hardware and memory chips.

#### **Set Password**

If you highlight this item and press **Enter**, a dialog box appears which lets you enter a password. You can enter no more than eight letters or numbers. Press **Enter** after you have typed in the password. A second dialog box asks you to retype the password for confirmation. Press **Enter** after you have retyped it correctly. The password is then required to access the Setup Utility or for that and at start-up, depending on the setting of the Password Check item in Advanced Setup.

#### **Change or Remove the Password**

Highlight this item, press **Enter** and type in the current password. At the next dialog box, type in the new password, or just press **Enter** to disable password protection.

## **M807 Mainboard User's Manual**

### **Save & Exit Setup**

Highlight this item and press **Enter** to save the changes that you have made in the Setup Utility configuration and exit the program. When the Save and Exit dialog box appears, press **Y** to save and exit, or press **N** to exit without saving.

### **Exit Without Saving**

Highlight this item and press **Enter** to discard any changes that you have made in the Setup Utility and exit the setup program. When the Exit Without Saving dialog box appears, press **Y** to discard changes and exit, or press **N** to return to the setup main menu.

## Chapter 4

# Software & Applications

---

### Introduction

The support software CD-ROM that is included in the mainboard package contains all the drivers and utility programs needed to properly run our products. Below you can find a brief description of each software program, and the location for your mainboard version. More information on some programs is available in a README file, located in the same directory as the software.

**If the operating system used in your system is Windows 98, it will automatically install all the drivers and utilities for your board.** See the Auto-Installing under Windows 98 section.

### Installing Support Software

The software on the support CD-ROM is for Windows 95/NT/2000 and Windows 98. The installation procedure differs depending on which Operating System you have, but the automatic installation is now for Win98 only.

#### Installing under Windows 95/NT/2000

To install support software for Windows 95/NT/2000 follow this general procedure:

1. Insert the support CD-ROM disc in the CD-ROM drive.  
*(The system might get an error message from the PnP function. Don't care the message. You don't really need that file to install the drivers)*
2. Use My Computer or Windows Explorer to look at the directory structure. You must use the Open command in the right-button menu. Double-clicking on the drive icon will result in an error message because the disc's AutoRun feature doesn't work in Windows 95/NT/2000.
3. Execute the EXE file name given in the description below.

## **M807 Mainboard User's Manual**

*Note: The correct path name for each software driver is provided, where **D:** identifies the CD-ROM drive letter – modify if necessary.*

### **Bus Master IDE Driver**

The IDE Bus Master Drivers allows the system to properly manage the IDE channels on the mainboard. You need to install two drivers if you are running Windows 9x.

- ◆ Windows 9x – D:\IDE\VIA\Setup.EXE

### **USB Driver**

The USB Driver allows the system to recognize the USB ports on the mainboard. You need to install this driver if you are running Windows 95. Windows 95 OSR2 does not require this driver.

This driver is available for:

- ◆ Win95 – D:\USB\EUSBSUPP\USBSUPP.EXE
- ◆ Win95 (Chinese) – D:\USB\CUSBSUPP\CUSBSUPP.EXE

### **3Deep Software**

Find the software here:

- ◆ D:\3Deep\3Deep 3.3\Setup.EXE

### **BIOS Update Utility**

The BIOS Update utility allows you to update the BIOS file on the mainboard to a newer version. You can download the latest version of the BIOS setup available for your mainboard from the website.

- ◆ D:\UTILITY\AMINF321.EXE

### **PC-Cillin Software**

The PC-cillin software program provides anti-virus protection for your system.

This program is available for:

- ◆ DOS – D:\PC-CILLIN\DOS\PCSCAN.EXE
- ◆ Win9x – D:\PC-CILLIN\WIN98\SETUP.EXE

## 4: Software & Applications

### Auto-installing under Windows 98

The support software CD-ROM disc loads automatically under Windows 98. When you insert the CD-ROM disc in the system CD-ROM drive the Autorun feature will automatically bring up the install screen. The screen has three buttons on it, Setup, Browse CD and Exit. See the following screen illustration.

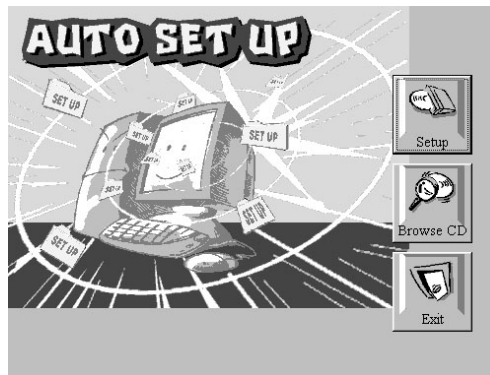

When you click on the **Setup** button the software installation program will run and you can select what kind of installation you want to do, as explained later in this section.

The **Browse CD** button is the standard Windows command that allows you to examine the contents of the disc using the Windows 98 file browsing interface.

The **Exit** button closes the Auto Setup window. To run the program again, reinsert the CD-ROM disc in the drive or click on AutoRun in the context sensitive menu for the CD-ROM drive icon in a file browser window.

### Installing Software with Auto Setup

To install support software for the system board follow this procedure:

1. Click on the **Setup** button. The install program will load and display the following screen. Click the **Next** button.

## M807 Mainboard User's Manual



2. Select the items that you want to setup by clicking on it (the default options are recommended). Click the **Next** button to proceed.

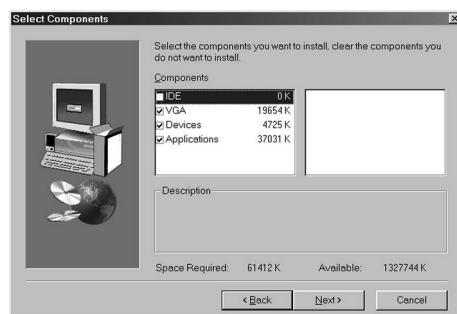

3. The support software will automatically install.

Once any of the installation procedures start, software is automatically installed in sequence. You will need to follow the onscreen instructions, confirm commands and allow the computer to restart as few times as is needed to complete installing whatever software you selected to install. When the process is finished, all the support software will be installed and working.

There are some utilities that you have to manually install if you need, check to the above section.