

M7VIG-D

FCC Statement and Copyright

This equipment has been tested and found to comply with the limits of a Class B digital device, pursuant to Part 15 of the FCC Rules. These limits are designed to provide reasonable protection against harmful interference in a residential installation. This equipment generates, uses and can radiate radio frequency energy and, if not installed and used in accordance with the instructions, may cause harmful interference to radio communications. There is no guarantee that interference will not occur in a particular installation.

The vendor makes no representations or warranties with respect to the contents here of and specially disclaims any implied warranties of merchantability or fitness for any purpose. Further the vendor reserves the right to revise this publication and to make changes to the contents here of without obligation to notify any party beforehand.

Duplication of this publication, in part or in whole is not allowed without first obtaining the vendor's approval in writing.

The content of this user's is subject to be changed without notice and we will not be responsible for any mistakes found in this user's manual. All the brand and product names are trademarks of their respective companies.

Contents

ENGLISH	1
M7VIG-D Features	1
Package contents	2
Layout of M7VIG-D.....	3
CPU Installation	4
DDR DIMM Modules: DDR1-2	5
Jumpers, Headers, Connectors & Slots	6
ESPAÑOL	12
Características del M7VIG-D	12
Contenido del Paquete	13
Disposición del M7VIG-D.....	14
Instalación del CPU	15
Módulos DDR DIMM: DDR1-2	16
Conectores, Cabezales, Puentes y Ranuras	17
DEUTSCH	23
Merkmals des M7VIG-D	23
Verpackungsinhalt	24
Layout des M7VIG-D.....	25
Installation der CPU.....	26
DDR-DIMM-Modules: DDR1-2.....	27
Jumpers, Headers, Connectors & Slots	28
WARPSPEEDER	35
Introduction.....	35
System Requirement	35
Installation.....	36
Usage.....	37
TROUBLE SHOOTING	45
SOLUCIÓN DE PROBLEMAS	46
PROBLEMLÖSUNG	47

Motherboard Description

English

M7VIG-D Features

CPU:

- Supports the single AMD Socket A for Athlon™ (Thunderbird™) / Athlon XP™/ Duron™ processors.
- Running at 200/ 266MHz Front Side Bus.

Chipset:

- North Bridge: VIA VT8375 (KM266) Chipset.
- South Bridge: VT8235 Chipset.

Main Memory

- Supports up to 2 DDR devices.
- Supports 200/266MHz (without ECC) devices.
- The largest memory capacity is 2GB.

Slots

- One AMR slot.
- Two 32-bit PCI Bus slots.
- One AGP slot.

Onboard IDE

- Supports IDE hard disk drives.
- Supports Ultra 133/ 100/ 66/ 33, PIO modes, LBA mode.

On Board VGA

- Integrate S3 Graphics 128-bit ProSavage 8 graphics accelerator.

Audio

- AC97 2.2 compatible.
- PC99 complaint.
- Supports 2 speaker out channels.

On Board Peripherals

- Supports 360K, 720K, 1.2MB, 1.44MB and 2.88MB floppy disk drivers.
- Supports 1 serial port.
- Supports 1 VGA port.
- Supports 1 multi-mode parallel port. (SPP/EPP/ECP mode)
- Supports PS/2 mouse and PS/2 keyboard.
- Supports 2 back ports and 4 front ports. (Optional)

Motherboard Description

BIOS

- AWARD legal Bios.
- Supports APM1.2.
- Supports ACPI.
- Supports USB Function.

Operating System

- Offers the highest performance for Windows 98, Windows NT, Windows 2000, Windows Me, Windows XP, LINUX and SCO UNIX.

Dimensions

- Micro ATX Form Factor: 22.9cm X 21.3cm (W X L)

Package contents

- HDD Cable X 1, FDD Cable X 1, Fully Setup Driver CD X 1
- Flash Memory Writer for BIOS update X 1
- USB Cable X 2 (Optional)
- Rear I/O Panel for Micro-ATX Case X 1 (Optional)
- SPDIF OUT Cable X1 (Optional)

Motherboard Description

Layout of M7VIG-D

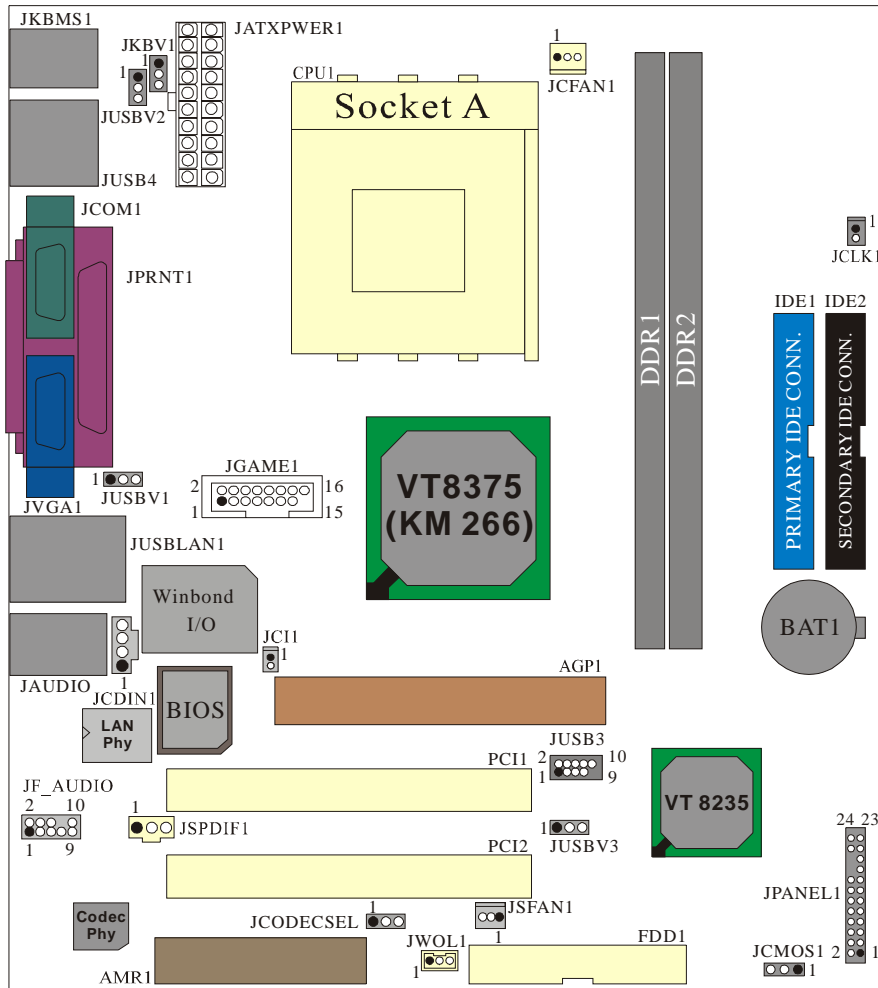

Motherboard Description

CPU Installation

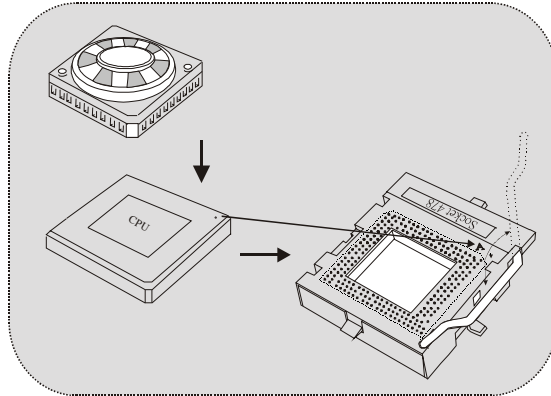

1. Pull the lever sideways away from the socket then raise the lever up to 90-degree angle.
2. Locate Pin A in the socket and lock for the white dot or cut edge in the CPU. Match Pin A with the white dot/cut edge then insert the CPU.
3. Press the lever down. Then Put the fan on the CPU and buckle it and put the fan's power port into the JCFAN1, then to complete the installation.

CPU/ System Fan Headers: JCFAN1/ JSFAN1

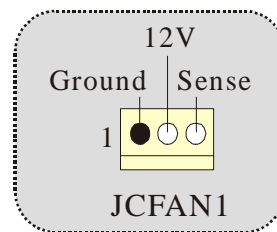
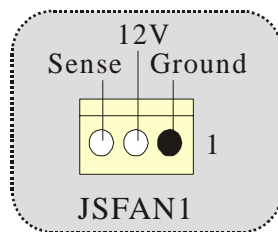

Motherboard Description

DDR DIMM Modules: DDR1-2

DRAM Access Time: 2.5V Unbuffered DDR 200/266MHz (without ECC) Type required.

DRAM Type: 64MB/ 128MB/ 256MB/ 512MB/ 1GB DIMM Module (184 pin)

DIMM Socket Location	DDR Module	Total Memory Size (MB)
DDR 1	64MB/128MB/256MB/512MB/1GB *1	Max is 2GB
DDR 2	64MB/128MB/256MB/512MB/1GB *1	

* The list shown above for DRAM configuration is only for reference.

How to install a DIMM Module

1. The DIMM socket has a “ Plastic Safety Tab”, and the DIMM memory module has an “Asymmetrical notch”, so the DIMM memory module can only fit into the slot in one direction.

2. Push the tabs out. Insert the DIMM memory modules into the socket at a 90-degree angle, then push down vertically so that it will fit into the place.

3. The Mounting Holes and plastic tabs should fit over the edge and hold the DIMM memory modules in place.

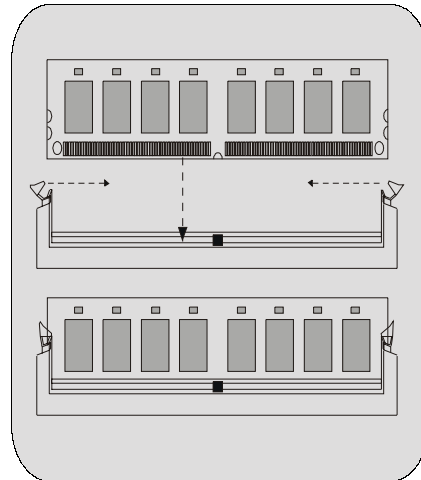

Motherboard Description

Jumpers, Headers, Connectors & Slots

Hard Disk Connectors: IDE1/ IDE2

The motherboard has a 32-bit Enhanced PCI IDE Controller that provides PIO Mode 0~4, Bus Master, and Ultra DMA / 33/ 66/ 100/ 133 functionality. It has two HDD connectors IDE1 (primary) and IDE2 (secondary).

The IDE connectors can connect a master and a slave drive, so you can connect up to four hard disk drives. The first hard drive should always be connected to IDE1.

Floppy Disk Connector: FDD1

The motherboard provides a standard floppy disk connector that supports 360K, 720K, 1.2M, 1.44M and 2.88M floppy disk types. This connector supports the provided floppy drive ribbon cables.

Audio Modem Riser Slot: AMR1

(Only support slave card)

The AMR specification is an open Industry Standard Architecture and that defines a hardware scalable riser card interface, which supports audio and modem only.

Peripheral Component Interconnect Slots: PCI1-2

This motherboard is equipped with 2 standard PCI slots. PCI stands for Peripheral Component Interconnect, and it is a bus standard for expansion cards. This PCI slot is designated as 32 bits.

Accelerated Graphics Port Slot: AGP1

Your monitor will attach directly to that video card. This motherboard supports video cards for PCI, but it is also equipped with an Accelerated Graphics Port (AGP). An AGP card will take advantage of AGP technology for improved video efficiency and performance, especially with 3D graphics.

Power Connectors: JATXPWR1

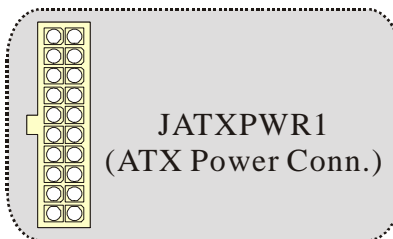

Motherboard Description

Wake On LAN Header: JWOL1

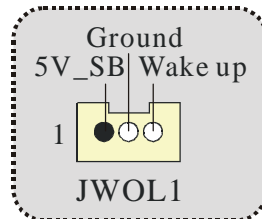

Clear CMOS Jumper: JCMOS1

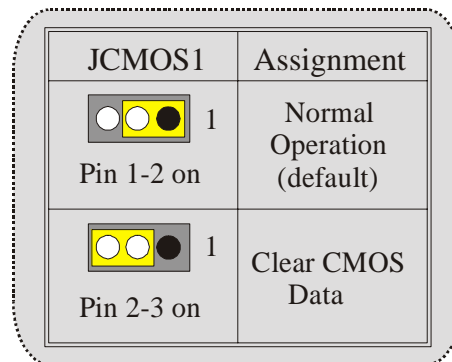

Front USB Header: JUSB3

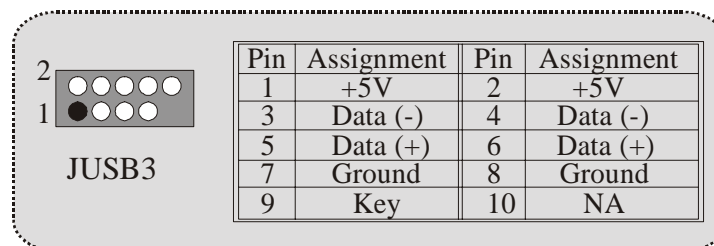

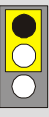
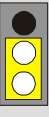

Motherboard Description

5V/ 5VSB Selection for USB: JUSBV1/2/3

JUSBV1/2/3	Assignment
 1 Pin 1-2 on	5V
 1 Pin 2-3 on	5V_SB



CPU Frequency Selection: JCLK1

 1	Close ==> 100 MHz
 1	Open ==> 133 Mhz

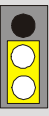
5V/ 5VSB Selection for Keyboard: JKBV1

JKBV1	Assignment
 1 Pin 1-2 on	5V
 1 Pin 2-3 on	5V_SB

AMR Codec Primary/ Secondary Selection: JCODECSEL

JCODECSEL	Assignment
 Pin 1-2 1	On-board Primary Codec (Default).
 Pin 2-3 1	AMR Primary Codec.

Motherboard Description

Case Open Connector: JCI1

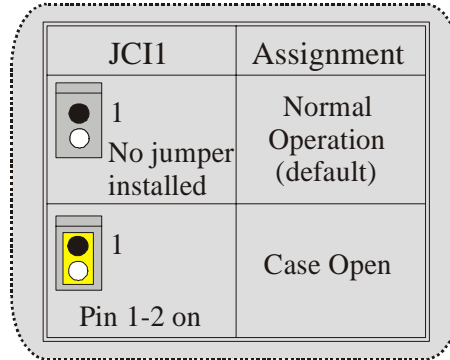

Front Panel Connector: JPANEL1

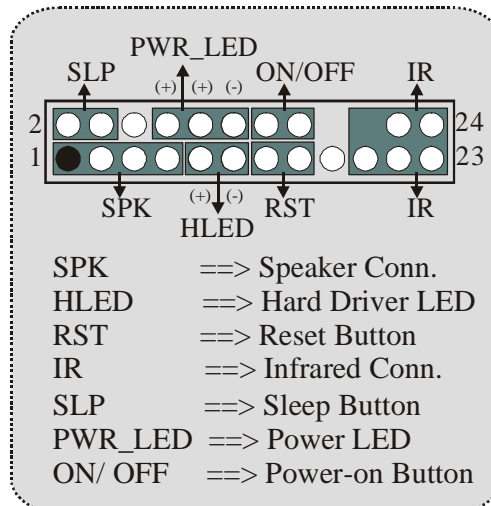

Digital Audio Connector: JSPDIF1 (Optional)

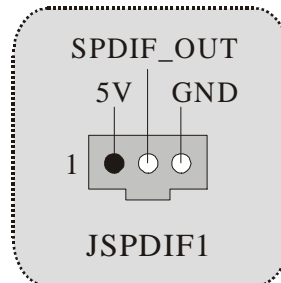

Motherboard Description

Audio Subsystem: JF_AUDIO/ JCDIN1



JF_AUDIO (Front Audio Header) JCDIN1 (CD-ROM Audio-In Header)

The diagram shows a 10-pin header with pins 1 and 2 shaded, and pins 3, 4, 9, and 10 highlighted in yellow.

Pin	Assignment	Pin	Assignment
1	Mic In	2	Ground
3	Mic Power	4	Audio Power
5	RT Line Out	6	RT Line Out
7	Reserved	8	Key
9	LFT Line Out	10	LFT Line Out

<i>Jumper Setting</i>		<i>Configuration</i>
<p>Pin 5 and 6 Pin 9 and 10</p>	<p>Audio line out signals are routed to the back panel audio line out connector.</p>	
<p>No jumpers installed</p>	<p>Audio line out and mic in signals are available for front panel audio connectors.</p>	

Motherboard Description

Game Header: JGAME1

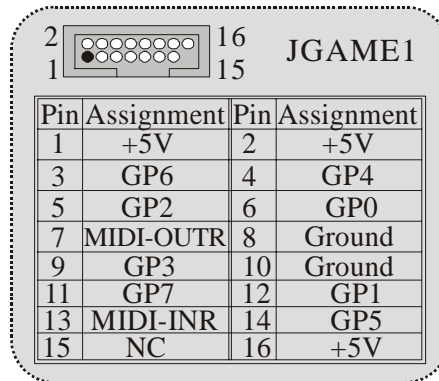

Back Panel Connectors

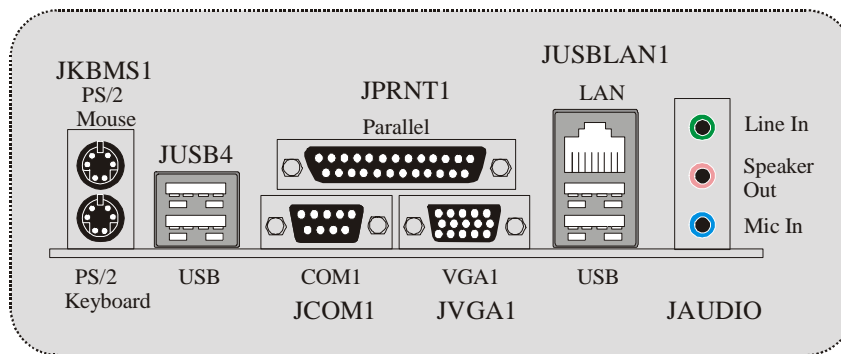

Motherboard Description

Español

Características del M7VIG-D

CPU:

- Soporta procesadores single AMD Socket A para Athlon™ (Thunderbird™) / Athlon XP™/ Duron™.
- Corre a 200/ 266MHz Front Side Bus.

Chipset:

- North Bridge: VIA VT8375 (KM266) Chipset.
- South Bridge: VT8235 Chipset.

Memoria Principal

- Soporta hasta 2 dispositivos DDR.
- Soporta dispositivos 200/ 266MHz (sin ECC).
- Capacidad máxima de memoria de 2GB.

Ranuras

- Una ranura AMR.
- Dos ranuras PCI Bus 32-bit.
- Una ranura AGP.

IDE Onboard

- Soporta discos duros IDE.
- Soporta Ultra 133/ 100/ 66/ 33, modos PIO, modo LBA.

VGA Onboard

- Integrate S3 Graphics 128-bit ProSavage 8 acelerador gráfico.

Audio

- AC97 2.2 compatible.
- PC99 compatible.
- Soporta 2 canales de salida del altavoz.

Periféricos Onboard

- Soporta 360K, 720K, 1.2MB, 1.44MB y 2.88MB tipos de disquette.
- Soporta 1 puerto serie.
- Soporta 1 puerto VGA.
- Soporta 1 puerto paralelo multi-modo. (modos SPP/EPP/ECP)
- Soporta ratón PS/2 y teclado PS/2.
- Soporta 2 puertos traseros y 4 puertos frontales. (Opcional)

BIOS

- AWARD legal Bios.
 - Soporta APM1.2.
-

Motherboard Description

- Soporta ACPI.
- Soporta función USB.

Sistemas Operativos

- Ofrece el más alto funcionamiento para Windows 98, Windows NT, Windows 2000, Windows Me, Windows XP, LINUX y SCO UNIX.

Dimensiones

- Factor de Forma Micro ATX: 22.9cm X 21.3cm (W X L)

Contenido del Paquete

- Cable HDD X 1
- Cable FDD X 1
- Completa Configuración del Driver CD X 1
- Flash Memory Writer para actualización del BIOS X 1
- Cable USB X 2 (Opcional)
- Panel Trasero I/O para Carcasa Micro-ATX X 1 (Opcional)
- Cable SPDIF OUT X1 (Opcional)

Motherboard Description

Disposición del M7VIG-D

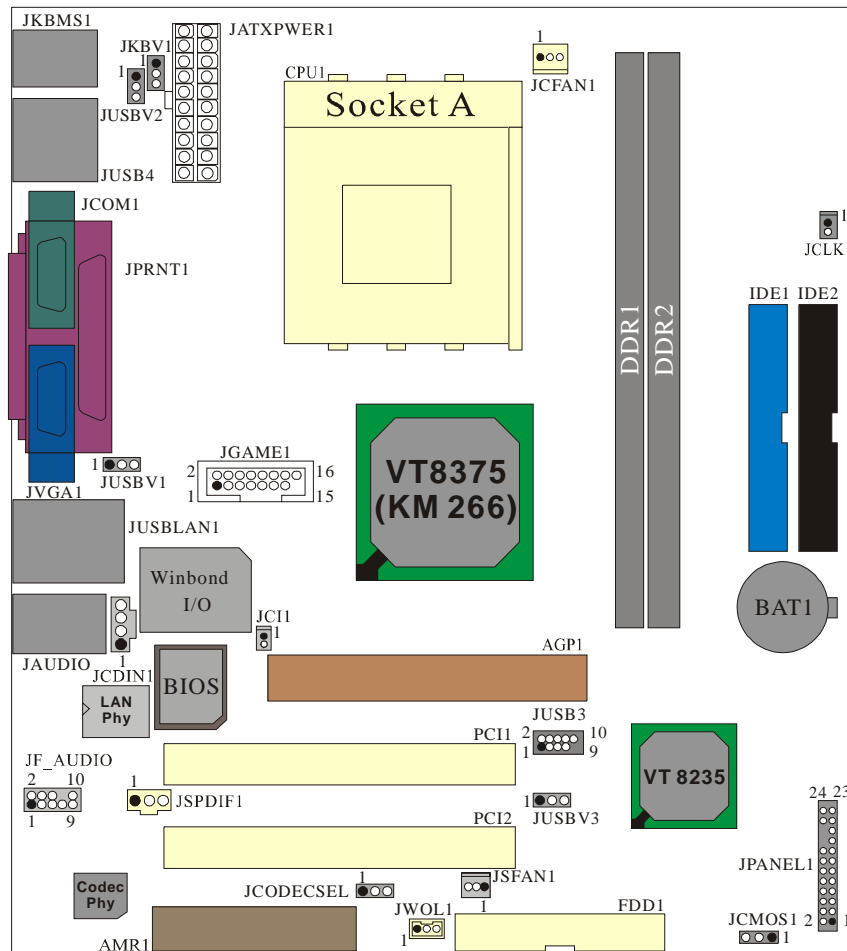

Motherboard Description

Instalación del CPU

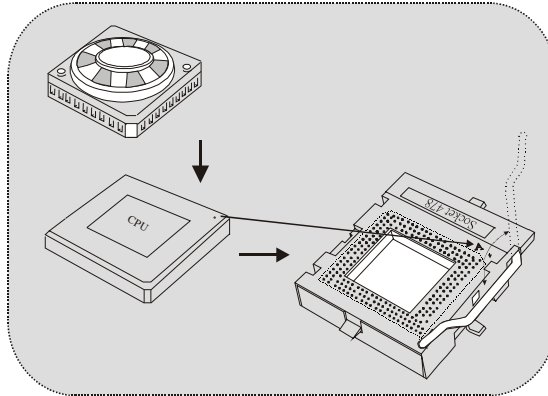

1. Tire de la palanca del lado del zócalo, luego levante la palanca hasta un ángulo de 90 grados.
2. Sitúe el contacto A del zócalo y busque el punto blanco o corte el borde en la CPU. Empareje el contacto A con el punto blanco/ corte del borde, luego inserte la CPU.
3. Presione la palanca para abajo. Ponga el ventilador en la CPU y abróchelo. Luego ponga el puerto de corriente del ventilador en el JCFAN1. Y ya habrá completado su instalación.

CPU/ Cabezales del Sistema de Ventilación: JCFAN1/ JSFAN1

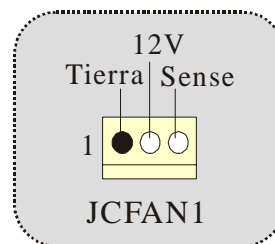
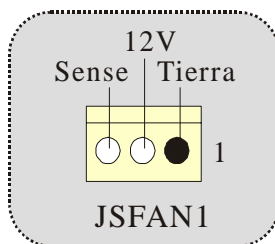

Motherboard Description

Módulos DDR DIMM: DDR1-2

DRAM Tiempo de Acceso: 2.5V Unbuffered DDR 200/ 266 MHz (sin ECC) Tipo requerido.

DRAM Tipo: 64MB/ 128MB/ 256MB/ 512MB/ 1GB Módulo DIMM (184 pin)

Localización del Módulo DIMM	Módulo DDR	Total del Tamaño de Memoria (MB)
DDR 1	64MB/128MB/256MB/512MB/1GB *1	Máximo de 2GB
DDR 2	64MB/128MB/256MB/512MB/1GB *1	

* La lista de arriba para la configuración DRAM es solamente para referencia.

Cómo instalar un Módulo DIMM

1. El zócalo DIMM tiene una lengüeta plástica de seguridad y el módulo de memoria DIMM tiene una muesca asimétrica, así el módulo de memoria DIMM puede caber solamente en la ranura de una sola dirección.

2. Tire la lengüeta hacia afuera. Inserte los módulos de memoria DIMM en el zócalo a los 90 grados, luego empuje hacia abajo verticalmente de modo que encaje en el lugar.

3. Los agujeros de montaje y las lengüetas plásticas deben caber por sobre el borde y sostenga los módulos de memoria DIMM en el lugar.

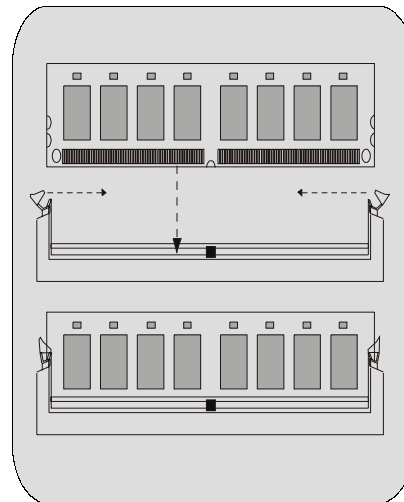

Motherboard Description

Conectores, Cabezales, Puentes y Ranuras

Conectores del Disco Duro: IDE1/ IDE2

La placa madre tiene un controlador de 32-bit PCI IDE que proporciona Modo PIO 0~4, Bus Master, y funcionalidad Ultra DMA 33/ 66/ 100/ 133. Tiene dos conectores HDD IDE1 (primario) y IDE2 (secundario).

El conector IDE puede conectar a un master y un drive esclavo, así puede conectar hasta cuatro discos rígidos. El primer disco duro debe estar siempre conectado al IDE1.

Conector para el Disquete: FDD1

La placa madre proporciona un conector estándar del disquete (FDC) que soporta 360K, 720K, 1.2M, 1.44M y 2.88M tipos de disquete. Éste conector utiliza los cables de cinta proporcionados por el disquete.

Ranura Audio y Módem Riser: AMR1

La especificación AMR es una Arquitectura de Industria Estándar y define una tarjeta elevadora de interface del hardware en el que soporta solamente audio y módem.

Ranura de Interconexión del Componente Periférico: PCI1-2

Ésta placa madre está equipada con 2 ranuras estándar PCI. PCI es la sigla para Interconexión del Componente Periférico, y es un bus estándar para tarjetas de expansión. Ésta ranura PCI está diseñado con 32 bits.

Ranura del Puerto Acelerado para Gráficos: AGP1

Su monitor se fijará directamente a la tarjeta de video. Ésta placa madre soporta tarjetas de video para PCI, pero también está equipada con puerto AGP. La tarjeta AGP tomará ventaja de la tecnología del AGP para el mejoramiento de la eficiencia y funcionamiento del video, especialmente con gráficos 3D.

Conectores de Corriente: JATXPWR1

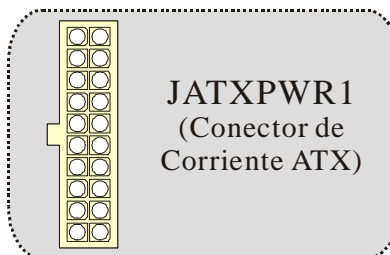

Motherboard Description

Cabezal Wake On LAN: JWOL1

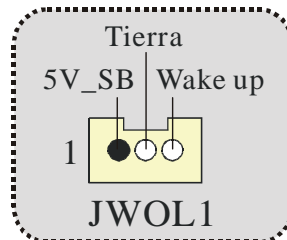

Puente de Borrar CMOS: JCMOS1

JCMOS1	Asignación
 Contacto 1-2 on	Operación Normal (Default)
 Contacto 2-3 on	Borrar Datos CMOS

Cabezal Frontal USB: JUSB3

Contactos	Asignación	Contactos	Asignación
1	+5V	2	+5V
3	Data (-)	4	Data (-)
5	Data (+)	6	Data (+)
7	Tierra	8	Tierra
9	Key	10	NA

Motherboard Description

5V/ 5VSB Selección para USB: JUSBV1/2/3

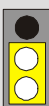
JUSBV1/ 2/ 3	Asignación
 1 Contactos 1-2 on	5V
 1 Contactos 2-3 on	5V_SB

Selección de Frecuencia del CPU: JCLK1

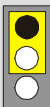
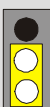

 1	Cerrado ==> 100 MHz
JCLK1	Abierto ==> 133 Mhz

5V/ 5VSB Selección para Teclado: JKBV1



JKBV1	Asignación
 1 Contactos 1-2 on	5V
 1 Contactos 2-3 on	5V_SB

Motherboard Description

AMR Codec de Selección Primario/ Secundario: JCODECSEL

JCODECSEL	Asignación
 Contacto 1-2	Codec Primario Onboard (Default)
 Contacto 2-3	AMR Codec Primario.

Conector Case Open: JCI1

JCI1	Asignación
 Puente sin instalar	Operación Normal (default)
 Contacto 1-2 on	Carcasa Abierta

Conector del Panel Frontal: JPANEL1

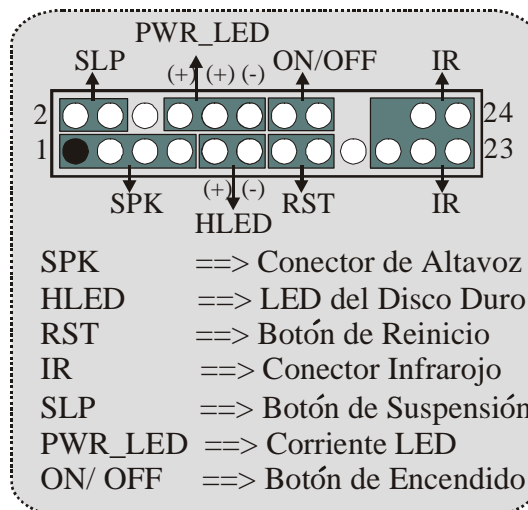

Motherboard Description

Conector Digital de Audio: JSPDIF1 (Optional)

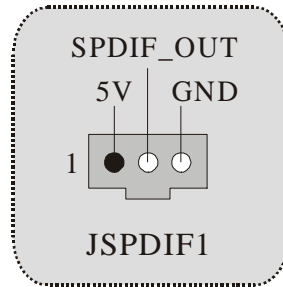

Subsistema de Audio: JF_AUDIO1/ JCDIN1

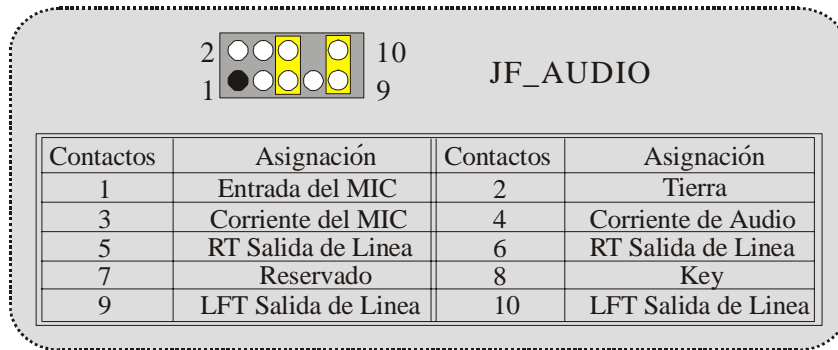

Motherboard Description

Conector del Panel Frontal de Audio/ Jumper Block

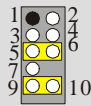
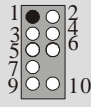
Jumper Setting	Configuración
 <p>1 2 3 4 5 6 7 8 9 10</p> <p>Contacto 5 & 6 Contacto 9 & 10</p>	<p>La señal de salida de línea del Audio encamina al conector de la salida de línea del Audio ubicado en el panel trasero.</p>
 <p>1 2 3 4 5 6 7 8 9 10</p> <p>No jumpers installed</p>	<p>La señal de salida de línea del Audio y la señal del entrada del mic estan disponibles desde el conector de Audio del panel frontal.</p>

Cabezal de Juego: JGAME1

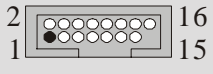

2 16
1 15 **JGAME1**

Contactos	Asignación	Contactos	Asignación
1	+5V	2	+5V
3	GP6	4	GP4
5	GP2	6	GP0
7	MIDI-OUTR	8	GND
9	GP3	10	GND
11	GP7	12	GP1
13	MIDI-INR	14	GP5
15	NC	16	+5V

Conectores del Panel Trasero

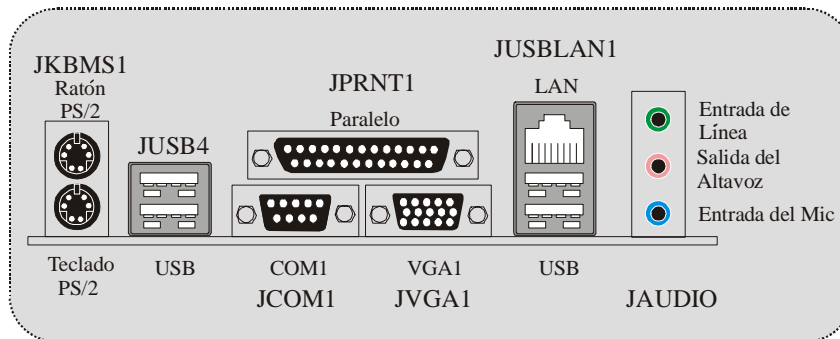

Motherboard Description

Deutsch

Merkmals des M7VIG-D

CPU:

- Unterstützt Athlon™ (Thunderbird™) / Athlon XP™ / Duron™ Prozessoren für einzeln AMD Socket A.
- Mit FSB 200/ 266MHz.

Chipsatz:

- Northbridge: VIA VT8375 (KM266) Chipsatz.
- Southbridge: VT8235 Chipsatz.

Hauptspeicher

- Unterstützung für 2 DDR Geräte.
- Unterstützung für 200/266MHz(ohne ECC) DDR Geräte.
- Die maximale Speichergröße ist 2 GB.

Slots

- Ein AMR-Slot.
- Zwei 32-Bit PCI-Bus-Slots.
- Ein AGP-Sot.

Onboard-IDE

- Unterstützung für vier IDE Diskettenlaufwerke.
- Unterstützung für Ultra 133/ 100/ 66/ 33, PIO Modus und LBA Modus.

Onboard-VGA

- Mit integriertem 128-Bit S3 ProSavage 8 Grafikken.

Audio

- AC97 2.2 kompatibel.
- Entspricht den Anforderungen von PC 99P.
- Unterstützung für 2-Kanal.

Onboard-Peripheriegeräte

- 1 Floppy-Port mit Unterstützung für 2 Diskettenlaufwerke.(360KB, 720KB, 1.2MB, 1.44MB und 2.88MB).
- 1 serielle Schnittstelle.
- 1 VGA-Port.
- 1 parallele Schnittstelle mit Unterstützung für SPP/EPP/ECP-Modus.
- Unterstützung für PS/2-Maus und PS/2 -Tastatur..
- Unterstützung für 4 USB2.0-Ports. (optional, hinten*2/vorn*4)

BIOS

- Unterstützung für AWARD legal Bios.
 - Unterstützung für APM1.2..
-

Motherboard Description

- Unterstützung für ACPI.
- Unterstützung für USB Function.

Betriebssysteme

- Unterstützung für die am meisten verbreiteten Betriebssysteme wie Windows 98, Windows NT, Windows 2000, Windows ME, Windows XP, LINUX and SCO UNIX

Abmessungen

- Micro ATX Form-Factor:: 22.9cm X 21.3cm (W X L)

Verpackungsinhalt

- HDD Kable X 1
- FDD Kable X 1
- Treiber CD für Installation X 1
- Flash-Speicher-Writer für BIOS-Update X 1
- USB Kable X 2 (optional)
- I/O-Rückwand für ATX Gehäuse X 1 (optional)
- SPDIF-Ausgang-Kable X1 (optional)

Motherboard Description

Layout des M7VIG-D

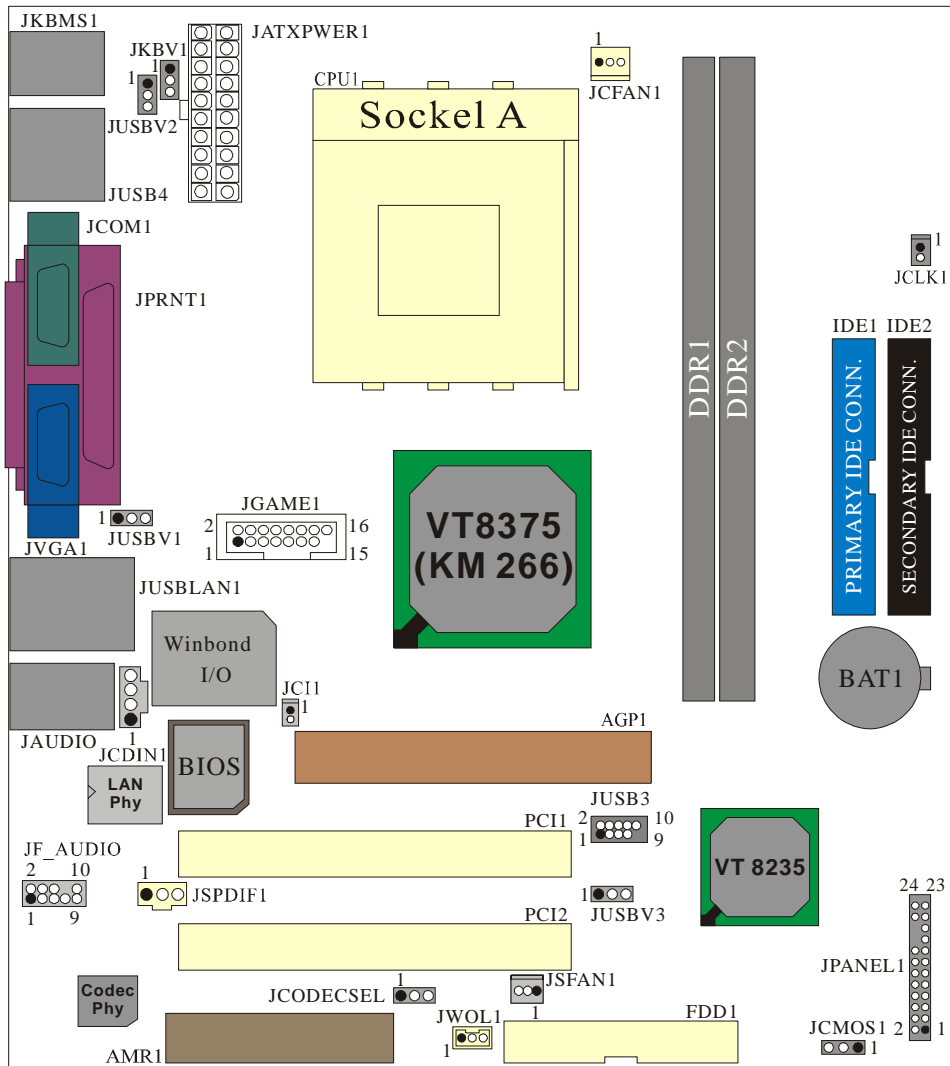

Motherboard Description

Installation der CPU

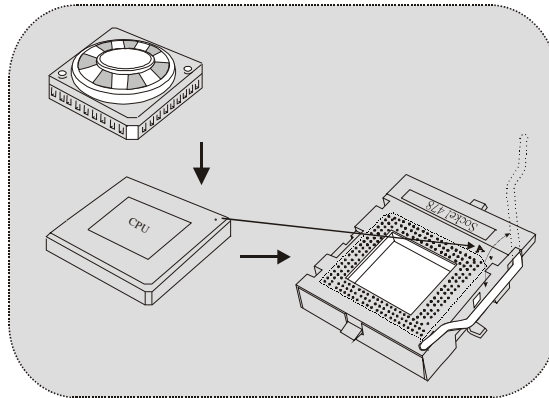

1. Ziehen Sie den Hebel seitwärts von der Sockel und neigen Sie ihn um 90-Grad nach oben.
2. Suchen Sie Pin A im Sockel und den weißen Punkt oder die Abschnittkante in der CPU. Passen Sie Pin A mit dem weißen Punkt/der Abschnittkante zusammen und legen Sie danach die CPU ein.
3. Drücken Sie den Hebel nach unten. Befestigen Sie danach den Lüfter auf die CPU und schließen Sie die Stromschnittstelle des Lüfters an JCFAN1 an und beenden Sie die Installation.

CPU/ System Fan Headers: JCFAN1/ JSFAN1

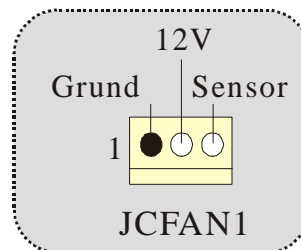
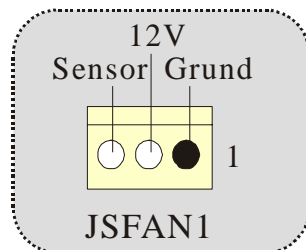

Motherboard Description

DDR-DIMM-Modules: DDR1-2

DRAM Zugriffszeit: 2.5V unbuffered DDR 200/266MHz (ohne ECC) Typen required.

DRAM Typen: 64MB/ 128MB/ 256MB/ 512MB/ 1GB DIMM-Module (184-Pin)

DIMM-Sockel Standort	DDR-Module	Speichergröße (MB)
DDR 1	64MB/128MB/256MB/512MB/1GB *1	maximal 2GB
DDR 2	64MB/128MB/256MB/512MB/1GB *1	

* Die obere Liste für DRAM-Konfiguration wird als Referenz gezeigt.

Installation von DIMM-Modulen

1. DDR DIMM hat nur eine Passkerbe in der Mitte des Moduls. Das Modul passt nur in einer Richtung.
2. Ziehen Sie die Plastikklammer an beiden Enden der DIMM-Steckplätze aus, dann setzen Sie das DIMM-Modul im 90-Grad-Winkel in den DIMM-Steckplatz und drücken es nach unten.
3. Schließen Sie die Plastikklammer, um das DiMM-Modul zu verriegeln.

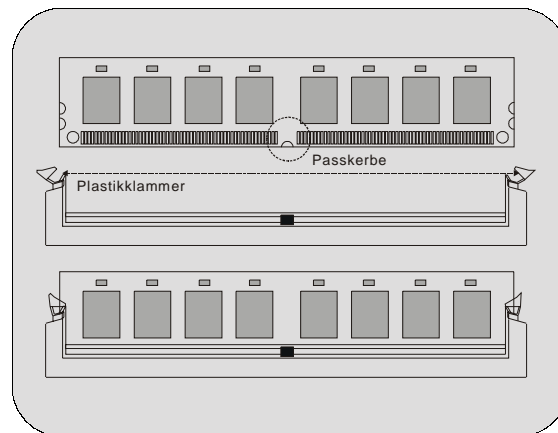

Motherboard Description

Jumpers, Headers, Connectors & Slots

Festplattenanschlüsse: IDE1 und IDE2

Das Mainboard hat einen 32-Bit Enhanced PCI IDE-Controller, der die Modi PIO0-4, Bus Master sowie die Ultra DMA/33/66/100/133- Funktion zur Verfügung stellt. Dieser ist mit zwei HDD-Anschlüssen versehen IDE1 (primär) und IDE2 (sekundär).

Die IDE-Anschlüsse können eine Master- und eine Slave-Festplatte verbinden, so dass bis zu 4 Festplatten angeschlossen werden können. Die erste Festplatte sollte immer an IDE1 angeschlossen werden.

Diskettenanschluss: FDD1

Das Motherboard enthält einen standardmäßigen Diskettenanschluss, der 360K-, 720K-, 1.2M-, 1.44M- und 2.88M-Disketten unterstützt. Dieser Anschluss unterstützt die mitgelieferte Bandkabel des Diskettenlaufwerks.

Audio Modem Riser: AMR1

(unterstützt nur Slave-Karte)

Die AMR-Spezifikation ist eine "offene Industrie-Standard-Architektur" und AMR wird als ein skalierbares Riser-Karte-Interface von Hardware definiert, das nur Modem und Soundfunktion unterstützt.

Peripheral Component Interconnect Slots: PCI1-2

Dieses Motherboard ist mit 2 standardmäßigen PCI-Slots ausgestattet. PCI steht für Peripheral Component Interconnect und bezieht sich auf einem Busstandard für Erweiterungskarten, der den älteren ISA-Busstandard in den meisten Schnittstellen ersetzt hat. Dieser PCI-Slot ist für 32 bits vorgesehen.

Accelerated Graphics Port Slot: AGP1

Ihr Monitor wird direkt an die Grafikkarte angeschlossen. Dieses Motherboard unterstützt Grafikkarten für PCI-Slots, aber es ist auch mit einem Accelerated Graphics Port ausgestattet. AGP-Karten verwenden die AGP-Technologie, um die Wirksamkeit und Leistung von Videosignalen zu verbessern, besonders wenn es sich um 3D-Grafiken handelt.

Stromversorgungsanschluss: JATXPWR1



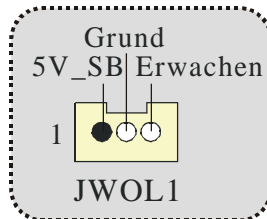

Motherboard Description

Wake On LAN Header: JWOL1



Clear CMOS Jumper: JCMOS1

JCMOS1	Beschreibung
 Pin 1-2 geschlossen	Normale Operation (Default)
 Pin 2-3 geschlossen	CMOS-Daten löschen

Front USB Header: JUSB3

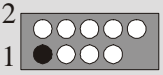



JUSB3

Pin	Beschreibung	Pin	Beschreibung
1	+5V	2	+5V
3	Data (-)	4	Data (-)
5	Data (+)	6	Data (+)
7	Grund	8	Grund
9	Key	10	NA

Motherboard Description



5V/ 5V_SB Auswahl für USB: JUSBV1/2/3

JUSBV1/2/3	Beschreibung
 1 Pin 1-2 geschlossen	5V
 1 Pin 2-3 geschlossen	5V_SB

CPU Frequenz Auswahl: JCLK1



 1 geschlossen ==> 100 MHz
JCLK1 geöffnet ==> 133 Mhz

5V/ 5VSB Auswahl für Tastatur: JKBV1



JKBV1	Beschreibung
 1 Pin 1-2 geschlossen	5V
 1 Pin 2-3 geschlossen	5V_SB

Motherboard Description

Auswahl für Primär/ Sekundär AMR Codec: JCODECSEL

J_CODECSEL	Beschreibung
 Pin 1-2 geschlossen 1	Primär Onboard Codec(Default)
 Pin 2-3 geschlossen 1	Primär AMRCodec

Anschluss für Gehäuse-Öffnen: JCI1: JCI1

JCI1	Beschreibung
 Kein Jumper geschlossen 1	Normale Operation (Default)
 Pin 1-2 geschlossen 1	Gehäuse öffnen

Front Panel Connector: JPANEL1

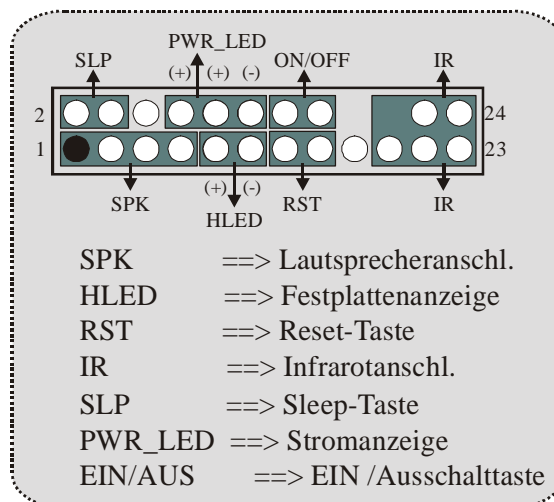

Motherboard Description

Digital-Audio-Anschluss: JSPDIF1 (optional)

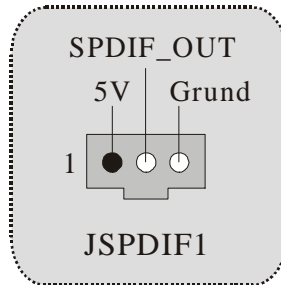

Audio Subsystem: JF_AUDIO/ JCDIN1

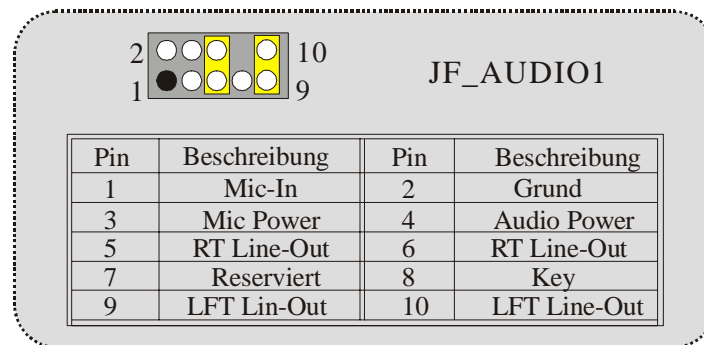

Motherboard Description

Audio-Anschlüsse für die Vorderseite/Jumper-Block

Jumper-Einstellen		Konfiguration
 <p>Pin 5 und 6 Pin 9 und 10</p>		Audio-Ausgang-Signals werden zu der Audio-Ausgang-Anschluss an der Rückwand geleitet.
 <p>Kein Jumper installieren</p>		Audio-Ausgang- und Mic-In-Signals sind verfügbar für Audio-Anschlüsse an der Vorderseite.

Game Header: JGAME1

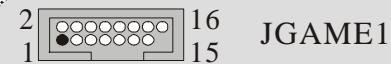

Pin	Beschreibung	Pin	Beschreibung
1	+5V	2	+5V
3	GP6	4	GP4
5	GP2	6	GP0
7	MIDI-OUTR	8	GND
9	GP3	10	GND
11	GP7	12	GP1
13	MIDI-INR	14	GP5
15	NC	16	+5V

Motherboard Description

Anschlüsse auf der Rückseite

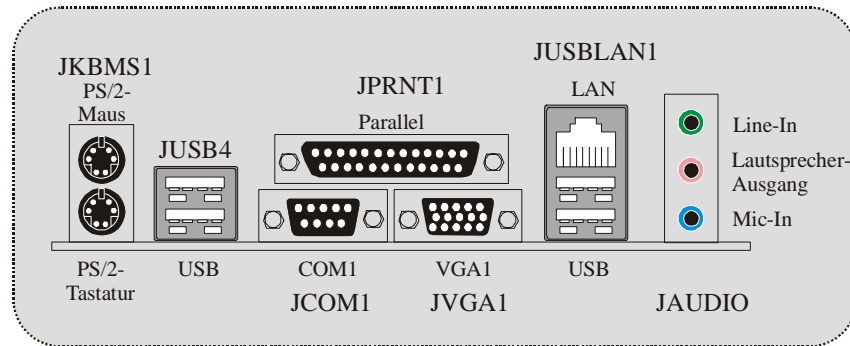

Motherboard Description

WarpSpeeder



Introduction

[WarpSpeeder™], a new powerful control utility, features three user-friendly functions including Overclock Manager, Overvoltage Manager, and Hardware Monitor.

With the Overclock Manager, users can easily adjust the frequency they prefer or they can get the best CPU performance with just one click. The Overvoltage Manager, on the other hand, helps to power up CPU core voltage and Memory voltage. The cool Hardware Monitor smartly indicates the temperatures, voltage and CPU fan speed as well as the chipset information. Also, in the About panel, you can get detail descriptions about BIOS model and chipsets. In addition, the frequency status of CPU, memory, AGP and PCI along with the CPU speed are synchronically shown on our main panel.

Moreover, to protect users' computer systems if the setting is not appropriate when testing and results in system fail or hang, [WarpSpeeder™] technology assures the system stability by automatically rebooting the computer and then restart to a speed that is either the original system speed or a suitable one.

System Requirement

OS Support: Windows 98 SE, Windows Me, Windows 2000, Windows XP

DirectX: DirectX 8.1 or above. (The Windows XP operating system includes DirectX 8.1. If you use Windows XP, you do not need to install DirectX 8.1.)

Motherboard Description

Installation

1. Execute the setup execution file, and then the following dialog will pop up. Please click “Next” button and follow the default procedure to install.

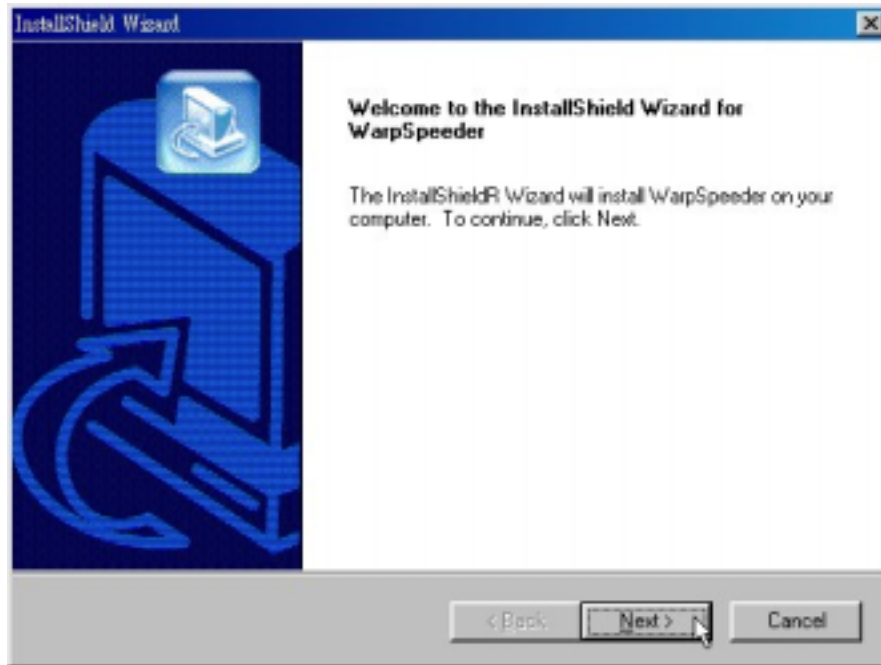

2. When you see the following dialog in setup procedure, it means setup is completed. If the “Launch the WarpSpeeder Tray Utility” checkbox is checked, the Tray Icon utility and [WarpSpeeder™] utility will be automatically and immediately launched after you click “Finish” button.

Motherboard Description

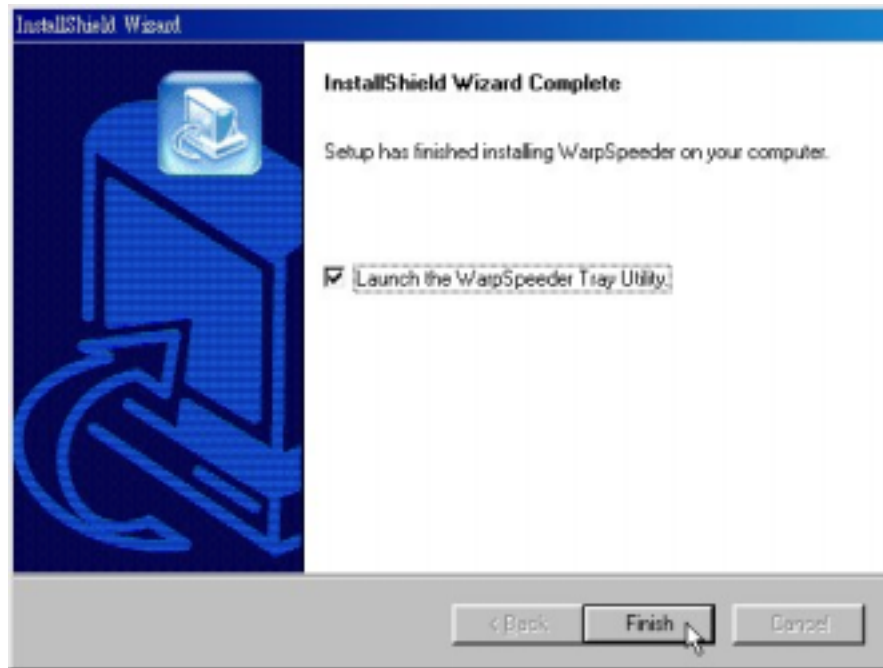

Usage

The following figures are just only for reference, the screen printed in this user manual will change according to your motherboard on hand.

[WarpSpeeder™] includes 1 tray icon and 5 panels:

1. Tray Icon:

Whenever the Tray Icon utility is launched, it will display a little tray icon on the right side of Windows Taskbar.

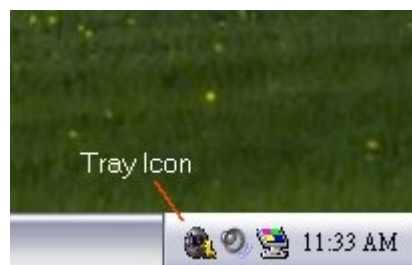

Motherboard Description

This utility is responsible for conveniently invoking [WarpSpeeder™] Utility. You can use the mouse by clicking the left button in order to invoke [WarpSpeeder™] directly from the little tray icon or you can right-click the little tray icon to pop up a popup menu as following figure. The “Launch Utility” item in the popup menu has the same function as mouse left-click on tray icon and “Exit” item will close Tray Icon utility if selected.

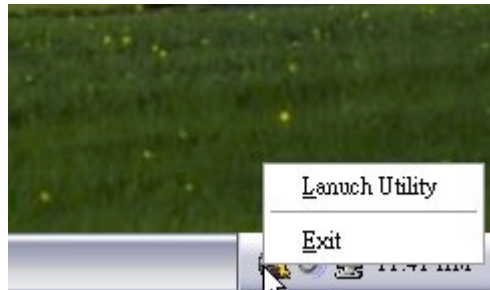

2. Main Panel

If you click the tray icon, [WarpSpeeder™] utility will be invoked. Please refer to the following figure; the utility's first window you will see is Main Panel.

Main Panel contains features as follows:

- a. Display the CPU Speed, CPU external clock, Memory clock, AGP clock, and PCI clock information.
- b. Contains About, Voltage, Overclock, and Hardware Monitor Buttons for invoking respective panels.
- c. With a user-friendly Status Animation, it can represent 3 overclock percentage stages:

Duck walking => overclock percentage from 100% ~ 110 %

Duck running => overclock percentage from 110% ~ 120%

Duck burning => overclock percentage from 120% ~ above

Motherboard Description

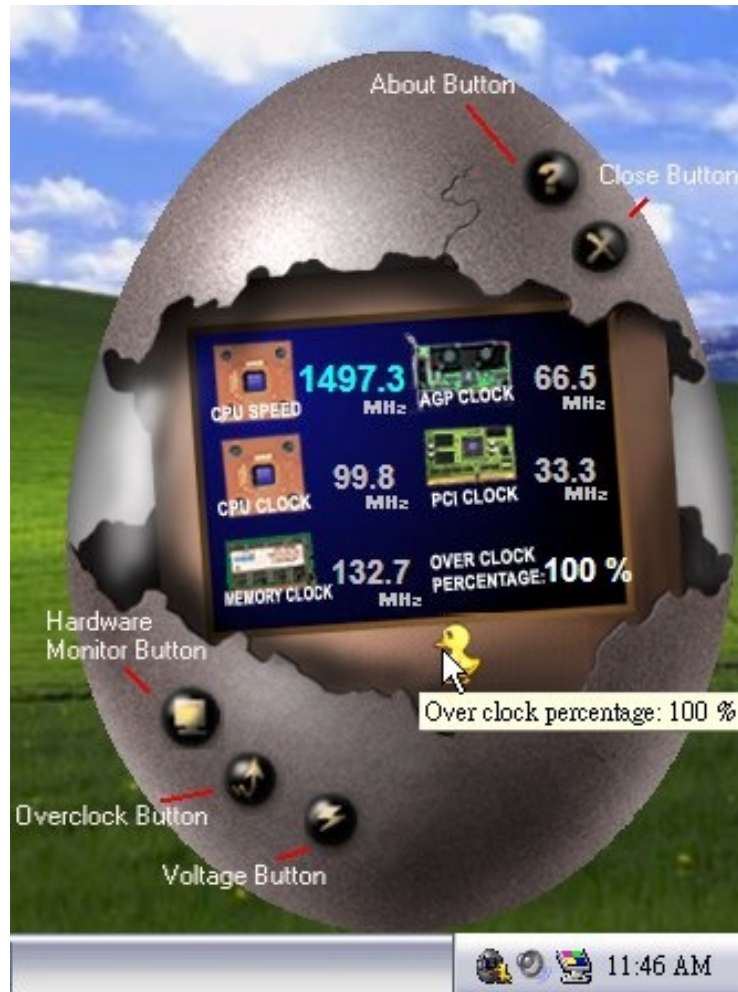

3. Voltage Panel

Click the Voltage button in Main Panel, the button will be highlighted and the Voltage Panel will slide out to up as the following figure.

In this panel, you can decide to increase CPU core voltage and Memory voltage or not. The default setting is "No". If you want to get the best performance of overclocking, we recommend you click the option "Yes".

Motherboard Description



4. Overclock Panel

Click the Overclock button in Main Panel, the button will be highlighted and the Overclock Panel will slide out to left as the following figure.

Motherboard Description



Overclock Panel contains the these features:

- a. “-3MHz button”, “-1MHz button”, “+1MHz button”, and “+3MHz button”: provide user the ability to do real-time overclock adjustment.

Warning: Manually overclock is potentially dangerous, especially when the overclocking percentage is over 110 %. We strongly recommend you verify every speed you overclock by click the Verify button. Or, you can just click Auto overclock button and let [WarpSpeeder™] automatically gets the best result for you.

- b. “Recovery Dialog button”: Pop up the following dialog. Let user select a restoring way if system need to do a fail-safe reboot.

Motherboard Description

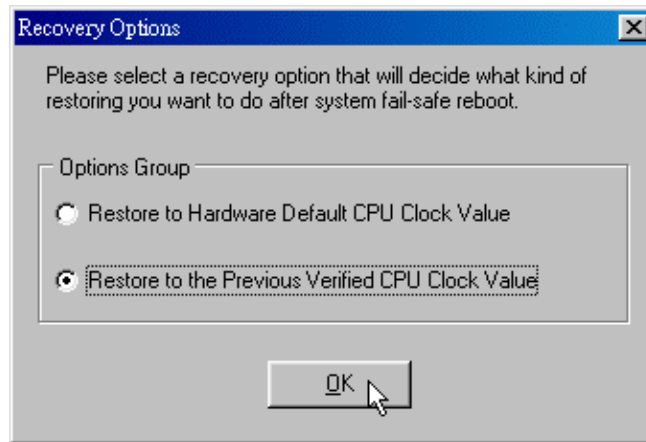

- d. "Auto-overclock button": User can click this button and [WarpSpeeder™] will set the best and stable performance and frequency automatically. [WarpSpeeder™] utility will execute a series of testing until system fail. Then system will do fail-safe reboot by using Watchdog function. After reboot, the [WarpSpeeder™] utility will restore to the hardware default setting or load the verified best and stable frequency according to the Recovery Dialog's setting.
- e. "Verify button": User can click this button and [WarpSpeeder™] will proceed a testing for current frequency. If the testing is ok, then the current frequency will be saved into system registry. If the testing fail, system will do a fail-safe rebooting. After reboot, the [WarpSpeeder™] utility will restore to the hardware default setting or load the verified best and stable frequency according to the Recovery Dialog's setting.

Note: Because the testing programs, invoked in Auto-overclock and Verify, include DirectDraw, Direct3D and DirectShow tests, the DirectX 8.1 or newer runtime library is required. And please make sure your display card's color depth is High color (16 bit) or True color (24/32 bit) that is required for Direct3D rendering.

Motherboard Description

5. Hardware Monitor Panel

Click the Hardware Monitor button in Main Panel, the button will be highlighted and the Hardware Monitor panel will slide out to left as the following figure.

In this panel, you can get the real-time status information of your system. The information will be refreshed every 1 second.



6. About Panel

Click the About button in Main Panel, the button will be highlighted and the About Panel will slide out to up as the following figure.

In this panel, you can get model name and detail information in hints of all the chipset that are related to overclocking. You can also get the mainboard's BIOS model and the Version number of [WarpSpeeder™] utility.

Motherboard Description

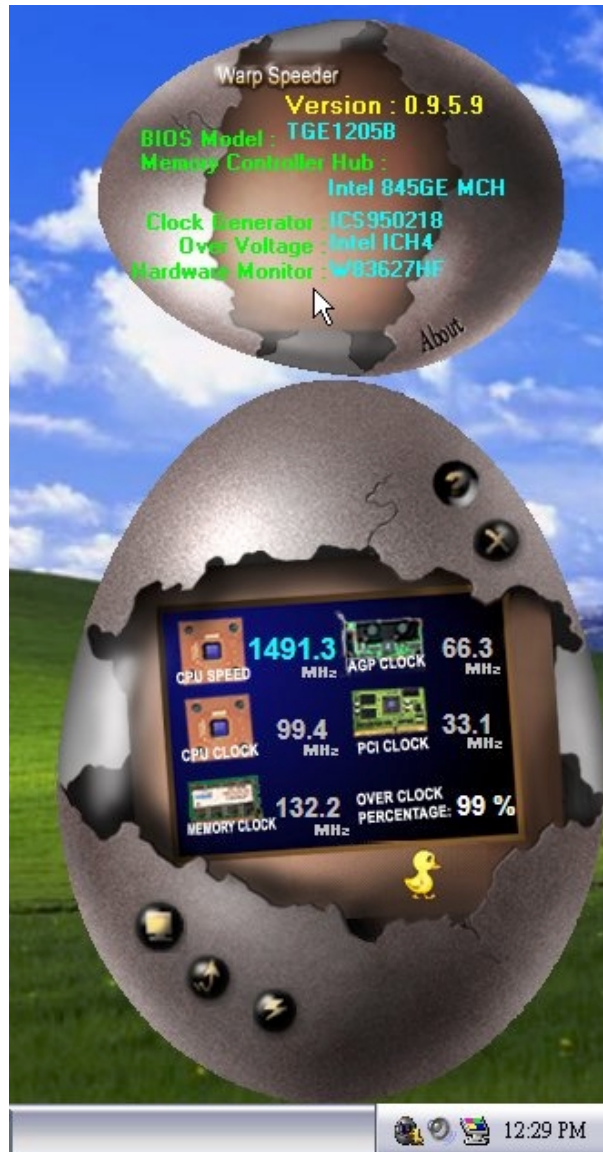

Note: Because the overclock, overvoltage, and hardware monitor features are controlled by several separate chipset, [WarpSpeeder™] divide these features to separate panels. If one chipset is not on board, the correlative button in Main panel will be disabled, but will not interfere other panels' functions. This property can make [WarpSpeeder™] utility more robust.

Trouble Shooting

PROBABLE	SOLUTION
No power to the system at all Power light don't illuminate, fan inside power supply does not turn on. Indicator light on keyboard does not turn on	<ul style="list-style-type: none"> * Make sure power cable is securely plugged in * Replace cable * Contact technical support
PROBABLE	SOLUTION
System inoperative. Keyboard lights are on, power indicator lights are lit, hard drive is spinning.	<ul style="list-style-type: none"> * Using even pressure on both ends of the DIMM, press down firmly until the module snaps into place.
PROBABLE	SOLUTION
System does not boot from hard disk drive, can be booted from CD-ROM drive.	<ul style="list-style-type: none"> * Check cable running from disk to disk controller board. Make sure both ends are securely plugged in; check the drive type in the standard CMOS setup. * Backing up the hard drive is extremely important. All hard disks are capable of breaking down at any time.
PROBABLE	SOLUTION
System only boots from CD-ROM. Hard disk can be read and applications can be used but booting from hard disk is impossible.	<ul style="list-style-type: none"> * Back up data and applications files. Reformat the hard drive. Re-install applications and data using backup disks.
PROBABLE	SOLUTION
Screen message says "Invalid Configuration" or "CMOS Failure."	<ul style="list-style-type: none"> * Review system's equipment . Make sure correct information is in setup.
PROBABLE	SOLUTION
Cannot boot system after installing second hard drive.	<ul style="list-style-type: none"> * Set master/slave jumpers correctly. * Run SETUP program and select correct drive types. Call drive manufacturers for compatibility with other drives.

Solución de Problemas

CAUSA PROBABLE	SOLUCIÓN
No hay corriente en el sistema. La luz de corriente no ilumina, ventilador dentro de la fuente de alimentación apagada. Indicador de luz del teclado apagado.	<ul style="list-style-type: none"> * Asegúrese que el cable de transmisión esté seguramente enchufado. * Reemplace el cable. * Contacte ayuda técnica.
CAUSA PROBABLE	SOLUCIÓN
Sistema inoperativo. Luz del teclado encendido, luz de indicador de corriente iluminado, disco rígido está girando.	<ul style="list-style-type: none"> * Presione los dos extremos del DIMM, presione para abajo firmemente hasta que el módulo encaje en el lugar.
CAUSA PROBABLE	SOLUCIÓN
Sistema no arranca desde el disco rígido, puede ser arrancado desde el CD-ROM drive.	<ul style="list-style-type: none"> * Controle el cable de ejecución desde el disco hasta el disco del controlador. Asegúrese de que ambos lados estén enchufados con seguridad; controle el tipo de disco en la configuración estándar CMOS. * Copiando el disco rígido es extremadamente importante. Todos los discos rígidos son capaces de dañarse en cualquier momento.
CAUSA PROBABLE	SOLUCIÓN
Sistema solamente arranca desde el CD-ROM. Disco rígido puede leer y aplicaciones pueden ser usados pero el arranque desde el disco rígido es imposible.	<ul style="list-style-type: none"> * Copie datos y documentos de aplicación. Vuelva a formatear el disco rígido. Vuelva a instalar las aplicaciones y datos usando el disco de copiado.
CAUSA PROBABLE	SOLUCIÓN
Mensaje de pantalla "Invalid Configuration" o "CMOS Failure."	<ul style="list-style-type: none"> * Revise el equipo del sistema. Asegúrese de que la información configurada sea correcta.
CAUSA PROBABLE	SOLUCIÓN
No puede arrancar después de instalar el segundo disco rígido.	<ul style="list-style-type: none"> * Fije correctamente el puente master/esclavo. * Ejecute el programa SETUP y seleccione el tipo de disco correcto. Llame a una manufacturación del disco para compatibilidad con otros discos.

Problemlösung

MÖGLICHE URSACHE	LÖSUNG
Das System hat keine Spannungsversorgung. Die Stromanzeige leuchtet nicht, der Lüfter im Inneren der Stromversorgung wird nicht eingeschaltet. Tastaturleuchten sind nicht an.	<ul style="list-style-type: none"> * Versichern Sie sich, dass das Stromkabel richtig angebracht ist * Ersetzen Sie das Stromkabel * Wenden Sie sich an Ihre Kundendienststelle
MÖGLICHE URSACHE	LÖSUNG
Das System funktioniert nicht. Die Tastaturleuchten sind an, die Stromanzeige leuchtet, die Festplatte dreht sich.	<ul style="list-style-type: none"> * Drücken Sie das DIMM-Modul bei gleichem Druck an beide Seiten, bis es einrastet.
MÖGLICHE URSACHE	LÖSUNG
Das System wird von der Festplatte nicht hochgefahren, vom CD-ROM-Treiber aber ja.	<ul style="list-style-type: none"> * Überprüfen Sie das Kabel zwischen Festplatte und Festplatten-Controller. Versichern Sie sich, dass beide Enden richtig angebracht sind; überprüfen Sie den Laufwerktyp in der standardmäßigen CMOS-Einrichtung. * Ein Backup der Festplatte ist sehr wichtig. Alle Festplatten können irgendwann beschädigt werden.
MÖGLICHE URSACHE	LÖSUNG
Das System wird nur von der CD-ROM hochgefahren. Die Festplatte wird gelesen und die Anwendungen sind funktionsfähig, aber es ist nicht möglich, das System von der Festplatte zu starten.	<ul style="list-style-type: none"> * Machen Sie eine Sicherungskopie von allen Daten und Anwendungsdateien. Formatieren Sie die Festplatte und reinstallieren Sie die Anwendungen und Daten mit Hilfe von Backup-Disks.
MÖGLICHE URSACHE	LÖSUNG
Auf dem Bildschirm erscheint die Meldung "Ungültige Konfiguration" oder "CMOS Fehler."	<ul style="list-style-type: none"> * Überprüfen Sie die Systemkomponenten und versichern Sie sich, dass diese richtig eingerichtet sind.
MÖGLICHE URSACHE	LÖSUNG
Das System kann nach der Installation einer zweiten Festplatte nicht hochgefahren werden.	<ul style="list-style-type: none"> * Setzen Sie die Master/Slave-Jumper richtig ein. * Führen Sie das SETUP-Programm aus und wählen Sie die richtigen Laufwerktypen. Wenden Sie sich an den Laufwerkhersteller, um die Kompatibilität mit anderen Laufwerken zu überprüfen.



03/14/2003

