

# **M7TDR**

---

## **Federal Communications Commission (F.C.C.) Statement**

This device complies with Part 15 of the FCC Rules. Operation of this device is subject to the following two conditions: (1) this device may not cause harmful interference, and (2) this device must accept any interference received, including interference that may cause undesired operation.

Accessories: This device has been tested and found to comply with the limits of a Class B digital device, the accessories associated with this equipment are as follows:

1. Shielded serial cable. (Can be obtained from multiple retail outlets)
2. Shielded printer cable. (Can be obtained from multiple retail outlets)
3. Shielded video cable. (Can be obtained from multiple retail outlets)
4. Shielded power cord. (Provided by manufacturer)

These accessories are required to ensure compliance with FCC Rules. It is the responsibility of the user to provide and use these accessories properly.

This equipment has been tested and found to comply with the limits of a Class B digital device, pursuant to Part 15 of the FCC Rules. These limits are designed to provide reasonable protection against harmful interference in a residential installation. This equipment generates, uses and can radiate radio frequency energy and, if not installed and used in accordance with the instructions, may cause harmful interference to radio communications. There is no guarantee that interference will not occur in a particular installation. If this equipment does cause harmful interference to radio or television reception, which can be determined by turning the equipment off and on, you are encouraged to try to correct the interference by one or more of the following measures:

1. Reorient / relocate the receiving antenna.
2. Increase the separation between the equipment and receiver.
3. Connect the equipment into an outlet on a circuit different from that to which the receiver is connected.
4. Consult the dealer or an experienced radio/TV technician for help.

Caution: Changes or modifications not expressly approved by the manufacturer could void the user's authority to operate the equipment.

---

---

## **Disclaimer**

The vendor makes no representations or warranties with respect to the contents here of and specially disclaims any implied warranties of merchantability or fitness for any purpose. Further the vendor reserves the right to revise this publication and to make changes to the contents here of without obligation to notify any party beforehand.

Duplication of this publication, in part or in whole, is not allowed without first obtaining the vendor's approval in writing.

## **Trademarks and Remarks**

MS-DOS, Windows, Windows NT, Windows 9X, Windows ME and Windows 2000 are products of Microsoft Corp, with its ownership of trademark, and are distributed by the vendor under a license agreement.

All trademarks used in this manual are the property of their respective owners.

Copyright© 2001

All Rights Reserved

## **Canadian D.O.C. Statement**

This digital apparatus does not exceed the Class B limits for radio noise emissions from digital apparatus as set out in the radio interference regulations of the Canadian Department of Communications.

Cet appareil numérique n'émet pas de bruits radioélectriques dépassant les limites appliquées aux appareils numériques de Class B prescrits dans le règlement du brouillage radioélectrique edict par le minister Des Communications du Canada.

---

## **Contents**

---

|  |            |
|--|------------|
| <b>Introduction .....</b>                                | <b>1-1</b> |
| <b>1. Motherboard Description .....</b>                  | <b>1-2</b> |
| 1.1 Features .....                                       | 1-2        |
| 1.1.1 Hardware.....                                      | 1-2        |
| 1.1.2 BIOS .....   | 1-6        |
| 1.1.3 Software.....                                      | 1-6        |
| 1.1.4 Accessories .....                                  | 1-6        |
| 1.2 Motherboard Installation.....                        | 1-7        |
| 1.2.1 System Block Diagram.....                          | 1-7        |
| 1.2.2 Layout of Motherboard.....                         | 1-8        |
| 1.2.3 Quick Reference.....                               | 1-9        |
| 1.3 CPU Installation.....                                | 1-10       |
| 1.3.1 CPU Installation Procedure: Socket 423 .....       | 1-10       |
| 1.3.2 CPU Fan Header: JCFAN1 .....                       | 1-11       |
| 1.3.3 System Fan Header: JSFAN1 .....                    | 1-11       |
| 1.4 RAM Module Installation .....                        | 1-12       |
| 1.4.1 DIMM.....  | 1-12       |
| 1.4.2 How to install a DIMM Module .....                 | 1-14       |
| 1.5 Slots .....  | 1-15       |
| 1.5.1 AGP (Accelerated Graphics Port) Slot.....          | 1-16       |
| 1.5.2 CNR (Communication Network Riser) Slot.....        | 1-16       |
| 1.5.3 PCI (Peripheral Component Interconnect) Slots..... | 1-16       |
| 1.6 Connectors, Headers & Jumpers .....                  | 1-17       |

## Contents

---

|   |            |
|---|------------|
| 1.6.1 Front Panel Connector: JPANEL1 .....              | 1-18       |
| 1.6.2 ATX 20-pin Power Connector: JATXPWR1.....         | 1-20       |
| 1.6.3 ATX 12V Power Connector: JATXPWR2 .....           | 1-20       |
| 1.6.4 AUX Power Connector: JAUXPWR1.....                | 1-20       |
| 1.6.5 Hard Disk Connectors: IDE1/IDE2.....              | 1-21       |
| 1.6.6 Floppy Disk Connector: FDD1.....                  | 1-21       |
| 1.6.7 Wake On LAN Header: JWOL1 .....                   | 1-21       |
| 1.6.8 Clear CMOS Jumper: JCMOS1 .....                   | 1-22       |
| 1.6.9 Front USB Headers: JUSBF1(Optional).....          | 1-22       |
| 1.7 Peripheral Port.....                                | 1-23       |
| 1.7.1 PS/2 Mouse / Keyboard Connector: JKBMS1 .....     | 1-23       |
| 1.7.2 USB Connector: JUSB1 .....                        | 1-24       |
| 1.7.3 Serial and Parallel Interface Ports.....          | 1-25       |
| 1.7.3.1 The Serial Interface: JCOM1/ JCOM2 .....        | 1-25       |
| 1.7.3.2 Parallel Interface Port: JPRNT1 .....           | 1-27       |
| 1.7.4 Game (Joystick/MIDI) Port Connector: JGAME1 ..... | 1-28       |
| 1.7.5 Audio Port Connectors: JSPKR1/JLIN1/JMIC1.....    | 1-28       |
| 1.7.6 Audio Subsystem .....                             | 1-29       |
| 1.7.6.1 CD-ROM Audio-In Header: JCDIN1.....             | 1-29       |
| 1.7.6.2 CD-ROM Audio-In Header: JCDIN2.....             | 1-30       |
| 1.7.6.3 Front Audio Header: JAUDIO1(Optional).....      | 1-30       |
| 1.7.6.4 Telephony Audio Header: JTAD1(Optional) .....   | 1-30       |
| 1.7.6.5 Auxiliary Audio Header: JAUX1(Optional).....    | 1-30       |
| <b>2. BIOS Setup.....</b>                               | <b>2-1</b> |

## **Contents**

---

|  |            |
|--|------------|
| 2.1 Main Menu.....   | 2-3        |
| 2.2 Standard CMOS Features.....                              | 2-6        |
| 2.3 Advanced BIOS Features.....                              | 2-9        |
| 2.4 Advanced Chipset Features.....                           | 2-13       |
| 2.5 Integrated Peripherals .....                             | 2-16       |
| 2.6 Power Management Setup.....                              | 2-21       |
| 2.7 PnP/PCI Configurations.....                              | 2-26       |
| 2.8 PC Health Status .....                                   | 2-29       |
| 2.9 Frequency/Voltage Control.....                           | 2-31       |
| <b>3. RAID BIOS Setting (Optional).....</b>                  | <b>3-1</b> |
| 3.1 Getting Started .....                                    | 3-1        |
| 3.1.1 Introduction.....                                      | 3-1        |
| 3.1.2 Main Features & Benefits.....                          | 3-1        |
| 3.2 Installation of Driver.....                              | 3-2        |
| 3.2.1 Introduction.....                                      | 3-2        |
| 3.2.2 Windows 98/ME.....                                     | 3-2        |
| 3.2.3 Windows NT4.0.....                                     | 3-4        |
| 3.2.4 Windows 2000 .....                                     | 3-6        |
| 3.3 Use RAID Administrator .....                             | 3-8        |
| 3.3.1 Install RAID Administrator.....                        | 3-8        |
| 3.3.2 Run RAID Administrator.....                            | 3-9        |
| 3.3.3 Create Stripe Array (RAID 0, for Performance).....     | 3-10       |
| 3.3.4 Create Mirror Array (RAID 1, for Data Protection)..... | 3-15       |

## **Contents**

---

|   |            |
|---|------------|
| 3.3.5 Add/Remove Spare Disk.....                                | 3-20       |
| 3.3.6 Synchronize/Validate/Verify Mirror Array.....             | 3-21       |
| 3.3.7 Create Span Array.....                                    | 3-23       |
| 3.3.8 Create 0+1 Array (For Performance & Data Protection)..... | 3-24       |
| 3.3.9 Remove Disk Array.....                                    | 3-27       |
| 3.3.10 Set Transfer Mode.....                                   | 3-28       |
| 3.3.11 Device Status.....                                       | 3-29       |
| 3.3.12 Hot-swapping Hard Disks of Mirror Array.....             | 3-30       |
| 3.3.13 Event Log.....   | 3-31       |
| 3.4 BIOS Configuration.....                                     | 3-32       |
| 3.4.1 Enter into BIOS Configuration Utility.....                | 3-32       |
| 3.4.2 Create RAID.....  | 3-33       |
| 3.4.3 Delete RAID.....  | 3-34       |
| 3.4.4 Rebuild Mirror Array.....                                 | 3-34       |
| 3.4.5 Add Spare Disk.....                                       | 3-35       |
| 3.4.6 Remove Spare Disk.....                                    | 3-35       |
| 3.4.7 Set Disk Mode.....  | 3-35       |
| 3.4.8 Set Boot Disk.....  | 3-36       |
| <b>4. Trouble Shooting.....</b>                                 | <b>4-1</b> |

## Introduction

### System Overview

Congratulations on the purchase of your new system! This motherboard is designed to take advantage of the latest industry technology to provide you with the ultimate solution in data processing. In the tradition of its predecessors, this motherboard continues a commitment to reliability and performance and strives for full compliance and compatibility with industry software and hardware standards.

### M7TDR Highlights:

- ▶ □ Contains on board I/O facilities, which include two serial ports, a parallel port, a PS/2 mouse port, a PS/2 keyboard port, audio ports, USB ports and a game port.
- ▶ □ Contains on board IDE facilities for IDE devices such as hard disks and CD-ROM Drives.
- ▶ □ Supports the Intel Pentium® 4 (Socket 423) processor, a leading edge processor which brings to you the latest technology in micro architecture design, graphics performance, system bus design, cache architecture and much more.
- ▶ □ Complies with PC ATX form factor specifications.
- ▶ □ Supports popular operating systems such as Windows 95/98, Windows NT, Windows 2000, Windows ME, Novell, UNIX, LINUX and SCO UNIX.

# 1. Motherboard Description

## 1.1 Features

### 1.1.1 Hardware

#### CPU

- Provides Socket-423.
- The Intel Pentium<sup>®</sup> 4 processor the new generation power for high-end workstations and servers.

#### Speed

- Running at 400 MHz Front Side Bus frequency.
- Supports up to 1.8GHz CPU core speeds.
- The 33MHz 32 bit PCI 2.2 compliant.
- The 66MHz AGP 2.0 compliant interface supports 1x, 2x, 4x data transfer mode. (Supports only 1.5v AGP electricals.)

#### Chipset

- Chipset– Intel 82845/82801BA.
- Chipset – Winbond W83627HF.



**DRAM Memory**

- Supports 100MHz or 133MHz SDR SDRAM devices.
- Supports 64Mb, 128Mb, 256Mb and 512Mb technologies for x8 and 16 devices.
- Max of 3 Double-Sided DIMMs (6 rows populated) with unbuffered PC133 (with or without ECC).
- The largest memory capacity possible is 1.5 GB.

**Shadow RAM**

- Motherboard is equipped with a memory controller providing shadow RAM and support for ROM BIOS.

**Green Functionality**

- Supports Award BIOS™ power management functionality.
- Has a power down timer from 1 to 15 minutes.
- Wakes from power saving sleep mode with any keyboard or mouse activity.

**BUS Slots**

- Provide one AGP slot.
- Provide one CNR slot.
- Provide six 32-bit PCI bus slots

**Flash Memory**

- Supports flash memory functionality.
- Supports ESCD functionality.

**Built in IDE Facilities**

- Supports four IDE hard disk drives.
- Supports PIO Mode 4, Master Mode, and high performance hard disk drives.
- Supports disk transfer rates up to 100 MB/second.
- Supports Ultra DMA 33, Ultra DMA 66, Ultra DMA 100 Bus Master Modes.
- Supports IDE interface with CD-ROM.
- Supports high capacity hard disk drives.
- Supports LBA mode.

**AC'97 Sound Codec Onboard**

- AC-LINK protocol compliance.
- Compliant with AC'97 2.2 specification.
- 18-bit full duplex stereo ADC,DACs.
- SNR>95 Bb throughmixer and DAC.
- AC-3 playback required for PVD applications.

**Universal Serial Bus**

- Supports two back panel Universal Serial Bus Ports and two front panel Universal Serial Bus Ports (optional).
- Supports 48 MHz USB.

**Hardware Monitor Function**

- Monitors CPU Fan Speed.
- Monitors System Voltage.

**HPT370 is designed to enable you add high performance ATA/ATAPI devices. (Optional)**

- Ultra DMA 100MB/S operation per ATA channel.
- Support up to 66MHz PCI bus Clock.

- One PCI function supports two independent ATA channels.
- Dedicated ATA Bus.
- ATA clock independent from PCI bus.
- Optional between external 50Hz ATA bus clock or internal PLL.
- 256Byte FIFO per ATA channel.
- Large FIFO independent.
- Easy Plug-and-Play feature.
- Supports up to 4 IDE devices. (Coexist with on-board IDE)
- Supports Hard Drive with capacity larger than 30GB.
- RAID function supported (RAID 0,1,0+1).
- Supports the most popular Windows 95/98, Windows NT4.0, Windows 2000, Windows ME and Linux.
- Supports booting function with Flash Memory interface.
- Automatically fine tunes to the best performance for each IDE/ATAPI device.
- Concurrent PIO and bus master access(ATA port accessible during DMA transfer)
- Total ATA bus tri-state by external control and Supports Hotswap (Low signal Current).

**Dimensions (ATX form-factor)**

- 24.4cm x 30.5cm (WxL).

**Super I/O Built-in onboard**

- Support one multi-mode Parallel Port.
  - (1) Standard & Bidirection Parallel Port (SPP).
  - (2) Enhanced Parallel Port (EPP).
  - (3) Extended Capabilities Port (ECP).
- Supports two serial ports, 16550 UART with 16 byte FIFO.
- UART data rates up to 1.5 Mbaud.
- Supports one Infrared transmission (IR) port.
- Supports PS/2 Mouse /Keyboard.
- Supports 360KB, 720KB, 1.2MB, 1.44MB and 2.88MB floppy disk drives.

### **1.1.2 BIOS**

- AWARD legal BIOS.
- Supports APM1.2.
- Supports USB Function.
- Supports ACPI.

### **1.1.3 Software**

#### **Operating System**

- Offers the highest performance for MS-DOS, Windows NT, Windows 2000, Windows 95/98, Windows ME, Novell, LINUX, UNIX, SCO UNIX etc.

### **1.1.4 Accessories**

- HDD Cable.
- FDD Cable.
- Flash Memory Writer for BIOS Update.
- USB Cable (Optional).
- Rear I/O Panel for ATX Case (Optional).
- Fully Setup Driver CD.

## 1.2 Motherboard Installation

### 1.2.1 System Block Diagram

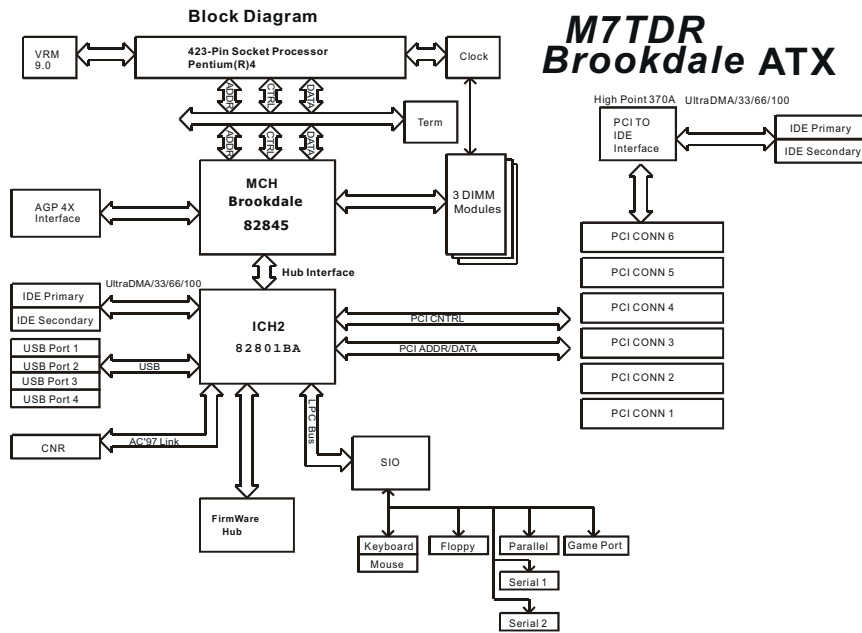

### 1.2.2 Layout of Motherboard Model No. M7TDR

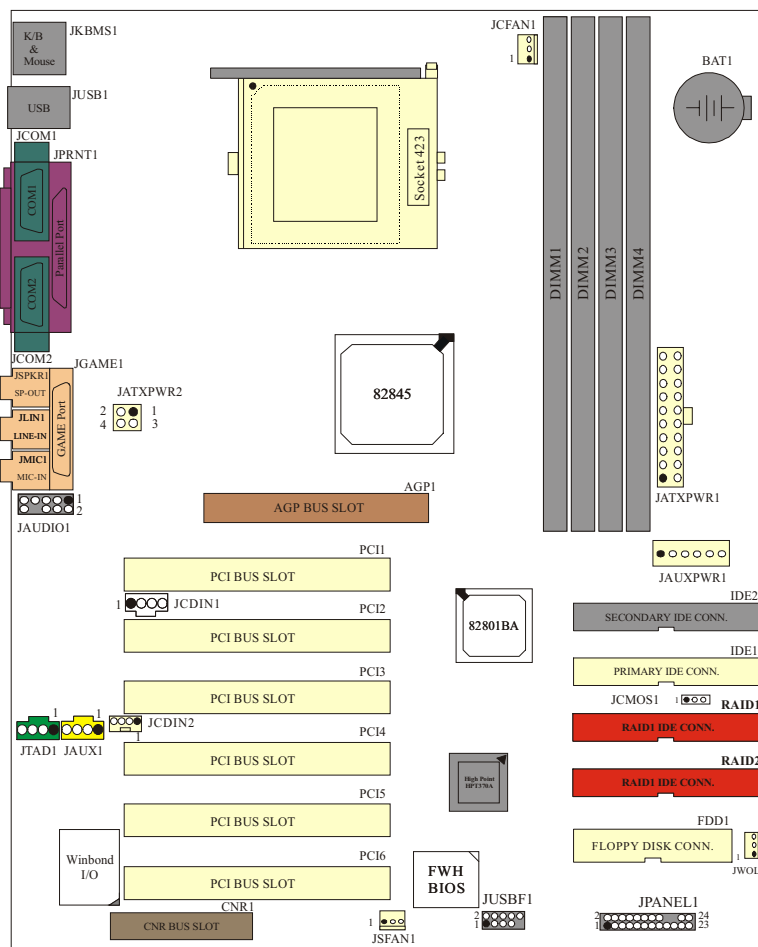

## 1.2.3 Quick Reference

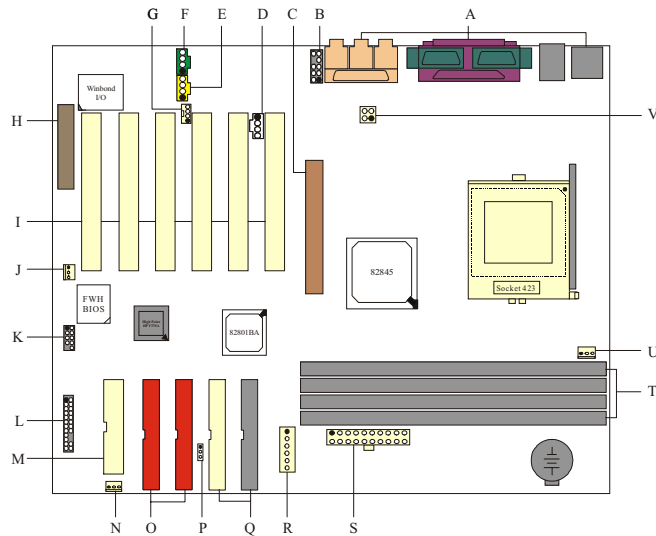

- |   |   |
|---|---|
| <b>A. Back Panel I/O Connectors</b>       | <b>M. Floppy Disk Connector (FDD1)</b>        |
| <b>B. Front Audio Header (*JAUDIO1)</b>   | <b>N. Wake-On-LAN Header (JWOL1)</b>          |
| <b>C. AGP Slot (AGP1)</b>                 | <b>O. RAID Conn. (*RAID1/2)</b>               |
| <b>D. CD Audio-In Headers (JCDIN1)</b>    | <b>P. Clear CMOS Jumper (JCMOS1)</b>          |
| <b>E. Auxiliary Audio Header (*JAUX1)</b> | <b>Q. IDE Connectors (IDE1/2)</b>             |
| <b>F. Telephony Audio Header (*JTAD1)</b> | <b>R. AUX Power Connector (JAUXPWR1)</b>      |
| <b>G. CD Audio-In Headers (JCDIN2)</b>    | <b>S. ATX Main Power Connector (JATXPWR1)</b> |
| <b>H. CNR Slot (CNR1)</b>                 | <b>T. DIMMs (DIMM1/4)</b>                     |
| <b>I. PCI BUS Slots (PC11-6)</b>          | <b>U. CPU FAN Header (JCFAN1)</b>             |
| <b>J. System FAN Header (JSFAN1)</b>      | <b>V. ATX12V Power Connector (JATXPWR2)</b>   |
| <b>K. Front USB Header (*JUSB1)</b>       |   |
| <b>L. Front Panel Connector (JPANEL1)</b> |   |

NOTE: The “\*” mark represent the function is optional.

## 1.3 CPU Installation

### 1.3.1 CPU Installation Procedure: Socket 423

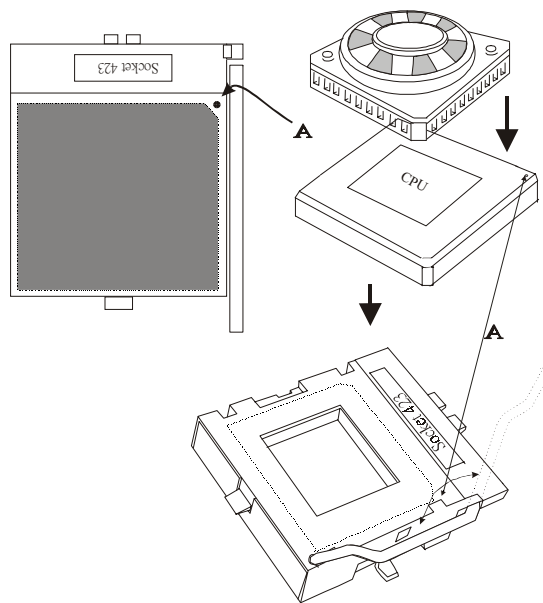

1. Pull the lever sideways away from the socket then raise the lever up to a 90-degree angle.
2. Locate Pin A in the socket and look for the white dot or cut edge in the CPU. Match Pin A with the white dot/cut edge then insert the CPU.
3. Press the lever down.
4. Put the fan on the CPU and buckle it and put the fan's power-port into the JCFAN1, then to complete the installation.



**CPU Installation Layout**

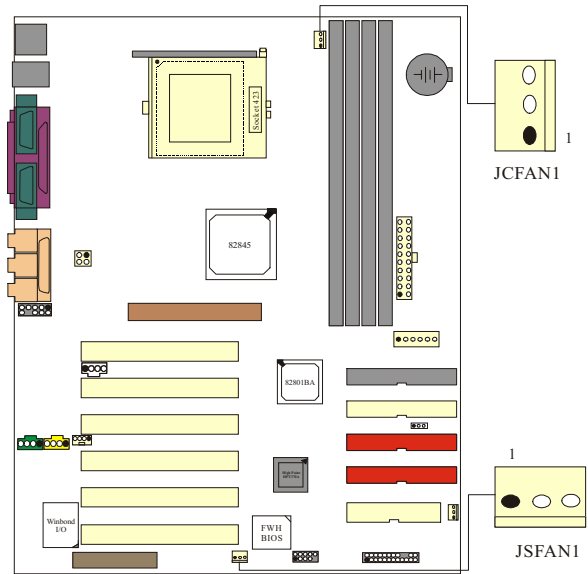

**1.3.2 CPU Fan Header: JCFAN1**

| Pin No. | Assignment |
|---------|------------|
| 1       | Ground     |
| 2       | 12V        |
| 3       | Sense      |

**1.3.3 System Fan Header: JSFAN1**

| Pin No. | Assignment |
|---------|------------|
| 1       | Ground     |
| 2       | 12V        |
| 3       | Sense      |

## 1.4 RAM Module Installation

### 1.4.1 DIMM

DRAM Access Time: 3.3V Unbuffered SDRAM PC100/133 Type required.

DRAM Type: 64MB/ 128MB/ 256MB/512MB DIMM Module  
(168 pin)

| Total            | Bank 0      | Bank 1      | Bank 2      |
|------------------|-------------|-------------|-------------|
| Memory Size (MB) | DIMM1       | DIMM2       | DIMM3/4     |
| 64 M             | 64M x 1 pc  | ----        | ----        |
| 128 M            | 128M x 1 pc | ----        | ----        |
| 256 M            | 256M x 1 pc | ----        | ----        |
| 512 M            | 512M x 1 pc | ----        | ----        |
| 128 M            | 64M x 1 pc  | 64M x 1 pc  | ----        |
| 256 M            | 128M x 1 pc | 128M x 1 pc | ----        |
| 512 M            | 256M x 1 pc | 256M x 1 pc | ----        |
| 1024 M           | 512M x 1 pc | 512M x 1 pc | ----        |
| 192 M            | 64M x 1 pc  | 64M x 1 pc  | 64M x 1 pc  |
| 320 M            | 128M x 1 pc | 128M x 1 pc | 64M x 1 pc  |
| 576 M            | 256M x 1 pc | 256M x 1 pc | 64M x 1 pc  |
| 1088 M           | 512M x 1 pc | 512M x 1 pc | 64M x 1 pc  |
| 256 M            | 64M x 1 pc  | 64M x 1 pc  | 128M x 1 pc |
| 384 M            | 128M x 1 pc | 128M x 1 pc | 128M x 1 pc |
| 640 M            | 256M x 1 pc | 256M x 1 pc | 128M x 1 pc |
| 1152 M           | 512M x 1 pc | 512M x 1 pc | 128M x 1 pc |
| 384 M            | 64M x 1 pc  | 64M x 1 pc  | 256M x 1 pc |
| 512 M            | 128M x 1 pc | 128M x 1 pc | 256M x 1 pc |
| 768 M            | 256M x 1 pc | 256M x 1 pc | 256M x 1 pc |
| 1280 M           | 512M x 1 pc | 512M x 1 pc | 256M x 1 pc |
| 640 M            | 64M x 1 pc  | 64M x 1 pc  | 512M x 1 pc |
| 768 M            | 128M x 1 pc | 128M x 1 pc | 512M x 1 pc |
| 1024 M           | 256M x 1 pc | 256M x 1 pc | 512M x 1 pc |
| 1536 M           | 512M x 1 pc | 512M x 1 pc | 512M x 1 pc |

Install DIMM3/4 in any combination table:

| DIMM3  | DIMM4  |
|--------|--------|
| Double | X      |
| X      | Double |
| Single | Single |

\* This M7TDR motherboard does not support with parity DIMM.

\*The list shown above for DRAM configuration is only for reference.

**Note:** 1. Don't stuff or remove the DIMM memory, If the LED1 is lighting.  
2. When you're using single-sided memory on DIMM4, you must use single-sided memory on DIMM3, If you use double-sided memory on DIMM3/4, please do not insert any memory on DIMM4/3.

## 1.4.2 How to install a DIMM Module

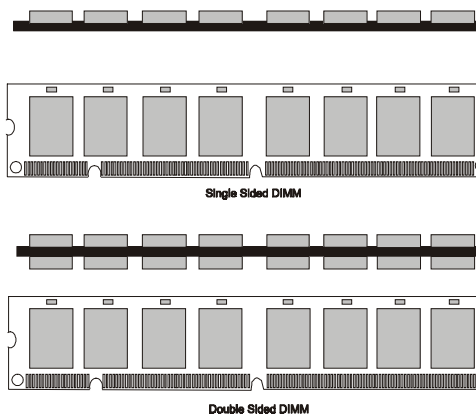

1. The DIMM socket has a “ Plastic Safety Tab” and the DIMM memory module has an asymmetrical notch”, so the DIMM memory module can only fit into the slot in one direction.

2. Push the tabs out. Insert the DIMM memory modules into the socket at a 90-degree angle then push down vertically so that it will fit into place.

3. The Mounting Holes and plastic tabs should fit over the edge and hold the DIMM memory modules in place.

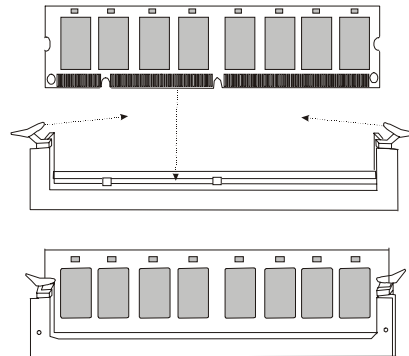

### 1.5 Slots

The slots in this motherboard are designed to hold expansion cards and connect them to the system bus. Expansion slots are a means of adding or enhancing the motherboard's features and capabilities. With these efficient facilities, you can increase the motherboard's capabilities by adding hardware that performs tasks that are not part of the basic system.

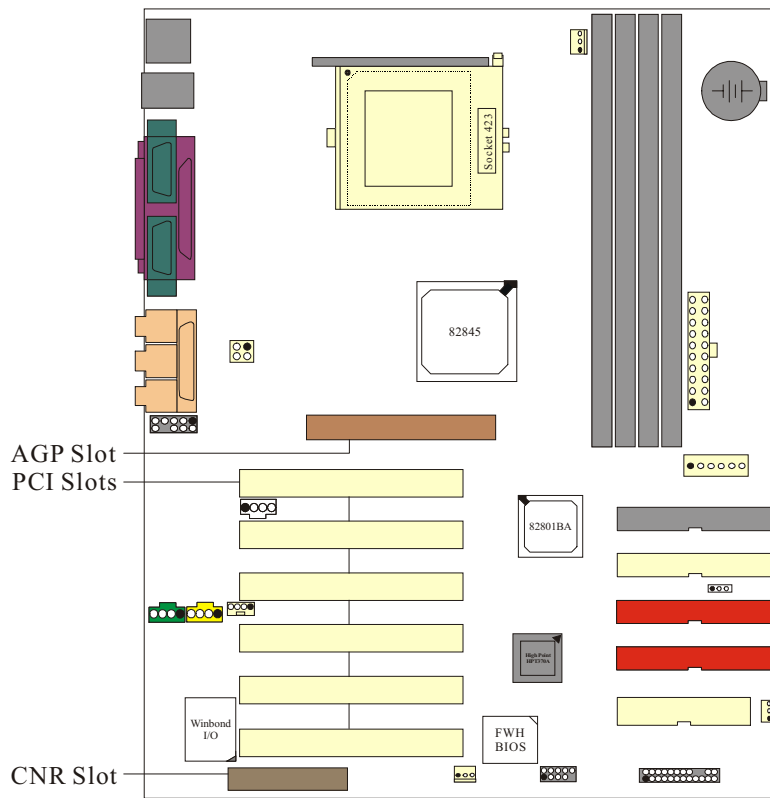

**1.5.1 AGP (Accelerated Graphics Port) Slot**

Unlike the mouse ports, keyboard ports and printer ports this motherboard does not have built in video facilities and therefore requires a video card for one of the expansion slots. Your monitor will attach directly to that video card. This motherboard supports video cards for PCI and ISA slots but is also equipped with an Accelerated Graphics Port (AGP). An AGP card will take advantage of AGP technology for improved video efficiency and performance, especially with 3D graphics.

**1.5.2 CNR (Communication Network Riser) Slot**

The CNR specification is an open Industry Standard Architecture and that defines a hardware scalable riser card interface, which supports audio, network and modem only.

**1.5.3 PCI (Peripheral Component Interconnect) Slots**

This motherboard is equipped with 6 standard PCI slots. PCI stands for Peripheral Component Interconnect and is a bus standard for expansion cards, which has, for the most part, supplanted the older ISA bus standard. This PCI slot is designated as 32 bit.

## 1.6 Connectors, Headers & Jumpers

The connectors, headers and jumpers introduced below provide you lots of capabilities such as power supply, front panel signal revelation, IDE hard disk connection, floppy disk connection, Wake On LAN function and Front USB connection. Noticeably, a jumper has two or more pins that can be covered by a plastic jumper cap, allowing you to select different system options.

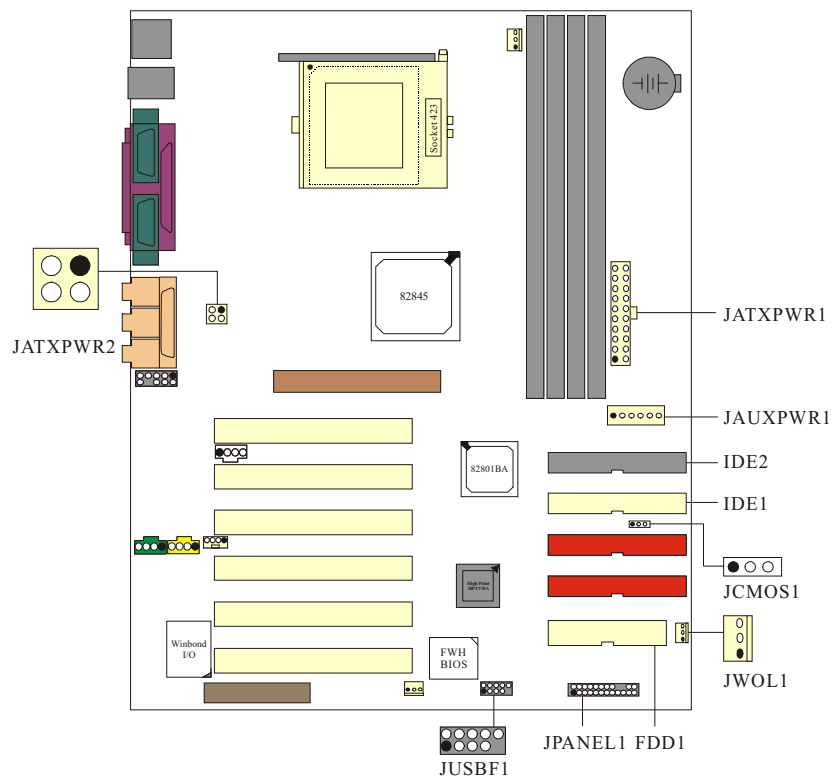

## 1.6.1 Front Panel Connector: JPANEL1

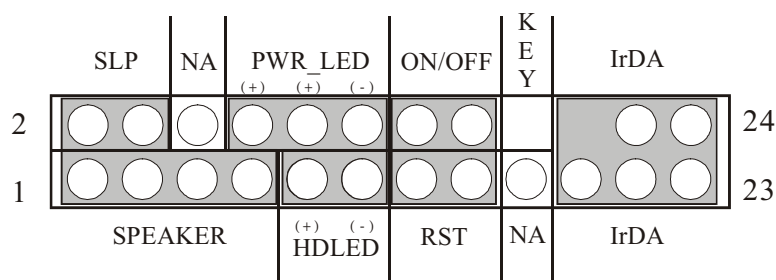

| Pin No. | Assignment    | Function          | Pin No.       | Assignment    | Function       |
|---------|---------------|-------------------|---------------|---------------|----------------|
| 1       | Speaker       | Speaker Connector | 2             | Sleep Control | Sleep Button   |
| 3       | NC            |                   | 4             | Ground        |                |
| 5       | NC            |                   | 6             | NA            |                |
| 7       | 5V            |                   | 8             | Power LED (+) | POWER LED      |
| 9       | HDD LED (+)   | 10                | Power LED (+) |               |                |
| 11      | HDD LED (-)   | 12                | Power LED (-) |               |                |
| 13      | Ground        | Reset Button      | 14            | Power Button  | POWER Button   |
| 15      | Reset Control |                   | 16            | Ground        |                |
| 17      | NA            |                   | 18            | KEY           |                |
| 19      | NA            | IrDA Connector    | 20            | KEY           | IrDA Connector |
| 21      | 5V            |                   | 22            | Ground        |                |
| 23      | IRTX          |                   | 24            | IRRX          |                |

**Speaker Connector**

An offboard speaker can be installed on the motherboard as a manufacturing option. An offboard speaker can be connected to the motherboard at the front panel connector. The speaker (onboard or offboard) provides error beep code information during the Power On Self-Test when the computer cannot use the video interface. The speaker is not connected to the audio subsystem and does not receive output from the audio subsystem.



**Reset Button**

This connector can be attached to a momentary SPST switch. This switch is usually open and when closed will cause the motherboard to reset and run the POST (Power On Self Test).

**Power LED Connector**

This connector can be attached to an LED on the front panel of a computer case. The LED will illuminate while the computer is powered on.

**HDD LED (Hard Drive LED Connector)**

This connector can be attached to an LED on the front panel of a computer case. The LED will flicker during disk activity. This disk activity only applies to those IDE drives directly attached to the system board.

**IrDA (Infrared Connector)**

This connector is used to attach to an infrared sensing device. After the IrDA interface is configured, connectionless data transfer to and from portable devices such as laptops, PDAs is possible.

**Sleep Button (Green Button)**

This connector is used to conserve energy by powering down the monitor and the hard disk when not in use. To configure this option, you need to connect a button from the front panel to this connector. Depressing the button will power down the monitor and hard drives until the system is invoked by any keyboard activity, mouse activity, modem activity or when the sleep button is depressed again. APM (Advanced Power Management) must be enabled in the system BIOS and the APM driver must be loaded.

**Power Button**

This connector can be attached to a front panel power switch. The switch must pull the Power Button pin to ground for at least 50 ms to signal the power supply to switch on or off. (The time required is due to internal debounce circuitry on the system board). At least two seconds must pass before the power supply will recognize another on/off signal.

### 1.6.2 ATX 20-pin Power Connector: JATXPWR1

This connector supports the power button on-board. Using the ATX power supply, function such as Soft Power Off is supported on this motherboard. This power connector supports instant power-on functionality, which means that the system will boot up instantly when the power connector is inserted on the board.

| PIN | Assignment | PIN | Assignment |
|-----|------------|-----|------------|
| 1   | 3.3V       | 11  | 3.3V       |
| 2   | 3.3V       | 12  | -12V       |
| 3   | Ground     | 13  | Ground     |
| 4   | 5V         | 14  | PS_ON      |
| 5   | Ground     | 15  | Ground     |
| 6   | 5V         | 16  | Ground     |
| 7   | Ground     | 17  | Ground     |
| 8   | PW_OK      | 18  | -5V        |
| 9   | 5V_SB      | 19  | 5V         |
| 10  | 12V        | 20  | 5V         |

### 1.6.3 ATX 12V Power Connector: JATXPWR2

| PIN | Assignment | PIN | Assignment |
|-----|------------|-----|------------|
| 1   | 12V        | 3   | Ground     |
| 2   | 12V        | 4   | Ground     |

### 1.6.4 AUX Power Connector: JAUXPWR1

| PIN | Assignment | PIN | Assignment |
|-----|------------|-----|------------|
| 1   | Ground     | 4   | 3.3V       |
| 2   | Ground     | 5   | 3.3V       |
| 3   | Ground     | 6   | 5V         |

### 1.6.5 Hard Disk Connectors: IDE1/IDE2

The motherboard has a 32-bit Enhanced PCI IDE Controller that provides PIO Mode 0~4, Bus Master, and Ultra DMA / 33, Ultra DMA / 66, Ultra DMA / 100 functionality. It has two HDD connectors IDE1 (primary) and IDE2 (secondary). You can connect up to four hard disk drives, a CD-ROM, a 120MB Floppy (reserved for future BIOS) and other devices to IDE1 and IDE2. These connectors support the IDE hard disk cable provided.

- **IDE1 (Primary IDE Connector)**

The first hard drive should always be connected to IDE1. IDE1 can connect a Master and a Slave drive. You must configure the second hard drive on IDE1 to Slave mode by setting the jumper accordingly.

- **IDE2 (Secondary IDE Connector)**

The IDE2 controller can also support a Master and a Slave drive. The configuration is similar to IDE1. The second drive on this controller must be set to slave mode.

### 1.6.6 Floppy Disk Connector: FDD1

The motherboard provides a standard floppy disk connector (FDC) that supports 360K, 720K, 1.2M, 1.44M and 2.88M floppy disk types. This connector supports the provided floppy drive ribbon cables.

### 1.6.7 Wake On LAN Header: JWOL1

| Pin No. | Assignment |
|---------|------------|
| 1       | 5V_SB      |
| 2       | Ground     |
| 3       | Wake up    |

### 1.6.8 Clear CMOS Jumper: JCMOS1

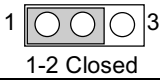
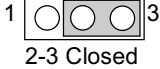
| JCMOS1  | Assignment                 |
|---|----------------------------|
| <br>1-2 Closed | Normal Operation (default) |
| <br>2-3 Closed | Clear CMOS Data            |

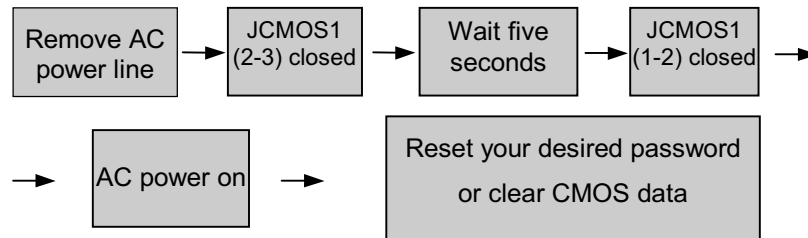

### 1.6.9 Front USB Headers: JUSBF1(Optional)

| Pin | Assignment   | Pin | Assignment   |
|-----|--------------|-----|--------------|
| 1   | 5V           | 2   | 5V           |
| 3   | USB1 Data(-) | 4   | USB2 Data(-) |
| 5   | USB1 Data(+) | 6   | USB2 Data(+) |
| 7   | Ground       | 8   | Ground       |
| 9   | KEY          | 10  | Over Current |

## 1.7 Peripheral Port

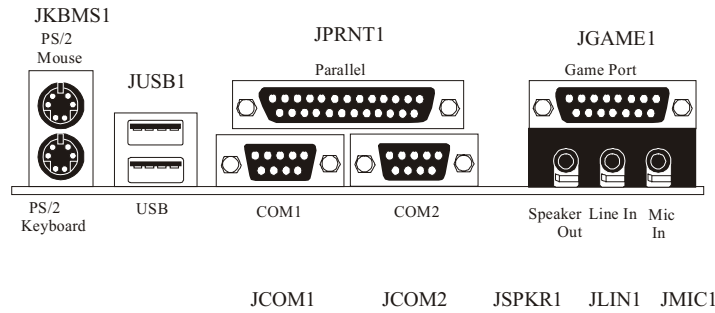

### 1.7.1 PS/2 Mouse / Keyboard Connector: JKBMS1

The motherboard provides a standard PS/2 mouse / Keyboard mini DIN connector for attaching a PS/2 mouse. You can plug a PS/2 mouse / Keyboard directly into this connector. The connector location and pin definition are shown below:

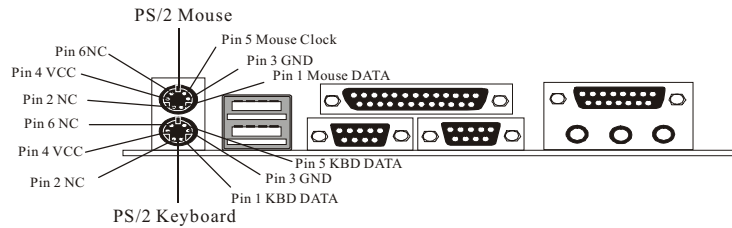

PS/2 Mouse / Keyboard Connectors

| Pin | Assignment  |
|-----|-------------|
| 1   | Data        |
| 2   | No connect  |
| 3   | Ground      |
| 4   | 5 V (fused) |
| 5   | Clock       |
| 6   | No connect  |

### 1.7.2 USB Connector: JUSB1

The motherboard provides an **OHCI (Open Host Controller Interface) Universal Serial Bus Roots** for attaching USB devices such as: keyboard, mouse and other USB devices. You can plug the USB devices directly into this connector.

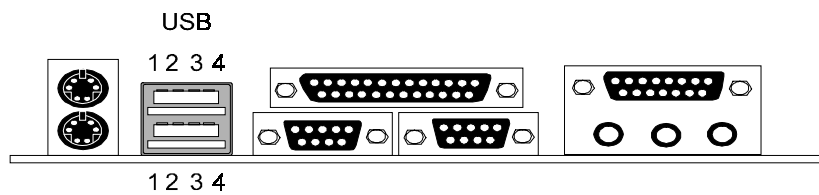

#### Stacked USB Connectors

| Pin | Assignment      |
|-----|-----------------|
| 1   | 5 V (fused)     |
| 2   | USBP0- [USBP1-] |
| 3   | USBP0+ [USBP1+] |
| 4   | Ground          |

Signal names in brackets ([ ]) are for USB Port 1.

### **1.7.3 Serial and Parallel Interface Ports**

This system comes equipped with two serial ports and one parallel port. Both types of interface ports will be explained in this chapter.

#### **1.7.3.1 The Serial Interface: JCOM1/ JCOM2**

The serial interface port is sometimes referred to as an RS-232 port or an asynchronous communication port. Mice, printers, modems and other peripheral devices can be connected to a serial port. The serial port can also be used to connect your computer with another computer system. If you wish to transfer the contents of your hard disk to another system it can be accomplished by using each machine's serial port.

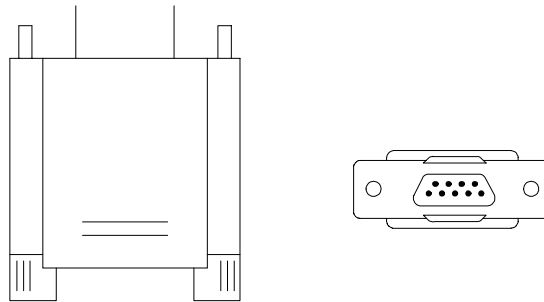

The serial ports on this system have two 9-pin connectors. Some older computer systems and peripherals used to be equipped with only one 25-pin connector. Should you need to connect your 9-pin serial port to an older 25-pin serial port, you can purchase a 9-to-25 pin adapter.

**Connectivity**

The serial ports can be used in many ways, and it may be necessary to become familiar with the pinout diagram. The following chart gives you the function of each pin on the 9-pin connector and some of the 25-pin connector. This information can be used when configuring certain software programs to work with the serial ports.

| <b>Signal</b> | <b>Name</b>         | <b>DB9 PIN</b> | <b>DB25 PIN</b> |
|---------------|---------------------|----------------|-----------------|
| DCD           | Data Carrier Detect | 1              | 8               |
| RX            | Receive Data        | 2              | 3               |
| TX            | Transmit Data       | 3              | 2               |
| DTR           | Data Terminal Ready | 4              | 20              |
| GND           | Signal Ground       | 5              | 7               |
| DSR           | Data Set Ready      | 6              | 6               |
| RTS           | Request to Send     | 7              | 4               |
| CTS           | Clear to Send       | 8              | 5               |
| RI            | Ring Indicator      | 9              | 22              |



### 1.7.3.2 Parallel Interface Port: JPRNT1

Unlike the serial ports, parallel interface port has been standardized and should not present any difficulty interfacing peripherals to your system. Sometimes called centronics port, the parallel port is almost exclusively used with printers. The parallel port on your system has a 25-pin, DB25 connector (see picture below). The pinout for the parallel port are shown in the table below.

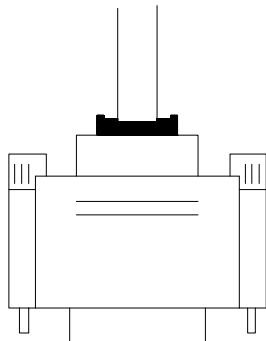
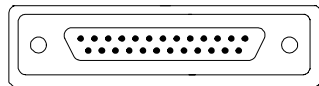

| Signal      | Pin |
|-------------|-----|
| -Strobe     | 1   |
| Data 0      | 2   |
| Data 1      | 3   |
| Data 2      | 4   |
| Data 3      | 5   |
| Data 4      | 6   |
| Data 5      | 7   |
| Data 6      | 8   |
| Data 7      | 9   |
| -Ack        | 10  |
| Busy        | 11  |
| Paper Empty | 12  |
| +Select     | 13  |
| -Auto FDXT  | 14  |
| -Error      | 15  |
| -Init       | 16  |
| -SLCTN      | 17  |
| Ground      | 18  |
| Ground      | 19  |
| Ground      | 20  |
| Ground      | 21  |
| Ground      | 22  |
| Ground      | 23  |
| Ground      | 24  |
| Ground      | 25  |

### 1.7.4 Game (Joystick/MIDI) Port Connector: JGAME1

This connector allows you to connect a joystick or game pad for playing computer games. Also, you may play or edit professional music by connecting MIDI devices.

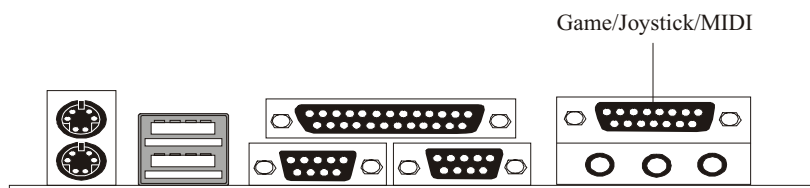

### 1.7.5 Audio Port Connectors: JSPKR1/JLIN1/JMIC1

**Speaker Out** is used to connect speakers or headphones for audio output.

**Line In** can be connected to the external CD player, Tape player or other audio devices for audio input.

**Mic In** is used to connect a microphone, which allows you to input sounds and voices.

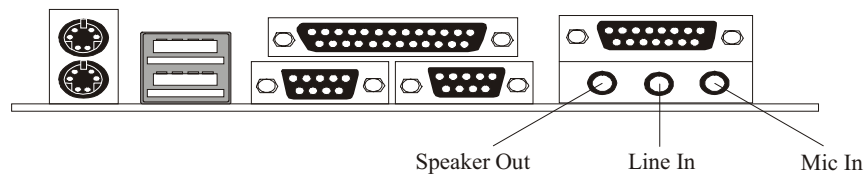

### 1.7.6 Audio Subsystem

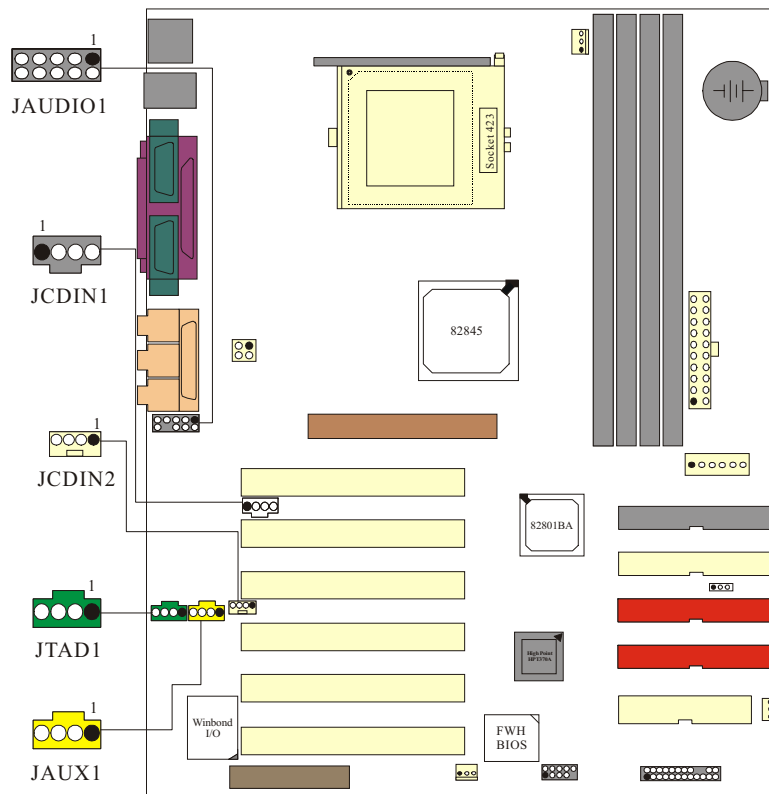

#### 1.7.6.1 CD-ROM Audio-In Header: JCDIN1

| Pin No. | Assignment          |
|---------|---------------------|
| 1       | Left Channel Input  |
| 2       | Ground              |
| 3       | Ground              |
| 4       | Right Channel Input |

**1.7.6.2 CD-ROM Audio-In Header: JCDIN2**

| Pin No. | Assignment          |
|---------|---------------------|
| 1       | Left Channel Input  |
| 2       | Ground              |
| 3       | Right Channel Input |
| 4       | Ground              |

**1.7.6.3 Front Audio Header: JAUDIO1(Optional)**

| Pin No. | Assignment   | Pin No. | Assignment   |
|---------|--------------|---------|--------------|
| 1       | Mic In       | 2       | Ground       |
| 3       | Mic Power    | 4       | Audio Power  |
| 5       | RT Line Out  | 6       | RT Line Out  |
| 7       | Reserved     | 8       | Key          |
| 9       | LFT Line Out | 10      | LFT Line Out |

**1.7.6.4 Telephony Audio Header: JTAD1(Optional)**

| Pin No. | Assignment |
|---------|------------|
| 1       | MONO_IN    |
| 2       | Ground     |
| 3       | Ground     |
| 4       | MONO_OUT   |

**1.7.6.5 Auxiliary Audio Header: JAUX1(Optional)**

| Pin No. | Assignment           |
|---------|----------------------|
| 1       | Left channel AUX_IN  |
| 2       | Ground               |
| 3       | Ground               |
| 4       | Right channel AUX_IN |

## **2. BIOS Setup**

### **Introduction**

This manual discussed Award™ Setup program built into the ROM BIOS. The Setup program allows users to modify the basic system configuration. This special information is then stored in battery-backed RAM so that it retains the Setup information when the power is turned off.

The Award BIOS™ installed in your computer system's ROM (Read Only Memory) is a custom version of an industry standard BIOS. This means that it supports Intel processors input/output system. The BIOS provides critical low-level support for standard devices such as disk drives and serial and parallel ports.

Adding important has customized the Award BIOS™, but nonstandard, features such as virus and password protection as well as special support for detailed fine-tuning of the chipset controlling the entire system.

The rest of this manual is intended to guide you through the process of configuring your system using Setup.

### **Plug and Play Support**

These AWARD BIOS supports the Plug and Play Version 1.0A specification. ESCD (Extended System Configuration Data) write is supported.

### **EPA Green PC Support**

This AWARD BIOS supports Version 1.03 of the EPA Green PC specification.

### **APM Support**

These AWARD BIOS supports Version 1.1&1.2 of the Advanced Power Management (APM) specification. Power management features are implemented via the System Management Interrupt (SMI). Sleep and Suspend power management modes are supported. Power to the hard disk drives and video monitors can be managed by this AWARD BIOS.

**PCI Bus Support**

This AWARD BIOS also supports Version 2.1 of the Intel PCI (Peripheral Component Interconnect) local bus specification.

**DRAM Support**

SDRAM (Synchronous DRAM) are supported.

**Supported CPUs**

This AWARD BIOS supports the Intel Pentium® 4 CPU.

**Using Setup**

In general, you use the arrow keys to highlight items, press <Enter> to select, use the <PgUp> and <PgDn> keys to change entries, press <F1> for help and press <Esc> to quit. The following table provides more detail about how to navigate in the Setup program by using the keyboard.

| <b>Keystroke</b> | <b>Function</b>   |
|------------------|---|
| Up arrow         | Move to previous item   |
| Down arrow       | Move to next item   |
| Left arrow       | Move to the item on the left (menu bar)   |
| Right arrow      | Move to the item on the right (menu bar)  |
| Move Enter       | Move to the item you desired  |
| PgUp key         | Increase the numeric value or make changes  |
| PgDn key         | Decrease the numeric value or make changes  |
| + Key            | Increase the numeric value or make changes  |
| - Key            | Decrease the numeric value or make changes  |
| Esc key          | Main Menu – Quit and not save changes into CMOS<br>Status Page Setup Menu and Option Page Setup Menu – Exit<br>Current page and return to Main Menu |
| F1 key           | General help on Setup navigation keys   |
| F5 key           | Load previous values from CMOS  |
| F6 key           | Load the fail-safe defaults from BIOS default table   |
| F7 key           | Load the optimized defaults   |
| F10 key          | Save all the CMOS changes and exit  |

## 2.1 Main Menu

Once you enter Award BIOS™ CMOS Setup Utility, the Main Menu will appear on the screen. The Main Menu allows you to select from several setup functions. Use the arrow keys to select among the items and press <Enter> to accept and enter the sub-menu.

**!! WARNING !!**

The information about BIOS defaults on manual (**Figure 1,2,3,4,5,6,7,8,9**) is just for reference, please refer to the BIOS installed on board, for update information.

■ **Figure 1. Main Menu**



### Standard CMOS Features

This submenu contains industry standard configurable options.

### Advanced BIOS Features

This submenu allows you to configure enhanced features of the BIOS.

**Advanced Chipset Features**

This submenu allows you to configure special chipset features.

**Integrated Peripherals**

This submenu allows you to configure certain IDE hard drive options and Programmed Input/ Output features.

**Power Management Setup**

This submenu allows you to configure the power management features.

**PnP/PCI Configurations**

This submenu allows you to configure certain “Plug and Play” and PCI options.

**PC Health Status**

This submenu allows you to monitor the hardware of your system.

**Frequency Control**

This submenu allows you to change CPU Vcore Voltage and CPU/PCI clock. **(However, this function is strongly recommended not to use. Not properly change the voltage and clock may cause CPU or M/B damage!)**

**Load Optimized Defaults**

This selection allows you to reload the BIOS when the system is having problems particularly with the boot sequence. These configurations are factory settings optimized for this system. A confirmation message will be displayed before defaults are set.



**Set Supervisor Password**

Setting the supervisor password will prohibit everyone except the supervisor from making changes using the CMOS Setup Utility. You will be prompted with to enter a password.

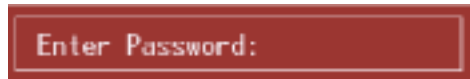



**Set User Password**

If the Supervisor Password is not set, then the User Password will function in the same way as the Supervisor Password. If the Supervisor Password is set and the User Password is set, the “User” will only be able to view configurations but will not be able to change them.

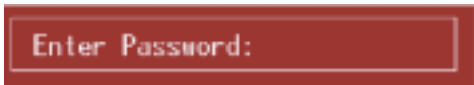

**Save & Exit Setup**

Save all configuration changes to CMOS(memory) and exit setup. confirmation message will be displayed before proceeding.

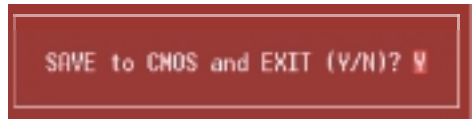

**Exit Without Saving**

Abandon all changes made during the current session and exit setup. confirmation message will be displayed before proceeding.



## 2.2 Standard CMOS Features

The items in Standard CMOS Setup Menu are divided into 10 categories. Each category includes no, one or more than one setup items. Use the arrow keys to highlight the item and then use the <PgUp> or <PgDn> keys to select the value you want in each item.

■ **Figure 2. Standard CMOS Setup**

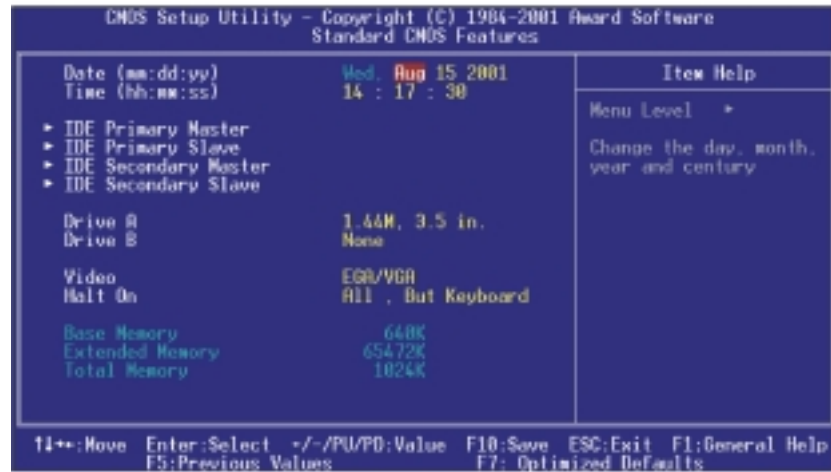

**Main Menu Selections**

This table shows the selections that you can make on the Main Menu.

| <b>Item</b>          | <b>Options</b>   | <b>Description</b>  |
|----------------------|--|---|
| Date                 | MM DD YYYY   | Set the system date. Note that the 'Day' automatically changes when you set the date. |
| IDE Primary Master   | Options are in its sub menu.   | Press <Enter> to enter the sub menu of detailed options                               |
| IDE Primary Slave    | Options are in its sub menu.   | Press <Enter> to enter the sub menu of detailed options.                              |
| IDE Secondary Master | Options are in its sub menu.   | Press <Enter> to enter the sub menu of detailed options.                              |
| IDE Secondary Slave  | Options are in its sub menu.   | Press <Enter> to enter the sub menu of detailed options.                              |
| Drive A              | 360K, 5.25 in<br>1.2M, 5.25 in<br>720K, 3.5 in<br>1.44M, 3.5 in<br>2.88M, 3.5 in | Select the type of floppy disk drive installed in your system.                        |
| Drive B              | None   |   |
| Video                | EGA/VGA<br>CGA 40<br>CGA 80<br>MONO  | Select the default video device.  |

| <b>Item</b>     | <b>Options</b>  | <b>Description</b>   |
|-----------------|---|--|
| Halt On         | All Errors<br>No Errors<br>All, but Keyboard<br>All, but Diskette<br>All, but Disk/ Key | Select the situation in which you want the BIOS to stop the POST process and notify you. |
| Base Memory     | N/A   | Displays the amount of conventional memory detected during boot up.                      |
| Extended Memory | N/A   | Displays the amount of extended memory detected during boot up.                          |
| Total Memory    | N/A   | Displays the total memory available in the system.                                       |

## 2.3 Advanced BIOS Features

■ Figure 3. Advanced BIOS Setup



### Virus Warning

This option allows you to choose the VIRUS Warning feature that is used to protect the IDE Hard Disk boot sector. If this function is enabled and an attempt is made to write to the boot sector, BIOS will display a warning message on the screen and sound an alarm beep.

|                           |                                |
|---------------------------|--------------------------------|
| <b>Disabled</b> (default) | Virus protection is disabled.  |
| Enabled                   | Virus protection is activated. |

### CPU L1 & L2 Cache

This item allows you to Enabled/ Disabled CPU L1/ L2 Cache.

**The Choices:** Enabled (default), Disabled.

**Quick Power On Self Test**

Enabling this option will cause an abridged version of the Power On Self-Test (POST) to execute after you power up the computer.

|                          |                    |
|--------------------------|--------------------|
| <b>Enabled</b> (default) | Enable quick POST. |
| Disabled                 | Normal POST.       |

**HPT370/SCSI Boot Priority (Optional)**

This item allows you to select booting priority.

**The Choices:** HPT370/ SCSI (default), SCSI/HPT370.

**First /Second/Third/ Boot Other Device**

These BIOS attempts to load the operating system from the devices in the sequence selected in these items.

**The Choices:** Floppy, LS120, HDD-0, SCSI, CDROM, HDD-1, HDD-2, HDD-3, ZIP100, LAN, HPT370, Disabled.

**Swap Floppy Drive**

For systems with two floppy drives, this option allows you to swap logical drive assignments.

**The Choices:** Enabled, **Disabled** (default).

**Boot Up Floppy Seek**

Enabling this option will test the floppy drives to determine if they have 40 or 80 tracks. Disabling this option reduces the time it takes to boot-up.

**The Choices:** **Enabled** (default), Disabled.

**Boot Up NumLock Status**

Selects the NumLock. State after power on.

|                     |                        |
|---------------------|------------------------|
| <b>On</b> (default) | Numpad is number keys. |
| Off                 | Numpad is arrow keys.  |

**Gate A20 Option**

Select if chipset or keyboard controller should control Gate A20.

|                       |   |
|-----------------------|---|
| Normal                | A pin in the keyboard controller controls Gate A20. |
| <b>Fast</b> (default) | Lets chipset control Gate A20.                      |

**Typematic Rate Setting**

When a key is held down, the keystroke will repeat at a rate determined by the keyboard controller. When enabled, the typematic rate and typematic delay can be configured.

**Disabled** (default)  
Enabled

**Typematic Rate (Chars/Sec)**

Sets the rate at which a keystroke is repeated when you hold the key down.

**The Choices:** 6 (default), 8,10,12,15,20,24,30.

**Typematic Delay (Msec)**

Sets the delay time after the key is held down before it begins to repeat the keystroke.

**The Choices:** 250 (default), 500,750,1000.

**Security Option**

This option will enable only individuals with passwords to bring the system online and/or to use the CMOS Setup Utility.

|                        |   |
|------------------------|---|
| System                 | A password is required for the system to boot and is also required to access the Setup Utility. |
| <b>Setup</b> (default) | A password is required to access the Setup Utility only.  |

This will only apply if passwords are set from the Setup main menu.

**APIC Mode**

Selecting Enabled enables ACPI device mode reporting from the BIOS to the operating system.

**The Choices:** Enabled (default), Disabled

**MPS Version Control For OS**

The BIOS supports versions 1.1 and 1.4 of the Intel multiprocessor specification. Select the version supported by the operation system running on this computer.

**The Choices:** 1.4 (default), 1.1.

**OS Select For DRAM > 64MB**

A choice other than Non-OS2 is only used for OS2 systems with memory exceeding 64MB.

**The Choices:** Non-OS2 (default), OS2.

**Report No FDD For WIN 95**

Whether report no FDD for Win 95 or not.

**The Choices:** No (default), Yes.



## 2.4 Advanced Chipset Features

This submenu allows you to configure the specific features of the chipset installed on your system. This chipset manages bus speeds and access to system memory resources, such as DRAM and external cache. It also coordinates communications with the PCI bus. The default settings that came with your system have been optimized and therefore should not be changed unless you are suspicious that the settings have been changed incorrectly.

### ■ Figure 4. Advanced Chipset Setup

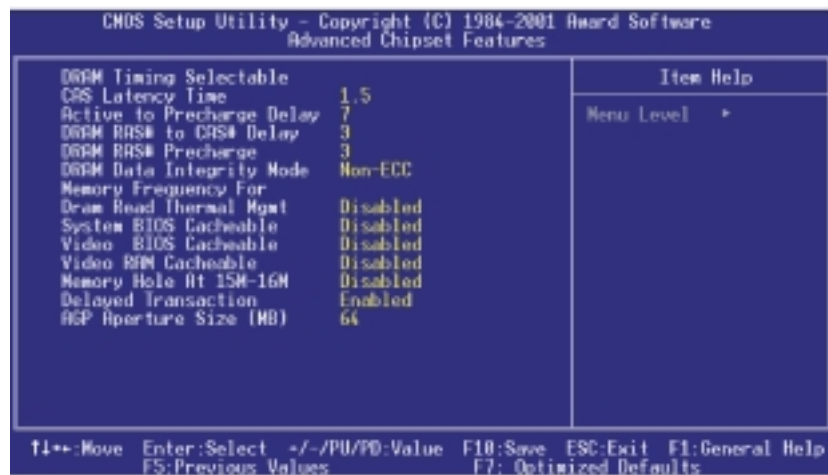

### DRAM Timing Selectable

The default is **BySPD**.

#### **CAS Latency Time**

When synchronous DRAM is installed, the number of clock cycles of CAS latency depends on the DRAM timing.

**The Choices:** 3 (default), 2.

**Active to Precharge Delay**

This item controls the number of DRAM clocks for active to precharge delay.

**The Choices:** 6(default), 7, 5.

**DRAM RAS# to CAS# Delay**

This field lets you insert a timing delay between the CAS and RAS strobe signals, used when DRAM is written to, read from, or refreshed. Fast gives faster performance; and slow gives more stable performance. This field applies only when synchronous DRAM is installed in the system.

**The Choices:** 3(default), 2.

**DRAM RAS# Precharge**

If an insufficient number of cycle is allowed for RAS to accumulate its charge before DRAM refresh, the refresh may be incomplete and the DRAM may fail to retain data. Fast gives faster performance; and Slow gives more stable performance. This field applies only when synchronous DRAM is installed in the system.

**The Choices:** 3 (default),2.

**DRAM Data Integrity Mode**

This item select supported ECC or Non-ECC for DRAM.

**The Choices:** Non-ECC (default), ECC.

**Memory Frequency For**

The default is **Auto**.

**Dram Read Thermal Mgmt**

The Intel 845 Chipset MCH provides Memory Thermal Management functionality to increase system reliability by decreasing thermal stress on system memory and the Intel 845 Chipset MCH.

**The Choices:** Disabled (default), Enabled.

**System BIOS Cacheable**

Selecting Enabled allows caching of the system BIOS ROM at F0000h~FFFFFh, resulting in better system performance. However, if any program writes to this memory area, a system error may result.

**The Choices:** Disabled (default), Enabled.

**Video BIOS Cacheable**

Select Enabled allows caching of the video BIOS, resulting in better system performance. However, if any program writes to this memory area, a system error may result.

**The Choices:** Disabled (default), Enabled.

**Video RAM Cacheable**

Enabling this option allows caching of the video RAM, resulting in better system performance. However, if any program writes to this memory area, a system error may result.

**The Choices:** Disabled (default), Enabled.

**Memory Hole At 15M-16M**

You can reserve this area of system memory for ISA adapter ROM. When this area is reserved it cannot be cached. The user information of peripherals that need to use this area of system memory usually discusses their memory requirements.

**The Choices:** Disabled (default).

**Delayed Transaction**

The chipset has an embedded 32-bit posted write buffer to support delay transactions cycles. Select Enabled to support compliance with PCI specification version 2.1.

**The Choices:** Enabled (default), disabled.

**AGP Aperture Size (MB)**

Select the size of the Accelerated Graphics Port (AGP) aperture. The aperture is a portion of the PCI memory address range dedicated for graphics memory address space. Host cycles that hit the aperture range are forwarded to the AGP without any translation.

**The Choices:** 4M, 8M, 16M, 32M, **64M** (default), 128M, 256M.

## 2.5 Integrated Peripherals

### ■ Figure 5. Integrated Peripherals



#### Onboard RAID PCI IDE

This item select to Enabled or Disabled RAID PCI IDE.

**The Choices:** Enabled (default), Disabled.

#### On-Chip IDE Control

The chipset contains a PCI IDE interface with support for two IDE channels. Select “Enabled” to activate the first and / or second IDE interface. Select “Disabled” to deactivate an interface, if you install a primary and / or secondary add-in IDE interface. If you highlight the literal “Press Enter” next to the “Onchip IDE Control” label and then press the enter key, it will take you a submenu with the following options:

##### **On-Chip Primary /Secondary PCI IDE**

The integrated peripheral controller contains an IDE interface with support for two IDE channels. Select Enabled to activate each channel separately.

**The Choices:** Enabled (default), Disabled.

**IDE Primary / Secondary Master / Slave PIO**

The IDE PIO (Programmed Input / Output) fields let you set a PIO mode (0-4) for each of the IDE devices that the onboard IDE interface supports. Modes 0 through 4 provide successively increased performance. In Auto mode, the system automatically determines the best mode for each device.

**The Choices:** Auto (default), Mode0, Mode1, Mode2, Mode3, Mode4.

**IDE Primary / Secondary Master / Slave UDMA**

Ultra DMA / 33 implementation is possible only if your IDE hard drive supports. Mode 0 through 4 provide successively increased performance. In Auto mode, the system automatically determines the best mode for each device.

**The Choices:** Auto (default), Disabled.

**IDE HDD Block Mode**

Block mode is also called block transfer, multiple commands, or multiple sector read/ write. If your IDE hard drive supports block mode (most new drives do), select Enabled for automatic detection of the optimal number of block mode (most new drives do), select Enabled for automatic detection of the optimal number of block read/ write per sector the drive can support.

**The Choices:** Enabled (default), Disabled.

**USB Controller**

Select Enabled if your system contains a Universal Serial Bus (USB) controller and you have USB peripherals.

**The Choices:** Enabled (default), Disabled.

**USB Keyboard Support**

The default value is Disabled.

Enabled

Enable USB Keyboard Support.

**Disabled** (default)

Disable USB Keyboard Support.

**AC97 Audio/ Modem**

This item allows you to decide to enable/ disable to support AC97 Audio/Modem.

**The Choices:** Auto (default), Disabled.

**Init Display First**

This item allows you to decide to active whether PCI Slot or on-chip VGA first.

**The Choices:** AGP (default), PCI Solt.

**Onboard FDC Controller**

Select Enabled if your system has a floppy disk controller (FDC) installed on the system board and you wish to use it. If install and FDC or the system has no floppy drive, select Disabled in this field.

**The Choices:** Enabled (default), Disabled.

**Onboard Serial Port 1/Port 2**

Select an address and corresponding interrupt for the first and second serial ports.

**The Choices:** Disabled, Auto, 3F8/IRQ4, 2F8/IRQ3, 3E8/IRQ4, 2E8/IRQ3.

**UART Mode Select**

This item allows you to determine which Infrared (IR) function of onboard I/O chip.

**The Choices:** Normal (default), ASKIR, IrDA.

**RxD, TxD Active**

The item allows you to determine which Infrared (IR) function of onboard I/O chip.

**The Choices:** Hi/ Lo (default), Hi/ Hi, Lo/ Hi, Lo/ Lo.

**IR Transmission Delay**

This item allows you to enable/ disable IR transmission delay.

**The Choices:** Enabled (default), Disabled.

**UR2 Duplex Mode**

Select the value required by the IR device connected to the IR port. Full-duplex mode permits simultaneous two-direction transmission. Half-duplex mode permits transmission in one direction only at a time.

**The Choices:** Half (default), Full.

**Use IR Pins**

Consult your IR peripheral documentation to select the correct setting of the TxD and RxD signals.

**The Choices:** IR-Rx2Tx2 (default), Rx2D Tx2D.

**Onboard Parallel Port**

This item allows you to determine access onboard parallel port controller with which I/O Address.

**The Choices:** 378/IRQ7 (default), 278/IRQ5, 3BC/IRQ7, Disabled.

**Parallel Port Mode**

The default value is SPP.

|               |  |
|---------------|--|
| SPP (default) | Using Parallel Port as Standard Printer Port.      |
| EPP           | Using Parallel Port as Enhanced Parallel Port.     |
| ECP           | Using Parallel Port as Extended Capabilities Port. |
| ECP+EPP       | Using Parallel Port as ECP & EPP mode.             |
| Normal        | Supports EPP or ECP mode.                          |

**EPP Mode Select**

Select EPP port type 1.7 or 1.9.

**The Choices:** EPP1.7 (default), EPP1.9.

**ECP Mode Use DMA**

Select a DMA Channel for the port.

**The Choices:** 3 (default), 1.

**Game Port Address**

Game Port I/O Address.

**The Choices:** 201 (default), 209, Disabled.

**Midi Port Address**

Midi Port Base I/O Address.

**The Choices:** 330 (default), 300, 290, Disabled.

**Midi Port IRQ**

This determines the IRQ in which the Midi Port can use.

**The Choices:** 10 (default), 5.



## 2.6 Power Management Setup

The Power Management Setup Menu allows you to configure your system to utilize energy conservation and power up/power down features.

### ■ Figure 6. Power Management Setup

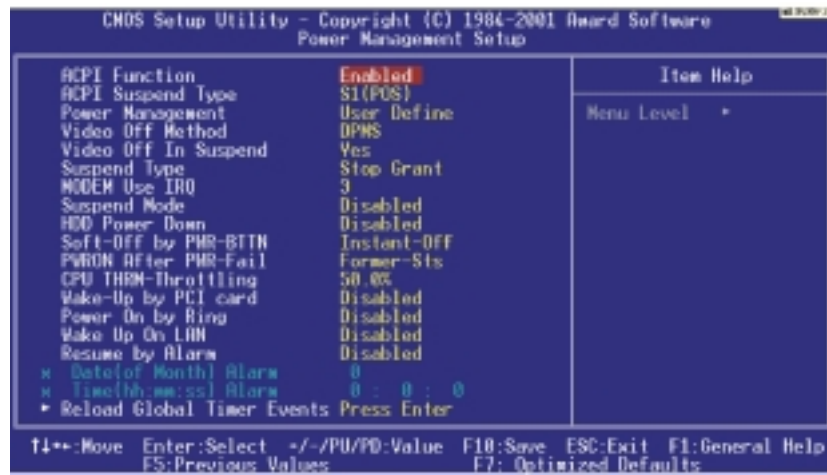

### ACPI function

This item displays the status of the Advanced Configuration and Power Management (ACPI).

**The Choices:** Enabled (default), Disabled.

### ACPI Suspend Type

The item allows you to select the suspend type under the ACPI operating system.

**The Choices:** S1 (POS) (default) Power on Suspend  
S3 (STR) Suspend to RAM

**Power Management**

This category allows you to select the type (or degree) of power saving and is directly related to the following modes:

- 1.HDD Power Down.
- 2.Doze Mode.
- 3.Suspend Mode.

There are four options of Power Management, three of which have fixed mode settings

**Min. Power Saving**

Minimum power management.  
Doze Mode = 1 hr.  
Standby Mode = 1 hr  
Suspend Mode = 1 hr.  
HDD Power Down = 15 min

**Max. Power Saving**

Maximum power management only available for sl CPU's.  
Doze Mode = 1 min  
Standby Mode = 1 min.  
Suspend Mode = 1 min.  
HDD Power Down = 1 min.

**User Defined (default)**

Allows you to set each mode individually.  
When not disabled, each of the ranges are from 1 min. to 1 hr. except for HDD Power Down which ranges from 1 min. to 15 min. and disable.

**Video Off Method**

This option determines the manner in which the monitor is goes blank.

V/H SYNC+Blank

This selection will cause the system to turn off the vertical and horizontal synchronization ports and write blanks to the video buffer.

Blank Screen

This option only writes blanks to the video buffer.

**DPMS** (default)

Initial display power management signaling.

**Video Off In Suspend**

This determines the manner in which the monitor is blanked.

**The Choices:** Yes (default), No.

**Suspend Type**

Select the Suspend Type.

**The Choices:** Stop Grant (default), PwrOn Suspend.

**Modem Use IRQ**

This determines the IRQ, which can be applied in MODEM use.

**3** (default)

4 / 5 / 7 / 9 / 10 / 11 / NA

**Suspend Mode**

When enabled and after the set time of system inactivity, all devices except the CPU will be shut off.

**The Choices:** Disabled (default), 1Min, 2Min, 4Min, 8Min, 12Min, 20Min, 30Min, 40Min, 1Hour.

**HDD Power Down**

When enabled and after the set time of system inactivity, the hard disk drive will be powered down while all other devices remain active.

**The Choices:** **Disabled** (default), 1Min, 2Min, 3Min, 4Min, 5Min, 6Min, 7Min, 8Min, 9Min, 10Min, 11Min, 12Min, 13Min, 14Min, 15Min.

**Soft-Off by PWR-BTTN**

Pressing the power button for more than 4 seconds forces the system to enter the Soft-Off state when the system has “hung.”

**The Choices:** Delay 4 Sec, **Instant-Off** (default).

**PWRON After PWR-Fail**

This field determines the action the system will automatically take when power is restored to a system that had lost power previously without any subsequent manual intervention. There are 3 sources that provide current to the CMOS area that retains these Power-On instructions; the motherboard battery (3V), the Power Supply (5VSB), and the Power Supply (3.3V). While AC is not supplying power, the motherboard uses the motherboard battery (3V). If AC power is supplied and the Power Supply is not turned on, 5VSB from the Power Supply is used. When the Power Supply is eventually turned on 3.3V from the Power Supply will be used.

There are 3 options: “Former-Sts”, “On”, “Off”.

|                        |  |
|------------------------|--|
| “Former-Sts” (default) | Means to maintain the last status of the CMOS when AC power is lost. |
| “On”                   | Means always set CMOS to the “On” status when AC power is lost       |
| “Off”                  | Means always set CMOS to the “Off” status when AC power is lost.     |

For example: If set to “Former-Sts” and AC power is lost when system is live, then after AC power is restored, the system will automatically power on. If AC power is lost when system is not live, system will remain powered off.

**CPU THRM-Throttling**

Select the CPU THRM-Throttling rate.

**The Choices:** 87.5%, 75.5%, 62.5%, **50.0%** (default), 37.5%, 25%, 12.5%.

**Wake-Up by PCI card**

When you select Enabled, a PME signal from PCI card returns the system to Full On state.

**The Choices:** Disabled (default), Enabled.

**Power On by Ring**

An input signal on the serial Ring Indicator (RI) line (in other words, an incoming call on the modem) awakens the system from a soft off state.

**The Choices:** Disabled (default), Enabled.

**WakeUp On LAN**

To use this function, you need a LAN add-on card which support power on function. It should also support the wake-up on LAN jumper.

**The Choices:** Disabled (default), Enabled.

**Resume by Alarm**

This function is for setting date and time for your computer to boot up. During Disabled, you cannot use this function. During Enabled, Choose the Date and Time Alarm:

**Date (of Month) Alarm** You can choose which month the system will boot up.

**Time (hh:mm:ss) Alarm** You can choose what hour, minute and second the system will boot up.

*Note:* If you have change the setting, you must let the system boot up until it goes to the operating system, before this function will work.

**Reload Global Timer Events**

Reload Global Timer Events are I/O events whose occurrence can prevent the system from entering a power saving mode or can awaken the system from such a mode. In effect, the system remains alert for anything, which occurs to a device, which is configured as *Enabled*, even when the system is in a power down mode.

**Primary IDE 0/1**

**Secondary IDE 0/1**

**FDD, COM, LPT Port**

**PCI PIRQ [A-D]#**

## 2.7 PnP/PCI Configurations

This section describes configuring the PCI bus system. PCI, or Personal Computer Interconnect, is a system which allows I/O devices to operate at speeds nearing the speed of the CPU itself uses when communicating with its own special components. This section covers some very technical items and it is strongly recommended that only experienced users should make any changes to the default settings.

### ■ Figure 7. PnP/PCI Configurations

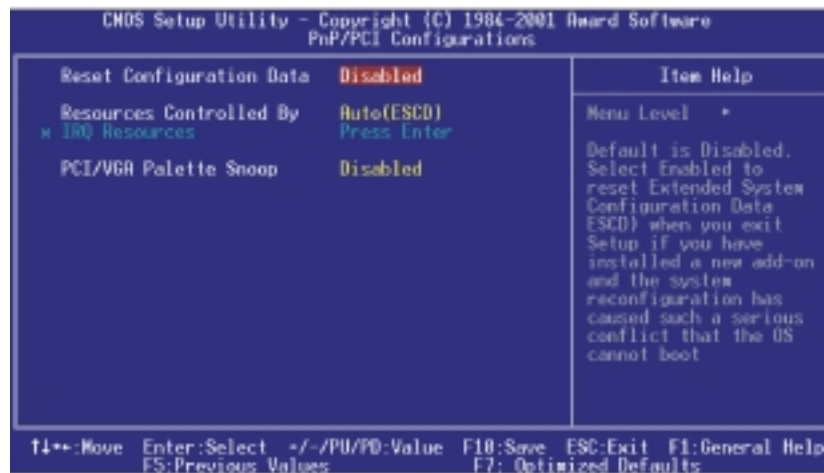

### Reset Configuration Data

The system BIOS supports the PnP feature which requires the system to record which resources are assigned and protects resources from conflict. Every peripheral device has a node, which is called ESCD. This node records which resources are assigned to it. The system needs to record and update ESCD to the memory locations. These locations (4K) are reserved in the system BIOS. If the Disabled (default) option is chosen, the system's ESCD will update only when the new configuration varies from the last one. If the Enabled option is chosen, the system is forced to update ESCDs and then is automatically set to the "Disabled" mode.

|        |                         |
|--------|-------------------------|
| IRQ-3  | assigned to: PCI Device |
| IRQ-4  | assigned to: PCI Device |
| IRQ-5  | assigned to: PCI Device |
| IRQ-7  | assigned to: PCI Device |
| IRQ-9  | assigned to: PCI Device |
| IRQ-10 | assigned to: PCI Device |
| IRQ-11 | assigned to: PCI Device |
| IRQ-12 | assigned to: PCI Device |
| IRQ-14 | assigned to: PCI Device |
| IRQ-15 | assigned to: PCI Device |

The above settings will be shown on the screen only if “Manual” is chosen for the resources controlled by function.

Legacy is the term, which signifies that a resource is assigned to the ISA Bus and provides non-PnP ISA add-on cards. PCI / ISA PnP signifies that a resource is assigned to the PCI Bus or provides for ISA PnP add-on cards and peripherals.

**The Choices:** Disabled (default), Enabled.

**Resources Controlled By**

By Choosing “Auto(ESCD)” (default), the system BIOS will detect the system resources and automatically assign the relative IRQ and DMA channel for each peripheral. By Choosing “Manual”, the user will need to assign IRQ & DMA for add-on cards. Be sure that there are no IRQ/DMA and I/O port conflicts.

**IRQ Resources**

This submenu will allow you to assign each system interrupt a type, depending on the type of device using the interrupt. When you press the “Press Enter” tag, you will be directed to a submenu that will allow you to configure the system interrupts. This is only configurable when “Resources Controlled By” is set to “Manual”.

**PCI / VGA Palette Snoop**

Choose Disabled or Enabled. Some graphic controllers which are not VGA compatible take the output from a VGA controller and map it to their display as a way to provide boot information and VGA compatibility.

However, the color information coming from the VGA controller is drawn from the palette table inside the VGA controller to generate the proper colors, and the graphic controller needs to know what is in the palette of the VGA controller. To do this, the non-VGA graphic controller watches for the Write access to the VGA palette and registers the snoop data. In PCI based systems, where the VGA controller is on the PCI bus and a non-VGA graphic controller is on an ISA bus, the Write Access to the palette will not show up on the ISA bus if the PCI VGA controller responds to the Write.

In this case, the PCI VGA controller should not respond to the Write, it should only snoop the data and permit the access to be forwarded to the ISA bus. The non-VGA ISA graphic controller can then snoop the data on the ISA bus. Unless you have the above situation, you should disable this option.

- |                           |                        |
|---------------------------|------------------------|
| <b>Disabled</b> (default) | Disables the function. |
| Enabled                   | Enables the function.  |



## 2.8 PC Health Status

### ■ Figure 8. PC Health Status

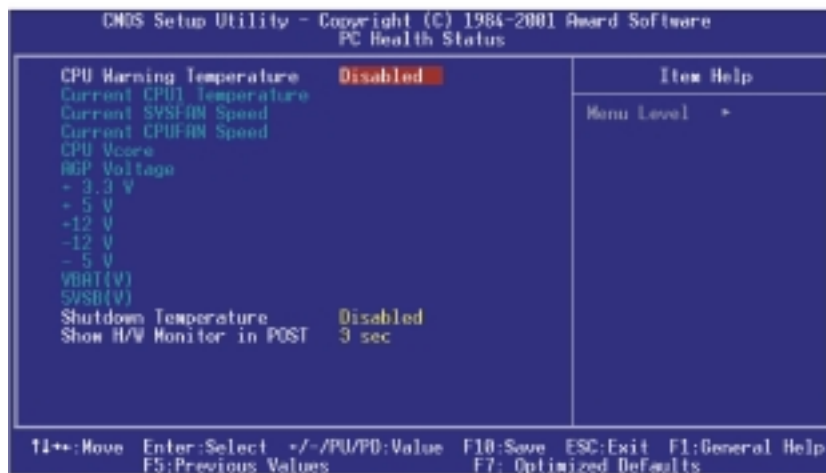

#### CPU Warning Temperature

The item will prevent CPU from overheating.

**The Choices:** Disabled (default), 50°C/122°F, 53°C/127°F, 56°C/133°F, 60°C/140°F, 63°C/145°F, 66°C/151°F, 70°C/158°F.

#### Current CPU1 Temperature

Show you the current CPU1 temperature.

#### Current SYSFAN Speed

This field displays the current speed SYSTEM fan.

#### Current CPUFAN Speed

This field displays the current CPUFAN speed.

**CPU Vcore/AGP Voltage/+3.3V/+5V/+12V/VBAT(V)/5VSB(V)**

Detect the system's voltage status automatically.

**Shutdown Temperature**

This item allows you to set up the CPU shutdown Temperature. This item only effective under Windows 98 ACPI mode.

**The Choices:** **Disabled** (default), 60°C/140°F, 65°C/149°F, 70°C/158°F, 75°C/167°F.

**Show H/W Monitor in POST**

If your computer contain a monitoring system, it will show PC health status during POST stage. The item offers several delay time to select you want.

## 2.9 Frequency/Voltage Control

### ■ Figure 9. FrequencyControl

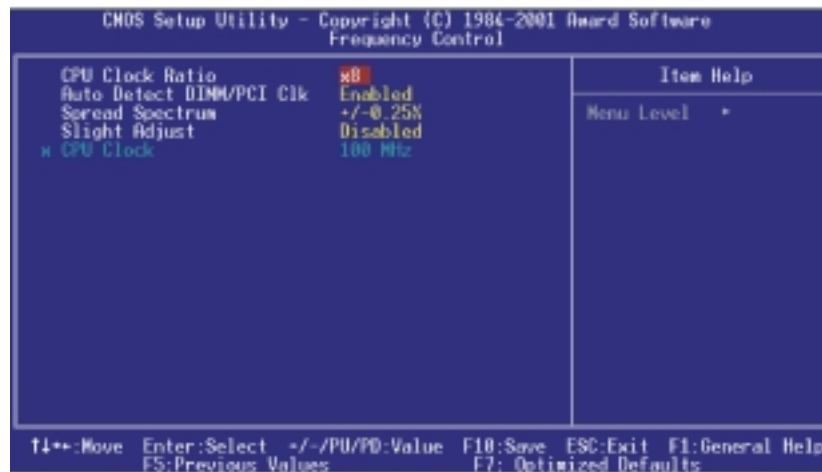

#### CPU Clock Ratio

This item allows you to select the CPU Ratio.

#### Auto Detect DIMM/PCI Clk

This item allows you to enable/ disable auto Detect DIMM/ PCI Clock.

**The Choices:** Enabled (default), Disabled.

**Spread Spectrum**

This item allows you to Enabled/ Disabled spread spectrum for all clock.

**The Choices:** +/-0.25% (default), +/-0.25%, -0.5%, +/-0.5%, +/-0.38%, Disabled.

**Slight Adjust**

This item allows you to adjust CPU frequency when “Slight Adjust” enable.

**The Choices:** Disabled (default), Enabled.



If unfortunately, the system's frequency that you are selected is not functioning, there are two methods of booting-up the system.

Method 1: Clear the COMS data by setting the JCOMS1 ((2-3) closed)) as “ON” status. All the CMOS data will be loaded as defaults setting.

Method 2: Press the <Insert> key and Power button simultaneously, after that keep-on pressing the <Insert> key until the power-on screen showed. This action will boot-up the system according to FSB of the processor.

※ **It's strongly recommended to set CPU Vcore and clock in default setting. If the CPU Vcore and clock are not in default setting, it may cause CPU or M/B damage.**

## 3. RAID BIOS Setting (Optional)

### 3.1 Getting Started

#### 3.1.1 Introduction

RAID Administrator is a Windows-based RAID management utility for HPT370 Series UDMA/ ATA100 RAID Controller. By using this RAID management utility, users can easily configure and manage the hard disks connected to this RAID Controller.

#### 3.1.2 Main Features & Benefits

Below are the main features and benefits of RAID Administrator.

- (1) Support RAID 0, 1,0+1 & JBOD
- (2) Support Ultra ATA100(UDMA Mode 5) high performance hard disk
- (3) Support up to 4 hard disks in connection
- (4) Support hot-swapping hard disks of mirror array
- (5) Support independent use of hard disk
- (6) Support such operating systems as Windows98/ME, Windows NT4.0 & Windows 2000
- (7) Support GUI software for RAID management (compatible with BIOS)
- (8) Disk error alarm mechanism
- (9) Support spare disk to automatically rebuild mirror array
- (10) Event log for easy RAID management
- (11) Plug-and-play.

## 3.2 Installation of Driver

### 3.2.1 Introduction

After the computer start up, you shall install RAID driver .

### 3.2.2 Windows 98/ME

#### Automatic Installation

After the computer start-up, Windows system will find the newly installed RAID adapter and ask you to install its driver. Please follow the prompt to finish the driver installation.

#### Manual Installation

If Windows can not find new hardware, the driver can be installed through the following steps :

1. Shut down all programs.
2. Click **Start-->Setup-->Control Panel**, then double-click on **Add New Hardware** icon.
3. Click **Next** in the popup window to continue.”.
4. A dialog box will appear and ask whether to let windows search new hardware. Select **No,I want to select the hardware form a list**. Then click **Next** to continue.
5. Hardwares of different types will be shown in the follow-on window. Select **SCSI Controllers** and then click **Next** to continue.
6. Insert the floppy disk of driver into the floppy drive, then click **Have Disk...**
7. A dialog box will pop up, input the path of driver **A:\Win9X**.Then click **OK** to continue.
8. In the follow-on window, select **HPT370 UDMA/ATA100 RAID Controller** then click **Next** to continue.
9. Follow the system prompt to install driver. When finished, restart the computer.

## Verify Installation

When the driver has been successfully installed and the computer restarted:

1. Right-click **My Computer** icon on desktop, and then select **Property** item from the popup menu.
2. Select **Device Manager** item from the popup window.

If there are two device items under **SCSI Controllers**, it indicates that the driver has been installed properly.

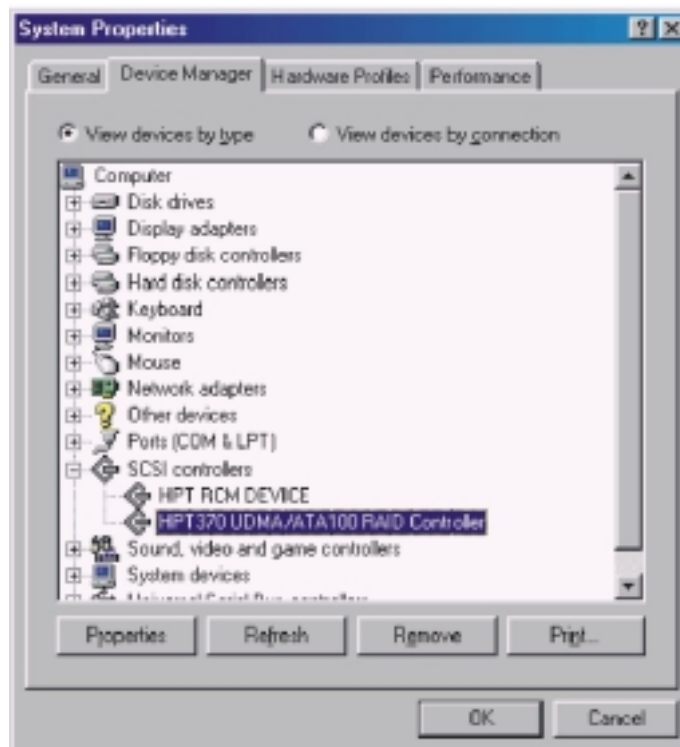

If you cannot find these two above-mentioned device items, or there are **?** or **!** on device icon, it indicates that the driver has not been correctly installed and needs reinstallation.

### 3.2.3 Windows NT4.0

#### Install driver under Windows NT4.0

1. Click **Start-->Setup-->Control Panel**, then double-click **SCSI Adapter** icon.
2. In the follow-on window, select **Driver** item. then click **Add** button.
3. In the follow-on window, select **Have Disk**.
4. Insert the floppy disk of driver, input the path of driver **A:\WinNT**, then click **OK**.
5. In the follow-on window, select **HPT370 UDMA/ATA100 RAID Controller** item, then click **OK**.
6. Follow the system prompt to install the driver. When finished, re-start the computer.

#### Install driver in the process of Windows NT4.0 installation

1. Press **F6** key when the system prompts **Setup is inspecting your computer's hardware configuration**.
2. Press **F6** key, the installation will continue. Later, installation program will remind user to press **S** key to specify other devices. Please press **S** key.
3. In the follow-on **Device Type** window, select **Other** item, then press **Enter** to confirm.
4. The installation program will prompt users to insert the floppy disk of driver. Please insert it and then press **Enter** to confirm.
5. In the follow-on window, select **HPT370 UDMA/ATA100 RAID Controller**, then press **Enter** to confirm.
6. The follow-on interface will list the devices to be installed, in which **HPT370 UDMA/ATA100 RAID Controller** item should be included.( If users want to install other devices, please operate at this time. If all devices have been successfully installed, please go to next.)
7. Press **Enter** to continue the installation of Windows NT4.0.



### Verify Installation

When the driver has been successfully installed and the computer restarted:

1. Click **Start-->Setup-->Control Panel**, and then double-click **SCSI Adapter** item.
2. If there is **HPT370 UDMA/ATA100 RAID Controller** item in the popup window, it indicates that the driver has been successfully installed. Otherwise, users need to reinstall the driver.

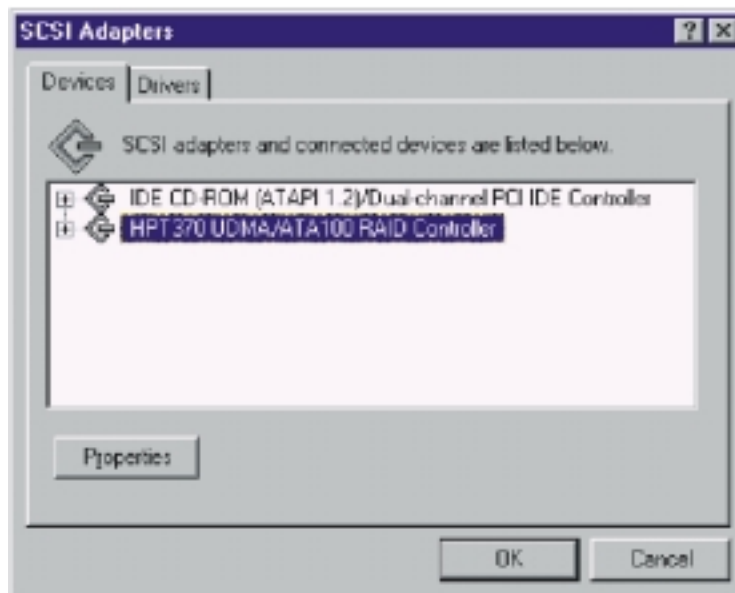

### 3.2.4 Windows 2000

#### Install driver under Windows 2000

##### Automatic Installation

Start the computer and enter the operating system of Windows 2000, the system will automatically detect new hardware and prompt users to install the driver. Please insert the floppy disk of driver and follow the system prompt to finish the driver installation and restart the computer.

##### Manual Installation

If Windows can not find new hardware, the driver shall be installed through the following steps :

1. Click **Start-->Setup-->Control Panel**, select **Add/Remove New Hardware**. In the follow-on window, Click **Next** to continue.
2. In the follow-on window, select the first item **Add/Troubleshoot a device**, then click **Next** to continue.
3. In the follow-on device list, select the first item **Add New Device**, then click **Next** to continue.
4. Then the system will ask **Did you want Windows to search for your new hardware?** Please select **No, I want to select the hardware from a list**. Then click **Next** to continue.
5. In the follow-on window of device types, select **SCSI and RAID controllers**, then click **Next** to continue.
6. In the follow-on window, select **Have Disk...**
7. Please insert the floppy disk of driver and input path name **A:\Win2k** into **Copy manufacturer's files from:** column, then click **OK**.
8. In the follow-on type column, select **HPT370 UDMA/ATA100 RAID Controllers**.
9. Follow the system prompt to finish the installation, and restart the computer.

#### Install driver in the process of Windows 2000 installation

1. If Windows 2000 is installed from the floppy drive, please let the installing program run automatically. If Windows 2000 is installed from the CD-ROM drive, please **F6** key when the message **Press F6 if you need to install third party SCSI or RAID driver** appears. If it is to type **WinNT** and install, after files have been copied and the computer

- restarted, press **F6** key when the message **Setup is inspecting your computer's hardware configuration** appears.
2. Press **S** key to specify additional devices when the **Windows 2000 Setup** window appears.
  3. In the follow-on window of device type, please select **Other** and press **Enter** to continue.
  4. Insert the floppy disk of driver, then press **Enter** to continue.
  5. The system will ask whether to install driver under **WinNT** or under **Windows 2000**, please select to install driver under **Windows 2000**.
  6. The follow-on interface will list the devices to be installed, in which **HPT370 UDMA/ATA100 RAID Controller** item should be included.( If users want to install other devices, please operate at this time. If all devices have been successfully installed, please go to next.)
  7. Press **Enter** to continue Windows 2000 setup.

## Verify Installation

When the driver has been successfully installed and the computer restarted:

1. Right-click **My Computer** icon, select **Property** item in the popup menu.
2. In the popup window, select **Hardware** item and then click **Device Manager** button.

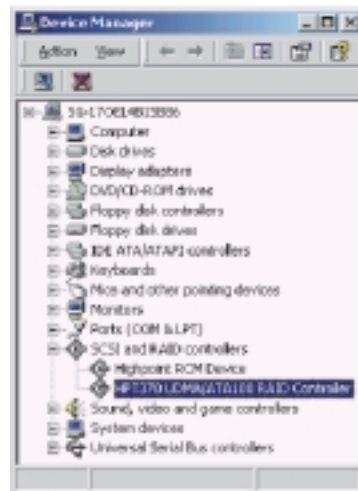

If there is **HPT370 UDMA/ATA100 RAID Controller** item in the popup **Device Manager** window, it indicates that the driver has been successfully installed. Otherwise, please reinstall the driver.

## 3.3 Use RAID Administrator

### 3.3.1 Install RAID Administrator

Please take the following steps to install RAID Administrator:

1. Insert the installation CD into the CD-ROM drive.
2. Enter **Windows Explorer**, find and double-click the setup program file:  
Setup Program: **Driver\Chipset\Hpoint\RAID\setup.exe**
3. Click **OK** button, follow the program prompt to finish the installation.
4. After the installation is complete, restart the computer.

With the implicit option, the setup program will create program group: **Start-->Program-->RAID Administrator**. This program group contains the following contents:

|                    |                      |
|--------------------|----------------------|
| RAID Administrator | running program      |
| RAID Help          | help file            |
| Uninstall RAID     | uninstalling program |

### 3.3.2 Run RAID Administrator

The following steps should be taken to run RAID Administrator.":

1. Click **Start-->Program-->RAID Administrator-->RAID Administrator**.
2. Then the main interface of RAID Administrator will come up. (see below).

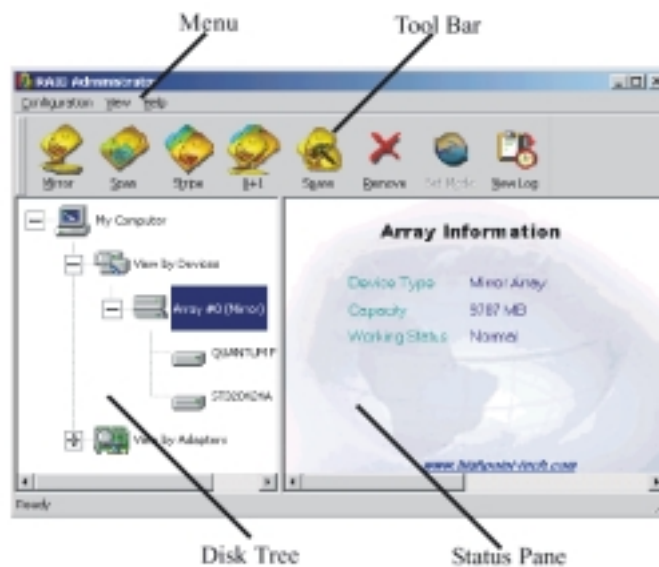
**Tool Bar:**

It provides a shortcut way to execute the common commands. Commands shown by **Tool Bar** can also be found under **Configuration** menu.

**Disk Tree:**

It shows the connecting information of all hard disks in two ways: **View by Device** and **View by Adapter**.

**Status Pane:**

It lists the information and working status of selected hard disks or disk arrays.

### 3.3.3 Create Stripe Array (RAID 0, for Performance)

The following steps shall be taken to create the stripe array.

1. Click **Stripe** icon on the tool bar.



2. Select the stripe size in the follow-on window, and then click **Next** button.

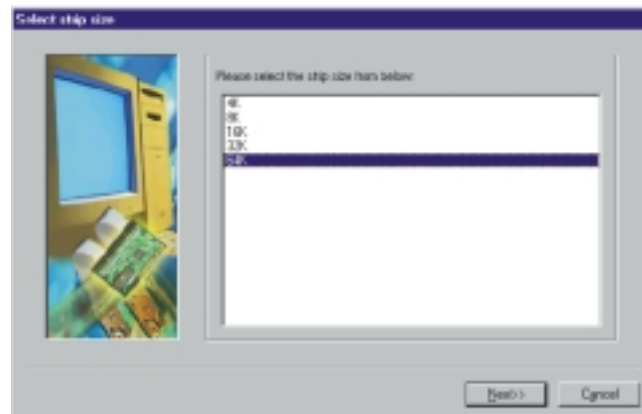

3. In the follow-on dialog box, select a hard disk from **Available Disks** column.

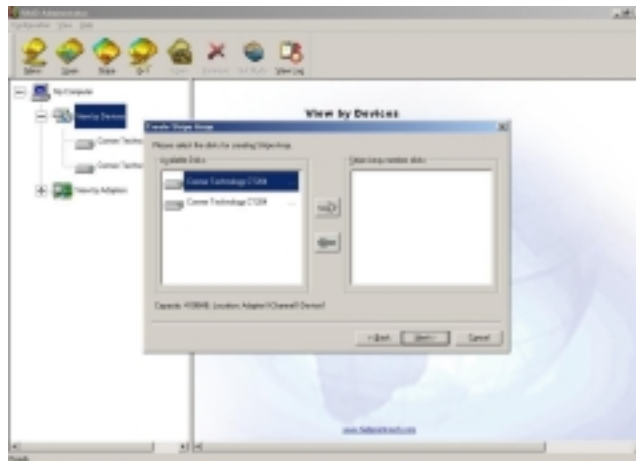

4. Add it into **Stripe Array Member Disks** column by clicking the corresponding arrow button.

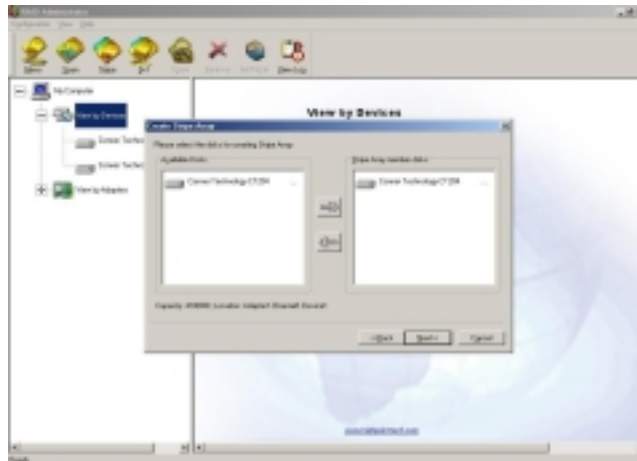

5. Continue to select the other hard disk from **Available Disks** column.

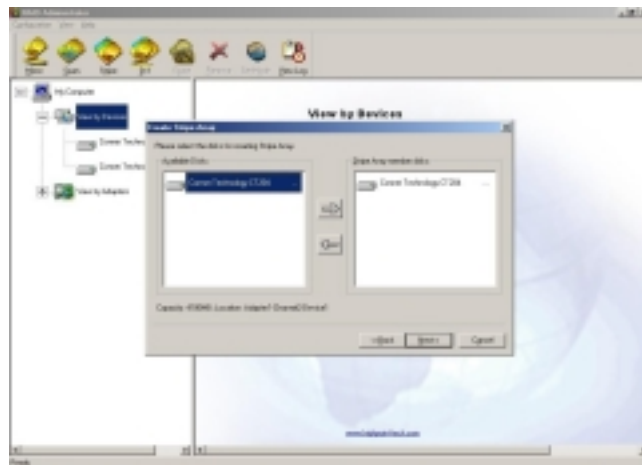

6. Add it into **Stripe Array Member Disks** column by clicking the corresponding arrow button. Then click **Next** button.

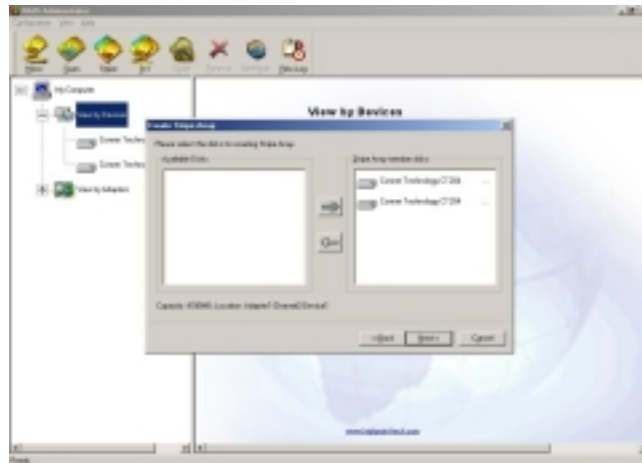



7. In the follow-on dialog box, click **Create** button to create stripe array, or click **Cancel** button to cancel this creation. If the cancel operation has been selected, the system will remain unchanged.

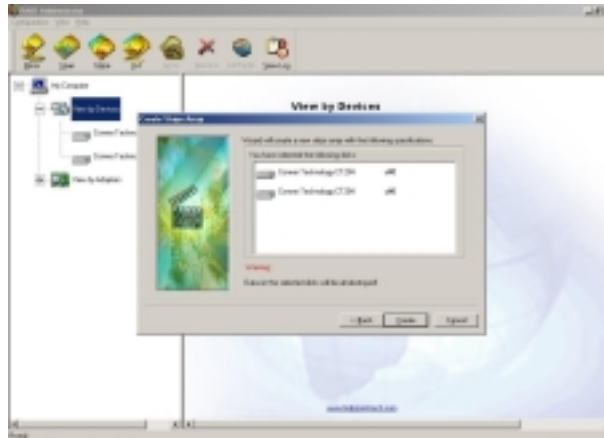

8. After the completion of creating stripe array , shut down all other programs. Then click **Yes** to restart the computer, or select **No** to restart the computer later.



9. After you restart your computer, please remember to run “FDISK” in DOS mode in order to let your computer find all your hard disks and the completely finished RAID 0 array.

**Note:**

1. At least two hard disks are needed to create the stripe array. Disks can be connected at any cable and set as either master or slave device.
2. The capacity of the stripe array is equal to the product of the number of total hard disks and the smallest HD capacity.

**Suggestion:**

1. When selecting the strip size, if the user does not know which one is suitable, please select the default size **64K**.
2. In order to avoid the capacity waste, try to use hard disks with the identical capacity to create stripe array.
3. For the consideration of performance, if two hard disks are used, please connect them to different IDE channels respectively.

**Warning:**

The data on all disks will be destroyed after the creation of the stripe array.

### 3.3.4 Create Mirror Array (RAID 1, for Data Protection)

The following steps shall be taken to create the mirror array:

1. Click **Mirror** icon on the tool bar.

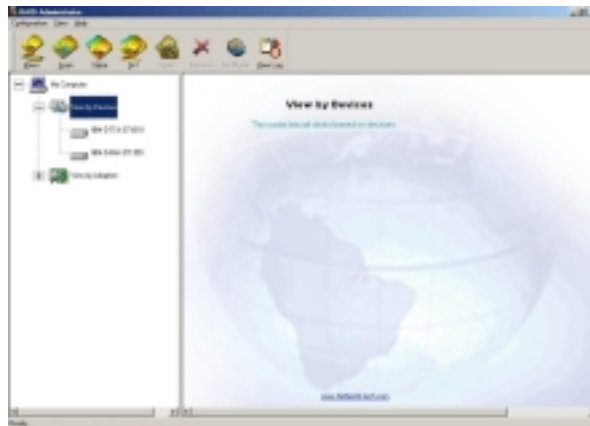

2. In the follow-on dialog box, select a hard disk from **Available Disks** column.

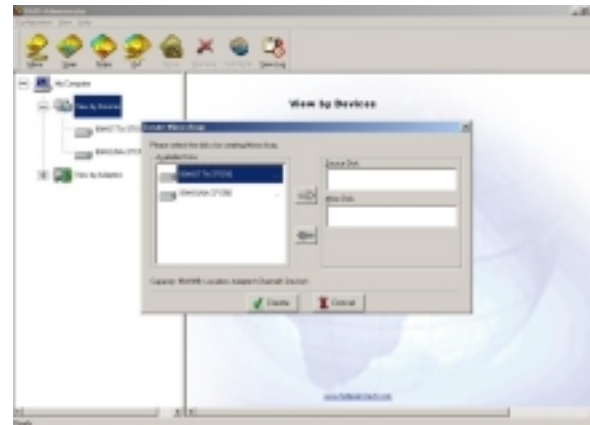

3. Then add it into **Source Disk** column or **Mirror Disk** column respectively by clicking the corresponding arrow button.



4. Continue to select the other hard disk from **Available Disks** column.

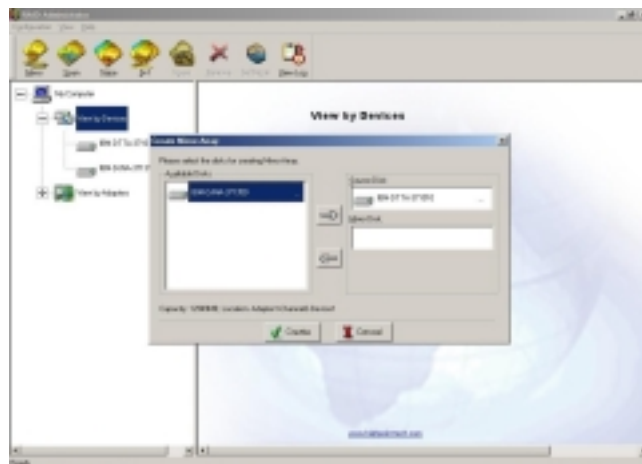

5. Add it into **Source Disk** column or **Mirror Disk** column respectively by clicking the corresponding arrow button. Then click **Create** to begin the creation or **Cancel** to exit. If you select the cancel operation, the system will remain unchanged.



- ※ If the user wants to use a spare disk, please select **Use Spare Disk** item. Then select hard disks from **Available Disks** column, and add it into **Use Spare Disk** column. (Note: This function only works when you use more than three hard disks to create the array.)

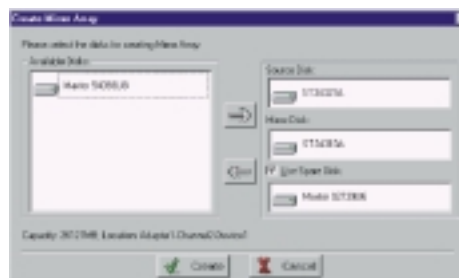

**Illustration:** If the user has set a spare disk, when the read/write failure of either the source disk or the mirror disk, the program will automatically use the left normal disk and the spare disk to rebuild the mirror array, thereby providing dual security for data.

6. After the creation is complete, the program will prompt you to synchronize mirror, select **Yes** to begin or **No** to cancel.



7. If you select **Yes**, the synchronization process will proceed as shown below.



8. After your selection of either , the program will prompt you to restart your computer. Then you can click **Yes** to restart the computer, or select **No** to restart the computer later.



9. After you restart your computer, the creating mirror array process will be completely finished.



**Note:**

1. At least the source disk and the mirror disk are needed in the creation of the mirror array. The spare disk is optional. Disks can be connected at any cable and set as either master or slave device.
2. The capacity of either the mirror disk or the spare disk shall be no less than that of the source disk.
3. The capacity of the mirror array is equal to that of the source disk.

**Suggestion:**

In order to avoid the capacity waste , please use hard disks with the identical capacity to create mirror array.

**Warning:**

The creation of the mirror array will make only the data on the source disk be preserved while the data on both the mirror disk and the spare disk destroyed.

### 3.3.5 Add/Remove Spare Disk

If the user does not want to set a spare disk during the creation of mirror, he can add the spare disk into the mirror array later. The user can also remove the spare disk that has been set. The steps to add/remove the spare disk are as follows:

1. Select the mirror array to be add/remove the spare disk.
2. Click **Spare** icon on the tool bar.
3. In the popup dialog box , select **Add** or **Remove** operation, then click **Next** button.
4. If the user is to add the spare disk, select the hard disk to be used in the follow-on dialog box , and then click **Finish** button .
5. If the user is to remove the spare disk, click **Finish** button in the follow-on dialog box .



### 3.3.6 Synchronize/Validate/Verify Mirror Array

#### Synchronize Mirror

After the completion of creating mirror array, the data on the source disk has not been copied to the mirror disk. The data on the source disk and the mirror disk do not keep identical yet. The user should synchronize mirror, by which the data on the source disk will be fully copied to the mirror disk. Thus the data on the disks in the mirror array become identical.

Once the creation of the mirror array is finished, the user will be asked whether to synchronize mirror at once or not. Select **Yes** to begin the synchronize operation or **No** to skip.

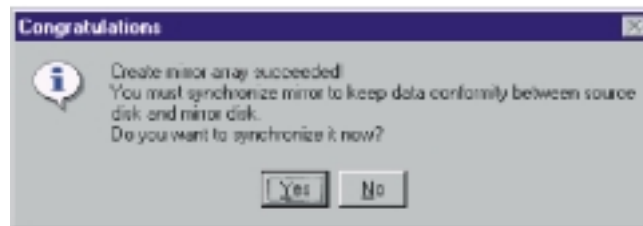

The status of the mirror array will remain locked if **No** selected to skip the synchronize operation. The user may at any time synchronize mirror which is in either locked status or normal status. The detailed steps to synchronize mirror are as follows:

1. Right-click the mirror array to be synchronized.

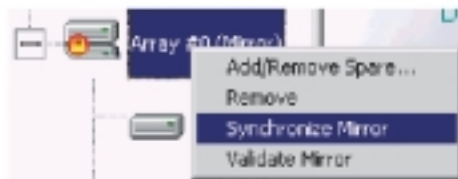

2. Select **Synchronize Mirror** item from the popup menu.

The mirror array being synchronized is labeled at locked status. By selecting this disk array, the user can see the progress of synchronizing mirror.

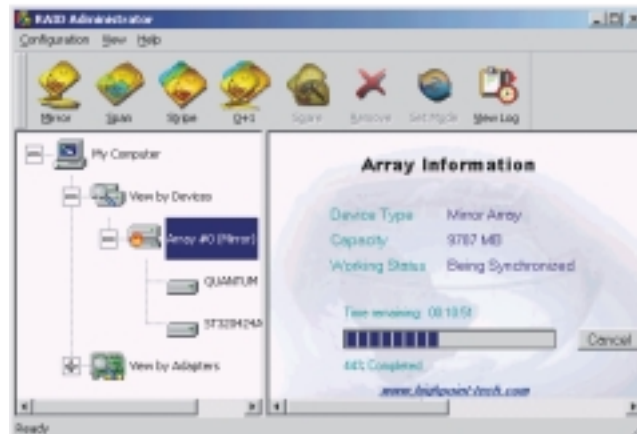

### Validate Mirror

The user can validate the locked mirror array through the following steps:

1. Right-click the locked mirror array .
2. In the popup menu, select **Validate Mirror** item.

Once the mirror disk is validated, it will be implicit by the program that the data on the mirror disk is the same with that on the source disk. And the program will no longer ask the user to synchronize mirror. If the user wants to copy the data from the source disk to the mirror disk, he has to synchronize mirror manually.

### Verify Mirror

The operation of the verify mirror will compare the data on the source disk and that on the mirror disk. If any discrepancy is found between them, the program will ask the user to synchronize mirror to keep the data in the mirror array identical. The detailed steps to verify mirror are as follows:

1. Right-click the mirror array to be verified.
2. In the popup menu, select **Verify Mirror** item.

By selecting this disk array, the user can check the verification progress at the status pane.

#### Suggestion:

After the creation of the mirror array, if the user wants to keep the source disk data preserved, he shall select **Yes** when the program asks him whether to synchronize mirror or not.

### 3.3.7 Create Span Array

Please follow the steps below to create the span array:

1. Click **Span** icon on the tool bar.
2. In the popup window, select hard disks from **Available Disks** column. Add them into **Span Array Member Disks** column by clicking the corresponding arrow. Then click **Next** to continue.
3. In the follow-on confirmation dialog box, please click **Create** button to start the creation or click **Cancel** button to cancel the creation. If the user selects **Cancel**, the system will remain unchanged.

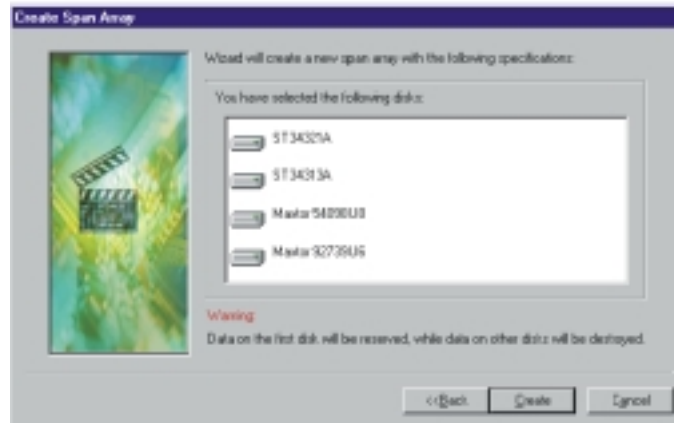

4. After the create operation is complete, please shut down all other programs. And then click **Yes** to restart the computer. The user may also select **No** to restart the computer later.

**Note:**

At least two hard disks are needed in the creation of the span array. Disks can be connected at any cable and set as either master or slave device.

**Warning:**

In the creation of the span array, only the data on the first member disk will be preserved while the data on others will be completely destroyed.

### 3.3.8 Create 0+1 Array (For Performance & Data Protection)

The following steps shall be taken to create the 0+1 array:

1. Click **0+1** icon on the tool bar.



2. Select the stripe size.

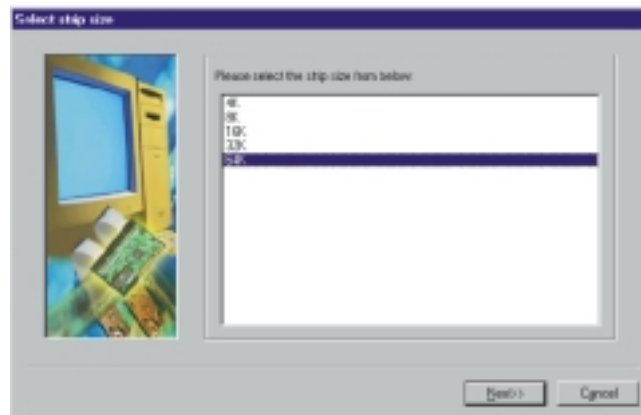

3. In the popup dialog box, select the hard disks to be used, and add them into **Source Disks** column or **Mirror Disks** column. Then click **Create** button to create or **Cancel** button to cancel the creation. If the user selects **Cancel**, the system will remain unchanged.



4. When the creation is complete, the program will ask the user to restart the computer.

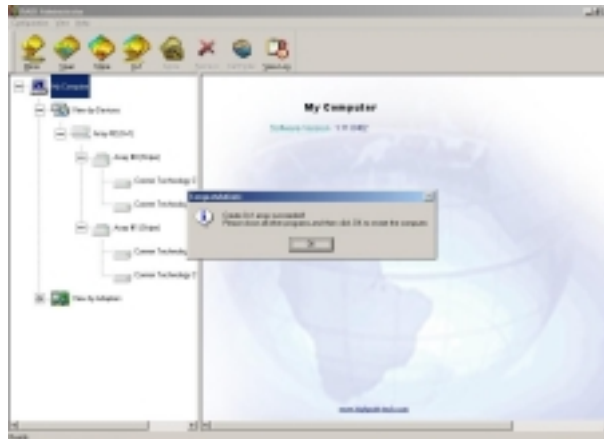

5. After you restart your computer, please remember to run “FDISK” in DOS mode in order to let your computer find all your hard disks and the completely finished RAID 0+1 array.

**Note:**

1. Four hard disks are needed in the creation of the 0+1 array.
2. In the creation of the 0+1 array, the source disk will actually be the first stripe array composed of two hard disks, the mirror disk will actually be the second stripe array composed of two hard disks.
3. The capacity of the stripe array as the source disk shall be not larger than that of the stripe array as the mirror disk.
4. The capacity of the 0+1 array is equal to that of the stripe array as the source disk.
5. Version 1.11 RAID Administrator does not support disk hot-swapping of RAID 0+1 array. User must replace the failed disk after the computer is turned off, and then rebuild the 0+1 array in BIOS.

**Suggestion:**

In order to avoid the capacity waste, please use hard disks with the identical capacity to create the 0+1 array.

**Warning:**

The data on all member disks will be destroyed after creating the 0+1 array.

### 3.3.9 Remove Disk Array

The following steps shall be taken to remove disk array.

1. Select the disk array to be deleted in the disk tree.
2. Click **Remove** icon on the tool bar.
3. In the popup dialog box, select **Yes** to confirm the remove operation, select **No** to cancel the remove operation.

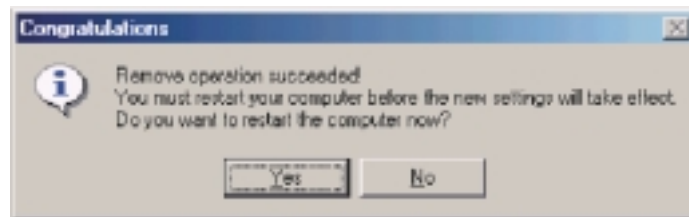

4. After the remove operation is complete, shut down all other programs. Then click **Yes** to restart the computer, or select **No** to restart the computer later.

**Note:**

1. Remove mirror array operation will generate two physical disks with the identical data on each.
2. Remove 0+1 array operation will generate two stripe arrays with the identical data on each.

**Warning:**

1. Remove stripe array operation will lead to the data on the striping disks all destroyed.
2. Remove span array operation will lead to the data on the first disk reserved while the data on other disks will be all destroyed.

### 3.3.10 Set Transfer Mode

The following steps shall be taken to set transfer mode of hard disk:

1. Select the hard disk in the disk tree.”.
2. Click **Mode** icon on the tool bar.
3. In the popup **Set Transfer Mode** window select the mode to be set.

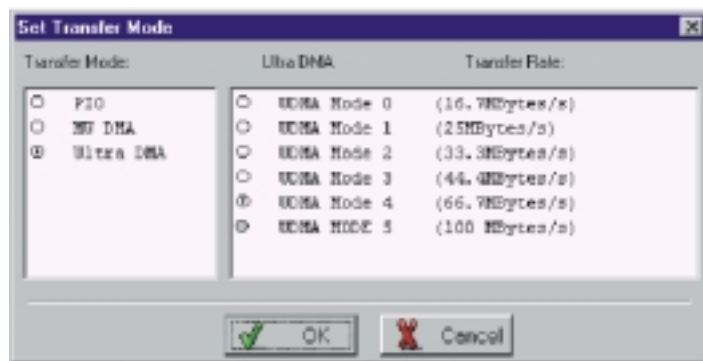

4. Click **OK** button to finish or click **Cancel** button to cancel .If **Cancel** button is clicked, the system will remain unchanged.
5. The setting will take effect only after the restart of computer.





#### Suggestion:

1. BIOS and driver of RAID Adapter can automatically detect the optimum transfer mode supported by the corresponding hard disk. Usually no need to change the transfer mode.
2. If the option box of transfer mode is gray, it means such mode is not supported by this hard disk and can not be set.



### 3.3.11 Device Status

Raid Administrator detects the status of each device and shows their status information with different icons to prompt users (see below).

-  Device is with error.
-  Device is normal.
-  Device is not operatable and needs rebooting.
-  Mirror Array needs to be synchronized.

**Note:**

When reading data from the mirror array, the source disk is always to be read first, and the mirror disk will not be accessed if the data is read out from the source disk and so the mirror disk's failure can not be detected. But when writing data to the mirror array, both of the member disks will be accessed, so failure on either of them can be detected.

**Suggestion:**

When a failure occurs on a member disk of the mirror array, this array will be labeled in error status. At this time, the mirror array can continue work normally with the other normal disk. In order to avoid data loss due to the failure of the left disk, the user shall settle the fault first and rebuild mirror with this left normal disk.

**Warning:**

1. When the member disk of either the stripe array or the span array failed, the corresponding disk array will be labeled in error status, and it will not be able to work.
2. If both the source disk and the mirror disk failed, the mirror array will not be able to work. The user shall settle the fault quickly.

### 3.3.12 Hot-swapping Hard Disks of Mirror Array

During the working process of the mirror array, if there is failure of either the source disk or the mirror disk and the spare disk has not been set, the user can remove the failed hard disk while the computer is still on and hot-plug in a new one. The program will automatically detect the plug-in of the new hard disk and prompt the user whether to add the newly plugged hard disk into the failed mirror array (see below).

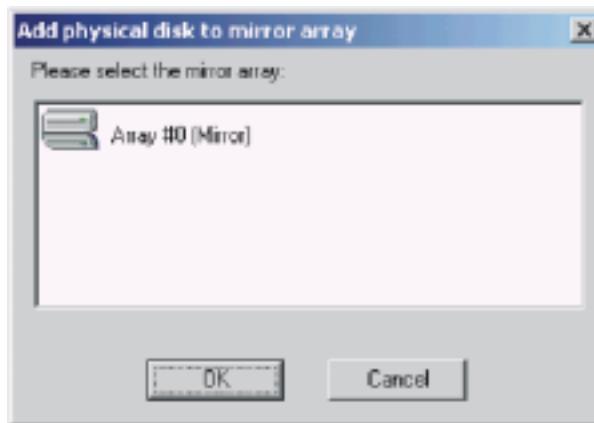

Select **OK** to add it into the failed mirror array, the newly plugged hard disk and the left normal member disk will generate a new mirror array that will be automatically synchronized to keep the data on its member disks identical. Hot-swapping hard disks of mirror array can quick recover the failed mirror array without a shut-down of the computer or a break-off of the work, thereby providing users with the maximum data security and the easiest operation.

**Note:**

The hard disk used to be a substitute for the failed one must keep the same connection to IDE and setting of jumper to that of the failed one. For example, if the failed hard disk is connected to IDE2 and set as master, its substitute must be connected to IDE2 and set as master.

**Warning:**

In order to avoid any possible damage to both the system and the device by the manual hot-swap of power and cable. Please operate hot-swapping hard disks of mirror array with the special hard disk swapping box.

### 3.3.13 Event Log

Event Log window will be opened by clicking **View Log** icon on the tool bar.

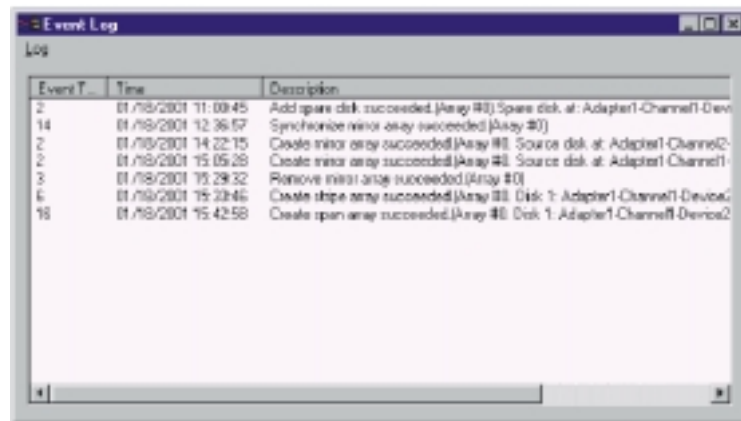

Event log window lists all the historical operation information including event, time & description, thereby providing reference for solving the problems in the operation of RAID Administrator.

Event log menu provides users with functions as follows:

- Set Log File:** Set the log file for recording the events .
- Clear Log:** Clear all the current records in the file.
- Print Log:** Print the log.
- Exit:** shut the event log window.

## 3.4 BIOS Configuration

### 3.4.1 Enter into BIOS Configuration Utility

When the following information is displayed on screen during the system starting, press **ctrl + H** key to enter into BIOS configuration utility.

```
HighPoint Technologies, Inc. HPT370 80MA/87A100 RAID Controller BIOS v1.xx
Press <Ctrl><H> to run BIOS Setting Utility
Scan Devices. Please wait .._
```

The main interface of BIOS configuration utility is as below:

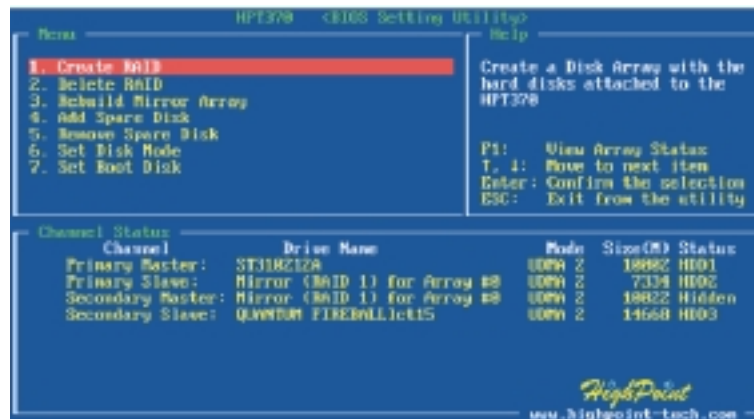

**Menu:**

It displays all items of the operating command.

**Help:**

It displays the illustrating information of the current selection and the available operation prompts.

**Channel Status:**

It displays the status information of all devices in connection. When it is active, users can select the device to be operated.

### 3.4.2 Create RAID

The following steps shall be taken to create RAID in BIOS.

1. Use the arrow key to select **1. Create RAID**.
2. Press **Enter** to confirm and go to next.
3. Select **1. Array Mode** in the popup sub-interface and press **Enter**.
4. Select the intended RAID level in the popup selection box and press **Enter**.
5. Select **2. Select Disk Drives** in the previous sub-interface and press **Enter**.
6. Select the disks to be used for creating the disk array and press **Enter** to confirm in the channel status zone.
7. Select **3. Start Creation Process** and press **Enter** except that in the selection box you have selected **Stripping (RAID 0) for Performance**.
8. Press **Y** to continue when the warning message appears.

**Note:**

1. If you have selected **Stripping (RAID 0) for Performance** in the popup sub-interface after the operation of **1. Array Mode**, you should direct go to **3. Strip Size 64K** and then select **4. Start Creation Process**. The default strip size is **64K**.
2. Different warning messages appear according to different RAID levels.

### 3.4.3 Delete RAID

The following steps shall be taken to delete RAID.

1. In the menu zone, select **2. Delete RAID**, press **Enter** to confirm this operation and go to next.
2. In the validated channel status zone, use the arrow key to select the disk array to be deleted and press **Enter** to confirm.
3. Press **Y** when warned **Are you sure you want to remove the disk array?**

### 3.4.4 Rebuild Mirror Array

The following steps shall be taken to rebuild the mirror array.

1. In the menu zone, select **3. Rebuild Mirror Array**, press **Enter** to confirm this operation and go to next.
2. In the menu zone of the popup sub-interface, select **1. Select Source Disk: None** and press **Enter** to confirm.
3. In the validated channel status zone, select the source disk of the mirror array and then press **Enter**.
4. In the menu zone of the popup sub-interface, select **2. Select Target Disk: None** and press **Enter** to confirm.
5. In the validated channel status zone, select the target disk of the mirror array and then press **Enter**.
6. In the menu zone of the popup sub-interface, select **3. Start Duplication Process** and press **Enter** to confirm.
7. Press **Y** when asked **The last time rebuild not completed. Continue?**

### 3.4.5 Add Spare Disk

The following steps shall be taken to add the spare disk.

1. In the menu zone, select **4. Add Spare Disk** and press **Enter** to confirm.
2. In menu zone of the popup sub-interface, select **1. Select Mirror Array: None** and press **Enter** to confirm.
3. In the validated channel status zone, select the mirror array and press **Enter** to confirm.
4. In the menu zone of the popup sub-interface , select **2. Select Spare Drive: None** and press **Enter** to confirm.
5. In the validated channel status zone, select the spare disk to be added and press **Enter** to confirm.

### 3.4.6 Remove Spare Disk

The following steps shall be taken to remove the spare disk.

1. In the menu zone, select **5. Remove Spare Disk** and press **Enter** to confirm.
2. The **1. Select Mirror Array: None** item appears in the menu zone of the popup sub-interface.
3. In the validated channel status zone, select the spare disk to be removed and press **Enter** to confirm.

### 3.4.7 Set Disk Mode

The following steps shall be taken to set the disk mode.

1. Select **6. Set Disk Mode** in the menu zone and press **Enter** to confirm.
2. Select the disk mode to be set in the popup selection box and press **Enter** to confirm.

### 3.4.8 Set Boot Disk.

The following steps shall be taken to set the boot disk:

1. In the menu zone, select **7. Set Boot Disk** item, press **Enter** to confirm this operation and go to next .
2. In the validated channel status zone , use the arrow key to select the boot device and press **Enter** to confirm.

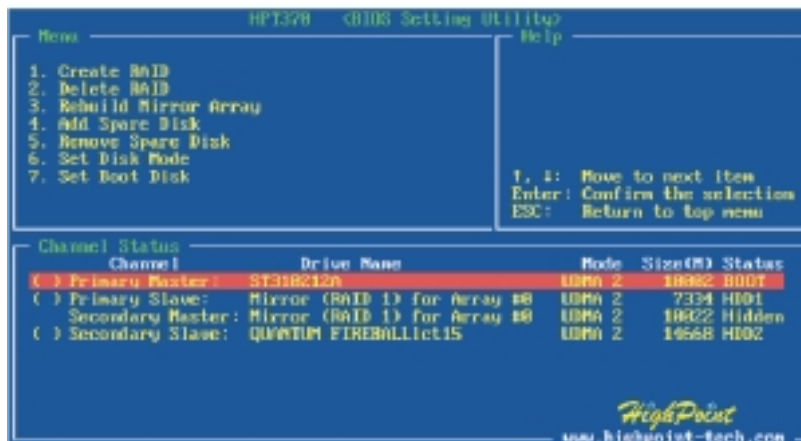

**Note:**

1. The **Set Boot Disk** item appears on condition that no hard disk is connected to IDE on motherboard.
2. After the boot disk is set, its status will become **Boot**.



## 4. Trouble Shooting

### **PROBLEM**

No power to the system at all. Power light does not illuminate, fan inside power supply does not turn on. Indicator light on keyboard does not turn on.

| <b>PROBABLE CAUSE</b>                              | <b>DIAGNOSIS</b>  | <b>SOLUTION</b>   |
|--|---|---|
| Power cable is unplugged.                          | Visually inspect power cable.                                 | Make sure power cable is securely plugged in.                               |
| Defective power cable.                             | Visually inspect the cable; try another cable.                | Replace cable.  |
| Power supply failure.                              | Power cable and wall socket are OK, but system is still dead. | Contact technical support.  |
| Faulty wall outlet; circuit breaker or fuse blown. | Plug in device known to work in socket and test               | Use different socket, repair outlet, reset circuit breaker or replace fuse. |

### **PROBLEM**

System inoperative. Keyboard lights are on, power indicator lights are lit, hard drive is spinning.

| <b>PROBABLE CAUSE</b>  | <b>DIAGNOSIS</b>   | <b>SOLUTION</b>  |
|--|--|--|
| Memory DIMM is partially dislodged from the slot on the motherboard. | Turn off computer. Take cover off system unit. Check the DIMM to ensure it is securely seated in the slot. | Using even pressure on both ends of the DIMM, press down firmly until the module snaps into place. |

**PROBLEM**

System does not boot from hard disk drive, can be booted from CD-ROM drive.

| <b>PROBABLE CAUSE</b>                                    | <b>DIAGNOSIS</b>  | <b>SOLUTION</b>   |
|--|---|---|
| Connector between hard drive and system board unplugged. | When attempting to run the FDISK utility you get a message, INVALID DRIVE SPECIFICATION.    | Check cable running from disk to disk controller board. Make sure both ends are securely plugged in; check the drive type in the standard CMOS setup. |
| Damaged hard disk or disk controller.                    | Format hard disk; if unable to do so the hard disk may be defective.                        | Contact technical support.  |
| Hard disk directory or FAT is scrambled.                 | Run the FDISK program, format the hard drive. Copy data that was backed up onto hard drive. | Backing up the hard drive is extremely important. All hard disks are capable of breaking down at any time.  |

**PROBLEM**

System only boots from CD-ROM. Hard disk can be read and applications can be used but booting from hard disk is impossible.

| <b>PROBABLE CAUSE</b>                      | <b>DIAGNOSIS</b>                         | <b>SOLUTION</b>  |
|--|--|--|
| Hard Disk boot program has been destroyed. | A number of causes could be behind this. | Back up data and applications files.<br>Reformat the hard drive.<br>Re-install applications and data using backup disks. |

**PROBLEM**

Error message reading “SECTOR NOT FOUND” or other error messages not allowing certain data to be retrieved.

| <b>PROBABLE CAUSE</b>                    | <b>DIAGNOSIS</b>  | <b>SOLUTION</b>   |
|--|---|---|
| A number of causes could be behind this. | Use a file by file backup instead of an image backup to backup the hard disk. | Back up any salvageable data. Then low level format, partition, and high level format the hard drive. Re-install all saved data when completed. |

**PROBLEM**

Screen message says “Invalid Configuration” or “CMOS Failure.”

| <b>PROBABLE CAUSE</b>   | <b>DIAGNOSIS</b>  | <b>SOLUTION</b>  |
|---|---|--|
| Incorrect information entered into the configuration (setup) program. | Check the configuration program. Replace any incorrect information. | Review system's equipment . Make sure correct information is in setup. |

**PROBLEM**

Screen is blank.

| <b>PROBABLE CAUSE</b>              | <b>DIAGNOSIS</b> | <b>SOLUTION</b>  |
|------------------------------------|------------------|--|
| No power to monitor.               |                  | Check the power connectors to monitor and to system. Make sure monitor is connected to display card. |
| Monitor not connected to computer. |                  | See instructions above.  |

**PROBLEM**

No screen.

| <b>PROBABLE CAUSE</b> | <b>DIAGNOSIS</b> | <b>SOLUTION</b>   |
|-----------------------|------------------|---|
| Memory problem.       |                  | Reboot computer.<br>Reinstall memory, make sure that all memory modules are installed in correct sockets. |
| Computer virus.       |                  | Use anti-virus programs to detect and clean viruses.  |

**PROBLEM**

Screen goes blank periodically.

| <b>PROBABLE CAUSE</b>    | <b>DIAGNOSIS</b> | <b>SOLUTION</b>       |
|--------------------------|------------------|-----------------------|
| Screen saver is enabled. |                  | Disable screen saver. |

**PROBLEM**

Keyboard failure.

| <b>PROBABLE CAUSE</b>     | <b>DIAGNOSIS</b> | <b>SOLUTION</b>  |
|---------------------------|------------------|--|
| Keyboard is disconnected. |                  | Reconnect keyboard.<br>Check keys again, if no improvement replace keyboard. |

**PROBLEM**

No color on screen.

| <b>PROBABLE CAUSE</b>    | <b>DIAGNOSIS</b> | <b>SOLUTION</b>  |
|--------------------------|------------------|--|
| Faulty Monitor.          |                  | If possible, connect monitor to another system. If no color replace monitor. |
| CMOS incorrectly set up. |                  | Call technical support.  |

**PROBLEM**

C: drive failure.

| <b>PROBABLE CAUSE</b>                    | <b>DIAGNOSIS</b> | <b>SOLUTION</b>         |
|--|------------------|-------------------------|
| Hard drive cable not connected properly. |                  | Check hard drive cable. |

**PROBLEM**

Cannot boot system after installing second hard drive.

| <b>PROBABLE CAUSE</b>                                 | <b>DIAGNOSIS</b> | <b>SOLUTION</b>   |
|---|------------------|---|
| Master/slave jumpers not set correctly.               |                  | Set master/slave jumpers correctly.   |
| Hard drives not compatible / different manufacturers. |                  | Run SETUP program and select correct drive types. Call drive manufacturers for compatibility with other drives. |

**PROBLEM**

Missing operating system on hard drive.

| <b>PROBABLE CAUSE</b>        | <b>DIAGNOSIS</b> | <b>SOLUTION</b>                          |
|------------------------------|------------------|--|
| CMOS setup has been changed. |                  | Run setup and select correct drive type. |

**PROBLEM**

Certain keys do not function.

| <b>PROBABLE CAUSE</b>     | <b>DIAGNOSIS</b> | <b>SOLUTION</b>   |
|---------------------------|------------------|-------------------|
| Keys jammed or defective. |                  | Replace keyboard. |

---

08/28/2001  
MADE IN TAIWAN  
R.O.C.

---