

# 80486

486 PCI/VESA Mainboard  
User's Guide &  
Technical Reference

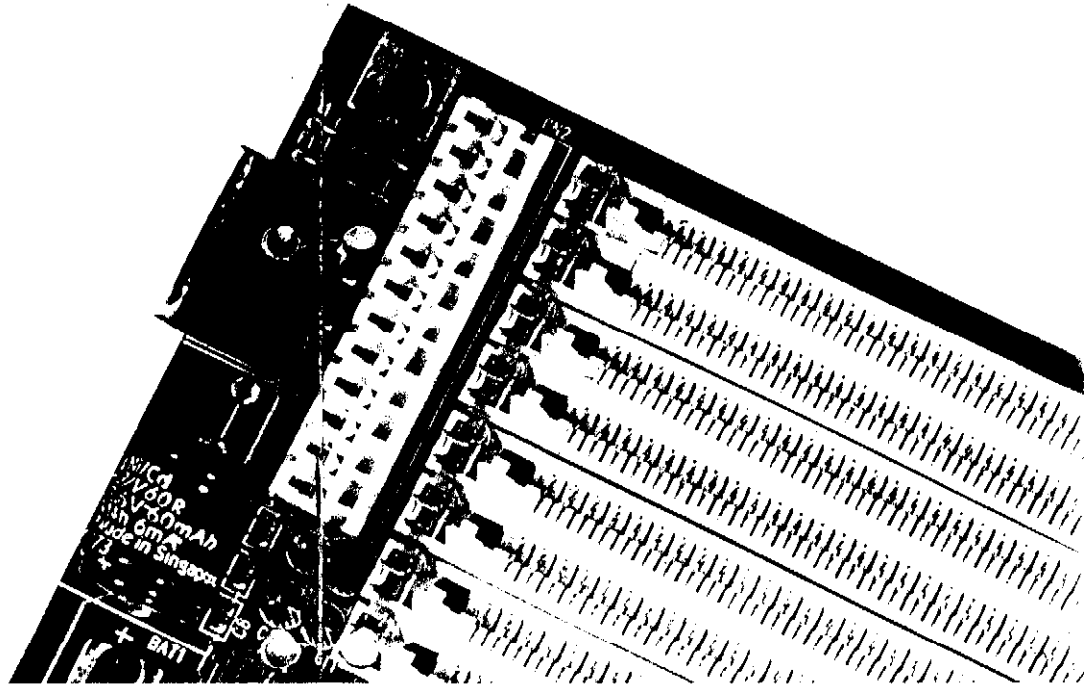

## About This Guide

This User's Guide is for assisting system manufacturers and end users in setting up and installing the mainboard. Information in this guide has been carefully checked for reliability; however, no guarantee is given as to the correctness of the contents. The information in this document is subject to change without notice.

## Copyright Notice

Copyright 1994, Soyo Technology Co., Ltd. All rights reserved. This manual is copyrighted by Soyo Technology Co., Ltd. You may not reproduce, transmit, transcribe, store in a retrieval system, or translate into any language, in any form or by any means, electronic, mechanical, magnetic, optical, chemical, manual, or otherwise, any part of this publication without express written permission of Soyo Technology Co., Ltd.

## Trademarks

Soyo is a registered trademark of Soyo Technology Co., Ltd. All trademarks are the property of their owners.

## Disclaimer

Soyo Technology Co., Ltd. makes no representations or warranties regarding the contents of this manual. We reserve the right to revise the manual or make changes in the specifications of the product described within it at any time without notice and without obligation to notify any person of such revision or change. The information contained in this manual is provided for general use by our customers. Our customers should be aware that the personal computer field is the subject of many patents. Our customers should ensure that they take appropriate action so that their use of our products does not infringe upon any patents. It is the policy of Soyo Technology Co., Ltd. to respect the valid patent rights of third parties and not to infringe upon or assist others to infringe upon such rights.

## Restricted rights legend

Use, duplication, or disclosure by the Government is subject to restrictions set forth in subparagraph (c)(1)(ii) of the Rights in Technical Data and Computer Software clause at 252.227-7013.

Edition: April 1994

Version 1.0

30 A/B/C SERIAL

# Table of Contents

<b>Chapter 1: Introduction</b> .....	<b>1</b>
Key Features.....	1
Unpacking the Mainboard.....	2
Electrostatic Discharge Precautions.....	2
Mainboard Layout.....	3
<b>Chapter 2: Hardware Setup</b> .....	<b>4</b>
Jumpers.....	4
JP3: Display Type.....	4
JP5: CMOS Reset Jumper.....	5
JP2, JP6, JP7, JP8: Monitor Green Function Control.....	5
JP20, JP27: PCI Bus Clock Mode.....	6
JP42: Berg Jumper (Green Jumper).....	6
VESA Local Bus Configuration.....	7
JP37: VESA Local Bus Clock Configuration.....	7
JP38: VESA Wait State Configuration.....	7
CPU Type Configuration.....	8
PCI Configuration.....	17
JP9-JP12: PCI Slot Trigger Type Selectors.....	17
JP10A-JP10L: IRQ Trigger Type Selectors.....	18
Cache Configuration.....	21
Cache Size and RAM Locations.....	21
Connectors.....	24
CN1 - Keyboard Connector.....	24
CN2 - Power Supply Connectors.....	24
J17 - Keylock & Power LED Connector.....	24
J18 - Speaker Connector.....	24
J19 - Hardware Reset Control.....	25
J20 - External Battery Connector.....	25
J21 - Turbo Switch Connector.....	25
J22 - Turbo LED Connector.....	25
JP18 - Green LED Connector.....	25
Memory Configuration.....	26

<b>Chapter 3: BIOS Setup</b> .....	<b>27</b>
Standard CMOS Setup.....	28
BIOS Features Setup.....	29
Chipset Features Setup.....	32
Power Management Setup.....	34
PCI Configuration Setup.....	36
Load BIOS Defaults.....	36
Load Setup Defaults.....	36
Password Setting.....	37
IDE HDD Auto Detection.....	37

## 1 Introduction

The 486 PCI/VESA mainboard is a high-performance system board that supports 486DX2/DX/SX/SL Enhanced 486, P24C, P24D, P24T, and Cyrix M6/M7 CPUs. The mainboard is fully compatible with industry standards, and adds many technical enhancements.

The 486 PCI/VESA mainboard offers superior system performance, compatibility, and reliability, and is the ideal choice for a wide variety of system applications.

### Key Features

- Fully AT compatible, supports 486DX2/DX/SX/SL Enhanced 486, P24C, P24D, P24T, AMD 486, and Cyrix M6/M7 CPUs
- Four 32-bit PCI local bus master expansion slots.
- Two 32-bit VESA local bus master expansion slots.
- Four 16-bit ISA bus expansion slots.
- Support for 256Kb, 512Kb, or 1Mb of secondary cache memory
- Flexible memory support from 1 MB up to 128 MB using 256KB, 1MB, 4MB, or 16MB SIMM
- Shadow RAM support for the system and video BIOS
- Fast Gate A20 and reset support
- BIOS/Video ROM cacheable
- Hardware turbo speed switch
- Support for both 5-volt and 3.3-volt microprocessors
- Support for Green PC functions with BIOS or hardware switch control, reduces CPU speed to 8MHz

## Unpacking the Mainboard

The mainboard package contains:

- The 486 PCI/VESA Mainboard
- This User's Guide

*Note: Do not unpack the mainboard until you are ready to install it.*

Follow the precautions below while unpacking the mainboard.

1. Before handling the mainboard, ground yourself by grasping an unpainted portion of the system's metal chassis.
2. Remove the mainboard from its anti-static packaging and place it on a grounded surface, component side up.
3. Check the mainboard for damage. If any chip appears loose, press carefully to seat it firmly in its socket.

Do not apply power if the mainboard appears damaged. If there is damage to the board contact your dealer immediately.

## Electrostatic Discharge Precautions

Make sure you ground yourself before handling the mainboard or other system components. Electrostatic discharge can easily damage the components. Note that you must take special precaution when handling the mainboard in dry or air-conditioned environments.

Take these precautions to protect your equipment from electrostatic discharge:

- Do not remove the anti-static packaging until you are ready to install the mainboard and other system components.
- Ground yourself before removing any system component from its protective anti-static packaging. To ground yourself grasp the expansion slot covers or other unpainted portions of the computer chassis.
- Frequently ground yourself while working, or use a grounding strap.
- Handle the mainboard by the edges and avoid touching its components.

# 2 Hardware Setup



This chapter explains how to configure the mainboard's hardware. After you install the mainboard, you can set jumpers, install memory on the mainboard, and make case connections. Refer to this chapter whenever you upgrade or reconfigure your system.

**CAUTION:** Turn off power to the mainboard, system chassis, and peripheral devices before performing any work on the mainboard or system.

## Jumpers

### JP3: Display Type

Set JP3 to configure the mainboard for use with either a color or monochrome monitor.

Monitor Type	JP3
Monochrome (default)	
EGA/VGA	

## Mainboard Layout

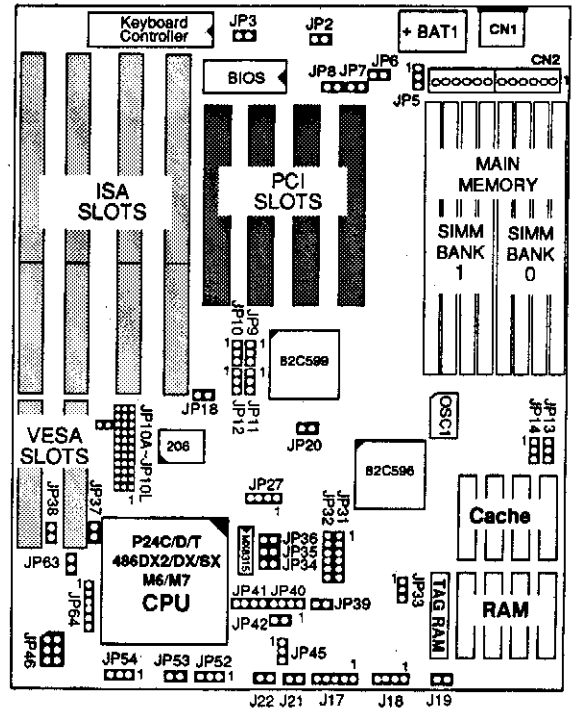



Figure 1-1. Mainboard Layout

## Hardware Setup

### JP5: CMOS Reset Jumper

Jumper JP5 lets you discharge CMOS memory in the event you forget your password or encounter a BIOS Setup problem. Before you install the mainboard make sure that JP5 is set to retain CMOS memory.

CMOS Setting	JP5
Retain CMOS Data	
Discharge CMOS	

### JP2, JP6, JP7, JP8: Monitor Green Function Control

Jumpers JP2, JP6, JP7, and JP8 control external Green function devices, such as video (VSYNC, HSYNC, SYNCEN) or the power supply (GPORT). Polarity of the jumpers is low. The external device you attach must also support Green functions.

Jumper	Function
JP2	GPORT
JP8	VSYNC
JP7	HSYNC
JP6	SYNCEN

**JP20, JP27: PCI Bus Clock Mode**

Jumper JP20 and JP27 set the PCI bus clock mode for either ASYNC mode or SYNC mode.

Clock Mode	JP20	JP27
ASYNC mode		
SYNC mode		

- Note:
- For ASYNC mode the PCI clock = 33MHz  
For SYNC mode the PCI clock = system clock
  - When the system clock equals 50 MHz, you cannot set the PCI clock for ASYNC mode, because PCI does not work at speeds greater than 33 MHz.

**JP42: Berg Jumper (Green Jumper)**

Toggle this jumper to force the system to enter the 8 MHz (Standby) mode. Press any key or move the mouse to wake the system to full speed mode.

Function	JP42
Normal (default)	
Forced into Green function	

**CPU Type Configuration**

Configure the 486 VESA mainboard's CPU by inserting the specified CPU and setting jumpers as described in the diagrams that follow. Note that the CPU

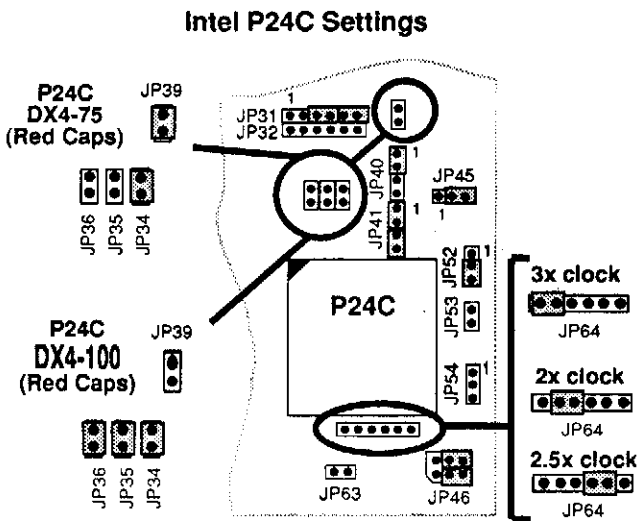

Figure 2-1. Intel P24C CPU Jumper Settings

**WARNING:** JP46 sets the voltage —5V or 3.3V— for the CPU. If you do not set JP46 correctly as shown above, you will damage the CPU. Note that JP46 has green caps.

**VESA Local Bus Configuration**

The 486 PCI/VESA mainboard features two VESA local bus slots that you can configure for a wide range of VESA adapters at different system clock speeds for optimal performance. Jumper JP37 sets the local bus for system clock speeds above or below 33MHz. Jumper JP38 inserts 1 wait-state on the local bus.

**JP37: VESA Local Bus Clock Configuration**

CPU Clock Speed	JP37
Less than or equal to 33MHz	
Greater than 33MHz (default)	

**JP38: VESA Wait State Configuration**

Local Bus Wait States	JP38
0 wait-state	
1 wait-state (default)	

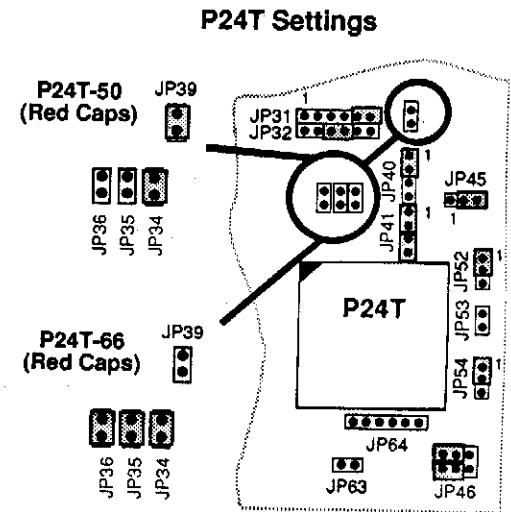

Figure 2-2. P24T CPU Jumper Settings

### P24D Settings

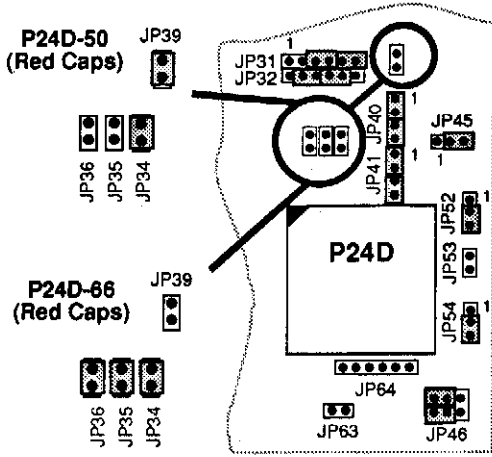

Figure 2-3. P24D CPU Jumper Settings

### Cyrix 486S (M6) Settings

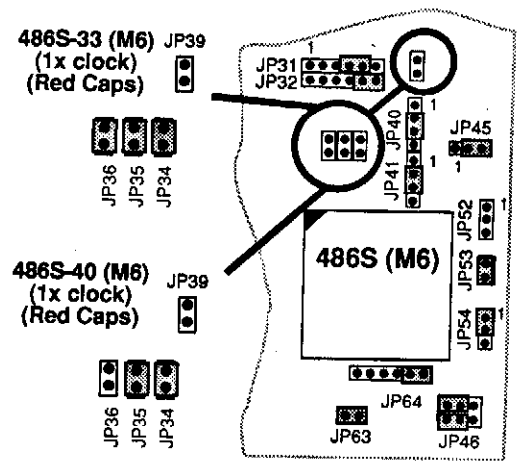

Figure 2-4. Cyrix 486S (M6) Jumper Settings

### Cyrix 486DX (M7) Settings

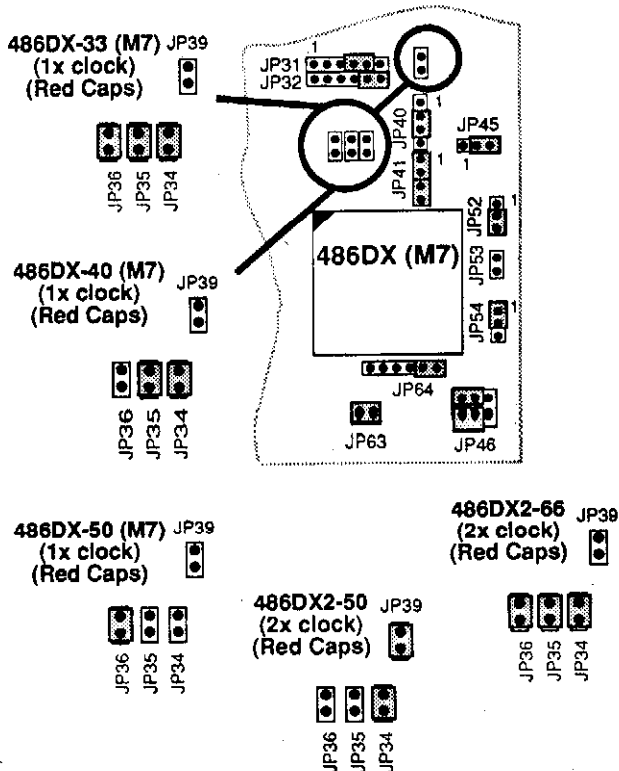

Figure 2-5. Cyrix 486DX (M7) Jumper Settings

### Intel 486SX/SL Settings

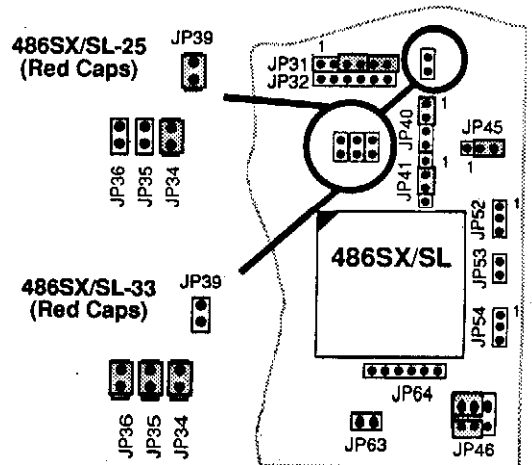

Figure 2-6. Intel 486SX/SL Jumper Settings

Intel 486DX/DX2/SL Settings

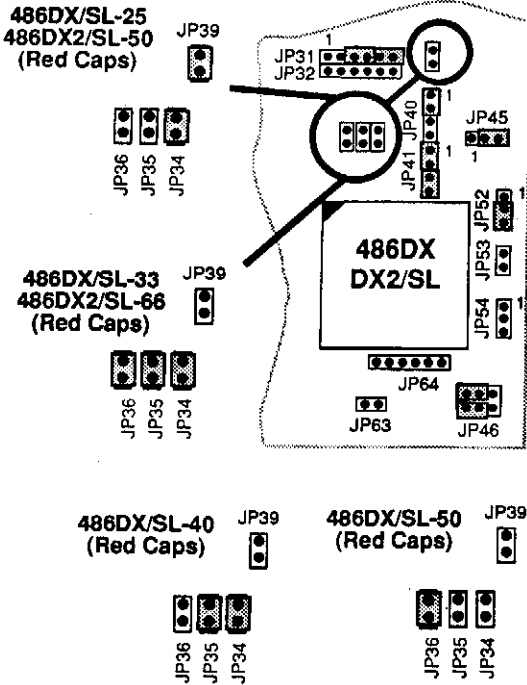

Figure 2-7. Intel 486DX/DX2/SL Jumper Settings

Intel / AMD 486SX Settings

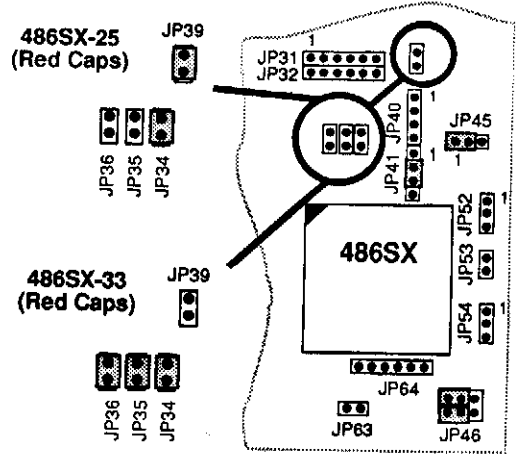

Figure 2-8. Intel/AMD 486SX Jumper Settings

Intel / AMD 486DX/DX2 Settings

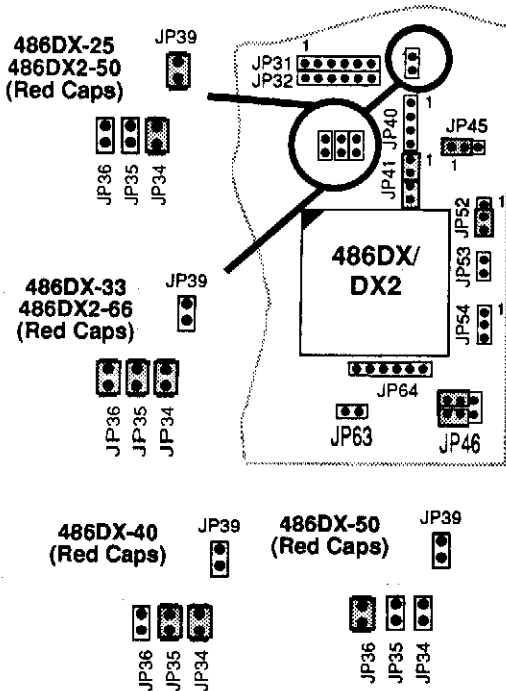

Figure 2-9. Intel/AMD 486DX/DX2 Jumper Settings

PCI Configuration

Two sets of jumpers configure the PCI bus. JP9-JP12 configure the Level/Edge triggers for the PCI slots. Jumpers JP10A-JP10L configure the PCI IRQ Level/Edge Triggers. Set jumpers as described below.

JP9-JP12: PCI Slot Trigger Type Selectors

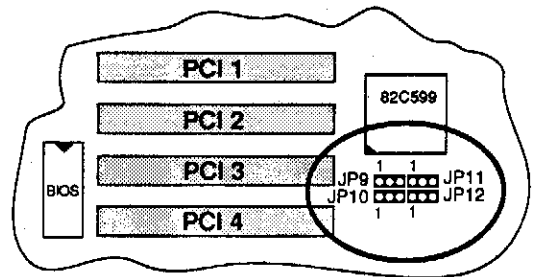

Figure 2-10. PCI Slot Trigger Type Jumper Settings

Jumpers JP9-JP12 let you select the trigger type of each PCI slot. Each jumper corresponds to a PCI slot. Check your interface card to see if the INT Signal is Level Trigger or Edge Trigger and set the jumper of the corresponding PCI slot accordingly. Set jumpers as below.

	PCI 3	PCI 4	PCI 1	PCI 2
	JP9	JP10	JP11	JP12
Level Trigger				
Edge Trigger				

JP10A-JP10L: IRQ Trigger Type Selectors

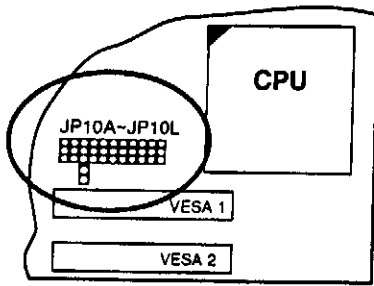

Figure 2-11. IRQ Trigger Type Jumper Settings

Jumpers JP10A-JP10L let you select the trigger type of IRQ numbers used by the PCI slots. Note that PCI 1 has only one setting, which is for IRQ14. Set jumpers as below.

PCI 1 IRQ Setting

IRQ 14 for PCI 1	
Level Trigger	
Edge Trigger	

PCI 2, PCI 3, PCI 4 IRQ Settings

	IRQ 15 for PCI 2, 3, 4	IRQ 14 for PCI 2, 3, 4
Level Trigger		
Edge Trigger		
Level Trigger		
Edge Trigger		
Level Trigger		
Edge Trigger		

	IRQ 7 for PCI 2, 3, 4	IRQ 6 for PCI 2, 3, 4
Level Trigger		
Edge Trigger		
Level Trigger		
Edge Trigger		
Level Trigger		
Edge Trigger		

Cache Configuration

The mainboard has a write-back caching scheme. You can configure the mainboard's cache by installing cache chips in the sockets noted below, and then set jumpers JP13, JP14, and JP33. See Figures 2-12 ~ 2-16 for cache configurations.

Cache Size and RAM Locations

Cache Size	Data RAM	Tag RAM
256KB	32K x 8/ U19-U22, U26-U29	32K x 8/ U30
256KB	64K x 8/ U19-U22	32K x 8/ U30
512KB	128K x 8/ U19-U22	32K x 8/ U30
512KB	64K x 8/ U19-U22, U26-U29	32K x 8/ U30
1MB	128K x 8/ U19-U22, U26-U29	128K x 8/ U30

256K Cache Configuration with 32K x 8

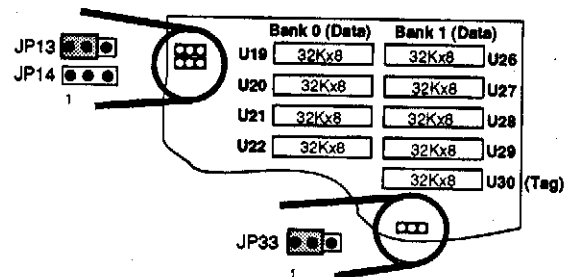

Figure 2-12. 256K Cache Configuration with 32Kx8

Cache Size	Data	Tag	JP13	JP14	JP33
256K	32Kx8	32Kx8	1-2	X	1-2

X = setting doesn't matter

**256K Cache Configuration with 64K x 8**

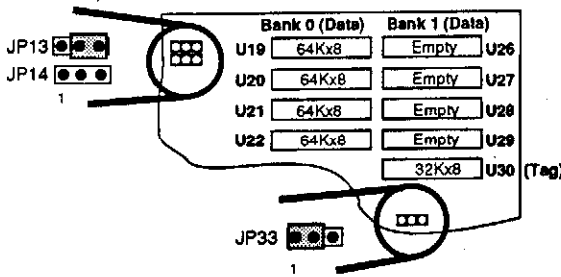

Figure 2-13. 256K Cache Configuration with 64Kx8

Cache Size	Data	Tag	JP13	JP14	JP33
256K	64Kx8	32Kx8	2-3	X	1-2

**512K Cache Configuration with 128K x 8**

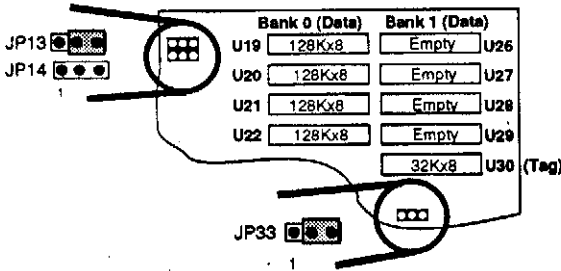

Figure 2-14. 512K Cache Configuration with 128K x 8

Cache Size	Data	Tag	JP13	JP14	JP33
512K	128Kx8	32Kx8	2-3	X	2-3

X = setting doesn't matter

**512K Cache Configuration with 64K x 8**

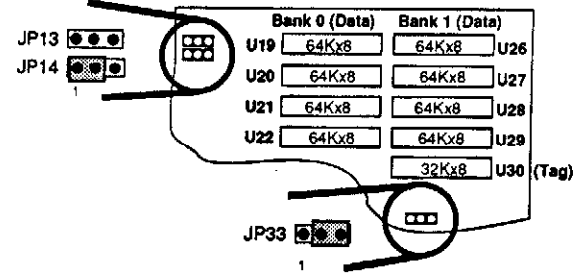

Figure 2-15. 512K Cache Configuration with 64K x 8

Cache Size	Data	Tag	JP13	JP14	JP33
512K	64Kx8	32Kx8	X	1-2	2-3

**1M Cache Configuration with 128K x 8**

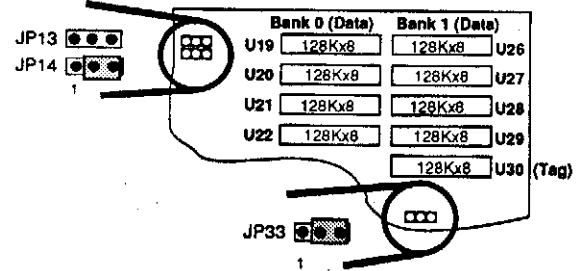

Figure 2-16. 1M Cache Configuration with 128K x 8

Cache Size	Data	Tag	JP13	JP14	JP33
1M	128Kx8	128Kx8	X	2-3	2-3

X = setting doesn't matter

**Connectors**

Attach the 486 PCI/VESA mainboard to case devices, or an external battery, via connectors on the mainboard. Refer to Figure 1-1 for connector locations and connector pin positions.

**CN1- Keyboard Connector**

A five-pin female DIN is located at the rear of the board. Plug the keyboard jack into this connector.

**CN2 - Power Supply Connectors**

The mainboard requires a power supply with at least 200 watts and a "power good" signal. CN2 provides two six-pin male header connectors. Plug the dual connectors from the power directly onto the board connector while making sure the black leads are in the center.

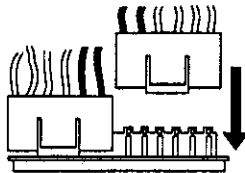

**J17 - Keylock & Power LED Connector**

J17 is a connector for a lock that may be installed on the system case for enabling or disabling the keyboard. J17 also attaches to the case's Power LED.

**J18 - Speaker Connector**

Attach the system speaker to connector J18.

**J19 - Hardware Reset Control**

Attach the Reset switch to J19. Closing the Reset switch restarts the system.

**J20 - External Battery Connector**

J20 is a 4-pin connector to which you can attach an external battery. Pin 1 of J20 is positive (+) and pin 4 is negative (-).

**J21 - Turbo Switch Connector**

J21 is connected to a Turbo switch on the front of the system case. Open the connector's pins 1-2 for turbo operation. Short pins 1-2 for normal operation.

**J22 - Turbo LED Connector**

J22 connects to a Turbo LED on the case control panel and works with the Turbo Switch. If the mainboard is in Turbo mode, the Turbo LED lights.

**JP18 - Green LED Connector**

JP18 connects to a Green LED on the system case. If the mainboard is in Green mode, the Green LED lights.



### Memory Configuration

The 486 PCI/VESA mainboard lets you increase the system's main memory via on-board SIMM (Single In-line Memory Modules) sockets. The mainboard supports two banks of 256K, 1M, 4M or 16M SIMM. The mainboard requires SIMM of at least 80ns access time.

On-board memory is located in two banks: Bank 0 and Bank 1. See Figure 1-1, four SIMM sockets are provided in each bank. You can install either a 256K, 1M, or a 4M SIMM in each socket.

The mainboard supports the following configurations:

Memory Size	Bank 0	Bank 1
1 MB	256K	—
2 MB	256K	256K
4 MB	1M	—
5 MB	256K	1M
8 MB	1M	1M
16 MB	4M	—
17 MB	256K	4M
20 MB	1M	4M
32 MB	4M	4M
64 MB	16M	—
80 MB	4M	16M
128 MB	16M	16M

Table 2-1. On-board Memory Configurations

## 3 BIOS Setup

The mainboard's BIOS setup program is the ROM PCI/ISA BIOS from Award Software Inc. Enter the Award BIOS program's Main Menu as follows:

1. Turn on or reboot the system. After a series of diagnostic checks, you are asked to press DEL to enter Setup.
2. Press the <DEL> key to enter the Award BIOS program and the main screen appears:

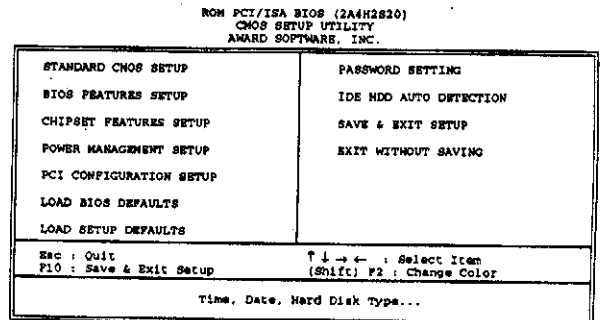

3. Choose an option and press <Enter>. Modify the system parameters to reflect the options installed in the system. (See the following sections.)
4. Press <ESC> at anytime to return to the Main Menu.
5. In the Main Menu, choose "SAVE AND EXIT SETUP" to save your changes and reboot the system. Choosing "EXIT WITHOUT SAVING" ignores your changes and exits the program.

The Main Menu options of the Award BIOS are described in the sections that follow.

### Standard CMOS Setup

Run the Standard CMOS Setup as follows.

1. Choose "STANDARD CMOS SETUP" from the Main Menu. A screen appears.

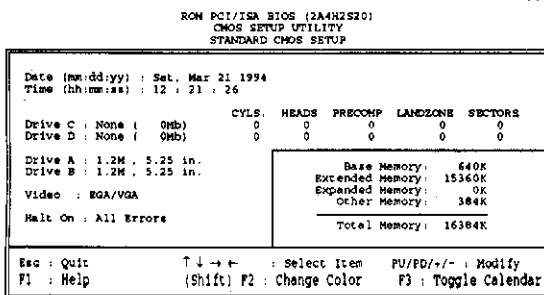

2. Use arrow keys to move between items and select values. Modify selected fields using PgUp/PgDn/+/- keys. Some fields let you enter values directly.

- Date (mm/dd/yy)** Type the current date.
- Time (hh:mm:ss)** Type the current time.
- Drive C & D** Choose from the standard hard disk types 1 to 46. Type 47 is user definable. If a hard disk is not installed choose "Not installed." (default)
- Drive A & B** Choose 360KB, 5 1/4", 1.2MB, 5 1/4" (default), 720KB, 3 1/2", 1.4M, 3 1/2", 2.88 MB, 3 1/2" or Not installed
- Video** Choose Monochrome, (default) Color 40x25, VGA/EGA Color 80x25

3. When you finish, press the <ESC> key to return to the Main Menu.

### BIOS Features Setup

Run the BIOS Features Setup as follows.

1. Choose "BIOS FEATURES SETUP" from the Main Menu and a screen with a list of items appears. (The screen below shows the BIOS default settings.)

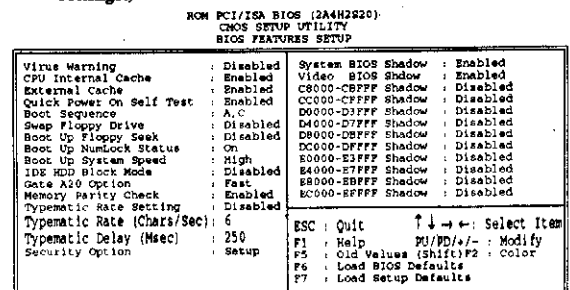

2. Use the arrow keys to move between items and to select values. Modify the selected fields using the PgUp/PgDn/+/- keys. <F> keys are explained below:

- <F1>: "Help" gives options available for each item.
- Shift <F2>: Change color.
- <F5>: Get the old values. These values are the values with which the user started the current session.
- <F6>: Load all options with the BIOS Setup default values.
- <F7>: Load all options with the Power-On default values.

A short description of screen items follows:

- Virus Warning** Enable this option and a warning appears when the system detects a virus. (The Default setting is Disabled.)
- CPU Internal Cache** This option enables/disables the CPU's internal cache. (The Default setting is Enabled.)
- External Cache** This option enables/disables the external cache memory. (The Default setting is Enabled.)
- Quick Power On Self Test** Enabled provides a fast POST at boot-up.
- Boot Sequence** The default setting attempts to first boot from drive A: and then from hard disk C:. You can reverse this sequence with "C: A:", but then drive A: cannot boot directly.
- Swap Floppy Drive** Enabled changes the sequence of the A: and B: drives. (The Default setting is Disabled.)
- Boot Up Floppy Seek** Choose Enabled or Disabled. "Disabled" provides a fast boot and reduces the possibility of damage to the heads.
- Boot Up Num Lock Status** Choose On or Off. On puts numeric keypad in Num Lock mode at boot-up. Off puts this keypad in arrow key mode at boot-up.
- Boot Up System Speed** Choose High or Low for the speed of system boot up.
- IDD HDD Block Mode** This option enables/disables the IDD HDD Block Mode function. Not all HDDs support this function.
- Memory Parity Check** This option enables/disables the Memory Parity Check function. (The Default setting is Enabled.)
- Typematic Rate Setting** Enable this option to adjust the keystroke repeat rate.

- Typematic Rate (Chars/Sec)** Choose the rate a character keeps repeating.
  - Typematic Delay (Msec)** Choose how long after you press a key that a character begins repeating.
  - Security Option** Choose Setup or System. Use this feature to prevent unauthorized system boot-up or use of BIOS Setup.
    - "System" - Each time the system is booted the password prompt appears.
    - "Setup" - If a password is set, the password prompt only appears if you attempt to enter the Setup program.
  - System BIOS Shadow** If enabled and BIOS is present in this segment, then system BIOS (64K) is shadowed.
  - Video or Adaptor BIOS Shadow** BIOS shadow copies BIOS code from slower ROM to faster RAM. BIOS can then execute from RAM. These 32K segments can be shadowed from ROM to RAM. BIOS is shadowed in a 32K segment if it is enabled and it has BIOS present.
3. After you have finished with the BIOS Features Setup program, press the <ESC> key and follow the screen instructions to save or disregard your settings.

### Chipset Features Setup

The Chipset Features Setup option changes the values of the chipset registers. These registers control system options in the computer.

*Note:* Change these settings only if you are familiar with the PCI Chipset.

Run the Chipset Features Setup as follows.

1. Choose "CHIPSET FEATURES SETUP" from the Main Menu and the following screen appears. (The screen below shows default settings.)

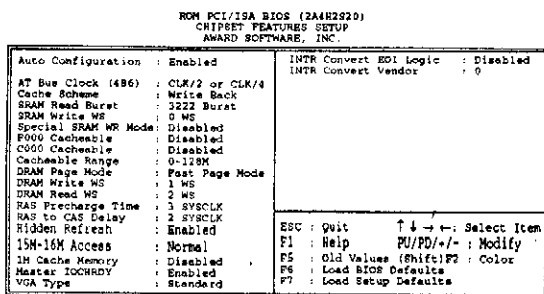

2. Use the arrow keys to move between items and select values. Modify selected fields using the PgUp/PgDn/+/- keys.
 

Refer to the recommended Settings shown in Table 3-1 on the following page.
3. After you have finished with the Chipset Features Setup, press the <ESC> key and follow the screen instructions to save or disregard your settings.

Table 3-1. Recommended Settings for Chipset Features Setup

	486SX/DX-25 486DX2-50 P24D-50 P24T-50 Cx 486S2-40/50 Cx 486DX2-50 P24C-75	486SX/DX-33 486DX2-66 P24D-66 P24T-66 Cx 486S-33 Cx 486DX-33 Cx 486DX2-66 P24C-100	486DX-40 Cx 486S-40 Cx 486DX-40	486DX-50 Cx 486DX-50
<b>AT Bus Clock</b>	CLK/3 or CLK/6	CLK/2 or CLK/4	CLK/2.5 or CLK/5	CLK/3 or CLK/6
<b>SRAM Read Burst</b>	3111 Burst	3222 Burst	3222 Burst	3222 Burst
<b>SRAM Write WS</b>	0 WS	0 WS	1 WS	1 WS
<b>DRAM Write WS</b>	0 WS	1 WS	1 WS	1 WS
<b>DRAM Read WS</b>	1 WS	2 WS	3 WS	3 WS
<b>RAS Precharge Time</b>	3 SYSCLK	3 SYSCLK	3 SYSCLK	3 SYSCLK
<b>RAS TO CAS Delay</b>	1 SYSCLK	2 SYSCLK	2 SYSCLK	2 SYSCLK

## Power Management Setup

The Power Management Setup option lets you set the system's power saving functions.

Run the Power Management Setup as follows.

1. Choose "POWER MANAGEMENT SETUP" from the Main Menu and a screen with a list of items appears.

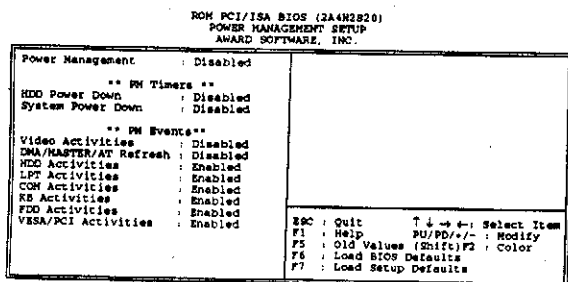

2. Use the arrow keys to move between items and to select values. Modify the selected fields using the PgUp/PgDn/+/- keys.

A short description of selected screen items follows:

**Power Management** Options are as follows:

- User Define** Let's you define the HDD and system power down times.
- Disabled** Disables the Green PC Features.
- Min Saving** Sets HDD Power Down = 15 Min  
System Power Down = 260 Min
- Max Saving** Sets HDD Power Down = 1 Min  
System Power Down = 30 Sec

## PCI Configuration Setup

This option sets the mainboard's PCI Slots. Run this option as follows:

1. Choose "PCI CONFIGURATION SETUP" from the Main Menu and the following screen appears. (The screen below shows default settings.)

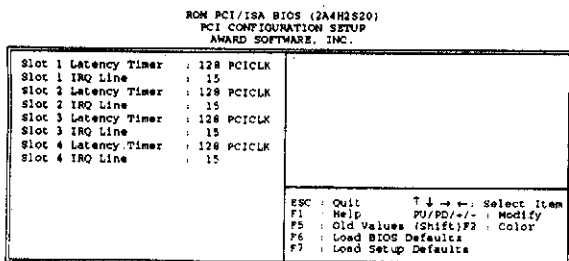

2. Use the arrow keys to move between items and select values. Modify selected fields using the PgUp/PgDn/+/- keys.
3. After you have finished with the Chipset Features Setup, press the <ESC> key and follow the screen instructions to save or disregard your settings.

## Load BIOS Defaults

This Main Menu item loads the BIOS default system values. Choose this item and the following message appears:

"Load BIOS Defaults (Y/N)? N"

To use the BIOS defaults, change the prompt to "Y" and press <Enter>.

## Load Setup Defaults

This item loads the system values you have previously saved. Choose this item and the following message appears:

"Load SETUP Defaults (Y/N)? N"

To use the SETUP defaults, change the prompt to "Y" and press <Enter>.

**HDD Power Down** When the Power Management option is set to **User Define**, you can set hard disk power down times from 1 ~ 15 min. (Your HDD must have Green function to use this feature.)

**System Power Down** When the Power Management option is set to **User Define** you can set times from 30 sec ~ 260 min. If no activity occurs during the time you set, the system powers down to 8 MHz.

**PM Events** Choose which events enable PM modes. Enable an item to cause the system to enter power down/ wakeup modes.

3. After you have finished with the Power Management Setup, press the <ESC> key to return to the Main Menu.

## Password Setting

This Main Menu item lets you configure the system so that a password is required every time the system boots or an attempt is made to enter the Setup program. Change the password as follows:

1. Choose "PASSWORD SETTING" in the Main Menu and press <Enter>. The following message appears:

"Enter Password:"

2. Enter a password and press <Enter>.

(If you do not wish to use the password function, you can just press <Enter> and a "Password disabled" message appears.)

3. After you enter your password, the following message appears prompting you to confirm the new password:

"Confirm Password:"

4. Re-enter your password and then Press <ESC> to exit to the Main Menu.

**Important:** If you forget or lose the password, the only way to access the system is to set jumper J5 to clear the CMOS RAM. All setup information is lost and you must run the BIOS setup program again.

## IDE HDD Auto Detection

This Main Menu item automatically detects the hard disk type and configures the STANDARD CMOS SETUP accordingly.

*Note:* This function is only valid for IDE hard disks.

