



System Board User's Manual

Copyright

This publication contains information that is protected by copyright. No part of it may be reproduced in any form or by any means or used to make any transformation/adaptation without the prior written permission from the copyright holders.

This publication is provided for informational purposes only. The manufacturer makes no representations or warranties with respect to the contents or use of this manual and specifically disclaims any express or implied warranties of merchantability or fitness for any particular purpose. The user will assume the entire risk of the use or the results of the use of this document. Further, the manufacturer reserves the right to revise this publication and make changes to its contents at any time, without obligation to notify any person or entity of such revisions or changes.

© 2004. All Rights Reserved.

Trademarks

Windows® 2000, Windows NT® 4.0 and Windows® XP are registered trademarks of Microsoft Corporation. Intel® and Pentium® 4 are registered trademarks of Intel Corporation. Award is a registered trademark of Award Software, Inc. Other trademarks and registered trademarks of products appearing in this manual are the properties of their respective holders.

Caution

To avoid damage to the system:

- Use the correct AC input voltage range.

To reduce the risk of electric shock:

- Unplug the power cord before removing the system chassis cover for installation or servicing. After installation or servicing, cover the system chassis before plugging the power cord.

Battery:

- Danger of explosion if battery incorrectly replaced.
- Replace only with the same or equivalent type recommend by the manufacturer.
- Dispose of used batteries according to the battery manufacturer's instructions.

FCC and DOC Statement on Class B

This equipment has been tested and found to comply with the limits for a Class B digital device, pursuant to Part 15 of the FCC rules. These limits are designed to provide reasonable protection against harmful interference when the equipment is operated in a residential installation. This equipment generates, uses and can radiate radio frequency energy and, if not installed and used in accordance with the instruction manual, may cause harmful interference to radio communications. However, there is no guarantee that interference will not occur in a particular installation. If this equipment does cause harmful interference to radio or television reception, which can be determined by turning the equipment off and on, the user is encouraged to try to correct the interference by one or more of the following measures:

- Reorient or relocate the receiving antenna.
- Increase the separation between the equipment and the receiver.
- Connect the equipment into an outlet on a circuit different from that to which the receiver is connected.
- Consult the dealer or an experienced radio TV technician for help.

Notice:

1. The changes or modifications not expressly approved by the party responsible for compliance could void the user's authority to operate the equipment.
2. Shielded interface cables must be used in order to comply with the emission limits.

About this Manual

This user's manual contains detailed information about the system board. If, in some cases, some information doesn't match those shown in the multilingual manual, the multilingual manual should always be regarded as the most updated version. The multilingual manual is included in the system board package.

To view the user's manual, insert the CD into a CD-ROM drive. The autorun screen (Mainboard Utility CD) will appear. Click the "TOOLS" icon then click "Manual" on the main menu.

Notice

The system board and accessories you receive in the package may not come similar to the information stated in this manual. This may differ in accordance to the sales region or models in which it was sold. For more information about the standard package in your region, please contact your dealer or sales representative.

Table of Contents

Chapter 1 - Introduction

1.1	Specifications.....	7
1.2	Special Features of the System Board.....	10
1.3	Package Checklist.....	15

Chapter 2 - Hardware Installation

2.1	System Board Layout	16
2.2	System Memory.....	17
2.3	CPU.....	22
2.4	Jumper Settings.....	28
2.5	Rear Panel I/O Ports.....	33
2.6	I/O Connectors.....	43

Chapter 3 - Award BIOS Setup Utility

3.1	The Basic Input/Output System.....	59
3.2	Intel ICH6R BIOS Setting Utility.....	105
3.3	Updating the BIOS.....	106

Chapter 4 - Supported Softwares

4.1	Desktop Management Interface.....	108
4.2	Drivers, Utilities and Software Applications.....	111
4.3	Installation Notes.....	120

Appendix A - Enabling the Hyper-Threading Technology

A.1 Enabling the Hyper-Threading Technology.....	121
--	-----

Appendix B - System Error Messages

B.1 POST Beep.....	124
B.2 Error Messages.....	124

Appendix C - Troubleshooting

C.1 Troubleshooting Checklist.....	126
------------------------------------	-----

Chapter I - Introduction

I.1 Specifications

Processor

- Intel® Pentium® 4 Prescott processor
 - Hyper-Threading Technology
 - 800MT/s (200MHz) system bus interface
- Socket LGA 775 (LAN Grid Array)

Chipset

- Intel® 925X chipset
 - Intel® 925X Memory Controller Hub (MCH)
 - Intel® 82801FR I/O Controller Hub (ICH6R)

System Memory

- Four 240-pin DDR2 DIMM sockets
- Supports dual channel (128-bit wide) memory interface
- Supports up to 4GB system memory
- Supports DDR2 400 and DDR2 533 DIMMs
- Supports ECC (x8) only or non-ECC x8 and x16 DIMMs
- Support for 256Mb and 512Mb DRAM densities
- Supports Performance Acceleration Technology
- Supports unbuffered DIMMs

BIOS

- Award BIOS
- Genie BIOS provides:
 - CPU/DRAM overlocking
 - CPU/NB/DRAM overvoltage
- Supports SCSI sequential boot-up
- Supports DMI 2.0 function
- 4Mbit flash memory

Energy Efficient Design

- Supports ACPI specification and OS Directed Power Management
- Supports ACPI STR (Suspend to RAM) function

- Wake-On-Events include:
 - Wake-On-PS/2 Keyboard/Mouse
 - Wake-On-USB Keyboard/Mouse
 - Wake-On-Ring (external modem)
 - Wake-On-LAN
 - RTC timer to power-on the system
- AC power failure recovery

Hardware Monitor

- Monitors CPU/system temperature and overheat alarm
- Monitors 12V/5V/3.3V/Vcore/Vbat/5Vsb/3.3Vsb voltages
- Monitors the speed of the CPU/system fan
- CPU Overheat Protection function monitors CPU temperature and fan during system boot-up - automatic shutdown upon system overheat

Onboard Audio Features

- Azalia audio codec with independent variable sampling rate
- True stereo line level outputs
- S/PDIF-in/out interface
- 8-channel audio output

Onboard LAN Features

- Gigabit ethernet controllers - Marvell 88E8053 PCI Express and Marvell 88E8001 PCI
- Integrated power management functions
- Full duplex support at both 10 Mbps, 100 Mbps and 1 Gbps
- Supports IEEE 802.3u auto-negotiation
- Supports wire for management

Serial ATA Interface with RAID

- Supports four SATA (Serial ATA) interfaces which are compliant with SATA 1.0 specification (1.5Gbps interface)
- Supports RAID 0, RAID 1 and JBOD

IEEE 1394 Interface

- Supports two 100/200/400 Mb/sec ports

IDE Interface

- Supports ATA/33, ATA/66 and ATA/100 hard drives

Rear Panel I/O Ports

- 1 mini-DIN-6 PS/2 mouse port
- 1 mini-DIN-6 PS/2 keyboard port
- 2 S/PDIF RCA jacks (S/PDIF-in and S/PDIF-out)
- Karajan audio card (6 audio jacks)
- 1 IEEE 1394 port
- 2 RJ45 LAN ports
- 6 USB 2.0/1.1 ports

I/O Connectors

- 1 connector for 2 additional external USB 2.0/1.1 ports
- 1 connector for 1 external IEEE 1394 port
- 1 connector for 1 external serial port
- 1 front audio connector for external line-out and mic-in jacks
- 1 CD-in internal audio connector
- 1 S/PDIF connector for optical cable connection
- 1 IR connector
- 1 CIR connector
- 4 Serial ATA connectors
- 1 IDE connector
- 1 floppy connector
- 2 ATX power supply connectors
- 5 fan connectors
- 4 diagnostic LEDs
- 1 diagnostic LED connector for external 4 diagnostic LEDs display
- EZ touch switches (power switch and reset switch)

Expansion Slots

- 1 PCI Express x16 slot
- 3 PCI Express x1 slots
- 3 PCI slots

Compatibility

- PCI 2.2 and Azalia compliant

PCB

- 6 layers, ATX form factor
- 24.5cm (9.64") x 30.5cm (12")

I.2 Special Features of the System Board

PCI Express

PCI Express is a high bandwidth I/O infrastructure that possesses the ability to scale speeds by forming multiple lanes. The system board currently supports the physical layer of x1 and x16 lane widths.

The x1 PCI Express lane supports transfer rate of 2.5 Gigabytes (250MBbps) per second. The PCI Express architecture also provides a high performance graphics infrastructure by doubling the capability of the existing AGP 8x designs over a x16 PCI Express lane that provides 4 Gigabytes per second transfer rate.

Hyper-Threading Technology Functionality Requirements

The system board supports Intel processors with Hyper-Threading Technology. Enabling the functionality of Hyper-Threading Technology for your computer system requires **ALL** of the following platforms.

Components:

- CPU - an Intel® Pentium® 4 Processor with HT Technology
- Chipset - an Intel® chipset that supports HT Technology
- BIOS - a BIOS that supports HT Technology and has it enabled
- OS - an operating system that includes optimizations for HT Technology

Please refer to Appendix A for information about enabling the functionality of the Hyper-Threading Technology. For more information on Hyper-Threading Technology, go to: www.intel.com/info/hyperthreading.

Performance Acceleration Technology (PAT)

PAT performs data transactions directly from the CPU to the system memory, bypassing the normal path of operation. This reduces the MCH timing therefore providing improved system performance.

CPU Overheat Protection

CPU Overheat Protection has the capability of monitoring the CPU's temperature during system boot up. Once the CPU's temperature exceeded the temperature limit pre-defined by the CPU, the system will automatically shutdown. This preventive measure has been added to protect the CPU from damage and insure a safe computing environment.

DDR2

DDR2 is a higher performance DDR technology whose data transfer rate delivers bandwidth of 4.3 GB per second and beyond. That is twice the speed of the conventional DDR without increasing its power consumption. DDR2 SDRAM modules work at 1.8V supply compared to 2.6V memory voltage for DDR modules. DDR2 also incorporates new innovations such as the On-Die Termination (ODT) as well as larger 4-bit pre-fetch against DDR which fetches 2 bits per clock cycle.

CMOS Reloaded

CMOS Reloaded is a technology that allows storing multiple user-defined BIOS settings by using the BIOS utility to save, load and name the settings. This is especially useful to overclockers who require saving a variety of overclocked settings and being able to conveniently switch between these settings simultaneously.

Karajan Audio Card

The Karajan audio add-in card at the rear I/O panel supports 8-channel audio output via the audio jacks on the card.

S/PDIF

S/PDIF is a standard audio file transfer format that transfers digital audio signals to a device without having to be converted first to an analog format. This prevents the quality of the audio signal from degrading whenever it is converted to analog. S/PDIF is usually found on digital audio equipment such as a DAT machine or audio processing device. The S/PDIF connector on the system board sends surround sound and 3D audio signal outputs to amplifiers and speakers and to digital recording devices like CD recorders.

Serial ATA Interface with RAID

Serial ATA is a storage interface that is compliant with SATA 1.0 specification. With speed of up to 1.5Gbps, it improves hard drive performance faster than the standard parallel ATA whose data transfer rate is 100MB/s. The system board allows configuring RAID on SATA drives. It supports RAID 0, RAID 1 and JBOD.

IEEE 1394 Interface

IEEE 1394 is fully compliant with the 1394 OHCI (Open Host Controller Interface) 1.1 specification. It supports up to 63 devices that can run simultaneously on a system. 1394 is a fast external bus standard that supports data transfer rates of up to 400Mbps. In addition to its high speed, it also supports isochronous data transfer which is ideal for video devices that need to transfer high levels of data in real-time. 1394 supports both Plug-and-Play and hot plugging.

IrDA Interface

The system board is equipped with an IrDA connector for wireless connectivity between your computer and peripheral devices. The IRDA (Infrared Data Association) specification supports data transfers of 115K baud at a distance of 1 meter.

USB Ports

The system board supports USB 2.0 and USB 1.1 ports. USB 1.1 supports 12Mb/second bandwidth while USB 2.0 supports 480Mb/second bandwidth providing a marked improvement in device transfer speeds between your computer and a wide range of simultaneously accessible external Plug and Play peripherals.

Dual Function Power Button

Depending on the setting in the “Soft-Off By PWR-BTTN” field of the Power Management Setup, this switch will allow the system to enter the Soft-Off or Suspend mode.

Wake-On-Ring

This feature allows the system that is in the Suspend mode or Soft Power Off mode to wake-up/power-on to respond to calls coming from an external modem or respond to calls from a modem PCI card that uses the PCI PME (Power Management Event) signal to remotely wake up the PC.



Important:

If you are using a modem add-in card, the 5VSB power source of your power supply must support a minimum of $\geq 720\text{mA}$.

Wake-On-LAN

This feature allows the network to remotely wake up a Soft Power Down (Soft-Off) PC. It is supported via the onboard LAN port or via a PCI LAN card that uses the PCI PME (Power Management Event) signal. However, if your system is in the Suspend mode, you can power-on the system only through an IRQ or DMA interrupt.



Important:

The 5VSB power source of your power supply must support $\geq 720\text{mA}$.

Wake-On-PS/2 Keyboard/Mouse

This function allows you to use the PS/2 keyboard or PS/2 mouse to power-on the system.



Important:

The 5VSB power source of your power supply must support $\geq 720\text{mA}$.

Wake-On-USB Keyboard/Mouse

This function allows you to use a USB keyboard or USB mouse to wake up a system from the S3 (STR - Suspend To RAM) state.

**Important:**

- *If you are using the Wake-On-USB Keyboard/Mouse function for 2 USB ports, the 5VSB power source of your power supply must support $\geq 1.5A$.*
- *If you are using the Wake-On-USB Keyboard/Mouse function for 3 or more USB ports, the 5VSB power source of your power supply must support $\geq 2A$.*

RTC Timer to Power-on the System

The RTC installed on the system board allows your system to automatically power-on on the set date and time.

ACPI STR

The system board is designed to meet the ACPI (Advanced Configuration and Power Interface) specification. ACPI has energy saving features that enables PCs to implement Power Management and Plug-and-Play with operating systems that support OS Direct Power Management. Currently, only Windows® 2000/XP supports the ACPI function. ACPI when enabled in the Power Management Setup will allow you to use the Suspend to RAM function.

With the Suspend to RAM function enabled, you can power-off the system at once by pressing the power button or selecting “Standby” when you shut down Windows® 2000/XP without having to go through the sometimes tiresome process of closing files, applications and operating system. This is because the system is capable of storing all programs and data files during the entire operating session into RAM (Random Access Memory) when it powers-off. The operating session will resume exactly where you left off the next time you power-on the system.

**Important:**

The 5VSB power source of your power supply must support $\geq 1A$.

AC Power Failure Recovery

When power returns after an AC power failure, you may choose to either power-on the system manually, let the system power-on automatically or return to the state where you left off before power failure occurs.

I.3 Package Checklist

- ☑ One LANPARTY 925X-T2 system board
- ☑ One Karajan audio card
- ☑ One Serial ATA to Parallel ATA adapter module
- ☑ One Serial ATA power cable for the adapter module
- ☑ One IDE round cable
- ☑ One floppy round cable
- ☑ Two Serial ATA data cables
- ☑ One Serial ATA power cable
- ☑ One card-edge bracket mounted with a DB-9 serial port
- ☑ One I/O shield
- ☑ One I/O shield label sticker
- ☑ One thermal paste
- ☑ One PC Transpo kit
- ☑ One FrontX device equipped with:
 - 4 diagnostic LEDs
 - 1 S/PDIF-out jack
 - 1 mini 1394 port
 - 1 Serial ATA port
- ☑ One LANPARTY sticker
- ☑ One case badge
- ☑ One UV sleeve
- ☑ One "Intel ICH6R RAID Driver" diskette
- ☑ One "Mainboard Utility" CD
- ☑ One LANPARTY 925X-T2 User's Manual
- ☑ One LANPARTY Features User's Manual
- ☑ One LANPARTY 925X-T2 Quick Installation Guide
- ☑ One CMOS Reloaded User Guide

If any of these items are missing or damaged, please contact your dealer or sales representative for assistance.

Please refer to the LANPARTY Features manual for more information on the FrontX device.

Chapter 2 - Hardware Installation

2.1 System Board Layout

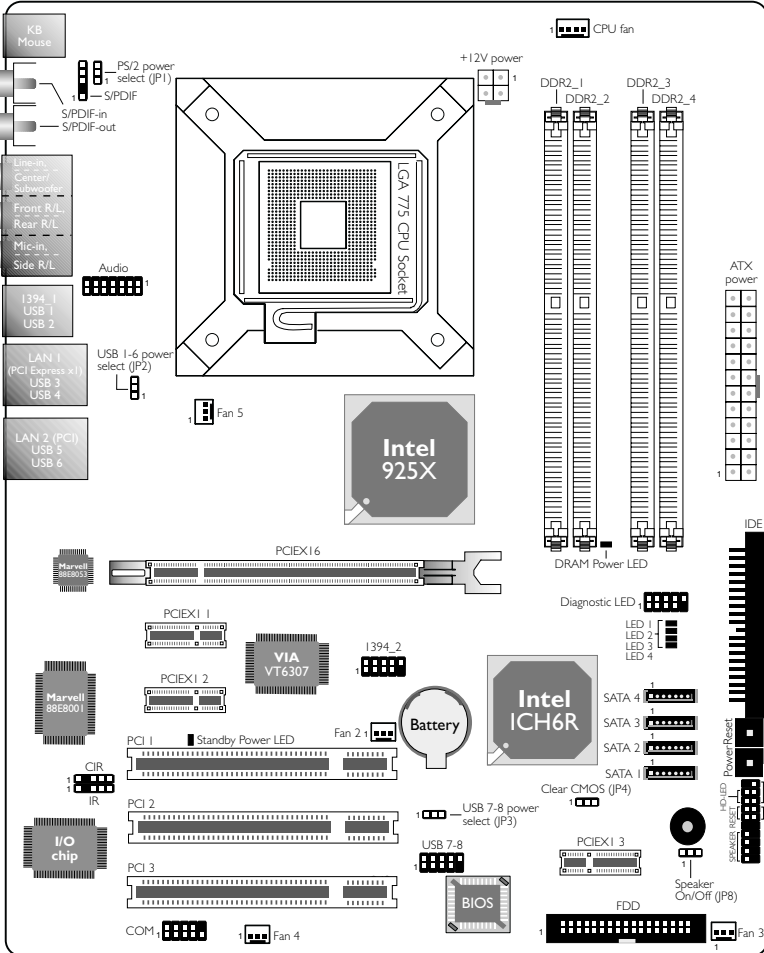

**Warning:**

Electrostatic discharge (ESD) can damage your system board, processor, disk drives, add-in boards, and other components. Perform the upgrade instruction procedures described at an ESD workstation only. If such a station is not available, you can provide some ESD protection by wearing an antistatic wrist strap and attaching it to a metal part of the system chassis. If a wrist strap is unavailable, establish and maintain contact with the system chassis throughout any procedures requiring ESD protection.

2.2 System Memory

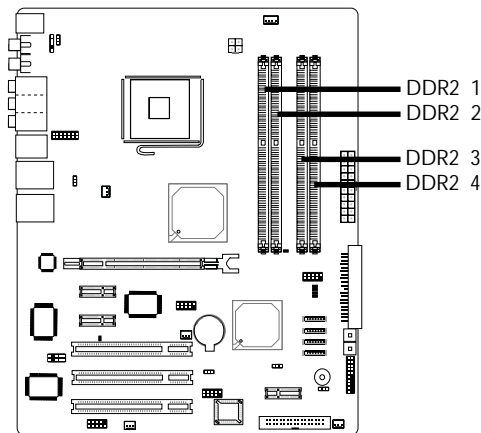

The system board supports 240-pin DDR2 DIMM sockets. The four DDR2 DIMM sockets on the system board are divided into 2 channels:

Channel A - DDR2 1 and DDR2 2

Channel B - DDR2 3 and DDR2 4

The system board supports the following memory interface.

Single Channel (SC)

Data will be accessed in chunks of 64 bits (8B) from the memory channels.

Virtual Single Channel (VSC)

If both channels are populated with different memory configurations, the MCH defaults to Virtual Single Channel.

Dual Channel (DC)

Dual channel provides better system performance because it doubles the data transfer rate.

Dynamic Mode Addressing

This mode minimizes the overhead of opening/closing pages in memory banks allowing for row switching to be done less often.

Single Channel	DIMMs are on the same channel. DIMMs in a channel can be identical or completely different. Not all slots need to be populated.
Virtual Single Channel	DIMMs of different memory configurations are on different channels. Odd number of slots can be populated.
Dual Channel	DIMMs of the same memory configuration are on different channels.
Dynamic Mode Addressing	In single channel, requires even number or rows (side of the DIMM) populated. This mode can be enabled with 1 SS, 2 SS or 2 DS.
	In VSC mode, both channels must have identical row structure.

BIOS Setting

Configure the system memory in the Advanced Chipset Features submenu of the BIOS.

The table below lists the various optimal operating modes that should be configured for the memory channel operation.

Config	DDR2 1	DDR2 2	DDR2 3	DDR2 4
No memory	E	E	E	E
Single channel A	P	E	E	E
Single channel A	P	P	E	E
Single channel A	E	P	E	E
Single channel B	E	E	P	E
Single channel B	E	E	P	P
Single channel B	E	E	E	P
Virtual single channel	E	P(**)	E	P(**)
Virtual single channel	E	P	P	E
Virtual single channel	E	P(**)	P	P(**)
Virtual single channel	P	E	E	P
Virtual single channel	P(**)	E	P(**)	E
Virtual single channel	p(**)	E	P(**)	P
Virtual single channel	P	P(**)	E	P(**)
Virtual single channel	P(**)	P	P(**)	E
Virtual single channel	P(**)	P(**)	P(**)	P(**)
Dual channel	E	P(*) (2,4)	E	P(*) (2,4)
Dual channel	P(*) (1,3)	E	P(*) (1,3)	E
Dual channel	P(*) (1,3)	P(*) (2,4)	P(*) (1,3)	P(*) (2,4)

Continued on the next page...

Config	DDR2 1	DDR2 2	DDR2 3	DDR2 4
Dynamic Mode Addressing	E	P(*) (2,4) DS	E	P(*) (2,4) DS
Dynamic Mode Addressing	P(*) (1,3) DS	E	P(*) (1,3) DS	E
Dynamic Mode Addressing	P(*) (1,3) DS	P(*) (2,4) DS	P(*) (1,3) DS	P(*) (2,4) DS
Dynamic Mode Addressing	E	P(*) (2,4) SS	E	P(*) (2,4) SS
Dynamic Mode Addressing	P(*) (1,3) SS	E	P(*) (1,3) SS	E
Dynamic Mode Addressing	P(*) (1,3) SS	P(*) (2,4) SS	P(*) (1,3) SS	P(*) (2,4) SS

P - denotes populated

E - denotes empty

* - denotes DIMMs are identical

** - denotes DIMMs are not identical

SS - denotes Single Sided DIMM

DS - denotes Double Sided DIMM

1, 2, 3 or 4 - denotes the DDR DIMM slot

2.2.1 Installing the DIM Module

A DIM module simply snaps into a DIMM socket on the system board. Pin 1 of the DIM module must correspond with Pin 1 of the socket.

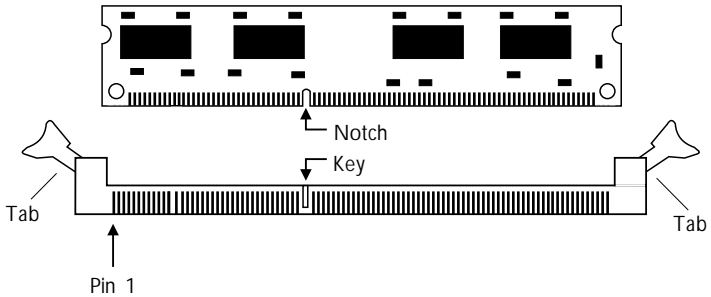

1. Pull the “tabs” which are at the ends of the socket to the side.
2. Position the DIMM above the socket with the “notch” in the module aligned with the “key” on the socket.
3. Seat the module vertically into the socket. Make sure it is completely seated. The tabs will hold the DIMM in place.

2.3 CPU

2.3.1 Overview

The system board is equipped with a surface mount LGA 775 socket. This socket is exclusively designed for installing a LGA 775 packaged Prescott CPU.

2.3.2 Installing the CPU

1. Make sure the PC and all other peripheral devices connected to it has been powered down.
2. Disconnect all power cords and cables.
3. Locate the LGA 775 CPU socket on the system board.

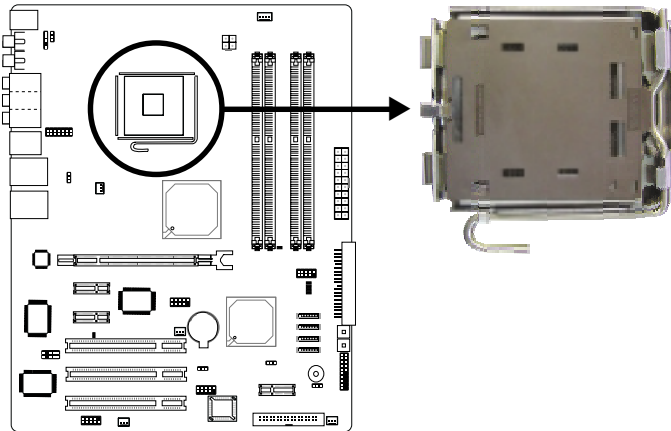

Important:

The CPU socket must not come in contact with anything other than the CPU. Avoid unnecessary exposure. Remove the protective cap only when you are about to install the CPU.

- The CPU socket comes with a cover that is attached with a removable protective cap. The cap is used to protect the CPU socket against dust and harmful particles. Remove the protective cap only when you are about to install the CPU.

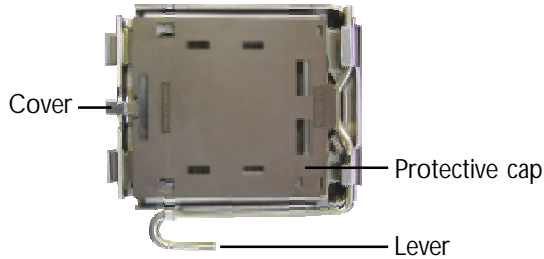

- Lift the protective cap from the location pointed below to detach the cap from the cover.

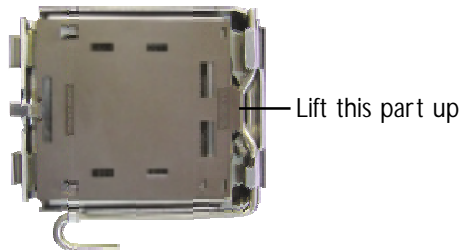

- Unlock the socket by pushing the lever down, moving it away from the side tab of the socket, then lifting it up.

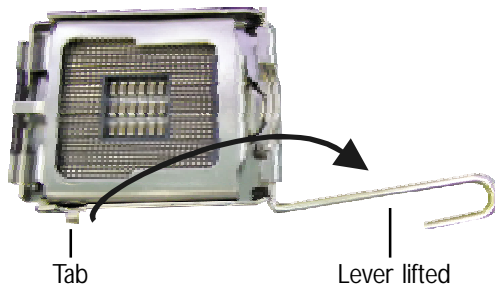

7. Now lift the cover.

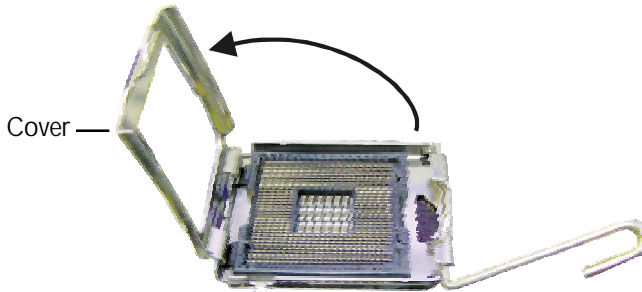

8. Position the CPU above the socket. The gold mark on the CPU must align with pin 1 of the CPU socket.



Important:

Handle the CPU by its edges and avoid touching the pins.

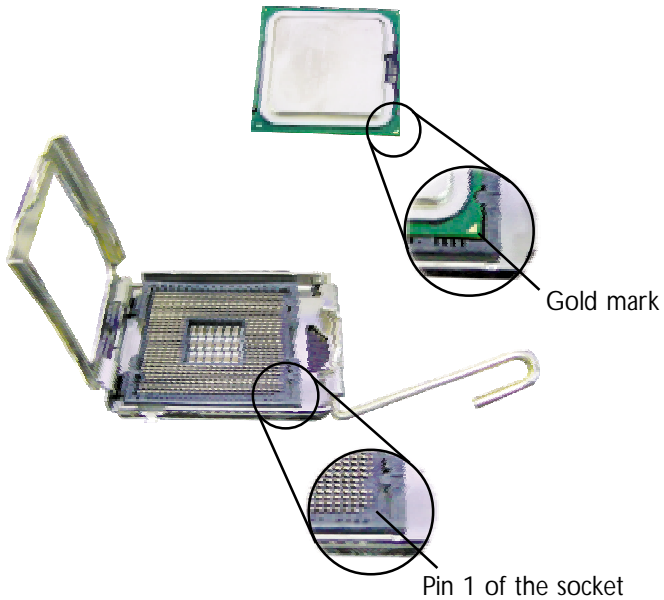

9. Insert the CPU into the socket until it is seated in place. The CPU will fit in only one orientation and can easily be inserted without exerting any force.



Important:

Do not force the CPU into the socket. Forcing the CPU into the socket may bend the pins and damage the CPU.

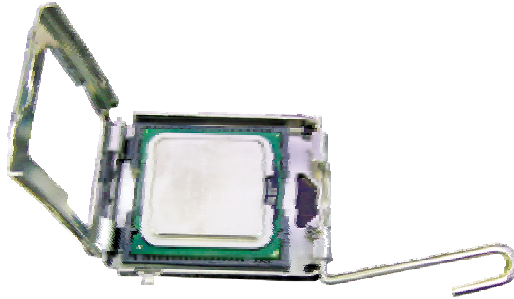

10. Once the CPU is in place, move the cover down.



11. Push the lever down to lock the socket. The lever should hook onto the side tab to indicate that the CPU is completely secured in the socket.

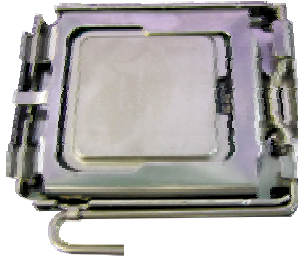

2.3.3 Installing the Fan and Heat Sink

The CPU must be kept cool by using a CPU fan with heat sink. Without sufficient air circulation across the CPU and heat sink, the CPU will overheat damaging both the CPU and system board.



Note:

- *Use only certified fan and heat sink.*
 - *The fan and heat sink package usually contains the fan and heat sink assembly, and an installation guide. If the installation procedure in the installation guide differs from the one in this section, please follow the installation guide in the package.*
1. Before you install the fan / heat sink, you must apply a thermal paste onto the top of the CPU. The thermal paste is usually supplied when you purchase the CPU or fan heat sink assembly. Do not spread the paste all over the surface. When you later place the heat sink on top of the CPU, the compound will disperse evenly.

Do not apply the paste if the fan / heat sink already has a patch of thermal paste on its underside. Peel the strip that covers the paste before you place the fan / heat sink on top of the CPU.

- Place the heat sink on top of the CPU. The 4 studs around the heat sink which are used to secure the heat sink onto the system board must match the 4 mounting holes around the socket.

Position each stud so that the groove faces the heat sink then push it down firmly until it clicks into place.



Note:

You will not be able to secure the fan and heat sink assembly in place if the groove is not facing the heat sink.

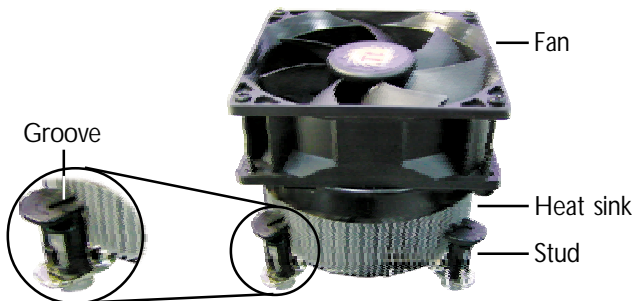
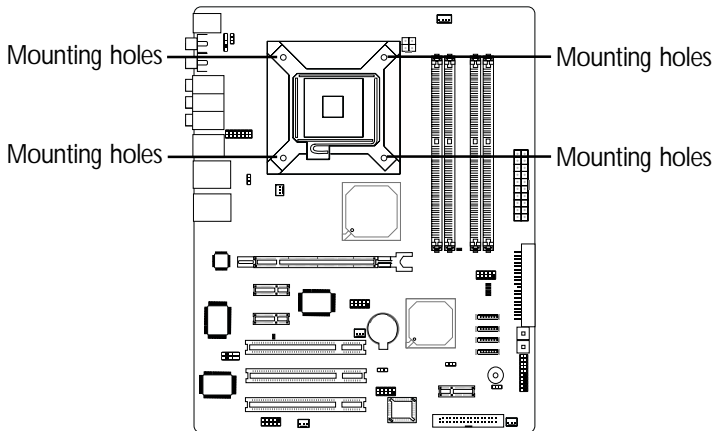

- Connect the CPU fan's cable connector to the CPU fan connector on the system board.

2.4 Jumper Settings

2.4.1 Clear CMOS Data

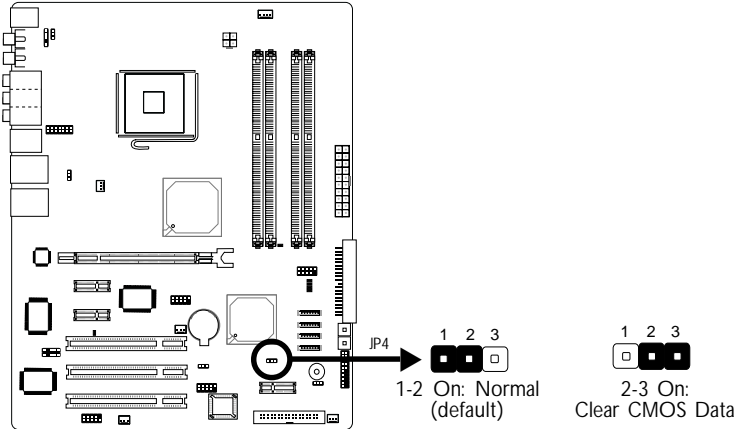

If you encounter the following,

- CMOS data becomes corrupted.*
- You forgot the supervisor or user password.*
- You are unable to boot-up the computer system because the processor's ratio/clock was incorrectly set in the BIOS.*

you can reconfigure the system with the default values stored in the ROM BIOS.

To load the default values stored in the ROM BIOS, please follow the steps below.

- Power-off the system.
- Set JP4 pins 2 and 3 to On. Wait for a few seconds and set JP4 back to its default setting, pins 1 and 2 On.
- Now power-on the system.

If your reason for clearing the CMOS data is due to incorrect setting of the processor's ratio/clock in the BIOS, please proceed to step 4.

4. After powering-on the system, press to enter the main menu of the BIOS.
5. Select the Genie BIOS Setting submenu and press <Enter>.
6. Set the "CPU Clock" or "CPU Clock Ratio" field to its default setting or an appropriate bus clock or frequency ratio. Refer to the Genie BIOS Setting section in chapter 3 for more information.
7. Press <Esc> to return to the main menu of the BIOS setup utility. Select "Save & Exit Setup" and press <Enter>.
8. Type <Y> and press <Enter>.

2.4.2 PS/2 Power Select

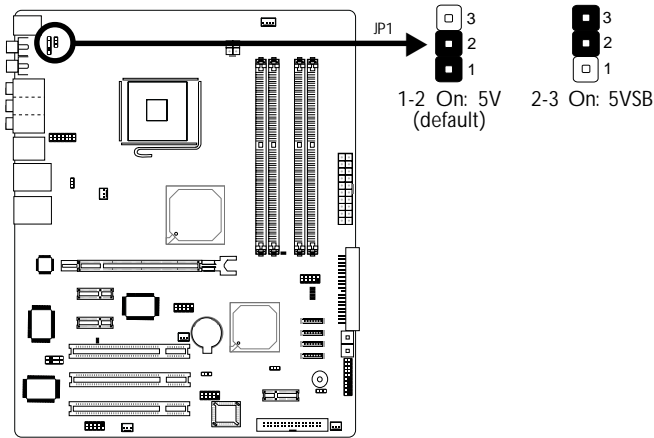

JP1 is used to select the power of the PS/2 keyboard/mouse port. Selecting 5VSB will allow you to use the PS/2 keyboard or PS/2 mouse to wake up the system.

BIOS Setting

Configure the PS/2 keyboard/mouse wake up function in the Integrated Peripherals submenu ("Super IO Device" section) of the BIOS. Refer to chapter 3 for more information.



Important:

The 5VSB power source of your power supply must support $\geq 720\text{mA}$.

2.4.3 USB Power Select

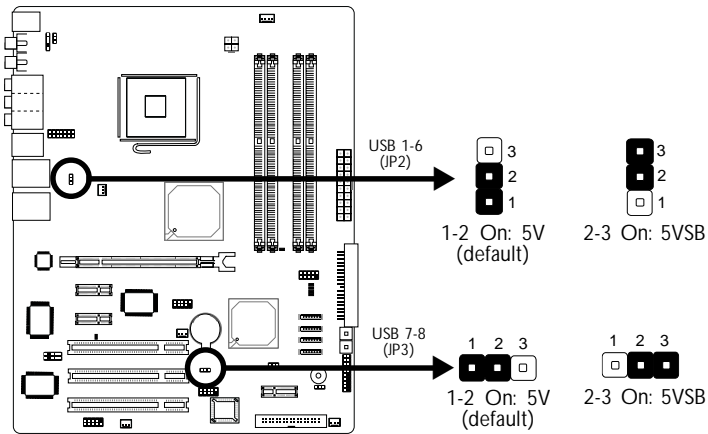

JP2 and JP3 are used to select the power of the USB ports. Selecting 5VSB will allow you to use the USB keyboard or USB mouse to wake up the system..

BIOS Setting

“USB KB Wake-Up From S3” in the Power Management Setup submenu of the BIOS must be set to Enabled. Refer to chapter 3 for more information.



Important:

- If you are using the Wake-On-USB Keyboard/Mouse function for 2 USB ports, the 5VSB power source of your power supply must support $\geq 1.5A$.
- If you are using the Wake-On-USB Keyboard/Mouse function for 3 or more USB ports, the 5VSB power source of your power supply must support $\geq 2A$.

2.4.3 Speaker On/Off Select

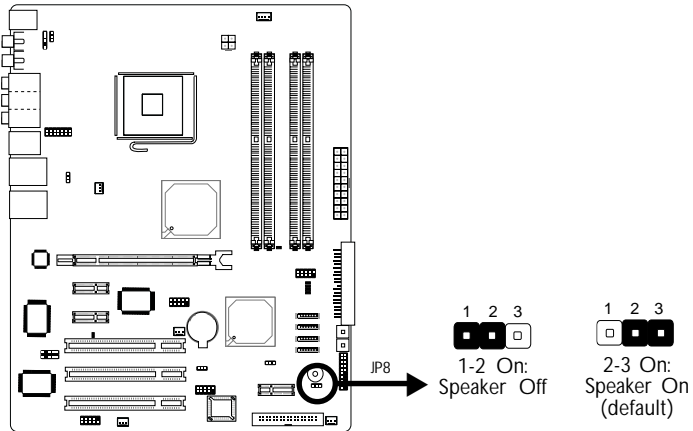

JP8 is used to turn on or off the PC's speaker. Turning on the speaker will allow you to hear the system's beep messages and warnings.

2.5 Rear Panel I/O Ports

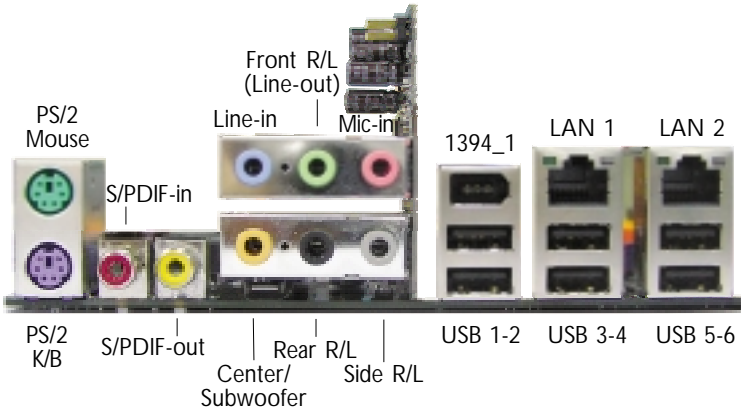

The rear panel I/O ports consist of the following:

- PS/2 mouse port
- PS/2 keyboard port
- S/PDIF-in jack
- S/PDIF-out jack
- Line-in jack
- Front right/left jack (Line-out)
- Mic-in jack
- Center/Subwoofer jack
- Rear right/left port jack
- Side right/left port jack
- 1394_1 port
- USB ports
- LAN 1 port (PCI Express)
- LAN 2 port (PCI)

2.5.1 PS/2 Mouse and PS/2 Keyboard Ports

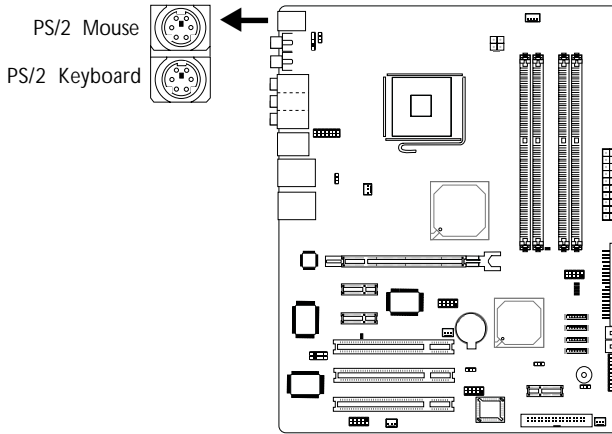

The system board is equipped with an onboard PS/2 mouse (Green) and PS/2 keyboard (Purple) ports - both at location CN1 of the system board. The PS/2 mouse port uses IRQ12. If a mouse is not connected to this port, the system will reserve IRQ12 for other expansion cards.



Warning:

Make sure to turn off your computer prior to connecting or disconnecting a mouse or keyboard. Failure to do so may damage the system board.

Wake-On-PS/2 Keyboard/Mouse

The Wake-On-PS/2 Keyboard/Mouse function allows you to use the PS/2 keyboard or PS/2 mouse to power-on the system. To use this function:

- Jumper Setting:
JP1 must be set to "2-3 On: 5VSB". Refer to "PS/2 Power Select" in this chapter for more information.
- BIOS Setting:
Configure the PS/2 keyboard/mouse wake up function in the Integrated Peripherals submenu ("Super IO Device" section) of the BIOS. Refer to chapter 3 for more information.

2.5.2 S/PDIF-in/out Jacks

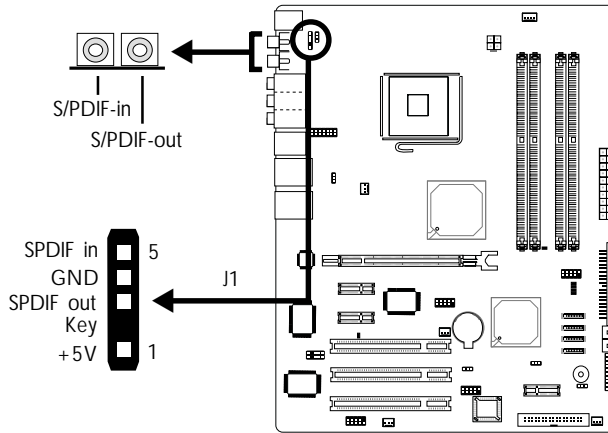

The system board is equipped with an onboard S/PDIF-in RCA jack (red) and a S/PDIF-out RCA jack (yellow) at locations CN4 and CN5 respectively.

The S/PDIF connector at location J1 is used to connect to the optical S/PDIF-out port that is on the FrontX device. (The FrontX device, which comes with LANPARTY series products, must be installed into a drive bay of the chassis.) Refer to the LANPARTY Features manual for more information about FrontX.

Connect the optical audio cable connector from FrontX to J1. Make sure pin 1 of the cable connector is aligned with pin 1 of J1. You may now connect an external audio output device to the S/PDIF port.

DO NOT use RCA S/PDIF and optical S/PDIF at the same time.

2.5.3 Karajan Audio Card

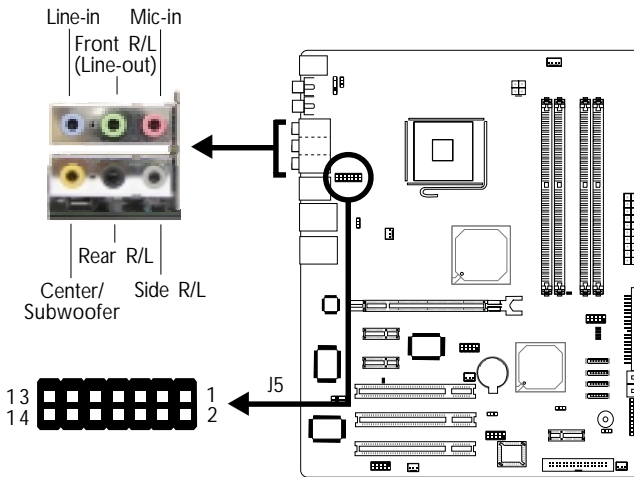

Installing the Karajan Audio Card

1. An adhesive tape is located at the underside of the Karajan card. Peel off the strip that covers the tape.
2. Insert the 14-pin connector at the solder side of the card to J5 on the system board.

**Important:**

The adhesive tape is used to stabilize Karajan to the system board. Make sure to peel off the strip of the adhesive tape.

3. The system board supports 8-channel audio output. Connect audio devices to the audio jacks on the Karajan audio card.

Line-in (Light Blue)

This jack is used to connect any audio devices such as Hi-fi set, CD player, tape player, AM/FM radio tuner, synthesizer, etc.

Front Right/Left Jack - Line-out (Lime)

This jack is used to connect to the front right and front left speakers of the audio system.

Mic-in Jack (Pink)

This jack is used to connect an external microphone.

Center/Subwoofer Jack (Orange)

This jack is used to connect to the center and subwoofer speakers of the audio system.

Rear Right/Left Jack (Black)

This jack is used to connect to the rear right and rear left speakers of the audio system.

Side Right/Left Jack (Gray)

This jack is used to connect to the side left and side right speakers of the audio system.

Front Audio

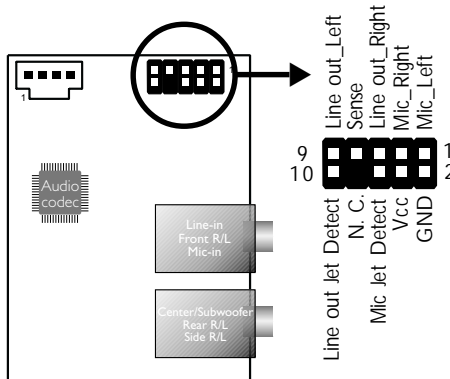

The front audio connector (J4) on the Karajan audio add-in card allows you to connect to the line-out and mic-in jacks that are at the front panel of your system. Using this connector will not disable the front right/left (line-out) and mic-in functions of the card. This is because the audio jacks on the Karajan audio card are 8 independent channels and they function independently from the front audio connector.

Driver Installation

Install the “Audio Drivers”. Refer to chapter 4 for more information.

2.5.4 IEEE 1394

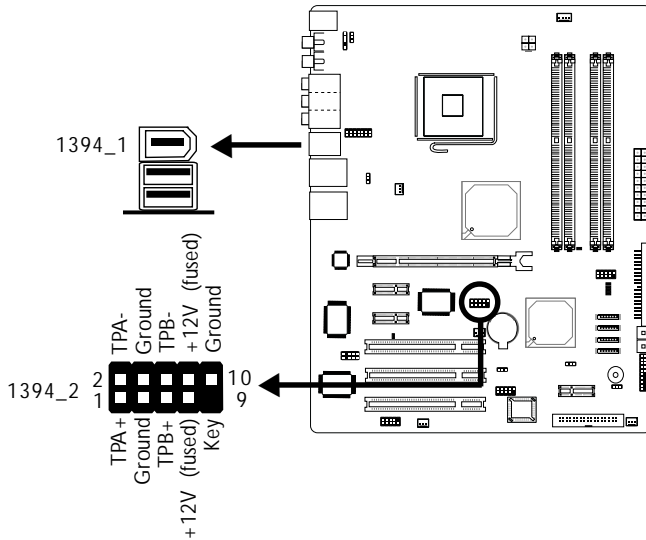

The system board is equipped with an onboard IEEE 1394 port at location CN8 (IEEE 1394_1) of the system board.

The IEEE 1394 connector at location J6 (1394_2) is used to connect to the IEEE 1394 port that is on the FrontX device. (The FrontX device, which comes with LANPARTY series products, must be installed into a drive bay of the chassis.) Refer to the LANPARTY Features manual for more information about FrontX.

Connect the IEEE 1394 cable connector from FrontX to J6. Make sure pin 1 of the cable connector is aligned with pin 1 of J6. You may now connect an IEEE 1394 device to the port.

BIOS Setting

Enable or disable the onboard IEEE 1394 in the Integrated Peripherals submenu (“Onboard Device” section) of the BIOS. Refer to chapter 3 for more information.

2.5.5 Universal Serial Bus Ports

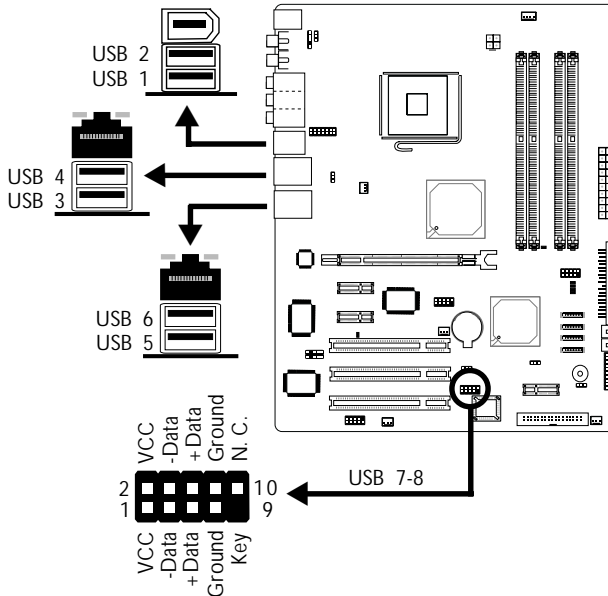

The system board supports 8 USB 2.0/1.1 ports. USB allows data exchange between your computer and a wide range of simultaneously accessible external Plug and Play peripherals.

Six onboard USB 2.0/1.1 ports (Black) are at locations CN8 (USB 1-2), CN7 (USB 3-4) and CN12 (USB 5-6) of the system board.

J9 (USB 7-8) allows you to connect 2 additional USB 2.0/1.1 ports. The USB ports may be mounted on a card-edge bracket. Install the card-edge bracket to the system chassis then insert the connector that is attached to the USB port cables to J9.

BIOS Setting

Configure the onboard USB in the Integrated Peripherals submenu ("Onboard Device" section) of the BIOS. Refer to chapter 3 for more information.

Driver Installation

You may need to install the proper drivers in your operating system to use the USB device. Refer to your operating system's manual or documentation for more information.

Wake-On-USB Keyboard/Mouse

The Wake-On-USB Keyboard/Mouse function allows you to use a USB keyboard to wake up a system from the S3 (STR - Suspend To RAM) state. To use this function:

- Jumper Setting:
JP2 and/or JP3 must be set to "2-3 On: 5VSB". Refer to "USB Power Select" in this chapter for more information.
- BIOS Setting:
"USB KB Wake-Up From S3" in the Power Management Setup submenu of the BIOS must be set to Enabled. Refer to chapter 3 for more information.



Important:

- *If you are using the Wake-On-USB Keyboard/Mouse function for 2 USB ports, the 5VSB power source of your power supply must support $\geq 1.5A$.*
- *If you are using the Wake-On-USB Keyboard/Mouse function for 3 or more USB ports, the 5VSB power source of your power supply must support $\geq 2A$.*

2.5.6 RJ45 LAN Port

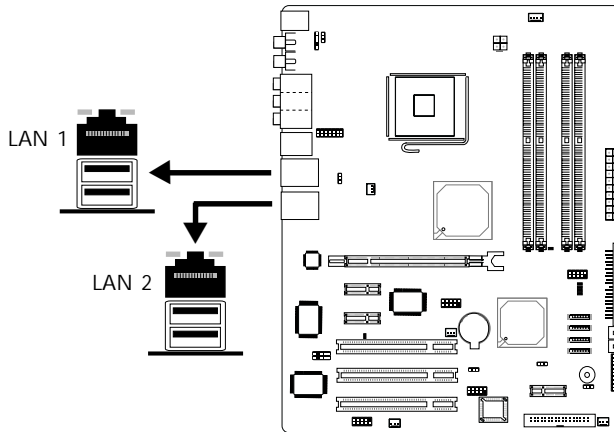

The system board is equipped with 2 onboard RJ45 LAN ports. LAN 1 which is controlled by the Marvell 88E8053 PCI Express controller is at location CN7 and LAN 2 which is controlled by the Marvell 88E8001 PCI chip is at location CN12.

LAN allows the system board to connect to a local area network by means of a network hub.

BIOS Setting

Configure the onboard LAN in the in the Integrated Peripherals submenu (“Onboard Device” section) of the BIOS. Refer to chapter 3 for more information.

Driver Installation

Install the “LAN Drivers”. Refer to chapter 4 for more information.

2.6 I/O Connectors

2.6.1 CD-in Internal Audio Connector

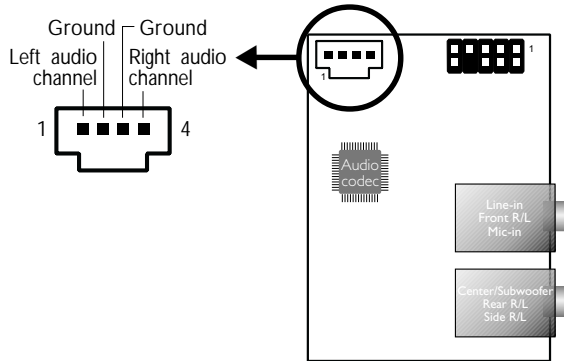

The CD-in (J2) connector on the Karajan audio add-in card is used to receive audio from a CD-ROM drive, TV tuner or MPEG card.

2.5.2 Serial Ports

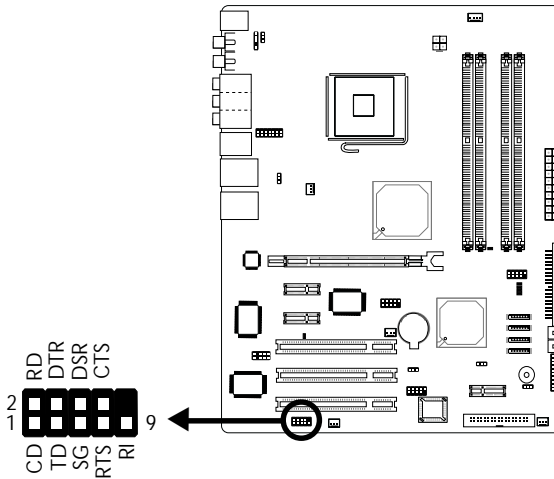

The system board is equipped with a COM connector (Teal/Turquoise) at location J4 of the system board for connecting an external serial port. It is a RS-232C asynchronous communication port with 16C550A-compatible UART that can be used with a modem, serial printer, remote display terminal or other serial devices.

The serial port may be mounted on a card-edge bracket. Install the card-edge bracket to the system chassis then insert the cable connector to J4. Make sure the colored stripe on the ribbon cable is aligned with pin 1 of J4.

BIOS Setting

Select the serial ports' I/O address in the Integrated Peripherals submenu ("Super IO Device" field) of the BIOS. Refer to chapter 3 for more information.

2.6.3 Floppy Disk Drive Connector

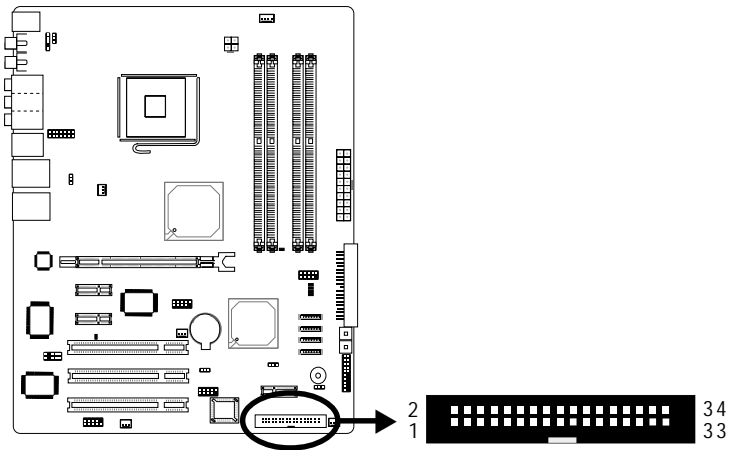

The system board is equipped with a shrouded floppy disk drive connector that supports two standard floppy disk drives. To prevent improper floppy cable installation, the shrouded floppy disk header has a keying mechanism. The 34-pin connector on the floppy cable can be placed into the header only if pin 1 of the connector is aligned with pin 1 of the header.

Connecting the Floppy Disk Drive Cable

Install one end of the floppy disk drive cable into the shrouded floppy disk header (J18) on the system board and the other end-most connector to the drive you want to designate as Drive A. If you are connecting another drive (Drive B), install the middle connector of the cable to the drive. The colored edge of the daisy chained ribbon cable should be aligned with pin 1 of J18.

BIOS Setting

Enable or disable this function in the Integrated Peripherals submenu ("Super I/O Device" field) of the BIOS. Refer to chapter 3 for more information.

2.64 Serial ATA Connectors

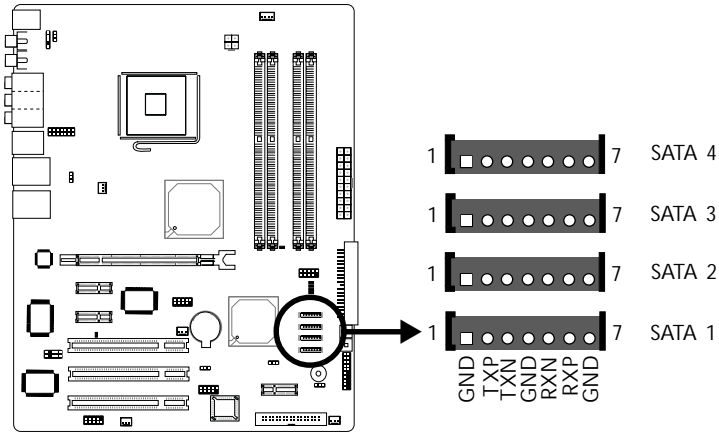

The system board is equipped with four Serial ATA connectors for connecting Serial ATA devices. Connect one end of the Serial ATA cable to J14 (SATA 4), J13 (SATA 3), J12 (SATA 2) or J11 (SATA 1) and the other end to your Serial ATA device.

Connecting to FrontX

You can connect one of the Serial ATA connectors to the Serial ATA port that is on the FrontX device. (The FrontX device, which comes with LANPARTY series products, must be installed into a drive bay of the chassis.) Refer to the LANPARTY Features manual for more information about FrontX.

Connect the Serial ATA cable connector from FrontX to one of the Serial ATA connectors on the system board. Make sure pin 1 of the cable connector is aligned with pin 1 of the Serial ATA connector. You can now connect an external Serial ATA device to the port.

Connecting the Serial ATA to Parallel ATA Adapter Module

The SATA to PATA module provides more flexibility to the system board by allowing you to connect an additional parallel IDE drive via a SATA connector and supports RAID spanning across SATA and PATA drives.

1. Connect the IDE connector on the module to the IDE connector at the rear of the parallel IDE drive.
2. Connect one end of the Serial ATA cable to a Serial ATA connector on the system board and the other end to the Serial ATA connector on the module.
3. Connect one end of the provided power cable to the power connector on the module and the other end to the power supply.

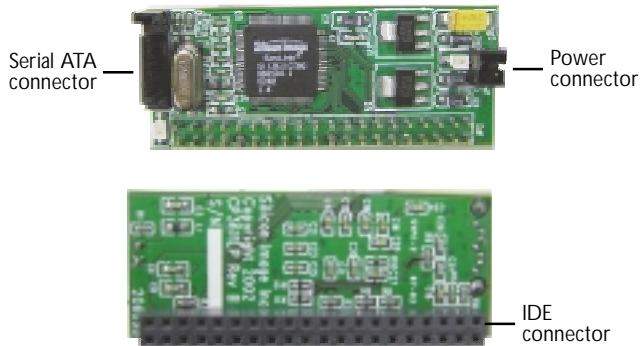

BIOS Setting

Configure the Serial ATA drives in the Integrated Peripherals submenu (“OnChip IDE Device” field) of the BIOS. Refer to chapter 3 for more information.

Configuring RAID on Serial ATA Drives

The ICH6R south bridge chip allows configuring RAID on Serial ATA drives. It supports RAID 0, RAID 1 and JBOD. The following must be set accordingly.

- BIOS Setting
 1. Enable the RAID function for Serial ATA drives in the Integrated Peripherals submenu (“OnChip IDE Device” field) of the Award BIOS.
 2. Configure and manage RAID in the Intel ICH6R BIOS Setting Utility. Refer to chapter 3 for more information.
- Drivers and Utility

Install the Intel ICH6R drivers and utility. Refer to chapter 4 for more information.

2.6.6 IDE Disk Drive Connector

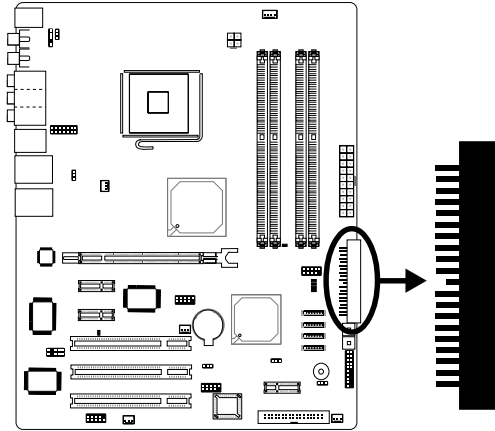

The system board is equipped with a 90° shrouded PCI IDE header that will interface two Enhanced IDE (Integrated Drive Electronics) disk drives. To prevent improper IDE cable installation, the shrouded PCI IDE header has a keying mechanism. The 40-pin connector on the IDE cable can be placed into the header only if pin 1 of the connector is aligned with pin 1 of the header.

The IDE connector supports 2 devices, a Master and a Slave. Use an IDE ribbon cable to connect the drives to the system board. An IDE ribbon cable has 3 connectors on them, one that plugs into an IDE connector on the system board and the other 2 connect to IDE devices. The connector at the end of the cable is for the Master drive and the connector in the middle of the cable is for the Slave drive.

Connecting the IDE Disk Drive Cable

Install one end of the IDE cable into the IDE header (J17) on the system board and the other connectors to the IDE devices.



Note:

Refer to your disk drive user's manual for information about selecting proper drive switch settings.

Adding a Second IDE Disk Drive

When using two IDE drives, one must be set as the master and the other as the slave. Follow the instructions provided by the drive manufacturer for setting the jumpers and/or switches on the drives.

The system board supports Enhanced IDE or ATA-2, ATA/33, ATA/66 or ATA/100 hard drives. We recommend that you use hard drives from the same manufacturer. In a few cases, drives from two different manufacturers will not function properly when used together. The problem lies in the hard drives, not the system board.



Important:

If you encountered problems while using an ATAPI CD-ROM drive that is set in Master mode, please set the CD-ROM drive to Slave mode. Some ATAPI CD-ROMs may not be recognized and cannot be used if incorrectly set in Master mode.

BIOS Setting

Enable or disable the onboard IDE in the Integrated Peripherals submenu ("OnChip IDE Device" field) of the BIOS. Refer to chapter 3 for more information.

2.6.7 IrDA Connector

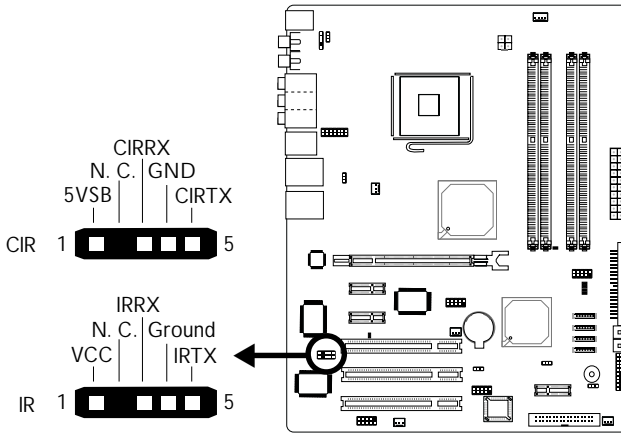

Connect the cable connector from your CIR/IR module to the CIR connector (J24) or IR connector (J8).

**Note:**

The sequence of the pin functions on some CIR/IR cable may be reversed from the pin function defined on the system board. Make sure to connect the cable connector to the CIR/IR connector according to their pin functions.

BIOS Setting

Configure CIR/IR in the Integrated Peripherals submenu ("Super IO Device" field) of the BIOS.

Driver Installation

You may need to install the proper drivers in your operating system to use the CIR/IR function. Refer to your operating system's manual or documentation for more information.

2.6.8 Cooling Fan Connectors

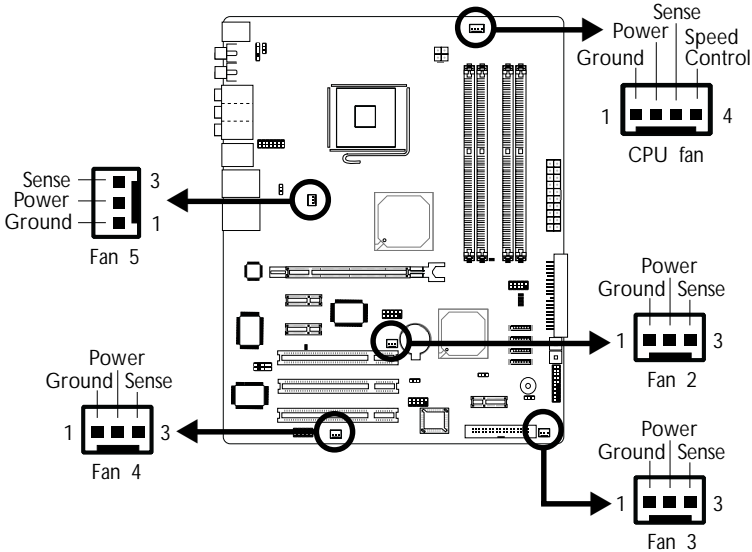

Connect the CPU fan's cable connector to the CPU fan connector (J21) on the system board. Fan 2 (J19), Fan 3 (J20), Fan 4 (J22) and Fan 5 (J23) are used to connect additional cooling fans. The cooling fans will provide adequate airflow throughout the chassis to prevent overheating the CPU and system board components.

BIOS Setting

The "PC Health Status" submenu of the BIOS will display the current speed of the cooling fans. Refer to chapter 3 for more information.

2.6.10 LEDs

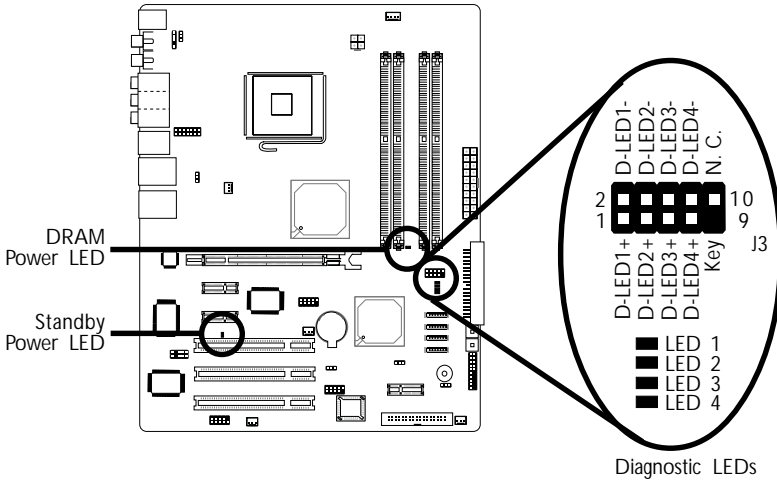

Diagnostic LEDs

DRAM Power LED

This LED will light when the system's power is on.

Standby Power LED

This LED will light when the system is in the standby mode.

Diagnostic LEDs

LED 1 to LED 4 are diagnostic LEDs. These LEDs will indicate the current condition of the system.

J3 is used to connect to the 4 diagnostic LEDs that are on the FrontX device. (The FrontX device, which comes with LANPARTY series products, must be installed into a drive bay of the chassis.) Connect the Diagnostic LED cable connector from FrontX to J3. The LEDs will indicate the current condition of the system. Refer to the LANPARTY Features manual for more information about FrontX.

Refer to the table on the next page for a list of LEDs' status and their corresponding system condition.

	LED 1	LED 2	LED 3	LED 4
Early program chipset register before POST.	On	Off	Off	Off
Testing memory presence.	Off	On	Off	Off
Detecting memory size.	On	On	Off	Off
No memory present.	Off	Off	On	Off
Programming DRAM timing register.	On	Off	On	Off
Calculating DRAM size variable including row, column and bank.	Off	On	On	Off
Initializing JEDEC of current DRAM row.	On	On	On	Off
Checking CMOS checksum and battery.	Off	Off	Off	On
Initializing the clock generator.	On	Off	Off	On
Initializing USB.	Off	On	Off	On
Testing all memory (cleared all extended memory to 0).	On	On	Off	On
Initializing the onboard Super IO.	Off	Off	On	On
Detecting and installing an IDE device.	On	Off	On	On
Final initialization.	Off	On	On	On
Booting the system.	On	On	On	On

2.6.11 Power Connectors

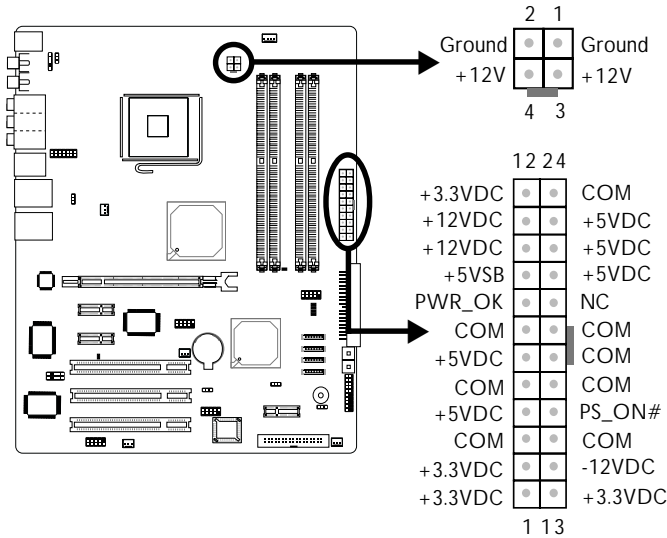

We recommend that you use a power supply that complies with the ATX12V Power Supply Design Guide Version 1.1. An ATX12V power supply has a standard 24-pin ATX main power connector and a 4-pin +12V power connector that must be inserted onto CN11 and CN10 connectors respectively.

The 4-pin +12V power connector enables the delivery of more +12VDC current to the processor's Voltage Regulator Module (VRM).

The system board requires a minimum of 300 Watt power supply to operate. Your system configuration (CPU power, amount of memory, add-in cards, peripherals, etc.) may exceed the minimum power requirement. To ensure that adequate power is provided, we strongly recommend that you use a minimum of 400 Watt (or greater) power supply.

2.6.12 Front Panel Connectors

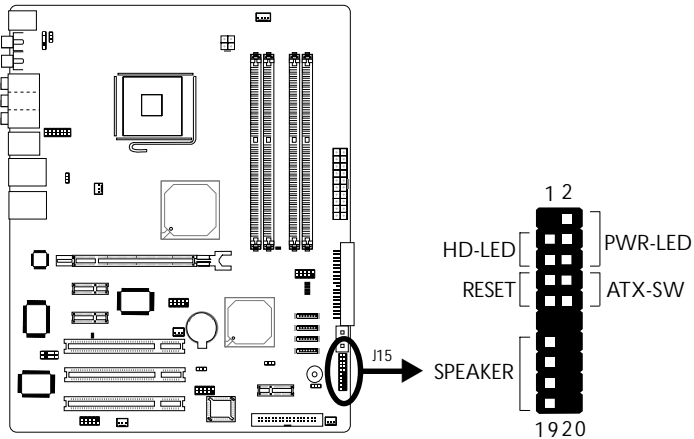

HD-LED: Primary/Secondary IDE LED

This LED will light when the hard drive is being accessed.

RESET: Reset Switch

This switch allows you to reboot without having to power off the system thus prolonging the life of the power supply or system.

SPEAKER: Speaker Connector

This connects to the speaker installed in the system chassis.

ATX-SW: ATX Power Switch

Depending on the setting in the BIOS setup, this switch is a "dual function power button" that will allow your system to enter the Soft-Off or Suspend mode. Refer to "Soft-Off By PWR-BTTN" in the Power Management Setup (Chapter 3).

PWR-LED: Power/Standby LED

When the system's power is on, this LED will light. When the system is in the S1 (POS - Power On Suspend) or S3 (STR - Suspend To RAM) state, it will blink every second.

**Note:**

If a system did not boot-up and the Power/Standby LED did not light after it was powered-on, it may indicate that the CPU or memory module was not installed properly. Please make sure they are properly inserted into their corresponding socket.

	Pin	Pin Assignment
HD-LED (Primary/Secondary IDE LED)	3 5	HDD LED Power HDD
Reserved	14 16	N. C. N. C.
ATX-SW (ATX power switch)	8 10	PWRBT+ PWRBT-
Reserved	18 20	N. C. N. C.
RESET (Reset switch)	7 9	Ground H/W Reset
SPEAKER (Speaker connector)	13 15 17 19	Speaker Data N. C. Ground Speaker Power
PWR-LED (Power/Standby LED)	2 4 6	LED Power (+) LED Power (+) LED Power (-) or Standby Signal

2.6.13 EZ Touch Switches

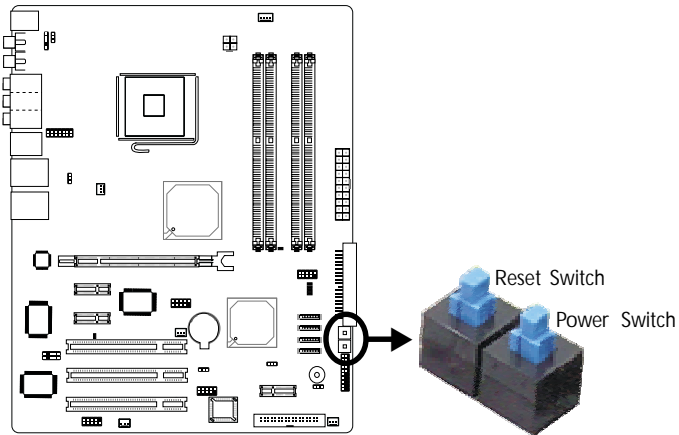

The presence of the power switch and reset switch on the system board are user-friendly especially to DIY users. They provide convenience in powering on and/or resetting the system while fine tuning the system board before it is installed into the system chassis.

2.6.14 PCI Express x16 and x1 Slots

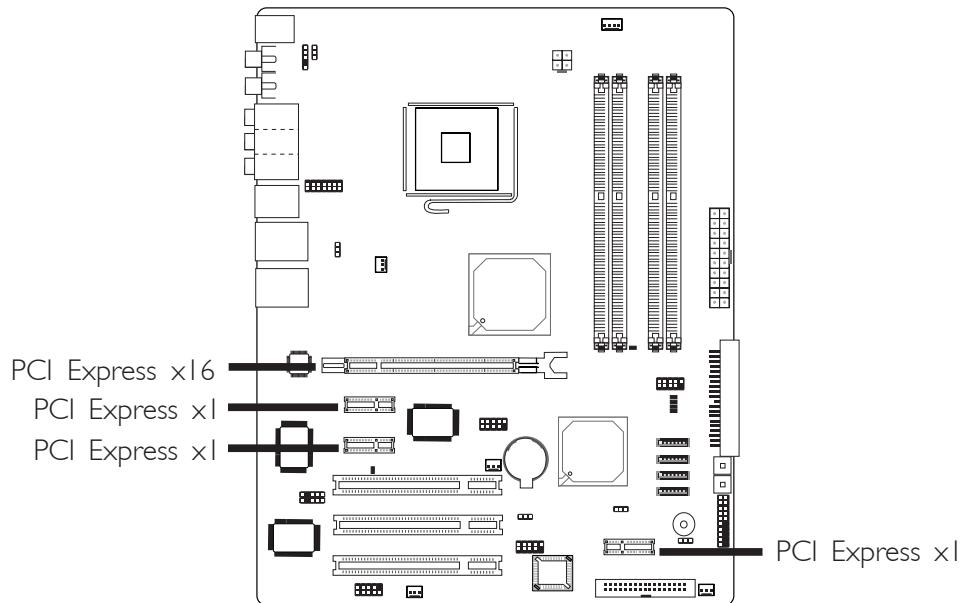

The system board allows installing one x16 and three x1 PCI Express cards.

Install PCI Express x16 graphics card, that comply to the PCI Express specifications, into the PCI Express x16 slot. To install a graphics card into the x16 slot, align the graphics card above the slot then press it down firmly until it is completely seated in the slot. The retaining clip of the slot will automatically hold the graphics card in place.

Install PCI Express x1 cards such as network cards or other cards that comply to the PCI Express specifications into the PCI Express x1 slot.

Chapter 3 - BIOS Setup

3.1 Award BIOS Setup Utility

The Basic Input/Output System (BIOS) is a program that takes care of the basic level of communication between the processor and peripherals. In addition, the BIOS also contains codes for various advanced features found in this system board. This chapter explains the Setup Utility for the Award BIOS.

After you power up the system, the BIOS message appears on the screen and the memory count begins. After the memory test, the following message will appear on the screen:

Press DEL to enter setup

If the message disappears before you respond, restart the system or press the "Reset" button. You may also restart the system by pressing the <Ctrl> <Alt> and keys simultaneously.

When you press , the main menu screen will appear:

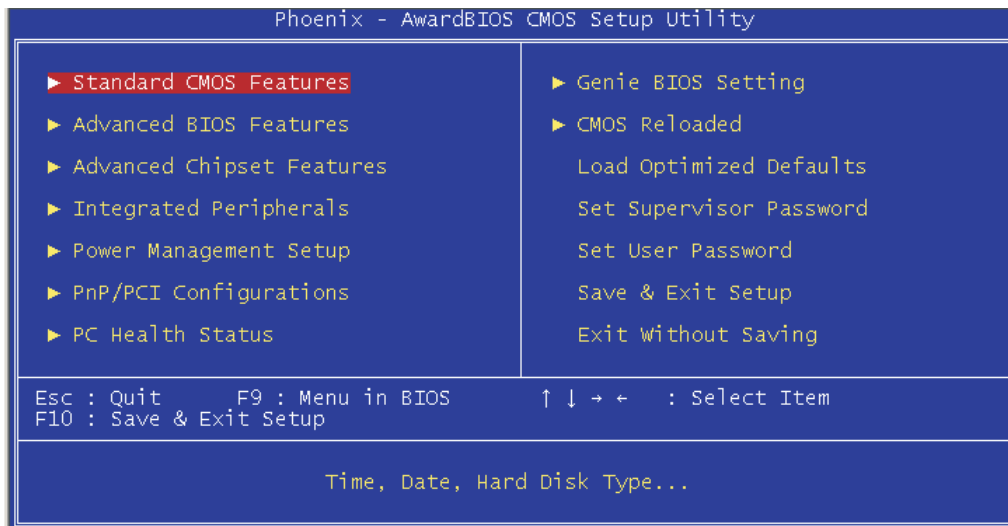

3.1.1 Standard CMOS Features

Use the arrow keys to highlight “Standard CMOS Features” and press <Enter>. A screen similar to the one on the next page will appear:

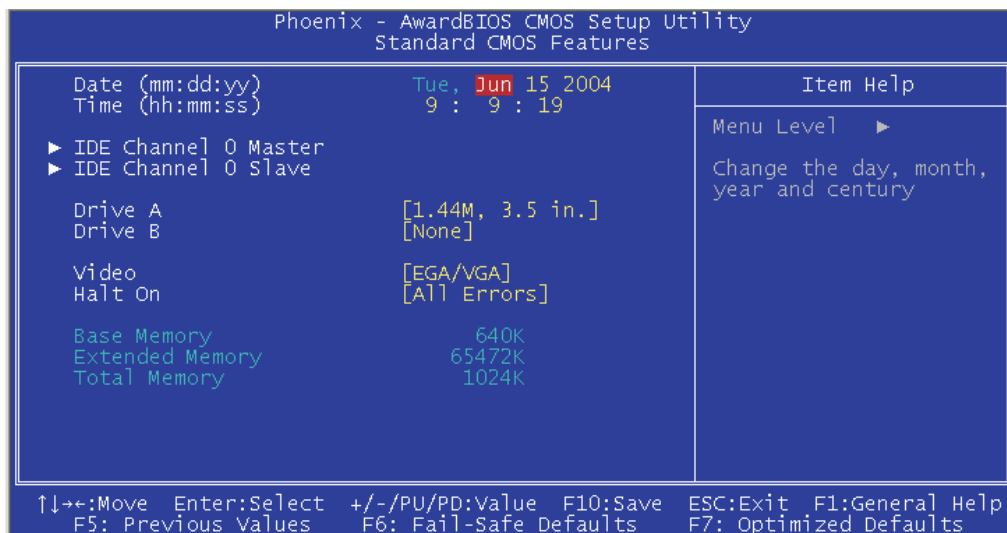

The settings on the screen are for reference only. Your version may not be identical to this one.

3.1.1.1 Date

The date format is <day>, <month>, <date>, <year>. Day displays a day, from Sunday to Saturday. Month displays the month, from January to December. Date displays the date, from 1 to 31. Year displays the year, from 1990 to 2098.

3.1.1.2 Time

The time format is <hour>, <minute>, <second>. The time is based on the 24-hour military-time clock. For example, 1 p.m. is 13:00:00. Hour displays hours from 00 to 23. Minute displays minutes from 00 to 59. Second displays seconds from 00 to 59.

3.1.1.3 IDE Channel 0 Master and IDE Channel 0 Slave

Move the cursor to the “IDE Channel 0 Master” or “IDE Channel 0 Slave” field, then press <Enter>.

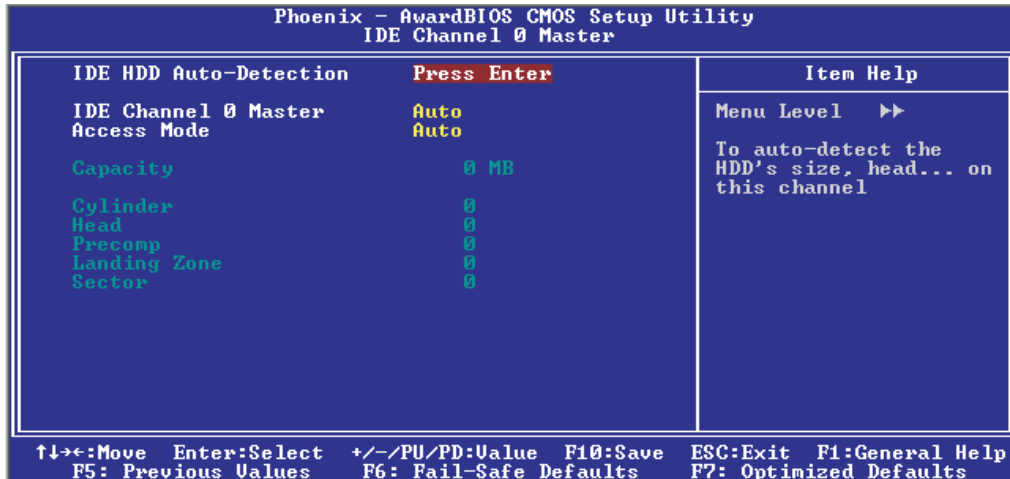

The settings on the screen are for reference only. Your version may not be identical to this one.

IDE HDD Auto Detection

Detects the parameters of the drive. The parameters will automatically be shown on the screen.

IDE Channel 0 Master and IDE Channel 0 Slave

The drive type information should be included in the documentation from your hard disk vendor. If you select “Auto”, the BIOS will auto-detect the HDD & CD-ROM drive at the POST stage and show the IDE for the HDD & CD-ROM drive. If a hard disk has not been installed, select “None”.

Access Mode

For hard drives larger than 528MB, you would typically select the LBA type. Certain operating systems require that you select CHS or Large. Please check your operating system's manual or Help desk on which one to select.

Capacity

Displays the approximate capacity of the disk drive. Usually the size is slightly greater than the size of a formatted disk given by a disk checking program.

Cylinder

This field displays the number of cylinders.

Head

This field displays the number of read/write heads.

Precomp

This field displays the number of cylinders at which to change the write timing.

Landing Zone

This field displays the number of cylinders specified as the landing zone for the read/write heads.

Sector

This field displays the number sectors per track.

3.1.1.4 Drive A and Drive B

These fields identify the types of floppy disk drives installed.

<i>None</i>	No floppy drive is installed
<i>360K, 5.25 in.</i>	5-1/4 in. standard drive; 360KB capacity
<i>1.2M, 5.25 in.</i>	5-1/4 in. AT-type high-density drive; 1.2MB capacity
<i>720K, 3.5 in.</i>	3-1/2 in. double-sided drive; 720KB capacity
<i>1.44M, 3.5 in.</i>	3-1/2 in. double-sided drive; 1.44MB capacity
<i>2.88M, 3.5 in.</i>	3-1/2 in. double-sided drive; 2.88MB capacity

3.1.1.5 Video

This field selects the type of video adapter used for the primary system monitor. Although secondary monitors are supported, you do not have to select the type. The default setting is EGA/VGA.

<i>EGA/VGA</i>	Enhanced Graphics Adapter/Video Graphics Array. For EGA, VGA, SVGA and PGA monitor adapters.
<i>CGA 40</i>	Color Graphics Adapter. Power up in 40-column mode.
<i>CGA 80</i>	Color Graphics Adapter. Power up in 80-column mode.
<i>Mono</i>	Monochrome adapter. Includes high resolution monochrome adapters.

3.1.1.6 Halt On

This field determines whether the system will stop if an error is detected during power up. The default setting is All Errors.

<i>No Errors</i>	The system boot will not stop for any errors detected.
<i>All Errors</i>	The system boot will stop whenever the BIOS detects a non-fatal error.
<i>All, But Keyboard</i>	The system boot will not stop for a keyboard error; it will stop for all other errors.
<i>All, But Diskette</i>	The system boot will not stop for a disk error; it will stop for all other errors.
<i>All, But Disk/Key</i>	The system boot will not stop for a disk or keyboard error; it will stop for all other errors.

3.1.1.7 Base Memory

Displays the amount of base (or conventional) memory installed in the system. The value of the base memory is typically 512K for systems with 512K memory installed on the motherboard or 640K for systems with 640K or more memory installed on the motherboard.

3.1.1.8 Extended Memory

Displays the amount of extended memory detected during boot-up.

3.1.1.9 Total Memory

Displays the total memory available in the system.

3.1.2 Advanced BIOS Features

The Advanced BIOS Features allows you to configure your system for basic operation. Some entries are defaults required by the system board, while others, if enabled, will improve the performance of your system or let you set some features according to your preference.

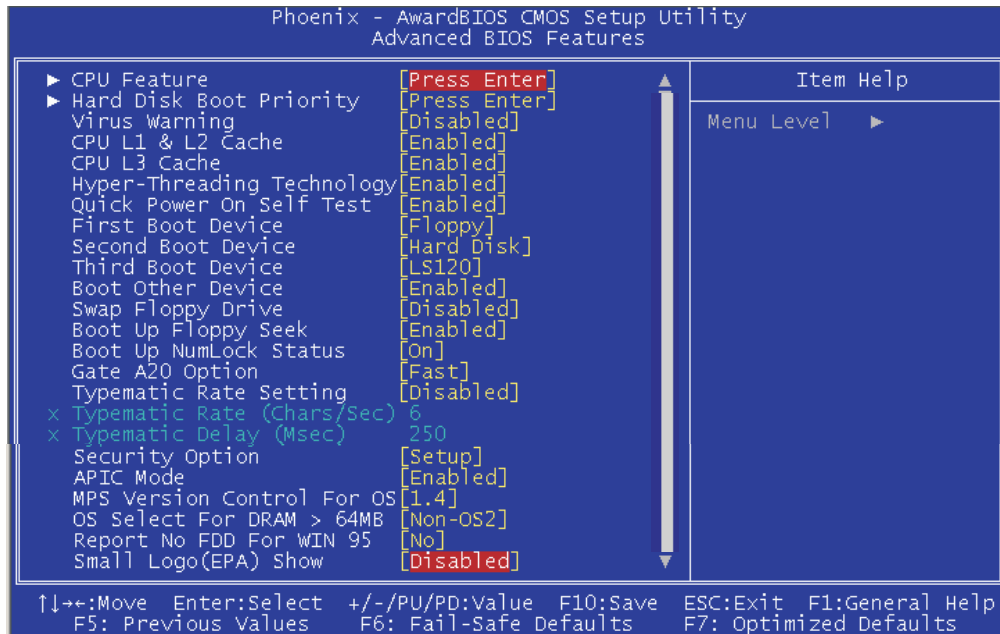

The screen above list all the fields available in the Advanced BIOS Features submenu, for ease of reference in this manual. In the actual CMOS setup, you have to use the scroll bar to view the fields. The settings on the screen are for reference only. Your version may not be identical to this one.

3.1.2.1 CPU Feature

Move the cursor to this field and press <Enter>. The following screen will appear:

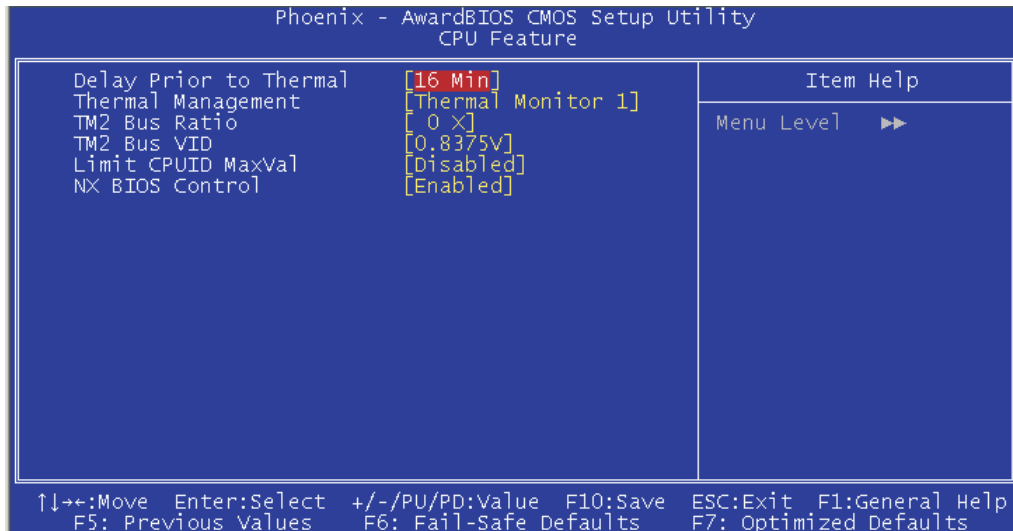

The settings on the screen are for reference only. Your version may not be identical to this one.

Delay Prior To Thermal

This field is used to select the time that would force the CPU to a 50% duty cycle when it exceeds its maximum operating temperature therefore protecting the CPU and the system board from overheating to ensure a safe computing environment.

Thermal Management

<i>Thermal Monitor 1</i>	On-die throttling
<i>Thermal Monitor 2</i>	Ratio and VID transition

TM2 Bus Ratio

This field is used to select the frequency (bus ratio) of the throttled performance state that will be initiated when the on-die sensor turns from cool to hot.

TM2 Bus VID

This field is used to select the voltage of the throttled performance state that will be initiated when the on-die sensor turns from cool to hot.

Limit CPUID MaxVal

The CPUID instruction of some newer CPUs will return a value greater than 3. Problems will occur only in certain operating systems. The default is Disabled because this problem does not exist in the Windows series operating systems. If you are using an operating system other than Windows, this problem may occur. To avoid this problem, enable this field to limit the return value to 3 or lesser than 3.

NX BIOS Control

The default is Enabled. When this function is disabled, it forces the NX features flag to always return to 0.

3.1.2.2 Hard Disk Boot Priority

This field is used to select the boot sequence of the hard drives. Move the cursor to this field then press <Enter>. Use the Up or Down arrow keys to select a device then press <+> to move it up or <-> to move it down the list.

3.1.2.3 Virus Warning

This field protects the boot sector and partition table of your hard disk drive. When this field is enabled, the Award BIOS will monitor the boot sector and partition table of the hard disk drive. If an attempt is made to write to the boot sector or partition table of the hard disk drive, the BIOS will halt the system and an error message will appear:

After seeing the error message, if necessary, you will be able to run an anti-virus program to locate and remove the problem before any damage is done.

Many disk diagnostic programs which attempt to access the boot sector table will cause the warning message to appear. If you are running such a program, we recommend that you first disable this field.

3.1.2.4 CPU L1 & L2 Cache

These fields speed up the memory access. The default value is enabled. Enable the external cache for better performance.

3.1.2.5 CPU L3 Cache

This field is used to enable or disable the CPU's L3 cache.

3.1.2.6 Hyper-Threading Technology (for Intel® Pentium® 4 Processor with Hyper-Threading Technology only)

This field is used to enable the functionality of the Intel® Pentium® 4 Processor with Hyper-Threading Technology and will appear only when using this processor.

3.1.2.7 Quick Power On Self Test

This field speeds up Power On Self Test (POST) whenever the system is powered on. The BIOS will shorten or skip some check items during POST. To attain the shortest POST time, select "Fast".

3.1.2.8 First Boot Device, Second Boot Device, Third Boot Device and Boot Other Device

Select the drive to boot first, second and third in the "First Boot Device" "Second Boot Device" and "Third Boot Device" fields respectively. The BIOS will boot the operating system according to the sequence of the drive selected. Set "Boot Other Device" to Enabled if you wish to boot from another device.

3.1.2.9 Swap Floppy Drive

When this field is enabled and the system is booting from the floppy drive, the system will boot from drive B instead of drive A. When this field is disabled and the system is booting from the floppy drive, the system will boot from drive A. You must have two floppy drives to use this function.

3.1.2.10 Boot Up Floppy Seek

When enabled, the BIOS will check whether the floppy disk drive installed is 40 or 80 tracks. Note that the BIOS cannot distinguish between 720K, 1.2M, 1.44M and 2.88M drive types as they are all 80 tracks. When disabled, the BIOS will not search for the type of floppy disk drive by track number. Note that there will not be any warning message if the drive installed is 360KB.

3.1.2.11 Boot Up NumLock Status

This allows you to determine the default state of the numeric keypad. By default, the system boots up with NumLock on wherein the function of the numeric keypad is the number keys. When set to Off, the function of the numeric keypad is the arrow keys.

3.1.2.12 Gate A20 Option

This entry allows you to select how gate A20 is handled. Gate A20 is a device used to address memory above 1 Mbyte. Initially, gate A20 was handled via the keyboard controller. Today, while keyboards still provide this support, it is more common, and much faster, for the system chipset to provide support for gate A20.

- Fast* The chipset controls Gate A20.
- Normal* A pin in the keyboard controller controls Gate A20.

3.1.2.13 Typematic Rate Setting

- Disabled* Continually holding down a key on your keyboard will cause the BIOS to report that the key is down.
- Enabled* The BIOS will not only report that the key is down, but will first wait for a moment, and, if the key is still down, it will begin to report that the key has been depressed repeatedly. For example, you would use such a feature to accelerate cursor movements with the arrow keys. You can then select the typematic rate and typematic delay in the “Typematic Rate (Chars/Sec)” and “Typematic Delay (Msec)” fields below.

3.1.2.14 Typematic Rate (Chars/Sec)

This field allows you to select the rate at which the keys are accelerated.

3.1.2.15 Typematic Delay (Msec)

This field allows you to select the delay between when the key was first depressed and when the acceleration begins.

3.1.2.16 Security Option

This field determines when the system will prompt for the password - everytime the system boots or only when you enter the BIOS setup. Set the password in the Set Supervisor/User Password submenu.

System The system will not boot and access to Setup will be denied unless the correct password is entered at the prompt.

Setup The system will boot, but access to Setup will be denied unless the correct password is entered at the prompt.

3.1.2.17 APIC Mode

Leave this field in its default setting.

3.1.2.18 MPS Version Control for OS

This field is used to select the MPS version that the system board is using.

3.1.2.19 OS Select for DRAM > 64MB

This field allows you to access the memory that is over 64MB in OS/2.

3.1.2.20 Report No FDD For WIN 95

The options are Yes and No.

3.1.2.21 Small Logo(EPA) Show

Enabled The EPA logo will appear during system boot-up.

Disabled The EPA logo will not appear during system boot-up.

3.1.3 Advanced Chipset Features

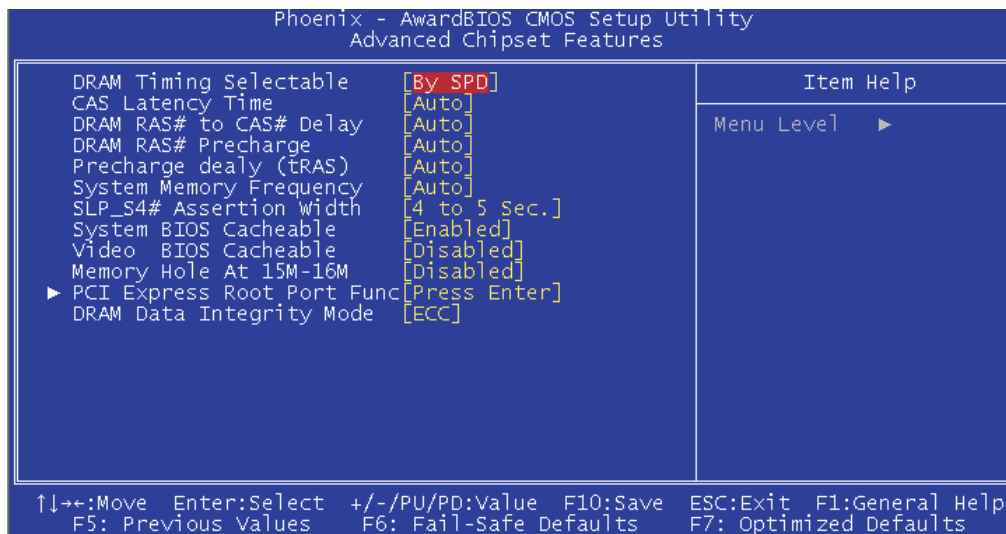

The settings on the screen are for reference only. Your version may not be identical to this one.

This section gives you functions to configure the system based on the specific features of the chipset. The chipset manages bus speeds and access to system memory resources. **These items should not be altered unless necessary.** The default settings have been chosen because they provide the best operating conditions for your system. The only time you might consider making any changes would be if you discovered some incompatibility or that data was being lost while using your system.

3.1.3.1 DRAM Timing Selectable

This field is used to select the timing of the DRAM.

By SPD The EEPROM on a DIMM has SPD (Serial Presence Detect) data structure that stores information about the module such as the memory type, memory size, memory speed, etc. When this option is selected, the system will run according to the information in the EEPROM. This option is the default setting because it provides the most stable condition for the system. The “CAS Latency Time” to “System Memory Frequency” fields will show the default settings by SPD.

Manual If you want better performance for your system other than the one “by SPD”, select “Manual” then

select the best option in the “CAS Latency Time” to “System Memory Frequency” fields.

3.1.3.2 CAS Latency Time

This field is used to select the latency between the DRAM read command and the time that the data was received.

3.1.3.3 DRAM RAS# to CAS# Delay

This field is used to select the latency between the DRAM active command and the read/write command.

3.1.3.4 DRAM RAS# Precharge

This field is used to select the idle clocks after issuing a precharge command to the DRAM.

3.1.3.5 Precharge Delay (tRAS)

The options are Auto, 4, 5, 6, 7, 8, 9, 10, 11, 12, 13, 14 and 15.

3.1.3.6 System Memory Frequency

This field is used to select the memory clock speed of the DIMM.

Refer to chapter 1 (System Memory section) for detailed specification of the memory supported by the system board.

3.1.3.7 SLP_S4# Assertion Width

The options are 1 to 2 Sec., 2 to 3 Sec., 3 to 4 Sec. and 4 to 5 Sec.

3.1.3.8 System BIOS Cacheable

When this field is enabled, accesses to the system BIOS ROM addressed at F0000H-FFFFFH are cached, provided that the cache controller is enabled. The larger the range of the Cache RAM, the higher the efficiency of the system.

3.1.3.9 Video BIOS Cacheable

As with caching the system BIOS, enabling the Video BIOS cache will allow access to video BIOS addressed at C0000H to C7FFFH to be cached, if the cache controller is also enabled. The larger the range of the Cache RAM, the faster the video performance.

3.1.3.10 Memory Hole At 15M-16M

In order to improve system performance, certain space in memory can be reserved for ISA cards. This memory must be mapped into the memory space below 16MB. When enabled, the CPU assumes the 15-16MB memory range is allocated to the hidden ISA address range instead of the actual system DRAM. When disabled, the CPU assumes the 15-16MB address range actually contains DRAM memory. If more than 16MB of system memory is installed, this field must be disabled to provide contiguous system memory.

3.1.3.11 PCI Express Root Port Func

Move the cursor to this field and press <Enter>. The following screen will appear:

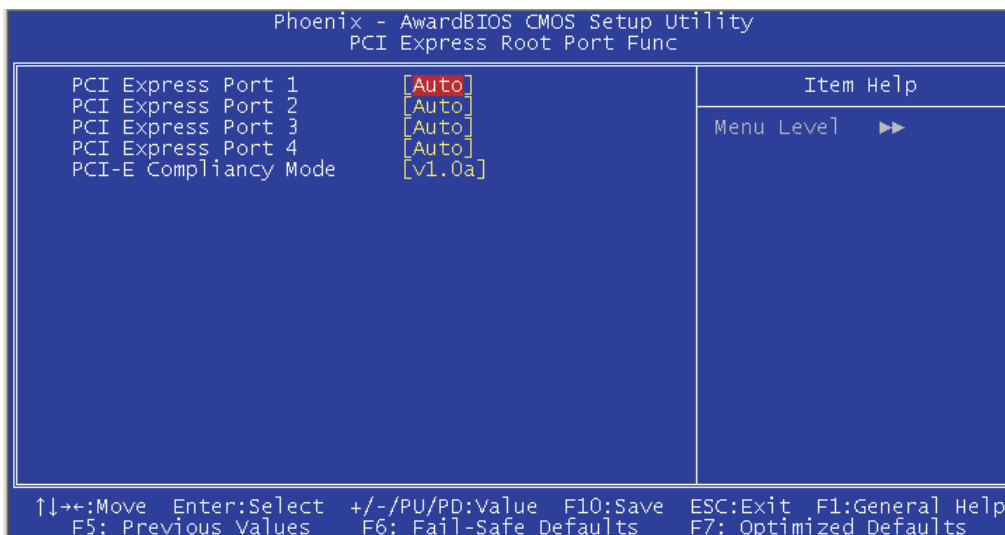

The settings on the screen are for reference only. Your version may not be identical to this one.

PCI Express Port 1 to PCI Express Port 4

These fields are used to enable or disable the PCI Express port function.

PCI-E Compliancy Mode

This field is used to select the mode for the PCI Express add-in card.

3.1.3.12 DRAM Data Integrity Mode

Leave this field in its default setting.

3.1.4 Integrated Peripherals

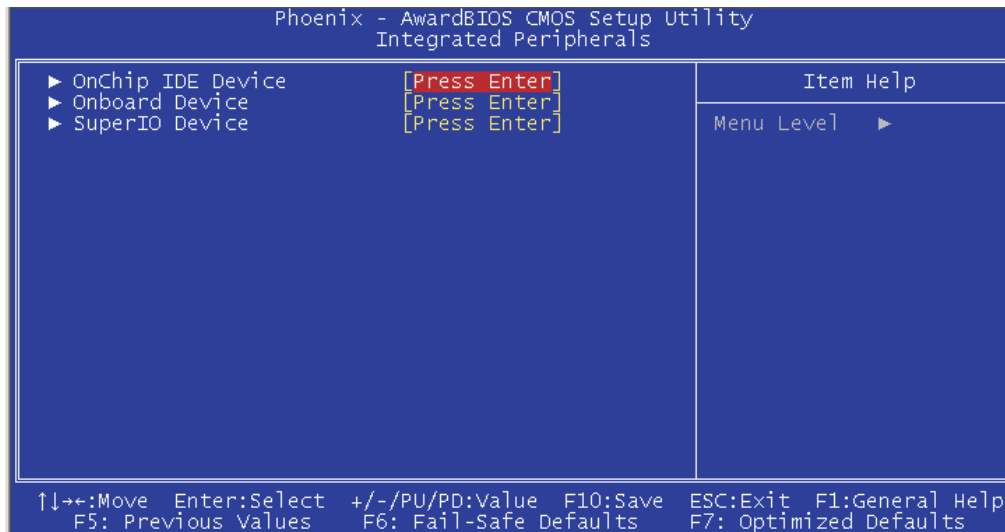

The settings on the screen are for reference only. Your version may not be identical to this one.

3.1.4.1 OnChip IDE Device

Move the cursor to this field and press <Enter>. The following screen will appear:

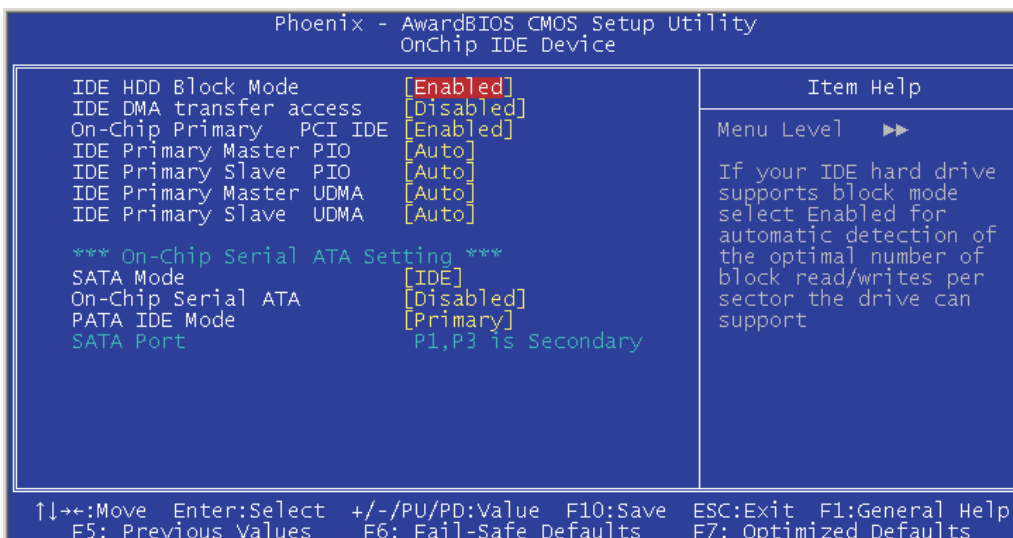

The settings on the screen are for reference only. Your version may not be identical to this one.

IDE HDD Block Mode

- Enabled* The IDE HDD uses the block mode. The system BIOS will check the hard disk drive for the maximum block size the system can transfer. The block size will depend on the type of hard disk drive.
- Disabled* The IDE HDD uses the standard mode.

IDE DMA Transfer Access

This field, when Enabled, will enhance the IDE DMA transfer of an IDE hard disk drive.

On-Chip Primary PCI IDE

These fields allow you to enable or disable the primary and secondary IDE controller. Select Disabled if you want to add a different hard drive controller.

IDE Primary Master PIO and IDE Primary Slave PIO

PIO means Programmed Input/Output. Rather than have the BIOS issue a series of commands to effect a transfer to or from the disk drive, PIO allows the BIOS to tell the controller what it wants and then let the controller and the CPU perform the complete task by themselves. Your system supports five modes, 0 (default) to 4, which primarily differ in timing. When Auto is selected, the BIOS will select the best available mode after checking your drive.

- Auto* The BIOS will automatically set the system according to your hard disk drive's timing.
- Mode 0-4* You can select a mode that matches your hard disk drive's timing. Caution: Do not use the wrong setting or you will have drive errors.

IDE Primary Master UDMA and IDE Primary Slave UDMA

These fields allow you to set the Ultra DMA in use. When Auto is selected, the BIOS will select the best available option after checking your hard drive or CD-ROM.

- Auto* The BIOS will automatically detect the settings for you.
- Disabled* The BIOS will not detect these categories.

On-Chip Serial ATA Setting

SATA Mode

IDE This option configures the Serial ATA drives in IDE mode.

RAID This option configures RAID on the Serial ATA drives.

On-Chip Serial ATA

Disabled Disables the onboard SATA.

Auto The system will detect the existing SATA and IDE drives then automatically set them to the available master/slave mode.

Combined Mode This option allows you to use both IDE and SATA drives; allowing a maximum of 4 drives - 1 IDE Master, 1 IDE Slave and 2 SATA. You must manually set the SATA and PATA drives' mode in the "PATA IDE Mode" and "SATA Port" fields.

Enhanced Mode This option allows you to use both IDE and SATA drives; allowing a maximum of 6 drives - 1 IDE Master, 1 IDE Slave and 4 SATA.

SATA Only This option automatically sets the SATA drives to Primary Master mode. Since the SATA drives are in Master mode, you cannot set the IDE drive to Master mode.

PATA IDE Mode

This field is used to select the function mode for the IDE 1 connector and its relation to the SATA ports.

Primary IDE 1 serves as Primary Master and Primary Slave channel. SATA 2 and SATA 4 serve as Secondary Master and Secondary Slave channel. SATA 1 and SATA 3 are disabled.

Secondary IDE 1 serves as Secondary Master and Secondary Slave channel. SATA 1 and SATA 3 serve as Primary Master and Primary Slave channel. SATA 2 and SATA 4 are disabled.

SATA Port

If the “PATA IDE Mode” field is set to Primary, this field will show “P1, P3 is Secondary”; meaning SATA 2 and SATA 4 are Secondary.

If the “PATA IDE Mode” field is set to Secondary, this field will show “P0, P2 is Primary”; meaning SATA 1 and SATA 3 are Primary.

3.1.4.2 Onboard Device

Move the cursor to this field and press <Enter>. The following screen will appear:

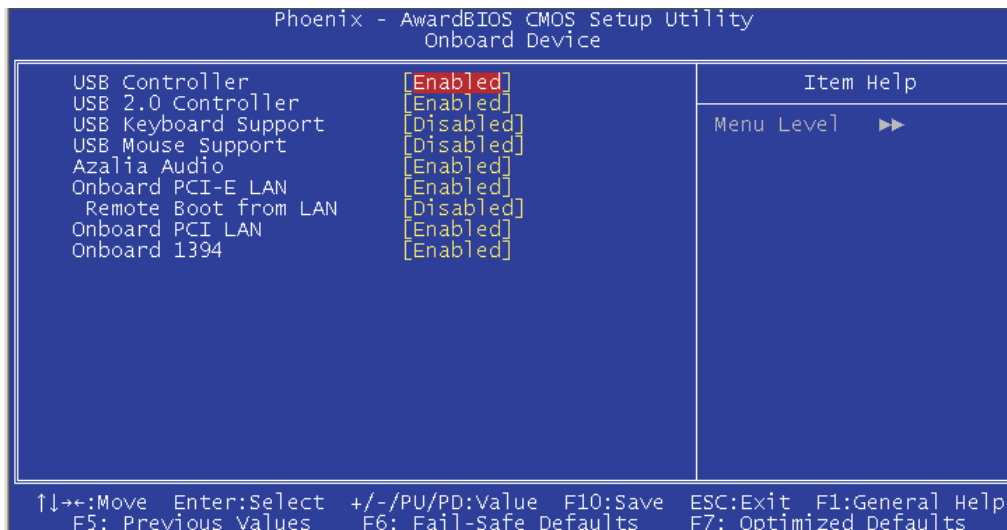

The settings on the screen are for reference only. Your version may not be identical to this one.

USB Controller

Enabled Enables the onboard USB.

Disabled Disables the onboard USB.

USB 2.0 Controller

If you are using a USB 2.0 device, this field must be set to Enabled.

USB Keyboard Support

By default, this field is Disabled. However, if you are using a USB keyboard under DOS, make sure to enable this function.

USB Mouse Support

This field is used to enable or disable the USB mouse.

Azalia Audio

Enabled Select this option when using the onboard Azalia codec.

Disabled Select this option when using a PCI sound card.

Onboard PCI-E LAN

This field is used to enable or disable LAN 1 which is controlled by the Marvell 88E8053 PCI Express controller.

Remote Boot from LAN

By default, this field is disabled. Enable this field if you wish to use the boot ROM (instead of a disk drive) to boot-up the system and access the local area network directly.

If you wish to change the boot ROM's settings, type the <Shift> and <F10> keys simultaneously when prompted during boot-up. Take note: you will be able to access the boot ROM's program (by typing <Shift> + <F10>) only when this field is enabled.

Onboard PCI LAN

This field is used to enable or disable LAN 2 which is controlled by the Marvell 88E8001 PCI chip.

Onboard I394

This field is used to enable or disable the onboard IEEE 1394.

3.1.4.3 Super IO Device

Move the cursor to this field and press <Enter>. The following screen will appear:

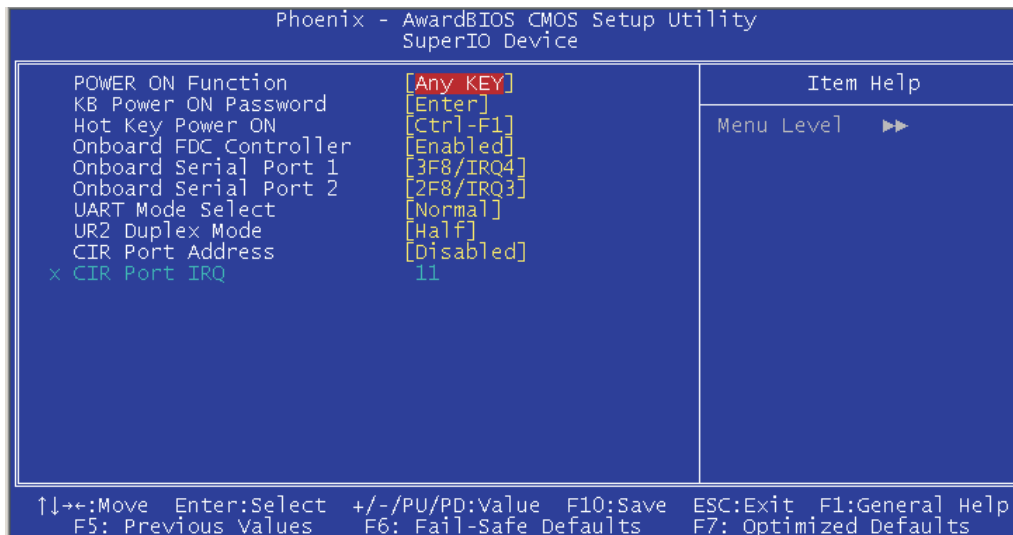

The settings on the screen are for reference only. Your version may not be identical to this one.

Power On Function

This field allows you to use the keyboard or PS/2 mouse to power-on the system.

- Button only* Default setting. Uses the power button to power on the system.
- Password* When this option is selected, set the password you would like to use to power-on the system in the “KB Power On Password” field.
- Hot Key* When this option is selected, select the function key you would like to use to power-on the system in the “Hot Key Power On” field.
- Mouse Left* When this option is selected, double-click the left button of the mouse to power-on the system.
- Mouse Right* When this option is selected, double-click the right button of the mouse to power-on the system.
- Any Key* Press any key to power-on the system.
- Keyboard 98* When this option is selected, press the “wake up” key of the keyboard to power-on the system.

KB Power On Password

Move the cursor to this field and press <Enter>. Enter your password. You can enter up to 5 characters. Type in exactly the same password to confirm, then press <Enter>.

The power button will not function once a keyboard password has been set in this field. You must type the correct password to power-on the system. If you forgot the password, power-off the system and remove the battery. Wait for a few seconds and install it back before powering-on the system.

Hot Key Power On

This field is used to select a function key that you would like to use to power-on the system.

Onboard FDC Controller

Enabled Enables the onboard floppy disk controller.

Disabled Disables the onboard floppy disk controller.

Onboard Serial Port 1 and Onboard Serial Port 2

Auto The system will automatically select an I/O address for the onboard serial port 1 and serial port 2.

3F8/IRQ4, 2F8/IRQ3, 3E8/IRQ4, 2E8/IRQ3 Allows you to manually select an I/O address for the onboard serial port 1 and serial port 2.

Disabled Disables the onboard serial port 1 and/or serial port 2.

UART Mode Select

This field is used to select the type of IrDA standard supported by your IrDA device. For better transmission of data, your IrDA peripheral device must be within a 30° angle and within a distance of 1 meter.

UR2 Duplex Mode

Half Data is completely transmitted before receiving data.

Full Transmits and receives data simultaneously.

CIR Port Address

This field is used to select an I/O address for the CIR device.

CIR Port IRQ

This field is used to select an IRQ for the CIR device.

3.1.5 Power Management Setup

The Power Management Setup allows you to configure your system to most effectively save energy.

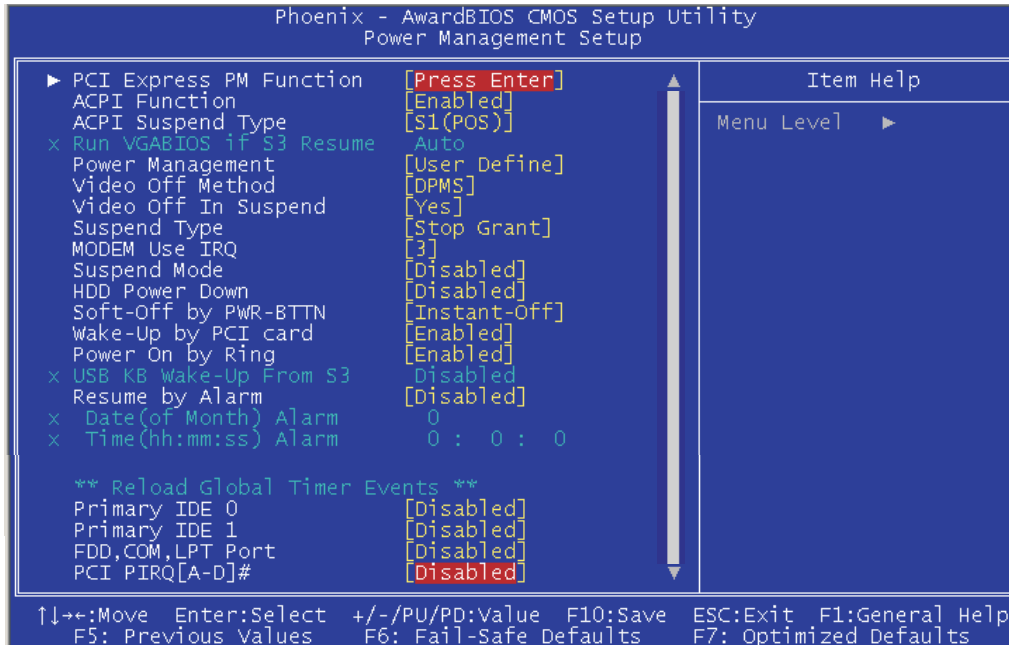

The screen above list all the fields available in the Power Management Setup submenu, for ease of reference in this manual. In the actual CMOS setup, you have to use the scroll bar to view the fields. The settings on the screen are for reference only. Your version may not be identical to this one.

3.1.5.1 PCI Express PM Function

Move the cursor to this field and press <Enter>. The following screen will appear:

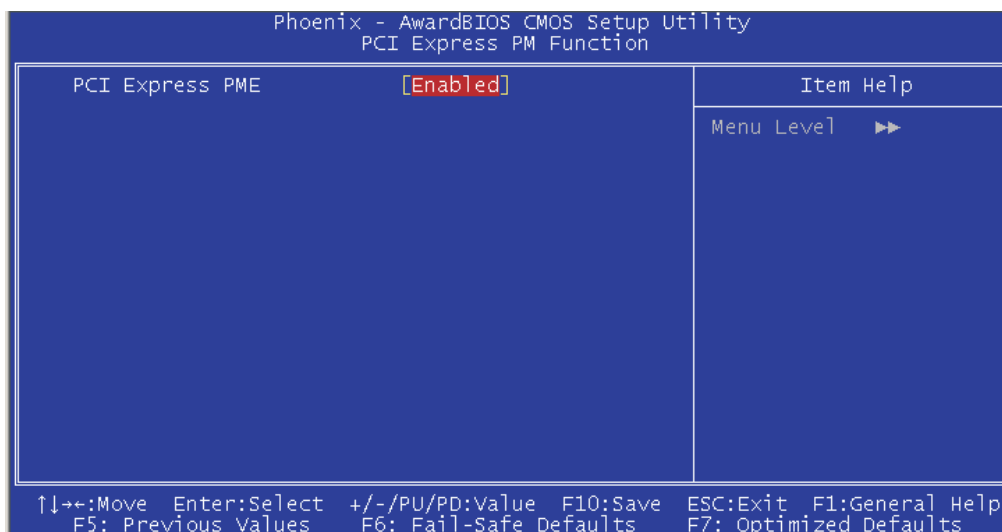

The settings on the screen are for reference only. Your version may not be identical to this one.

PCI Express PME

This options are Enabled and Disabled.

3.1.5.2 ACPI Function

This function should be enabled only in operating systems that support ACPI. Currently, only Windows® 2000/XP supports this function. If you want to use the Suspend to RAM function, make sure this field is enabled then select “S3(STR)” in the “ACPI Suspend Type” field.

3.1.5.3 ACPI Suspend Type

This field is used to select the type of Suspend mode.

- S1(POS)* Enables the Power On Suspend function.
- S3(STR)* Enables the Suspend to RAM function.

3.1.5.4 Run VGABIOS if S3 Resume

When this field is set to Auto, the system will initialize the VGA BIOS when it wakes up from the S3 state. This can be configured only if the “ACPI Suspend Type” field is set to “S3(STR)”.

3.1.5.5 Power Management

This field allows you to select the type (or degree) of power saving by changing the length of idle time that elapses before the Suspend mode and HDD Power Down fields are activated.

- Min Saving* Minimum power saving time for the Suspend Mode (1 hour) and HDD Power Down (15 min.)
- Max Saving* Maximum power saving time for the. Suspend Mode and HDD Power Down = 1 min.
- User Define* Allows you to set the power saving time in the “Suspend Mode” and “HDD Power Down” fields.

3.1.5.6 Video Off Method

This determines the manner in which the monitor is blanked.

- VIH SYNC + Blank* This selection will cause the system to turn off the vertical and horizontal synchronization ports and write blanks to the video buffer.
- Blank Screen* This option only writes blanks to the video buffer.
- DPMS* Initializes display power management signaling. Use this option if your video board supports it.

3.1.5.7 Video Off In Suspend

This field is used to activate the video off feature when the system enters the Suspend mode. The options are Yes and No.

3.1.5.8 Suspend Type

The options are Stop Grant and PwrOn Suspend.

3.1.5.9 MODEM Use IRQ

This field is used to set an IRQ channel for the modem installed in your system.

3.1.5.10 Suspend Mode

This is selectable only when the Power Management field is set to User Define. When the system enters the Suspend mode according to the power saving time selected, the CPU and onboard peripherals will be shut off.

3.1.5.11 HDD Power Down

This is selectable only when the Power Management field is set to User Define. When the system enters the HDD Power Down mode according to the power saving time selected, the hard disk drive will be powered down while all other devices remain active.

3.1.5.12 Soft-Off by PWR-BTTN

This field allows you to select the method of powering off your system.

Delay 4 Sec. Regardless of whether the Power Management function is enabled or disabled, if the power button is pushed and released in less than 4 sec, the system enters the Suspend mode. The purpose of this function is to prevent the system from powering off in case you accidentally “hit” or pushed the power button. Push and release again in less than 4 sec to restore. Pushing the power button for more than 4 seconds will power off the system.

Instant-Off Pressing and then releasing the power button at once will immediately power off your system.

3.1.5.13 Wake-Up By PCI Card

Enabled This field should be set to Enabled only if your PCI card such as LAN card or modem card uses the PCI PME (Power Management Event) signal to remotely wake up the system. Access to the LAN card or PCI card will cause the system to wake up. Refer to the card's documentation for more information.

Disabled The system will not wake up despite access to the PCI card.

3.1.5.14 Power On By Ring

Set this field to Enabled to use the modem ring-on function. This will allow your system to power-on to respond to calls coming from an external modem.

3.1.5.15 USB KB Wake-Up From S3

This field, when enabled, allows you to use a USB keyboard to wake up a system that is in the S3 (STR - Suspend To RAM) state. This can be configured only if the “ACPI Suspend Type” field is set to “S3(STR)”.

3.1.5.16 Resume By Alarm

Enabled When Enabled, you can set the date and time you would like the Soft Power Down (Soft-Off) PC to power-on in the “Date (of Month) Alarm” and “Time (hh:mm:ss) Alarm” fields. However, if the system is being accessed by incoming calls or the network (Resume On Ring/LAN) prior to the date and time set in these fields, the system will give priority to the incoming calls or network.

Disabled Disables the automatic power-on function. (default)

3.1.5.17 Date (of Month) Alarm

0 The system will power-on everyday according to the time set in the “Time (hh:mm:ss) Alarm” field.

1-31 Select a date you would like the system to power-on. The system will power-on on the set date, and time set in the “Time (hh:mm:ss) Alarm” field.

3.1.5.18 Time (hh:mm:ss) Alarm

This is used to set the time you would like the system to power-on. If you want the system to power-on everyday as set in the “Date (of Month) Alarm” field, the time set in this field must be later than the time of the RTC set in the Standard CMOS Features submenu.

3.1.5.19 Reload Global Timer Events

When enabled, access to the specified field (Primary IDE 0/1, FDD/COM/LPT Port or PCI PIRQ[A-D]#) will cause the system to wake up completely from the power management mode. When disabled, the system will not wake up from the power management mode despite access to the specified field.

3.1.6 PnP/PCI Configurations

This section describes configuring the PCI bus system. It covers some very technical items and it is strongly recommended that only experienced users should make any changes to the default settings.

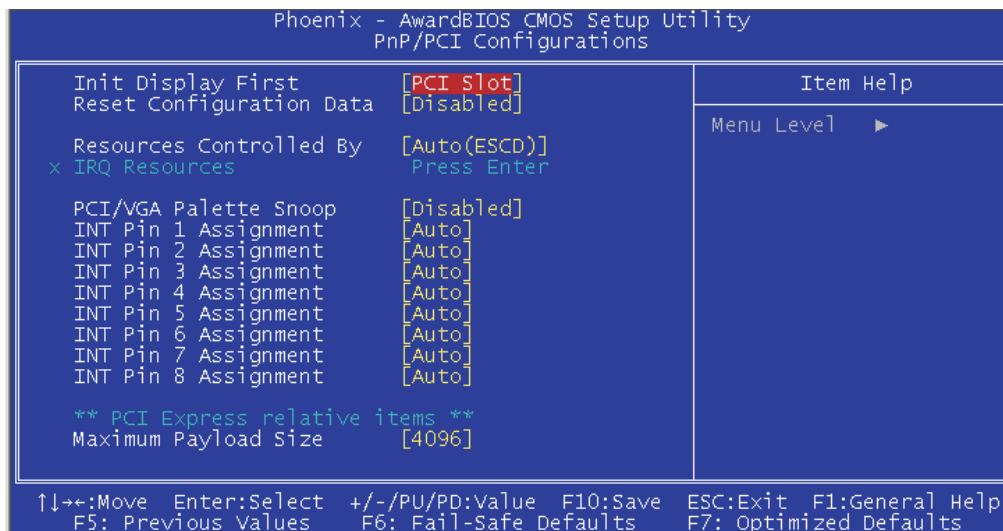

The settings on the screen are for reference only. Your version may not be identical to this one.

3.1.6.1 Init Display First

This field is used to select whether to initialize the AGP or PCI first when the system boots.

- AGP* When the system boots, it will first initialize the AGP.
- PCI Slot* When the system boots, it will first initialize PCI.

3.1.6.2 Reset Configuration Data

- Enabled* The BIOS will reset the Extended System Configuration Data (ESCD) once automatically. It will then recreate a new set of configuration data.
- Disabled* The BIOS will not reset the configuration data.

3.1.6.3 Resources Controlled By

The Award Plug and Play BIOS has the capability to automatically configure all of the boot and Plug and Play compatible devices.

- Auto* The system will automatically detect the settings for you.
- Manual* Choose the specific IRQ in the “IRQ Resources” field respectively.

3.1.6.4 IRQ Resources

Move the cursor to this field and press <Enter>. This field is used to set each system interrupt to either Reserved or PCI Device.

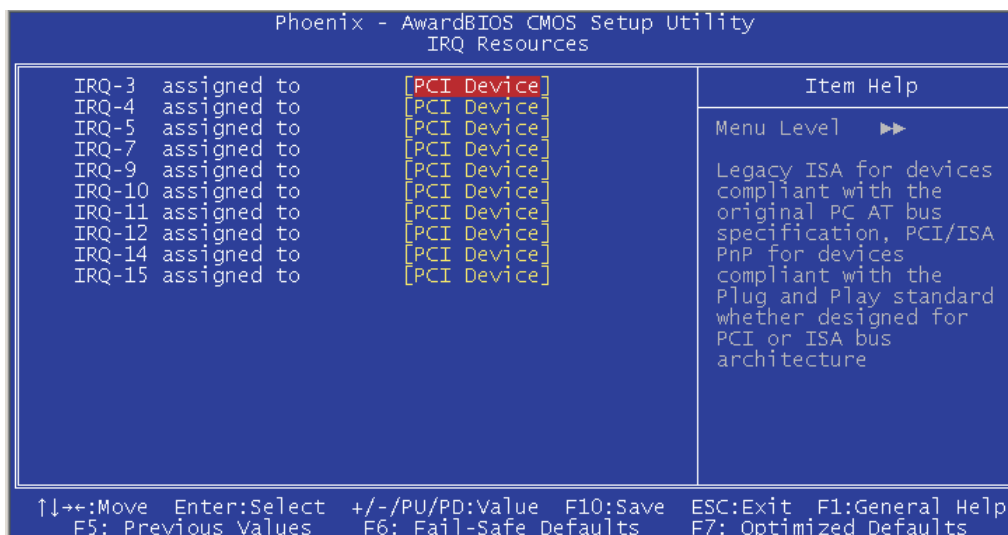

The settings on the screen are for reference only. Your version may not be identical to this one.

3.1.6.5 PCI/VGA Palette Snoop

This field determines whether the MPEG ISA/VESA VGA cards can work with PCI/VGA or not. The default value is Disabled.

- Enabled* MPEG ISA/VESA VGA cards work with PCI/VGA.
- Disabled* MPEG ISA/VESA VGA cards does not work with PCI/VGA.

3.1.6.6 INT Pin 1 Assignment to INT Pin 8 Assignment

By default, a device is automatically assigned to each INT. You can also manually assign an INT for a device.

3.1.6.7 Maximum Payload Size

This field is used to select the maximum TLP payload size of the PCI Express devices. The unit is byte.

3.1.7 PC Health Status

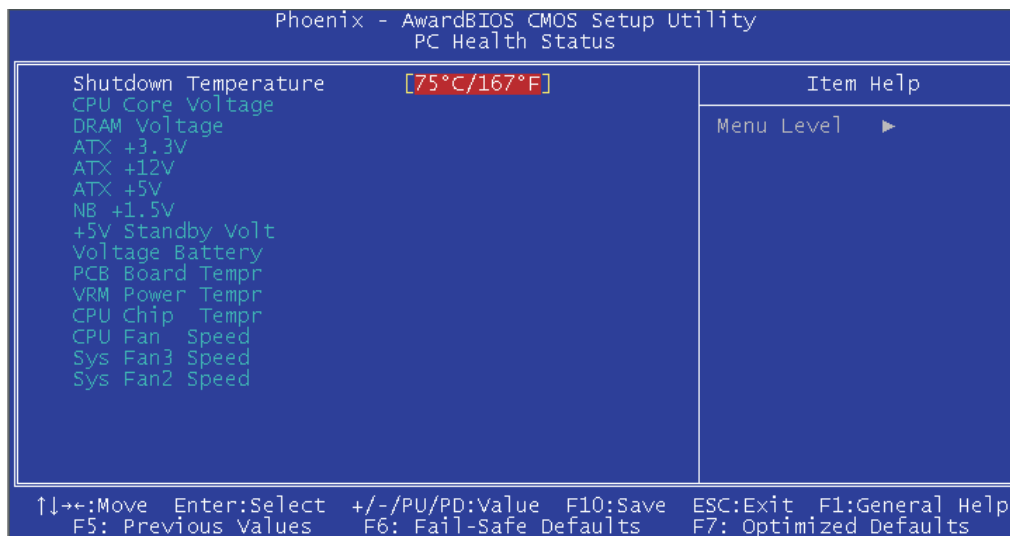

The settings on the screen are for reference only. Your version may not be identical to this one.

3.1.7.1 Shutdown Temperature

You can prevent the system from overheating by selecting a temperature in this field. If the system detected that its temperature exceeded the one set in this field, it will automatically shutdown. This function will work only when you enable this function in the Hardware Monitor utility.

3.1.7.2 CPU Core Voltage

This field will show the voltage of the processor.

3.1.7.3 DRAM Voltage

This field will show the voltage of the DRAM.

3.1.7.4 ATX +3.3V, ATX +12V., ATX +5V, NB +1.5V and +5V Standby Volt

These fields will show the output voltage of the power supply.

3.1.7.5 Voltage Battery

This field will show the voltage of the battery.

3.1.7.6 PCB Board Tempr,VRM Power Tempr and CPU Chip Tempr

These fields will show the temperature monitored by the system.

3.1.7.7 CPU Fan Speed, Sys Fan3 Speed and Sys Fan2 Speed

These fields will show the fan speed of the cooling fans in RPM (Revolutions Per Minute).



Note:

The onboard hardware monitor function is capable of detecting “system health” conditions but if you want a warning message to pop-up or a warning alarm to sound when an abnormal condition occurs, you must install the Hardware Monitor utility. This utility is included in the CD that came with the system board. Refer to the Hardware Monitor section in chapter 4 for more information.

3.1.8 Genie BIOS Setting

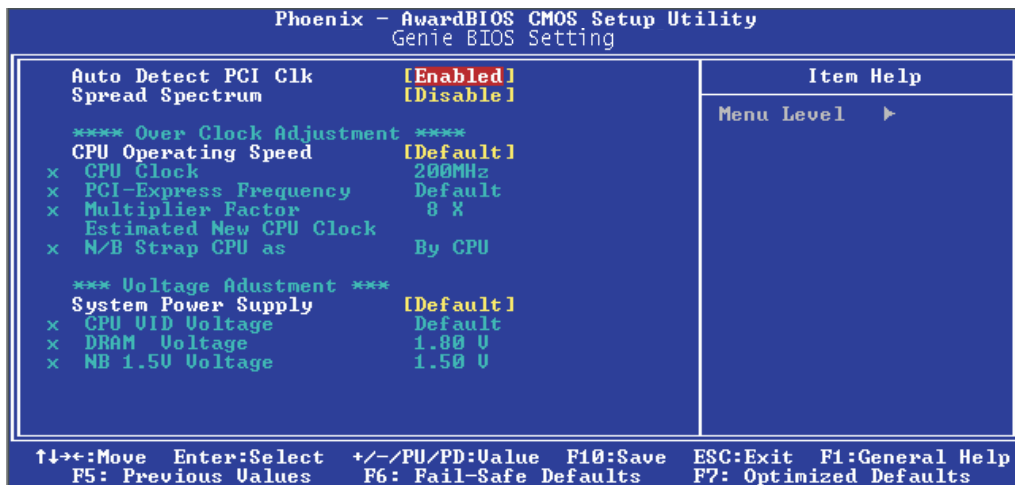

The settings on the screen are for reference only. Your version may not be identical to this one.

3.1.8.1 Auto Detect PCI Clk

When enabled, the system will automatically send clock signals to existing PCI devices.

3.1.8.2 Spread Spectrum

Leave this field in its default setting. Do not alter this setting unless advised by an engineer or technician.

3.1.8.3 CPU Operating Speed

Default Default setting.

Manual Select this option to manually configure the “CPU Clock” to “N/B Strap CPU As” fields.

3.1.8.4 CPU Clock

This field provides several options for selecting the external system bus clock of the processor. The available options allow you to adjust the processor’s bus clock by 1MHz increment.



Important:

Selecting an external bus clock other than the default setting may result to the processor’s or system’s instability and are not guaranteed to provide better system performance.

3.1.8.5 PCI-Express Frequency

<i>Default</i>	Default setting.
<i>Fix100MHz</i>	This option will set the PCI Express frequency to 100MHz.

3.1.8.6 Multiplier Factor

This field is used to select the multiplier factor for the CPU.



Important:

The multiplier factor of some processors may have been locked by the manufacturer. If you are using this kind of processor, setting a multiplier factor for the processor will have no effect. The system will instead use its factory default multiplier.

3.1.8.7 Estimated New CPU Clock

This field will show the estimated new CPU clock.

3.1.8.8 N/B Strap CPU As

This field is used to select the external hardware reset strap for the north bridge (MCH).

3.1.8.9 System Power Supply

<i>Default</i>	Default setting.
<i>Manual</i>	Select this option to manually configure the “CPU VID Voltage” to “NB 1.5V Voltage” fields.

3.1.8.10 CPU VID Voltage

This field allows you to manually adjust to a higher core voltage that is supplied to the CPU. If you want to use the CPU's default core voltage, leave this field in its default setting. The CPU's Vcore will be generated according to the CPU VID configuration.



Important:

Although this function is supported, we do not recommend that you use a higher voltage because unstable current may be supplied to the system board causing damage.

3.1.8.11 DRAM Voltage

This field allows you to manually select higher voltage supplied to the DRAM. If you want to use the DRAM's default voltage, leave this field in its default setting.



Important:

Although this function is supported, we do not recommend that you use a higher voltage because unstable current may be supplied to the system board causing damage.

3.1.8.12 NB 1.5V Voltage

This field allows you to manually select higher voltage supplied to the north bridge. If you want to use the default voltage, leave this field in its default setting.



Important:

Although this function is supported, we do not recommend that you use a higher voltage because unstable current may be supplied to the system board causing damage.

3.1.9 CMOS Reloaded

The CMOS Reloaded submenu allows you to save different configurations and when needed, allows you to conveniently restore one of these previously saved configurations. Highlight CMOS Reloaded in the main menu then press <Enter>.

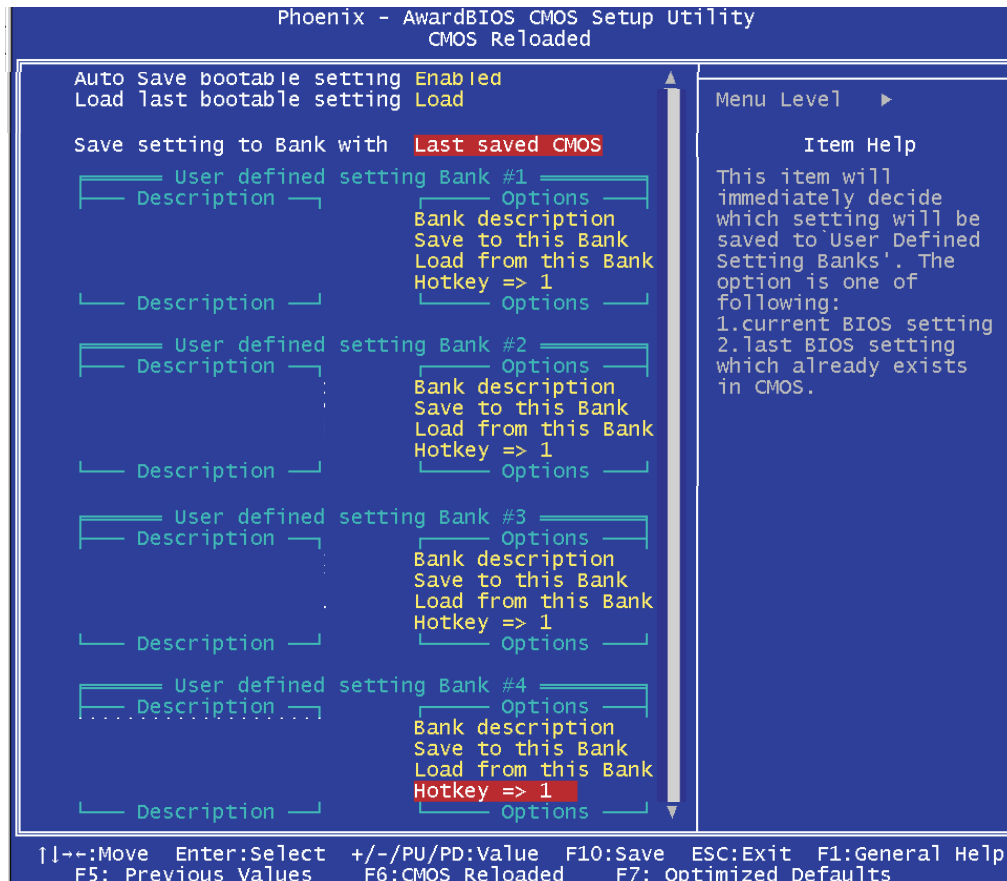

The screen above list all the fields available in the CMOS Reloaded submenu, for ease of reference in this manual. In the actual CMOS setup, you have to use the scroll bar to view the fields. The settings on the screen are for reference only. Your version may not be identical to this one.

CMOS Reloaded is especially helpful to overclockers who often go through the tiresome trial and error process of repeatedly changing the BIOS settings to come up with the most ideal overclocked setting. By being able to save and load the settings, it eliminates the tedious job of remembering several settings and/or repeatedly resetting settings during the trial process. The settings are stored in the SEEPROM. SEEPROM is divided into 5 banks - the backup bank and the 4 user defined banks.

Auto Save Bootable Setting

This field is used to automatically save the last bootable setting from CMOS to an area in the SEEPROM referred to as the backup bank. To use this function:

1. Set this field to Enabled.
2. Select "Save & Exit Setup" in the main menu then press <Enter>.
3. Type <Y> then press <Enter>.

If the changes to the setting allowed the system to boot, the setting will be stored in the SEEPROM. In other words, if the system did not boot up, the setting will not be stored. You may then follow the steps in the next section to load the last bootable setting.

Load Last Bootable Setting

If, during the trial and error process, the setting resulted to the system's instability or worse yet, not being able to boot up the system, please follow the steps below to use the Load function.



Note:

You can use the Load function only if you have set the "Auto Save Bootable Setting" to Enabled.

1. If the system did not boot up properly but you were able to enter the BIOS utility:
 - a. Select "CMOS Reloaded" in the main menu then press <Enter>.
 - b. Move the cursor to "Load Last Bootable Setting" then press "Load".
 - c. Press <Y> to load the last bootable setting that was stored in the backup bank.
2. If you cannot enter the BIOS utility:
 - a. Use JP3 to clear the CMOS. Refer to chapter 2 for more information about clearing CMOS.
 - b. Enter the BIOS utility then perform steps 1a to 1c.

Saving, Loading and Naming BIOS Settings

For overclockers who require different sets of settings for various system environments or operating systems, CMOS Reloaded allows you to save, load and name up to four sets of BIOS settings - in the “User Defined Setting Bank #1” to “User Defined Setting Bank #4” fields.

Save Setting to Bank With

This field is used to select the type of setting you would like saved to a User Defined Setting Bank when you use the “Save to this Bank” function of that bank.

Current BIOS Setting This option will save the current BIOS setting to the User Defined Setting Bank.

Last BIOS Setting This option will save the last saved BIOS setting to the User Defined Setting Bank.

User Defined Setting Bank #1/2/3/4

Bank Description

To name the BIOS setting, move the cursor to “Bank Description” then press <Enter>. You can enter up to 60 characters. Providing a name to the BIOS setting will allow you to easily remember the settings in the bank.

Save to this Bank

To save the BIOS setting, move the cursor to “Save to this Bank” then press <Enter>. Type <Y> then press <Enter>. This will save the current setting or the last saved setting to this bank; depending on the option selected in the “Save Setting to Bank With” field.

If you want to immediately reboot to use the new settings, make sure to save before you exit the BIOS setup utility by selecting “Y” in the “Save & Exit Setup” submenu.

Load from this Bank

To load the setting saved in the bank, move the cursor to “Load from this Bank” then press <Enter>. The setting in this bank will replace the current setting. Make sure to save before you exit the BIOS setup utility by selecting “Y” in the “Save & Exit Setup” submenu.

Hotkey

You can now load a BIOS setting during system boot up; bypassing the lengthy process of entering the BIOS utility to load a setting. Move the cursor to “Hotkey” then press <Enter>. Select the key you would like to use to load the settings from the bank. When the system boots up, press the key to load the setting.

3.1.10 Load Optimized Defaults

The “Load Optimized Defaults” option loads optimized settings from the BIOS ROM. Use the default values as standard values for your system. Highlight this option in the main menu and press <Enter>.

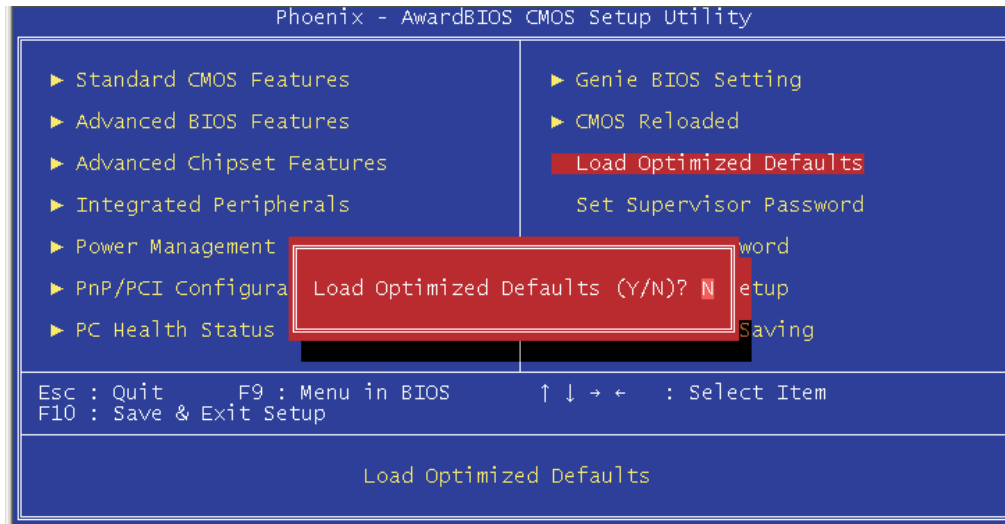

Type <Y> and press <Enter> to load the Setup default values.

3.1.11 Set Supervisor Password

If you want to protect your system and setup from unauthorized entry, set a supervisor's password with the "System" option selected in the Advanced BIOS Features. If you want to protect access to setup only, but not your system, set a supervisor's password with the "Setup" option selected in the Advanced BIOS Features. You will not be prompted for a password when you cold boot the system.

Use the arrow keys to highlight "Set Supervisor Password" and press <Enter>.

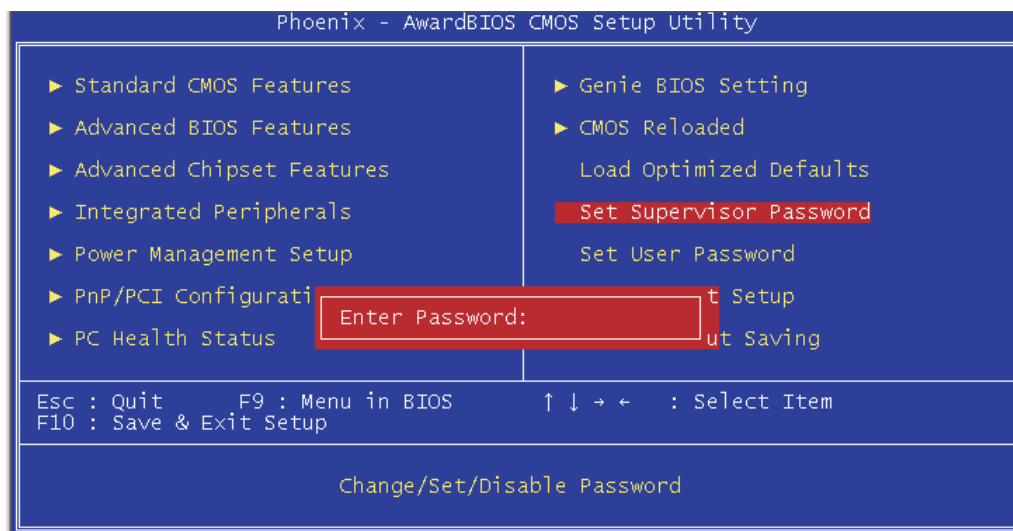

Type in the password. You are limited to eight characters. When done, the message below will appear:

Confirm Password:

You are asked to verify the password. Type in exactly the same password. If you type in a wrong password, you will be prompted to enter the correct password again. To delete or disable the password function, highlight "Set Supervisor Password" and press <Enter>, instead of typing in a new password. Press the <Esc> key to return to the main menu.

3.1.12 Set User Password

If you want another user to have access only to your system but not to setup, set a user's password with the "System" option selected in the Advanced BIOS Features. If you want a user to enter a password when trying to access setup, set a user's password with the "Setup" option selected in the Advanced BIOS Features.

Using user's password to enter Setup allows a user to access only "Set User Password" that appears in the main menu screen. Access to all other options is denied.

Use the arrow keys to highlight "Set User Password" and press <Enter>.

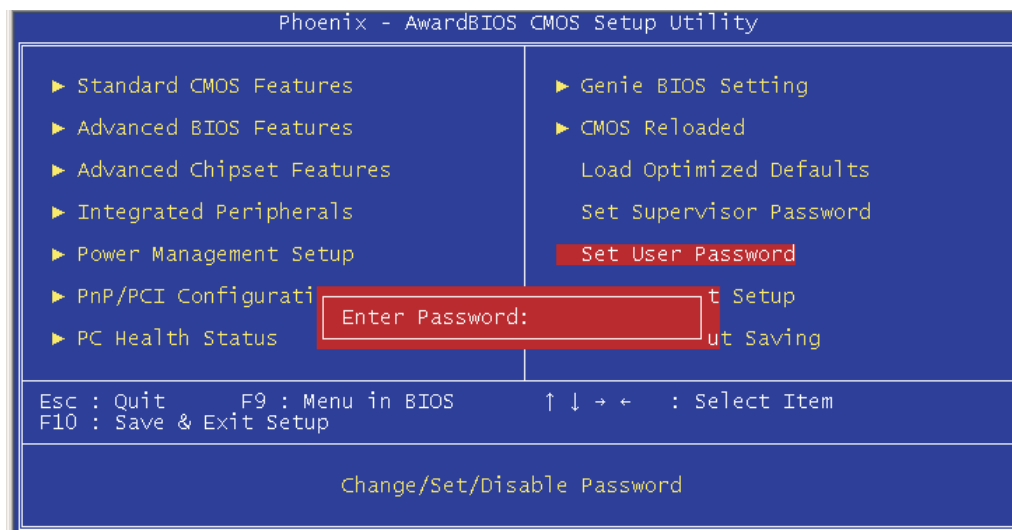

Type in the password. You are limited to eight characters. When done, the message below will appear:

Confirm Password:

You are asked to verify the password. Type in exactly the same password. If you type in a wrong password, you will be prompted to enter the correct password again. To delete or disable the password function, highlight "Set User Password" and press <Enter>, instead of typing in a new password. Press the <Esc> key to return to the main menu.

3.1.13 Save & Exit Setup

When all the changes have been made, highlight “Save & Exit Setup” and press <Enter>.

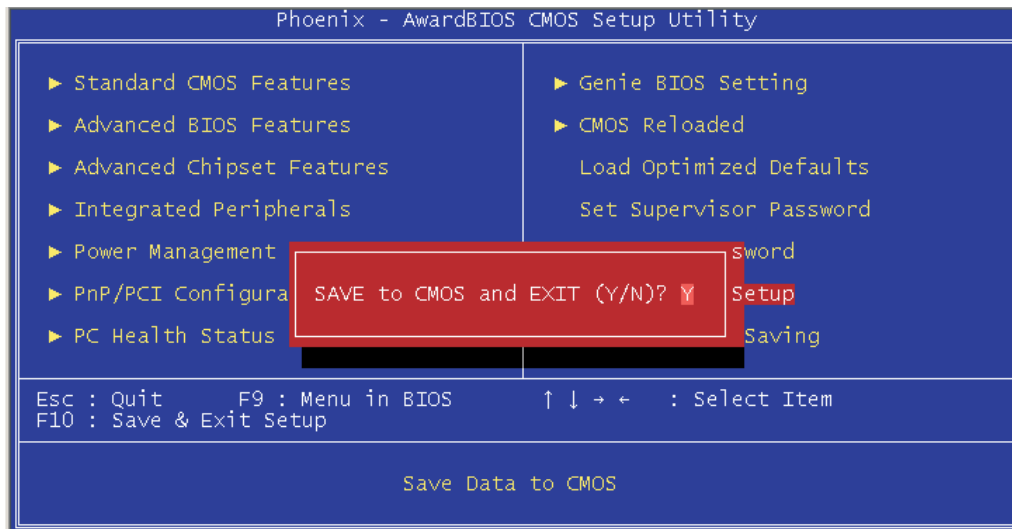

Type “Y” and press <Enter>. The modifications you have made will be written into the CMOS memory, and the system will reboot. You will once again see the initial diagnostics on the screen. If you wish to make additional changes to the setup, press <Ctrl> <Alt> <Esc> simultaneously or after memory testing is done.

3.1.14 Exit Without Saving

When you do not want to save the changes you have made, highlight “Exit Without Saving” and press <Enter>.

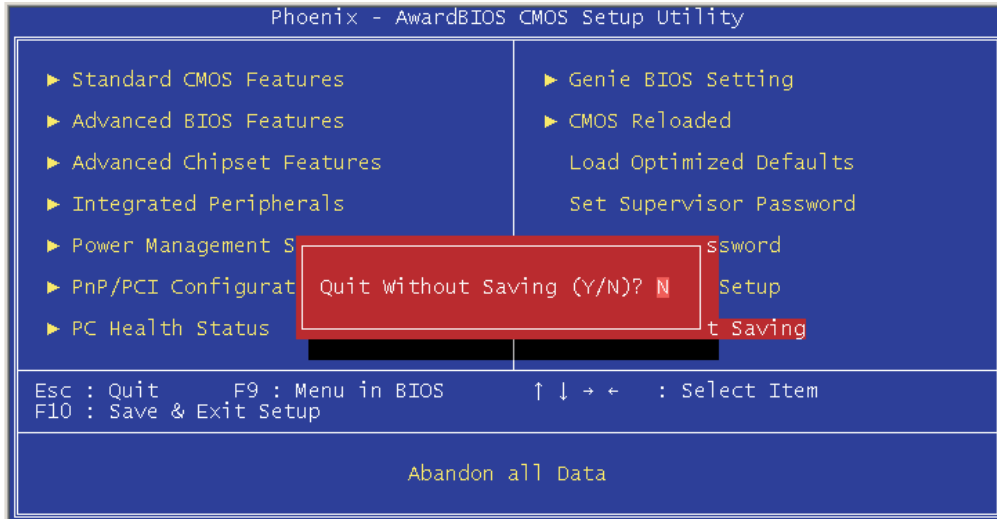

Type “Y” and press <Enter>. The system will reboot and you will once again see the initial diagnostics on the screen. If you wish to make any changes to the setup, press <Ctrl> <Alt> <Esc> simultaneously or after memory testing is done.

3.2 Intel ICH6R BIOS Setting Utility

The Intel ICH6R BIOS Setting Utility is used to configure and manage RAID on Serial ATA drives.



Important:

Before you run the Intel ICH6R BIOS Setting Utility, make sure "SATA Mode" ("OnChip IDE Device" section) in the Integrated Peripherals submenu of the Award BIOS is set to "RAID".

After you power up the system and all hard disk drives have been detected, the Intel RAID BIOS status message screen will appear. Press the <Ctrl> and <I> keys simultaneously to enter the utility. The utility allows you to build a RAID system with Windows® XP or Windows® 2000 installed on a RAID 0 or RAID 1 Volume using two Serial ATA (SATA) hard drives.

3.3 Updating the BIOS

To update the BIOS, you will need the new BIOS file and a flash utility, AWDFLASH.EXE. You can download them from DFI's web site or contact technical support or your sales representative.

**Note:**

AWDFLASH.EXE works only in DOS mode.

1. Save the new BIOS file along with the flash utility AWDFLASH.EXE to a floppy disk.
2. Reboot the system and enter the Award BIOS Setup Utility to set the first boot drive to "Floppy".
3. Save the setting and reboot the system.
4. After the system booted from the floppy disk, execute the flash utility by typing AWDFLASH.EXE. The following screen will appear:

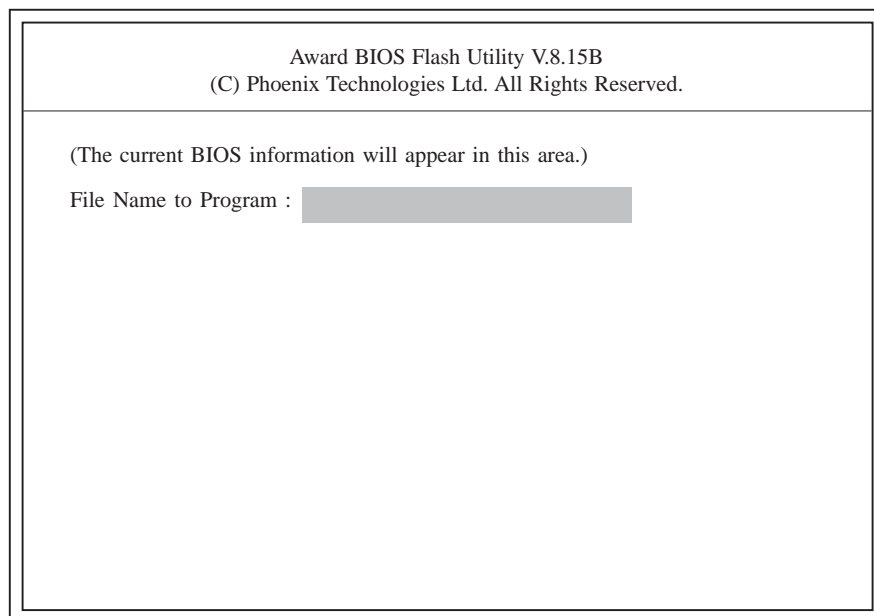

5. Type the new BIOS file name onto the gray area that is next to "File Name to Program" then press <Enter>.

6. The following will appear:

Do You Want to Save BIOS (Y/N)

This question refers to the current existing BIOS in your system. We recommend that you save the current BIOS and its flash utility; just in case you need to reinstall the BIOS. To save the current BIOS, press <Y> then enter the file name of the current BIOS. Otherwise, press <N>.

7. The following will then appear:

Press "Y" to Program or "N" to Exit

8. Press <Y> to flash the new BIOS.

Chapter 4 - Supported Software

4.1 Desktop Management Interface (DMI)

The system board comes with a DMI built into the BIOS. DMI, along with the appropriately networked software, is designed to make inventory, maintenance and troubleshooting of computer systems easier. With DMI, a network administrator or MIS engineer can remotely access some information about a particular computer system without physically going to it. Quite often a service call may be unnecessary as the problem can be solved remotely.

The DMI utility in the BIOS automatically records various information about your system configuration. Information about the type and speed of CPU, type and amount of memory for each memory slot, BIOS revision level, types of add-in PCI boards and components, certain revision numbers of hardware installed, etc. are automatically detected and stored in the DMI pool, which is a part of the system board's Plug and Play BIOS. Additional information, such as ISA based peripherals, which may not be automatically detected, can be manually recorded in the DMI pool by using the Add DMI menu. The DMI pool data is then verified or updated whenever the system hardware or setup is altered.

4.1.1 Running the DMI Utility

To run the DMI utility, type: DMICFG.EXE. You can download this utility from [ftp.dfusa.com](ftp://ftp.dfusa.com) - /utilities/DMI directory.

The DMI utility must run in real mode with at least 180K of base memory. Memory managers like HIMEM.SYS (required by Windows) must not be installed. You may do this by using one of the 3 methods listed below.

1. Boot up from a system diskette without the AUTOEXEC.BAT and CONFIG.SYS files,
2. "REM" HIMEM.SYS in the CONFIG.SYS, or
3. Press <F5> during bootup to bypass your AUTOEXEC.BAT and CONFIG.SYS files.

4.1.2 Using the DMI Utility

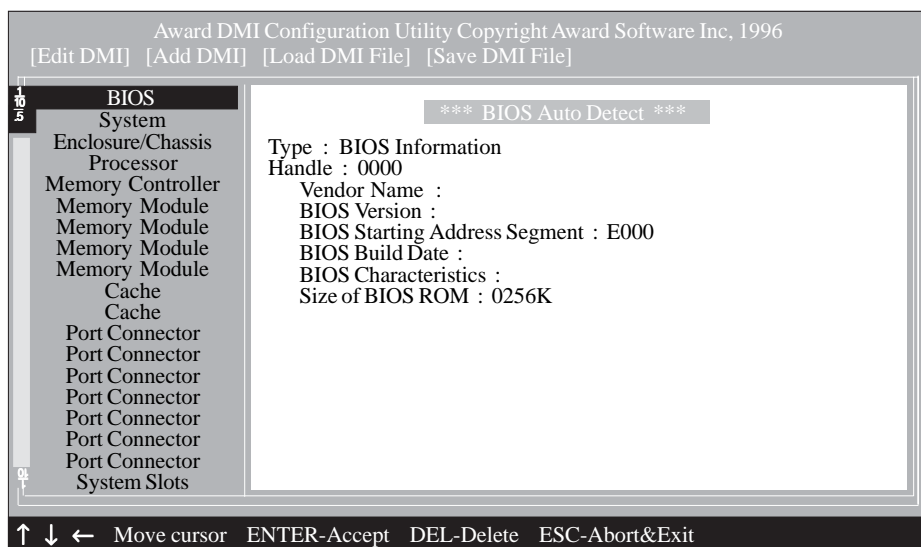

The four menus located on top of the DMI Configuration Utility screen are Edit DMI, Add DMI, Load DMI File and Save DMI File. Use the ← or → (left or right) arrow keys to select a menu from the Menu bar.

On the left side of the screen is a list of the system configuration items. Use the ↑ or ↓ (up or down) arrow keys to select an item.

The commands at the bottom of the screen will allow you to navigate through the various setup menus.

Edit DMI

1. Use the ← or → arrow keys to select the Edit DMI menu.
2. Highlight the item on the left screen that you would like to edit by using the ↑ or ↓ arrow keys, then press <Enter>.
3. The cursor will move to the screen you select allowing you to edit information. The screen will also display the auto-detected information.
4. Press <F10> to update the edited information into the flash ROM.

Add DMI

1. Use the ← or → arrow keys to select the Add DMI menu.
2. Highlight the item on the left screen that you would like to add by using the ↑ or ↓ arrow keys, then press <Enter>.
3. The cursor will move to the screen you select allowing you to enter information about the added item.
4. Press <F10> to save information into the flash ROM.

To view information about the added items, go to the Edit DMI menu.

Load DMI File

1. Use the ← or → arrow keys to select the Load DMI File menu.
2. The following message will appear:

Press [Enter] to select DMI file for load

Press <Enter>.

3. The DMI files will appear on the screen. Select the file you would like to load and press <Enter>.
4. The following message will appear:

Do you want to execute? (Y/N)

Type <Y>. All previous DMI structures will be destroyed and the new file will be saved into the flash ROM.

Save DMI File

1. Use the ← or → arrow keys to select the Save DMI File menu.
2. The following message will appear:

Press [Enter] to select DMI file for save

Press <Enter>.

3. Enter the directory and filename under which you would like the DMI file saved.

4.2 Drivers, Utilities and Software Applications

The CD that came with the system board contains drivers, utilities and software applications required to enhance the performance of the system board.

Insert the CD into a CD-ROM drive. The autorun screen (Mainboard Utility CD) will appear. If after inserting the CD, "Autorun" did not automatically start (which is, the Mainboard Utility CD screen did not appear), please go directly to the root directory of the CD and double-click "Setup".



4.2.1 Intel Chipset Software Installation Utility

The Intel Chipset Software Installation Utility is used for updating Windows® 2000/XP's INF files so that the Intel chipset can be recognized and configured properly in the system.

To install the utility, please follow the steps below.

1. On the left side of the autorun screen, click the “CHIPSET” icon.
2. Click “Intel Chipset Software Installation Utility” on the main menu. The following screen will appear:

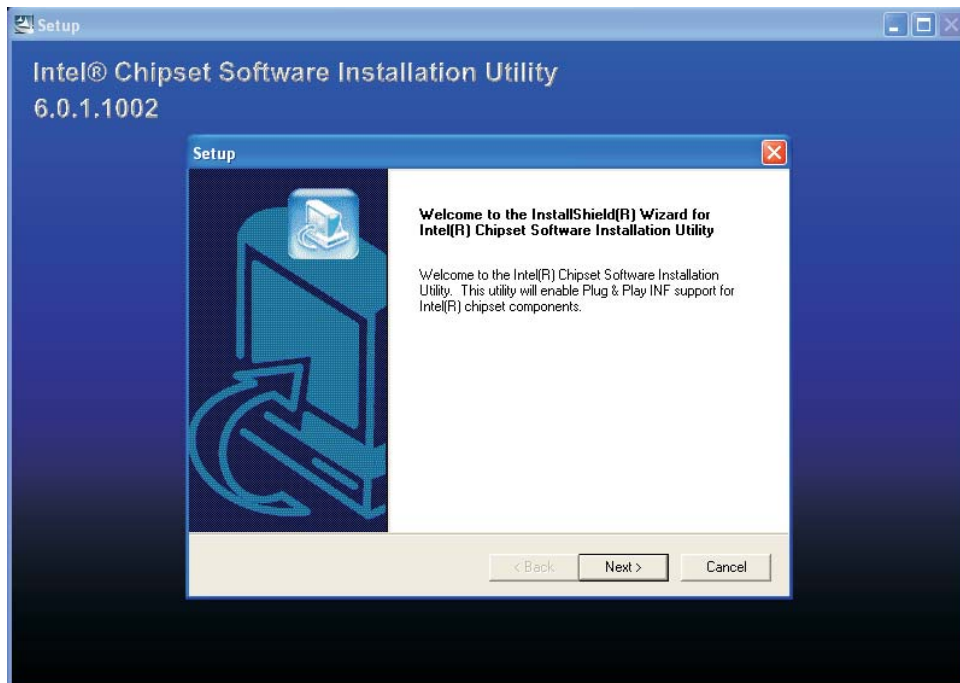

3. Follow the prompts on the screen to complete installation.
4. Reboot the system for the utility to take effect.

4.2.2 Audio Drivers

The Realtek audio drivers are supported in the following operating systems: Windows NT® 4.0, Windows® 2000 and Windows® XP.

To install the driver, please follow the steps below.

1. Click “Audio Drivers” on the main menu. The following screen will appear:



2. Follow the prompts on the screen to complete installation.
3. Reboot the system for the driver to take effect.

4.2.3 LAN Drivers

To install the driver, please follow the steps below.

1. On the left side of the autorun screen, click the “NETWORK” icon.
2. Click “LAN Drivers” on the main menu. The following screen will appear:



3. Follow the prompts on the screen to complete installation.
4. Reboot the system for the driver to take effect.

4.2.4 Intel ICH6R RAID Driver (for Windows XP and Windows 2000 only)

After the SATA drives have been configured with a RAID volume in the Intel ICH6R BIOS Setting Utility, you must install the ICH6R RAID driver.

To install the RAID driver:

1. Start Windows Setup by booting from the installation CD.
2. Press <F6> when prompted at the beginning of Windows setup.
3. Press <S> to select "Specify Additional Device".
4. At this point you should be prompted to insert a floppy disk containing the Intel RAID driver. Insert the "Intel ICH6R RAID Driver" diskette.
5. Select "Intel® 82801ER SATA RAID Controller" from the list then press <Enter>.
6. The next screen should confirm that you have selected the Intel(r) RAID controller. Press <Enter> again to continue.
7. Finish the Windows installation. Leave the floppy disk in the floppy drive until the system reboots itself. Windows setup will need to copy the files from the floppy disk again after the RAID volume is formatted, then Windows setup starts copying files.
8. Install the "Intel Application Accelerator RAID Edition" software. (Refer to the next page). This will add the Intel Application Accelerator RAID Edition user interface utility that can be used to manage the RAID configuration.

4.2.5 Intel Application Accelerator (for Windows XP and Windows 2000 only)

This utility is used to configure and manage RAID on Serial ATA drives.

To install the utility, please follow the steps below.

1. On the left side of the autorun screen, click the "TOOLS" icon.
2. Click "Intel Application Accelerator" on the main menu.
3. Follow the installation instructions shown on the screen.
4. Reboot the system for the driver to take effect.

4.2.6 Hardware Monitor

The system board comes with the Hardware Monitor utility contained in the provided CD. This utility is capable of monitoring the system's "health" conditions and allows you to manually set a range (Highest and Lowest Limit) to the items being monitored. If the settings/values are over or under the set range, a warning message will pop-up. The utility can also be configured so that a beeping alarm will sound whenever an error occurs. We recommend that you use the "Default Setting" which is the ideal setting that would keep the system in good working condition.

To install, please follow the steps below.

1. On the left side of the autorun screen, click the "TOOLS" icon.
2. Click "Hardware Monitor" on the main menu.
3. Follow the prompts on the screen to complete installation.
4. Reboot the system for the driver to take effect.

4.2.7 Microsoft DirectX 9

To install, please follow the steps below.

1. On the left side of the autorun screen, click the “TOOLS” icon.
2. Click “Microsoft DirectX 9” on the main menu. The following screen will appear:

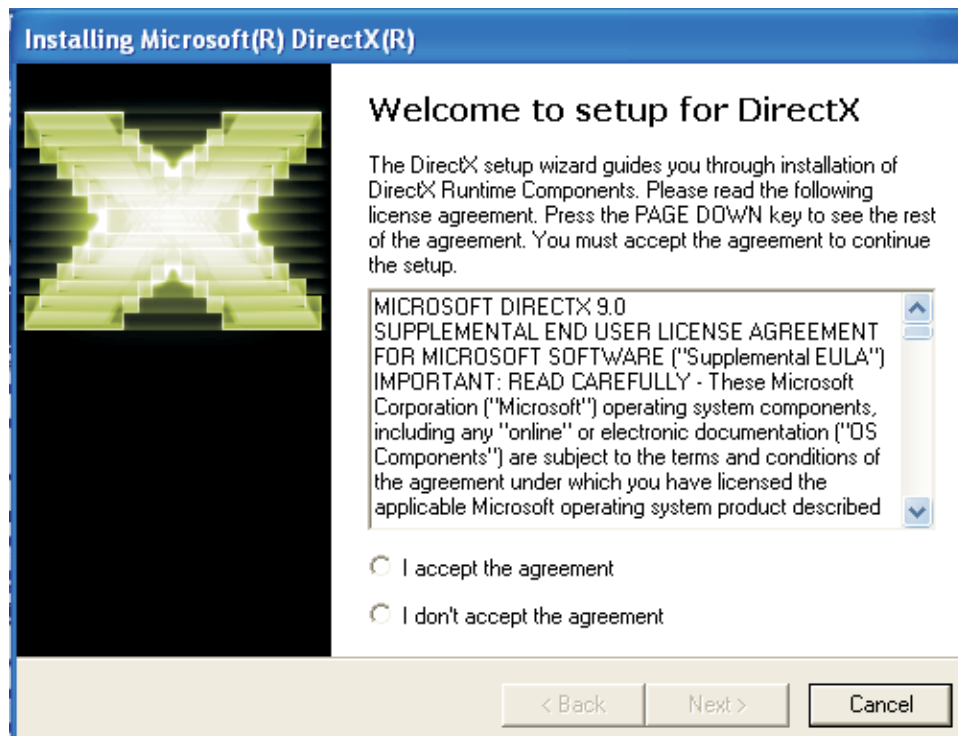

3. Click “I accept the agreement” then click “Next”.
4. Follow the prompts on the screen to complete installation.
5. Reboot the system for the driver to take effect.

4.2.8 WinFlash

WinFlash is a utility program that allows you to flash the BIOS under an operating system.

To install, please follow the steps below.

1. On the left side of the autorun screen, click the “TOOLS” icon.
2. Click “WinFlash” on the main menu. The following screen will appear:

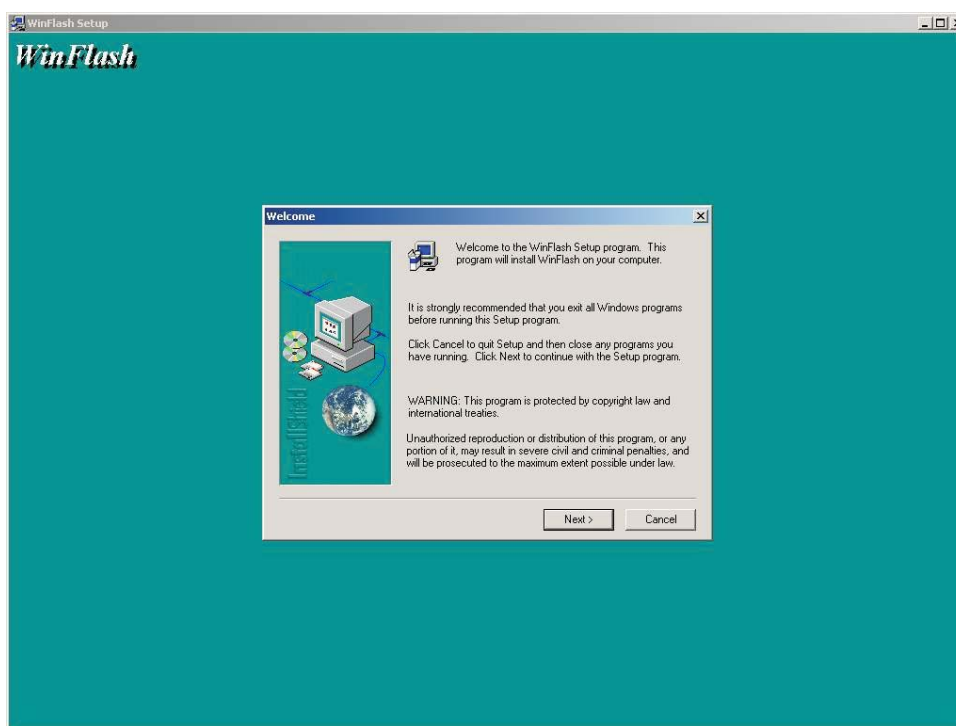

3. Follow the prompts on the screen to complete installation.
4. Restart the system.

To flash the BIOS, run the WinFlash utility.

4.3 Installation Notes

1. "Autorun" ONLY supports the Windows® 2000, Windows NT® 4.0 and Windows® XP operating systems. If after inserting the CD, "Autorun" did not automatically start (which is, the Main Board Utility CD screen did not appear), please go directly to the root directory of the CD and double-click "Setup".
2. All steps or procedures to install software drivers are subject to change without notice as the softwares are occasionally updated. Please go to DFI's web site at "<http://www.dfi.com/support1/download2.asp>" for the latest version of the drivers or software applications.

Appendix A - Enabling Hyper-Threading Technology

A.1 Enabling Hyper-Threading Technology

To enable the functionality of the Hyper-Threading Technology, please follow the requirements and steps below. Basically, the following presumes that you have already installed an Intel® Pentium® 4 Processor with Hyper-Threading Technology.

1. The system requires a minimum of 300 Watt ATX 12V power supply.
2. Aside from installing a CPU fan on the Intel® Pentium® 4 Processor with Hyper-Threading Technology, make sure to install cooling fans. The system requires adequate airflow throughout the chassis to prevent overheating the processor.
3. The “CPU Hyper-Threading” field in the Advanced BIOS Features submenu of the Award BIOS setup will appear. Make sure this field is set to Enabled.
4. Currently, only Windows® XP supports the Hyper-Threading Technology. If this OS has been previously installed, you must **REINSTALL** it.
5. After installing Windows® XP, please check the following to ensure that the operating system has been properly installed.
 - a. Click Start, point to Settings then click Control Panel.
 - b. Double-click the System icon. The System Properties dialog box will appear.

- c. Click the General tab. The processor shown under Computer should resemble the one shown below.

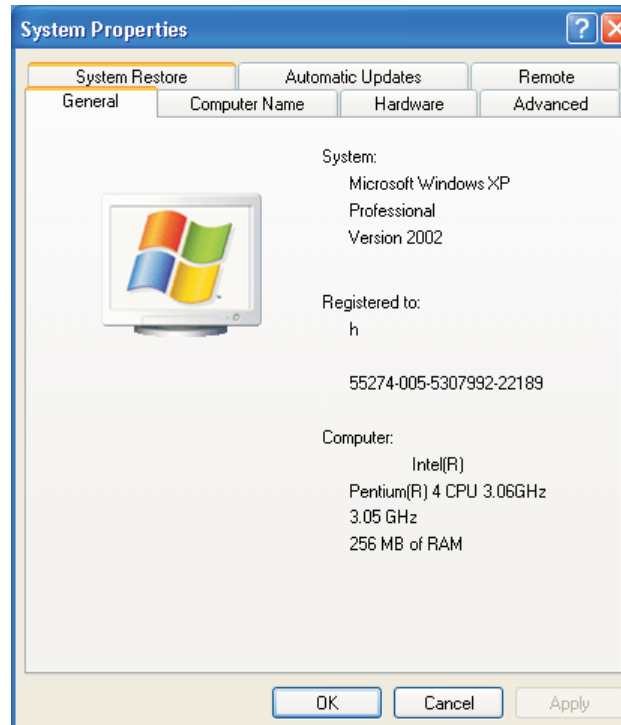

- d. Now click the Hardware tab then click Device Manager. The items shown under Computer and Processors should resemble the ones shown below.

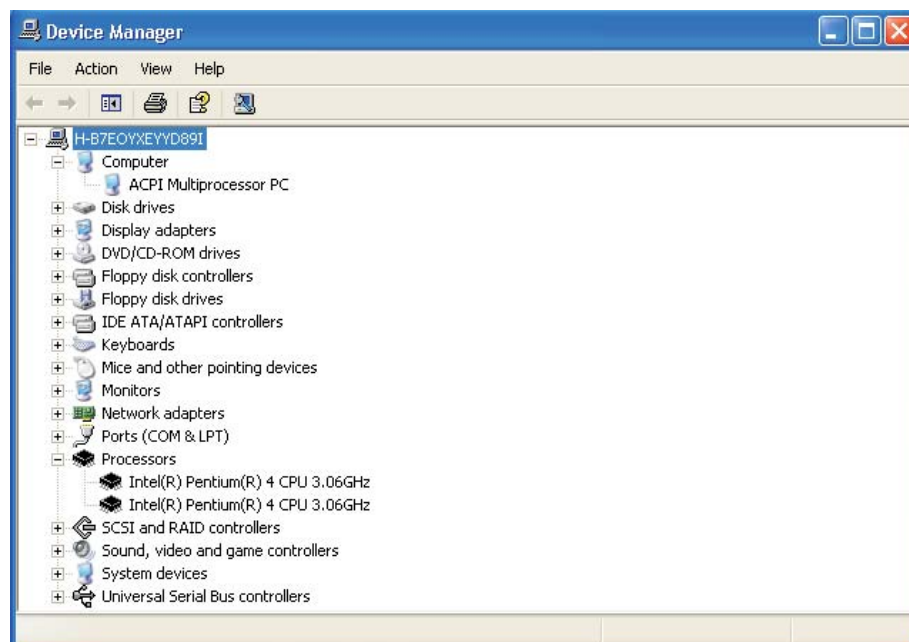

Enabling Hyper-Threading Technology

- e. Lastly, press the <Ctrl> <Alt> and keys simultaneously. The Windows Task Manager dialog box will appear. Click the Performance tab. The diagram under CPU Usage History should resemble the one shown below.

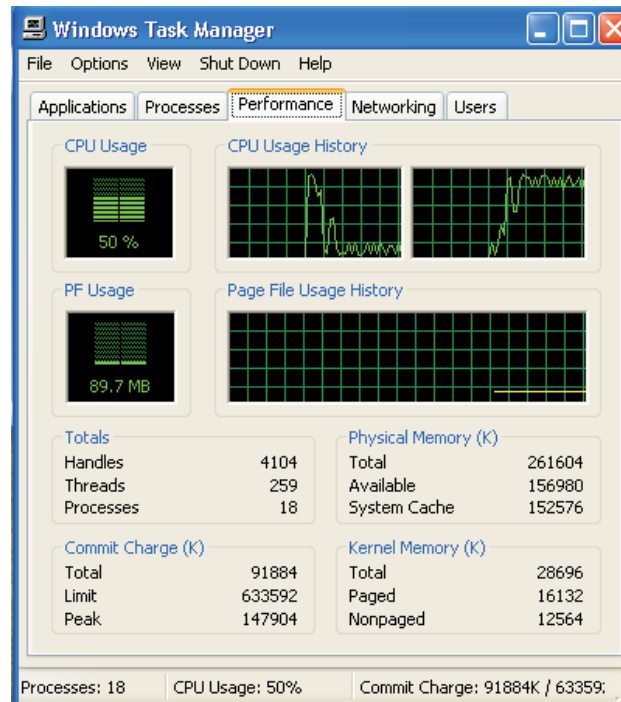

Appendix B - System Error Message

When the BIOS encounters an error that requires the user to correct something, either a beep code will sound or a message will be displayed in a box in the middle of the screen and the message, PRESS F1 TO CONTINUE, CTRL-ALT-ESC or DEL TO ENTER SETUP, will be shown in the information box at the bottom. Enter Setup to correct the error.

B.1 Error Messages

One or more of the following messages may be displayed if the BIOS detects an error during the POST. This list indicates the error messages for all Awards BIOSes:

CMOS BATTERY HAS FAILED

The CMOS battery is no longer functional. It should be replaced.



Caution:

Danger of explosion if battery incorrectly replaced. Replace only with the same or equivalent type recommended by the manufacturer. Dispose of used batteries according to the battery manufacturer's instructions.

CMOS CHECKSUM ERROR

Checksum of CMOS is incorrect. This can indicate that CMOS has become corrupt. This error may have been caused by a weak battery. Check the battery and replace if necessary.

DISPLAY SWITCH IS SET INCORRECTLY

The display switch on the motherboard can be set to either monochrome or color. This indicates the switch is set to a different setting than indicated in Setup. Determine which setting is correct, either turn off the system and change the jumper or enter Setup and change the VIDEO selection.

FLOPPY DISK(S) fail (80)

Unable to reset floppy subsystem.

FLOPPY DISK(S) fail (40)

Floppy type mismatch.

Hard Disk(s) fail (80)

HDD reset failed.

Hard Disk(s) fail (40)

HDD controller diagnostics failed.

Hard Disk(s) fail (20)

HDD initialization error.

Hard Disk(s) fail (10)

Unable to recalibrate fixed disk.

Hard Disk(s) fail (08)

Sector Verify failed.

Keyboard is locked out - Unlock the key

The BIOS detects that the keyboard is locked. Keyboard controller is pulled low.

Keyboard error or no keyboard present

Cannot initialize the keyboard. Make sure the keyboard is attached correctly and no keys are being pressed during the boot.

Manufacturing POST loop

System will repeat POST procedure infinitely while the keyboard controller is pull low. This is also used for the M/B burn in test at the factory.

BIOS ROM checksum error - System halted

The checksum of ROM address F0000H-FFFFFFH is bad.

Memory test fail

The BIOS reports memory test fail if the memory has error(s).

Appendix C - Troubleshooting

C.1 Troubleshooting Checklist

This chapter of the manual is designed to help you with problems that you may encounter with your personal computer. To efficiently troubleshoot your system, treat each problem individually. This is to ensure an accurate diagnosis of the problem in case a problem has multiple causes.

Some of the most common things to check when you encounter problems while using your system are listed below.

1. The power switch of each peripheral device is turned on.
2. All cables and power cords are tightly connected.
3. The electrical outlet to which your peripheral devices are connected is working. Test the outlet by plugging in a lamp or other electrical device.
4. The monitor is turned on.
5. The display's brightness and contrast controls are adjusted properly.
6. All add-in boards in the expansion slots are seated securely.
7. Any add-in board you have installed is designed for your system and is set up correctly.

Monitor/Display

If the display screen remains dark after the system is turned on:

1. Make sure that the monitor's power switch is on.
2. Check that one end of the monitor's power cord is properly attached to the monitor and the other end is plugged into a working AC outlet. If necessary, try another outlet.
3. Check that the video input cable is properly attached to the monitor and the system's display adapter.
4. Adjust the brightness of the display by turning the monitor's brightness control knob.

The picture seems to be constantly moving.

1. The monitor has lost its vertical sync. Adjust the monitor's vertical sync.
2. Move away any objects, such as another monitor or fan, that may be creating a magnetic field around the display.
3. Make sure your video card's output frequencies are supported by this monitor.

The screen seems to be constantly wavering.

1. If the monitor is close to another monitor, the adjacent monitor may need to be turned off. Fluorescent lights adjacent to the monitor may also cause screen wavering.

Power Supply

When the computer is turned on, nothing happens.

1. Check that one end of the AC power cord is plugged into a live outlet and the other end properly plugged into the back of the system.
2. Make sure that the voltage selection switch on the back panel is set for the correct type of voltage you are using.
3. The power cord may have a "short" or "open". Inspect the cord and install a new one if necessary.

Floppy Drive

The computer cannot access the floppy drive.

1. The floppy diskette may not be formatted. Format the diskette and try again.
2. The diskette may be write-protected. Use a diskette that is not write-protected.
3. You may be writing to the wrong drive. Check the path statement to make sure you are writing to the targeted drive.
4. There is not enough space left on the diskette. Use another diskette with adequate storage space.

Hard Drive

Hard disk failure.

1. Make sure the correct drive type for the hard disk drive has been entered in the BIOS.
2. If the system is configured with two hard drives, make sure the bootable (first) hard drive is configured as Master and the second hard drive is configured as Slave. The master hard drive must have an active/bootable partition.

Excessively long formatting period.

If your hard drive takes an excessively long period of time to format, it is likely a cable connection problem. However, if your hard drive has a large capacity, it will take a longer time to format.

Parallel Port

The parallel printer doesn't respond when you try to print.

1. Make sure that your printer is turned on and that the printer is on-line.
2. Make sure your software is configured for the right type of printer attached.
3. Verify that the onboard LPT port's I/O address and IRQ settings are configured correctly.
4. Verify that the attached device works by attaching it to a parallel port that is working and configured correctly. If it works, the printer can be assumed to be in good condition. If the printer remains inoperative, replace the printer cable and try again.

Serial Port

The serial device (modem, printer) doesn't output anything or is outputting garbled characters.

1. Make sure that the serial device's power is turned on and that the device is on-line.
2. Verify that the device is plugged into the correct serial port on the rear of the computer.

3. Verify that the attached serial device works by attaching it to a serial port that is working and configured correctly. If the serial device does not work, either the cable or the serial device has a problem. If the serial device works, the problem may be due to the onboard I/O or the address setting.
4. Make sure the COM settings and I/O address are configured correctly.

Keyboard

Nothing happens when a key on the keyboard was pressed.

1. Make sure the keyboard is properly connected.
2. Make sure there are no objects resting on the keyboard and that no keys are pressed during the booting process.

System Board

1. Make sure the add-in card is seated securely in the expansion slot. If the add-in card is loose, power off the system, re-install the card and power up the system.
2. Check the jumper settings to ensure that the jumpers are properly set.
3. Verify that all memory modules are seated securely into the memory sockets.
4. Make sure the memory modules are in the correct locations.
5. If the board fails to function, place the board on a flat surface and seat all socketed components. Gently press each component into the socket.
6. If you made changes to the BIOS settings, re-enter setup and load the BIOS defaults.