

# **PowerPro TX**

**Solid Technology for Superior System**

---

**ATX Main Board**

**User Manual v2.0**



# Table of Contents

---

|   |           |
|---|-----------|
| <b>CHAPTER 1 INTRODUCTION</b>           | <b>1</b>  |
| ① SPECIFICATIONS                        | 2         |
| ② LAYOUT DIAGRAM                        | 4         |
| ③ SYSTEM BLOCK DIAGRAM                  | 5         |
| <b>CHAPTER 2 MAINBOARD INSTALLATION</b> | <b>6</b>  |
| ① EXTERNAL CONNECTORS                   | 8         |
| ② JUMPERS AND SWITCHES                  | 15        |
| ③ CPU INSTALLATION                      | 16        |
| ④ MEMORY MODULE INSTALLATION            | 19        |
| <b>CHAPTER 3 SYSTEM BIOS</b>            | <b>21</b> |
| ① CPU SOFT MENU™                        | 23        |
| ② STANDARD CMOS SETUP MENU              | 29        |
| ③ BIOS FEATURES SETUP MENU              | 31        |
| ④ CHIPSET FEATURES SETUP MENU           | 36        |
| ⑤ POWER MANAGEMENT SETUP MENU           | 38        |
| ⑥ PCI & ONBOARD I/O SETUP               | 42        |
| ⑦ LOAD BIOS DEFAULTS                    | 47        |
| ⑧ LOAD SETUP DEFAULTS                   | 47        |
| ⑨ PASSWORD SETTING                      | 48        |
| ⑩ IDE HDD AUTO DETECTION                | 49        |
| <b>APPENDIX A QUICK INSTALLATION</b>    | <b>1</b>  |
| <b>APPENDIX B INTEL PENTIUM CPUS</b>    | <b>1</b>  |

|                                      |                 |
|--------------------------------------|-----------------|
| <b><u>APPENDIX C AMD-K5 CPUS</u></b> | <b><u>1</u></b> |
|--------------------------------------|-----------------|

|  |                 |
|--|-----------------|
| <b><u>APPENDIX D CYRIX 6X86 CPUS</u></b> | <b><u>1</u></b> |
|--|-----------------|

|   |                 |
|---|-----------------|
| <b><u>APPENDIX E HDD INSTALLATION</u></b> | <b><u>1</u></b> |
|---|-----------------|

|  |                 |
|--|-----------------|
| <b><u>APPENDIX F TECHNICAL SUPPORT</u></b> | <b><u>1</u></b> |
|--|-----------------|

|   |                 |
|---|-----------------|
| <b><u>APPENDIX G FLASH BIOS UPGRADE</u></b> | <b><u>1</u></b> |
|---|-----------------|

# Chapter 1 Introduction

The PowerPro TX have been especially designed for file server, workstation and professional users. It can support a wide range of processors, including all up-to-date Intel Pentium processors, AMD K5/K6 processors, and as well as Cyrix 6x86/6x86L/6x86MX processors. It also takes into account, as much as possible, all future CPUs.

The PowerPro TX uses **SOFT MENU™ technology**, which means that all the processor's parameters can be configured without using DIP switches or hardware jumpers. The configuration is entirely achieved through a "Soft Switch" that allows the user to set CPU speed and operating voltage with ease.

The PowerPro TX uses Intel 430TX series chipsets with 512K Level-2 Pipeline Burst SRAM on board. Four 168-pin DIMM slots meet the requirements for all memory configurations required by high level computing. The 168-pin DIMM slots support fast page DRAM, EDO DRAM, and SDRAM for next generation 64-bit systems.

The PowerPro TX also provides two Universal Serial Bus (USB) ports and meets the Concurrent PCI Rev. 2.1 standard. It also supports IDE interface for Fast HDD (Mode 0~4) and Ultra DMA/33, as well as IDE Bus Master. These features also meet present and future interface standards and needs.

System BIOS features include Plug-and-Play (PnP), Advanced Configuration Power Interface (ACPI), the newest Desktop Management Interface (DMI), as well as PowerPro TX's unique CPU operating frequency and voltage setup feature in order to meet modern computing demands.

# Chapter 1

---

## ① SPECIFICATIONS

### 1. CPU “SOFT MENU™”

- Setup of the mainboard’s frequency and voltage without DIP Switches or Jumpers.
- Modification of CPU operating voltage and frequency through software configuration.
- Modification of CPU operating voltage and frequency directly on screen.

### 2. Versatile CPU ZIF Socket 7

- Utilizing switching type voltage regulator for a more stable CPU operating environment
- Supports 50, 55, 60, 66 MHz bus clock and as well as 75/83MHz bus clock reserved.
- Supports Intel Pentium® CPUs: 100MHz to 200MHz and Pentium with MMX processors from 166MHz to 233MHz.
- Supports AMD-K5™ CPUs: 133MHz/166MHz, AMD-K6™ CPUs: 200MHz and 233MHz
- Supports Cyrix 6x86™ CPUs: P120+, P133+, P150+, P166+, and 6x86MX
- Reserved circuitry to support future CPUs

### 3. Chipset

- Intel 430TX chipset
- Supports standard version PCI 2.1

### 4. L2 Cache Memory

- Built-in 512K Pipeline Burst SRAM cache memory

## 5. System DRAM

- Four 168-pin **DIMM** sockets can support FP, EDO and Synchronous DRAM (SDRAM) for up to 256MB memory size.

## 6. System BIOS

- AWARD BIOS
- Built-in user-friendly SOFT-Menu to set all CPU parameters.
- Supports Plug-and-Play (PnP)
- Supports Advanced Configuration Power Interface (ACPI)
- Supports Desktop Management Interface (DMI)

## 7. Multi I/O features

- Built-in two Universal Serial Bus (USB) ports
- Two fast IDE channels (PIO mode 0~4, Ultra “DMA/33” and Bus Master) supporting four IDE devices
- One EPP/ECP parallel port and two 16550 serial ports
- Two floppy disk drive connectors (FDD) (360K, 720K, 1.2M, 1.44M and 2.88M)

## 8. Other features

- Standard ATX architecture dimensions (244mm x 305mm)
- Four ISA bus slots and four PCI bus slots
- Supports two bootable hard disks to run two different operating systems

Note: All brand names and trademarks are the property of their respective owners.

# Chapter 1

## ② LAYOUT DIAGRAM

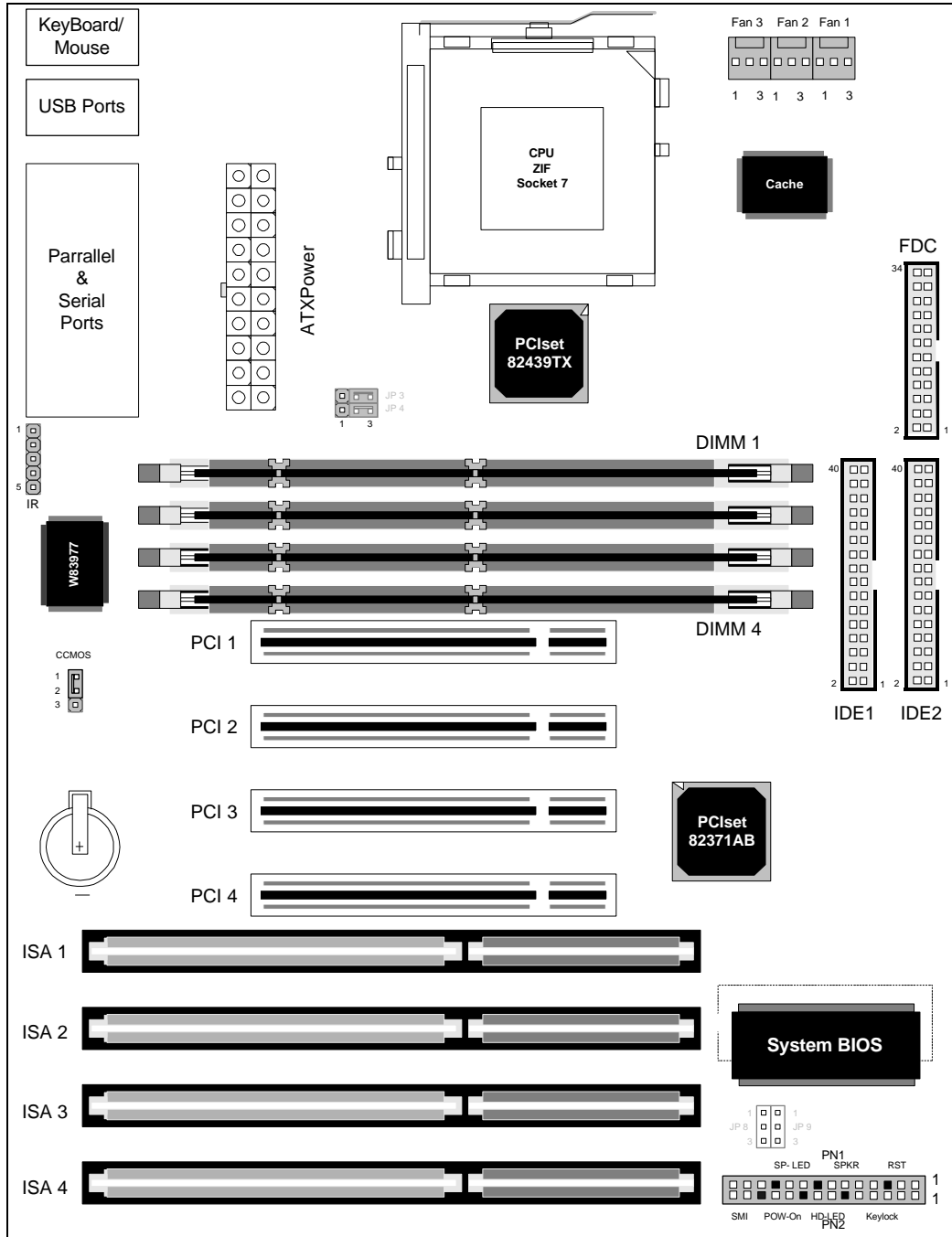

Fig 1-1 Board Layout © 1997 Jaton Corp.



③ SYSTEM BLOCK DIAGRAM

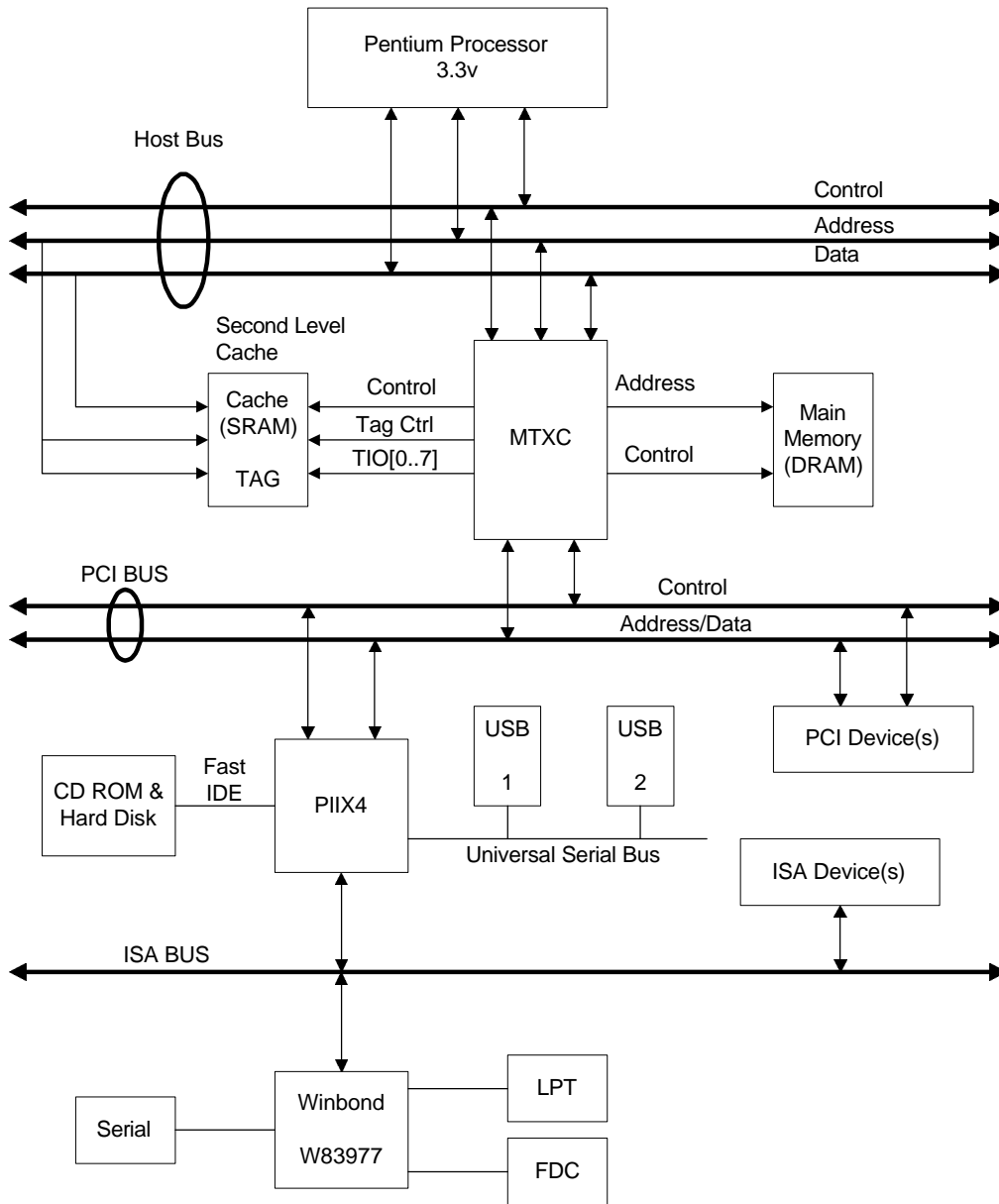

Fig. 1-2 System block diagram

## Chapter 2

---

# Chapter 2 Mainboard Installation

This PowerPro TX mainboard not only provides all standard equipment for classic personal computers, but also provides great flexibility for meeting future upgrade demands. This chapter will introduce step by step all the standard equipment and will also present, as completely as possible future upgrade capabilities. This mainboard is able to support all Intel Pentium including P54C , P55C , Cyrix 6x86, 6x86L, 6x86MX and AMD-K5, K6 processors now on the market. (For details, see specifications in Chapter 1.) However, we cannot guarantee that the description given in this manual on the circuitry of your mainboard will work for processors not listed in Chapter 1. For example, the operating voltage of Cyrix's next generation CPUs is unknown at the present time. Thus we were not able to include these specifications in your motherboard. We will supply further information about CPU support when new CPUs arrive on the market.

This chapter is organized according the following features:

- Standard external connectors
- Jumpers and switches
- Presentation and Installing of the CPU.
- Installing the system memory.

### **Before proceeding with the installation**

---

- Note to use a power supply that is specially optimized for ATX since this main board is of ATX form factor.
- **Before installing the mainboard or making any hardware modification, be sure to either the mechanical switch of ATX power supply is turn off or the electric power cord is unplugged** to avoid any damages to the hardware. Please note only turning off soft power button on the front panel of ATX computer case will still leave some standby voltage on the mainboard, it is not safe enough to plug or unplug any add-on cards or perform other activities may cause short circuit.

# Mainboard Installation

---



## User friendly instructions

---

Our objective is to enable the novice computer user to perform the installation by themselves. We have attempted to write this document in a very clear, concise and descriptive manner to help overcome any obstacles you may face during installation. Please read our instructions carefully and follow them carefully step-by-step.

## Chapter 2

---

### ① EXTERNAL CONNECTORS

Inside the case of any computer several cables and plugs have to be connected. These cables and plugs are usually connected one-by-one to connectors located on the mainboard. You need to pay close attention to the orientation of the cables and notice the position of the first pin, if any, of the connector.

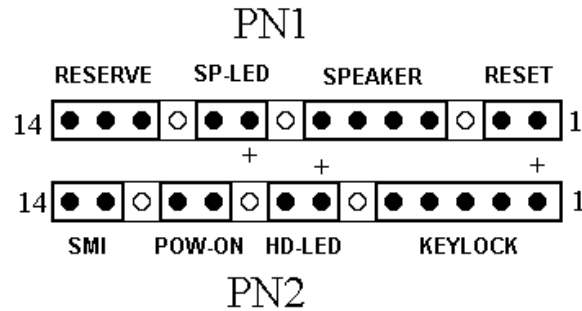

### PN2 - Keylock connector

*Please pay attention to pin position and orientation*

This connector has a specific orientation. Connect the five-thread keylock connector cable to the PN2 connector pins on the mainboard. Certain types of cases have a separated connector for Power LED indicator and Keylock connector.

| Pin number | Name or significance of signal     |
|------------|------------------------------------|
| 1          | +5VDC [ also for power LED]        |
| 2          | No connection[ also for power LED] |
| 3          | Ground[ also for power LED]        |
| 4          | Keyboard inhibit Signal            |
| 5          | Ground                             |

The “keylock” is used to lock the computer’s keyboard. When you lock the keyboard, the computer keyboard will not function unless it is unlocked.

# Mainboard Installation

---

## PN2 - SMI (Hardware Suspend) switch

There is no specific orientation. Connect the two-thread hardware suspend plug to the PN2 connector pins on the mainboard. Since most cases do not support this feature, you may ignore this connection. Furthermore, this feature is not necessary as it is already a part of the mainboard.

| Pin number | Name or significance of the signal |
|------------|------------------------------------|
| 13         | +3VDC                              |
| 14         | Suspend                            |

## PN2 - HD-LED (HDD LED) connector

This connector has a specific orientation. Connect the two-thread IDE LED connector cable attached to the case to the IDE LED connector on the mainboard.

| Pin number | Name or significance of signal |
|------------|--------------------------------|
| 8          | LED's Cathode                  |
| 7          | LED's Anode                    |

## PN2 - POW-ON (Power-ON/OFF) switch

There is no specific orientation. Connect the two-thread power button cable to the PN2 connector pins on the mainboard. For ATX power supply only.

| Pin number | Name or significance of signal |
|------------|--------------------------------|
| 10         | Ground                         |
| 11         | Power-on Signal                |

## Warning:

For those ATX power supply without a Power ON/OFF switch, keep the Power Core unplugged while you are working on the PC hardware.

## PN1 - Speaker connector

There is no specific orientation. Connect the four-thread speaker cable to the PN1 connector pins on the mainboard.

| Pin number | Name or significance of signal |
|------------|--------------------------------|
| 4          | +5VDC                          |
| 5          | Ground                         |
| 6          | Ground                         |

## Chapter 2

---

|   |              |
|---|--------------|
| 7 | Sound Signal |
|---|--------------|

# Mainboard Installation

---

## PN1 - SP-LED connector

This connector has a specific orientation. Connect the two-thread Sleep LED connector cable attached to the case to the SP-LED connector on the mainboard.

| Pin number | Name or significance of signal |
|------------|--------------------------------|
| 10         | LED's Cathode                  |
| 9          | LED's Anode                    |

## PN1 - REST (Hardware Reset) switch

There is no specific orientation. Connect the two-thread hardware reset cable to the PN1 connector pins on the mainboard.

| Pin number | Name or significance of signal |
|------------|--------------------------------|
| 1          | Hardware reset signal          |
| 2          | Ground                         |

## FAN1/FAN2/FAN3 - CPU Fan power

This connector has a specific orientation. Connect the three-threads CPU fan cable to the FAN1 connector. The FAN2 and FAN3 are reserved for future use.

| Pin number | Name of the signal or signification |
|------------|-------------------------------------|
| 1          | N.C                                 |
| 2          | +12V                                |
| 3          | control signal                      |

## IR - Infrared remote Connectors

*Watch the pin number and the orientation*

You must to have an infrared interface device to use an IR remote device. There are two types of connection for your IR interface device, one is to connect it to the main board 5-pin IR header, the other is to connect the IR device to the COM2 port.

| Pin number | Name of the signal or signification |
|------------|-------------------------------------|
| 1          | +5VDC                               |
| 2          | Fast receive data                   |
| 3          | Receive data                        |
| 4          | Ground                              |
| 5          | Transmit data                       |

## Chapter 2

---

### ATXPWR1 - ATX Power connector

These have a specific orientation. The three warning marks indicate that if you make a mistake in pin number or connection orientation, you could destroy your equipment. During installation, you just need to connect to the correct pins and in the correct orientation, and to connect connector of the power supply unit to the connector on the mainboard.

| Pin number | Name of the signal or signification | Pin number | Name of the signal or signification |
|------------|-------------------------------------|------------|-------------------------------------|
| 1          | +3.3VDC                             | 11         | +3.3VDC                             |
| 2          | +3.3VDC                             | 12         | -12VDC                              |
| 3          | Ground                              | 13         | Ground                              |
| 4          | +5VDC                               | 14         | PS_ON                               |
| 5          | Ground                              | 15         | Ground                              |
| 6          | +5VDC                               | 16         | Ground                              |
| 7          | Ground                              | 17         | Ground                              |
| 8          | POWERGOOD                           | 18         | -5VDC                               |
| 9          | +5VDC                               | 19         | +5VDC                               |
| 10         | +12VDC                              | 20         | +5VDC                               |



# Mainboard Installation

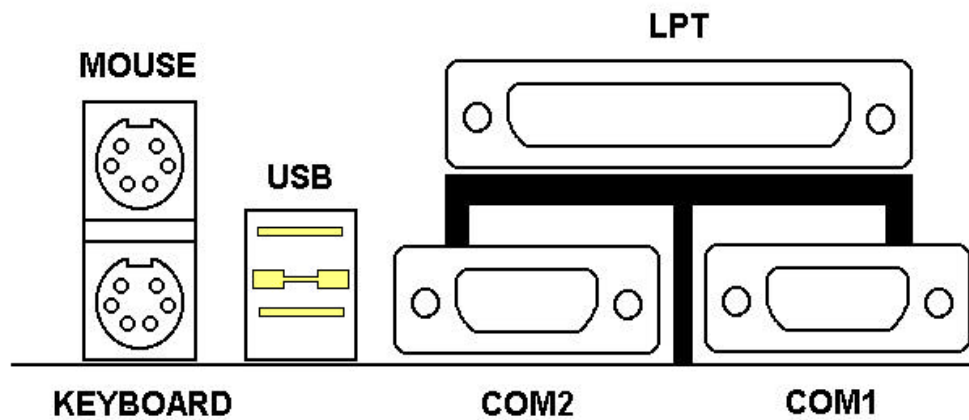

Mechanics of Mouse/Keyboard/USB/COM1/COM2/LPT

## Mouse - PS/2 Mouse connector

This connector has an orientation pin. Match the PS/2 Mouse connector and plug it into the mainboard PS/2 Mouse port.

| Pin number | Name of the signal or signification |
|------------|-------------------------------------|
| 1          | Mouse data                          |
| 2          | No connection                       |
| 3          | Ground                              |
| 4          | +5VDC                               |
| 5          | Ground                              |
| 6          | Mouse clock                         |

The “PS/2 Mouse Port” is different from COM1 or COM2 serial port to which you can also connect a Mouse. If you cannot find any PS/2 Mouse, you can still use COM1 or COM2 to connect a serial mouse to your computer.

## Chapter 2

---

### Keyboard - PS/2 Keyboard Connector

This connector has an orientation pin. Match and plug your PS/2 keyboard connector to the connector on the mainboard.

| Pin number | Name of the signal or signification |
|------------|-------------------------------------|
| 1          | Keyboard data                       |
| 2          | No connection                       |
| 3          | Ground                              |
| 4          | +5VDC                               |
| 5          | Ground                              |
| 6          | Keyboard clock                      |

### I/O Port connectors

*Watch the pin number and the orientation*

| Connector name | Pin number | Name of the peripheral connected |
|----------------|------------|----------------------------------|
| IDE 1          | 40         | IDE Channel 1                    |
| IDE 2          | 40         | IDE Channel 2                    |
| FDC            | 34         | Floppy Disk connector            |
| LPT            | 25         | Parallel port connector          |
| COM1           | 9          | Serial port COM1 connector       |
| COM2           | 9          | Serial port COM2 connector       |
| USB            | 16         | Universal Serial Bus connector   |

## ② JUMPERS AND SWITCHES

### **CCMOS** : Delete the contents of the CMOS

This jumper is set on pins 1 and 2 at the factory default. This jumper is used for clearing BIOS setup data in CMOS when you experience difficulties. For instance:

- You have forgotten the password you set.
- You have inappropriately setup the BIOS, and the system become unstable.
- You want to change the flash BIOS to a different version.

First turn off the power switch or unplug the power core to your PC and open the computer cover, then locate the CCMOS jumper (near the Lithium battery) and replace the jumper on pins 2 and 3 for a couple of seconds, then put the jumper back to operation position Pin 1 and 2 to erase the CMOS.

After you have deleted the CMOS information, you need to go back to the BIOS Setup menu, and reset all the items correctly, such as, CPU, date, hour, FDD and HDD parameters, and etc.

**JP8:** Factory reserved jumper for different brand of flash ROM.  
It must be fixed at pin 2 and pin 3.

**JP9:** Factory reserved jumper for different brands of flash ROM.  
It must be left as blank.

**JP3 and JP4** : Select the working voltage of DIMM memory.

Both JP3 and JP4 are is on pin 2 and pin 3 at the factory for industrial standard 3.3V DIMM memory.

You may set JP3 and JP4 on pin 1 and pin 2 for some special designed 5V DIMM memory.

## Chapter 2

---

### ③ CPU INSTALLATION

#### Jumperless CPU Configuration Mainboard

You do not need to setup any jumpers or switches on the PowerPro TX mainboard for CPU.

Most other main boards require you setup a bunch of jumpers or DIP switches for the type of the CPU you plan to install. Not so with PowerPro TX mainboard. You do not need to adjust any jumper or switch on the board for your CPU. The CPU is easily setup by software. After you have inserted the CPU into the ZIF (Zero Insertion Force) CPU socket, and other necessary display interface, you can simply turn the computer on. The only thing you will need to do next is to enter BIOS SETUP to configure the CPU speed or enter certain CPU parameters if the CPU speed is listed in the CPU SOFT MENU™. However, even if you don't need to setup any switch for your CPU, we still recommend you to read our presentation of the CPUs. It will be useful information for you.

Since 1996, every two or three months, Intel adds some new models to the Pentium CPU series. With other CPU manufactures introducing new CPU at similar pace, the CPU market is filled with a lot of different brands and models. All CPUs have different electrical specifications. That's why installing a CPU is becoming more and more complex.

The PowerPro TX mainboard simplified the CPU installation procedure by eliminating all the jumpers for CPU. It not only supports all the CPUs listed in the specifications, but also reserved several circuits in order to be able to support future processors. However, we must clarify that "we have only tested the CPUs listed in Chapter 1", we cannot guarantee that this board will be able to support future products, because we cannot forecast future developments.

#### **Related terminology :**

##### **External clock**

Also referred to as the external CPU clock, or "Bus clock", it is the input clock of the CPU. For instance, Intel Pentium P90, P120 and P150 all have a 60MHz external CPU clock, but have different internal clock multiplier factors.

##### **Clock multiplier factor**

The real operation clock within the CPU is the multiple of the external clock. We refer to this factor as the clock multiplier factor. The four factors possible are 1.5, 2, 2.5 and 3. The factor differs from one CPU to another. For instance, the Intel Pentium 166 CPU has a 66MHz external clock, with a multiplier factor of 2.5, so

# Mainboard Installation

---

that the speed of the internal clock is 66MHz x 2.5.

## **Internal clock**

Also referred to as the real internal CPU clock, it is the actual internal operating clock of the CPU. The Internal Clock is a multiple of the external clock and of the clock multiplier factor. For instance, the Intel Pentium 90 CPU has a 60MHz external clock and its clock multiplier factor is 1.5; the Intel Pentium P133 CPU has a 66MHz external clock and its clock multiplier factor is 2.

Internal CPU clock = clock multiplier factor \* external CPU clock

## **AT Bus clock**

Also referred to as ISA SPEED, or AT CLOCK, or even ISA Bus clock. Ten years ago, the original specification of AT Bus clock installed in the first generation PC/AT computers was 8MHz, this means that there are some interface cards which can only work at 8MHz. In order to guarantee compatibility with older hardware, we still support 8MHz AT Bus clock, but if your interface card is newer or faster, you can choose a higher speed for the AT Bus clock, in order to increase the transmission rate of the interface cards. But we recommend you not to be too ambitious. An 8MHz setup ensures maximum compatibility.

## **CPU Voltage - Vcore and Vio**

From the voltage point of view, 586 series CPU can be divided into two categories: Single Voltage CPU and Dual Voltage CPUs. Single voltage CPUs include: Intel Pentium P54C series, AMD-K5 and Cyrix 6x86, etc.

Dual voltage CPUs include: Intel P55C with MMX, future AMD CPUs, Cyrix 6x86L and M2.

Dual voltage CPUs requires two different voltages for the power source: Core Voltage (Vcore) and IO Voltage (Vio). Vcore provides all the power for internal processing, and its power consumption is quite important. Vio provides the power necessary for the external interface of the CPU.

## Chapter 2

---

### **P-Rating**

The P-Rating is defined by some CPU manufacturers other than Intel to rate the performance of their CPU in comparison with Intel Pentium CPUs. For instance, Cyrix 6x86 P166+ has a higher actual speed compared with Intel Pentium P166, and its internal clock need only be 133MHz versus 166MHz for Intel's product. The internal architecture is different between Cyrix 6x86 and Intel Pentium CPU even they are treated as the same type.

Having read the related terminology above, please refer to Appendices B, C or D for more information of your CPU. We suggest you make a note of the specification of your CPU, which will help you to configure your CPU correctly.

### **CPU Settings:**

|                      |
|----------------------|
| <b>CPU SOFT MENU</b> |
|----------------------|

To configure the speed and the voltage of the CPU, you must enter to the **CPU SOFT MENU** in BIOS Setup, which is discussed in Chapter 3 System BIOS.

## ④ MEMORY MODULE INSTALLATION

When this mainboard was designed, we not only have taken into account the economy and compatibility, but we also focused on the tremendous performance gain by using SDRAM DIMM.

There are four 168-pin DIMM sockets on board. You may install up to four single sided or maximum three double sided (bank) DIMMs on board. A total of 256MB system memory is supported.

The installation is easy. Simply push the two clips on the DIMM socket ends outward, orientates the DIMM with the notches against the socket keys, and gently push it down. Gradually increase the force you use, and make sure the clips are properly snapped on the module. However, before you proceed with installation, be patient, first read what follows:

### 1. 60ns FastPage Mode or EDO DRAM DIMMs.

If your memory modules are faster than 70ns, say 60ns or 45ns, you can modify the BIOS settings to speed up the operating speed of the system.

If you set the external CPU clock at 66MHz or more, we recommend you use 60ns or even faster DRAM modules.

Do not mix the type of the DIMMs you use, especially when you are using 3.3V SDRAM.

### 2. Memory error check and correction is not supported.

The Intel 430TX chipset used on this main board does not support this feature, since the memory error check and correction feature may not be effective, and since you cannot easily find memory modules with memory check and correction.

### 3. 168-pin DIMM modules specifications

According to the standards defined by JEDEC, there are a lot of different types of specifications for 168-pin DIMM sockets. Here are the possible types:

- 3.3V UNBUFFERED DIMM
- 3.3V BUFFERED DIMM
- 5V UNBUFFERED DIMM
- 5V BUFFERED DIMM

Currently, the standard for PC is 3.3V UNBUFFERED DIMM, which is supported by this motherboard by default.

Please read the following rules for how to install the DRAM module:

## Chapter 2

---

- The maximum memory size is 256M bytes.
- Support both single sided and double sided memory modules.
- Memory modules supported: 1Mx64 [8M], 2Mx64 [16M], 4Mx64 [32M], 8Mx64 [32M], or 16Mx64 [128M].
- There are four 168-pin DIMM sockets on the board. Their are DIMM 1 to 4. Please insert the DIMM in ascending order.
- The DIMM 1 and DIMM 2 sockets can support either single sided or double sided memory modules without any limitation. But the DIMM 3 and DIMM 4 can only support two memory banks totally. If the DIMM 3 was populated with a double sided (bank) module, you must be leave the DIMM 4 as vacant.



# Chapter 3 System BIOS

The BIOS is a program located on a Read-Only Memory chip on the mainboard. This program will not be lost when you turn the computer off. This program is also referred to as the boot program. It is the only channel for the hardware circuit to communicate with the operating system. Its main function is to manage the setup of the mainboard and interface cards parameters, including simple parameters such as time, date, hard disk drive, as well as more complex parameters such as hardware synchronization, device operating mode, CPU SOFT MENU™ techniques, setup of CPU voltage and speed. The computer will operate normally, or will operate at its best, only if all these parameters are correctly configured through the BIOS.

**Don't change the parameters inside the BIOS unless you know what you are doing**

The parameters inside the BIOS are used to setup the hardware synchronization or the device operating mode. If the parameters are not correct, they will produce errors, the computer will crash, and sometimes you will even not be able to boot the computer after it has crashed. We recommend that you do not change the parameters inside the BIOS unless you are familiar with them. If you are not able to boot your computer anymore, please refer to the section "Erase CMOS data" in Chapter 2.

When you start the computer, it is controlled by the BIOS program. The BIOS first operates an auto-diagnostic for all the necessary hardware, configures the parameters of the hardware synchronization, and detects all the hardware. Only when these tasks are completed does it give up control of the computer to the program of the next level, which is the operating system. Since the BIOS is the only channel for hardware and software to communicate, it will be the key factor to system stability, and to ensure that your system performs at its best. After the BIOS has achieved the auto-diagnostic and auto-detection operations, it will display the following message:

**TO ENTER SETUP BEFORE BOOT PRESS CTRL-ALT-ESC OR DEL KEY**

## Chapter 3

---

Three to five seconds after the message is displayed, if you press the **Del** key, or if you press simultaneously the **Ctrl Alt Esc** keys, you will access the BIOS Setup menu. At that moment, the BIOS will display the following message:



Fig 3 BIOS Setup main menu

In the BIOS Setup main menu of Figure 3, you can see several options. We will explain these options step by step in the following pages of this chapter, but let us first see a short description of the function keys you may use here:

- Press **Esc** to quit the BIOS Setup.
- Press (up, down, left, right) to choose, in the main menu, the option you want to confirm or to modify.
- Press **F10** when you have completed the setup of BIOS parameters to save these parameters and to exit the BIOS Setup menu.
- Press Page Up/Page Down or +/- keys when you want to modify the BIOS parameters for the active option.

### CMOS DATA

Maybe you have heard somebody saying that their CMOS DATA was lost. What is the CMOS? Is it important? The CMOS is the memory used to store the BIOS parameters that you have configured. This memory is passive. You can read its data, and you can also store data in it. But this memory has to be powered by a battery, in order to avoid any loss of its data when the computer is turned off. Since you may have to change the CMOS battery when it is out of power and in doing so, you will lose all CMOS data, therefore, we recommend that you write down all the parameters of your hardware, or to put a label with these parameters on your hard disk.

## ① CPU SOFT MENU™

The CPU can be setup through a programmable switch (CPU SOFT MENU™), that replaces traditional manual hardware configuration. This feature allows the user to complete the installation procedures more easily. However, the CPU must be setup according its specifications with the SOFT MENU™.

In the first option, you can press <F1> at any time to display all the items that can be chosen for that option.

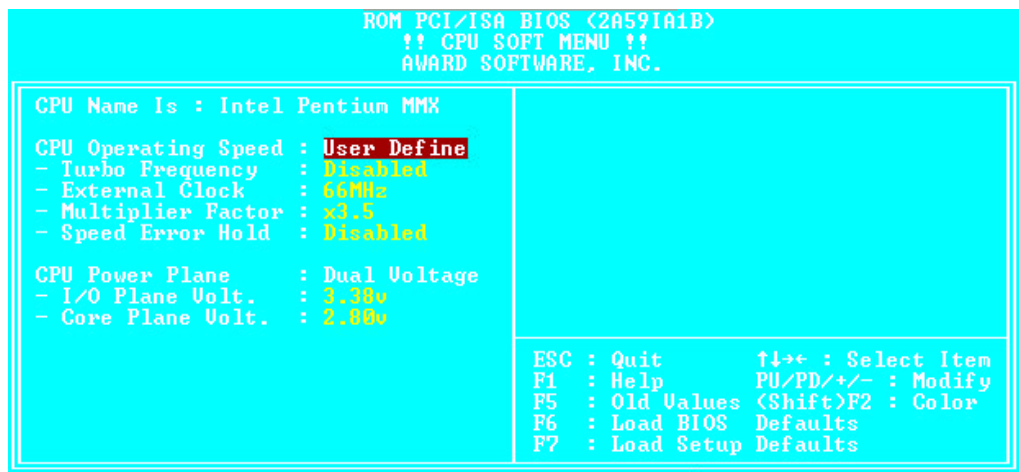

Fig 3-1 CPU SOFT MENU™

### *CPU Name Is:*

|               |                   |
|---------------|-------------------|
| Intel Pentium | Intel Pentium MMX |
| AMD K5        | AMD K6            |
| Cyrix 6x86    | Cyrix 6x86L       |
| Cyrix 6x86MX  |                   |

When you boot the computer, **the mainboard BIOS will automatically detect the CPU brand and type.**

## Chapter 3

---

### ***CPU Operating Speed:***

This option sets the CPU speed. Different CPU brands use different techniques to indicate the CPU speed. For example, AMD and Cyrix use P-Rating.

In this field, the CPU speed is indicated like this: CPU speed (external clock x multiplier factor)

Select the CPU speed according the type and the speed of your CPU.

Usually, you do not need to enter the clock and multiplier factor unless you try to use the “User Define” CPU speed.

Note 1 For Intel Pentium CPUs, you can choose the following settings:

|              |              |
|--------------|--------------|
| 100 (66x1.5) | 120 (60x2)   |
| 133 (66x2)   | 150 (60x2.5) |
| 166 (66x2.5) | 200 (66x3)   |

Note 2 For AMD-K5 CPUs from AMD, you can choose the following P-Ratings:

|                 |                |
|-----------------|----------------|
| PR120 (60x1.5)  | PR133 (66x1.5) |
| PR166 (66x1.75) |                |

Note 3 For Cyrix 6x86 and 6x86L CPUs, you can choose the following P-Ratings:

|               |               |
|---------------|---------------|
| PR120+ (50x2) | PR133+ (55x2) |
| PR150+ (60x2) | PR166+ (66x2) |

Note 4 User define external clock and multiplier factor:

User Define

⇒ ***External Clock:***

|       |       |
|-------|-------|
| 50MHz | 55MHz |
| 60MHz | 66MHz |
| 75MHz | 83MHz |

⇒ ***Multiplier Factor:***

You can choose the following multiplier factors:

|     |      |
|-----|------|
| 1.5 | 1.75 |
| 2.0 | 2.5  |
| 3.0 | 3.5  |

However, differences will exist because of the various brands and types available.

Normally, we do not recommend that you use the “User Define” option to setup CPU speed and multiplier factor. This option is for setup of future CPUs whose specifications are still unknown. The specifications of all present CPUs are included in the default settings. Unless you are very familiar with all CPU parameters, it is very easy to make mistakes when you define by yourself the external clock and the multiplier factor.

⇒ **Turbo Frequency:**

This item will only be displayed if your CPU external clock supports Turbo mode.

The Turbo mode allows you to speed up the external clock by approximately 2.5%. This feature is used to verify the design flexibility. It is a very important tool for test units to verify CPU stability. Do not use this feature.

Disable: CPU external clock is operating within the normal limits.

Enable: CPU external clock is operating within the limits of the Turbo mode.

**Solution in case of booting problem due to invalid clock setup:**

Normally, if the CPU external clock setup is wrong, you will not be able to boot. In this case, turn the system off than on again. The CPU will automatically use its standard parameters to boot. You can then enter BIOS Setup again and set up the external clock.

**When you change your CPU:**

The POWERPRO TX mainboard have been designed in such a way that you can turn the system on after having inserted the CPU in the socket without having to configure any jumpers or DIP switches. But if you change your CPU, normally, you just have to turn off the power supply, change the CPU and then, set up the CPU parameters through CPU **SOFT MENU™**. However, if the CPU brand and type is the same, and if the new CPU is slower than the old one, we offer you three methods to successfully complete the CPU change operation.

Method 1: Setup up the CPU for the lowest speed for its brand. Turn the power supply off and change the CPU. Then turn the system on again, and set up the CPU parameters through CPU SOFT MENU.

Method 2: Try turning the system on a few times (3~4 times) and the system will automatically use its standard parameters to boot. You can then enter BIOS SETUP again and set up the new parameters.

Method 3: Since you have to open the computer case when you change the CPU, it could be a good idea to use the CCMOS jumper to erase the parameters of the original CPU and to enter BIOS Setup to set up CPU parameters again.

## Chapter 3

---

**Note :** The increase by 2.5% of the CPU speed is not a standard feature of this product. It is only for use by our development department to verify that the CPU is able to work normally when CPU speed, operating temperature and power supply are 2.5% higher or lower than the standard values. This is to guarantee product stability. We require the manufacturer of the Clock Generator to meet the demands of our development department and to add a TURBO Frequency feature used for testing purposes by our R&D department. Of course, you can use this feature to test the stability of your own system, but after you have tested the product, we recommend that you set it back to its normal value in order to guarantee system stability.

### ***CPU Power Plane:***

In the previous chapter we explained that the 586 CPUs can be divided into two types: single voltage and dual voltage. This option will normally auto-detect the type of your CPU, so you don't need to make any changes.

Single Voltage: Single voltage CPU

Dual Voltage: Dual voltage CPU

Set up the voltage via CPU Marking

When the CPU is **single voltage**, the following options will be displayed to set up the voltage:

⇒ ***Plane voltage:***

3.52v For Intel VRE standard CPUs and AMK-K5 or Cyrix 8x86 CPUs

3.38v For Intel STD and VR standards CPUs

## System BIOS

---

When the CPU is **dual voltage**, two options will be displayed to set up Vcore and Vio plane voltage

⇒ **Core Plane Voltage:**

- 2.90v For AMD-K6/200 CPU.
- 2.80v For Intel Pentium MMX, Cyrix 6x86L and Cyrix 6x86MX CPU.
- 2.70v For future CPUs.
- 2.50v For future CPUs. (If hardware supports.)
- 3.20v For AMD-K6/233 and future CPUs. (If hardware supports.)

⇒ **I/O Plane Voltage:**

- 3.52v Reserved
- 3.38v Some CPUs from AMD need this I/O Plane Voltage.
- 3.30v For most of the dual voltage CPUs (default) currently available.

The CPU voltage must be set according to voltage indications via CPU Marking given by the manufacturer. Since the CPU voltage will decrease as technology improves, we have reserved some options according to what we can forecast from present documentation. We cannot give you detailed information about the voltage required by each kind of CPU in this chapter. For the correct values, refer to appendices B, C and D.

Set up the voltage via CPU Marking:

If you consider using the Appendices to set up as too complicated, you can use the CPU Marking: within the options under “CPU Marking Is,” set up via CPU Marking on the CPU.

Notes:

1. If your CPU is a dual voltage one and that the voltage set up is 3.52V, our mainboard features a hardware protection circuit that will lower the voltage between 2.8V and 2.9V, which is within the CPU operating voltage limits.
2. The voltage value given is the central value. For example, the voltage range of 3.52V is 3.45V to 3.6V. The central voltage value between 3.45V and 3.6V is 3.52V.

## Chapter 3

---

Attention: After setting up the parameters and you leave the BIOS SETUP, and you have verified that the system can be booted, do not press the Reset button or turn off the power supply. Otherwise the BIOS will not read correctly, the parameters will fail and you must enter CPU **SOFT MENU**<sup>™</sup> again to set up the parameters all over again.



## ② STANDARD CMOS SETUP MENU

It is the basic configuration parameters of the BIOS. These parameters include the settings of date, hour, VGA card, FDD and HDD.

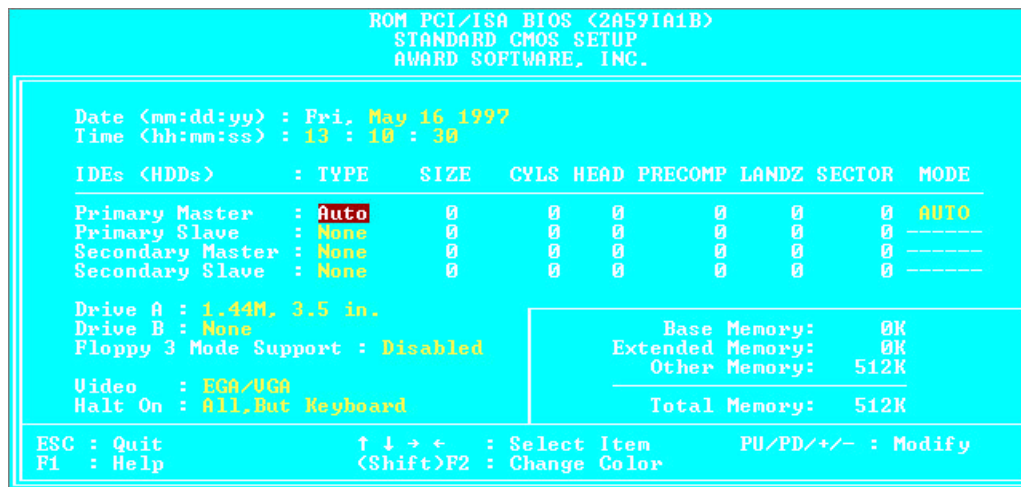

Fig 3-2 Standard CMOS Setup Menu

- *Set up of HDD operating mode* NORMAL, LBA, LARGE

Since old operating systems were only able to support HDD whose capacity was not bigger than 528MB, any hard disk with more than 528MB was unusable. AWARD BIOS features a solution to this problem: you can, according to your operating system, choose three operating modes: NORMAL, LBA or LARGE.

**Normal mode:**

Standard normal mode supports hard disks of 528MB or less. This mode directly uses positions indicated by Cylinders (CYLS), Heads, and Sectors to access data.

## Chapter 3

---

### **LBA (Logical Block Addressing) mode:**

LBA mode supports hard disk drives up to 8.4Giga. This mode uses a different method to calculate the position of disk data to be accessed. It translates Cylinders (CYLS), Heads and Sectors into a logical address where data are located. The Cylinders, Heads, and Sectors displayed in this menu do not reflect the actual structure of the hard disk, they are just reference values used to calculate actual positions. Currently, all high capacity hard disks support this mode, that's why we recommend you use this mode. The HDD AUTODETECTION option in the Main Menu will automatically detect the parameters of your hard disk and the mode supported.

### **LARGE Mode:**

When the number of cylinders (CYLs) of the hard disk exceeds 1024 and DOS is not able to support it, or if your operating system does not support LBA mode, you should select this mode.

- **FDD supporting 3 Mode:**  
3 Mode floppy disk drives (FDD) are 3 1/2" drives used in Japanese computer systems. If you need to access data stored in this kind of floppy, you must select this mode, and of course you must have a 3 Mode floppy drive.

For further information about HDD installation, refer to Appendix E.

## ③ BIOS FEATURES SETUP MENU

BIOS Features Setup Menu has already been set for maximum operation. If you do not really understand each of the options in this menu, we recommend you use default values.

In each item, you can press <F1> at any time to display all the options for this item.

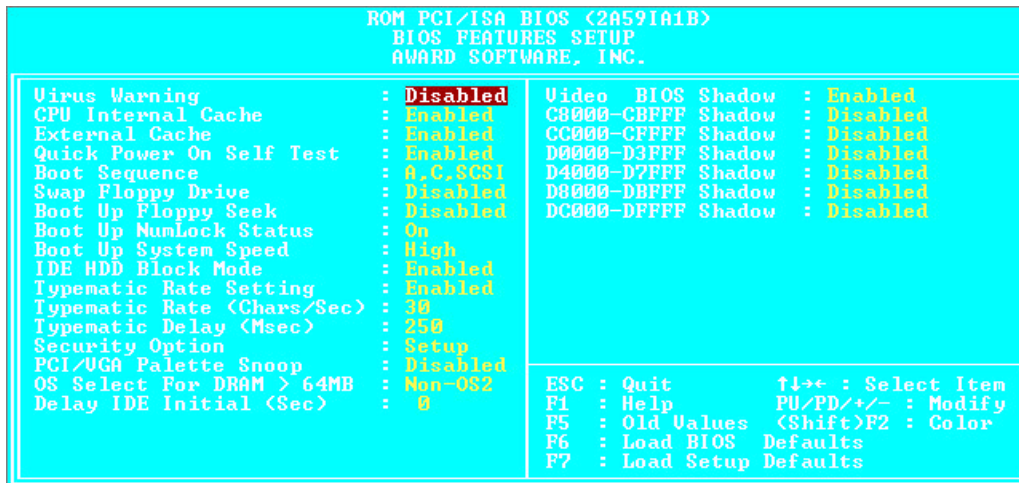

Fig 3-3 BIOS Features Setup

### ***Virus Warning:***

This item can be set as Enable or Disable.

When this feature is enabled, if there is any attempt from a software or an application to access the boot sector or the partition table, the BIOS will warn you that a boot virus is attempting to access to the hard disk.

## Chapter 3

---

### ***CPU Internal Cache:***

This item is used to Enable or to Disable the CPU internal cache. When the cache is set at Disable, it is much slower, so the default setting for this item is Enable. Some old and very bad programs will make the computer malfunction or crash if the system speed is too high. In that case, you should Disable this feature.

### ***CPU External Cache:***

This item is used to enable or to disable the CPU external cache. When the external cache is enabled, the system works faster. The default is Enable.

### ***Quick power on self test:***

After the computer has been powered on, the BIOS of the mainboard will run a series of tests in order to check the system and its peripherals. If the Quick power on self test feature is Enable, the BIOS will simplify the test procedures in order to speed up the boot process. The default is Enable.

### ***Boot Sequence:***

When the computer boots up, it can load the operating system from floppy drive A:, hard disk drive C:, SCSI disk drive or CD-ROM. There are many options for the boot sequence:

- A, C, SCSI
- C, A, SCSI
- C, CD-ROM, A
- CD-ROM, C, A
- D, A, SCSI (at least 2 IDE HDD can be used)
- E, A, SCSI (at least 3 IDE HDD can be used)
- F, A, SCSI (at least 4 IDE HDD can be used)
- SCSI, A, C
- SCSI, C, A
- A, SCSI, C

### ***Swap Floppy Drive:***

This item can be set as Enable or Disable.

When this feature is enabled, you don't need to open the computer case to swap the position of floppy disk drive connectors. Drive A: can be set as drive B:, and drive B: can be set as drive A:.

### ***Boot Up Floppy Seek:***

When computer boots up, the BIOS detects if the system has FDD or not. When this item is enabled, if the BIOS detects no floppy drive, it will display a floppy disk drive error message. If this item is disabled, the BIOS will skip this test.

### ***Boot Up NumLock Status:***

On: At boot up, the Numeric Keypad is in numeric mode.

Off: At boot up, the Numeric Keypad is in cursor control mode.

### ***IDE HDD Block Mode:***

This item can be set as Enable or Disable.

Most of new hard disk drives (IDE drives) support multi-sector transfers. This feature speeds up hard disk drive access performance and reduces the time necessary to access data. When this item is enabled, the BIOS will automatically detect if your hard disk drive supports this feature or not, and will choose the right settings for you.

For further details about hard disk drive installation, refer to appendix E.

### ***Typematic Rate Setting:***

This item allows you to adjust the keystroke repeat rate. When enabled, you can set the two keyboard typematic control that follow (Typematic Rate and Typematic Rate Delay). If this item is disabled, the BIOS will use the default setting.

### ***Typematic Rate (Chars/Sec):***

When you press a key continuously, the keyboard will repeat the keystroke according to the rate you have set. (Unit: characters/second)

### ***Typematic Rate Delay (Msec):***

When you press a key continuously, if you exceed the delay you have set here, the keyboard will automatically repeat the keystroke according a certain rate. (Unit: milliseconds)

## Chapter 3

---

### ***Security Option:***

This option can be set to System or to Setup.

After you have created a password through PASSWORD SETTING, this option will deny access to your system (System) or modification of computer setup (BIOS Setup) by unauthorized users.

**SYSTEM:** When you choose System, a password is required each time the computer boots up. If the correct password is not given, the system will not start.

**SETUP:** When you choose Setup, a password is required only when accessing the BIOS Setup. If you have not set a password in the PASSWORD SETTING option, this option is not available.

**Notice:** Don't forget your password. If you forget the password, you will have to open the computer case and clear all information in the CMOS before you can start up the system. But doing this, you have to reset all the options you had set up before.

### ***PCI/VGA Palette Snoop:***

This option allows the BIOS to preview VGA Status, and to modify the information delivered from the Feature Connector of the VGA card to the MPEG Card. This option can solve the display inversion to black after you have used the MPEG card.

### ***OS Select For DRAM > 64MB:***

When the system memory is bigger than 64MB, the communication method between the BIOS and the operating system will differ from one operating system to another. If you use OS/2, select OS2; if you choose another operating system, select Non-OS2.

### ***Video BIOS Shadow:***

This option is used to define whether the BIOS on the video card uses shadow feature or not. You should set this option to Enable, otherwise the display performance of the system will greatly decrease.

***Shadowing address ranges (C8000-CBFFF Shadow):***

This option allows you to decide if the memory block (BIOS) of an interface card at the address C8000-CBFFF uses the shadow feature or not. If you have no interface card using this memory block, don't enable this option.

***Shadowing address ranges (CC000-CFFFF Shadow):***

This option allows you to decide if the memory block (BIOS) of an interface card at the address CC000-CFFFF uses the shadow feature or not. If you have no interface card using this memory block, don't enable this option.

***Shadowing address ranges (D0000-D3FFF Shadow):***

This option allows you to decide if the memory block (BIOS) of an interface card at the address D0000-D3FFF uses the shadow feature or not. If you have no interface card using this memory block, don't enable this option.

***Shadowing address ranges (D4000-D7FFF Shadow):***

This option allows you to decide if the memory block (BIOS) of an interface card at the address D4000-D7FFF uses the shadow feature or not. If you have no interface card using this memory block, don't enable this option.

***Shadowing address ranges (D8000-DBFFF Shadow):***

This option allows you to decide if the memory block (BIOS) of an interface card at the address D8000-DBFFF uses the shadow feature or not. If you have no interface card using this memory block, don't enable this option.

***Shadowing address ranges (DC000-DFFFF Shadow):***

This option allows you to decide if the memory block (BIOS) of an interface card at the address DC000-DFFFF uses the shadow feature or not. If you have no interface card using this memory block, don't enable this option.

**SHADOW**

What is the SHADOW? The BIOS of standard video or interface cards is stored in ROM, and it is often very slow. With the Shadow feature, the CPU reads the BIOS on the VGA card and copies it into RAM. When the CPU runs this BIOS, the operation is speeded up.

## Chapter 3

### ④ CHIPSET FEATURES SETUP MENU

The Chipset Features Setup Menu is used to modify the contents of the buffers in the chipset on the mainboard. Since the parameters of the buffers are closely related to hardware, if the setup is not correct or false, the mainboard will become unstable or you will not be able to boot up. If you don't know the hardware very well, use default values (use the LOAD SETUP DEFAULTS option).

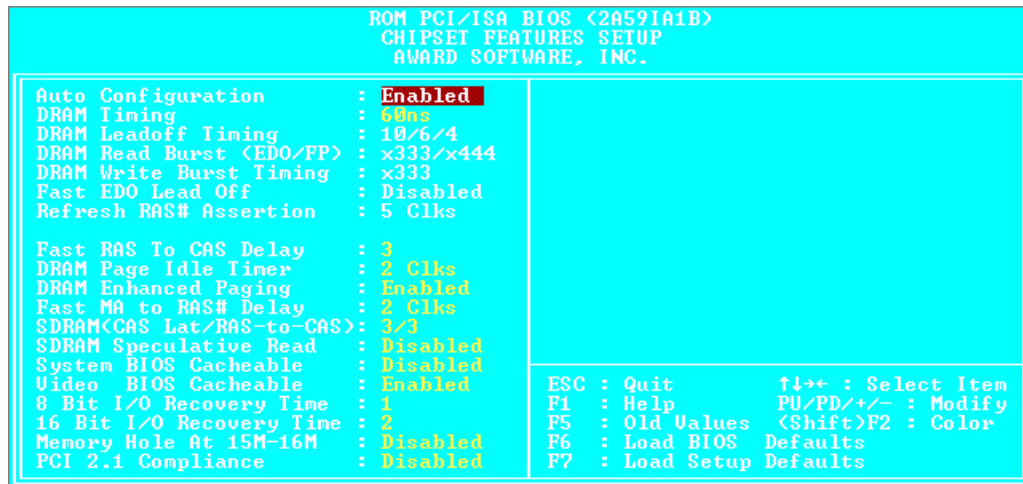

Fig 3-4 Chipset Features Setup

You can use the arrow keys to move between the items. Use "PgUP", "PgDn", "+" and "-" to change the values. When you have finished setting up the chipset, press "ESC" to go back to the main menu.

#### ***Auto Configuration:***

This option allows (Enable) or prevents (Disable) the BIOS from using default values for Auto Configuration. The BIOS default is Enable.

When you select Enable, the BIOS will automatically use the values related to DRAM. You will not be able to set up the following options.

When you select Disable, you can manually set up DRAM options.



## System BIOS

---

**Attention:** Unless you are very familiar with your computer and with the DRAM configuration and speed, we recommend you not change the DRAM options but enable this option.

### ***DRAM settings:***

The other DRAM settings are all closely related to hardware. If you do not understand this very well, don't make any changes. Our BIOS is able to autodetect the characteristics of your DRAM and to choose the best settings.

### ***Memory Hole At 15M-16M:***

This option is used to free up the 15M-16M memory block. Some special peripherals need to use a memory bloc located between 15M and 16M, and this memory block has a size of 1M. We recommend that you disable this option.

There are small differences in the chipset feature setup according to different mainboard models, but this has no influence upon performance. Our default setup should be the best one. That is the reason why we do not describe all the features of this menu.

## Chapter 3

### ⑤ POWER MANAGEMENT SETUP MENU

The difference between Green PCs and traditional computers is that Green PCs have a power management feature. With this feature, when the computer is powered on but inactive, the power consumption is reduced in order to save energy. When the computer operates normally, it is in Normal mode. In this mode, the Power Management Program will control the access to video, parallel ports, serial ports and drives, and the operating status of the keyboard, mouse and other device. These are referred to as Power Management Events. In cases where none of these events occur, the system enters the power saving mode. When one of the controlled events occurs, the system immediately returns to normal mode and operates at its maximum speed. Power saving modes can be divided into three modes according to their power consumption: Doze Mode, Standby Mode, and Suspend Mode. The four modes proceed in the following sequence:

Normal Mode====> Doze Mode====> Standby Mode====> Suspend Mode

The system consumption is reduced according the following sequence:

Normal > Doze > Standby > Suspend

1. In the Main Menu, select "Power Management Setup" and press "Enter". The following screen is displayed:

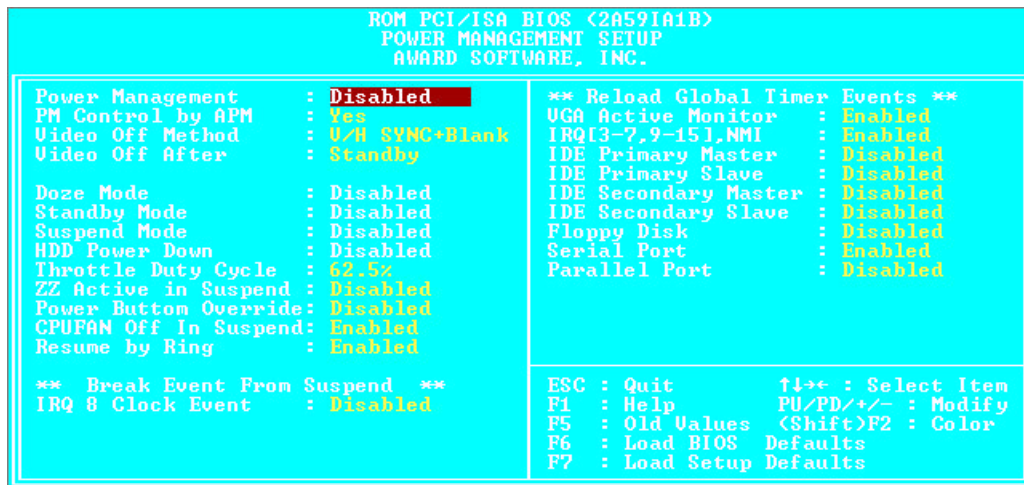

Fig 3-5 Power Management Setup Menu

## System BIOS

---

2. Use arrow keys to go to the item you want to configure. To change the settings, use "PgUP", "PgDn", "+" and "-".
3. After you have configured the Power Management feature, press "Esc" to go back to the Main Menu.

We are now going to briefly explain the options in this menu:

### ***Power Management:***

Four options:

User Define

User Define defines the delay for accessing the power modes.

Disable

Disable Power Management features.

Min Saving

When the three saving modes are enabled, the system is set up for minimum power savings.

Doze = 1 hour

Standby = 1 hour

Suspend = 1 hour

Max Saving

When the three saving modes are enabled, the system is set up for maximum power savings.

Doze = 1 minute

Standby = 1 minute

Suspend = 1 minute

### ***PM Control by APM:***

Power Management is completely controlled by the APM.

APM stands for Advanced Power Management, it is a power management standard set by Microsoft, Intel and other major manufacturers.

### ***Video Off Method:***

Three video off methods are available: "Blank", "V/H SYNC+Blank" and "DPMS". The default is "V/H SYNC+Blank".

If this setting does not shut off the screen, select "Blank". If your monitor and video card support DMPS standard, select "DPMS".

## Chapter 3

---

### ***Video Off After:***

Select the saving mode in which the video is switched off.

Always On

The video will never be switched off in no saving mode.

All Modes Off

The video will be switched off in all saving modes.

Standby

The video will only be switched off in Standby or Suspend mode.

Suspend

The video will only be switched off in Suspend mode.

### ***IDE HDD Power Down:***

If the system has not accessed data on the hard disk drive during the specified time period, the engine of the HDD will stop in order to save electricity.

You can set 1 to 15 minutes or select Disable according to your use of the HDD.

### ***Doze Mode:***

When the setting selected for "Power Management" is "User Define", you can define for this mode any delay from 1 minute to 1 hour. If no power management event occurs during this time period, meaning that computer is inactive during this period, the system will enter the **Doze** power saving mode.

If this mode is disabled, the system will enter the next mode in the sequence (Standby or Suspend mode).

### ***Standby Mode:***

When the setting selected for "Power Management" is "User Define", you can define for this mode any delay from 1 minute to 1 hour. If no power management event occurs during this time period, meaning the computer is inactive during this period, the system will enter the **Standby** power saving mode.

If this mode is disabled, the system will enter the next mode in the sequence (Suspend mode).

## ***Suspend Mode:***

When the setting selected for "Power Management" is "User Define", you can define for this mode any delay from 1 minute to 1 hour. If no power management event occurs during this time period, meaning the computer is inactive during this period, the system will enter the **Suspend** power saving mode. The CPU stops working completely.

If this mode is disabled, the system will not enter the Suspend mode.

## ***Throttle Duty Cycle:***

This is used to specify the CPU speed in saving mode. Seven options are available: 12.5%, 25.0%, 37.5%, 50.0%, 62.5%, 75.0% or 87.5%.

## ***CPU Fan Off In Suspend:***

CPU fan can be turn off in suspend mode.

## ***Power Button Override:***

Support ACPI Power Button Over-ride. The user presses the power button for more then four seconds while the system is in the working state, then the system will transition to the soft-off(Power off by software). This is called the power button over-ride.

## ***Break Event From Suspend:***

Supper ACPI RTC Alarm Function (via IRQ8).

## ***Reload Global Timer Events***

When one of the spificied occurs, the count down made for entry in power saving mode goes back to zero.

Since the computer will enter a power saving mode only after an inactivity delay specified (time spificied for Doze, Standby and Suspend modes) and after it has no activity, during this time period, any event will cause the computer to re-count the time elapsed. Resume events are operations or signals that cause the computer to resume time counting.

## Chapter 3

### ⑥ PCI & ONBOARD I/O SETUP

In this menu, you can change the INT# and IRQ of the PCI bus and the onboard I/O device, I/O port address and other hardware settings.

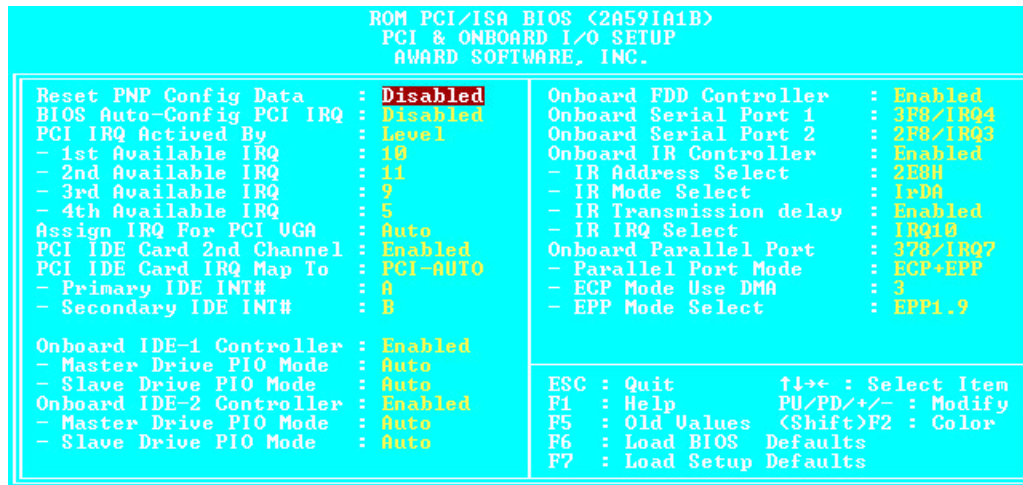

Fig 3-6 PCI & Onboard I/O Setup

#### ***Reset PnP Config Data:***

If you want to clear ESCD data next time you boot up, and ask the BIOS to reset the settings for the Plug & Play ISA Card and the PCI Card, select Enabled. But the next time you boot up, this option will automatically be set as Disabled.

#### **ESCD (Extended System Configuration Data)**

The ESCD contains the IRQ, DMA, I/O Port, Memory information of the system. This is a specification and a feature specific to Plug & Play BIOS.

#### ***BIOS Auto-Config PCI IRQ:***

This option enables or disables the BIOS capability to automatically assign IRQs. The BIOS default is Disable.

When you select Enable, the BIOS will automatically assign the correct IRQ to the interrupt number (INT#) of the PCI slots. When this option is disabled, you have to assign IRQs used by the interrupt number (INT#) of the PCI slots.

### ***Xth Available IRQ:***

You can select four IRQs out of the 10 listed (IRQ3, 4, 5, 7, 9, 10, 11, 12, 14, 15) to be assigned for use by the interrupt number (INT#) of the PCI slot.

### ***1st Available IRQ:***

This means that the first interrupt number (INT#) found on the PCI bus will use this IRQ. That is, this IRQ will be assigned to the first interrupt number (INT#) found on the PCI bus.

### ***2nd Available IRQ:***

This means that the second interrupt number (INT#) found on the PCI bus will use this IRQ. That is, this IRQ will be assigned to the second interrupt number (INT#) found on the PCI bus.

***The third and the fourth available IRQ will be assigned in sequence to the third and the fourth interrupt numbers (INT#) found on the PCI bus.***

### ***PCI IDE Card 2nd Channel:***

This option can be enabled or disabled. BIOS default is Enable.

Since this channel uses IRQ15, if you want to use this channel, you have to enable this option to make the BIOS assign IRQ15 to this channel.

### ***PCI IDE Card IRQ Map to:***

Three options are available for this item: PCI Auto, PCI-slotX and ISA.

PCI-Auto: The onboard BIOS auto-detects which PCI slot has an IDE card inserted in.

PCI-slotX: Some old PCI IDE cards cannot be detected by the BIOS. If the onboard BIOS cannot detect a PCE IDE card, you have to specify on which PCI slot the IDE card is inserted, to make the BIOS assign IRQ14 for use by the interrupt number (INT#) of this PCI slot.

ISA: If you select ISA, it means that your PCI IDE card features a “paddleboard” and a cable that can be connected to IRQ on the ISA slot, because the BIOS will not assign any IRQ to this PCI slot.

**Attention:** Primary Channel and Secondary Channel : The BIOS needs two independent interrupt number (INT#) lines to be allocated to the PCI IDE card. Be careful not to choose twice the same interrupt number (INT#).

## Chapter 3

---

### ***On Board FDD Controller:***

This is to Enable or Disable the Onboard FDD Controller.

### ***On board Serial Port 1:***

This is used to specify the I/O address and IRQ of Serial Port 1. Five options are available: Disable, 3F8h/IRQ4, 2F8h/IRQ3, 3E8h/IRQ4 or 2E8h/IRQ3.

### ***On board Serial Port 2:***

This is used to specify the I/O address and IRQ of Serial Port 2. Five options are available: Disable, 3F8h/IRQ4, 2F8h/IRQ3, 3E8h/IRQ4 or 2E8h/IRQ3.

### ***On board IR Controller:***

This is to Enable or Disable the Onboard IR Controller.

#### ***IR Address Select:***

This is used to specify the I/O address. Four options are available: 2F8H, 2E8H, 3F8H or 3E8H.

#### ***⇒ IR IRQ Select:***

This is used to specify the IRQ of IR. Four options are available: IRQ3,IRQ4,IRQ10 or IRQ11.

#### ***⇒ IR Transmission Delay:***

Set IR transmission delays 4 character-time(40 bit-time) when SIR is changed form RX mode to TX mode.

#### ***⇒ IR Mode Select:***

Four options are available:

IrDA (HPSIR)mode.

ASK IR (Amplitude Shift Keyed IR)mode.

FIR (Fast IR) mode

CIR

#### ***⇒ FIR Mode Use DMA:***

This is used to specify the DMA channel of FIR. Four options are available: DMA0, DMA1, DMA3 or Disable.



## ***On board parallel Port:***

Set the I/O address and IRQ of the onboard parallel port. Four options are available: Disable, 3BCh/IRQ7, 278h/IRQ5 and 378h/IRQ7. Default is 378h/IRQ7.

### **⇒ *Parallel Port Mode:***

Can be set as EPP v.1.7, EPP v. 1.9, ECP, ECP+EPP 1.7, ECP+EPP 1.9 or Normal (SPP) mode. Default is Normal (SPP) mode.

### **⇒ *ECP Mode Use DMA:***

When the mode selected for the onboard parallel port is ECP, the DMA channel selected can be Channel 1 or Channel 3.

## ***On board IDE-1 Controller:***

Onboard PCI IDE 1 controller can be set as Enable or Disable.

### **⇒ *Master drive PIO Mode:***

Auto: the BIOS can auto-detect the PIO mode of the HDD in order to set its data transfer rate. (Default)

Mode 0~Mode 4: User can specify the PIO mode of the HDD in order to set its data transfer rate.

### **⇒ *Slave drive PIO Mode:***

Auto: the BIOS can auto-detect the PIO mode of the HDD in order to set its data transfer rate. (Default)

Mode 0~Mode 4: User can specify the PIO mode of the HDD in order to set its data transfer rate.

## ***On board IDE-2 Controller:***

The onboard IDE-2 controller can be set at Enable or Disable.

### **⇒ *Master drive PIO Mode:***

Auto: the BIOS can auto-detect the PIO mode of the HDD installed in order to set its data transfer rate. (Default)

Mode 0~Mode 4: User can specify the PIO mode of the HDD in order to set its data transfer rate.

### **⇒ *Slave drive PIO Mode:***

Auto: the BIOS can auto-detect the PIO mode of the HDD installed in order to set its data transfer rate. (Default)

Mode 0~Mode 4: User can specify the PIO mode of the HDD in order to set its data transfer rate.

## Chapter 3

---

**Note:**

MODE 0~4 reflects the HDD data transfer rate. The higher the MODE value is, the better is the HDD data transfer rate. But it does not mean that you can select the highest MODE value just as you like, you first have to be sure that your HDD supports this MODE, otherwise the hard disk will not be able to operate normally.

For further information about HDD installation, refer to Appendix E.

### ⑦ **LOAD BIOS DEFAULTS**

BIOS defaults are the reference settings that allow your system to work at a comparatively low performance. When you choose the option, the following message is displayed:

“Load BIOS Defaults (Y/N)? N”

If you want to use BIOS default values, press “Y”, than <Enter>.

### ⑧ **LOAD SETUP DEFAULTS**

Setup defaults are the settings that allow your system to operate at its highest performance. When you choose this option, the following message is displayed:

“Load Setup Defaults (Y/N)? N”

If you want to use BIOS Setup default values, press “Y”, than <Enter> to complete the loading of the settings for best performance.

You should first load the best settings, than enter the CPU Soft Menu to set up CPU parameters, otherwise the BIOS will replace set parameters by default parameters.

## Chapter 3

---

### ⑨ PASSWORD SETTING

This option allows you to set a password required to start the system (System) or to access to the BIOS (Setup).

After you have set a password through the PASSWORD SETTING option, you can enter the Security Option in the “BIOS Features Setup Menu” to select the security level in order to prevent any unauthorized access.

#### **Password setting procedure:**

When you choose the Password setting option, the following message is displayed:

**“Enter Password:“**

Type your password. When complete, press <Enter>. The following message is displayed:

**“Confirm Password:“**

Type your password again. When complete, press <Enter>. The password setting is completed.

#### **Password clearing procedure:**

When you select the Password setting option, the following message is displayed:

**“Enter Password:“**

Press <Enter>, the message “Password Disable” is displayed. Press a key. The password clearing procedure is completed.

**Notice:** Do not forget your password. If you forget it, you will have to open the computer case, clear the contents of the CMOS, and boot the system up again. But doing this, you must reset all your settings.

### ⑩ IDE HDD AUTO DETECTION

After you have installed the hard disk, in old systems, you had to know the hard disk specifications, such as the number of cylinders, heads and sectors, and to enter the relevant information into the hard disk information section. If the CMOS data were erased, and you had forgotten the hard disk specifications, it was a great problem. But now, you can use this option to autodetect the hard disk type and specifications, and the BIOS will automatically detect all the relevant information and place them in the Hard Disk data section of the Standard CMOS Setup Menu, in order to allow you to use your hard disk.



## Appendix A Quick Installation

Appendix A will *give you a simplified installation procedure*, in order to allow you to install your mainboard quickly and correctly.

If you need further information or if you need to change some other settings, read from Chapters 1.

### ***Installing the CPU:***

Lift up the lever of the CPU socket, insert your CPU on the socket, and lower the lever back in position. Don't worry, if you don't respect the correct orientation, you will not be able to insert the CPU.

### ***Adjusting CPU voltage and speed:***

According to your CPU voltage and speed, set up the CPU in the CPU SOFT MENU™ of the BIOS SETUP. For information about your CPU, refer to appendices B, C or D, and to information labeled on the CPU itself.

### ***Installing DRAM:***

Inserting your DRAM modules into the DIMM 1 ~ DIMM 4.

### ***Installing FDD:***

**FDC-** Connect one end of the 34-pin cable that comes with the drive to the FDD connector, and the other end of the cable to the FDC pin connector on the mainboard.

**Note:** Be sure that the red line on the cable connects to the first pin of the connectors.

### ***Installing HDD:***

**IDE1-** Connect one end of the 40-pin cable that comes with the drive to the HDD connector, and the other end to IDE1 pin connector on the mainboard.

**Note:** Be sure that the red line on the cable connects to the first pin of the connectors.

### ***Installing CD-ROM Drive:***

**IDE2-** Connect one end of the 40-pin cable that

## Appendix A

---

comes with the drive to the CD-ROM connector, and the other end to the IDE2 pin connector on the mainboard.

**Note:** Be sure that the red line on the cable connects to the first pin of the connectors.

### ***Installing parallel port:***

**LPT-** Connect the 26-pin cable that comes with the hardware to the LPT connector on the mainboard.

### ***Installing serial port:***

**COM1-** Connect the 10-pin cable that comes with the hardware to connector COM1 on the mainboard.

**COM2-** Connect the other 10-pin cable to connector COM2 on the mainboard.

*Attach the bracket of Parallel Port, Serial Port and PS2 Mouse on the computer case.*

### ***Installing Keylock connector:***

*Watch the pin position and the orientation*

**PN2 -** There is a specific orientation for pin 1 to pin 5. Insert the five-threads keylock cable into correct pins of connector on the mainboard.

| Pin number | Name or significance of signal     |
|------------|------------------------------------|
| 1          | +5VDC [ also for power LED]        |
| 2          | No connection[ also for power LED] |
| 3          | Ground[ also for power LED]        |
| 4          | Keyboard inhibit Signal            |
| 5          | Ground                             |



## Quick Installation

### ***Installing HDD LED connector:***

*Watch the pin position and the orientation*

**PN2** - There is a specific orientation for pin 7 and pin 8. Connect the two-threads IDE LED connector to the connector on mainboard.

| Pin number | Name of the signal or signification |
|------------|-------------------------------------|
| 7          | HDD LED signal LED Anode            |
| 8          | HDD LED signal LED Cathode          |

### ***Installing Suspend and Power ON/OFF switch connector:***

*Watch the pin position and the orientation*

**PN2** - There is a specific orientation for pin 10 and pin 11. Connect the two-threads suspend switch connector of the computer case to correct pins of connector on the mainboard. You can ignore this connector since most of computer cases do not support this feature (the mainboard itself supports it).

| Pin number | Name of the signal or signification |
|------------|-------------------------------------|
| 11         | Power-on Signal                     |
| 10         | Ground                              |

### ***SP-LED connector:***

**PN1** - This connector has a specific orientation. Connect the two-threads Sleep LED connector on the mainboard.

| Pin number | Name of the signal or signification |
|------------|-------------------------------------|
| 10         | LED's Cathode                       |
| 9          | LED's Anode                         |

## Appendix A

---

### ***Installing speaker connector:***

**PN1** - There is no specific orientation for pin 4 to pin 7. Connect the four-threads speaker cable to the PN1 connector pins on the mainboard.

| Pin number | Name of the signal or signification |
|------------|-------------------------------------|
| 4          | +5VDC                               |
| 5          | Ground                              |
| 6          | Ground                              |
| 7          | Sound Signal                        |

### ***Installing ATX Power input connector:***

*Watch the pin position and the orientation*

**ATXPWR1** - Connect the power supply unit to the correct connectors on the mainboard.

| Pin number | Name of the signal or signification | Pin number | Name of the signal or signification |
|------------|-------------------------------------|------------|-------------------------------------|
| 1          | +3.3VDC                             | 11         | +3.3VDC                             |
| 2          | +3.3VDC                             | 12         | -12VDC                              |
| 3          | Ground                              | 13         | Ground                              |
| 4          | +5VDC                               | 14         | PS_ON                               |
| 5          | Ground                              | 15         | Ground                              |
| 6          | +5VDC                               | 16         | Ground                              |
| 7          | Ground                              | 17         | Ground                              |

### ***Installing Keyboard connector:***

|    |           |    |       |
|----|-----------|----|-------|
| 8  | POWERGOOD | 18 | -5VDC |
| 9  | +5VDC     | 19 | +5VDC |
| 10 | +12VDC    | 20 | +5VDC |

**Keyboard** - There is an orientation pin. Connect your keyboard connector to connector on the mainboard. If your cable doesn't include both keylock and power LED,

## Quick Installation

---

### ***Installing PS2 Mouse:***

**Mouse** - Connect the six-threads PS/2 Mouse cable that comes with the hardware to the connector on the mainboard. Install the bracket located on the other end of the computer case. When you buy a Mouse, it has to be a PS/2 Mouse for it to be connected to this port.

*Attach the bracket of Parallel Port, Serial Port and PS2 Mouse on the computer case.*

### ***Installing CPU Fan Power connector:***

**FAN1/FAN2/FAN3** - There is a specific orientation. Connect the three-threads CPU fan cable to the FAN1 connector. The FAN2 and FAN3 are reserved for future use.

| Pin number | Name of the signal or signification |
|------------|-------------------------------------|
| 1          | N.C                                 |
| 2          | +12V                                |
| 3          | Control signal                      |

### ***Adjusting other jumpers:***

Some jumpers are reserved for future functions or are not to be adjusted in normal operation. Adjust them according to the following recommendations.

**CCMOS** Put jumper on pin 1 and pin 2.

### ***BIOS Setup:***

Parameters and CPU settings After you have followed the steps described above and completed the installation, when you power the computer on, you will see the following message displayed:

**TO ENTER SETUP BEFORE BOOT PRESS CTRL-ALT-ESC OR DEL KEY**  
Press immediately Del key to enter BIOS Setup. Select Load Setup Defaults, than enter CPU Soft Menu to set CPU parameters.



## Appendix B Intel Pentium CPUs

### Pentium 75MHz

| CPU Spec. | Internal Clock | Bus Factor | External Clock | Power |      | CPU Timing | DP Supp. | Note |
|-----------|----------------|------------|----------------|-------|------|------------|----------|------|
|           |                |            |                | Vcore | VIO  |            |          |      |
| Q0649     | 75MHz          | 1.5        | 50MHz          | STD   |      | STD        | Yes      |      |
| Sx753     | 75MHz          | 1.5        | 50MHz          | STD   |      | STD        | Yes      |      |
| SX961     | 75MHz          | 1.5        | 50MHz          | STD   |      | STD        | Yes      |      |
| SX969     | 75MHz          | 1.5        | 50MHz          | STD   |      | STD        | Yes      |      |
| Q0700/S   | 75MHz          | 1.5        | 50MHz          | STD   |      | STD        | Yes      |      |
| Q0749/S   | 75MHz          | 1.5        | 50MHz          | STD   |      | MD         | Yes      |      |
| Q0837     | 75MHz          | 1.5        | 50MHz          | STD   |      | STD        | Yes      |      |
| SY005     | 75MHz          | 1.5        | 50MHz          | STD   |      | STD        | Yes      |      |
| Q0540     | 75MHz          | 1.5        | 50MHz          | STD   |      | STD        | Yes      |      |
| Q0541     | 75MHz          | 1.5        | 50MHz          | STD   |      | STD        | Yes      |      |
| Q0666     | 75MHz          | 1.5        | 50MHz          | STD   |      | STD        | Yes      |      |
| SX961     | 75MHz          | 1.5        | 50MHz          | STD   |      | STD        | Yes      |      |
| SZ977     | 75MHz          | 1.5        | 50MHz          | STD   |      | STD        | Yes      |      |
| Q0700     | 75MHz          | 1.5        | 50MHz          | STD   |      | STD        | Yes      |      |
| Q0749     | 75MHz          | 1.5        | 50MHz          | STD   |      | MD         | Yes      |      |
| SX998     | 75MHz          | 1.5        | 50MHz          | STD   |      | MD         | Yes      |      |
| SZ994     | 75MHz          | 1.5        | 50MHz          | STD   |      | MD         | Yes      |      |
| SU070     | 75MHz          | 1.5        | 50MHz          | STD   |      | MD         | Yes      |      |
| Q0689     | 75MHz          | 1.5        | 50MHz          | 2.9V  | 3.3V |            | Yes      |      |
| SK091     | 75MHz          | 1.5        | 50MHz          | 2.9V  | 3.3V |            | Yes      |      |
| Q0851     | 75MHz          | 1.5        | 50MHz          | 2.9V  | 3.3V |            | Yes      |      |
| SK122     | 75MHz          | 1.5        | 50MHz          | 2.9V  | 3.3V |            | Yes      |      |
| SU097     | 75MHz          | 1.5        | 50MHz          | STD   |      | STD        | Yes      |      |
| SU098     | 75MHz          | 1.5        | 50MHz          | STD   |      | STD        | Yes      |      |

# Appendix B

## Pentium 90MHz

|      | CPU Speed | CPU Spec | Internal Clock | Bus Factor | External Clock | Power |      | CPU Timing | DP Supp. | Note |
|------|-----------|----------|----------------|------------|----------------|-------|------|------------|----------|------|
|      |           |          |                |            |                | Vcore | VIO  |            |          |      |
| P54C | 90 MHz    | Sx653    | 90MHz          | 1.5        | 60MHz          | STD   |      | STD        | Yes      |      |
| P54C |           | Sx957    | 90MHz          | 1.5        | 60MHz          | STD   |      | STD        | Yes      |      |
| P54C |           | Q0654    | 90MHz          | 1.5        | 60MHz          | VR    |      | STD        | Yes      |      |
| P54C |           | Sx958    | 90MHz          | 1.5        | 60MHz          | VR    |      | STD        | Yes      |      |
| P54C |           | Q0655    | 90MHz          | 1.5        | 60MHz          | STD   |      | MD         | Yes      |      |
| P54C |           | Sx959    | 90MHz          | 1.5        | 60MHz          | STD   |      | MD         | Yes      |      |
| P54C |           | Q0699/S  | 90MHz          | 1.5        | 60MHz          | STD   |      | STD        | Yes      |      |
| P54C |           | Sx968    | 90MHz          | 1.5        | 60MHz          | STD   |      | STD        | Yes      |      |
| P54C |           | Sx969    | 90MHz          | 1.5        | 60MHz          | STD   |      | STD        | Yes      |      |
| P54C |           | Q0783    | 90MHz          | 1.5        | 60MHz          | STD   |      | STD        | Yes      |      |
| P54C |           | Sy006    | 90MHz          | 1.5        | 60MHz          | STD   |      | STD        | Yes      |      |
| P54C |           | Q0542    | 90MHz          | 1.5        | 60MHz          | STD   |      | STD        | Yes      |      |
| P54C |           | Q0613    | 90MHz          | 1.5        | 60MHz          | VR    |      | STD        | Yes      |      |
| P54C |           | Q0543    | 90MHz          | 1.5        | 60MHz          | STD   |      | DP         | Yes      |      |
| P54C |           | Sx879    | 90MHz          | 1.5        | 60MHz          | STD   |      | STD        | Yes      |      |
| P54C |           | Sx885    | 90MHz          | 1.5        | 60MHz          | STD   |      | MD         | Yes      |      |
| P54C |           | Sx909    | 90MHz          | 1.5        | 60MHz          | VR    |      | STD        | Yes      |      |
| P54C |           | Q0628    | 90MHz          | 1.5        | 60MHz          | STD   |      | STD        | Yes      |      |
| P54C |           | Q0611    | 90MHz          | 1.5        | 60MHz          | STD   |      | STD        | Yes      |      |
| P54C |           | Q0612    | 90MHz          | 1.5        | 60MHz          | VR    |      | STD        | Yes      |      |
| P54C |           | Sx923    | 90MHz          | 1.5        | 60MHz          | STD   |      | STD        | Yes      |      |
| P54C |           | Sx922    | 90MHz          | 1.5        | 60MHz          | VR    |      | STD        | Yes      |      |
| P54C |           | Sx921    | 90MHz          | 1.5        | 60MHz          | STD   |      | MD         | Yes      |      |
| P54C |           | Sz951    | 90MHz          | 1.5        | 60MHz          | STD   |      | STD        | Yes      |      |
| P54C |           | Q0653    | 90MHz          | 1.5        | 60MHz          | STD   |      | STD        | Yes      |      |
| P54C |           | Q0654    | 90MHz          | 1.5        | 60MHz          | VR    |      | STD        | Yes      |      |
| P54C |           | Sz978    | 90MHz          | 1.5        | 60MHz          | STD   |      | STD        | Yes      |      |
| P54C |           | Q0699    | 90MHz          | 1.5        | 60MHz          | STD   |      | STD        | Yes      |      |
| P54C |           | Sz995    | 90MHz          | 1.5        | 60MHz          | STD   |      | STD        | Yes      |      |
| P54C |           | SU031    | 90MHz          | 1.5        | 60MHz          | STD   |      | STD        | Yes      |      |
| P54C |           | Q0695    | 90MHz          | 1.5        | 60MHz          | 2.9V  | 3.3V |            | Yes      |      |

# Intel Pentium CPUs

## Pentium 100MHz

|      | CPU Speed | CPU Spec | Internal Clock | Bus Factor | External Clock | Power |      | CPU Timing | DP Supp. | Note |
|------|-----------|----------|----------------|------------|----------------|-------|------|------------|----------|------|
|      |           |          |                |            |                | Vcore | VIO  |            |          |      |
| P54C | 100 MHz   | Sx886    | 100MHz         | 1.5        | 66MHz          | STD   |      | MD         | No       |      |
| P54C |           | Sx910    | 100MHz         | 1.5        | 66MHz          | VR    |      | MD         | No       |      |
| P54C |           | Sx956    | 100MHz         | 1.5        | 66MHz          | STD   |      | STD        | No       |      |
| P54C |           | Sx960    | 100MHz         | 1.5        | 66MHz          | VRE   |      | MD         | No       |      |
| P54C |           | Q0657    | 100MHz         | 1.5        | 66MHz          | VR    |      | MD         | No       |      |
| P54C |           | Q0658    | 100MHz         | 1.5        | 66MHz          | VRE   |      | MD         | Yes      |      |
| P54C |           | Sx962    | 100MHz         | 1.5        | 66MHz          | VRE   |      | MD         | Yes      |      |
| P54C |           | Q0698/S  | 100MHz         | 1.5        | 66MHz          | VRE   |      | MD         | Yes      |      |
| P54C |           | Q0697/S  | 100MHz         | 1.5        | 66MHz          | STD   |      | STD        | Yes      |      |
| P54C |           | Sx963    | 100MHz         | 1.5        | 66MHz          | STD   |      | STD        | Yes      |      |
| P54C |           | Sx970    | 100MHz         | 1.5        | 66MHz          | VRE   |      | MD         | Yes      |      |
| P54C |           | Q0784    | 100MHz         | 1.5        | 66MHz          | STD   |      | STD        | Yes      |      |
| P54C |           | SY007    | 100MHz         | 1.5        | 66MHz          | STD   |      | STD        | Yes      |      |
| P54C |           | Q0563    | 100MHz         | 1.5        | 66MHz          | STD   |      | STD        | Yes      |      |
| P54C |           | Q0587    | 100MHz         | 1.5        | 66MHz          | VR    |      | STD        | Yes      |      |
| P54C |           | Q0614    | 100MHz         | 1.5        | 66MHz          | VR    |      | STD        | Yes      |      |
| P54C |           | Q0677    | 100MHz         | 1.5        | 66MHz          | VRE   |      | MD         | Yes      |      |
| P54C |           | Q0656    | 100MHz         | 1.5        | 66MHz          | STD   |      | MD         | Yes      |      |
| P54C |           | Q0698    | 100MHz         | 1.5        | 66MHz          | VRE   |      | MD         | Yes      |      |
| P54C |           | Q0697    | 100MHz         | 1.5        | 66MHz          | STD   |      | STD        | Yes      |      |
| P54C |           | SZ996    | 100MHz         | 1.5        | 66MHz          | STD   |      | STD        | Yes      |      |
| P54C |           | SU032    | 100MHz         | 1.5        | 66MHz          | STD   |      | STD        | Yes      |      |
| P54C |           | Q0853    | 100MHz         | 1.5        | 66MHz          | 2.9V  | 3.3V | MD         | Yes      |      |
| P54C |           | SK124    | 100MHz         | 1.5        | 66MHz          | 2.9V  | 3.3V | MD         | Yes      |      |
| P54C |           | SY046    | 100MHz         | 1.5        | 66MHz          |       |      |            | Yes      |      |
| P54C |           | Q0784    | 100MHz         | 1.5        | 66MHz          | STD   |      | STD        | Yes      |      |
| P54C |           | SU110    | 100MHz         | 1.5        | 66MHz          | STD   |      | STD        | Yes      |      |
| P54C |           | SU099    | 100MHz         | 1.5        | 66MHz          | STD   |      | STD        | Yes      |      |
|      |           |          |                |            |                |       |      |            |          |      |
|      |           |          |                |            |                |       |      |            |          |      |
|      |           |          |                |            |                |       |      |            |          |      |
|      |           |          |                |            |                |       |      |            |          |      |

# Appendix B

## Pentium120MHz

|        | CPU Speed | CPU Spec. | Internal Clock | Bus Factor | External Clock | Power |     | CPU Timing | DP Supp. | Note            |
|--------|-----------|-----------|----------------|------------|----------------|-------|-----|------------|----------|-----------------|
|        |           |           |                |            |                | Vcore | VIO |            |          |                 |
| P54CQS | 120 MHz   | Q0708     | 120MHz         | 2          | 60MHz          | STD   |     | STD        | Yes      |                 |
| P54CQS |           | Q0711     | 120MHz         | 2          | 60MHz          | VRE   |     | MD         | Yes      | Convert to P54C |
| P54CQS |           | Q0730     | 120MHz         | 2          | 60MHz          | STD   |     | MD         | Yes      |                 |
| P54CQS |           | Sk084     | 120MHz         | 2          | 60MHz          | STD   |     | MD         | Yes      |                 |
| P54CQS |           | Sk086     | 120MHz         | 2          | 60MHz          | VRE   |     | MD         | Yes      | Convert to P54C |
| P54C   |           | Sx994     | 120MHz         | 2          | 60MHz          | VRE   |     | MD         | No       |                 |
| P54C   |           | Q0732/S   | 120MHz         | 2          | 60MHz          | VRE   |     | MD         | No       |                 |
| P54C   |           | Q0785     | 120MHz         | 2          | 60MHz          | VRE   |     | STD        | No       |                 |
| P54C   |           | SY008     | 120MHz         | 2          | 60MHz          | VRE   |     | STD        | No       |                 |
| P54C   |           | SY033     | 120MHz         | 2          | 60MHz          | STD   |     | STD        | No       |                 |
| P54C   |           | Q0707     | 120MHz         | 2          | 60MHz          | VRE   |     | STD        | No       |                 |
| P54C   |           | Q0732     | 120MHz         | 2          | 60MHz          | VRE   |     | MD         | No       |                 |
| P54C   |           | SU033     | 120MHz         | 2          | 60MHz          | VRE   |     | MD         | No       |                 |
| P54C   |           | Q0776     | 120MHz         | 2          | 60MHz          | STD   |     |            | Yes      |                 |
| P54C   |           | SK110     | 120MHz         | 2          | 60MHz          | STD   |     |            | Yes      |                 |
| P54C   |           | Q0808     | 120MHz         | 2          | 60MHz          | STD   |     |            | Yes      |                 |
| P54C   |           | SX999     | 120MHz         | 2          | 60MHz          | STD   |     |            | Yes      |                 |
| P54C   |           | SY030     | 120MHz         | 2          | 60MHz          | STD   |     |            | Yes      |                 |
| P54C   |           | SU100     | 120MHz         | 2          | 60MHz          | STD   |     | STD        | No       |                 |
|        |           |           |                |            |                |       |     |            |          |                 |
|        |           |           |                |            |                |       |     |            |          |                 |
| P54CS  | Q031      | 120MHz    | 2              | 60MHz      | STD            |       | KIT | Yes        |          |                 |
| P54CS  | SY062     | 120MHz    | 2              | 60MHz      | STD            |       | KIT | Yes        |          |                 |
|        |           |           |                |            |                |       |     |            |          |                 |
|        |           |           |                |            |                |       |     |            |          |                 |



# Intel Pentium CPUs

## Pentium 133MHz

|        | CPU Speed | CPU Spec | Internal Clock | Bus Factor | External Clock | Power |     | CPU Timing | DP Supp. | Note             |
|--------|-----------|----------|----------------|------------|----------------|-------|-----|------------|----------|------------------|
|        |           |          |                |            |                | Vcore | VIO |            |          |                  |
| P54CS  | 133 MHz   | Q0772    | 133MHz         | 2          | 66MHz          | STD   |     | STD        | Yes      |                  |
| P54CS  |           | Q0773    | 133MHz         | 2          | 66MHz          | STD   |     | Kit        | Yes      |                  |
| P54CS  |           | Q0774    | 133MHz         | 2          | 66MHz          | VRE   |     | MD         | Yes      |                  |
| P54CS  |           | Q0877    | 133MHz         | 2          | 66MHz          | VRE   |     | STD        | Yes      |                  |
| P54CS  |           | Sk106    | 133MHz         | 2          | 66MHz          | STD   |     | STD        | Yes      |                  |
| P54CS  |           | SI06J    | 133MHz         | 2          | 66MHz          | STD   |     |            | Yes      |                  |
| P54CS  |           | Sk107    | 133MHz         | 2          | 66MHz          | STD   |     |            | Yes      |                  |
| P54CS  |           | Q0843    | 133MHz         | 2          | 66MHz          | STD   |     |            | Yes      |                  |
| P54CS  |           | SY022    | 133MHz         | 2          | 66MHz          | STD   |     |            | Yes      |                  |
| P54CS  |           | Q0844    | 133MHz         | 2          | 66MHz          | STD   |     |            | Yes      |                  |
| P54CS  |           | SY023    | 133MHz         | 2          | 66MHz          | STD   |     |            | Yes      |                  |
| P54CS  |           | SU038    | 133MHz         | 2          | 66MHz          | STD   |     |            | Yes      |                  |
| P54CS  |           | SU073    | 133MHz         | 2          | 66MHz          | STD   |     |            | Yes      |                  |
| P54CS  |           | Q0882    | 133MHz         | 2          | 66MHz          |       |     |            | Yes      |                  |
| P54CS  |           | SY082    | 133MHz         | 2          | 66MHz          |       |     |            | Yes      |                  |
| P54CQS |           | Q0733    | 133MHz         | 2          | 66MHz          | STD   |     | MD         | Yes      | Convert to P54CS |
| P54CQS |           | Sk098    | 133MHz         | 2          | 66MHz          | STD   |     | MD         | Yes      | Convert to P54CS |
| P54CQS |           | Q0751    | 133MHz         | 2          | 66MHz          | STD   |     | MD         | Yes      |                  |
| P54CQS |           | Q0775    | 133MHz         | 2          | 66MHz          | VRE   |     | MD         | Yes      | Convert to P54CS |
|        |           |          |                |            |                |       |     |            |          |                  |

## Appendix B

### Pentium 150MHz

|       | CPU Speed | CPU Spec | Internal Clock | Bus Factor | External Clock | Power |      | CPU Timing | DP Supp. | Note |      |
|-------|-----------|----------|----------------|------------|----------------|-------|------|------------|----------|------|------|
|       |           |          |                |            |                | Vcore | VIO  |            |          |      |      |
| P54CS | 150 MHz   | Q0835    | 150MHz         | 2.5        | 60MHz          | STD   |      | STD        | Yes      |      |      |
| P54CS |           | SY015    | 150MHz         | 2.5        | 60MHz          | STD   |      | STD        | Yes      |      |      |
| P54CS |           | Q0878    | 150MHz         | 2.5        | 60MHz          | STD   |      | STD        | Yes      | PPGA |      |
| P54CS |           | SU071    | 150MHz         | 2.5        | 60MHz          | STD   |      | STD        | Yes      |      |      |
|       |           |          |                |            |                |       |      |            |          |      |      |
| P55C  |           | Q0939    | 150MHz         | 2.5        | 60MHz          | 2.9V  | 3.3V |            |          |      | CPGA |
| P55C  |           | Q0941    | 150MHz         | 2.5        | 60MHz          | 2.9V  | 3.3V |            |          |      | PPGA |
| P55C  |           | Q974     | 150MHz         | 2.5        | 60MHz          | 2.8V  | 3.3V |            |          |      | CPGA |
| P55C  |           | Q977     | 150MHz         | 2.5        | 60MHz          | 2.8V  | 3.3V |            |          |      | PPGA |
|       |           |          |                |            |                |       |      |            |          |      |      |

### Pentium 166MHz

|       | CPU Speed | CPU Spec | Internal Clock | Bus Factor | External Clock | Power |      | CPU Timing | DP Supp. | Note    |      |
|-------|-----------|----------|----------------|------------|----------------|-------|------|------------|----------|---------|------|
|       |           |          |                |            |                | Vcore | VIO  |            |          |         |      |
| P54CS | 166MHz    | SY016    | 166MHz         | 2.5        | 66MHz          | VRE   |      |            | Yes      |         |      |
| P54CS |           | Q0841    | 166MHz         | 2.5        | 66MHz          | VRE   |      |            | Yes      |         |      |
| P54CS |           | SY017    | 166MHz         | 2.5        | 66MHz          | VRE   |      |            | Yes      |         |      |
| P54CS |           | Q0949    | 166MHz         | 2.5        | 66MHz          | VRE   |      | Kit        | No       | PPGA up |      |
| P54CS |           | SY037    | 166MHz         | 2.5        | 66MHz          | VRE   |      |            | No       | PPGA up |      |
| P54CS |           | Q0951F   | 166MHz         | 2.5        | 66MHz          | VRE   |      | Kit        | Yes      | PPGA    |      |
| P54CS |           | SY044    | 166MHz         | 2.5        | 66MHz          | VRE   |      | Kit        | Yes      | PPGA    |      |
| P54CS |           | Q0836    | 166MHz         | 2.5        | 66MHz          | VRE   |      |            | Yes      |         |      |
| P54CS |           | Q0886    | 166MHz         | 2.5        | 66MHz          | VRE   |      |            | Yes      | PPGA    |      |
| P54CS |           | Q0890    | 166MHz         | 2.5        | 66MHz          | VRE   |      |            | Yes      | PPGA    |      |
| P54CS |           | SY072    | 166MHz         | 2.5        | 66MHz          | VRE   |      |            | Yes      |         |      |
|       |           |          |                |            |                |       |      |            |          |         |      |
|       |           |          |                |            |                |       |      |            |          |         |      |
| P55C  |           | Q0940    | 166MHz         | 2.5        | 66MHz          | 2.9V  | 3.3V |            |          |         | CPGA |
| P55C  |           | Q0942    | 166MHz         | 2.5        | 66MHz          | 2.9V  | 3.3V |            |          |         | PPGA |
| P55C  |           | Q975     | 166MHz         | 2.5        | 66MHz          | 2.8V  | 3.3V |            |          |         | CPGA |
| P55C  | Q978      | 166MHz   | 2.5            | 66MHz      | 2.8V           | 3.3V  |      |            |          | PPGA    |      |
| P55C  | Q019      | 166MHz   | 2.5            | 66MHz      | 2.8V           | 3.3V  |      |            |          | PPGA    |      |
|       |           |          |                |            |                |       |      |            |          |         |      |

# Intel Pentium CPUs

## Pentium 200MHz

|       | CPU Speed | CPU Spec | Internal Clock | Bus Factor | External Clock | Power |      | CPU Timing | DP Supp. | Note    |      |
|-------|-----------|----------|----------------|------------|----------------|-------|------|------------|----------|---------|------|
|       |           |          |                |            |                | Vcore | VIO  |            |          |         |      |
| P54CS | 200 MHz   | Q0951    | 200MHz         | 3          | 66MHz          | VRE   |      |            | No       | PPGA up |      |
| P54CS |           | SY045    | 200MHz         | 3          | 66MHz          | VRE   |      | Kit        | No       | PPGA up |      |
| P54CS |           | Q0951F   | 200MHz         | 3          | 66MHz          | VRE   |      | Kit        | Yes      | PPGA    |      |
| P54CS |           | SY044    | 200MHz         | 3          | 66MHz          | VRE   |      |            | Yes      | PPGA    |      |
|       |           |          |                |            |                |       |      |            |          |         |      |
| P55C  |           |          | Q018           | 200MHz     | 3              | 66MHz | 2.8V | 3.3V       |          |         | PPGA |
|       |           |          |                |            |                |       |      |            |          |         |      |

## Appendix B

---

### Bus Factor

|               |            |   |
|---------------|------------|---|
| <b>Power</b>  | <b>STD</b> | 3.15V~3.465V (Recommended voltage is 3.38V)                                 |
|               | <b>VR</b>  | 3.300V~3.465V (Recommended voltage is 3.38V)                                |
|               | <b>VRE</b> | 3.450V~3.6V (Recommended voltage is 3.52V)                                  |
| <b>Timing</b> | <b>STD</b> | Standard Timing   |
|               | <b>MD</b>  | Min. Delay (denoting shorter minimum valid delay AC timing for some signal) |
|               | <b>Kit</b> | Supports timing for C55/C88 cache chipsets & design                         |

### P54C

1. Beginning with the P54C E-Step, standard timings have been replaced by existing Min Delay timing.

### P54CS

1. P54CS PPGA UP:No DP,No APIC,No FRC
2. Beginning with the P54C E-Step, standard timings have been replaced by existing Min Delay timing.

### P55C

1. P55C A-Step is NOT production stepping
2. A-1 step: Vcc and timing on initial samples is 2.9V +/- 0.1V
3. A-2 Step and B step: Vcc and timing on production stepping is 2.8V +/- 0.1V

# AMD-K5 CPUs

## Appendix C AMD-K5 CPUs

Recognizing AMD CPU speed, voltage and package:

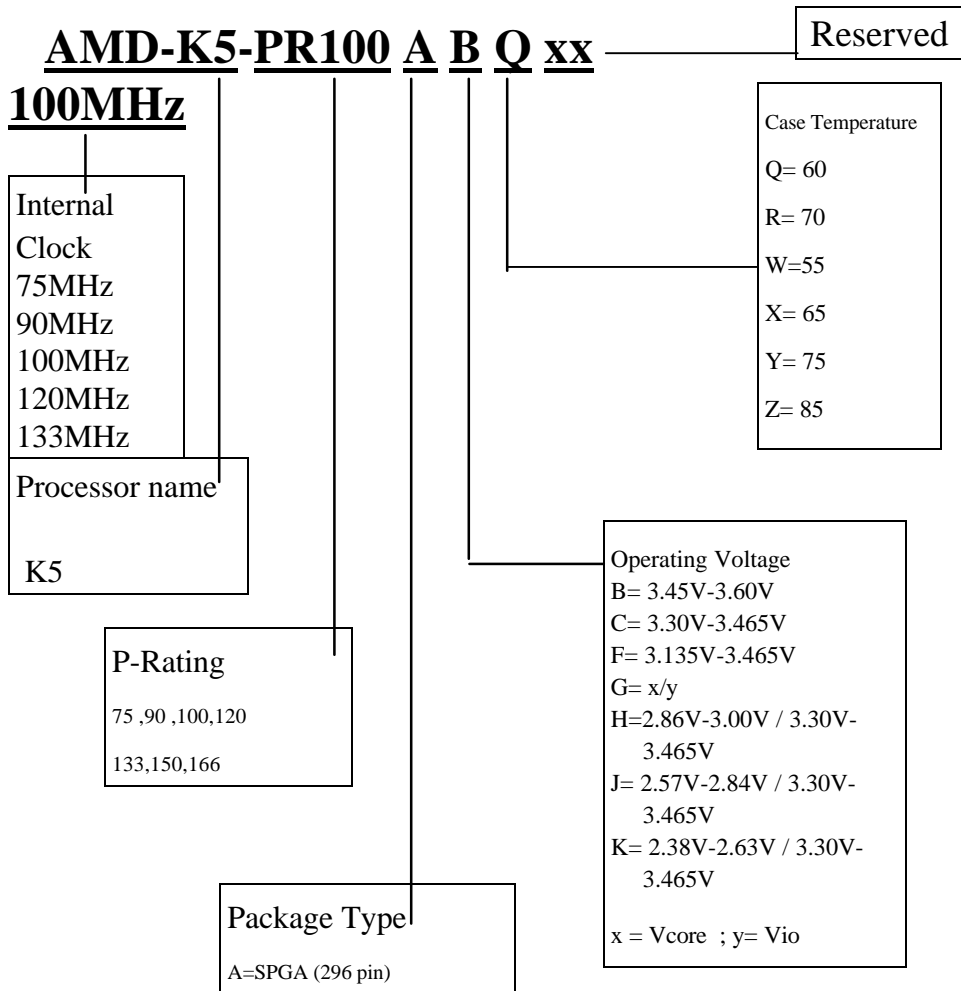



# Appendix D Cyrix 6x86 CPUs

Recognizing Cyrix CPU speed and voltage:

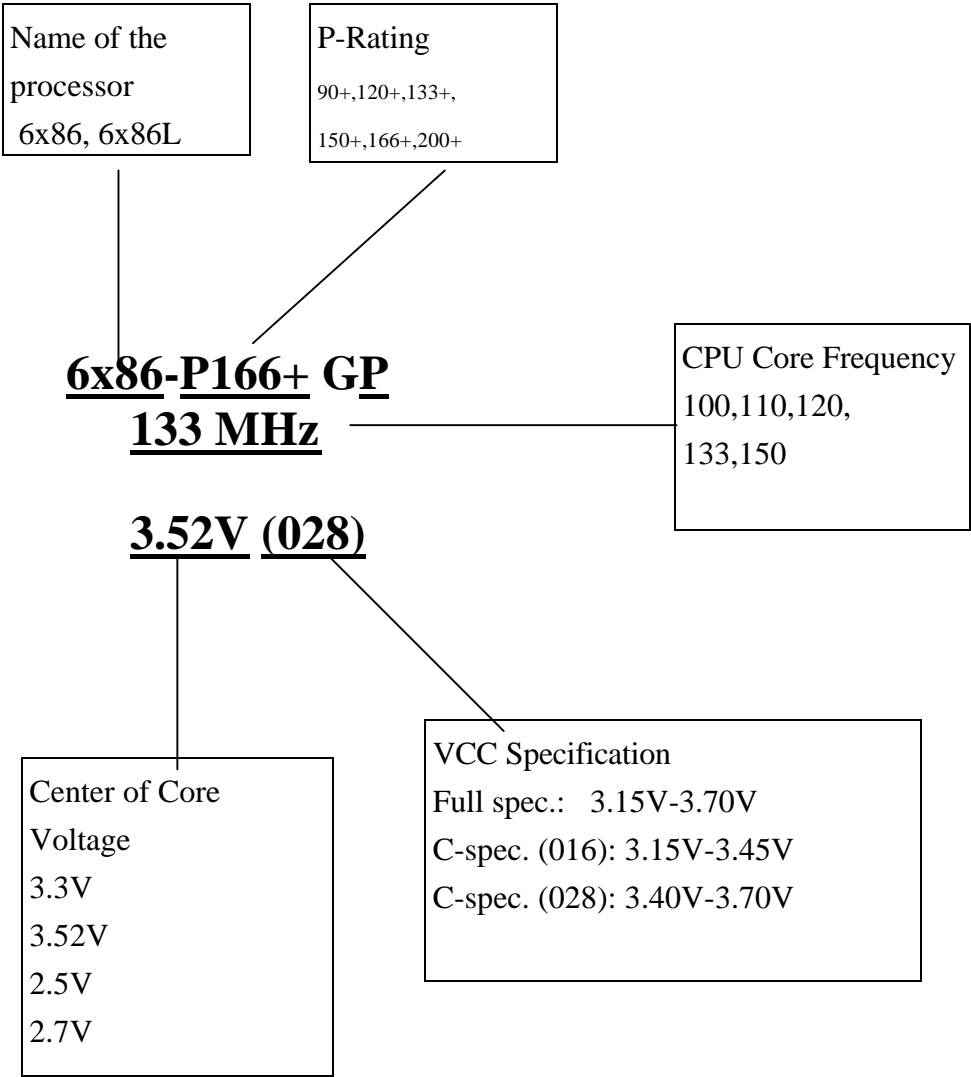





### ***Appendix E     HDD Installation***

Most of the present HDDs use IDE interface. Installing an IDE hard disk does not require a huge amount of intelligence like installing the driver for a SCSI hard disk, but this means that the user often must install the hard disk by himself and cope with all the problems he may encounter. Here, we will try to help you solve these possible problems.

The data stored in the hard disk are accessed through a chipset located on the mainboard. You probably often hear about the PIO mode, Master mode or DMA mode of HDD. These modes reflect the way data is transferred from and to the IDE drive and the mainboard.

What is the PIO mode? When the system needs to access hard disk data, the CPU delivers input/output (I/O) orders through the chipset on the mainboard to the hard disk drive, and then puts these data into the system memory. This is the PIO mode.

What is the Master mode? When the system needs to access hard disk data, these data are directly accessed from the hard disk by the chipset on the mainboard (using a DMA or a PIO mode), and then the data is put into the memory. In this case, the CPU does not participate in the data transfer.

What is the DMA mode? Usually, DMA mode refers to accessing the hard disk data by the chipset, it does not refer to data transfer mode.

Here are some examples of data transfer rates for IDE HDD with PIO interface:

PIO Mode 0 The fastest data transfer rate reaches 3.3Mbyte/sec

PIO Mode 1 The fastest data transfer rate reaches 5.2Mbyte/sec

PIO Mode 2 The fastest data transfer rate reaches 8.3Mbyte/sec

PIO Mode 3 The fastest data transfer rate reaches 11.1Mbyte/sec

PIO Mode 4 The fastest data transfer rate reaches 16.6Mbyte/sec

## Appendix E

---

The higher the MODE value is, the best is the hard disk data transfer rate. But this does not mean that you can select the highest mode value as you like. You must be sure that your hard disk supports that type of fast data transfer, otherwise your hard disk will not be able to operate correctly.

Here are some examples of data transfer rates for IDE HDD with DMA mode:

DMA Mode 0 The fastest data transfer rate reaches 4.16Mbyte/sec

DMA Mode 1 The fastest data transfer rate reaches 13.3Mbyte/sec

DMA Mode 2 The fastest data transfer rate reaches 16.6Mbyte/sec

Usually, PIO mode means that the hard disk data are accessed by the CPU through the chipset and placed into memory, and the chipset is using PIO mode to access hard disk data.

MASTER mode means that hard disk data are accessed by the chipset, and that the chipset places the data into memory. The chipset is using DMA or PIO mode to access data stored in the hard disk drive. The Master mode can reduce the CPU load, especially in a Multi-task environment. This can help system performance.

# HDD Installation

---

## Installing a hard disk:

In the **Standard CMOS Setup Menu**,

- ◆ Primary means the first connector on the mainboard, that is, connector IDE1 on our mainboard.
- ◆ Secondary means the second connector on the mainboard, that is, connector IDE2 on our mainboard.
- ◆ Two HDDs can be connected to the each connector:  
The first HDD is referred to as Master,  
The second HDD is referred to as Slave.

*The Master or Slave status of the hard disk drive is set on the hard disk itself. Refer to the hard disk drive manual.*

## Installing one HDD :

The red line on the connection cable must be lined up with pin 1 on the connector.

Be sure that your hard disk drive is set at Master. Actually, most hard disk drives are set at Master as a default, so you don't need to adjust any setting. Just connect one end of the 40 pin cable on the drive connector, and the other end to connector IDE1 on the mainboard.

## Installing one HDD + one CD-ROM drive:

The red line on the connection cable must be lined up with pin 1 on the connector.

Method 1: Set the HDD at Master, and the CD-ROM drive at Slave.

Connect one connector of the 40-pin cable to the hard disk, another one to the CD-ROM drive, and the other end to connector IDE1 on the mainboard.

Method 2: Set the HDD as Master and connect one end of the 40-pin cable to the HDD, and the other end to connector IDE1 on the mainboard.

You can ignore the setting of the CD-ROM drive, just connect one end of the 40-pin cable to the CD-ROM drive, and the other end to connector IDE2 on the mainboard.

We recommend you use this kind of connection, which has no influence on HDD speed.

# Appendix E

---

**Installing two HDDs:** The red line on the connection cable must be lined up with pin 1 on the connector.

Method 1: Set the hard disk drive used for boot up at Master, and the other drive at Slave. Connect one of the connectors of the 40-pin cable to the first drive, another connector to the second drive, and the other end of the cable to connector IDE1 on the mainboard.

Method 2: Set the hard disk drive used for boot up at Master, connect one end of the 40-pin cable to the drive, and the other end to connector IDE1 on the mainboard.

Set the other hard disk drive at Master, connect one end of the 40-pin cable to the drive, and the other end to connector IDE2 on the mainboard.

**Installing two HDDs + one CD-ROM drive:** The red line on the connection cable must be lined up with pin 1 on the connector.

Method 1: Set the hard disk drive used for boot up as Master, set the other HDD at Slave, connect one connector of the 40-pin cable to the first drive, another connector to the second drive, and the other end of the cable to connector IDE1 on the mainboard.

You can ignore the setting of the CD-ROM drive. Connect one end of the 40-pin cable to the drive, and the other end to connector IDE2 on the mainboard.

We recommend you use this method, which has no influence on HDD speed.

Method 2: Set the hard disk drive used for boot up at Master, connect one end of the 40-pin cable to the drive, and the other end to connector IDE1 on the mainboard.

Set the other hard disk drive at Master, and be sure that the CD-ROM drive is set at Slave. Most of CD-ROM drives are set at Slave as a default, so you will normally not have to set the CD-ROM drive. After you have verified the settings, connect one connector of the 40-pin cable to the HDD, another connector to the CD-ROM drive, and the other end of the cable to connector IDE2 on the mainboard.

# HDD Installation

---

**Installing three HDDs:** The red line on the connection cable must be lined up with pin 1 on the connector.

Method 1: Set the hard disk drive used for boot up at Master, set the second drive at Slave. Connect one connector of the 40-pin cable to the first drive, another connector to the second drive, and the other end of the cable to connector IDE1 on the mainboard.

Set the other (the third) drive at Master, and connect one end of the 40-pin cable to the drive, and the other end to connector IDE2 on the mainboard.

Method 2: Set the hard disk drive used for boot up at Master, and connect one end of the 40-pin cable to the drive and the other end to connector IDE1 on the mainboard. Set another drive (the second drive) at Master and the third drive at Slave, connect one connector of the 40-pin cable to the second drive, another connector to the third drive, and the other end of the cable to connector IDE2 on the mainboard.

**Installing three HDDs + one CD-ROM drive:** The red line on the connection cable must be lined up with pin 1 on the connector.

Set the hard disk drive used for boot up at Master, set another HDD (the second) at Slave, connect one connector of the 40-pin cable to the first drive, another connector to the second drive, and the other end of the cable to connector IDE1 on the mainboard.

Set the third hard disk drive at Master, set the CD-ROM drive at Slave, connect one connector of the 40-pin cable to the third HDD, another connector to the CD-ROM drive, and the other end of the cable to connector IDE2 on the mainboard.

## BIOS Setup:

- ◆ If all your HDDs are new, you can use the **IDE HDD Auto Detection** option in the CMOS to autodetect the parameters of all your drives. You don't need to set any hard disk parameter.
- ◆ If one or several of your HDDs are old, and if you don't know their parameters, and you want to reconfigure your drives, you can also use the **IDE HDD Auto Detection** option in the CMOS to autodetect the drives parameters.

## Appendix E

---

- ◆ If one or several of your HDD are old, and if you don't want to erase the data stored in your drives, you will have to remember the parameters (Type, Cylinders, Heads, Sectors, Mode) of the drive(s) you don't want to erase. After you have used the **IDE HDD Auto Detection** option in the CMOS, enter the **Standard CMOS Setup Menu** to change the settings of the related hard disk drive.

### Software use:

The basic step in using a hard disk drive is to make a **HDD Low Level Format**, than run **FDISK**, and than **FORMAT** the drive. Most of present HDD have already been subjected to low level format at the factory, so you probably can skip this operation.

Boot with a bootable floppy disk, then enter **FDISK**.

Using **FDISK**: (DOS command)

This command is found in the DOS disks.

**FDISK** is a tool used to organize and to partition the hard disk. The hard disk must have been partitioned before use. You can create one unique partition on the hard disk, or create several partition and use a different Operating System on each partition. Just don't forget that you have to specify an Active partition, otherwise your hard disk will not be bootable. For further information about **FDISK**, refer to the **FDISK** section in the DOS user's manual.

After you have partitioned the hard disk with **FDISK**, the system will reboot automatically. Boot from a system floppy disk, and type **FORMAT C:/S**

Using **FORMAT**: (DOS command)

This command is found in the DOS disks.

**FORMAT** is used to format the hard disk. The HDD have to be formatted before use. Don't forget to add **/S** after **C:**, otherwise the hard disk will not be bootable after formatting.

### ***Appendix F    Technical Support***

When you have a problem during operation...

In order to help our technical support personnel to quickly find out what is the problem of your mainboard and to give you the answers you need, before filling in the technical support form, eliminate any peripheral that is not related to the problem, and indicate on the form the key peripherals. Fax this form to your dealer or to the company where you bought the hardware in order to benefit from our technical support. (You can refer to the examples given below.)

Example 1: With a system including: mainboard (with CPU, DRAM, COAST...) HDD, CD-ROM, FDD, VGA CARD, MPEG CARD, SCSI CARD, SOUND CARD..., after the system is assembled, if you cannot boot up, check the key components of the system using the procedure described below.

First remove all interface cards except the VGA card and try to reboot.

If you still cannot boot up:

Try installing another brand/model VGA card and see if the system will start. If it still does not start, note the VGA card model, mainboard model, Bios identification number, CPU on the technical support form (refer to main instructions), and describe the problem in the problem description space provided.

If you can boot up:

Insert back the interface cards you have removed one by one and try to start the system each time you insert a card, until the system doesn't start anymore. Keep the VGA card and the interface card that causes the problem inserted on the mainboard, remove any other card or peripheral, and start again. If you still cannot start, note down the information related to both cards in the Add-On Card space provided, and don't forget to indicate the mainboard model, version, BIOS identification number, CPU (refer to main instructions), and give a description of the problem.

## Appendix F

---

Example 2: With a system including the mainboard (with CPU, DRAM, COAST...) HDD, CD-ROM, FDD, VGA CARD, LAN CARD, MPEG CARD, SCSI CARD, SOUND CARD, after assembly and after having installed the Sound Card Driver, when you restart the system, when it runs the Sound Card Driver, it resets automatically. This problem may be due to the Sound Card Driver. During the Starting DOS... procedure, press SHIFT (BY-PASS) key, to skip CONFIG.SYS and AUTOEXEC.BAT; edit CONFIG.SYS with a text editor, and in front on the line that loads the Sound Card Driver, add a remark REM, in order to disable the Sound Card Driver. See the example below.

```
CONFIG.SYS:  
DEVICE=C:\DOS\HIMEM.SYS  
DEVICE=C:\DOS\EMM386.EXE HIGHSCAN  
DOS=HIGH,UMB  
FILES=40  
BUFFERS=36  
REM DEVICEHIGH=C:\PLUGPLAY\DWCFGMG.SYS  
LASTDRIVE=Z
```

Restart the system. If the system starts and does not reset, you can be sure that the problem is due to the Sound Card Driver. Note down the Sound Card model, mainboard model, BIOS identification number on the technical support file (refer to main instructions), and describe the problem in the space provided.



# Technical Support

## Technical Support Form

Company name:

Phone #:

Contact:

Fax #:

|                           |       |                |   |
|---------------------------|-------|----------------|---|
| Model                     | *     | BIOS ID #      | * |
| Mainboard model no.       |       | DRIVER REV     |   |
| OS/Application            | *     |                |   |
|                           |       |                |   |
| Hardware name             | Brand | Specifications |   |
| C.P.U                     | *     |                |   |
| HDD IDE1<br>IDE2          |       |                |   |
| CD-ROM Drive IDE1<br>IDE2 |       |                |   |
| System Memory (DRAM)      |       |                |   |
| COAST                     |       |                |   |
| ADD-ON CARD               |       |                |   |
|                           |       |                |   |
|                           |       |                |   |
|                           |       |                |   |
|                           |       |                |   |

Problem Description:

\_\_\_\_\_  
\_\_\_\_\_

## Appendix F

---

### Instructions...

To fill in this “Technical Support Form”, refer to the step-by-step instructions given below:

**\*1. MODEL:** Note the model number given in your user’s manual.

Example: PT5R2, PR5R2...

**\*2. Mainboard model number (REV):** Note the mainboard model number labeled on the mainboard as “REV:\*.\*\*”.

Example: REV:2.11

**\*3. BIOS ID# :** See below:

Example:

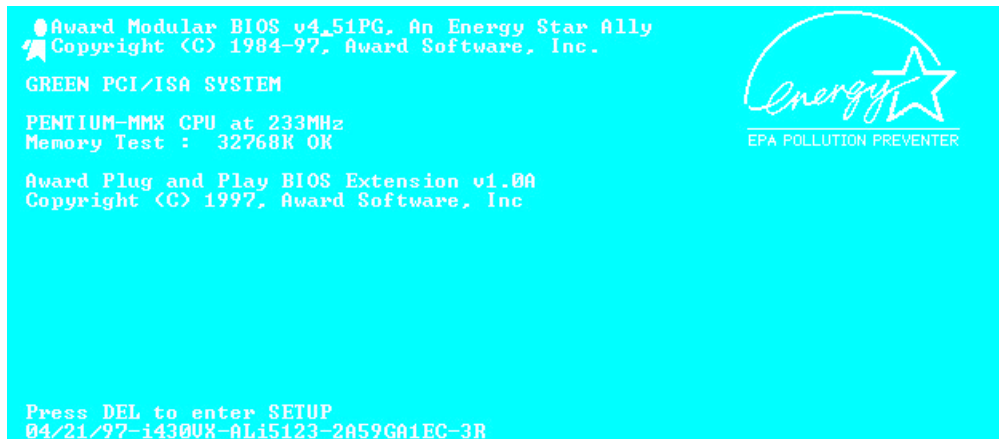

“3R” is the BIOS ID number.

“2A59GA1EC” is the BIOS part number

## Technical Support

---

- 4. DRIVER REV:** Note the driver version number indicated on the DEVICE DRIVER disk as "Release \*.\*".

Example: IDE Device Driver  
Drivers Diskette Release 1.09A

Release 1.09A

- \*5. OS/APPLICATION:** Indicate what are the operating system and the applications your are running on the system.

Example: MS-DOS 6.22, Windows 3.1....

- \*6. CPU:** Indicate the brand and the speed (MHz) of your CPU.

Example: (A) In the "Brand" space, write "Intel", in the "Specifications" space, write "150MHz"

(B) In the "Brand" space, write "Cyrix", in the "Specifications" space, write "P166+"

(C) In the "Brand" space, write "AMD", in the "Specifications" space, write "P75".

- 7. HDD:** Indicate the brand and specifications of your HDD(s), specify if the HDD is using IDE1 or IDE2. If you know the disk capacity, indicate it and check ( " ") ""; in case you give no indication, we will consider that your HDD is " IDE1" Master.

Example: In the "HDD" space, check the box, in the Brand space, write "Seagate", in the Specifications space, write "ST31621A (1.6GB)".

- 8. CD-ROM Drive:** Indicate the brand and specifications of your CD-ROM drive, specify if it uses IDE1 or IDE2 and check ( " ") ""; in case you give no indication, we will consider that your CD-ROM is " IDE2" Master.

Example: In the "CD-ROM drive" space, check the box, in the Brand space, write "Mitsumi", in the Specifications space, write "FX-400D".

## Appendix F

---

**9. System Memory (DRAM):** Indicate the brand and specifications (SIMM/DIMM) of your system memory.

Examples:

In the Brand space, write “Panasonic”, in the Specifications space, write “SIMM-FP DRAM 4MB-06”.

Or, in the Brand, write “NPNX”, in the Specifications space, write “SIMM-EDO DRAM 8MB-06”.

Or, in the Brand space, write “SEC”, in the Specifications space, write “DIMM-S DRAM 8MB-G12”.

**10. COAST:** Indicate the brand and specifications of your COAST.

Example:

In the Brand space, write “Winbond”, in the Specifications space, write “256KB” or “W25P010AF-8”

**11. ADD-ON CARD:** Indicate which add-on cards you are “absolutely sure” are related to the problem.

If you cannot identify the problem origin, indicate all the add-on cards inserted into your system.

**Note:** Items between the “\*” are absolutely necessary.

# Flash BIOS User Instructions

## Appendix G Flash BIOS Upgrade

```
FLASH MEMORY WRITER v5.34
Copyright (C) 1996, Award Software, Inc..

AWDFLASH [(FLASH)[PATH][FILENAME]] [/Py,Pn]
          [(SAVE)[PATH][FILENAME]] [/Sy,Sn]
          [(CLEAR CMOS)/CC] [(CLEAR PnP)/CP]
          [/?]

[Py/Pn] PROGRAM BIOS ANSWER Y or N.
[Sy/Sn] SAVE OLDBIOS ANSWER Y or N.
[/?] FOR HELP !
EXAMPLE 1 : AWDFLASH NEWBIOS /Py SAVEBIOS /Sy
EXAMPLE 2 : AWDFLASH NEWBIOS SAVEBIOS /CC
EXAMPLE 3 : AWDFLASH NEWBIOS /Sn /CP
EXAMPLE 4 : AWDFLASH /Pn SAVEBIOS

Error Message :
```

- Example 1 To update BIOS and create a backup of the current system BIOS execute this command:  
**AWDFLASH NEWBIOS /Py SAVEBIOS /Sy**
- Example 2 To update BIOS, create a backup of current system BIOS, and clear the CMOS, execute this command:  
**AWDFLASH NEWBIOS SAVEBIOS /CC**
- Example 3 To update BIOS and clear PnP settings execute this command:  
**AWDFLASH NEWBIOS /Sn /CP**
- Example 4 To make a backup of the current system BIOS execute the following command:  
**AWDFLASH NEWBIOS /Pn SAVEBIOS**

**Notes:** “NEWBIOS” indicates file name for the new BIOS which can be downloaded from our website at <http://www.jaton.com.tw> (user can choose a different file name in place of NEWBIOS).

“SAVEBIOS” indicates the filename of the old system BIOS (user can choose a different file name in place of SAVEBIOS).

## Appendix G

---

Explanation of parameter names:

/CC: Clears CMOS data

/CP: Clears PnP data

### Remarks:

- ① When executing AWDFLASH.EXE, do not run HIMEM.SYS and EMM386.EXE in the CONFIG.SYS.
- ② Please take the following actions to solve problems caused by power shortage or other other unpreventable malfunctions during BIOS update that lead to update failure. First, it is strongly suggested that you format a disk that can boot your computer before you update your BIOS. If the above mentioned problem occurs during BIOS update you will be able to use this disk to automatically execute a BIOS update. The content of the disk should be the following:
  - a. Startup system files (COMMAND.COM, MSDOS.SYS, IO.SYS...)
  - b. AWDFLASH.EXE
  - c. The NEWBIOS file which can be downloaded from Jatón's website.
  - d. AUTOEXEC.BAT, which has the following content:  
**A:\AWDFLASH NEWBIOS /Py /Sn**

When a version of BIOS that is for the incorrect mainboard model the following message will appear:

**“The program file's part number does not match with your system!”**

**LIMITED WARRANTY:**

This product is warranted against defects in materials and workmanship for a period of two years from the date of purchase from authorized agent. During the warranty period, product determined by us to be defective in form or function will be repaired or at our option, replaced at no charge. This warranty does not apply if the product has been damaged by accident, abuse, misuse, or as result of service or modification other than by us.

This warranty is in lieu of any other warranty expressed or implied. In no event shall we be held liable for incidental or consequential damages arising from the purchase of this product.