

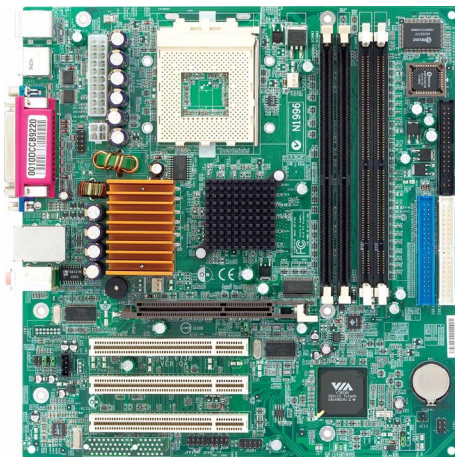

KM2M Combo

MS-6738 (v1.X) Micro ATX Mainboard



Version 1.0
G52-M6738X1-G22

Manual Rev: 1.0

Release Date: December 2002



FCC-B Radio Frequency Interference Statement

This equipment has been tested and found to comply with the limits for a class B digital device, pursuant to part 15 of the FCC rules. These limits are designed to provide reasonable protection against harmful interference when the equipment is operated in a commercial environment. This equipment generates, uses and can radiate radio frequency energy and, if not installed and used in accordance with the instruction manual, may cause harmful interference to radio communications. Operation of this equipment in a residential area is likely to cause harmful interference, in which case the user will be required to correct the interference at his own expense.

Notice 1

The changes or modifications not expressly approved by the party responsible for compliance could void the user's authority to operate the equipment.

Notice 2

Shielded interface cables and A.C. power cord, if any, must be used in order to comply with the emission limits.

VOIR LA NOTICE D'INSTALLATION AVANT DE RACCORDER AU RESEAU.

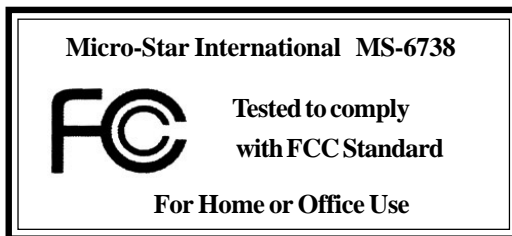

Copyright Notice

The material in this document is the intellectual property of **MICRO-STAR INTERNATIONAL**. We take every care in the preparation of this document, but no guarantee is given as to the correctness of its contents. Our products are under continual improvement and we reserve the right to make changes without notice.

Trademarks

All trademarks are the properties of their respective owners.

All trademarks are the properties of their respective owners.

AMD, Athlon™, Athlon™ XP, Thoroughbred™, and Duron™ are registered trademarks of AMD Corporation.

Intel® and Pentium® are registered trademarks of Intel Corporation.

PS/2 and OS®/2 are registered trademarks of International Business Machines Corporation.

Microsoft is a registered trademark of Microsoft Corporation. Windows® 98/2000/NT/XP are registered trademarks of Microsoft Corporation.

NVIDIA, the NVIDIA logo, DualNet, and nForce are registered trademarks or trademarks of NVIDIA Corporation in the United States and/or other countries.

Netware® is a registered trademark of Novell, Inc.

Award® is a registered trademark of Phoenix Technologies Ltd.

AMI® is a registered trademark of American Megatrends Inc.

Kensington and MicroSaver are registered trademarks of the Kensington Technology Group.

PCMCIA and CardBus are registered trademarks of the Personal Computer Memory Card International Association.

Revision History

Revision	Revision History	Date
V1.0	First release for PCB 1.x	Dec. 2002

Safety Instructions

1. Always read the safety instructions carefully.
2. Keep this User's Manual for future reference.
3. Keep this equipment away from humidity.
4. Lay this equipment on a reliable flat surface before setting it up.
5. The openings on the enclosure are for air convection hence protects the equipment from overheating. **Do not cover the openings.**
6. Make sure the voltage of the power source and adjust properly 110/220V before connecting the equipment to the power inlet.
7. Place the power cord such a way that people can not step on it. Do not place anything over the power cord.
8. Always Unplug the Power Cord before inserting any add-on card or module.
9. All cautions and warnings on the equipment should be noted.
10. Never pour any liquid into the opening that could damage or cause electrical shock.
11. If any of the following situations arises, get the equipment checked by a service personnel:
 - The power cord or plug is damaged.
 - Liquid has penetrated into the equipment.
 - The equipment has been exposed to moisture.
 - The equipment has not work well or you can not get it work according to User's Manual.
 - The equipment has dropped and damaged.
 - The equipment has obvious sign of breakage.
12. **Do not leave this equipment in an environment unconditioned, storage temperature above 60^o C (140^oF), it may damage the equipment.**



CAUTION: Danger of explosion if battery is incorrectly replaced. Replace only with the same or equivalent type recommended by the manufacturer.

CONTENTS

FCC-B Radio Frequency Interference Statement	ii
Copyright Notice	iii
Revision History	iii
Safety Instructions	iv
Chapter 1. Getting Started	1-1
Mainboard Specifications	1-2
Mainboard Layout	1-4
MSI Special Features	1-5
PC Alert™ 4	1-5
Live BIOS™/Live Driver™	1-7
Live Monitor™	1-8
Chapter 2. Hardware Setup	2-1
Quick Components Guide	2-2
Central Processing Unit: CPU	2-3
CPU Core Speed Derivation Procedure	2-3
CPU Installation Procedures for Socket 462	2-4
Installing AMD Athlon CPU (Socket 462) Cooler Set	2-5
Memory	2-6
DDR Module Combination	2-7
Installing DDR Modules	2-7
SDR Module Combination	2-8
Installing SDR Modules	2-8
Power Supply	2-9
ATX 20-Pin Power Connector: CONN1	2-9
ATX 12V Power Connector: JPW1	2-9
Back Panel	2-10
Mouse Connector	2-10
Keyboard Connector	2-11

Serial Port Connectors: COM A & JCOM2 (Optional)	2-12
VGA Connector	2-13
RJ-45 LAN Jack (Optional)	2-13
Audio Port Connectors	2-13
Parallel Port Connector: LPT1	2-14
Connectors	2-15
Floppy Disk Drive Connector: FDD1	2-15
Chassis Intrusion Switch Connector: JCI1	2-15
Hard Disk Connectors: IDE1 & IDE2	2-16
Fan Power Connectors: CPUFA1/SYSFA1	2-17
Front Panel Connectors: JFP1 & JFP2	2-18
Front Panel Audio Connector: JAUD1	2-19
Front USB Connectors: JUSB1	2-20
SPDIF Connector: JSP1	2-21
CD-In Connector: JCD1	2-22
IrDA Infrared Module Header: JIR1	2-22
Jumpers	2-23
Clear CMOS Jumper: JBAT1	2-23
FSB Mode Jumper: SW1	2-24
Slots	2-25
AGP (Accelerated Graphics Port) Slot (Optional)	2-25
PCI Interrupt Request Routing	2-26
Chapter 3. BIOS Setup	3-1
Entering Setup	3-2
Control Keys	3-2
Getting Help	3-3
The Main Menu	3-4
Standard CMOS Features	3-6
Advanced BIOS Features	3-8
Advanced Chipset Features	3-12

Integrated Peripherals	3-16
Power Management Setup	3-21
PNP/PCI Configurations	3-25
PC Health Status	3-27
Frequency/Voltage Control	3-28
Load Fail-Safe/Optimized Defaults	3-29
Set Supervisor/User Password	3-30
Appendix: Using 4- or 6-Channel Audio Function	A-1
Using 4- or 6-Channel Audio Function	A-2
Installing the Audio Driver	A-2
Using 4- or 6-Channel Audio Function	A-2
Testing the Connected Speakers	A-6
Testing Each Speaker:	A-6
Playing KaraOK	A-8
Playing KaraOK	A-8
Troubleshooting	T-1
Glossary	G-1

1

Getting Started

Thank you for purchasing KM2M (MS-6738) v1.X Micro ATX mainboard. The KM2M is based on **VIA® KM266** & **VIA® VT8235** chipsets and provides 6 USB ports for high-speed data transmission. With all these special designs, the KM2M v1.x delivers a high performance and professional desktop platform solution.

Mainboard Specifications

CPU

- ▶ Socket A for AMD® Duron™/Athlon™/ XP™ processor.
- ▶ Supports 1GHz to Athlon™/ XP™ 2600+ processor.

Chipset

- ▶ VIA® KM266 Chipset.
 - FSB @200/266MHz.
 - Integrated Savage 8 2D/3D Graphic Controller.
 - AGP 4x and high bandwidth Vlink host controller.
 - Advanced memory controller support PC2100 (DDR266) technology.
- ▶ VIA® VT8235 Chipset
 - 533MB/sec Vlink client controller.
 - Direct sound ready AC97 digital audio controller.
 - Ultra DMA 66/100/133 master mode EIDE controller.
 - Supports both ACPI and legacy APM power management.
 - 6 ports USB 2.0 controller.
 - Integrated Ethernet MAC.

Main Memory

- ▶ Supports four memory banks using two 184-pin DDR DIMMs or two 168-pin SDR DIMMs.
- ▶ Supports a maximum memory size of 2GB .
- ▶ Supports 2.5v DDR SDRAM DIMM.

Slots

- ▶ One 4x/2x 2.0 AGP (Accelerated Graphics Port) universal slot. (Optional)
- ▶ Three PCI 2.2 32-bit Master PCI Bus slots, supporting 3.3v/5v PCI bus Interface.

On-Board IDE

- ▶ Dual Channel master mode IDE controller on the VIA® VT8235 Chipset provides IDE HDD/CD-ROM with PIO, Bus Master and Ultra DMA 66/100/133 operation modes.
- ▶ Can connect up to four IDE devices.

On-Board Peripherals

- ▶ On-Board Peripherals include:

- 1 floppy port supports 2 FDDs with 360K, 720K, 1.2M, 1.44M and 2.88 Mbytes.
- 1 serial port (COM1), 1 Intel-spec serial port (JCOM2, Optional) and 1 VGA port
- 1 parallel port supports SPP/EPP/ECP mode
- 6 USB ports (Rear * 4 / Front * 2)
- 1 Line-In/Line-Out/Mic-In port
- 1 LAN RJ45 connector (Optional)
- 1 IrDA connector for SIR/CIR/ASKIR/HPSIR

Audio

- Front Audio supported.
- Chip Integrated.
 - 5.1 channel AC'97 software Audio.
 - Realtek ALC 650 codec.

LAN (Optional)

- VIA VT8235 integrated MAC + VIA 6103 PHY.
- RJ45 connector.

BIOS

- 2MB Award BIOS with PNP BIOS, ACPI, SMBIOS 2.3, Green and Boot Block.
- Provides DMI 2.0, WFM 2.0, WOL, WOR, chassis intrusion, and SMBus for system management.

Dimension

- Micro-ATX Form Factor: 24.5 cm (L) x 23.8 cm (W).

Mounting

- 6 mounting holes.

Others

- LAN Wake-Up function
- Support DMI (Desktop Management Interface) through BIOS
- Support PCI 2.2
- PC2001 Compliant
- Support PS2 Keyboard/Mouse and USB Keyboard/Mouse wake up function

Mainboard Layout

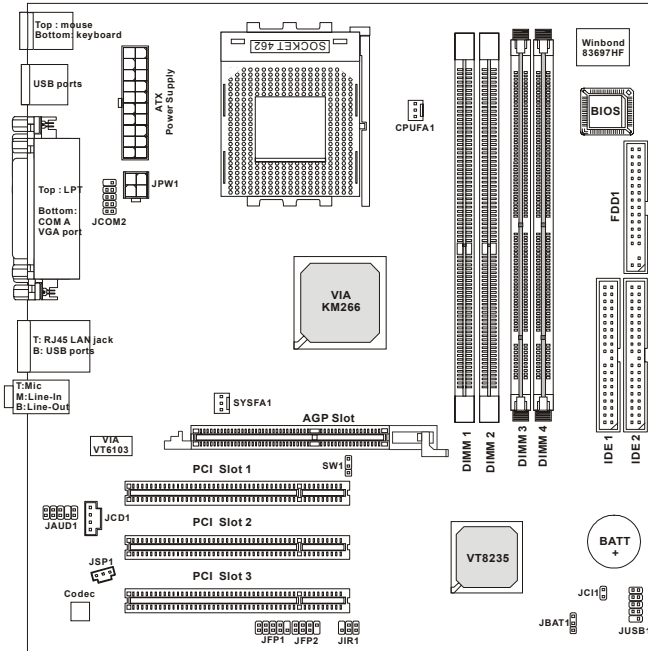

KM2M Combo (MS-6738) v1.X Micro ATX Mainboard

MSI Special Features

PC Alert™ 4

The PC Alert™ 4 is a utility you can find in the CD-ROM disk. The utility is just like your PC doctor that can detect the following PC hardware status during real time operation:

- ◆ monitor CPU & system temperatures
- ◆ monitor fan speeds
- ◆ monitor system voltages



If one of the items above is abnormal, the program main screen will be immediately shown on the screen, with the abnormal item highlighted in red. This will continue to be shown until the condition returns to the normal status.

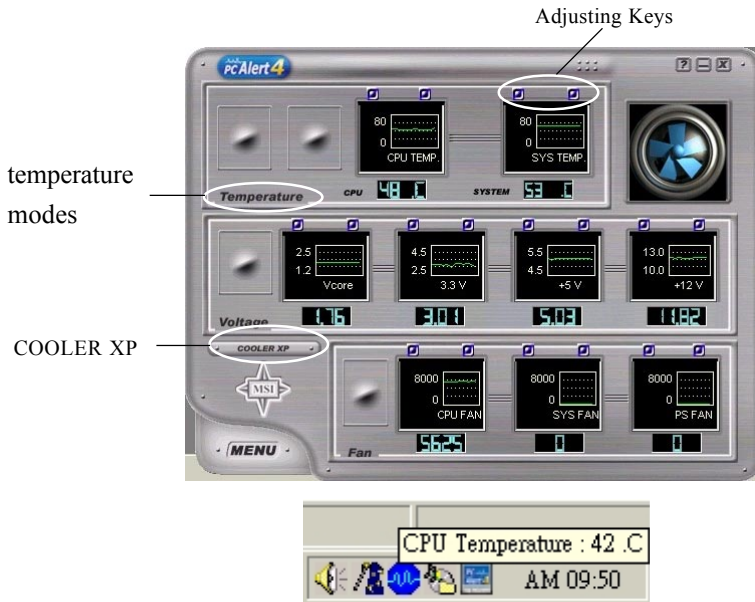

Users can use the Adjusting Keys to change the minimum and maximum threshold of each item for the system to send out a warning message. Click *Temperature* to select the temperature modes of either Fahrenheit (°F) or Celsius (°C). The PC Alert4 icon on the Status Area will show the current CPU temperature.

To better protect the CPU from overheating, a new feature, **COOLER XP**, has been added to decrease the temperature of AMD Athlon XP CPU. To do so, simply click **COOLER XP** and the screen will show the **Cute** skin (as shown below) with information about the CPU and chipset. Right-click the mouse to select the skin you want to switch to.

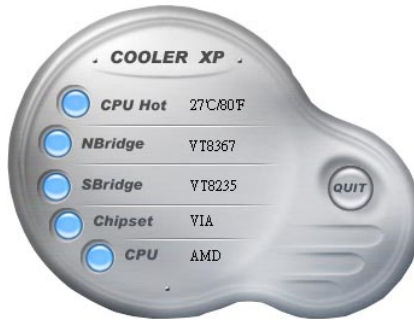

Cute



MSI Reminds You...

*The new feature **COOLER XP** will work only if your mainboard supports AMD Athlon XP CPU.*

Items shown on PC Alert 4 vary depending on your system's status.

Live BIOS™/Live Driver™

The Live BIOS™/Live Driver™ is a tool used to detect and update your BIOS/drivers online so that you don't need to search for the correct BIOS/driver version throughout the Web site. To use the function, you need to install the “MSI Live Update 2” application. After the installation, the “MSI Live Update 2” icon (as shown on the right) will appear on the screen.



Double click the “MSI Live Update 2” icon, and the following screen will appear:

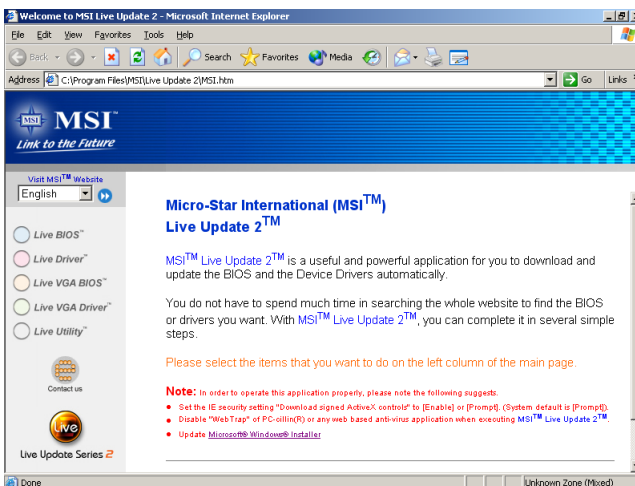

Five buttons are placed on the leftmost pane of the screen. Click the desired button to start the update process.

- **Live BIOS** – Updates the BIOS online.
- **Live Driver** – Updates the drivers online.
- **Live VGA BIOS** – Updates the VGA BIOS online.
- **Live VGA Driver** – Updates the VGA driver online.
- **Live Utility** – Updates the utilities online.

If the product you purchased does not support any of the functions listed above, a “sorry” message is displayed. For more information on the update instructions, insert the companion CD and refer to the “Live Update Guide” under the “Manual” Tab.

Live Monitor™

The Live Monitor™ is a tool used to schedule the search for the latest BIOS/drivers version on the MSI Web site. To use the function, you need to install the “MSI Live Update Series 2” application. After the installation, the “MSI Live Monitor” icon (as shown on the right) will appear on the screen. Double click this icon to run the application.



Double click the “MSI Live Monitor” icon  at the lower-right corner of the taskbar, and the following dialog box will appear. You can specify how often the system will automatically search for the BIOS/drivers version, or change the LAN settings right from the dialog box.

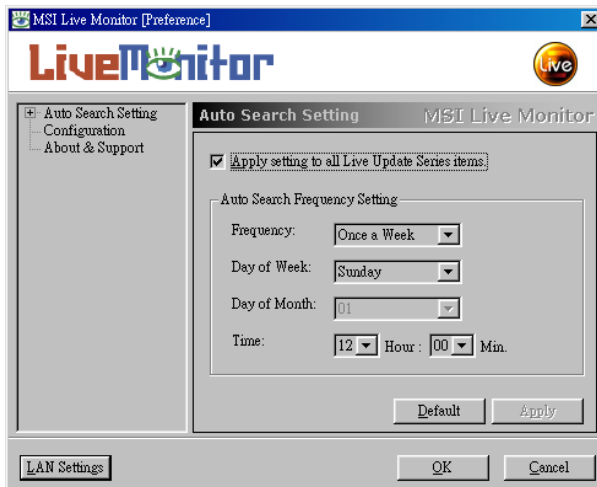

You can right-click the MSI Live Monitor icon  to perform the functions listed below:

- **Auto Search** – Searches for the BIOS/drivers version you need immediately.
- **View Last Result** – Allows you to view the last search result if there is any.
- **Preference** – Configures the Search function, including the Search schedule.
- **Exit** – Exits the Live Monitor™ application.

2



Hardware Setup

This chapter tells you how to install the CPU, memory modules, and expansion cards, as well as how to setup the jumpers on the mainboard. Also, it provides the instructions on connecting the peripheral devices, such as the mouse, keyboard, etc.

While doing the installation, be careful in holding the components and follow the installation procedures.

Quick Components Guide

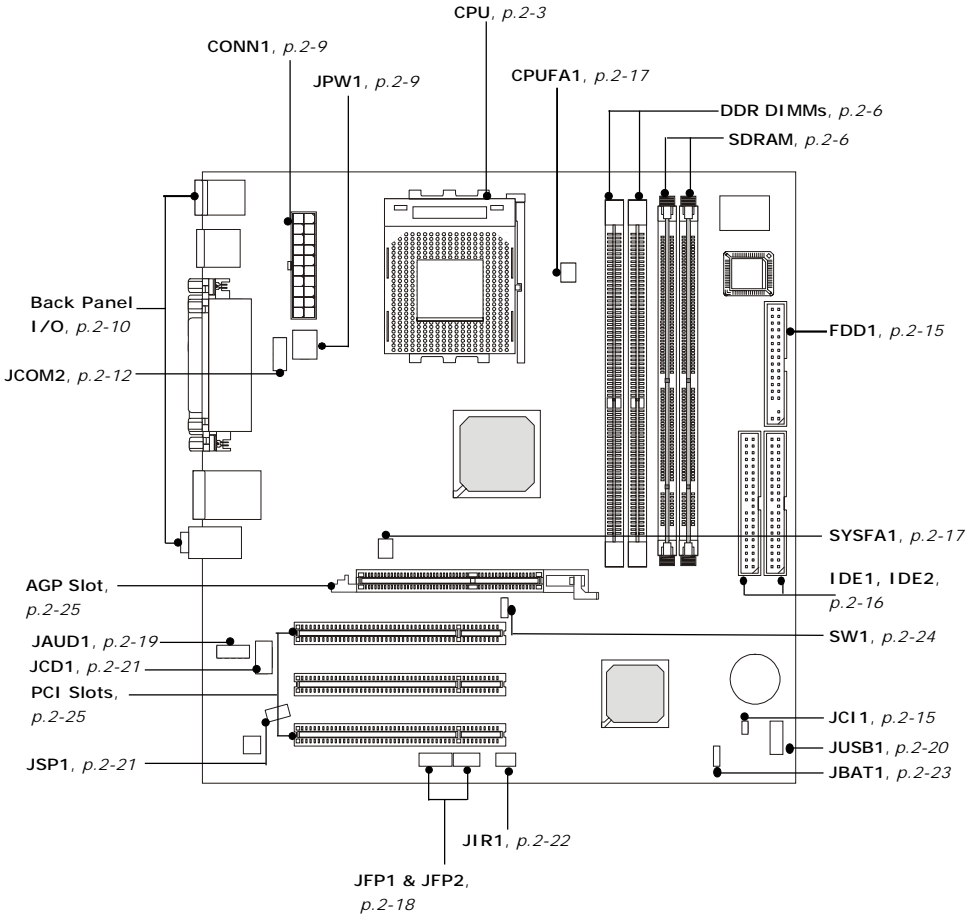

Central Processing Unit: CPU

The mainboard supports AMD® Athlon™, Athlon™ XP and Duron™ processors in the 462 pin package. The mainboard uses a CPU socket called Socket-462 for easy CPU installation. When you are installing the CPU, **make sure the CPU has a heat sink and a cooling fan attached on the top to prevent overheating.** If you do not find the heat sink and cooling fan, contact your dealer to purchase and install them before turning on the computer.

CPU Core Speed Derivation Procedure

CPU Clock multiplied by Core/Bus ratio equals the CPU core speed.

For example:

If	CPU Clock	=	100MHz
	Core/Bus ratio	=	14
then	CPU core speed	=	Host Clock x Core/Bus ratio
		=	100MHz x 14
		=	1.4 GHz



WARNING!

Thermal Issue for CPU

As processor technology pushes to faster speeds and higher performance, thermal management becomes increasingly crucial when building computer systems. Maintaining the proper thermal environment is key to reliable operation. As such, the processor must be maintained in the specified thermal requirements. AMD recommends the use of high performance thermal interface material.

AMD Athlon™/Duron™ processor with a speed of **600MHz and above** requires LARGER heatsink and fan. You also need to add thermal grease between the CPU and heatsink to improve heat dissipation. Then, make sure that the CPU and heatsink are securely fastened and in good contact with each other. These are needed to prevent damaging the processor and ensuring reliable operation.

You can check AMD's web site for more information.

CPU Installation Procedures for Socket 462

1. Please turn off the power and unplug the power cord before installing the CPU.
2. Pull the lever sideways away from the socket. Make sure to raise the lever up to a 90-degree angle.
3. Look for the gold arrow. The gold arrow should point towards the lever pivot. The CPU can only fit in the correct orientation.
4. If the CPU is correctly installed, the pins should be completely embedded into the socket and can not be seen. Please note that any violation of the correct installation procedures may cause permanent damages to your mainboard.
5. Press the CPU down firmly into the socket and close the lever. As the CPU is likely to move while the lever is being closed, always close the lever with your fingers pressing tightly on top of the CPU to make sure the CPU is properly and completely embedded into the socket.

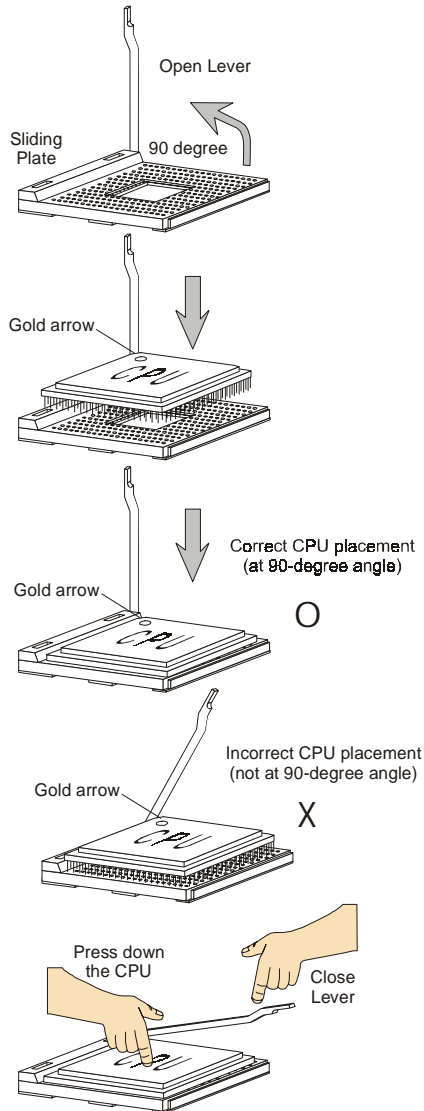

Installing AMD Athlon CPU (Socket 462) Cooler Set

The following instructions will guide you through the heat sink installation procedures. Please consult your agent for the proper CPU cooler set.

1. Position your CPU cooler set onto the CPU.
2. Use one end of the clip to hook the latch of the CPU sliding plate.
3. Hook the other latch to fix the cooling fan set. You may need a screw drive to press down the other side of the clip.
4. Connect the fan to the power supply connector provided on your mainboard.

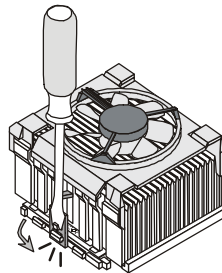
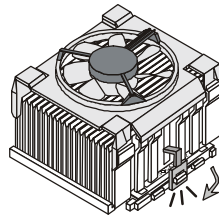
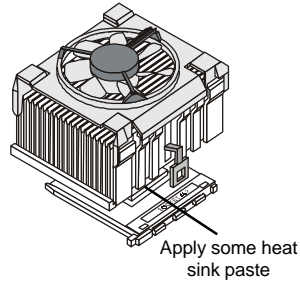

MSI Reminds You...

Please apply some heat sink paste on top of CPU to dissipate the heat more effectively.

Memory

The mainboard provides two 184-pin unbuffered PC2700/PC2100/PC1600 DDR SDRAM or two 168-pin unbuffered PC100/133 SDRAM and supports the memory size up to 2GB. To operate properly, at least one DIMM module must be installed.

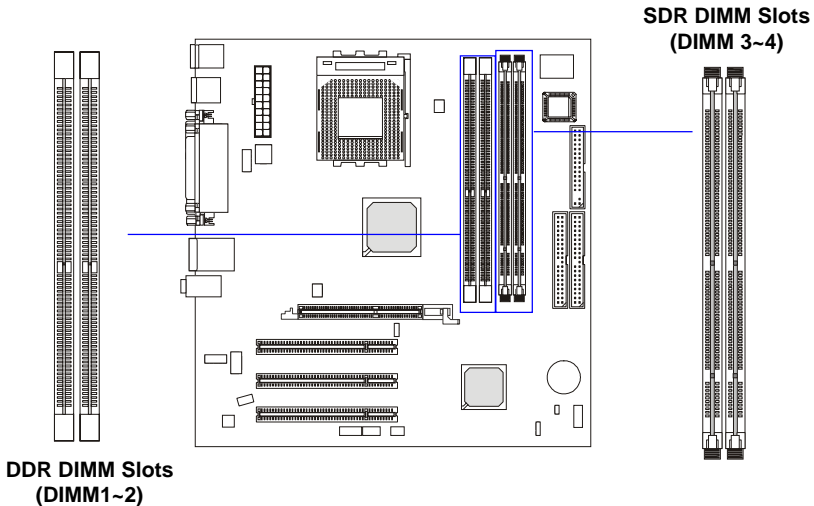

MSI Reminds You...

Make sure that you install **only one type of memory modules (either SDR or DDR) at one time**. **DO NOT** install both types at the same time. For security reason, the system will automatically power off if you simultaneously install SDR & DDR memory modules onboard.

DDR Module Combination

Install at least one DIMM module on the slots. Memory modules can be installed on the slots in any order. You can install either single- or double-sided modules to meet your own needs.

Memory modules can be installed in any combination as follows:

Slot	Memory Module	Total Memory
DDR 1 (Bank 0 & 1)	S/D	64MB~1GB
DDR 2 (Bank 2 & 3)	S/D	64MB~1GB
Maximum System Memory Supported		64MB~2GB

S: Single Side

D: Double Side

Installing DDR Modules

1. The DDR DIMM has only one notch on the center of module. The module will only fit in the right orientation.
2. Insert the DIMM memory module vertically into the DIMM slot. Then push it in until the golden finger on the memory module is deeply inserted in the socket.
3. The plastic clip at each side of the DIMM slot will automatically close.

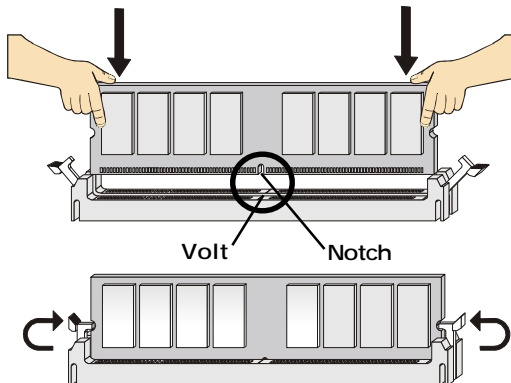

MSI Reminds You...

You can barely see the golden finger if the module is properly inserted in the socket.

SDR Module Combination

At least one DIMM module should be installed on the motherboard. Memory modules can be installed on the slots in any order. The single-/double-sided memory modules that each DIMM slot supports are listed as below:

Slot	Memory Module	Total Memory
DIMM 1 (Bank 0 & 1)	S/D	64MB~1GB
DIMM 2 (Bank 2 & 3)	S/D	64MB~1GB
Maximum System Memory Supported		64MB~2GB

S: Single Side

D: Double Side

Installing SDR Modules

1. The SDR DIMM slot has 2 Notch Keys “VOLT and DRAM”, so the DIMM memory module can only fit in one direction.
2. Insert the DIMM memory module vertically into the DIMM slot. Then push it in.
3. The plastic clip at each side of the DIMM slot will automatically close.

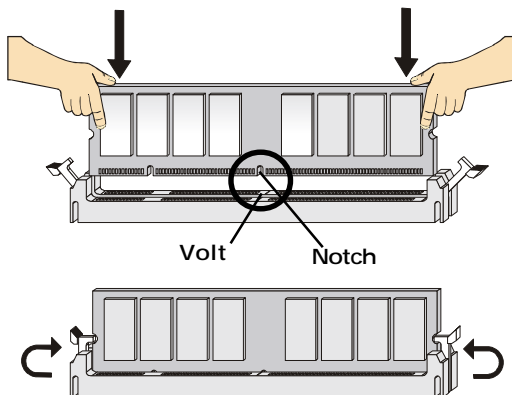

MSI Reminds You...

You can barely see the golden finger if the module is properly inserted in the socket.

Power Supply

The mainboard supports ATX power supply for the power system. Before inserting the power supply connector, always make sure that all components are installed properly to ensure that no damage will be caused.

ATX 20-Pin Power Connector: CONN1

This connector allows you to connect to an ATX power supply. To connect to the ATX power supply, make sure the plug of the power supply is inserted in the proper orientation and the pins are aligned. Then push down the power supply firmly into the connector.

ATX 12V Power Connector: JPW1

This 12V power connector is used to provide power to the CPU.

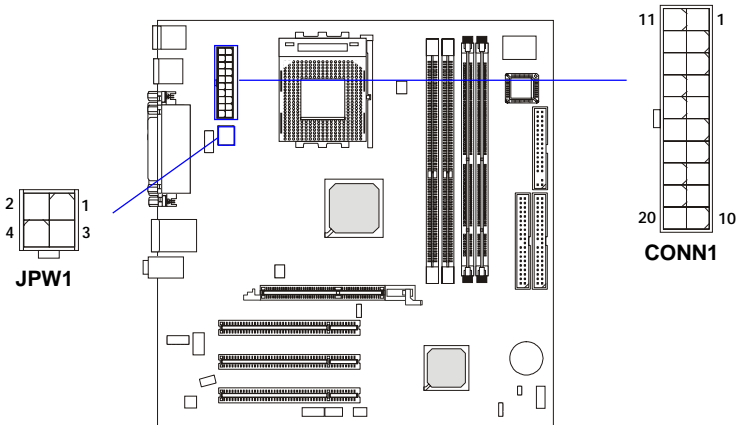

JPW1 Pin Definition

PIN	SIGNAL
1	GND
2	GND
3	12V
4	12V

CONN1 Pin Definition

PIN	SIGNAL	PIN	SIGNAL
1	3.3V	11	3.3V
2	3.3V	12	-12V
3	GND	13	GND
4	5V	14	PS_ON
5	GND	15	GND
6	5V	16	GND
7	GND	17	GND
8	PW_OK	18	-5V
9	5V_SB	19	5V
10	12V	20	5V

Back Panel

The back panel provides the following connectors:

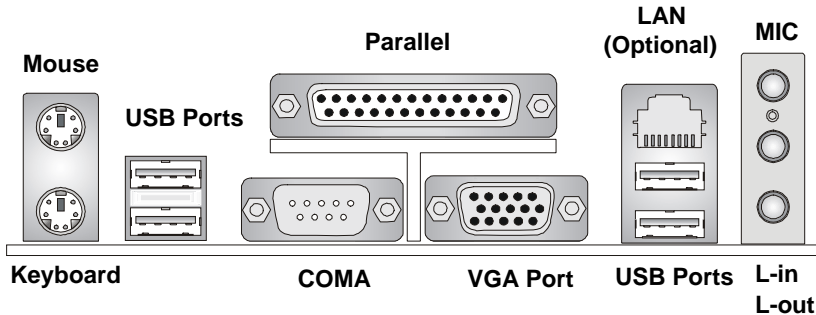

Mouse Connector

The mainboard provides a standard PS/2[®] mouse mini DIN connector for attaching a PS/2[®] mouse. You can plug a PS/2[®] mouse directly into this connector. The connector location and pin assignments are as follows:

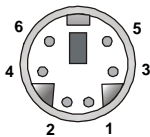

PS/2 Mouse (6-pin Female)

Pin Definition

PIN	SIGNAL	DESCRIPTION
1	Mouse DATA	Mouse DATA
2	NC	No connection
3	GND	Ground
4	VCC	+5V
5	Mouse Clock	Mouse clock
6	NC	No connection

Keyboard Connector

The mainboard provides a standard PS/2[®] keyboard mini DIN connector for attaching a PS/2[®] keyboard. You can plug a PS/2[®] keyboard directly into this connector.

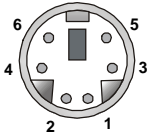

PS/2 Keyboard (6-pin Female)

Pin Definition

PIN	SIGNAL	DESCRIPTION
1	Keyboard DATA	Keyboard DATA
2	NC	No connection
3	GND	Ground
4	VCC	+5V
5	Keyboard Clock	Keyboard clock
6	NC	No connection

USB Connectors

The mainboard provides a UHCI (Universal Host Controller Interface) Universal Serial Bus root for attaching USB devices such as keyboard, mouse or other USB-compatible devices. You can plug the USB device directly into the connector.

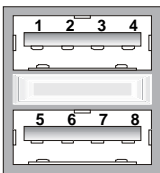

USB Ports

USB Port Description

PIN	SIGNAL	DESCRIPTION
1	VCC	+5V
2	-Data 0	Negative Data Channel 0
3	+Data0	Positive Data Channel 0
4	GND	Ground
5	VCC	+5V
6	-Data 1	Negative Data Channel 1
7	+Data 1	Positive Data Channel 1
8	GND	Ground

Serial Port Connectors: COM A & JCOM2 (Optional)

The mainboard offers two 9-pin male DIN connectors as serial port COM A & JCOM2 on the board. The ports are 16550A high speed communication ports that send/receive 16 bytes FIFOs. You can attach a serial mouse or other serial devices directly to the connectors.

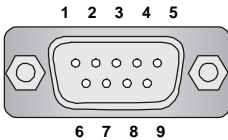

9-Pin Male DIN Connector

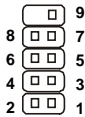

JCOM 2

Pin Definition

PIN	SIGNAL	DESCRIPTION
1	DCD	Data Carry Detect
2	SIN	Serial In or Receive Data
3	SOUT	Serial Out or Transmit Data
4	DTR	Data Terminal Ready
5	GND	Ground
6	DSR	Data Set Ready
7	RTS	Request To Send
8	CTS	Clear To Send
9	RI	Ring Indicate

VGA Connector

The mainboard provides a DB 15-pin female connector to connect a VGA monitor.

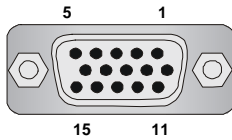

**VGA Connector
(DB 15-pin)**

Pin	Signal Description
1	RED
2	GREEN
3	BLUE
4	N/C
5	GND
6	GND
7	GND
8	GND
9	+5V
10	GND
11	N/C
12	SDA
13	Horizontal Sync
14	Vertical Sync
15	SCL

RJ-45 LAN Jack (Optional)

The mainboard provides one standard RJ-45 jack for connection to Local Area Network (LAN). You can connect a network cable to the LAN jack.

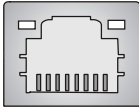

RJ-45 LAN Jack

Pin Definition

PIN	SIGNAL	DESCRIPTION
1	TDP	Transmit Differential Pair
2	TDN	Transmit Differential Pair
3	RDP	Receive Differential Pair
4	NC	Not Used
5	NC	Not Used
6	RDN	Receive Differential Pair
7	NC	Not Used
8	NC	Not Used

Audio Port Connectors

Line Out is a connector for Speakers or Headphones. **Line In** is used for external CD player, Tape player, or other audio devices. **Mic** is a connector for microphones.

1/8" Stereo Audio Connectors

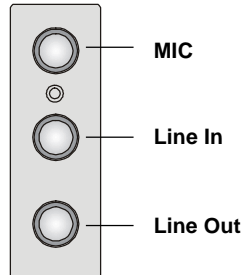

MSI Reminds You...

*For advanced audio application, Realtek ALC 650 is provided to offer support for **6-channel audio operation** and can turn rear audio connectors from 2-channel to 4-/6-channel audio. For more information on **6-channel audio operation**, please refer to Appendix. Using 4- or 6-Channel Audio Function.*

Parallel Port Connector: LPT1

The mainboard provides a 25-pin female centronic connector as LPT. A parallel port is a standard printer port that supports Enhanced Parallel Port (EPP) and Extended Capabilities Parallel Port (ECP) mode.

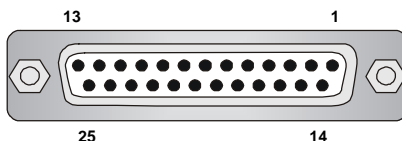

Pin Definition

PIN	SIGNAL	DESCRIPTION
1	STROBE	Strobe
2	DATA0	Data0
3	DATA1	Data1
4	DATA2	Data2
5	DATA3	Data3
6	DATA4	Data4
7	DATA5	Data5
8	DATA6	Data6
9	DATA7	Data7
10	ACK#	Acknowledge
11	BUSY	Busy
12	PE	Paper End
13	SELECT	Select
14	AUTO FEED#	Automatic Feed
15	ERR#	Error
16	INIT#	Initialize Printer
17	SLIN#	Select In
18	GND	Ground
19	GND	Ground
20	GND	Ground
21	GND	Ground
22	GND	Ground
23	GND	Ground
24	GND	Ground
25	GND	Ground

Connectors

The mainboard provides connectors to connect to FDD, IDE HDD, case, modem, LAN, USB Ports, IR module and CPU/System/Power Supply FAN.

Floppy Disk Drive Connector: FDD1

The mainboard provides a standard floppy disk drive connector that supports 360K, 720K, 1.2M, 1.44M and 2.88M floppy disk types.

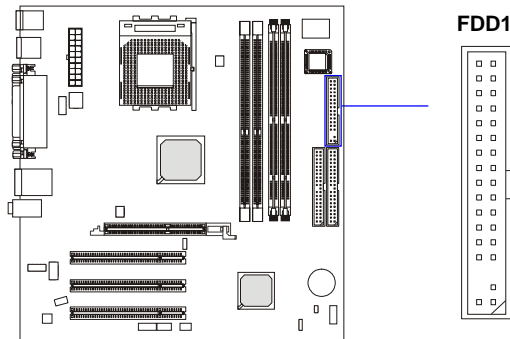

Chassis Intrusion Switch Connector: JCI1

This connector is connected to 2-pin connector chassis switch. If the Chassis is open, the switch will be short. The system will record this status. To clear the warning, you must enter the BIOS setting and clear the status.

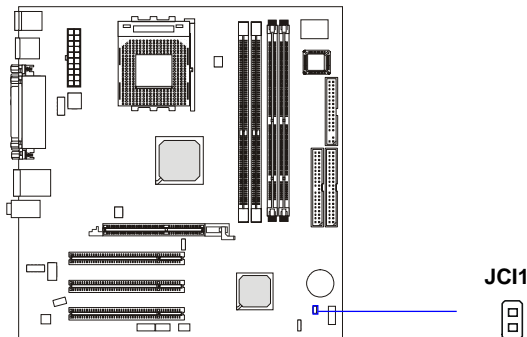

Hard Disk Connectors: IDE1 & IDE2

The mainboard has a 32-bit Enhanced PCI IDE and Ultra DMA 33/66/100/133 controller that provides PIO mode 0~4, Bus Master, and Ultra DMA 33/66/100/133 function. You can connect up to four hard disk drives, CD-ROM, 120MB Floppy (reserved for future BIOS) and other devices.

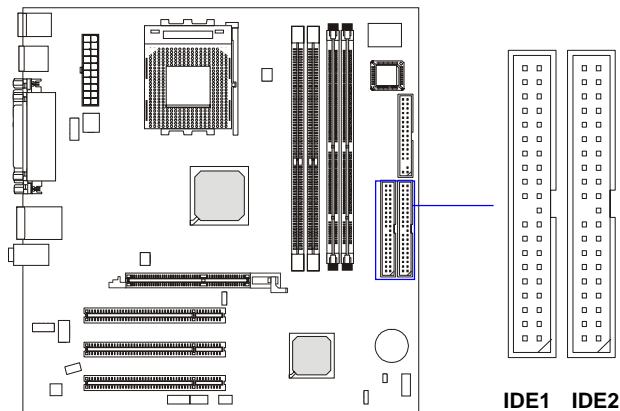

IDE1 (Primary IDE Connector)

The first hard drive should always be connected to IDE1. IDE1 can connect a Master and a Slave drive. You must configure second hard drive to Slave mode by setting the jumper accordingly.

IDE2 (Secondary IDE Connector)

IDE2 can also connect a Master and a Slave drive.



MSI Reminds You...

If you install two hard disks on cable, you must configure the second drive to Slave mode by setting its jumper. Refer to the hard disk documentation supplied by hard disk vendors for jumper setting instructions.

Fan Power Connectors: CPUFA1/SYSFA1

The CPUFA1 (processor fan) and SYSFA1 (system fan) support system cooling fan with +12V. They support three-pin head connector. When connecting the wire to the connectors, always take note that the red wire is the positive and should be connected to the +12V, the black wire is Ground and should be connected to GND. If the mainboard has a System Hardware Monitor chipset on-board, you must use a specially designed fan with speed sensor to take advantage of the CPU fan control.

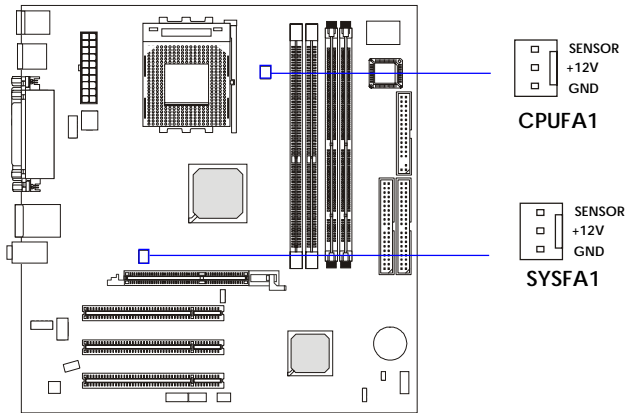

MSI Reminds You...

1. Always consult the vendors for proper CPU cooling fan.
2. CPUFA1 supports the fan control. You can install the PC Alert utility that will automatically control the CPU fan speed according to the actual CPU temperature.

Front Panel Connectors: JFP1 & JFP2

The mainboard provides two front panel connectors for electrical connection to the front panel switches and LEDs. JFP1 is compliant with Intel® Front Panel I/O Connectivity Design Guide.

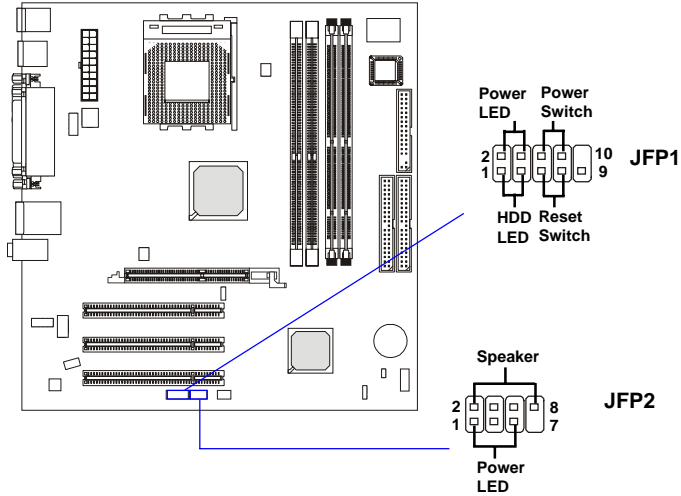

JFP1 Pin Definition

PIN	SIGNAL	DESCRIPTION
1	HD_LED_P	Hard disk LED pull-up
2	FP_PWR/SLP	MSG LED pull-up
3	HD_LED_N	Hard disk active LED
4	FP_PWR/SLP	MSG LED pull-up
5	RST_SW_N	Reset Switch low reference pull-down to GND
6	PWR_SW_P	Power Switch high reference pull-up
7	RST_SW_P	Reset Switch high reference pull-up
8	PWR_SW_N	Power Switch low reference pull-down to GND
9	RSVD_DNU	Reserved. Do not use.

JFP2 Pin Definition

PIN	SIGNAL	PIN	SIGNAL
1	GND	2	SPK-
3	SLED	4	BUZ+
5	PLED	6	BUZ-
7	NC	8	SPK+

Front Panel Audio Connector: JAUD1

The JAUD1 front panel audio connector allows you to connect to the front panel audio and is compliant with Intel® Front Panel I/O Connectivity Design Guide.

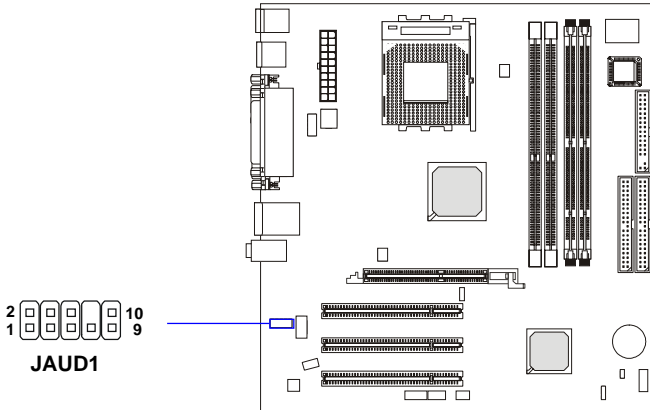

JAUD1 Pin Definition

PIN	SIGNAL	DESCRIPTION
1	AUD_MIC	Front panel microphone input signal
2	AUD_GND	Ground used by analog audio circuits
3	AUD_MIC_BIAS	Microphone power
4	AUD_VCC	Filtered +5V used by analog audio circuits
5	AUD_FPOUT_R	Right channel audio signal to front panel
6	AUD_RET_R	Right channel audio signal return from front panel
7	HP_ON	Reserved for future use to control headphone amplifier
8	KEY	No pin
9	AUD_FPOUT_L	Left channel audio signal to front panel
10	AUD_RET_L	Left channel audio signal return from front panel



MSI Reminds You...

If you don't want to connect to the front audio header, pins 5 & 6, 9 & 10 have to be jumpered in order to have signal output directed to the rear audio ports. Otherwise, the Line-Out connector on the back panel will not function.



Front USB Connectors: JUSB1

The mainboard provides one USB 2.0 pin header *JUSB1* that is compliant with Intel® I/O Connectivity Design Guide. USB 2.0 technology increases data transfer rate up to a maximum throughput of 480Mbps, which is 40 times faster than USB 1.1, and is ideal for connecting high-speed USB interface peripherals such as **USB HDD, digital cameras, MP3 players, printers, modems and the like.**

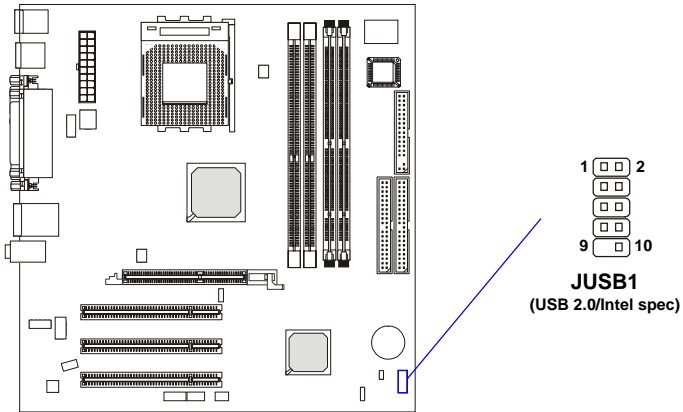

JUSB1 Pin Definition

PIN	SIGNAL	PIN	SIGNAL
1	VCC	2	VCC
3	USB0-	4	USB1-
5	USB0+	6	USB1+
7	GND	8	GND
9	Key	10	USBOC

SPDIF Connector: JSP1

The connector is used to connect SPDIF (Sony & Philips Digital Interconnect Format) interface for digital audio transmission.

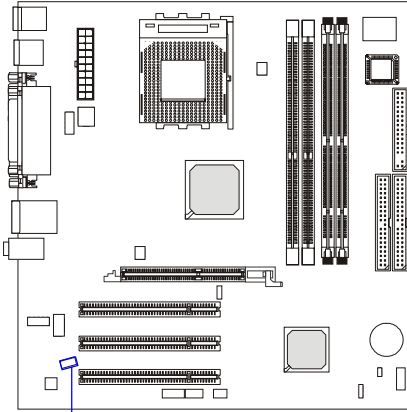

JSP1 Pin Definition

PIN	SIGNAL
1	VCC
2	SPDIF
3	NC

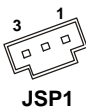

The JSP1 supports SPDIF output only and can be connected to an external SPDIF Bracket for digital audio transmission.

Connected to JSP1



SPDIF Bracket

CD-In Connector: JCD1

The connector is for CD-ROM audio connector.

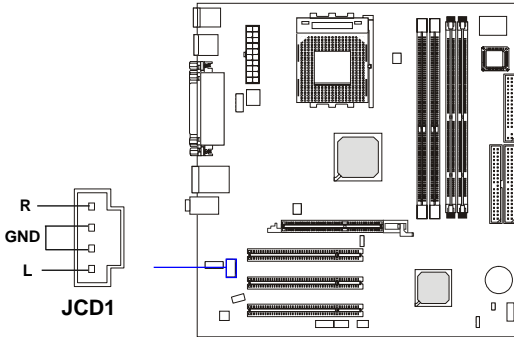

IrDA Infrared Module Header: JIR1

The connector allows you to connect to IrDA Infrared module. You must configure the setting through the BIOS setup to use the IR function. JIR1 is compliant with Intel® Front Panel I/O Connectivity Design Guide.

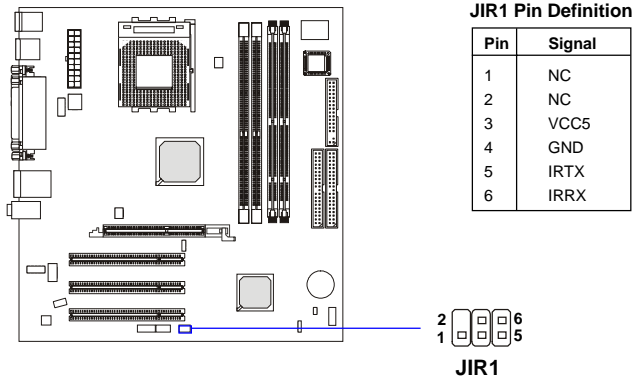

Jumpers

The motherboard provides the following jumpers for you to set the computer's function. This section will explain how to change your motherboard's function through the use of jumpers.

Clear CMOS Jumper: JBAT1

There is a CMOS RAM on board that has a power supply from external battery to keep the data of system configuration. With the CMOS RAM, the system can automatically boot OS every time it is turned on. If you want to clear the system configuration, use the JBAT1 (Clear CMOS Jumper) to clear data. Follow the instructions below to clear the data:

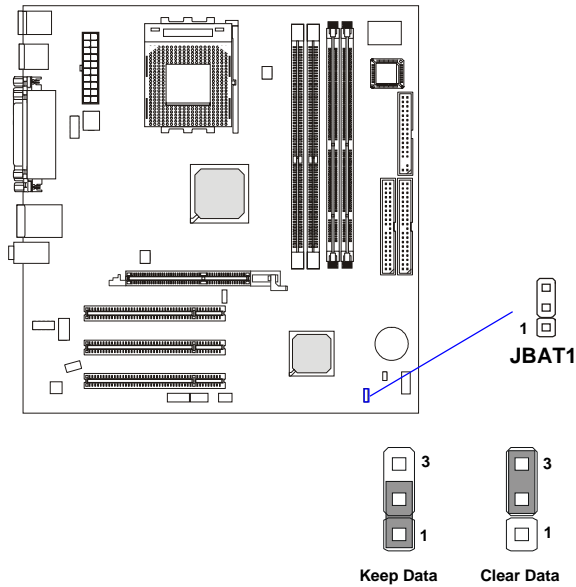

MSI Reminds You...

You can clear CMOS by shorting 2-3 pin while the system is off. Then return to 1-2 pin position. Avoid clearing the CMOS while the system is on; it will damage the mainboard.

FSB Mode Jumper: SW1

This jumper allows you to set the CPU FSB. When the system is down while doing the overclocking, you can use this jumper to set the CPU FSB that allows you to reset the system.

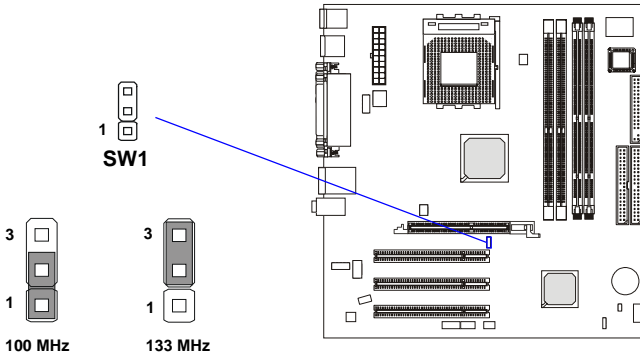

Slots

The motherboard provides one AGP slot and three 32-bit PCI bus slots.

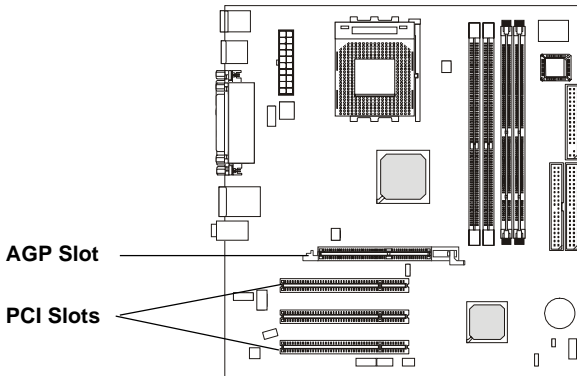

AGP (Accelerated Graphics Port) Slot (Optional)

The AGP slot allows you to insert the AGP graphics card. AGP is an interface specification designed for the throughput demands of 3D graphics. It introduces a 66MHz, 32-bit channel for the graphics controller to directly access main memory. The slot supports 4x/2x/1x AGP card.

PCI (Peripheral Component Interconnect) Slots

The PCI slots allow you to insert the expansion cards to meet your needs. When adding or removing expansion cards, make sure that you unplug the power supply first. Meanwhile, read the documentation for the expansion card to make any necessary hardware or software settings for the expansion card, such as jumpers, switches or BIOS configuration.

PCI Interrupt Request Routing

The IRQ, abbreviation of interrupt request line and pronounced I-R-Q, are hardware lines over which devices can send interrupt signals to the microprocessor. The PCI IRQ pins are typically connected to the PCI bus INT A# ~ INT D# pins as follows:

	Order 1	Order 2	Order 3	Order 4
PCI Slot 1	INT A#	INT B#	INT C#	INT D#
PCI Slot 2	INT B#	INT C#	INT D#	INT A#
PCI Slot 3	INT C#	INT D#	INT A#	INT B#

3

BIOS Setup

This chapter provides information on the BIOS Setup program and allows you to configure the system for optimum use. You may need to run the Setup program when:

- ◆ An error message appears on the screen during the system booting up, and requests you to run SETUP.
- ◆ You want to change the default settings for customized features.

Entering Setup

Power on the computer and the system will start POST (Power On Self Test) process. When the message below appears on the screen, press key to enter Setup.

Press DEL to enter SETUP

If the message disappears before you respond and you still wish to enter Setup, restart the system by turning it OFF and On or pressing the RESET button. You may also restart the system by simultaneously pressing <Ctrl>, <Alt>, and <Delete> keys.

Control Keys

<↑>	Move to the previous item
<↓>	Move to the next item
<<->	Move to the item in the left hand
<->	Move to the item in the right hand
<Enter>	Select the item
<Esc>	Jumps to the Exit menu or returns to the main menu from a submenu
<+ /PU>	Increase the numeric value or make changes
<- /PD>	Decrease the numeric value or make changes
<F1>	General help, only for Status Page Setup Menu and Option Page Setup Menu
<F5>	Restore the previous CMOS value from CMOS, only for Option Page Setup Menu
<F6>	Load High Performance Defaults
<F7>	Load BIOS Setup Defaults
<F10>	Save all the CMOS changes and exit

Getting Help

After entering the Setup menu, the first menu you will see is the Main Menu.

Main Menu

The main menu lists the setup functions you can make changes to. You can use the control keys ($\uparrow\downarrow$) to select the item. The on-line description of the highlighted setup function is displayed at the bottom of the screen.

Sub-Menu

If you find a right pointer symbol (as shown in the right view) appears to the left of certain fields that means a sub-menu containing additional options can be launched from this field. You can use control keys ($\uparrow\downarrow$) to highlight the field and press <Enter> to call up the sub-menu. Then you can use the control keys to enter values and move from field to field within a sub-menu. If you want to return to the main menu, just press <Esc >.



```
▶ IDE Primary Master
▶ IDE Primary Slave
▶ IDE Secondary Master
▶ IDE Secondary Slave
```

General Help <F1>

The BIOS setup program provides a General Help screen. You can call up this screen from any menu by simply pressing <F1>. The Help screen lists the appropriate keys to use and the possible selections for the highlighted item. Press <Esc> to exit the Help screen.



MSI Reminds You...

The items under each BIOS category described in this chapter are under continuous update for better system performance. Therefore, the description may be slightly different from the latest BIOS and should be held for reference only.

PC Health Status

This entry shows your PC health status.

Frequency/Voltage Control

Use this menu to specify your settings for frequency/voltage control.

Load Fail-Safe Defaults

Use this menu to load the BIOS values for the best system performance, but the system stability may be affected.

Load Optimized Defaults

Use this menu to load factory default settings into the BIOS for stable system performance operations.

Set Supervisor Password

Use this menu to set Supervisor Password.

Set User Password

Use this menu to set User Password.

Save & Exit Setup

Save changes to CMOS and exit setup.

Exit Without Saving

Abandon all changes and exit setup.

Standard CMOS Features

The items in Standard CMOS Features Menu are divided into 11 categories. Each category includes no, one or more than one setup items. Use the arrow keys to highlight the item and then use the <PgUp> or <PgDn> keys to select the value you want in each item.

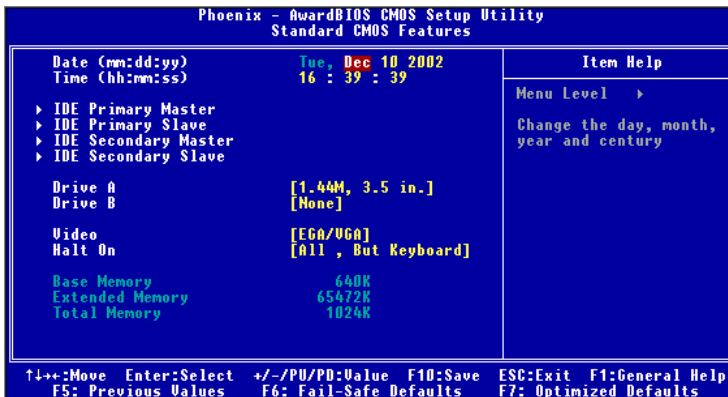

Date

The date format is <day> <month> <date> <year>.

day Day of the week, from Sun to Sat, determined by BIOS. Read-only.

month The month from Jan. through Dec.

date The date from 1 to 31 can be keyed by numeric function keys.

year The year can be adjusted by users.

Time

The time format is <hour> <minute> <second>.

IDE Primary/Secondary Master/Slave

Press PgUp/<+> or PgDn/<-> to select *Manual*, *None* or *Auto* type. Note that the specifications of your drive must match with the drive table. The hard disk will not work properly if you enter improper information for this category. If your hard disk drive type is not matched or listed, you can use *Manual* to define your own drive type manually.

If you select *Manual*, related information is asked to be entered to the following

items. Enter the information directly from the keyboard. This information should be provided in the documentation from your hard disk vendor or the system manufacturer.

Access Mode	The settings are CHS, LBA, Large, Auto.
Capacity	The formatted size of the storage device.
Cylinder	Number of cylinders.
Head	Number of heads.
Precomp	Write precompensation.
Landing Zone	Cylinder location of the landing zone.
Sector	Number of sectors.

Drive A/B

This item allows you to set the type of floppy drives installed. Available options: *None, 360K, 5.25 in., 1.2M, 5.25 in., 720K, 3.5 in., 1.44M, 3.5 in., 2.88M, 3.5 in.*

Floppy 3 Mode Support

Floppy 3 is the standard Japanese floppy drive mode. Supported by the BIOS, the selected diskette drive can read 720-KB, 1.2-MB, and 1.44-MB diskettes on a 3.5" diskette. Setting options: *Disabled, Drive A, Drive B, Both.*

Video

The setting controls the type of video adapter used for the primary monitor of the system. Available options: *EGA/VGA, CGA 40, CGA 80, MONO.*

Halt On

The setting determines whether the system will stop if an error is detected at boot. Available options are:

<i>All Errors</i>	The system stops when any error is detected.
<i>No Errors</i>	The system doesn't stop for any detected error.
<i>All, But Keyboard</i>	The system doesn't stop for a keyboard error.
<i>All, But Diskette</i>	The system doesn't stop for a disk error.
<i>All, But Disk/Key</i>	The system doesn't stop for either a disk or a keyboard error.

Base/Extended/Total Memory

The three items show the memory status of your system (read only).

Advanced BIOS Features

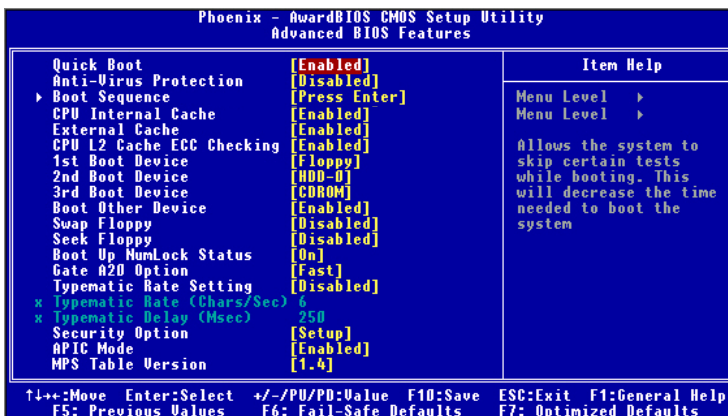

Quick Boot

Setting the item to *Enabled* allows the system to boot within 5 seconds since it will skip some check items. Settings: *Enabled, Disabled*.

Anti-Virus Protection

The item is to set the Virus Warning feature for IDE Hard Disk boot sector protection. If the function is enabled and any attempt to write data into this area is made, BIOS will display a warning message on screen and beep. Settings: *Disabled, Enabled*.

Boot Sequence

Press <Enter> and the following sub-menu appears:



1st/2nd/3rd Boot Device

The items allow you to set the sequence of boot devices where BIOS attempts to load the disk operating system. The settings are:

<i>Floppy</i>	The system will boot from floppy drive.
<i>LS120</i>	The system will boot from LS-120 drive.
<i>HDD-0</i>	The system will boot from the first HDD.
<i>SCSI</i>	The system will boot from the SCSI.
<i>CDROM</i>	The system will boot from the CD-ROM.

<i>HDD-1</i>	The system will boot from the second HDD.
<i>HDD-2</i>	The system will boot from the third HDD.
<i>HDD-3</i>	The system will boot from the fourth HDD.
<i>ZIP100</i>	The system will boot from ATAPI ZIP100 drive.
<i>USB-FDD</i>	The system will boot from the USB-interfaced floppy drive.
<i>USB-ZIP</i>	The system will boot from the USB-interfaced ZIP drive.
<i>USB-CDROM</i>	The system will boot from the USB-interfaced CD-ROM.
<i>USB-HDD</i>	The system will boot from the USB-interfaced HDD.
<i>LAN</i>	The system will boot from the Network drive.
<i>Disabled</i>	Disable this sequence.



MSI Reminds You...

Available settings for “1st/2nd/3rd Boot Device” vary depending on the bootable devices you have installed. For example, if you did not install a floppy drive, the setting “Floppy” does not show up.

Boot Other Device

Setting the option to *Enabled* allows the system to try to boot from other device if the system fails to boot from the 1st/2nd/3rd boot device.

CPU Internal/External Cache

The item allows you to turn on or off CPU’s internal (L1) and external (L2) cache. Settings: *Enabled, Disabled*.

CPU L2 Cache EEC Checking

The item allows you to enable or disable the EEC (Error-Correcting Code) feature for error detection and correction when data passes through L2 cache memory. Settings: *Enabled, Disabled*.

Swap Floppy Drive

Setting to *Enabled* will swap floppy drives A: and B:.

Seek Floppy

Setting to *Enabled* will make BIOS seek floppy drive A: before booting the system. Settings: *Disabled, Enabled*.

Boot Up NumLock Status

This setting is to set the Num Lock status when the system is powered on. Setting to *On* will turn on the Num Lock key when the system is powered on. Setting to *Off* will allow users to use the arrow keys on the numeric keypad. Setting options: *On, Off*.

Gate A20 Option

This item is to set the Gate A20 status. A20 refers to the first 64KB of extended memory. When the default value *Fast* is selected, the Gate A20 is controlled by Port92 or chipset specific method resulting in faster system performance. When *Normal* is selected, A20 is controlled by a keyboard controller or chipset hardware.

Typematic Rate Setting

This setting is used to enable or disable the typematic rate setting including Typematic Rate & Typematic Delay.

Typematic Rate (Chars/Sec)

After *Typematic Rate Setting* is enabled, this item allows you to set the rate (characters/second) at which the keys are accelerated. Settings: *6, 8, 10, 12, 15, 20, 24* and *30*.

Typematic Delay (Msec)

This item allows you to select the delay between when the key was first pressed and when the acceleration begins. Settings: *250, 500, 750* and *1000*. Typematic Delay (Msec)

This item allows you to select the delay between when the key was first pressed and when the acceleration begins. Settings: *250, 500, 750* and *1000*.

Security Option

This specifies the type of BIOS password protection that is implemented. Settings are described below:

Option	Description
<i>Setup</i>	The password prompt appears only when end users try to run Setup.
<i>System</i>	A password prompt appears every time when the computer is powered on or when end users try to run Setup.

APIC Mode

This field is used to enable or disable the APIC (Advanced Programmable Interrupt Controller). Due to compliance to PC2001 design guide, the system is able to run in APIC mode. Enabling APIC mode will expand available IRQs resources for the system. Settings: *Enabled, Disabled*.

MPS Table Version

This field allows you to select which MPS (Multi-Processor Specification) version to be used for the operating system. You need to select the MPS version supported by your operating system. To find out which version to use, consult the vendor of your operating system. Settings: *1.4, 1.1*.

Advanced Chipset Features



MSI Reminds You...

Change these settings only if you are familiar with the chipset.

DRAM Clock/Drive Control

Press <Enter> and the following sub-menu appears.



Current FSB/DRAM Frequency

These two items show the current FSB/DRAM frequency.

DRAM Clock

Selects whether DRAM clock. Setting options: *By SPD*, *100 MHz*, *133 MHz*.

DRAM Timing

Selects whether DRAM timing is controlled by the SPD (Serial Presence Detect) EEPROM on the DRAM module. Setting to *By SPD* enables DRAM timings to be determined by BIOS based on the configurations on the SPD. Selecting *Manual* allows users to configure the DRAM timings manually.

DRAM CAS Latency

This controls the timing delay (in clock cycles) before SDRAM starts a read command after receiving it. Settings: 2, 2.5. 2 (clocks) increases the system performance the most while 2.5 (clocks) provides the most stable performance.

Bank Interleave

This field enables or disables bank interleave for the installed SDRAM. Disable the function if 16MB SDRAM is installed. Settings: *Disabled*, *4 Bank*, *2 Bank*.

Precharge to Active (Trp)

This item allows you to control the number of DRAM clocks used for DRAM parameter Trp. Trp specifies the minimum clock cycles required for the precharge command to be transferred to the active command. Setting options: *2T*, *3T*.

Active to Precharge (Tras)

This item allows you to control the number of DRAM clocks used for DRAM parameters Tras. Tras specifies the minimum clock cycles required for the active command to be transferred to the precharge command. Setting options: *5T*, *6T*.

Active to CMD (Trcd)

This item allows you to control the number of DRAM clocks used for DRAM parameters Trcd. Trcd specifies the minimum clock cycles required for the active command to be transferred to the re-active command. Setting options: *2T*, *3T*.

DRAM Burst Length

This setting allows you to set the size of Burst-Length for DRAM. Bursting feature is a technique that DRAM itself predicts the address of the next memory location to be accessed after the first address is accessed. To use the feature, you need to define the burst length, which is the actual length of burst plus the starting address and allows internal address counter to properly generate the next memory location. The bigger the size, the faster the DRAM performance. Setting options: 4, 8.

DRAM Command Rate

This setting controls the DRAM command rate. Selecting *1T Command* allows DRAM signal controller to run at 1T (T=clock cycles) rate. Selecting *2T Command* makes DRAM signal controller run at 2T rate. *1T* is faster than *2T*. Setting options: *1T Command*, *2T Command*.

AGP & P2P Bridge Control

Press <Enter> and the following sub-menu appears.

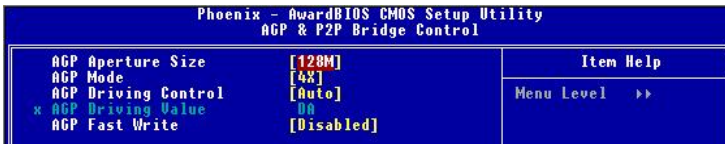

AGP Aperture Size

This setting controls just how much system RAM can be allocated to AGP for video purposes. The aperture is a portion of the PCI memory address range dedicated to graphics memory address space. Host cycles that hit the aperture range are forwarded to the AGP without any translation. The option allows the selection of an aperture size of *4MB*, *8MB*, *16MB*, *32MB*, *64MB*, *128MB*, *256MB*.

AGP Mode

This setting specifies an appropriate mode for the installed AGP card. Setting options: *1X*, *2X*, *4X*.

AGP Driving Control

This field is used to adjust the AGP driving force. Selecting *Manual* allows you to select an AGP driving force in **AGP Driving Value**. It is strongly recommended to select *Auto* to avoid causing any system error.

AGP Driving Value

This item specifies an AGP driving force.

AGP Fast Write

This option enables or disables the AGP Fast Write feature. The Fast Write technology allows the CPU to write directly to the graphics card without passing anything through the system memory and improves the AGP 4X speed. Select *Enabled* only when the installed AGP card supports this function. Settings: *Enabled, Disabled*.

Integrated Peripherals

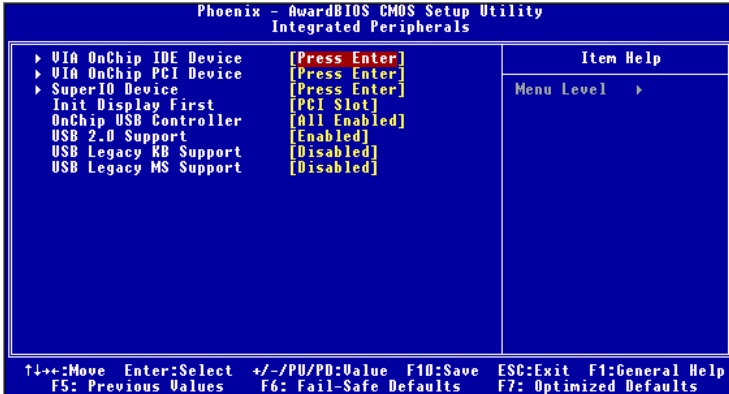

VIA OnChip IDE Device

Press <Enter> and the following sub-menu appears.

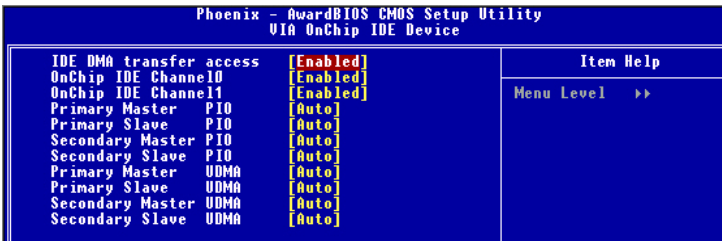

IDE DMA Transfer Access

Set this option to *Enabled* to specify that the IDE controller on the PCI local bus has bus mastering capability. Setting options: *Disabled, Enabled*.

OnChip IDE Channel 0/1

This setting enables or disables the internal primary and secondary IDE controllers. Setting options: *Disabled, Enabled*.

Primary/Secondary Master/Slave PIO

The four IDE PIO (Programmed Input/Output) fields let you set a PIO mode (0-4) for each of the four IDE devices that the onboard IDE interface supports. Modes 0 through 4 provide successively increased performance. In Auto mode, the system automatically determines the

best mode for each device. The settings are: *Auto, Mode 0, Mode 1, Mode 2, Mode 3, Mode 4.*

Primary/Secondary Master/Slave UDMA

Ultra DMA/33 implementation is possible only if your IDE hard drive supports it and the operating environment includes a DMA driver (Windows 95 OSR2 or a third-party IDE bus master driver). If your hard drive and your system software both support Ultra DMA/33, Ultra DMA/66 and Ultra DMA/100 select *Auto* to enable BIOS support. The settings are: *Auto, Disabled.*

VIA OnChip PCI Device

Press <Enter> and the following sub-menu appears.



VIA-3058 AC97 Audio

Auto allows the mainboard to detect whether an audio device is used. If the device is detected, the onboard AC'97 (Audio Codec'97) controller will be enabled; if not, it is disabled. Disable the controller if you want to use other controller cards to connect an audio device. Setting options: *Auto, Disabled.*

VIA-3043 OnChip LAN

The field determines whether the onboard LAN controller will be activated. Setting options: *Disabled, Enabled.*

Onboard LAN Boot ROM

The items enable or disable the initialization of the onboard LAN Boot ROMs during bootup. Selecting *Disabled* will speed up the boot process.

SuperIO Device

Press <Enter> and the following sub-menu appears.

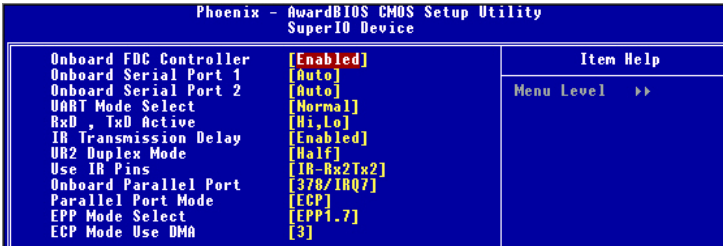

Onboard FDC Controller

Select *Enabled* if your system has a floppy disk controller (FDD) installed on the system board and you wish to use it. If you install add-on FDC or the system has no floppy drive, select *Disabled* in this field. The settings are: *Enabled* and *Disabled*.

Onboard Serial Port 1/Port 2

Select an address and corresponding interrupt for the first and second serial ports. The settings are: *3F8/IRQ4*, *2E8/IRQ3*, *3E8/IRQ4*, *2F8/IRQ3*, *Disabled*, *Auto*.

UART Mode Select

This setting allows you to specify the operation mode for serial port 2. Setting options: *IrDA*, *ASKIR*, *Normal*.

- Normal* RS-232C Serial Port
- IrDA* IrDA-compliant Serial Infrared Port
- ASKIR* Amplitude Shift Keyed Infrared Port

RxD, TxD Active

This setting controls the receiving and transmitting speed of the IR peripheral in use. Setting options: *Hi/Hi*, *Hi/Lo*, *Lo/Hi*, *Lo/Lo*.

IR Transmission Delay

This setting determines whether the IR transmission rate will be delayed while converting to receiving mode. Setting options: *Disabled*, *Enabled*.

UR2 Duplex Mode

This setting controls the operating mode of IR transmission/reception. Setting options: *Full, Half*. Under Full Duplex mode, synchronous, bi-directional transmission/reception is allowed. Under Half Duplex mode, only asynchronous, bi-directional transmission/reception is allowed.

Use IR Pins

Please consult your IR peripheral documentation to select the correct setting of the TxD and RxD signals. Setting options: *RxD2/TxD2, IR-Rx2Tx2*.

Onboard Parallel Port

There is a built-in parallel port on the on-board Super I/O chipset that provides Standard, ECP, and EPP features. It has the following options:

Disabled

3BC/IRQ7 Line Printer port 0

278/IRQ5 Line Printer port 2

378/IRQ7 Line Printer port 1

Parallel Port Mode

SPP : Standard Parallel Port

EPP : Enhanced Parallel Port

ECP : Extended Capability Port

ECP + EPP: Extended Capability Port + Enhanced Parallel Port

To operate the onboard parallel port as Standard Parallel Port only, choose "SPP." To operate the onboard parallel port in the EPP mode simultaneously, choose "EPP." By choosing "ECP", the onboard parallel port will operate in ECP mode only. Choosing "ECP + EPP" will allow the onboard parallel port to support both the ECP and EPP modes simultaneously.

EPP Mode Select

The onboard parallel port is EPP Spec. compliant, so after the user chooses the onboard parallel port with the EPP function, the following message will be displayed on the screen: "EPP Mode Select." At this time either *EPP 1.7 spec* or *EPP 1.9 spec* can be chosen.

ECP Mode Use DMA

The ECP mode has to use the DMA channel, so choose the onboard parallel port with the ECP feature. After selecting it, the following message will appear: “ECP Mode Use DMA.” At this time, the user can choose between DMA channel 3 or 1.

Init Display First

This item specifies which VGA card is your primary graphics adapter. Settings: *PCI Slot* and *AGP*.

OnChip USB Controller

This setting is used to enable/disable the on-chip USB controller. Setting options: *All Disabled*, *All Enabled*.

USB 2.0 Controller

This item is used to enable or disable the USB 2.0 supports. Settings: *Enabled*, *Disabled*.

USB Legacy KB/MS Support

Set to *Enabled* if you need to use a USB keyboard/mouse in the operating system that does not support or have any USB driver installed, such as DOS and SCO Unix.

Power Management Setup

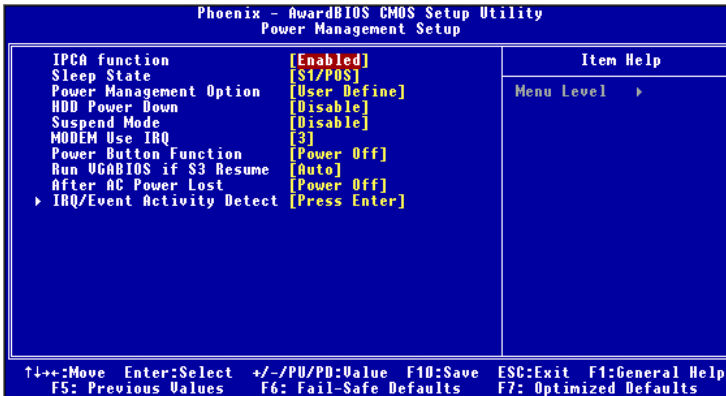

MSI Reminds You...

S3-related functions described in this section are available only when your BIOS supports S3 sleep mode.

IPCA Function

This item is to activate the IPCA (Advanced Configuration and Power Management Interface) Function. If your operating system is ACPI-aware, such as Windows 98SE/2000/ME, select *Enabled*. Settings: *Enabled* and *Disabled*.

Sleep State

This item specifies the power saving modes for ACPI function. Options are:

- S1 (POS)* The S1 sleep mode is a low power state. In this state, no system context (CPU or chipset) is lost and hardware maintains all system context.
- S3 (STR)* The S3 sleep mode is a power-down state in which power is supplied only to essential components such as main memory and wake-capable devices and all system context is saved to main memory. The information stored in memory will be used to restore the PC to the previous state when an “wake up” event occurs.

Power Management

This item is used to select the degree (or type) of power saving and is related to these modes: Suspend Mode and HDD Power Down. There are three options for power management:

- User Define* Allows end users to configure each mode separately.
- Min Saving* Minimum Power Management. Suspend Mode = 1 Hour, and HDD Power Down = 15 Min.
- Max Saving* Maximum Power Management. Suspend Mode = 1 Min, and HDD Power Down = 1 Min.

HDD Power Down

When enabled and after the set time of system inactivity, the hard disk drive will be powered down while all other devices remain active. The settings are: *Disable, 1~15 Min.*

Suspend Mode

If the system is not detected for the length of time specified in this field, all devices except CPU will be shut off. Setting options: *Disabled, 1 Min, 2 Min, 4 Min, 8 Min, 12 Min, 20 Min, 30 Min, 40 Min, 1 Hour.*

MODEM Use IRQ

Name the interrupt request (IRQ) line assigned to the modem (if any) on your system. Activity of the selected IRQ always awakens the system. Settings are *3, 4, 5, 7, 9, 10, 11* and *NA*.

Power Button Function

This feature sets the function of the power button. Settings are:

- Power Off* The power button functions as normal power off button.
- Suspend* When you press the power button, the computer enters the suspend/sleep mode, but if the button is pressed for more than four seconds, the computer is turned off.

Run VGABIOS if S3 Resume

This item allows the system to initialize the VGA BIOS from S3 (Suspend to RAM) sleep state. Setting options: *Auto, Yes, No.*

After AC Power Lost

This item specifies whether your system will reboot after a power failure or interrupt occurs. Available settings are:

- Power Off* Leaves the computer in the power off state.
- Power On* Leaves the computer in the power on state.
- Last State* Restores the system to the status before power failure or interrupt occurred.

IRQ/Event Activity Detect

Press <Enter> to enter the sub-menu and the following screen appears:

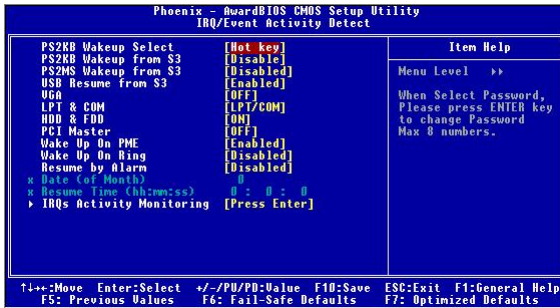

PS2KB Wakeup Select, PS2KB/MS Wakeup from S3, USB Resume from S3, VGA, LPT & COM, HDD & FDD, PCI Master, Wake Up On PME, Wake Up On Ring

These fields specify whether the system will be awakened from power saving modes when activity or input signal of the specified hardware peripheral or component is detected.



MSI Reminds You...

You need to install a modem card supporting power on function for “Wake Up On Ring” function.

Resume By Alarm

This is used to enable or disable the feature of booting up the system on a scheduled time/date from the S3 state. Settings: *Enabled, Disabled.*

Date (of Month)/Resume Time (hh:mm:ss)

If *Resume By Alarm* is set to *Enabled*, the system will automatically resume (boot up) on a specific date/hour/minute/second specified in these fields. Available settings for each item are:

- Alarm Date *01 ~ 31, Every Day*
- Alarm Hour *00 ~ 23*
- Alarm Minute *00 ~ 59*
- Alarm Second *00 ~ 59*



MSI Reminds You...

If you have changed this setting, you must let the system boot up until it enters the operating system, before this function will work.

IRQs Activity Monitoring

Press <Enter> and the following sub-menu appears.

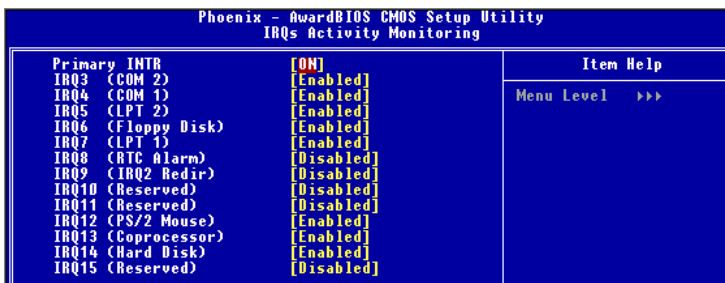

Primary INTR, IRQ3 (COM2), IRQ4 (COM1), IRQ5 (LPT2), IRQ6 (Floppy Disk), IRQ7 (LPT1), IRQ8 (RTC Alarm), IRQ9 (IRQ2 Redir), IRQ10 (Reserved), IRQ11 (Reserved), IRQ12 (PS/2 Mouse), IRQ13 (Coprocessor), IRQ14 (Hard Disk), IRQ15 (Reserved)

These settings disable/enable the monitoring of the specified IRQ's activity.

PNP/PCI Configurations

This section describes configuring the PCI bus system and PnP (Plug & Play) feature. PCI, or **P**eripheral **C**omponent **I**nterconnect, is a system which allows I/O devices to operate at speeds nearing the speed the CPU itself uses when communicating with its special components. This section covers some very technical items and it is strongly recommended that only experienced users should make any changes to the default settings.

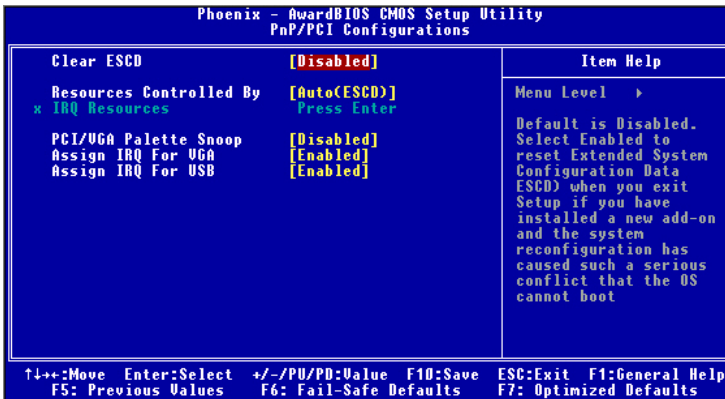

Clear ESCD

Normally, you leave this field Clear ESCD to reset Extended System Configuration Data (ESCD) when you exit Setup if you have installed a new add-on and the system reconfiguration has caused such a serious conflict that the operating system can not boot. The settings are: *Enabled* and *Disabled*.

Resource Controlled By

The Award Plug and Play BIOS has the capacity to automatically configure all of the boot and Plug and Play compatible devices. However, this capability means absolutely nothing unless you are using a Plug and Play operating system such as Windows® 98/2000/XP. If set to “Auto”, BIOS will automatically assign the IRQ to each device. If set to “manual”, you have to choose specific resources by going into each of the sub menu that follows this field (a sub menu is preceded by a “>”). The settings are: *Auto (ESCD)*, *Manual*.

IRQ Resources

The items are adjustable only when *Resources Controlled By* is set to *Manual*. Press <Enter> and you will enter the sub-menu of the items.

```

IRQ-3 assigned to [PCI Device]
IRQ-4 assigned to [PCI Device]
IRQ-5 assigned to [PCI Device]
IRQ-7 assigned to [PCI Device]
IRQ-9 assigned to [PCI Device]
IRQ-10 assigned to [PCI Device]
IRQ-11 assigned to [PCI Device]
IRQ-12 assigned to [PCI Device]
IRQ-14 assigned to [PCI Device]
IRQ-15 assigned to [PCI Device]
    
```

IRQ Resources list IRQ 3/4/5/7/9/10/11/12/14/15 for users to set each IRQ a type depending on the type of device using the IRQ. Settings are:

- PCI Device* For Plug & Play compatible devices designed for PCI bus architecture.
- Reserved* The IRQ will be reserved for further request.

PCI/VGA Palette Snoop

When set to *Enabled*, multiple VGA devices operating on different buses can handle data from the CPU on each set of palette registers on every video device. Bit 5 of the command register in the PCI device configuration space is the VGA Palette Snoop bit (0 is disabled). For example, if there are two VGA devices in the computer (one PCI and one ISA) and the:

VGA Palette Snoop Bit Setting	Action
<i>Disabled</i>	Data read or written by the CPU is only directed to the PCI VGA device's palette registers.
<i>Enabled</i>	Data read or written by the CPU is directed to both the PCI VGA device's palette registers and the ISA VGA device's palette registers, permitting the palette registers of both VGA devices to be identical.

The setting must be set to *Enabled* if any ISA bus adapter in the system requires VGA palette snooping.

Assign IRQ For VGA/USB

These settings specify the IRQ line for specified VGA/USB device. Setting options: *Disabled, Enabled*.

PC Health Status

This section shows the status of your CPU, fan, overall system status, etc. Monitor function is available only if there is hardware monitoring mechanism onboard.

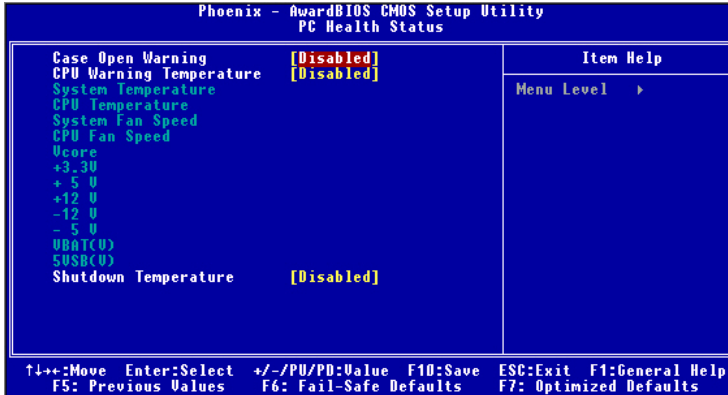

Case Open Warning

The field enables or disables the feature of recording the chassis intrusion status and issuing a warning message if the chassis is once opened. To clear the warning message, set the field to *Reset*. The setting of the field will automatically return to *Enabled* later. Setting options: *Enabled*, *Reset*, *Disabled*.

CPU Warning Temperature

If the CPU temperature reaches the upper limit preset in this setting, the warning mechanism will be activated. This helps you to prevent the CPU overheat problem.

System/CPU Temperature, System/CPU Fan Speed, Vcore, +3.3V, +5V, +12V, -12V, -5V, VBAT (V), 5VSB (V)

These items display the current status of all of the monitored hardware devices/components such as CPU voltages, temperatures and all fans' speeds.

Shutdown Temperature

This option is for setting the shutdown temperature level for the processor. When the processor reaches the temperature you set, the system will be shut down.

Frequency/Voltage Control

Use this menu to specify your settings for frequency/voltage control.

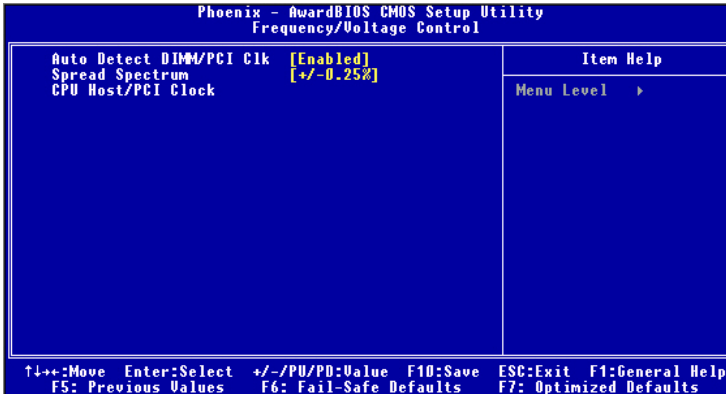

Auto Detect DIMM/PCI Clk

This item is used to auto detect the PCI/DIMM slots. When set to *Enabled*, the system will remove (turn off) clocks from empty PCI/DIMM slots to minimize the electromagnetic interference (EMI). Setting options: *Enabled*, *Disabled*.

Spread Spectrum

When the motherboard clock generator pulses, the extreme values (spikes) of the pulses creates EMI (Electromagnetic Interference). The Spread Spectrum function reduces the EMI generated by modulating the pulses so that the spikes of the pulses are reduced to flatter curves. If you do not have any EMI problem, leave the setting at *Disabled* for optimal system stability and performance. Remember to disable Spread Spectrum if you are overclocking because even a slight jitter can introduce a temporary boost in clockspeed which may just cause your overclocked processor to lock up. Settings: *Disabled*, *+/-0.25%*, *-0.37%*, *+/-0.50%*, *+/-0.75%*.

CPU Host/SDRAM/PCI Clock

This item specifies the clock frequency of CPU host bus (FSB), SDRAM and PCI bus. It provides a method for end users to overclock the processor. If the item shows *Default*, the setting will use the default value for the clock frequency of CPU host bus, SDRAM and PCI bus.

Load Fail-Safe/Optimized Defaults

The two options on the main menu allow users to restore all of the BIOS settings to the default Fail-Safe or Optimized values. The Optimized Defaults are the default values set by the mainboard manufacturer specifically for optimal performance of the mainboard. The Fail-Safe Defaults are the default values set by the BIOS vendor for stable system performance.

When you select Load Fail-Safe Defaults, a message as below appears:



Pressing *Y* loads the BIOS default values for the most stable, minimal system performance.

When you select Load Optimized Defaults, a message as below appears:



Pressing *Y* loads the default factory settings for optimal system performance.

Set Supervisor/User Password

When you select this function, a message as below will appear on the screen:



Enter Password:

Type the password, up to eight characters in length, and press <Enter>. The password typed now will replace any previously set password from CMOS memory. You will be prompted to confirm the password. Retype the password and press <Enter>. You may also press <Esc> to abort the selection and not enter a password.

To clear a set password, just press <Enter> when you are prompted to enter the password. A message will show up confirming the password will be disabled. Once the password is disabled, the system will boot and you can enter Setup without entering any password.

When a password has been set, you will be prompted to enter it every time you try to enter Setup. This prevents an unauthorized person from changing any part of your system configuration.

Additionally, when a password is enabled, you can also have BIOS to request a password each time the system is booted. This would prevent unauthorized use of your computer. The setting to determine when the password prompt is required is the Security Option of the Advanced BIOS Feature menu. If the Security Option is set to *System*, the password is required both at boot and at entry to Setup. If set to *Setup*, password prompt only occurs when you try to enter Setup.



MSI Reminds You...

About Supervisor Password & User Password:

Supervisor password: Can enter and change the settings of the setup menu.

User password: Can only enter but do not have the right to change the settings of the setup menu.

Appendix: Using 4- or 6-Channel Audio Function

The motherboard is equipped with Realtek ALC650 chip, which provides support for 6-channel audio output, including 2 Front, 2 Rear, 1 Center and 1 Subwoofer channel. ALC650 allows the board to attach 4 or 6 speakers for better surround sound effect. The section will tell you how to install and use 4-/6-channel audio function on the board.

TOPICS

<i>Using 4- or 6-Channel Audio Function</i>	A-2
<i>Testing the Connected Speakers</i>	A-6
<i>Playing KaraOK</i>	A-8

Using 4- or 6-Channel Audio Function

Installing the Audio Driver

1. Insert the companion CD into the CD-ROM drive. The CD will run automatically and the setup screen will appear.
2. Click **Avance ALC650 Sound Drivers** and follow the on-screen instructions to complete the installation.
3. After completion of the installation, please restart your computer.

Using 4- or 6-Channel Audio Function

In addition to a default 2-Channel analog audio output function, the audio connectors on the Back Panel also provide 4- or 6-Channel analog audio output function if a proper setting is made in the software utility.

Read the following steps to have the Multi-Channel Audio Function properly set in the software utility, and have your speakers correctly connected to the Back Panel:

Configuration in the Software Utility

1. Click the audio icon  from the window tray at the lower-right corner of the screen.
2. Select a desired surround sound effect from the “Environment” drop-down menu.
3. Click the **Speaker Configuration** tab.
4. Select **Synchronize the phonejack switch with the settings**.
5. Select a desired multi-channel operation from **No. of Speakers**.
 - a. Headphone
 - b. 2-Channel Mode for Stereo-Speaker Output
 - c. 4-Channel Mode for 4-Speaker Output
 - d. 6-Channels Mode for 5.1-Speaker Output
6. Click **OK** to close this window.

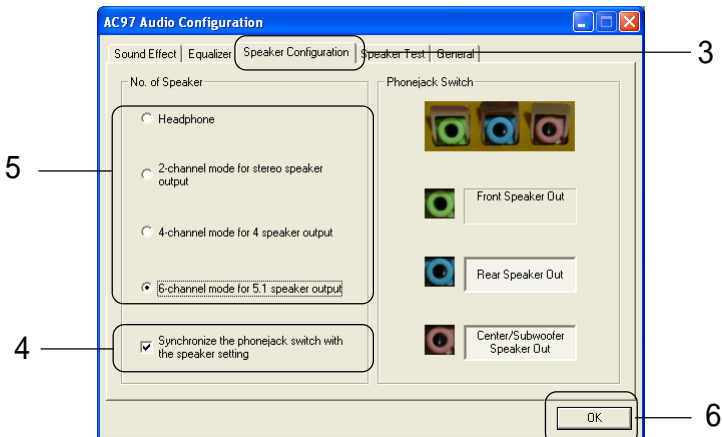
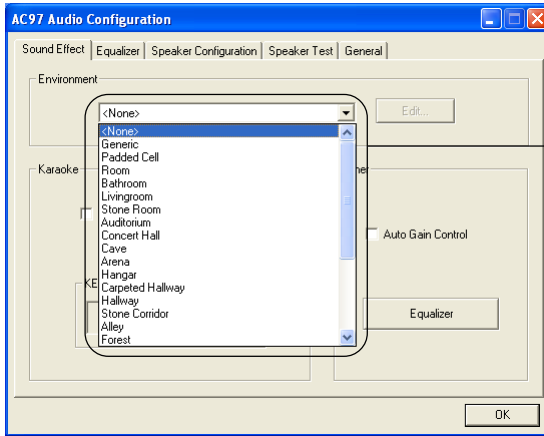

Connecting the Speakers

When you have set the Multi-Channel Audio Function mode properly in the software utility, connect your speakers to the correct phonejacks in accordance with the setting in software utility.

■ 2-Channel Mode for Stereo-Speaker Output

Refer to the following diagram and caption for the function of each phonejack on the back panel when 2-Channel Mode is selected.

- 1 Line Out (*Front channels*)
- 2 Line In
- 3 MIC

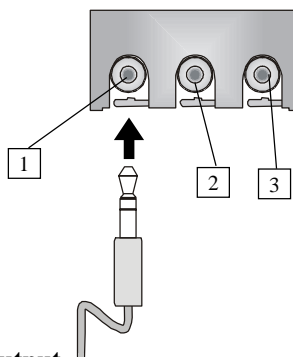

■ 4-Channel Mode for 4-Speaker Output

The audio jacks on the back panel always provide 2-Channel analog audio output function, however these audio jacks can be transformed to 4- or 6- channels analog audio jacks by selecting the corresponding multi-channel operation from **No. of Speakers**.

Refer to the following diagram and caption for the function of each jack on the back panel when 4-Channel Mode is selected.

- 1 Line Out (*Front channels*)
- 2* Line Out (*Rear channels*)
- 3 MIC

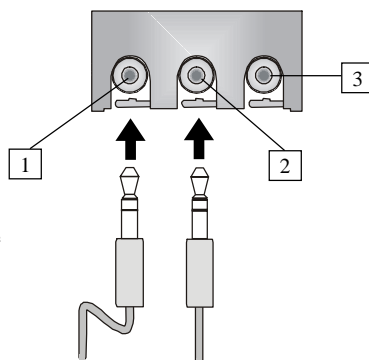

* Line In function is converted to Line Out function when 4-Channel Mode for 4-Speaker Output is selected.

■ **6-Channel Mode for 6-Speaker Output**

Refer to the following diagram and caption for the function of each jack on the back panel when 6-Channel Mode is selected.

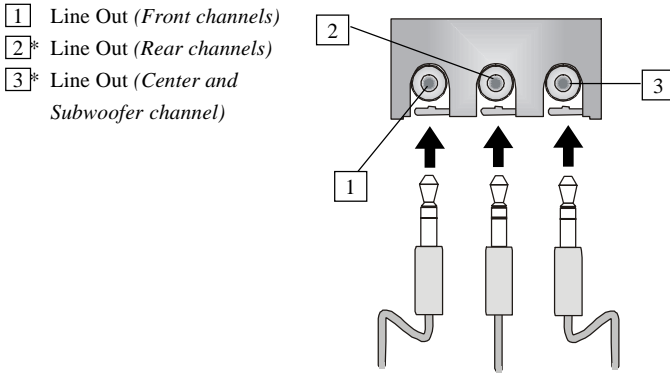

* Both Line In and MIC function are converted to Line Out function when 4-Channel Mode for 6-Speaker Output is selected.

Testing the Connected Speakers

To ensure that 4- or 6-channel audio operation works properly, you may need to test each connected speaker to make sure every speaker work properly. If any speaker fails to sound, then check whether the cable is inserted firmly to the connector or replace the bad speakers with good ones.

Testing Each Speaker:

1. Click the audio icon  from the window tray at the lower-right corner of the screen.
2. Click the **Speaker Test** tab.
3. The following window appears. Select the speaker which you want to test by clicking it.

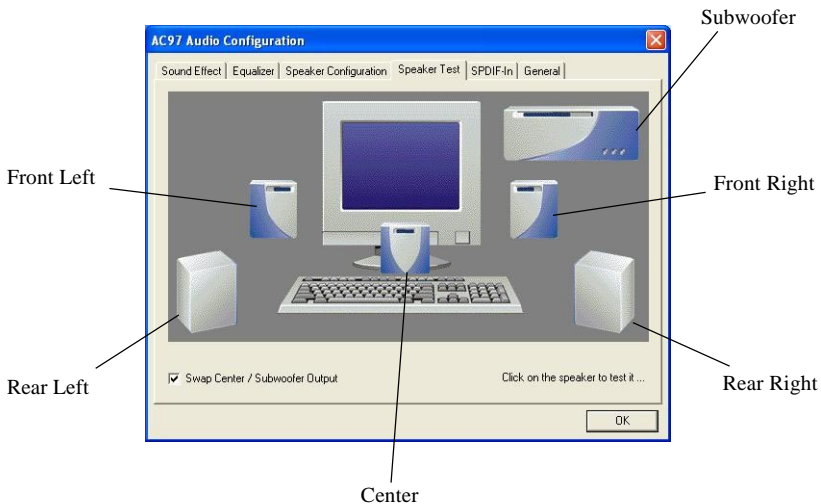

MSI Reminds You...

6 speakers appear on the "Speaker Test" window only when you select "6 channels mode" in the "No. of Speakers" column. If you select "4 channels mode", only 4 speakers appear on the window. Or, If you select "Headphone", only a headphone appears on the window.

4. While you are testing the speakers in 6-Channel mode, if the sound coming from the center speaker and subwoofer is swapped, you should select **Swap Center/Subwoofer Output** to readjust these two channels.



Select this function

Playing KaraOK

The KaraOK function will automatically remove human voice (lyrics) and leave melody for you to sing the song. **This function applies only to 2-channel audio operation**, so make sure “2-Channel Mode” is selected in the “No. of Speakers” column before playing KaraOK.

Playing KaraOK

1. Click the audio icon  from the window tray at the lower-right corner of the screen.
2. Select **Voice Cancellation** in the “KaraOK” column under the Sound Effect tab.
3. Click **OK** to close this window.

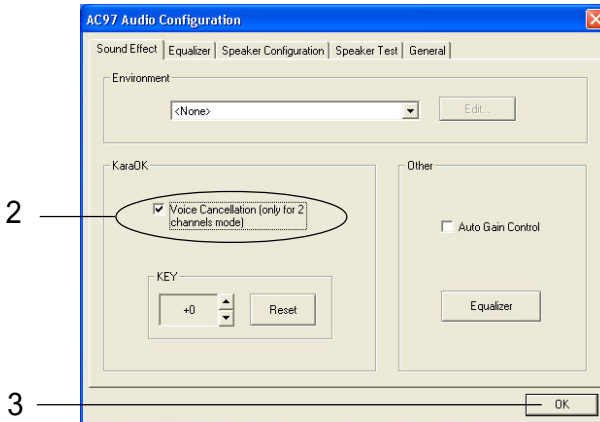

Troubleshooting

Q: Where will I find the model number of the mainboard?

A: There are two places where you can find the model number of the mainboard:

1. Somewhere between the PCI slots you shall find MS-xxxx or the marketing name like "K7T Turbo". You can also find the version number beside it.
2. At the back cover of the user's manual.

Q: What do you mean by PCB version 1?

A: PCB is printed circuit board. Saying PCB version 1 is the same as saying motherboard version 1.

Q: Why my motherboard BIOS sticker is "Phoenix BIOS" but when I boot up my system I saw that "Award BIOS" is being used?

A: Phoenix & Award already merged as one company. All MSI motherboard using Award BIOS comes with Phoenix logo sticker.

Q: How do I know what MSI D-LED or D-bracket light mean?

A: Please follow the special tech issue, http://www.msi.com.tw/support/techexpress/special_tech/smartled.htm

Q: I have got MSI Motherboard and when it says detecting drives, it detects them but says an error saying "Primary IDE Channel no 80 Conductor Cable Installed"

A: This is not a problem. It merely means that you're using an ATA-66 or ATA-100 HDD, but you're using the conductor 40 ATA-33 cable.

Q: I have high speed CPU cooling fan like Taisol CGK760092, Vantec CCK-6035D & GlobalWin WBK38. Can I install the fan directly to the motherboard?

A: We strongly recommend that you do NOT connect those described CPU fan directly to your motherboard, as it draws so much power, that it could damage it. Please use a 3-Pin to 4-Pin Cable that comes together with the fan.

Q: Can I use more than 512MB memory on Win9x or WinME?

A: No, you can't. You can only use more than 512MB memory on Win2000 or WinXP. This is a Microsoft OS issue. Please check <http://support.microsoft.com/support/kb/articles/Q108/0/79.ASP>

Q: I have tried to download the MSI Live Update utility from <http://www.msi.com.tw/support/liveupdate/livedriver.htm> but it keeps on failing?

A: This can be solved by one of the following suggestions: 1. Dont install zonealarm 2. Disable "WebTrap" of PC-cillion 2000 3. Disable any web based anti-virus Software.

Q: Can Live Update Series support WinXP?

A: Live Update Series version 215 can support WinXP. Download it from <http://www.msi.com.tw/support/liveupdate/livedriver.htm>

Q: After flashing the BIOS, my system for unknown reason dont want to boot, what should I do?

A: Please refer to the following suggestions: 1. Try the BIOS boot recovery feature as described in <http://www.msi.com.tw/support/bios/boot.htm> 2. Try to clear the CMOS If problem still persists, ask your reseller for new BIOS chip or contact one of MSI office near your place for new BIOS chip <http://www.msi.com.tw/contact/main.htm>

Q: Should I update my BIOS, once a new BIOS is released?

A: A new BIOS is usually released due to the following reasons:

1. New function is supported
2. New BIOS source code

3. Bugs are found
4. Customer-specific request

When we release a new BIOS, there's usually a release note attached which lists the reason for the release. Refer to this release note and decide for yourself if upgrading to the new BIOS will be worth it. A word of advice, though, do not upgrade to the new BIOS, unless you really have to.

Q: How do I update the BIOS?

A: Please refer to <http://www.msi.com.tw/support/bios/note.htm> for details.

Q: How do I identify the BIOS version?

A: Upon boot-up, the 1st line appearing after the memory count is the BIOS version. It is usually in the format:

1. For older model number:

AG76091096 where:

1st digit refers to BIOS maker as A = AMI(R) W = AWARD(R) P = PHOENIX (R).

2nd digit refers to the internal chipset code.

3rd digit refers to the processor class as 5 = 486, 7 = 586, 8 = 686.

4th digit is incremental.

091096 refers to the date this BIOS is released.

2. For newer model number:

W5139MS V1.091096 where:

1st digit refers to BIOS maker as A = AMI(R) W = AWARD(R) P = PHOENIX (R).

2nd - 5th digit refers to the model number.

6th - 7th digit refers to the customer as MS = all standard customers.

V1.0 refers to the BIOS version.

091096 refers to the date this BIOS is released.

Q: After flashing the bios and rebooting the system, the screen went blank.

A: *For AMI BIOS*

Rename the desired AMI BIOS file to AMIBOOT.ROM and save it on a floppy disk. e.g. Rename A569MS23.ROM to AMIBOOT.ROM

Insert this floppy disk in the floppy drive. Turn On the system and press and hold Ctrl-Home to force update. It will read the AMIBOOT.ROM file and recover the BIOS from the A drive.

When 4 beeps are heard you may remove the floppy disk and restart the computer.

For Award BIOS

Make a bootable floppy disk

Copy the Award flash utility & BIOS file to the said floppy disk

Create an autoexec.bat with "awdf1535 biosfilename" in the content e.g.
awdf1535 a619mj21.bin

Boot up system with the said floppy (it will take less than 2 minutes before screen comes out)

Re-flash the BIOS & reboot.

Glossary

ACPI (*Advanced Configuration & Power Interface*)

This power management specification enables the OS (operating system) to control the amount of power given to each device attached to the computer. Windows 98/98SE, Windows 2000 and Windows ME can fully support ACPI to allow users managing the system power flexibly.

AGP (*Accelerated Graphics Port*)

A new, high-speed graphics interface that based on PCI construction and designed especially for the throughput demands of 3-D graphics. AGP provides a direct channel (32-bit wide bus) between the display controller and main memory for high graphics quality and performance.

Bluetooth

Bluetooth refers to a worldwide standard for the wireless exchange of data between two devices. Bluetooth requires that a low-cost transceiver chip be included in each device. The transceiver transmits and receives in a previously unused frequency band of 2.45 GHz that is available globally (with some variation of bandwidth in different countries). In addition to data, up to three voice channels are available. Each device has a unique 48-bit address from the IEEE 802 standard. Connections can be point-to-point or multipoint. The maximum range is 10 meters. Data can be exchanged at a rate of 1 megabit per second (up to 2 Mbps in the second generation of the technology).

BIOS (*Basic Input/Output System*)

On PCs, an essential software that contains all the control code of input/output interface (such as keyboard, disk drives, etc.). It executes hardware test on booting the system, starts the OS, and provides an interface between the OS and the components. The BIOS is stored in a ROM chip.

Bus

A set of hardware lines within the computer system, through which the data is transferred among different components. In a PC, the term **bus** usually refers to a local bus that connects the internal components to the CPU and main memory.

Cache

A special memory subsystem that is used to speed up the data transfer. It stores the

contents of frequently accessed RAM locations and the addresses where these data items are stored.

Chipset

A collection of integrated chips designed to perform one or more related functions. For example, a modem chipset contains all the primary circuits for transmitting and receiving data; a PC chipset provides the electronic interfaces between all subsystems.

Clock Cycle

Clock cycle (or tick) is the smallest unit of time recognized by a device. For personal computers, clock cycles generally refer to the main system clock, which runs at 66 MHz. This means that there are 66 million clock cycles per second. Since modern CPUs run much faster (up to 533 MHz), the CPU can execute several instructions in a single clock tick.

CMOS (*Complementary Metal-Oxide Semiconductor*)

CMOS is a widely used type of semiconductor, which features high speed and low power consumption. PCs usually contain a small amount of battery-powered CMOS memory to retain the date, time, and system setup parameters.

DRAM (*Dynamic RAM*)

A most common type of computer memory. It usually uses one transistor and a capacitor to represent a bit. As the development of technology, the memory type and specification used in computer becomes variety, such as SDRAM, DDR SDRAM, and RDRAM. For further instruction, please see the table below:

Dynamic RAM (DRAM) Memory Technologies					
Type	First Used	Clock Rate	Bus* Width	Peak Bandwidth	Volts
FPM (60,70ns)	1990	25MHz	64 bits	200 MBps	5v
EDO (50,60,70ns)	1994	40MHz	64 bits	320 MBps	5v
SDRAM (66MHz)	1996	66MHz	64 bits	528 MBps	3.3v
SDRAM (100MHz)	1998	100MHz	64 bits	800 MBps	3.3v
SDRAM (133MHz)	1999	133MHz	64 bits	1.1 GBps	3.3v
RDRAM (Direct Rambus)	1999	400MHz	16 bits	1.6 GBps	2.5v
DDR SDRAM (100MHz)	2000	100MHz	64 bits	1.6 GBps	3.3v
DDR SDRAM (133MHz)	2000	133MHz	64 bits	2.1 GBps	3.3v

* Memory channel width (64 bits started with 75MHz Pentium)

Source: *Computer Desktop Encyclopedia*

ECC Memory (*Error Correcting Code Memory*)

A type of memory that contains special circuitry for testing the accuracy of data and correcting the errors on the fly.

EEPROM

Acronym for Electrically Erasable Programmable Read-Only Memory. An EEPROM is a special type of PROM that can be erased by exposing it to an electrical charge. Like other types of PROM, EEPROM retains its contents even when the power is turned off. Also like other types of ROM, EEPROM is not as fast as RAM. EEPROM is similar to flash memory (sometimes called flash EEPROM). The principal difference is that EEPROM requires data to be written or erased one byte at a time whereas flash memory allows data to be written or erased in blocks. This makes flash memory faster.

EIDE

Short for Enhanced IDE, a newer version of the IDE mass storage device interface standard developed by Western Digital Corporation. It supports data rates of between 4 and 16.6 MBps, about three to four times faster than the old IDE standard. In addition, it can support mass storage devices of up to 8.4 gigabytes, whereas the old standard was limited to 528 MB. Because of its lower cost, enhanced EIDE has replaced SCSI in many areas. There are four EIDE modes defined. The most common is Mode 4, which supports transfer rates of 16.6 MBps. There is also a new mode, called ATA-3 or Ultra ATA, that supports transfer rates of 33 MBps.

EISA (*Extended Industry Standard Architecture*)

EISA is a standard bus (computer interconnection) architecture that extends the ISA standard to a 32-bit interface. It was developed in part as an open alternative to the proprietary Micro Channel Architecture (MCA) that IBM introduced in its PS/2 computers. EISA data transfer can reach a peak of 33 megabytes per second.

ESCD (*Extended System Configuration Data*)

It is a format for storing information about Plug-and-Play (PnP) devices in the BIOS. Windows and the BIOS access the ESCD area each time you re-boot your computer

External Cache

Short for Level 2 cache, cache memory that is external to the microprocessor. In general, L2 cache memory, also called the secondary cache, resides on a separate chip from the microprocessor chip. Although, more and more microprocessors are including L2 caches into their architectures.

IDE (*Integrated Drive Electronics*)

A type of disk-drive interface widely used to connect hard disks, CD-ROMs and tape drives to a PC, in which the controller electronics is integrated into the drive itself, eliminating the need for a separate adapter card. The IDE interface is known as the ATA (AT Attachment) specification.

IEEE 1394

A new, high speed external bus standard, also known as *FireWire* or *iLink*, which supports data transfer rates of up to 400 Mbps for connecting up to 63 external devices.

Internal Cache

Short for Level 1 cache, a memory cache built into the microprocessor. The L1 cache is also called the primary cache.

IrDA (*Infrared Data Association*)

A group of device vendors, including computer, component and telecommunications, who have developed a standard for transmitting data via infrared light waves. This enables you to transfer data from one device to another without any cables.

IRQ (*Interrupt Request Line*)

IRQs are hardware lines over which devices can send interrupt signals to the microprocessor. When you add a new device to a PC, you sometimes need to set its IRQ number by setting a DIP switch. This specifies which interrupt line the device may use. IRQ conflicts used to be a common problem when adding expansion boards, but the Plug-and-Play specification has removed this headache in most cases.

ISA (*Industry Standard Architecture*)

ISA is a standard bus (computer interconnection) architecture that is associated with the IBM AT motherboard. It allows 16 bits at a time to flow between the motherboard circuitry and an expansion slot card and its associated device(s). Also see EISA and MCA.

LAN (*Local Area Network*)

A computer network that covers a relatively smaller area, such as in a building or an enterprise. It is made up of servers, workstations, shared resources, a network operating system and a communications link. These individual PCs and devices on a LAN are known as “nodes”, and are connected by cables to access data and devices anywhere on the LAN, so that many users can share expensive devices and data.

LBA (*Logical Block Addressing*)

Logical block addressing is a technique that allows a computer to address a hard disk larger than 528 megabytes. A logical block address is a 28-bit value that maps to a specific cylinder-head-sector address on the disk. 28 bits allows sufficient variation to specify addresses on a hard disk up to 8.4 gigabytes in data storage capacity. Logical block addressing is one of the defining features of Enhanced IDE (EIDE), a hard disk interface to the computer bus or data paths.

LED (*Light Emitting Diode*)

A semiconductor device that converts electrical energy into light. Since it lights up (usually red) when electricity is passed through it, it is usually used for the activity lights on computer's component, such as disk drivers.

LPT (*Line Printer Terminal*)

Logical device name for a line printer; a name reserved by the MS-DOS for up to three parallel printer ports: LPT1, LPT2, and LPT3. It is frequently used by the OS to identify a printer.

Overclocking

Overclocking is resetting your computer so that the microprocessor runs faster than the manufacturer-specified speed (for example, setting an Intel 166 MHz (megahertz) microprocessor to run at 200 Mhz).

PCI (*Peripheral Component Interconnect*)

A local bus standard developed by Intel that first appeared on PCs in late 1993. PCI provides "plug and play" capability and allows IRQs to be shared. The PCI controller can exchange data with the system's CPU either 32 bits or 64 bits at a time.

PnP (*Plug and Play*)

A set of specifications that allows a PC to configure itself automatically to work with peripherals. The user can "plug" in a peripheral device and "play" it without configuring the system manually. To implement this useful feature, both the BIOS that supports PnP and a PnP expansion card are required.

POST (*Power On Self Test*)

During booting up your system, the BIOS executes a series of diagnostic tests, include checking the RAM, the keyboard, the disk drives, etc., to see if they are properly connected and operating.

PS/2 Port

A type of port developed by IBM for connecting a mouse or keyboard to a PC. The PS/2 port supports a mini DIN plug containing just 6 pins. Most modern PCs equipped with PS/2 ports so that the special port can be used by another device, such as a modem.

RAID

RAID (Redundant Array of Independent Disks; originally Redundant Array of Inexpensive Disks) is a way of storing the same data in different places (thus, redundantly) on multiple hard disks. By placing data on multiple disks, I/O operations can overlap in a balanced way, improving performance. Since multiple disks increases the mean time between failure (MTBF), storing data redundantly also increases fault-tolerance.

SCSI

Acronym for Small Computer System Interface. Pronounced "scuzzy," SCSI is a parallel interface standard used by Apple Macintosh computers, PCs, and many UNIX systems for attaching peripheral devices to computers. SCSI interfaces provide for faster data transmission rates (up to 80 megabytes per second) than standard serial and parallel ports. In addition, you can attach many devices to a single SCSI port, so that SCSI is really an I/O bus rather than simply an interface.

USB (*Universal Serial Bus*)

A hardware interface for low-speed peripherals such as the keyboard, mouse, joystick, etc. USB provides a maximum bandwidth of 12 Mbit/sec (Mbps) for connecting up to 127 peripheral devices to PC. USB features hot swap capability and multiple data streams, allows external devices to be plugged in and unplugged without turning the system off.

Virus

A program or a piece of code that infects computer files by inserting in those files copies of itself. The virus code is buried within an existing program, and is activated when that program is executed. All the viruses are man-made, and often have damaging side effects.

WLAN

Acronym for wireless local-area network. Also referred to as LAWN. A type of local-area network that uses high-frequency radio waves rather than wires to communicate between nodes.