

CI6BM Series
Full-Size Slot 1 440BX
All-in-one CPU Card
Version 1.0D

Industrial CPU Card
PC-Based Computer Boards for Industrial Automation
User's Manual

Copyright Notice

This publication is protected by copyright and all rights are reserved. No part of it may be reproduced or transmitted by any means or in any form, without prior consent of the original manufacturer.

The information in this document has been carefully checked and is believed to be accurate. However, the original manufacturer assumes no responsibility for any inaccuracies that may appear in this manual. In no event will the original manufacturer be liable for direct, indirect, special, exemplary, incidental, incidental or consequential damages resulting from any defect or omission in this manual, even if advised of possibility of such damages. The material contained herein is for informational purposes only.

Acknowledgments

Award is a registered trademark of Award Software International, Inc.

Cyber 9520/9525 is a trademark of Trident Technologies Inc.

IBM, PS/2 are trademarks of International Business Machines Corporation.

Intel and Pentium are registered trademarks of Intel Corporation.

Microsoft Windows is a registered trademark of Microsoft Corporation.

VIA is a registered trademark of VIA Technologies Inc.

All other product names or trademarks are properties of their respective owners.

CI6BM Series Comparison Table

Model	CI6BM	CI6BMX	CI6BMV
Processor	Intel Pentium II	Intel Pentium II	Intel Pentium II
Processor Socket	Slot 1	Slot 1	Slot 1
Chipset	Intel 440BX	Intel 440BX	Intel 440BX
BIOS	Award	Award	Award
L2 cache	CPU Integrated	CPU Integrated	CPU Integrated
Max. SDRAM	256MB unbuffer 512MB buffer	256MB unbuffer 512MB buffer	256MB unbuffer 512MB buffer
Memory Sockets	2 x DIMM	2 x DIMM	2 x DIMM
VGA CRT/LCD	Trident 9520/9525	None	Trident 9520/9525
Watchdog Timer	16-level	16-level	16-level
PC/104 Connector	yes	yes	yes
Multi I/O Chip	Winbond 83977	Winbond 83977	Winbond 83977
Enhanced IDE	yes	yes	yes
2S/1P	yes	yes	yes
USB	yes	yes	yes
IrDA	yes	yes	yes
Ethernet (10/100Mbps)	yes	None	None
H/W Monitoring	Winbond W83781D	Winbond W83781D	Winbond W83781D
Board Size	338mm x 124mm	338mm x 124mm	338mm x 124mm

Contents

Chapter 1 Introduction	1
Checklist	2
Description	2
Features	3
Specifications	3
Intelligence	5
Board Dimensions	6
Chapter 2 Installations	7
CPU Installation	8
Memory Installation	9
Jumpers on the CI6BM	10
Jumper Locations on the CI6BM.....	11
DSW1 (1-8): CPU Frequency Selector	12
JP2: External Battery Connector	13
JP3: Clear CMOS Content	13
JP5: LCD Power Setting.....	13
JP9: DiskOnChip BIOS Expansion Address Select	13
JP10: RS232/422/485 (COM2) Selection	14
JP14, JP15, JP16, JP17: LCD Panel Type Select.....	15
JP18: CRT/LCD Display Selection	15
Connectors on the CI6BM	16
Connector Locations on the CI6BM.....	17
J1: Front Bezel Connector	18
J2, J3: EIDE Connectors	20
J4: Floppy Drive Connector	22
JP4: Wake On LAN Connector	22
J5: Parallel Port Connector.....	23
J6: LCD Panel Connector.....	24
Panel Signal Mapping.....	25
J7: COM1 Serial Port	26
J8: COM2 Serial Port	26
J9: External Keyboard Connector	27
J10: External ATX Power Connector.....	27
J11: PS/2 Keyboard Connector	27
J12: PS/2 Mouse Connector	28
J13: VGA CRT Connector	28
J14: CPU Fan Power Connector.....	28
J16: Chassis Fan Power Connector	28

J17, J18: USB Connectors	29
J19: RJ45 Connector	29
JP8: IrDA Connector.....	29
JP12: SB-Link Connector	29
CON1, CON2: PC-104 Connector	30
LED1, LED2: LAN Activity Indicators	31
Watchdog Timer Configuration.....	32
Chapter 3 BIOS Configuration.....	33
BIOS Introduction.....	36
BIOS Setup	36
Standard CMOS Setup.....	38
BIOS Features Setup	41
Chipset Features Setup.....	45
Power Management Setup.....	48
PNP/PCI Configuration.....	51
Load BIOS Defaults.....	53
Load Setup Defaults	53
Integrated Peripherals	54
Supervisor / User Password	56
IDE HDD Auto Detection.....	57
Save & Exit Setup	58
Exit Without Saving.....	58
Chapter 4 Intel PIIX Bus Master IDE Driver Installation	59
Chapter 5 VGA Driver Installation Guide	63
Chapter 6 LAN Driver Installation Guide.....	83
Chapter 7 System Monitor Utility	87
Chapter 8 LANdesk Client Manager	95
Appendix.....	102
A. I/O Port Address Map.....	103
B. Interrupt Request Lines (IRQ).....	104
C. Retention Mechanism.....	105

1

Introduction

This manual is designed to give you information on the CI6BM CPU card. It is divided into the following sections:

- Checklist 2
- Description 2
- Features 3
- Specifications 3
- Intelligence 5
- Board Dimensions 6

The topics covered in this chapter are as follows:

- ◆ Checklist
- ◆ Description
- ◆ Features
- ◆ Specifications
- ◆ Layout of Key Components and Dimensions

Checklist

Please check that your package is complete and contains the items below. If you discover damaged or missing items, please contact your dealer.

- The CI6BM Industrial CPU Card
- This User's Manual
- 1 IDE Ribbon Cable
- 1 Floppy Ribbon Connector
- 2 Serial Port Ribbon Cable and 1 Parallel Port Attached to a Mounting Bracket
- 1 Diskette Containing Intel PCI IDE Driver and Flash Memory Utility
- 2 Diskettes Containing Trident 9520/9525 VGA Driver (applies for CI6BM & CI6BMV)
- 1 Diskette Containing VIA VT86C100A LAN Driver (applies for CI6BM)
- 1 Diskette Containing System Monitor utility
- 1 Optional CD containing *Intel LANDesk Client Manger*

Description

The CI6BM is a Pentium II / Pentium !!! Industrial CPU card based on Intel's 440BX chipset and is fully designed for harsh industrial environment. It features a side-pocket type Slot 1 processor socket for processor insertion stability.

The CI6BM comes with Winbond's W83781D hardware monitoring device that monitors system and CPU temperature, system voltages, and CPU and chassis fan speeds to prevent system crashes by warning the user of adverse conditions. The power management feature provides power savings by slowing down the CPU clock, turning off the monitor screen and stopping the HDD spindle motor.

Features

- CPU Speed 233~600MHz, Intel Pentium II/ Pentium !!!
- Bus Speed 66MHz/100MHz
- Intel 440BX AGPset
- Two 168-pin DIMM sockets for up to 512MB memory
- Trident 9520/9525 AGP VGA chipset for LCD & CRT display
- 16 level programmable watchdog timer, from 0-30 seconds
- High speed bi-directional SPP/ECP/EPP parallel port
- PC/104 extension
- Hardware Monitoring
- Win95/98 shut-off, Modem ring-on
- 10/100M Base-T Ethernet interface, Novell NE2000 Compatible

Specifications

- **Processor Socket:** Slot 1 connector
- **Processor:**
 - Intel Pentium II 233/266/300MHz (66MHz / Klamath)
 - Intel Pentium II 333MHz (66MHz / Deschutes)
 - Intel Pentium II 300/350/400/450/500MHz (100MHz / Deschutes)
 - Intel Pentium !!! 450/500/550/600MHz
- **Chipset:** Intel 440BX AGPset with PCI EIDE and RTC built-in
- **Secondary Cache:** CPU integrated
- **Memory Sockets:**
 - Two 168-pin DIMM sockets
 - Memory module type: SDRAM (Synchronous DRAM)
 - Memory sizes: 16MB, 32MB, 64MB, 128MB, 256MB
- **BIOS:** Award BIOS, PnP support
 - FLASH EEPROM (256KB) for BIOS update
 - ISA Plug and Play (PnP) extension
 - Power management

- **DMI BIOS Support:**
Desktop Management Interface (DMI) allows users to download system hardware-level information such as CPU type, CPU speed, internal/external frequencies and memory size.
- **Multi I/O:** Winbond W83977TF
- **Parallel Port:** One high-speed parallel port, SPP/EPP/ECP mode
- **Serial Port:** Two 16550 UART compatible ports with COM1 as RS232 and COM2 jumper configurable as RS232/422/485
- **Enhanced IDE:** Two Bus Mastering EIDE mode, up to 4 devices, Two EIDE interfaces for up to four devices, support PIO Mode 3/4 or Ultra DMA/33 IDE Hard Disk and ATAPI CD-ROM.
- **FDD Interface:** Two floppy drives (360KB, 720KB, 1.2MB, 1.44MB, 2.88MB, LS-120)
- **AGP bus CRT/LCD:** Trident 9520/9525 chipset
 - Embedded 2MB SDRAM display memory
 - Simultaneous CRT & LCD display
 - LCD panel supports DSTN/TFT
 - 1600x1200x256 colors CRT resolution
 - Up to 1280x1024x64K colors resolution for color active matrix TFT panels (12, 18, and 24bit analog) or (12+12), (18+18) double pixel/CLK interface
- **USB Interface:** Two USB pin-header connectors, compliant with USB Specification Rev. 1.0
- **DiskOnChip:** The M-Systems flask disk supports system boot and storage capacity from 2MB to 72MB.
- **Watchdog Timer:** 16-level, programmable
 - I/O port 0443H to enable watchdog.
 - I/O port 0441H to disable watchdog.
 - Time-out timing select 0/2/4/6/8/10/12/14/16/18/20/22/24/26/28/30 seconds (+/-20%).
- **PCI Bus Ethernet Interface:** VIA VT86C100A chipset
 - PCI local bus Ethernet controller
 - Supports IEEE802.3u auto-negotiation for automatic speed selection
 - support 10/100Mbps operation in a single port PCI bus master architecture

- **Green Function:** Power management via BIOS, activated through mouse/keyboard movement
- **Keyboard and Mouse Connectors:** PS/2 type mini-DIN that supports PC/AT; supports a 5-pin external keyboard connector
- **IrDA Interface:** Pin-header connector for the optional IrDA external connector
- **PICMG Compliance:** Fully compliant to PICMG standards
- **Environmental and Mechanical:**
 - **Power Supply:** 15A @+5V(max), ±12V:100mA(max)
 - **Temperature:** 0°C to 60°C
 - **Humidity:** 5% to 95%
 - **Dimensions:** 338mm x 124mm

Intelligence

- **Temperature Monitoring and Alert:** A sensor for the CPU temperature on the CI6BM monitors the CPU temperature and alerts the user through the speaker or buzzer when temperature exceeds the safe heat level.
- **Windows 95 shut-off:** Allows shut-off control from within Windows 95 and through an ATX power supply.
- **Modem ring-on:** Allows system powering on through an external modem and through an ATX power supply.
- **Year 2000 Compliant BIOS:** The onboard Award BIOS is Year 2000 Compliant and will pass software applications that have the tendency to invoke INT1AH function 04H such as year2000.exe utility released by NSTL.

Board Dimensions

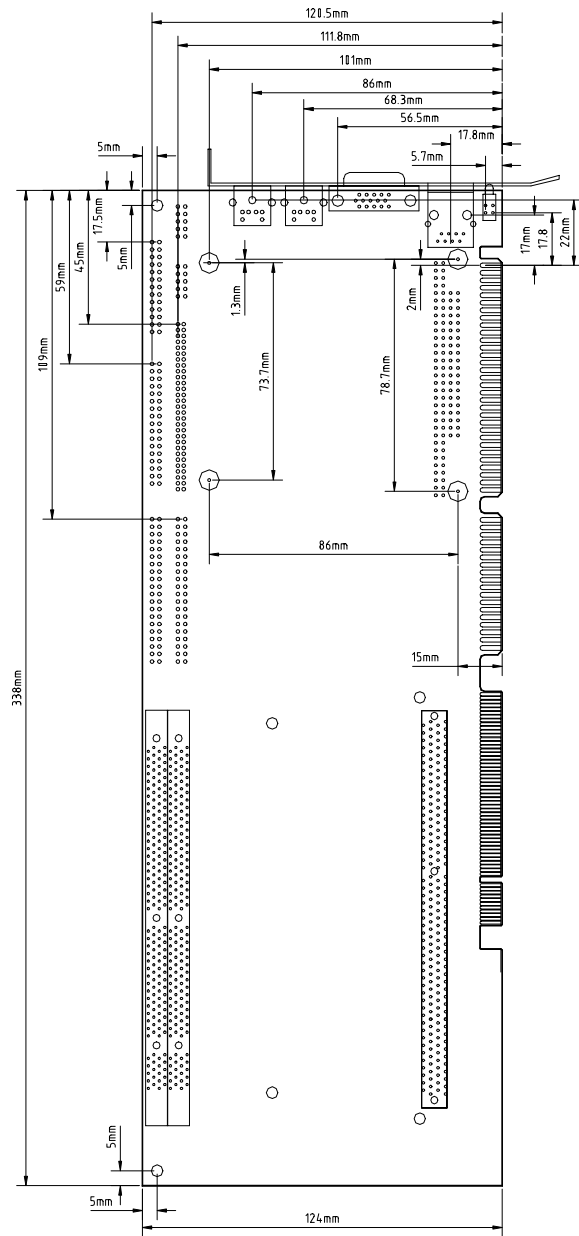

2

Installations

This chapter provides information on how to use the jumpers and connectors on the CI6BM in order to set up a workable system. The topics covered are:

CPU Installation	8
Memory Installation.....	9
Jumpers on the CI6BM.....	10
Connectors on the CI6BM.....	16
Watchdog Timer Configuration.....	32

CPU Installation

The CI6BM Industrial CPU Card supports a Slot 1 connector processor socket for Pentium II-processors.

To secure the installation of the Pentium II processor, the CI6BM is designed with the Slot 1 positioned like a side-pocket with the Pentium II processor to be inserted vertically in parallel with the CPU card and not side ways as with conventional CPU cards. This design allows easy installation and better access of the CPU, more secure installation for the processor and CPU card, and higher integration for more I/O space.

Before installing the Pentium II processor into the Slot connector, ensure that the CPU fan is installed first. After doing so, insert the processor into the Slot 1 connector. Locking mechanism on both side of the Slot 1 connector will 'click' and secure the Pentium II processor.

To uninstall the Pentium II processor, simply push the locking mechanism on both sides simultaneously and remove the Pentium II processor. No tools are needed.

CAUTION: When removing the Pentium II processor, be extra careful so as not to damage the DIMM sockets.

Memory Installation

The CI6BM Industrial CPU Card supports two 168-pin DIMM sockets. The SDRAM memory modules can come in sizes of 16MB, 32MB, 64MB, 128MB and 256MB.

The CI6BM Industrial CPU Card supports two 168-pin DIMM (Dual In-line Memory Module) sockets. Refer to the following table on how to configure the memory.

NOTE: Use SDRAM modules with PC100 specification when running 100MHz CPU bus speed. With 66MHz CPU bus speed, SDRAM modules with PC66 or PC100 specification can be used. You have to install the Pentium II processor before installing the memory modules.

168-pin DIMM (3.3V) SDRAM

Bank0	Bank1	Total Memory
16MB	-----	16MB
32MB	-----	32MB
64MB	-----	64MB
128MB	-----	128MB
256MB	-----	256MB
16MB	16MB	32MB
32MB	16MB	48MB
64MB	16MB	80MB
128MB	16MB	144MB
256MB	16MB	272MB
32MB	32MB	64MB
64MB	32MB	96MB
128MB	32MB	160MB
256MB	32MB	288MB
64MB	64MB	128MB
128MB	64MB	192MB
256MB	64MB	320MB
128MB	128MB	256MB
256MB	128MB	384MB
256MB	256MB	512MB

Jumpers on the CI6BM

The jumpers on the CI6BM allow you to configure your CPU card according to the needs of your applications. If you have doubts about the best jumper configuration for your needs, contact your dealer or sales representative. The following table lists the connectors on CI6BM and their respective functions.

Jumper Locations on the CI6BM.....	11
DSW1 (1-8): CPU Frequency Selector	12
JP2: External Battery Connector	13
JP3: Clear CMOS Content	13
JP5: LCD Power Setting.....	13
JP9: DiskOnChip BIOS Expansion Address Select	13
JP10: RS232/422/485 (COM2) Selection	14
JP14, JP15, JP16, JP17: LCD Panel Type Select.....	15
JP18: CRT/LCD Display Selection	15





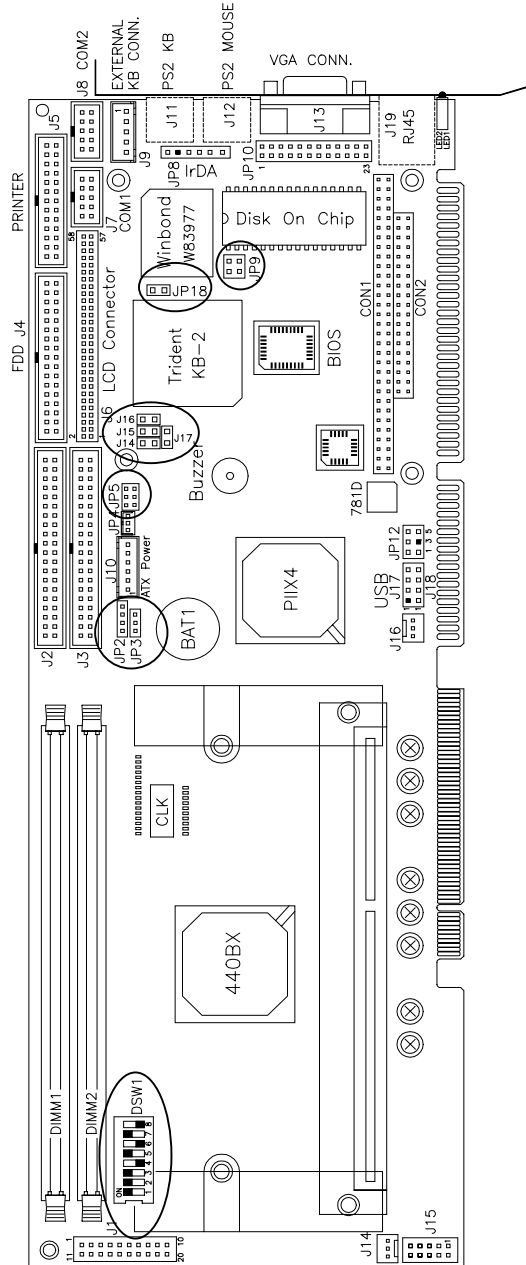



NOTE: Jumpers J15, J20, and JP13 are for manufacturer testing use only.

Jumper Locations on the CI6BM

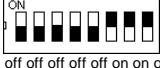

DSW1 (1-8): CPU Frequency Selector

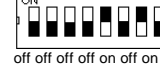
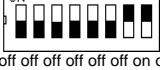
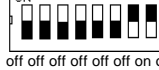
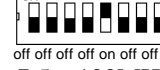
The table below shows the correct setting to match the CPU frequency.

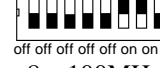
DSW1(1-8)	DSW1(1-8)	DSW1(1-8)
 <p>off off off off on off off on 3.5 x 66MHz 233MHz</p>	 <p>off off off on off off on 3.5 x 100MHz 350MHz</p>	 <p>off off off on on on off 6 x 100MHz 600MHz</p>
 <p>off off off off on on on on 4 x 66MHz 266MHz</p>	 <p>off off off off on on on on 4 x 100MHz 400MHz</p>	 <p>off off off on on off off 6.5 x 100MHz 650MHz</p>
 <p>off off off on on off on on 4.5 x 66MHz 300MHz</p>	 <p>off off off off on on on on 4.5 x 100MHz 450MHz</p>	 <p>off off off on on on off 7 x 100MHz 700MHz</p>
 <p>off off off off on on on on 5 x 66MHz 333MHz</p>	 <p>off off off off on on on on 5 x 100MHz 500MHz</p>	 <p>off off off on on off off 7.5 x 100MHz 750MHz</p>
 <p>off off off on on on on on 3 x 100MHz 300MHz</p>	 <p>off off off off on on on on 5.5 x 100MHz 550MHz</p>	 <p>off off off off on on off 8 x 100MHz 800MHz</p>

NOTES: The switch settings for 650MHz CPUs and above are for reference only. As of the time of the printing of this manual, these CPUs were not tested yet.

Switches DSW1(2), DSW1(3) and DSW1(4) should be left to its default setting of OFF. Do not reset these switches. For 'engineering sample' CPU, DSW1(1) can be used to set the CPU bus speed. For 66MHz, set this switch to ON; for 100MHz, this switch is OFF. For 'mass produced' CPU, DSW1(3) should be set to OFF for auto-detection of the CPU bus speed.

JP2: External Battery Connector

This 4-pin connector allows the user to connect an external battery to maintain the information stored in the CMOS RAM in case the built-in battery malfunctions.

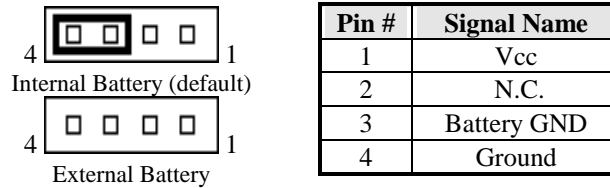

JP3: Clear CMOS Content

JP3	Setting	Function
	Pin 2-3 Short/Closed	Clear CMOS Content
	Pin 1-2 Short/Closed	Normal Operation

JP5: LCD Power Setting

The CI6BM XGA interface supports 5V and 3.3V LCD displays. Use JP5 to change between 5V (*default*) and 3.3V panel video signal level.

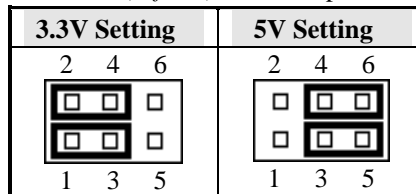

JP9: DiskOnChip BIOS Expansion Address Select

JP9	Address	JP9	Address
	D0000-D7FFF		D8000-DFFFF(default)

JP10: RS232/422/485 (COM2) Selection

COM1 is fixed for RS-232 use only.

COM2 is selectable for RS232, RS-422 and RS-485.

The following table describes the jumper settings of this connector.

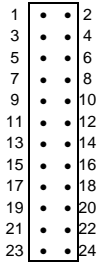
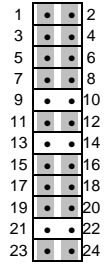
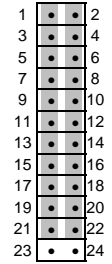

COM2 Function	RS-232	RS-422	RS-485
Jumper Setting (pin closed)	all jumpers open	1-2 3-4 5-6 7-8 11-12 15-16 17-18 19-20 23-24	1-2 3-4 5-6 7-8 9-10 11-12 13-14 15-16 17-18 19-20 21-22
Jumper Illustration	 <p>JP10</p>	 <p>JP10</p>	 <p>JP10</p>

JP14, JP15, JP16, JP17: LCD Panel Type Select

JP14	JP15	JP16	JP17	TFT LCD Panel
short	short	short	short	640 x 480 -18
short	open	short	short	800 x 600 -18
short	short	short	open	1024 x 768 -18
short	open	short	open	1024 x 768 -18+18
short	short	open	short	1280 x 1024 -18+18
JP14	JP15	JP16	JP17	DSTN LCD Panel
open	short	short	short	640 x 480 -16
open	open	short	short	800 x 600 -16
open	short	short	open	1024 x 768 -16
open	open	short	open	1024 x 768 -24
open	short	open	short	1280 x 1024 -24

JP18: CRT/LCD Display Selection

The JP18 jumper is used to toggle between CRT and LCD display.

JP18	Status	JP18	Status
	CRT Display		LCD Display
short		open	

Connectors on the CI6BM

The connectors on the CI6BM allows you to connect external devices such as keyboard, floppy disk drives, hard disk drives, printers, etc. The following table lists the connectors on CI6BM and their respective functions.

J1: Front Bezel Connector	18
J2, J3: EIDE Connectors	20
J4: Floppy Drive Connector	22
JP4: Wake On LAN Connector	23
J5: Parallel Port Connector.....	23
J6: LCD Panel Connector.....	24
Panel Signal Mapping.....	25
J7: COM1 Serial Port.....	26
J8: COM2 Serial Port.....	26
J9: External Keyboard Connector	27
J10: External ATX Power Connector.....	27
J11: PS/2 Keyboard Connector	27
J12: PS/2 Mouse Connector	28
J13: VGA CRT Connector	28
J14: CPU Fan Power Connector.....	28
J16: Chassis Fan Power Connector	28
J17, J18: USB Connectors.....	29
J19: RJ45 Connector	29
JP8: IrDA Connector	29
JP12: SB-Link Connector.....	29
CON1, CON2: PC-104 Connector	30
LED1, LED2: LAN Activity Indicators	31

Connector Locations on the CI6BM

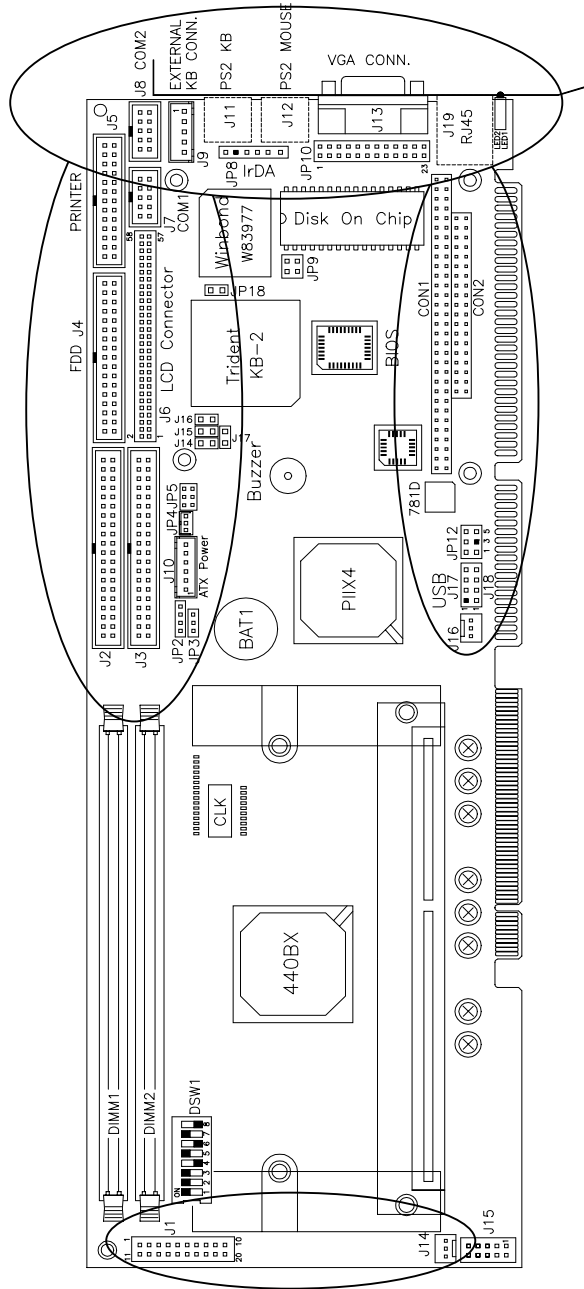

J1: Front Bezel Connector

The front bezel of the case has a control panel which provides light indication of the computer activities and switches to change the computer status. J1 is a 20-pin header that provides interfaces for the following functions.

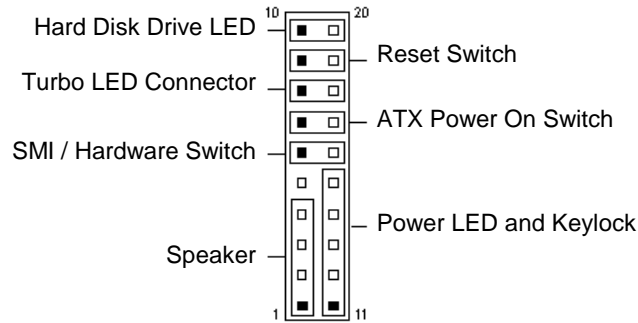

Speaker: Pins 1 - 4

This connector provides an interface to a speaker for audio tone generation. An 8-ohm speaker is recommended.



Pin #	Signal Name
1	Speaker out
2	No connect
3	Ground
4	+5V

Power LED and Keylock: Pins 11 - 15

The power LED indicates the status of the main power switch. The keylock switch, when closed, will disable the keyboard function.

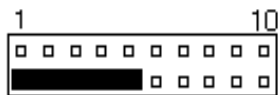

Pin #	Signal Name
11	Power LED
12	No connect
13	Ground
14	Keylock
15	Ground

SMI/Hardware Switch: Pins 6 and 16

This connector supports the "Green Switch" on the control panel, which, when pressed, will force the system into the power-saving mode immediately.

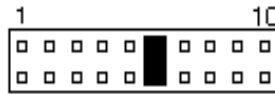

Pin #	Signal Name
6	Sleep
16	Ground

ATX Power ON Switch: Pins 7 and 17

This 2-pin connector is an "ATX Power Supply On/Off Switch" on the system that connects to the power switch on the case. When pressed, the power switch will force the system to power on. When pressed again, it will force the system to power off.

**Turbo LED Connector: Pins 8 and 18**

There is no turbo/deturbo function on the CPU card. The Turbo LED on the control panel will always be On when attached to this connector.

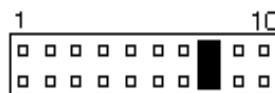

Pin #	Signal Name
8	5V
18	Ground

Reset Switch: Pins 9 and 19

The reset switch allows the user to reset the system without turning the main power switch off and then on again. Orientation is not required when making a connection to this header.

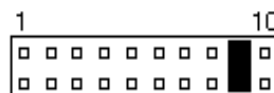

Hard Disk Drive LED Connector: Pins 10 and 20

This connector connects to the hard drive activity LED on control panel. This LED will flash when the HDD is being accessed.

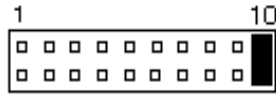

Pin #	Signal Name
10	Ground
20	5V

J2, J3: EIDE Connectors

J2: Primary IDE Connector

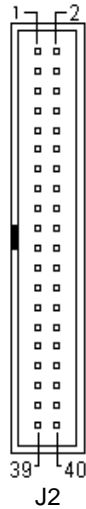

Signal Name	Pin #	Pin #	Signal Name
Reset IDE	1	2	Ground
Host data 7	3	4	Host data 8
Host data 6	5	6	Host data 9
Host data 5	7	8	Host data 10
Host data 4	9	10	Host data 11
Host data 3	11	12	Host data 12
Host data 2	13	14	Host data 13
Host data 1	15	16	Host data 14
Host data 0	17	18	Host data 15
Ground	19	20	Key
DRQ0	21	22	Ground
Host IOW	23	24	Ground
Host IOR	25	26	Ground
IOCHRDY	27	28	Host ALE
DACK0	29	30	Ground
IRQ14	31	32	No connect
Address 1	33	34	No connect
Address 0	35	36	Address 2
Chip select 0	37	38	Chip select 1
Activity	39	40	Ground

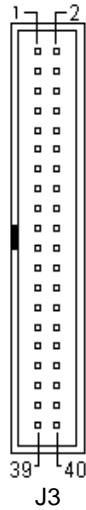
J3: Secondary IDE Connector

Signal Name	Pin #	Pin #	Signal Name
Reset IDE	1	2	Ground
Host data 7	3	4	Host data 8
Host data 6	5	6	Host data 9
Host data 5	7	8	Host data 10
Host data 4	9	10	Host data 11
Host data 3	11	12	Host data 12
Host data 2	13	14	Host data 13
Host data 1	15	16	Host data 14
Host data 0	17	18	Host data 15
Ground	19	20	Key
DRQ1	21	22	Ground
Host IOW	23	24	Ground
Host IOR	25	26	Ground
IOCHRDY	27	28	Host ALE
DACK1	29	30	Ground
IRQ15	31	32	No connect
Address 1	33	34	No connect
Address 0	35	36	Address 2
Chip select 0	37	38	Chip select 1
Activity	39	40	Ground

J4: Floppy Drive Connector

J4 is a 34-pin header and will support up to 2.88MB floppy drives.

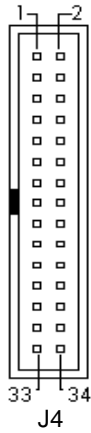

Signal Name	Pin #	Pin #	Signal Name
Ground	1	2	RM/LC
Ground	3	4	No connect
Ground	5	6	No connect
Ground	7	8	Index
Ground	9	10	Motor enable 0
Ground	11	12	Drive select 1
Ground	13	14	Drive select 0
Ground	15	16	Motor enable 1
Ground	17	18	Direction
Ground	19	20	Step
Ground	21	22	Write data
Ground	23	24	Write gate
Ground	25	26	Track 00
Ground	27	28	Write protect
Ground	29	30	Read data
Ground	31	32	Side 1 select
Ground	33	34	Diskette change

JP4: Wake On LAN Connector

JP4 is a 3-pin header for the Wake On LAN function on the motherboard. The following table shows the pin out assignments of this connector. Wake On LAN will function properly only with an ATX power supply with 5VSB that has 200mA.

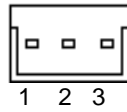

Pin #	Signal Name
1	+5VSB
2	Ground
3	Wake on LAN

J5: Parallel Port Connector

The following table describes the pin out assignments of this connector.

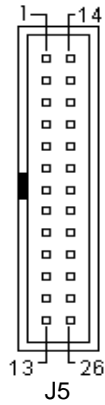

Signal Name	Pin #	Pin #	Signal Name
Line printer strobe	1	14	AutoFeed
PD0, parallel data 0	2	15	Error
PD1, parallel data 1	3	16	Initialize
PD2, parallel data 2	4	17	Select
PD3, parallel data 3	5	18	Ground
PD4, parallel data 4	6	19	Ground
PD5, parallel data 5	7	20	Ground
PD6, parallel data 6	8	21	Ground
PD7, parallel data 7	9	22	Ground
ACK, acknowledge	10	23	Ground
Busy	11	24	Ground
Paper empty	12	25	Ground
Select	13	N/A	N/A

J6: Flat Panel LCD Connector

J6 is a 58-pin (dual in line header) for flat panel LCD displays. The following shows the pin assignments of this connector.

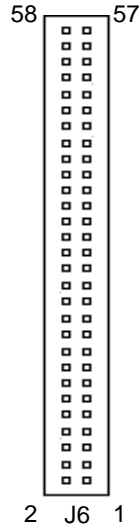

Signal Name	Pin #	Pin #	Signal Name
+12V	1	2	+12V
GND	3	4	GND
+5V/3.3V	5	6	+5V/3.3V
ENPVEE	7	8	GND
PD0	9	10	PD1
PD2	11	12	PD3
PD4	13	14	PD5
PD6	15	16	PD7
PD8	17	18	PD9
PD10	19	20	PD11
PD12	21	22	PD13
PD14	23	24	PD15
PD16	25	26	PD17
PD18	27	28	PD19
PD20	29	30	PD21
PD22	31	32	PD23
GND	33	34	GND
SHFCLK	35	36	FLM
M	37	38	LP
GND	39	40	ENABKL
GND	41	42	PVDD
ENAVDD	43	44	+5V/3.3V
NC	45	46	NC
PD24	47	48	PD25
PD26	49	50	PD27
PD28	51	52	PD29
PD30	53	54	PD31
PD32	55	56	PD33
PD34	57	58	PD35

Panel Signal Mapping

Table 1. DSTN Pins PD [0:15]

Type	PD0	PD1	PD2	PD3	PD4	PD5	PD6	PD7	PD8	PD9	PD10	PD11	PD12	PD13	PD14	PD15
DSTN16	LD0	LD1	LD2	LD3	LD4	LD5	LD6	LD7	UD0	UD1	UD2	UD3	UD4	UD5	UD6	UD7
DSTN24	LD0	LD1	LD2	LD3	LD4	LD5	LD6	LD7	LD8	LD9	LD10	LD11	UD0	UD1	UD2	UD3
	PD16	PD17	PD18	PD19	PD20	PD21	PD22	PD23								
DSTN24	UD4	UD5	UD6	UD7	UD8	UD9	UD10	UD11								

- Notes:**
- For 16-bit color dual scan STNs, LD7 or UD7 above corresponds to red column 0 for the first data of a line
 - For 24-bit color dual scan STNs, LD11 or UD11 above corresponds to red column 0 for the first data of a line. UD4-UD11 are on P16-P23.

Table 2. TFT Pins PD [0:23]

Data	R7	R6	R5	R4	R3	R2	R1	R0	G7	G6	G5	G4	G3	G2	G1	G0
TFT	PD0	PD1	PD2	PD3	PD4	PD5	PD6	PD7	PD8	PD9	PD10	PD11	PD12	PD13	PD14	PD15
12	R3	R2	R1	R0	G3	G2	G1	G0	B3	B2	B1	B0				
12+12	Ro3	Ro2	Ro1	Ro0	Go3	Go2	Go1	Go0	Bo3	Bo2	Bo1	Bo0	Re3	Re2	Re1	Re0
18	R5	R4	R3	R2	G5	G4	G3	G2	B5	B4	B3	B2	R1	R0	G1	G0
18+18¹	R5	R4	R3	R2	G5	G4	G3	G2	B5	B4	B3	B2	R1	R0	G1	G0
24	R7	R6	R5	R4	G7	G6	G5	G4	B7	B6	B5	B4	R3	R2	G1	G2

Data	B7	B6	B5	B4	B3	B2	B1	B0		
TFT	PD16	PD17	PD18	PD19	PD20	PD21	PD22	PD23	PD24	PD25
12										
12+12	Ge3	Ge2	Ge1	Ge0	Be3	Be2	Be1	Be0		
18	B1	B0								
18+18¹	B1	B0						S1	S2	
24	B3	B2	R1	R0	G1	G0	B1	B0		

Table 3. TFT 18+18² PD [0:35]

TFT	PD0	PD1	PD2	PD3	PD4	PD5	PD6	PD7	PD8	PD9	PD10	PD11	PD12	PD13	PD14	PD15
18+18	Ro5	Ro4	Ro3	Ro2	Go5	Go4	Go3	Go2	Bo5	Bo4	Bo3	Bo2	Re5	Re4	Re3	Re2

TFT	PD16	PD17	PD18	PD19	PD20	PD21	PD22	PD23	PD24	PD25	PD26	PD27
18+18	Ge5	Ge4	Ge3	Ge2	Be5	Be4	Be3	Be2	Ro1	Ro0	Go1	Go0

TFT	PD28	PD29	PD30	PD31	PD32	PD33	PD34	PD35
18+18	Bo1	Bo0	Re1	Re0	Ge1	Ge0	Be1	Be0

- Notes:**
- Type 1 of 18+18 uses external latches to capture odd and even data.
 - Type 2 of 18+18 is direct 36-bit output.
 - The most significant bits of color data are always on pins P0, P4, and P8.

J7: COM1 Serial Port

J7, a 10-pin header connector, is an onboard serial port of the CI6BM. The following table shows the pin assignments of this connector.

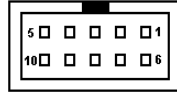

J7: COM1

Pin #	Signal Name
1	DCD, Data carrier detect
2	RXD, Receive data
3	TXD, Transmit data
4	DTR, Data terminal ready
5	GND, ground
6	DSR, Data set ready
7	RTS, Request to send
8	CTS, Clear to send
9	RI, Ring indicator
10	NC

J8: COM2 Serial Port

J8, a 10-pin header connector, is the onboard COM2 serial port of the CI6BM. The following table shows its pin assignments.

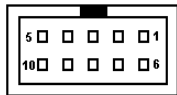

J8: COM2

Pin #	Signal Name		
	RS-232	R2-422	RS-485
1	DCD	TX-	DATA-
2	RX	TX+	DATA+
3	TX	RX+	NC
4	DTR	RX-	NC
5	GND	GND	GND
6	DSR	RTS-	NC
7	RTS	RTS+	NC
8	CTS	CTS+	NC
9	RI	CTS-	NC
10	NC	NC	NC

J9: External Keyboard Connector



Pin #	Signal Name
1	Keyboard clock
2	Keyboard data
3	PG
4	GND
5	Vcc

J10: External ATX Power Connector



Pin #	Signal Name
1	N.C.
2	GND
3	N.C.
4	GND
5	PS-ON (soft on/off)
6	5V SB (standby +5V)

J11: PS/2 Keyboard Connector

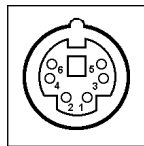

Pin #	Signal Name
1	Keyboard data
2	N.C.
3	GND
4	5V
5	Keyboard clock
6	N.C.

J12: PS/2 Mouse Connector

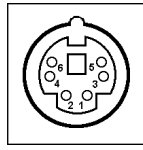

J12

Pin #	Signal Name
1	Mouse data
2	N.C.
3	N.C.
4	5V
5	Mouse Clock
6	N.C.

J13: VGA CRT Connector

The pin assignments of J13 VGA CRT connector are as follows:

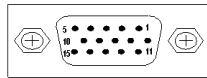

J13

Signal Name	Pin	Pin	Signal Name
Red	1	2	Green
Blue	3	4	N.C.
GND	5	6	GND
GND	7	8	GND
N.C.	9	10	GND
N.C.	11	12	N.C.
HSYNC	13	14	VSYNC
NC	15		

J14: CPU Fan Power Connector

J14 is a 3-pin header for the CPU fan. The fan must be a 12V fan.

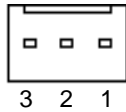

Pin #	Signal Name
1	Ground
2	+12V
3	Rotation

J16: Chassis Fan Power Connector

J16 is a 3-pin header for the chassis fan. The fan must be a 12V fan.

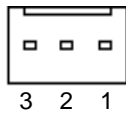

Pin #	Signal Name
1	Ground
2	+12V
3	Rotation

J17, J18: USB Connectors

The following table shows the pin outs of the USB connectors.

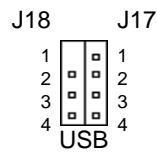

J18 Pin #	J17 Pin #	Signal Name
1	1	Vcc
2	2	USB-
3	3	USB+
4	4	Ground

J19: RJ45 Connector

This connector is for the 10/100Mbps Ethernet capability of the CPU card. The figure below shows the pin out assignments of this connector and its corresponding input jack.

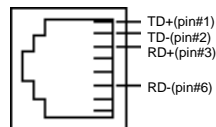

JP8: IrDA Connector

This connector is used for an IrDA connector for wireless communication.

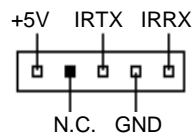

Pin #	Signal Name
1	+5V
2	No connect
3	Ir TX
4	Ground
5	Ir RX

JP12: SB-Link Connector

This connector is used for Creative Sound AWE64D PCI sound card.

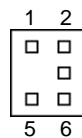

Pin #	Signal Name	Pin #	Signal Name
1	GNTA#	4	REQA#
2	Ground	5	Ground
3	N.C.	6	SERIRQ#

CON1, CON2: PC-104 Connector

CON1 and CON2 are dual-in-line pin headers that support PC-104 modules. CON1 consists of 64 pins and CON2 has 40 pins. The following table shows the their pin assignments.

CON1				CON2			
Pin	Signal Name	Pin	Signal Name	Pin	Signal Name	Pin	Signal Name
A1	IOCHK	B1	GND	C1	GND	D1	GND
A2	D7	B2	REST	C2	SBHE	D2	MEMCS16
A3	D6	B3	VCC	C3	LA23	D3	IOCS16
A4	D5	B4	IRQ9	C4	LA22	D4	IRQ10
A5	D4	B5	-5V	C5	LA21	D5	IRQ11
A6	D3	B6	DRQ2	C6	LA20	D6	IRQ12
A7	D2	B7	-12V	C7	LA19	D7	IRQ15
A8	D1	B8	OWS	C8	LA18	D8	IRQ14
A9	D0	B9	+12V	C9	LA17	D9	DACK0
A10	IOCHRDY	B10	GND	C10	MEMR	D10	DRQ0
A11	AEN	B11	SMEMW	C11	MEMW	D11	DACK5
A12	A19	B12	SMEMR	C12	D8	D12	DRQ5
A13	A18	B13	IOW	C13	D9	D13	DACK6
A14	A17	B14	IOR	C14	D10	D14	DRQ6
ZA15	A16	B15	DACK3	C15	D11	D15	DACK7
A16	A15	B16	DRQ3	C16	D12	D16	DRQ7
A17	A14	B17	DACK1	C17	D13	D17	VCC
A18	A13	B18	DRQ1	C18	D14	D18	MASTER
A19	A12	B19	REFRESH	C19	D15	D19	GND
A20	A11	B20	CLK	C20	KEY PIN	D20	GND
A21	A10	B21	IRQ7				
A22	A9	B22	IRQ6				
A23	A8	B23	IRQ5				
A24	A7	B24	IRQ4				
A25	A6	B25	IRQ3				
A26	A5	B26	DACK2				
A27	A4	B27	TC				
A28	A3	B28	BALE				
A29	A2	B29	VCC				
A30	A1	B30	OSC				
A31	A0	B31	GND				
A32	GND	B32	GND				

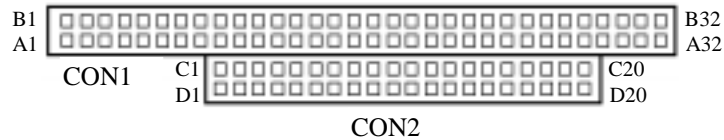

LED1, LED2: LAN Activity Indicators

LED1 and LED2 are orange and yellow LED indicators located at the bracket side of the CPU card that shows LAN activity and the transfer rate in progress. Refer to the following table for the functions of each LED status.

LED1 (yellow) Status	Function	LED2 (green) Status	Function
ON	Data transfer in progress	OFF	10Mbps transfer rate
OFF	Data transfer off (Link off)	ON	100Mbps transfer rate

Watchdog Timer Configuration

The function of the watchdog timer is to reset the system automatically and is defined at I/O port 0443H. To enable the watchdog timer and allow the system to reset, write I/O port 0443H. To disable the timer, write I/O port 0441H for the system to stop the watchdog function. The timer has a tolerance of 20% for its intervals.

The following describes how the timer should be programmed.

Enabling Watchdog:

```
MOV AX, 000FH (Choose the values from 0)
MOV DX, 0443H
OUT DX, AX
```

Disabling Watchdog

```
MOV AX, 00FH (Any value is fine.)
MOV DX, 0441H
OUT DX, AX
```

WATCHDOG TIMER CONTROL TABLE

Level	Value	Time/sec	Level	Value	Time/sec
1	F	0	9	7	16
2	E	2	10	6	18
3	D	4	11	5	20
4	C	6	12	4	22
5	B	8	13	3	24
6	A	10	14	2	26
7	9	12	15	1	28
8	8	14	16	0	30

3

BIOS Configuration

This chapter describes the different settings available in the Award BIOS that comes with the CI6BM CPU card. The topics covered in this chapter are as follows:

BIOS Introduction.....	36
BIOS Setup	36
Standard CMOS Setup	38
Date	38
Time	39
Primary HDDs / Secondary HDDs	39
Drive A / Drive B	40
Video	40
Halt On	40
BIOS Features Setup.....	41
Virus Warning	41
CPU Internal Cache / External Cache.....	41
CPU L2 Cache ECC Checking	42
Quick Power On Self Test	42
Boot Sequence.....	42
Swap Floppy Drive.....	42
Boot Up Floppy Seek	42
Boot Up NumLock Status.....	42
Boot Up System Speed	42
Gate A20 Option	42
Typematic Rate Setting.....	43
Typematic Rate (Chars/Sec).....	43
Typematic Delay (Msec)	43
Security Option.....	43

PCI/VGA Palette Snoop	43
OS Select for DRAM > 64MB	43
Report No FDD For WIN 95	43
Video BIOS Shadow.....	43
C8000 - CBFFF Shadow/DC000 - DFFFF Shadow	44
Chipset Features Setup	45
Auto Configuration	45
SDRAM RAS-toCAS Delay	45
SDRAM RAS Precharge Time	45
SDRAM CAS Latency Time	45
DRAM Integrity Mode	46
System BIOS Cacheable	46
Video BIOS Cacheable.....	46
Video RAM Cacheable.....	46
8 Bit I/O Recovery Time	46
16 Bit I/O Recovery Time	46
Memory Hole at 15MB - 16MB	46
Passive Release.....	46
Delayed Transaction	47
AGP Aperture Size (MB)	45
CPU Warning Temperature	45
Current CPU/Chips Temp. / Current System Temp.	47
Current CPU Fan Speed/Chassis Fan Speed	47
VCCP / VTT / VCC3.....	47
Power Management Setup	48
Power Management	48
PM Control by APM.....	49
Video Off Method.....	49
Video Off After.....	49
Modem Use IRQ.....	49
Doze Mode	49
Standby Mode	49
Suspend Mode	49
HDD Power Down.....	49
Throttle Duty Cycle	49
VGA Active Monitor	50
Soft-Off by PWR-BTTN	50
Resume by Ring	50
Resume by Alarm.....	50
IRQ 8 Break Suspend	50
Reload Global Timer Events.....	50

PNP/PCI Configuration.....	51
PNP OS Installed.....	51
Resources Controlled by.....	51
Reset Configuration Data	51
IRQ3/4/5/7/9/10/11/12/14/15, DMA0/1/3/5/6/7 assigned to	51
Load BIOS Defaults.....	53
Load Setup Defaults.....	53
Integrated Peripherals	54
IDE HDD Block Mode.....	54
IDE Primary/Secondary Master/Slave PIO	54
IDE Primary/Secondary Master/Slave UDMA	54
On-Chip Primary/Secondary PCI IDE.....	55
USB Keyboard Support.....	55
Init AGP Display First.....	55
Onboard FDC Controller.....	55
Onboard Serial/Parallel Port.....	55
UART Mode Select	55
Parallel Port Mode.....	55
Supervisor / User Password	56
IDE HDD Auto Detection.....	57
Save & Exit Setup	58
Exit Without Saving.....	58

BIOS Introduction

The Award BIOS (Basic Input/Output System) installed in your computer system's ROM supports Intel Pentium II processors in a standard IBM-AT compatible I/O system. The BIOS provides critical low-level support for a standard device such as disk drives, serial ports and parallel ports. It also adds virus and password protection as well as special support for detailed fine-tuning of the chipset controlling the entire system.

BIOS Setup

The Award BIOS provides a Setup utility program for specifying the system configurations and settings. The BIOS ROM of the system stores the Setup utility. When you turn on the computer, the Award BIOS is immediately activated. Pressing the key immediately allows you to enter the Setup utility. If you are a little bit late pressing the key, POST (Power On Self Test) will continue with its test routines, thus preventing you from invoking the Setup. If you still wish to enter Setup, restart the system by pressing the "Reset" button or simultaneously pressing the <Ctrl>, <Alt> and <Delete> keys. You can also restart by turning the system Off and back On again. The following message will appear on the screen:

Press to Enter Setup

In general, you press the arrow keys to highlight items, <Enter> to select, the <PgUp> and <PgDn> keys to change entries, <F1> for help and <Esc> to quit.

When you enter the Setup utility, the Main Menu screen will appear on the screen. The Main Menu allows you to select from various setup functions and exit choices.

ROM PCI/ISA BIOS
CMOS SETUP UTILITY
AWARD SOFTWARE, INC.

STANDARD CMOS SETUP	INTEGRATED PERIPHERALS
BIOS FEATURES SETUP	SUPERVISOR PASSWORD
CHIPSET FEATURES SETUP	USER PASSWORD
POWER MANAGEMENT SETUP	IDE HDD AUTO DETECTION
PNP/PCI CONFIGURATION	SAVE & EXIT SETUP
LOAD BIOS DEFAULTS	EXIT WITHOUT SAVING
LOAD SETUP DEFAULTS	
ESC : Quit	↑ ↓ → ← : Select Item
F10 : Save & Exit Setup	(Shift) F2 : Change Color
Time, Date, Hard Disk Type	

The section below the setup items of the Main Menu displays the control keys for this menu. At the bottom of the Main Menu just below the control keys section, there is another section which displays information on the currently highlighted item in the list.

NOTE: *If your computer cannot boot after making and saving system changes with Setup, the Award BIOS supports an override to the CMOS settings that resets your system to its default.*

We strongly recommend that you avoid making any changes to the chipset defaults. These defaults have been carefully chosen by both Award and your system manufacturer to provide the absolute maximum performance and reliability.

Standard CMOS Setup

The “Standard CMOS Setup” choice allows you to record some basic hardware configurations in your computer system and set the system clock and error handling. If the motherboard is already installed in a working system, you will not need to select this option. You will need to run the Standard CMOS option, however, if you change your system hardware configurations, the onboard battery fails, or the configuration stored in the CMOS memory was lost or damaged.

ROM PCI/ISA BIOS
STANDARD CMOS SETUP
AWARD SOFTWARE, INC.

Date (mm:dd:yy) : Wed, Mar 4 1998								
Time (hh:mm:ss) : 00 : 00 : 00								
HARD DISKS	TYPE	SIZE	CYLS	HEAD	PRECOMP	LANDZ	SECTOR	MODE
Primary Master	Auto	0	0	0	0	0	0	Auto
Primary Slave	Auto	0	0	0	0	0	0	Auto
Secondary Master	Auto	0	0	0	0	0	0	Auto
Secondary Slave	Auto	0	0	0	0	0	0	Auto
Drive A	: 1.44M, 3.5in							
Drive B	: None							
Video	: EGA / VGA							
Halt On	: All Errors							
			Base Memory			: 640K		
			Extended Memory			: 15360K		
			Other Memory			: 384K		
			Total Memory			: 16384K		
ESC : Quit			↑ ↓ → ← : Select Item			PU / PD / + / - : Modify		
F1 : Help			(Shift) F2 : Change Color					

At the bottom of the menu are the control keys for use on this menu. If you need any help in each item field, you can press the <F1> key. It will display the relevant information to help you. The memory display at the lower right-hand side of the menu is read-only. It will adjust automatically according to the memory changed. The following describes each item of this menu.

Date

The date format is:

Day : Sun to Sat
Month : 1 to 12
Date : 1 to 31
Year : 1994 to 2079

To set the date, highlight the “Date” field and use the PageUp/ PageDown or +/- keys to set the current time.

Time

The time format is: **Hour : 00 to 23**
Minute : 00 to 59
Second : 00 to 59

To set the time, highlight the “Time” field and use the <PgUp>/<PgDn> or +/- keys to set the current time.

Primary HDDs / Secondary HDDs

The onboard PCI IDE connectors provide Primary and Secondary channels for connecting up to four IDE hard disks or other IDE devices. Each channel can support up to two hard disks; the first is the “Master” and the second is the “Slave”.

To enter the specifications for a hard disk drive, you must select first a “Type”. There are 45 predefined types and 4 user definable types are for Enhanced IDE BIOS. Type 1 to 45 are predefined. Type “User” is user-definable. For the Primary Master/Slave as well as Secondary Master/Slave, you can select “Auto” under the TYPE and MODE fields. This will enable auto detection of your IDE drives and CD-ROM drive during POST.

Press <PgUp>/<PgDn> to select a numbered hard disk type or type the number and press the <Enter> key. The hard disk will not work properly if you enter incorrect information for this field. If your hard disk drive type is not matched or listed, you can use Type User to define your own drive type manually. If you select Type User, related information is asked to be entered to the following items.

CYLS : Number of cylinders
HEAD : Number of read/write heads
PRECOMP : Write precompensation
LANDZ : Landing zone
SECTOR : Number of sectors
SIZE : Automatically adjust according to the configuration
MODE (for IDE HDD only) : Auto
Normal (HD < 528MB)
Large (for MS-DOS only)
LBA (HD > 528MB and supports
Logical Block Addressing)

NOTE: *The specifications of your drive must match with the drive table. The hard disk will not work properly if you enter incorrect information in these fields. If your hard disk drive type is not matched or listed, you can use Type User to define your own drive type manually.*

Drive A / Drive B

These fields identify the types of floppy disk drive A or drive B that has been installed in the computer. The available specifications are:

360KB 1.2MB 720KB 1.44MB 2.88MB
5.25 in. 5.25 in. 3.5 in. 3.5 in. 3.5 in.

Video

This field selects the type of video display card installed in your system. You can choose the following video display cards:

EGA/VGA	For EGA, VGA, SEGA, SVGA or PGA monitor adapters. (default)
CGA 40	Power up in 40 column mode.
CGA 80	Power up in 80 column mode.
MONO	For Hercules or MDA adapters.

Halt On

This field determines whether the system will halt if an error is detected during power up.

No errors	The system boot will not be halted for any error that may be detected. (default)
All errors	Whenever the BIOS detects a non-fatal error, the system will stop and you will be prompted.
All, But Keyboard	The system boot will not be halted for a keyboard error; it will stop for all other errors
All, But Diskette	The system boot will not be halted for a disk error; it will stop for all other errors.
All, But Disk/Key	The system boot will not be halted for a keyboard or disk error; it will stop for all others.

BIOS Features Setup

This section allows you to configure and improve your system and allows you to set up some system features according to your preference.

ROM / PCI ISA BIOS BIOS FEATURES SETUP AWARD SOFTWARE, INC.			
Virus Warning	: Disabled	Video BIOS Shadow	: Enabled
CPU Internal Cache	: Enabled	C8000-CBFFF Shadow	: Disabled
External Cache	: Enabled	CC000-CFFFF Shadow	: Disabled
CPU L2 Cache ECC Checking	: Enabled	D0000-D3FFF Shadow	: Disabled
Quick Power On Self Test	: Enabled	D4000-D7FFF Shadow	: Disabled
Boot Sequence	: A, C, SCSI	D8000-DBFFF Shadow	: Disabled
Swap Floppy Drive	: Disabled	DC000-DFFF Shadow	: Disabled
Boot Up Floppy Drive	: Enabled		
Boot Up Numlock Status	: On		
Gate A20 Option	: Fast		
Typematic Rate Setting	: Disabled		
Typematic Rate (chars/Sec)	: 6		
Typematic Delay (Msec)	: 250		
Security Option	: Setup		
PCI /VGA Palette Snoop	: Disabled		
OS Select For DRAM>64MB	: Non-OS2		
Report No FDD For WIN 95	: No		
		ESC : Quit	↑ ↓ → ← : Select Item
		F1 : Help	PU/PD/+/- : Modify
		F5 : Old Values	(Shift) F2 : Color
		F6 : Load BIOS Defaults	
		F7 : Load Setup Defaults	

Virus Warning

This item protects the boot sector and partition table of your hard disk against accidental modifications. If an attempt is made, the BIOS will halt the system and display a warning message. If this occurs, you can either allow the operation to continue or run an anti-virus program to locate and remove the problem.

NOTE: *Many disk diagnostic programs, which attempt to access the boot sector table, can cause the virus warning. If you will run such a program, disable the Virus Warning feature.*

CPU Internal Cache / External Cache

Cache memory is additional memory that is much faster than conventional DRAM (system memory). CPUs from 486-type on up contain internal cache memory, and most, but not all, modern PCs have additional (external) cache memory. When the CPU requests data, the system transfers the requested data from the main DRAM into cache memory, for even faster access by the CPU. These items allow you to enable (speed up memory access) or disable the cache function. By default, these items are **Enabled**.

CPU L2 Cache ECC Checking

When enabled, this allows ECC checking of the CPU's L2 cache. By default, this field is *Enabled*.

Quick Power On Self Test

When enabled, this field speeds up the Power On Self Test (POST) after the system is turned on. If it is set to *Enabled*, BIOS will skip some items.

Boot Sequence

This field determines the drive that the system searches first for an operating system. The options are:

A, C, SCSI	D, A, SCSI	SCSI, C, A
C, A, SCSI	E, A, SCSI	C only
C, CDROM, A	F, A, SCSI	LS/ZIP, C
CDROM, C, A	SCSI, A, C	

The default value is *A, C, SCSI*.

Swap Floppy Drive

This item allows you to determine whether or not to enable Swap Floppy Drive. When enabled, the BIOS swaps floppy drive assignments so that Drive A becomes Drive B, and Drive B becomes Drive A. By default, this field is set to *Disabled*.

Boot Up Floppy Seek

When enabled, the BIOS will seek whether or not the floppy drive installed has 40 or 80 tracks. 360K type has 40 tracks while 760K, 1.2M and 1.44M all have 80 tracks. By default, this field is set to *Enabled*.

Boot Up NumLock Status

This allows you to activate the NumLock function after you power up the system. By default, the system boots up with *NumLock On*.

Boot Up System Speed

This has no function and selects the default system speed (*High*).

Gate A20 Option

This field allows you to select how Gate A20 is worked. Gate A20 is a device used to address memory above 1 MB. The default setting is *Fast*.

Typematic Rate Setting

When disabled, continually holding down a key on your keyboard will generate only one instance. When enabled, you can set the two typematic controls listed next. By default, this field is set to *Disabled*.

Typematic Rate (Chars/Sec)

When the typematic rate is enabled, the system registers repeated keystrokes speeds. You can select speed range from 6 to 30 characters per second. By default, this item is set to **6**.

Typematic Delay (Msec)

When the typematic rate is enabled, this item allows you to set the time interval for displaying the first and second characters. By default, this item is set to *250msec*.

Security Option

This field allows you to limit access to the System and Setup. The default value is *Setup*. When you select *System*, the system prompts for the User Password every time you boot up. When you select *Setup*, the system always boots up and prompts for the Supervisor Password only when the Setup utility is called up.

PCI/VGA Palette Snoop

Some non-standard VGA display cards may not show colors properly. This field allows you to set whether or not MPEG ISA/VESA VGA Cards can work with PCI/VGA. When this field is enabled, a PCI/VGA can work with an MPEG ISA/VESA VGA card. When this field is disabled, a PCI/VGA cannot work with an MPEG ISA/VESA Card.

OS Select for DRAM > 64MB

This option allows the system to access greater than 64MB of DRAM memory when used with OS/2 that depends on certain BIOS calls to access memory. The default setting is *Non-OS/2*.

Report No FDD For WIN 95

This option allows Windows 95 to share with other peripherals IRQ6 which is assigned to a floppy disk drive if the drive is not existing. The default setting is *No*.

Video BIOS Shadow

This item allows you to change the Video BIOS location from ROM to RAM. Video Shadow will increase the video speed.

C8000 - CBFFF Shadow/DC000 - DFFFF Shadow

Shadowing a ROM reduces the memory available between 640KB to 1024KB. These fields determine whether or not optional ROM will be copied to RAM.

Chipset Features Setup

This Setup menu controls the configuration of the motherboard chipset.

ROM PCI/ISA BIOS CHIPSET FEATURES SETUP AWARD SOFTWARE INC.			
Auto Configuration	: Enabled	CPU Warning Temperature	: 66°C/151°F
SDRAM RAS-to-CAS Delay	3	Current CPU Block Temp.	: 41°C/ 105°F
SDRAM RAS Precharge Time	3	Current CPU/Chips Temp.	: 27°C/ 80°F
SDRAM CAS Latency Time	3	Current System Temp.	: 34°C/ 93°F
DRAM Integrity Mode	Non-ECC	Current CPU Fan Speed	: 2789 RPM
System BIOS Cacheable	: Disabled	Current Chassis Fan Speed	: 2045 RPM
Video BIOS Cacheable	: Enabled	VCCP (V):	1.98 V VTT (V) : 1.50 V
Video RAM Cacheable	: Disabled	VCC3 (V):	3.45 V + 5 V : 4.99 V
8 Bit I/O Recovery Time	: 3	+12 V :	12.46 V -12 V : -12.54V
16 Bit I/O Recovery Time	: 2	-5V :	-5.21 V
Memory Hole At 15MB-16MB	: Disabled	ESC : Quit	↑ ↓ → ← : Select Item
Passive Release	: Disabled	F1 : Help	PU/PD/+/- : Modify
Delayed Transaction	: Disabled	F5 : Old Values	(Shift) F2 : Color
AGP Aperture Size (MB)	: 64	F6 : Load BIOS Defaults	
		F7 : Load Setup Defaults	

Auto Configuration

This field predefines values for DRAM, cache timing according to CPU type and system clock. When this field is enabled, the predefined items will become read-only.

SDRAM RAS-to-CAS Delay

When DRAM is refreshed, both rows and columns are addressed separately. This field allows you to determine the timing of transition from Row Address Strobe (RAS) to Column Address Strobe (CAS). The default setting is 3.

SDRAM RAS Precharge Time

The precharge time is the number of cycles it takes for the RAS to accumulate its charge before DRAM refresh. If insufficient time is allowed, refresh may be incomplete and the DRAM may fail to retain data. The default setting is 3.

SDRAM CAS Latency Time

When synchronous DRAM is installed, the number of clock cycles of CAS latency depends on the DRAM timing. Do not reset this field from the default value specified by the system designer. The default setting is 3.

DRAM Data Integrity Mode

This option sets the data integrity mode of the DRAM installed in the system. The default setting is *Non-ECC*.

System BIOS Cacheable

When enabled, access to the system BIOS ROM addressed at F0000H-FFFFFH is cached, provided that the cache controller is disabled.

Video BIOS Cacheable

When enabled, access to video BIOS addressed at C0000H to C7FFFH is cached, provided that the cache controller is disabled.

Video RAM Cacheable

Selecting *Enabled* allows caching of the video BIOS ROM at C0000h to C7FFFh, resulting in better video performance. However, if any program writes to this memory area, a memory access error may result.

8 Bit I/O Recovery Time

This option specifies the length of the delay (in sysclks) inserted between consecutive 8-bit I/O operations. The settings are 1, 2, 3, 4, 5, 6, 7, or 8. The default setting is 3.

16 Bit I/O Recovery Time

This option specifies the length of the delay (in sysclks) inserted between consecutive 16-bit I/O operations. The settings are 1, 2, 3, 4, 5, 6, 7, or 8. The default setting is 2.

Memory Hole at 15MB - 16MB

In order to improve performance, certain space in memory can be reserved for ISA cards. This field allows you to reserve 15MB to 16MB of memory address space to ISA expansion cards. This makes memory from 15MB and up unavailable to the system. Expansion cards can only access memory up to 16MB. By default, this field is set to *Disabled*.

Passive Release

When enabled, CPU to PCI bus accesses are allowed during passive release. Otherwise, the arbiter only accepts another PCI master access to local DRAM.

Delayed Transaction

The chipset has an embedded 32-bit posted write buffer to support delay transactions cycles. Select *Enabled* to support compliance with PCI specification version 2.1. The default setting is *Disabled*.

AGP Aperture Size (MB)

The field sets aperture size of the graphics. The aperture is a portion of the PCI memory address range dedicated for graphics memory address space. Host cycles that hit the aperture range are forwarded to the AGP without any translation. The options available are 4M, 8M, 16M, 32M, 64M, 128M and 256M. The default setting is *64M*.

CPU Warning Temperature

This field sets the threshold temperature at which an alert is sounded through the system's speaker. The CPU temperature is monitored by the onboard thermal sensor to prevent the CPU from overheating.

Current CPU/Chips Temp. / Current System Temp.

These read-only fields reflect the functions of the hardware thermal sensor that monitors the chip blocks and system temperatures to ensure the system is stable.

Current CPU Fan Speed/Chassis Fan Speed

These optional and read-only fields show the current speeds in RPM (revolution per minute) for the CPU fan and chassis fan as monitored by the hardware monitoring IC.

VCCP / VTT / VCC3

These optional and read-only fields show the current voltages in the voltage regulators and power supply as monitored by the hardware monitoring IC.

Power Management Setup

The Power Management Setup allows you to save energy of your system effectively. It will shut down the hard disk and turn off video display after a period of inactivity.

ROM PCI/ISA BIOS
POWER MANAGEMENT SETUP
AWARD SOFTWARE, INC.

Power Management	: User Define	** Reload Global Timer Events **	
PM Control by APM	: Yes	IRQ3 (3-7, 9-15), NMI	: Disabled
Video Off Method	: V/H SYNC +Blank	Primary IDE 0	: Enabled
Video Off After	: Standby	Primary IDE 1	: Enabled
MODEM Use IRQ	: 3	Secondary IDE 0	: Disabled
		Secondary IDE 1	: Disabled
Doze Mode	: Disabled	Floppy Disk	: Disabled
Standby Mode	: Disabled	Serial Port	: Enabled
Suspend Mode	: Disabled	Parallel Port	: Disabled
HDD Power Down	: Disabled		
Throttle Duty Cycle	: 62.5%		
VGA Active Monitor	: Enabled		
Soft-Off by PWR-BTTN	: Instant-Off		
Resume by Ring	: Disabled		
Resume by Alarm	: Disabled		
IRQ 8 Break Suspend	: Disabled	ESC : Quit	↑ ↓ → ← : Select Item
		F1 : Help	PU/PD/+/- : Modify
		F5 : Old Values	(Shift) F2 : Color
		F6 : Load BIOS Defaults	
		F7 : Load Setup Defaults	

Power Management

This field allows you to select the type of power saving management modes. There are four selections for Power Management.

Min. Power Saving	Minimum power management
Max. Power Saving	Maximum power management.
User Define	Each of the ranges is from 1 min. to 1hr. Except for HDD Power Down which ranges from 1 min. to 15 min. (Default)

NOTE: In order to enable the CPU overheat protection feature, the Power Management field should not be set to Disabled.

PM Control by APM

This field allows you to use the Advanced Power Management device to enhance the Max. Power Saving mode and stop the CPU's internal clock. If the Max. Power Saving is not enabled, this will be preset to NO.

Video Off Method

This field defines the Video Off features. There are three options.
V/H SYNC + Blank Default setting, blank the screen and turn off vertical and horizontal scanning.

DPMS Allows the BIOS to control the video display card if it supports the DPMS feature.

Blank Screen This option only writes blanks to the video buffer.

Video Off After

As the system moves from lesser to greater power-saving modes, select the mode in which you want the monitor to blank.

Modem Use IRQ

This field names the interrupt request (IRQ) line assigned to the modem (if any) on your system. Activity of the selected IRQ always awakens the system. By default, the IRQ is set to 3.

Doze Mode

When enabled, and after the set time of system inactivity, the CPU clock will run at a slower speed while all other devices still operate at full speed.

Standby Mode

After the selected period of system inactivity, the fixed disk drive and the video shut off while all other devices still operate at full speed.

Suspend Mode

When enabled, and after the set time of system inactivity, all devices except the CPU will be shut off.

HDD Power Down

When enabled, and after the set time of system inactivity, the hard disk drive will be powered down while all other devices remain active.

Throttle Duty Cycle

When the system enters Doze mode, the CPU clock runs only part of the time. You may select the percent of time that the clock runs.

VGA Active Monitor

When enabled, any video activity restarts the global timer for Standby mode. The default setting is *Enabled*.

Soft-Off by PWR-BTTN

This field defines the power-off mode when using an ATX power supply. The Instant-Off mode allows powering off immediately upon pressing the power button. In the Delay 4 Sec mode, the system powers off when the power button is pressed for more than four seconds or places the system in a very low-power-usage state, with only enough circuitry receiving power to detect power button activity or Resume by Ring activity (see next field) when pressed for less than 4 seconds. The default value is *Instant-Off*.

Resume by Ring

An input signal on the serial Ring Indicator (RI) line (in other words, an incoming call on the modem) awakens the system from a soft off state.

Resume by Alarm

This allows a computer to be turned on automatically through the timer set in the BIOS to make the system more scheduleable. By default, this field is set to *Disabled*.

IRQ 8 Break Suspend

You can enable or disable the monitoring of IRQ 8 (Real Time Clock) so it does not awaken the system from Suspend mode.

Reload Global Timer Events

This section determines the reloading of the 'timers' after entering the Full On You can enable or disable the monitoring of IRQ 8 (Real Time Clock) so it does not awaken the system from Suspend mode.

PNP/PCI Configuration

This option configures the PCI bus system. All PCI bus systems on the system use INT#, thus all installed PCI cards must be set to this value.

ROM PCI/ISA BIOS
PNP/PCI CONFIGURATION
AWARD SOFTWARE INC.

PNP OS Installed	: No	Used MEM base addr	: N/A
Resources Controlled by	: Manual		
Reset Configuration Data	: Disabled		
IRQ-3 assigned to	: Legacy ISA		
IRQ-4 assigned to	: Legacy ISA		
IRQ-5 assigned to	: PCI/ISA PnP		
IRQ-7 assigned to	: Legacy ISA		
IRQ-9 assigned to	: PCI/ISA PnP		
IRQ-10 assigned to	: PCI/ISA PnP		
IRQ-11 assigned to	: PCI/ISA PnP		
IRQ-12 assigned to	: PCI/ISA PnP		
IRQ-14 assigned to	: PCI/ISA PnP		
IRQ-15 assigned to	: PCI/ISA PnP		
DMA-0 assigned to	: PCI/ISA PnP		
DMA-1 assigned to	: PCI/ISA PnP	ESC : Quit	↑ ↓ ← : Select Item
DMA-3 assigned to	: PCI/ISA PnP	F1 : Help	PU/PD/+/- : Modify
DMA-5 assigned to	: PCI/ISA PnP	F5 : Old Values	(Shift) F2 : Color
DMA-6 assigned to	: PCI/ISA PnP	F6 : Load BIOS Defaults	
DMA-7 assigned to	: PCI/ISA PnP	F7 : Load Setup Defaults	

PNP OS Installed

This field allows you to specify if the operating system installed in your system is plug and play aware.

NOTE: *Operating systems such as DOS, OS/2, and Windows 3.x do not use PnP*

Resources Controlled by

This PnP BIOS can configure all of the boot and compatible devices automatically. However, this capability needs you to use a PnP operating system such as Windows 95. The default value is **Manual**.

Reset Configuration Data

This field allows you to determine whether or not to reset the configuration data. The default value is **Disabled**.

IRQ3/4/5/7/9/10/11/12/14/15, DMA0/1/3/5/6/7 assigned to

These fields allow you to determine the IRQ/DMA assigned to the ISA bus and is not available to any PCI slot.

Used MEM base addr

Select a base address for the memory area used by any peripheral that requires high memory. The default setting is *N/A*.

Load BIOS Defaults

This option allows you to load the troubleshooting default values permanently stored in the BIOS ROM. These default settings are non-optimal and disable all high-performance features.

ROM PCI/ISA BIOS
CMOS SETUP UTILITY
AWARD SOFTWARE, INC.

STANDARD CMOS SETUP BIOS FEATURES SETUP CHIPSET FEATURES SETUP POWER MANAG PNP/PCI CONF LOAD BIOS DEF LOAD SETUP DEF	INTEGRATED PERIPHERALS SUPERVISOR PASSWORD USER PASSWORD DETECTION UP AVING
<div style="border: 1px solid black; padding: 5px; display: inline-block;"> Load BIOS Defaults (Y/N)? N </div>	
ESC : Quit F10 : Save & Exit Setup	↑ ↓ → ← : Select Item (Shift) F2 : Change Color
Load BIOS Defaults except Standard CMOS Setup	

To load BIOS defaults value to CMOS SRAM, enter “Y”. If not, enter “N”.

Load Setup Defaults

This option allows you to load the default values to your system configuration. These default settings are optimal and enable all high performance features.

ROM PCI/ISA BIOS
CMOS SETUP UTILITY
AWARD SOFTWARE, INC.

STANDARD CMOS SETUP BIOS FEATURES SETUP CHIPSET FEATURES SETUP POWER MANAG PNP/PCI CONF LOAD BIOS DEF LOAD SETUP DEF	INTEGRATED PERIPHERALS SUPERVISOR PASSWORD USER PASSWORD DETECTION UP AVING
<div style="border: 1px solid black; padding: 5px; display: inline-block;"> Load Setup Defaults (Y/N)? N </div>	
ESC : Quit F10 : Save & Exit Setup	↑ ↓ → ← : Select Item (Shift) F2 : Change Color
Load BIOS Defaults except Standard CMOS Setup	

To load SETUP defaults value to CMOS SRAM, enter “Y”. If not, enter “N”.

Integrated Peripherals

This option sets your hard disk configuration, mode and port.

ROM PCI/ISA BIOS INTEGRATED PERIPHERALS AWARD SOFTWARE INC.			
IDE HDD Block Mode	: Enabled	Onboard Parallel Port	: 378/IRQ7
IDE Primary Master PIO	: Auto	Parallel Port Mode	: SPP
IDE Primary Slave PIO	: Auto		
IDE Secondary Master PIO	: Auto		
IDE Secondary Slave PIO	: Auto		
IDE Primary Master UDMA	: Auto		
IDE Primary Slave UDMA	: Auto		
IDE Secondary Master UDMA	: Auto		
IDE Secondary Slave UDMA	: Auto		
On-Chip Primary PCI IDE	: Enabled		
On-Chip Secondary PCI IDE	: Enabled		
USB Keyboard Support	: Disabled		
Init AGP Display First	: Disabled		
Onboard FDC Controller	: Enabled		
Onboard Serial Port 1	: 3F8/IRQ4	ESC : Quit	↑ ↓ ← : Select Item
Onboard Serial Port 2	: 2F8/IRQ3	F1 : Help	PU/PD/+/- : Modify
UART Mode Select	: Normal	F5 : Old Values	(Shift) F2 : Color
		F6 : Load BIOS Defaults	
		F7 : Load Setup Defaults	

IDE HDD Block Mode

This field allows your hard disk controller to use the fast block mode to transfer data to and from your hard disk drive.

IDE Primary/Secondary Master/Slave PIO

These fields allow your system hard disk controller to work faster. Rather than have the BIOS issue a series of commands that transfer to or from the disk drive, PIO (Programmed Input/Output) allows the BIOS to communicate with the controller and CPU directly.

The system supports five modes, numbered from 0 (default) to 4, which primarily differ in timing. When Auto is selected, the BIOS will select the best available mode.

IDE Primary/Secondary Master/Slave UDMA

These fields allow your system to improve disk I/O throughput to 33Mb/sec with the Ultra DMA/33 feature. The options are *Auto* and *Disabled*.

On-Chip Primary/Secondary PCI IDE

The integrated peripheral controller contains an IDE interface with support for two IDE channels. Select *Enabled* to activate each channel separately.

USB Keyboard Support

Select *Enabled* if your system contains a Universal Serial Bus (USB) controller and you have a USB keyboard.

Init AGP Display First

This field allows the system to initialize first the VGA card in the AGP slot on the motherboard when system is turned on.

Onboard FDC Controller

Select *Enabled* if your system has a floppy disk controller (FDC) installed on the system board and you wish to use it. If you install an add-in FDC or the system has no floppy drive, select *Disabled* in this field. This option allows you to select the onboard FDD port.

Onboard Serial/Parallel Port

These fields allow you to select the onboard serial and parallel ports and their addresses. The default values for these ports are:

Serial Port 1	3F8/IRQ4
Serial Port 2	2F8/IRQ3
Parallel Port	378H/IRQ7

UART Mode Select

This field determines the UART mode in your computer. The settings are *Normal*, *IrDA* and *ASKIR*. The default value is *Normal*.

Parallel Port Mode

This field allows you to determine parallel port mode function.

SPP	Normal Printer Port
EPP	Enhanced Parallel Port
ECP	Extended Capabilities Port

Supervisor / User Password

These two options set the system password. Supervisor Password sets a password that will be used to protect the system and Setup utility. User Password sets a password that will be used exclusively on the system. To specify a password, highlight the type you want and press <Enter>. The Enter Password: message prompts on the screen. Type the password, up to eight characters in length, and press <Enter>. The system confirms your password by asking you to type it again. After setting a password, the screen automatically returns to the main screen.

To disable a password, just press the <Enter> key when you are prompted to enter the password. A message will confirm the password to be disabled. Once the password is disabled, the system will boot and you can enter Setup freely.

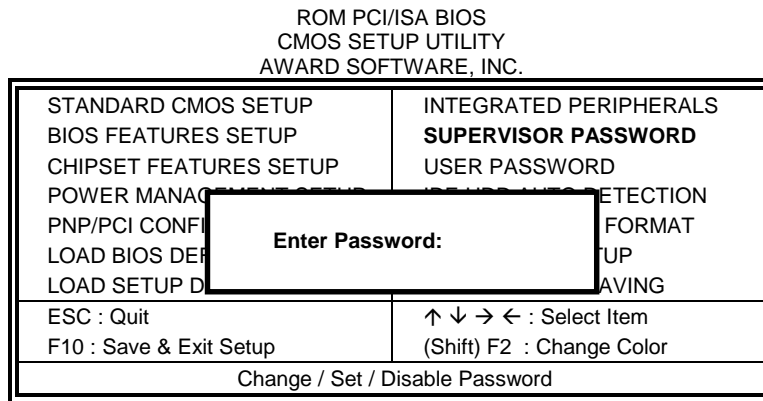

IDE HDD Auto Detection

This option detects the parameters of an IDE hard disk drive, and automatically enters them into the Standard CMOS Setup screen.

ROM PCI/ISA BIOS
STANDARD CMOS SETUP
AWARD SOFTWARE, INC.

HARD DISKS	TYPE	SIZE	CYLS	HEAD	PRECOMP	LANDZ	SECTOR	MODE
Primary Master:								
Select Primary Master Option (N=SKIP) : N								
OPTIONS 1 (Y)	TYPE 0	SIZE 0	CYLS 0	HEAD 0	PRECOMP 0	LANDZ 0	SECTOR 0	MODE NORMAL
NOTE: Some OSes (like SCO-UNIX) must use "NORMAL" for installation								
ESC: SKIP								

Up to four IDE drives can be detected, with parameters for each appearing in sequence inside a box. To accept the displayed entries, press the "Y" key; to skip to the next drive, press the "N" key. If you accept the values, the parameters will appear listed beside the drive letter on the screen.

Save & Exit Setup

This option allows you to determine whether to accept the modifications or not. If you type “Y”, you will quit the setup utility and save all changes into the CMOS memory. If you type “N”, you will return to Setup utility.

ROM PCI/ISA BIOS
CMOS SETUP UTILITY
AWARD SOFTWARE, INC.

STANDARD CMOS SETUP	INTEGRATED PERIPHERALS
BIOS FEATURES SETUP	SUPERVISOR PASSWORD
CHIPSET FEATURES SETUP	USER PASSWORD
POWER MANAGE	DETECTION
PNP/PCI CONF	Save to CMOS and Exit (Y/N)? N
LOAD BIOS DEF	AVING
LOAD SETUP DEFAULTS	
ESC : Quit	↑ ↓ → ← : Select Item
F10 : Save & Exit Setup	(Shift) F2 : Change Color
Save Data to CMOS & Exit Setup	

Exit Without Saving

Select this option to exit the Setup utility without saving the changes you have made in this session. Typing “Y” will quit the Setup utility without saving the modifications. Typing “N” will return you to Setup utility.

ROM PCI/ISA BIOS
CMOS SETUP UTILITY
AWARD SOFTWARE, INC.

STANDARD CMOS SETUP	INTEGRATED PERIPHERALS
BIOS FEATURES SETUP	SUPERVISOR PASSWORD
CHIPSET FEATURES SETUP	USER PASSWORD
POWER MANAGE	DETECTION
PNP/PCI CONF	Quit Without Saving (Y/N)? N
LOAD BIOS DEF	AVING
LOAD SETUP DEFAULTS	
ESC : Quit	↑ ↓ → ← : Select Item
F10 : Save & Exit Setup	(Shift) F2 : Change Color
Abandon all Data & Exit Setup	

4

Intel PIIX Bus Master IDE Driver Installation

This chapter describes the installation procedure for Intel PIIX Bus Master IDE Drivers for Windows 95.

This chapter contains the following sections:

System Requirements	60
Installing the Software	61

System Requirements

This section describes system requirements for the PIIX Bus Master IDE Device Driver for Windows 95*. This driver has been designed for and tested with Windows 95 only. This driver will only install on systems with Windows 95.

1. The system must contain a supported Intel processor and chipset configuration.
2. Ensure that a mouse is connected to the system.
3. One of the following versions of Windows 95* must be installed on the system prior to running utility program.

Windows 95* 4.00.950 (Retail)

Windows 95* 4.00.950a (OSR1)

Windows 95* 4.00.950b (OSR2 without USB Supplement)

Windows 95* 4.00.950b (OSR2.1 with USB Supplement)

4. This utility should only be used on desktop systems. The utility must not be executed on notebook or portable systems with or without dock.
5. It is assumed that the BIOS properly initialized the 82371xB IDE interface for Bus Master IDE operation.
6. There is no other non-82371xB IDE controllers (add-in IDE controller or sound card with IDE) enabled on the system.

Installing the Software

This subsection describes how to install the software on a system where Windows 95 is installed.

NOTE: Record the location of the Windows 95* directory before installing the driver.

1. Check the System Requirements. Windows 95* must be fully installed and running on the system prior to running this software.
2. Close any running applications.
3. Remove references to installed real-mode IDE device drivers in the AUTOEXEC.BAT and CONFIG.SYS files (especially any drivers that control ATAPI CD-ROM and special IDE features). Use the Notepad utility to do this.

The driver files are stored in an integrated application setup program. This program is a Windows 95* program that allows the driver files to be INSTALLED or DE-INSTALLED.

Execute the driver setup program.

Run SETUP.EXE.

4. Click 'Next' on Welcome Screen to read and agree to the license agreement. View the text file and choose File\Exit to close Notepad and continue. **NOTE:** If you click 'No', program will terminate.
5. Click 'Yes' if you agree to continue. **NOTE:** If you click 'No', the program will terminate.
6. Select 'INSTALL', to install the PIIX Bus Master IDE Device Driver when prompted to do so.

NOTE: If the driver is currently installed on the system, SETUP will ask you whether or not you want to continue. Follow the prompts on the screen to Install the driver if desired.

7. Click 'OK' to restart the system when prompted to do so.
8. Follow the screen instructions and use default settings to complete the setup when Windows 95* is re-started. Upon re-start, Windows 95* will display that it has found an Intel PCI Bus Master IDE controller hardware and is installing hardware for it.

If a "New Hardware Found" dialog box is displayed requesting the location of the drivers, use the mouse to click on the scrollbar and click on the <Windows 95* directory>\System\IOSubSys path:

For example:

Click on 'C:\WINDOWS\SYSTEM\IOSUBSYS'

Click 'OK'.

9. Select 'Yes', when prompted to re-start Windows 95.

NOTE: After installation, the following driver and related files are stored as listed.

<Windows 95* directory>\System\IOSubSys\IDEATAPI.MPD

<Windows 95* directory>\System\IOSubSys\PIIXVSD.VXD

<Windows 95* directory>\INF\IDEATAPI.INF

5

VGA Driver Installation Guide

This chapter describes the VGA driver installation procedure for the onboard Trident 9520/9525.

This chapter contains the following sections:

Installing Trident 9520/9525 Drivers for Windows 95.....	64
Installing Trident 9520/9525 Drivers for Windows 98.....	70
Installing Trident 9520/9525 Drivers for Windows NT	82

Installing Trident 9520/9525 Drivers for Windows 95

Step 1. In the Windows 95 screen, click Start. Select Settings, then click the Control Panel icon.

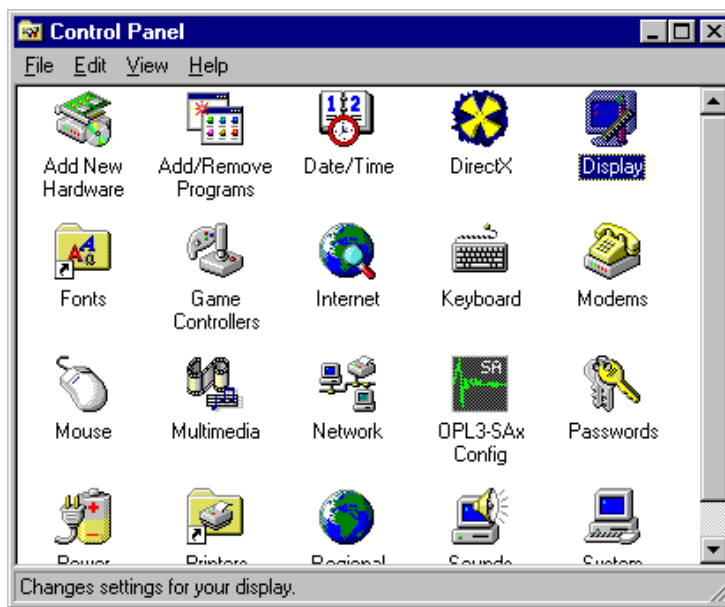
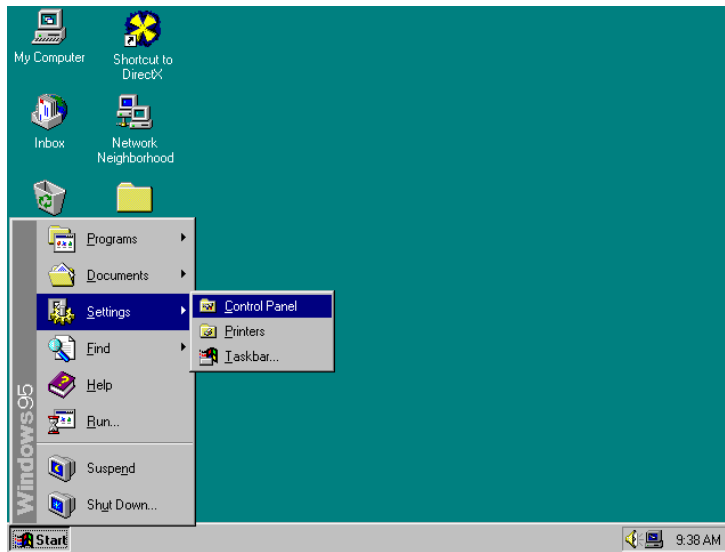

Step 2. Double click Display, then click Settings.

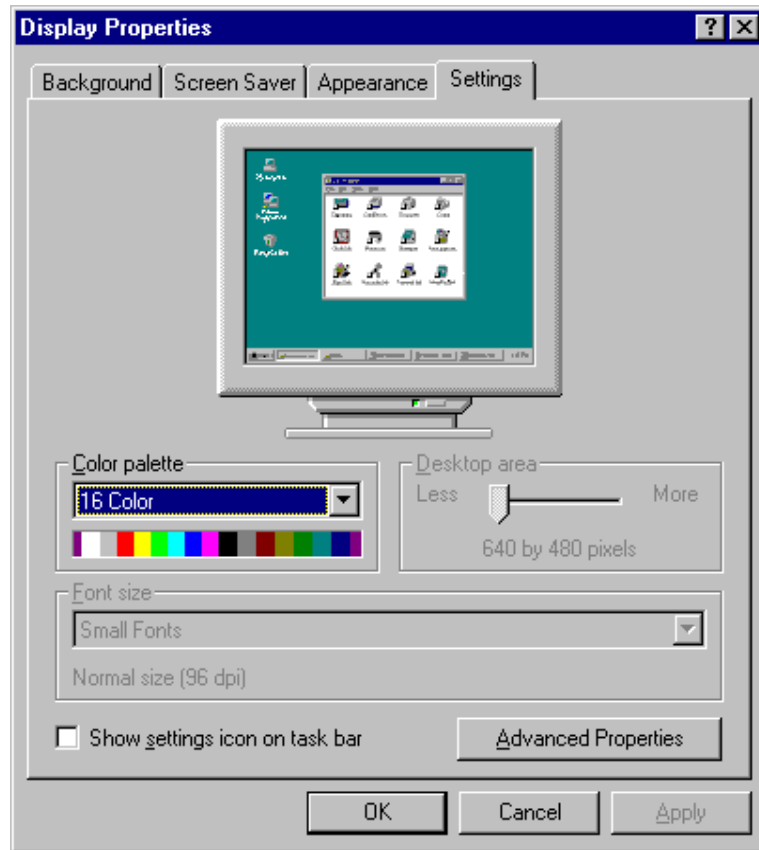

Step 3. Click Advanced Properties, then click Change....

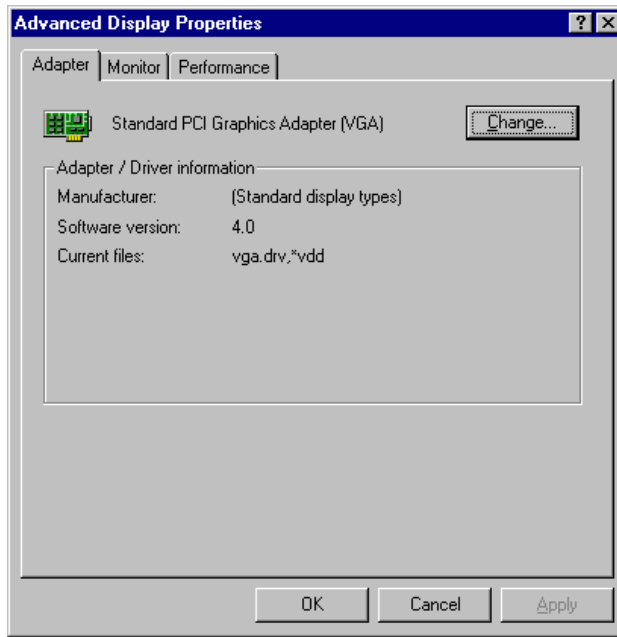

Step 4. Click Have Disk If "D:" is your CDROM, type D:\VGA\Trid9520\WIN95 or D:\VGA\Trid9525\WIN95 and click OK. If you are using floppy diskettes, type A:\ and click OK.

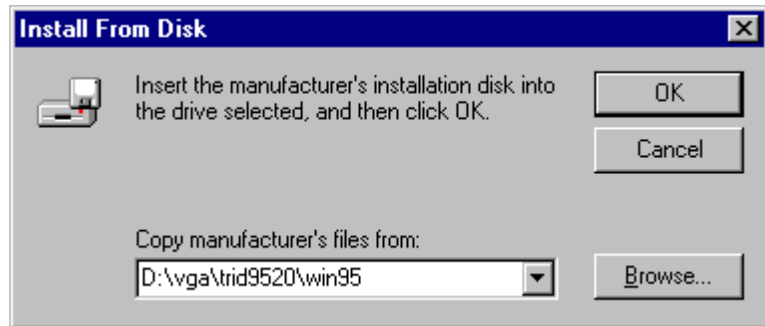
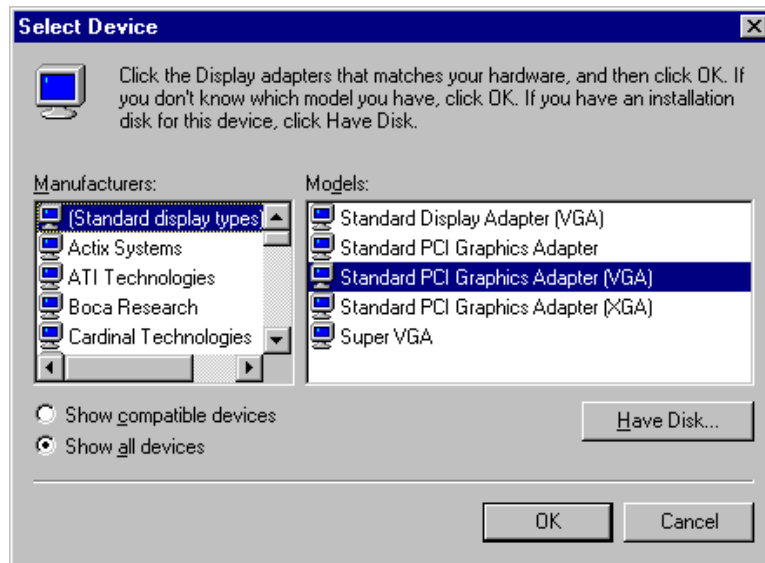

Step 5. Select Trident Cyber 9520/9525 PCI/AGP, then click OK.

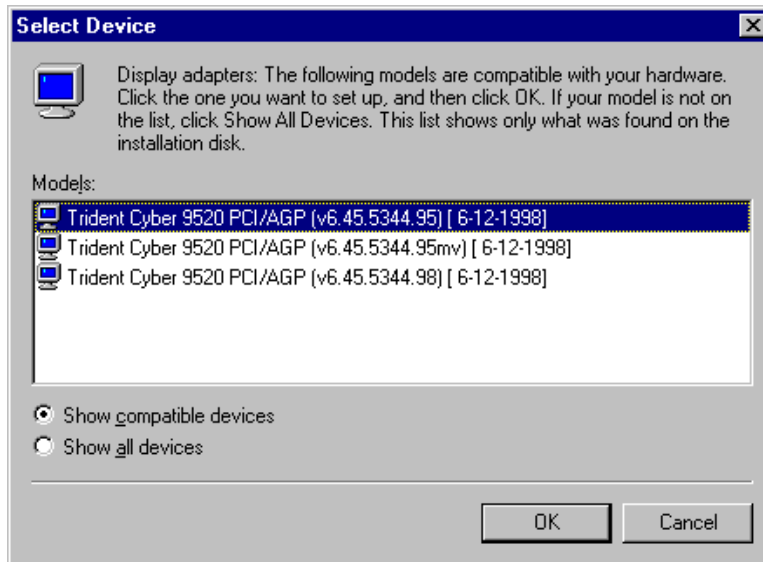

Step 6. After the files are copied, click Close.

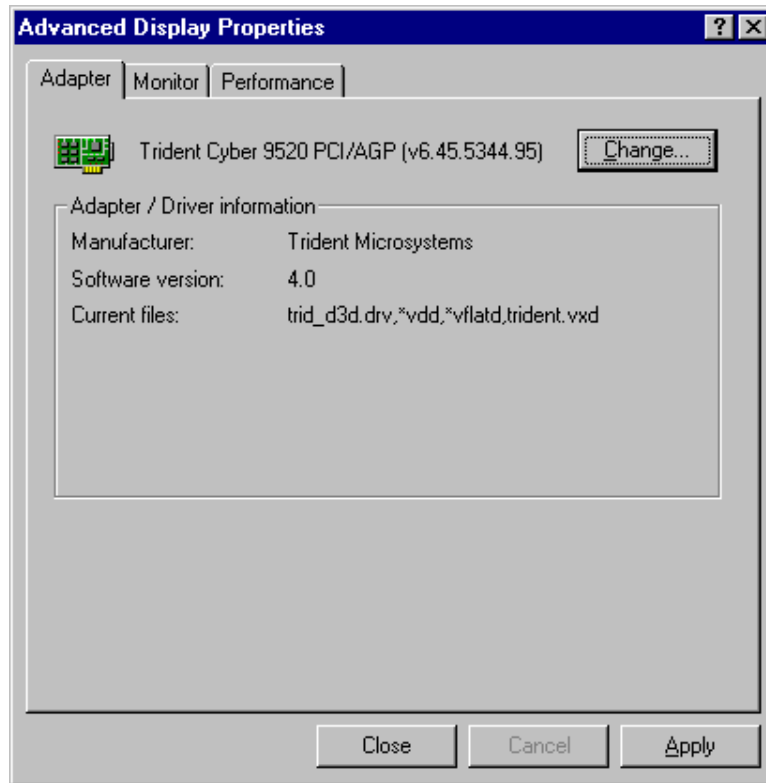

Step 7. Click Yes to restart your computer and for the new settings to

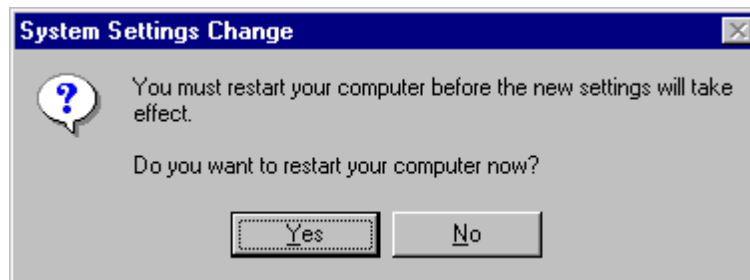

Installing Trident 9520/9525 Drivers for Windows 98

Step 1. Click Start. Select Settings, then click the Control Panel icon.

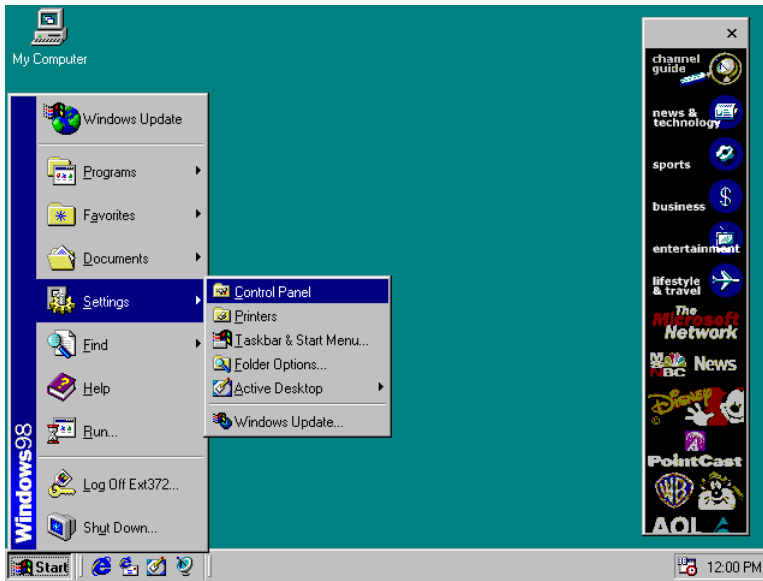

Step 2. Double click Display.

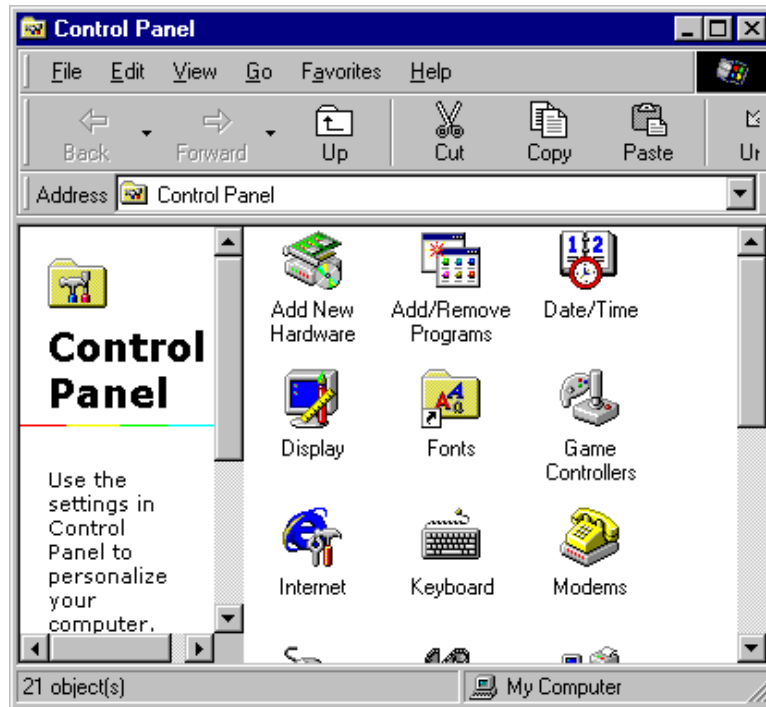

Step 3. Click Settings.

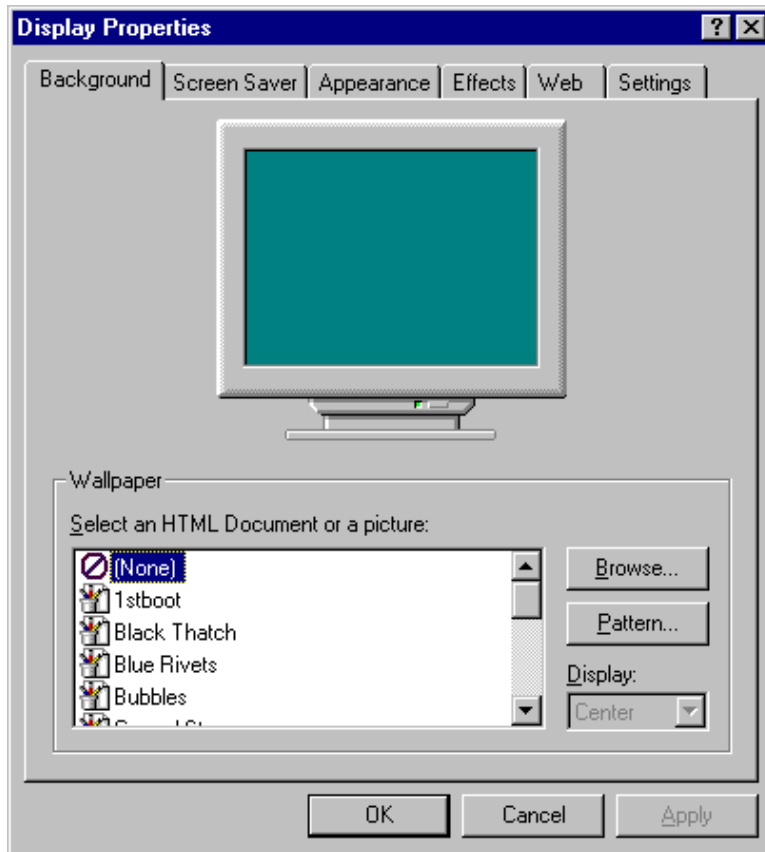

Step 4. Click Advanced.

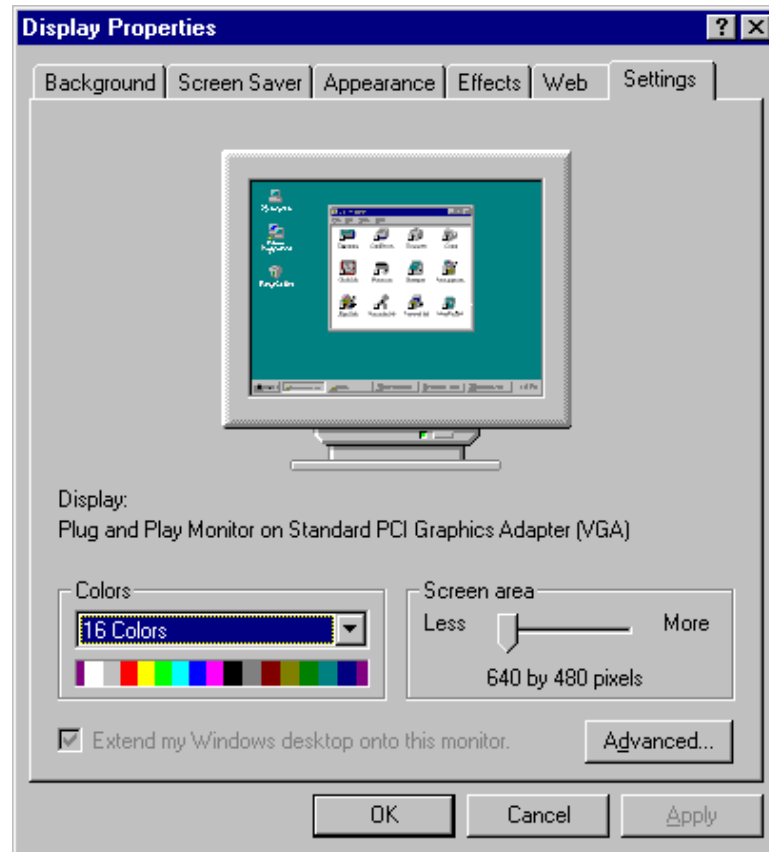

Step 5. Click Adapter.

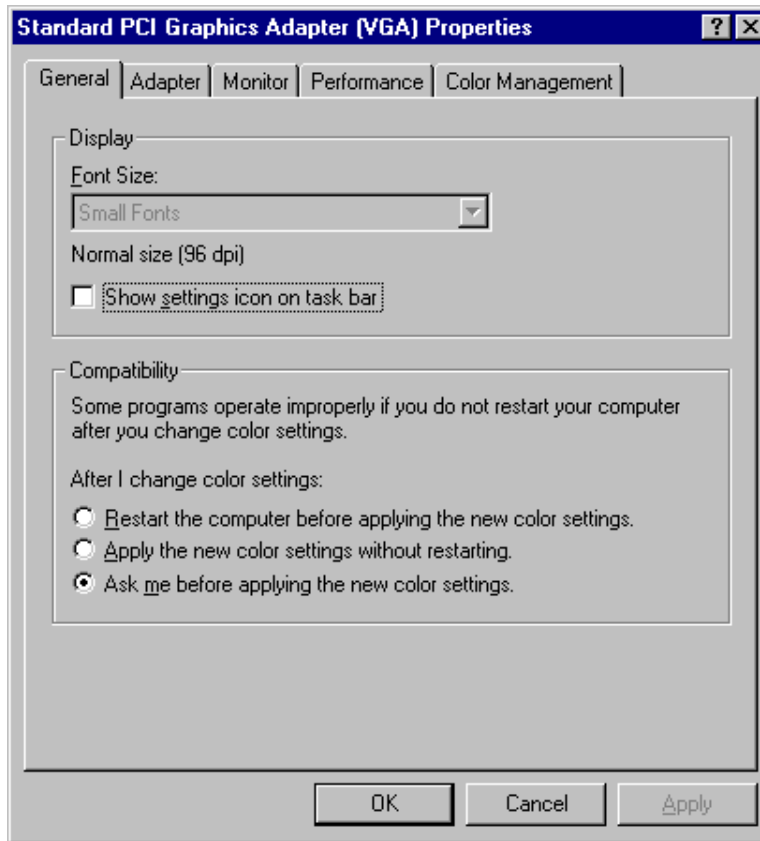

Step 6. Click Change....

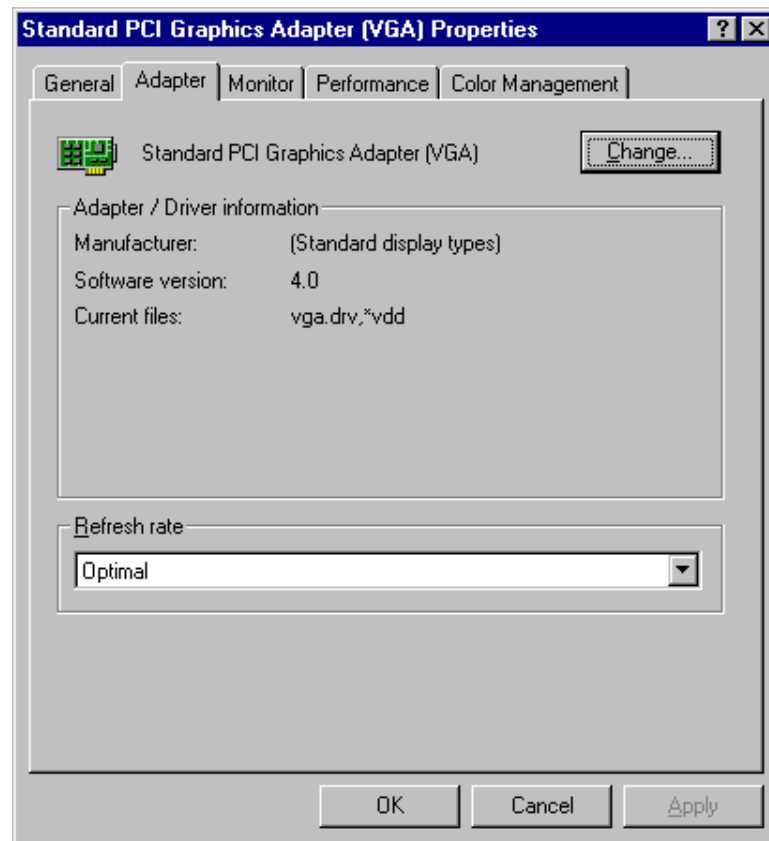

Step 7. Click Next.



Step 8. Select Display a list of all the drivers in a specific location, so you can select the driver you want."



Step 9. Click Have Disk

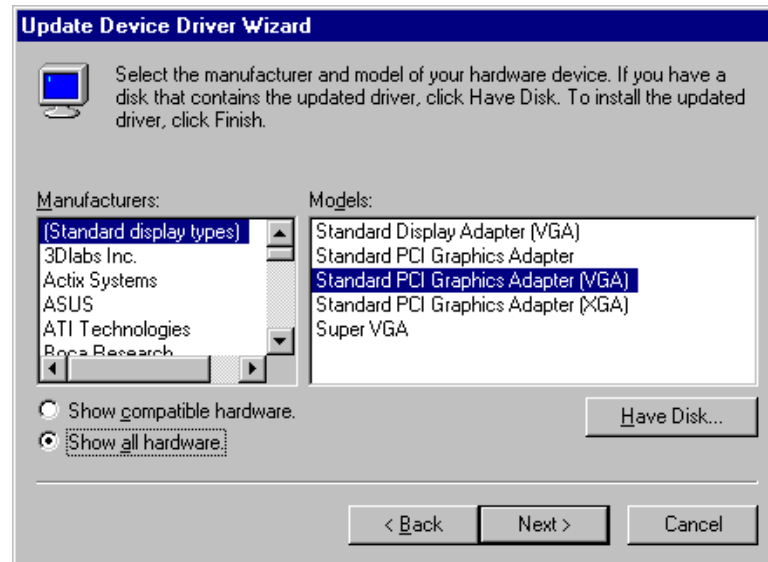

Step 10. If "D:" is your CDROM, type D:\VGA\Trid9520\WIN95 or D:\VGA\Trid9525\WIN95. If you are using floppy diskette, please type A:\ and click OK.

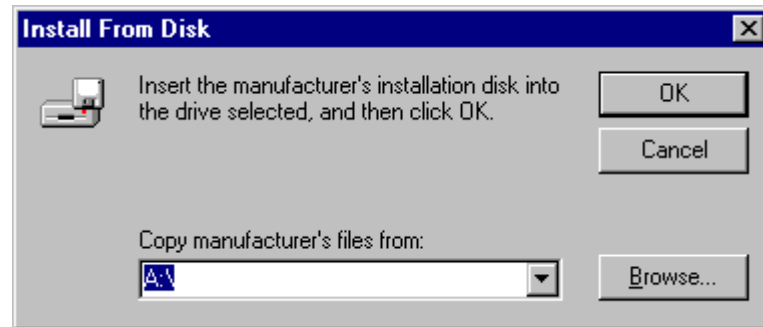

Step 11. Select Trident Cyber 9520 PCI/AGP(vx.xx.xxxx.98) or Trident Cyber 9525 PCI/AGP(vx.xx.xxxx.98), then click OK.

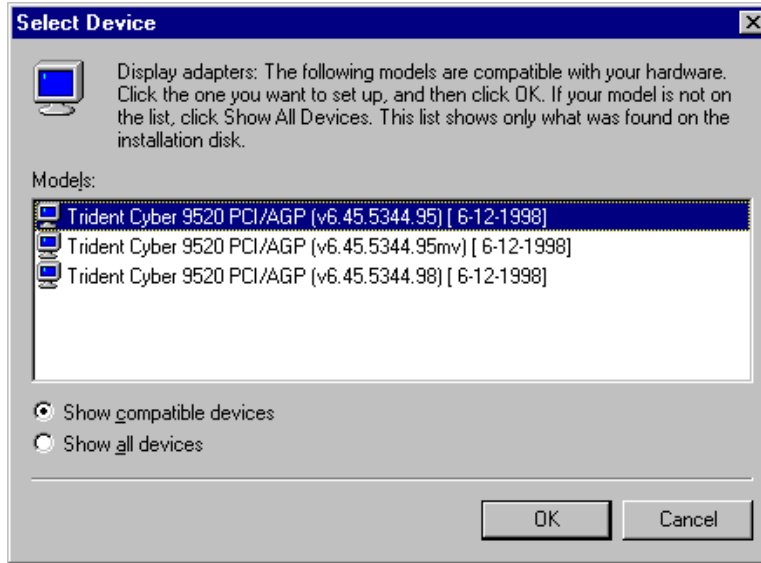

Step 12. Click Next.



Step 13. After the files are copied, click Finish.



Step 12. Click Close.

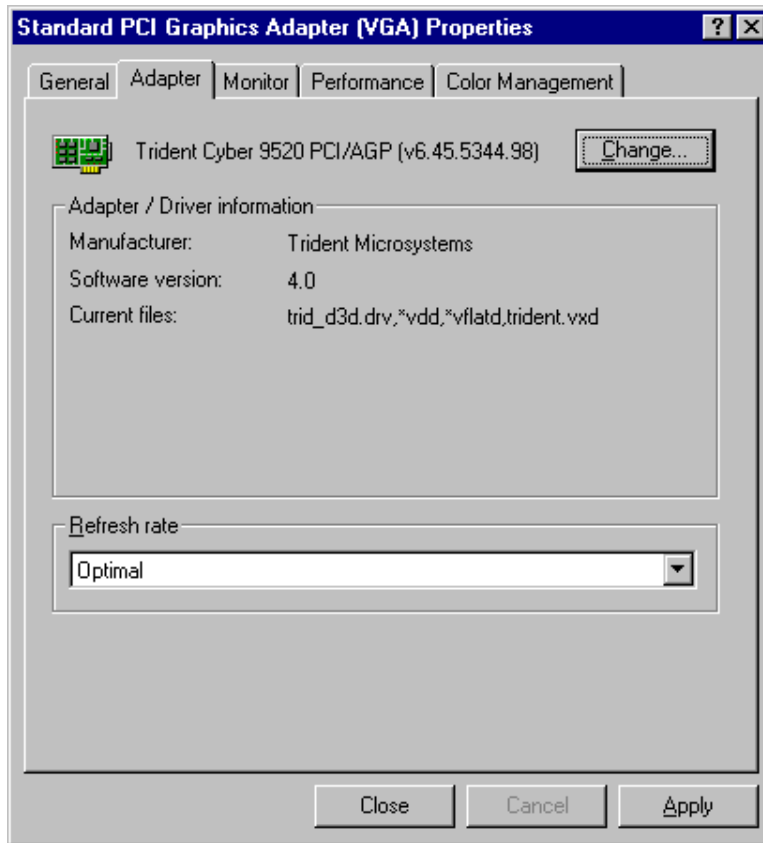

Step 13. Click Close.

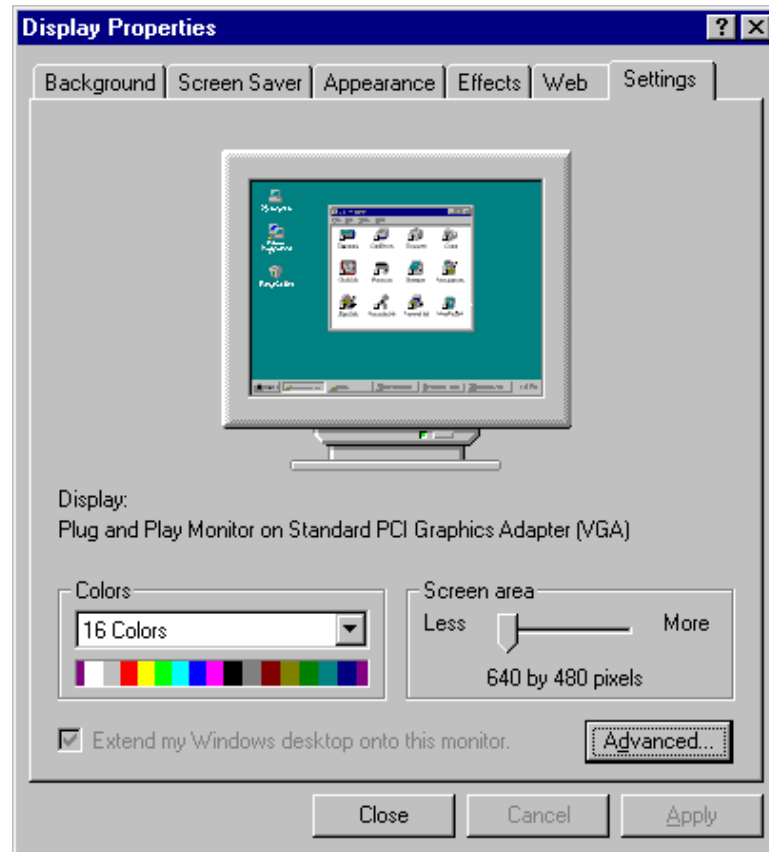

Step 14. Click Yes to restart your computer and for the new settings to take effect.

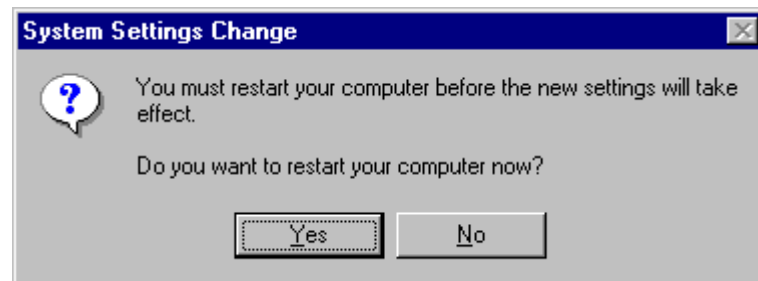

Installing Trident 9520/9525 Drivers for Windows NT

IMPORTANT: You should install the Windows NT 4.0 Service Pack 3 first before installing the Trident 9520/9525 VGA drivers. If you don't have the Windows NT 4.0 Service Pack 3, please contact your software vendor or download it from Microsoft's web site.

- Step 1. Boot Windows NT 4.0.
- Step 2. Double click the My Computer icon.
- Step 3. Double click the Control Panel icon.
- Step 4. Double click the Display icon.
- Step 5. Click Change Display Type.
- Step 6. Click Change.
- Step 7. Click Have Disk, then insert the diskette/CD containing the Trident 9520/9525 VGA Windows NT 4.0 drivers to the floppy disk drive/CD-ROM drive, then type in A:\ (if you are using drive A) or type in D:\VGA\Trid9520\WINNT40 or D:\VGA\Trid9525\WINNT40 (if you are using drive D which is your CD-ROM drive), and press Enter.
- Step 8. Select Trident Video Accelerator 3D Adapter [TW3001], then click OK.
- Step 9. Click Yes to copy the drivers from the floppy disk/CD to the hard disk.
- Step 10. When copying is done, click OK.
- Step 11. Click Close.
- Step 12. Click OK.
- Step 13. Windows NT 4.0 will prompt you to restart computer. Click OK to change the Windows NT configuration.

6

LAN Driver Installation Guide

This chapter describes LAN features and driver installation of the onboard VIA VT86C100A Ethernet controller.

This chapter contains the following sections:

Introduction	84
Features	84
Software Drivers Support	84
Running Diagnostics.....	85
Running Diagnostics.....	86

Introduction

VIA VT86C100A is a 32-bit 10/100Mbps Ethernet controller for PCI local bus-compliant PCs. It supports the bus mastering architecture, and Auto-negotiation feature which make it possible to combine one common type of Ethernet cabling – an RJ-45 connector for twisted-pair cabling that can be used for both 10Mbps and 100Mbps connection. Extensive driver support for commonly used network operating systems is also provided.

Features

- Conforms to the Ethernet IEEE 802.3u standard
- Compatible with PCI Local Bus Revision 2.1 specification
- IEEE 802.3u Auto-Negotiation for automatic speed selection
- Supports Full-Duplex/Half-Duplex Operation
- Provides 32-bit bus mastering data transfer
- Supports 10Mbps and 100Mbps operation in a single port

Software Drivers Support

NetWare ODI Drivers

Novell NetWare 3.x, 4.x, NetWare LAN WorkPlace TCP/IP, Novell LAN Analyzer for NetWare

Packet Drivers

FTP PC/TCP, NCSA TCP/IP

NDIS Drivers

Microsoft LAN Manager V2.x, Windows 3.x, Windows NT 4.0, Windows NT 3.51, Windows 98, Windows 95, SCO3, SCO5; IBM LAN Server 4.0 for DOS and OS/2; Linux,

Running Diagnostics

The CI6BMS comes with a diskette containing drivers and diagnostic software supporting the VIA VT86C100A Ethernet controller. You have to decompress the file LANDRIVE.EXE in the diskette to an empty directory in the hard drive and run SETUP in order to install the drivers and diagnostic utility to check the network cabling. You may follow the procedure below in order to do this.

1. Insert the LAN driver diskette into the floppy drive. We assume that the floppy drive is the A: Drive. Under the DOS Prompt, type the following:
MD C:\TEMPO <ENTER>
CD C:\TEMPO <ENTER>
COPY A:\LANDRIVE.EXE <ENTER>
LANDRIVE <ENTER>
SETUP <ENTER>
2. The system starts the *Setup Utility for PCI Fast Ethernet Adapter* and shows the following screen.

SETUP Utility for PCI Fast Ethernet Adapter Version 2.24 Apr 9 1998
--

Configuration	
I/O Base Address	- 0x6800
Interrupt Output Line	IRQ 11
Media Connection Type	Auto - 100M/Half
Boot ROM Size	No Boot ROM
Ethernet Address	004063001000

8. Pressing **F4** allows you to set the BootROM size. The options are:
No Boot ROM
8 K-Bytes
16 K-Bytes
32 K-Bytes
64 K-Bytes
9. Pressing **F5** allows you to configure the test count either *once* or *continuously* and start the Diagnose procedure.

10. Pressing **F5** starts the diagnostics which performs tests on the items as shown in the figure below. The screen displays **PASS** or **FAIL** to indicate the result of each test.

SETUP Utility for PCI Fast Ethernet Adapter Version 2.24 Apr 9 1998
--

Diagnose		
	PASS	FAIL
NIC registers read/write	-- 1	0
EEPROM read/write	-- 1	0
MII port registers read/write	-- 1	0
Loopback	-- 1	0
Loopback/CRC	-- 1	0
RD/TD handing	-- 1	0
MAC address match logic	-- 1	0
IRQ connect	-- 1	0
Cable link	-- 1	0

11. Pressing **F6** starts the Network test and shows the following options:
1. Master workstation (100000 packets)
 2. Master workstation (continuously)
 3. Slave workstation

Driver Installation

For the installation information of different operating systems, refer to the text files (*.TXT) in each driver subdirectory. For example, if you are installing Windows 95, please read the text file in WIN95\WIN95.TXT.

7

System Monitor Utility

This chapter introduces System Monitor Utility that comes with the motherboard in conjunction with the onboard hardware monitoring IC. The sections in the following pages give the functions of the utility.

System Monitor is a utility software that oversees the general performance of systems, covering areas like system temperature, system voltage, CPU and system fan rotational speeds. If conditions become adverse, that is, when voltages are erratic or CPU temperature exceeds the safe limits, an alarm will be sounded; thereby preventing system crashing and ensuring overall stability.

NOTE: System Monitor currently supports English and Chinese under Windows 95 and Windows NT. English will be used for other language environments.

When System Monitor is initiated, the icon below appears in the task bar in the Windows environment.



The following screen appears upon clicking on the System Monitor icon.



Clicking on the upper left corner button would show you the latest company information. "Summary" provides the current system status.

The section below describes the different functions of System Monitor.

1. Computer - displays the current working system version and processor type.

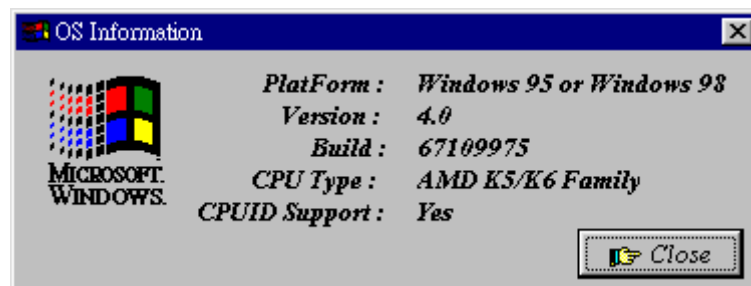

2. Power - displays the current voltage status.

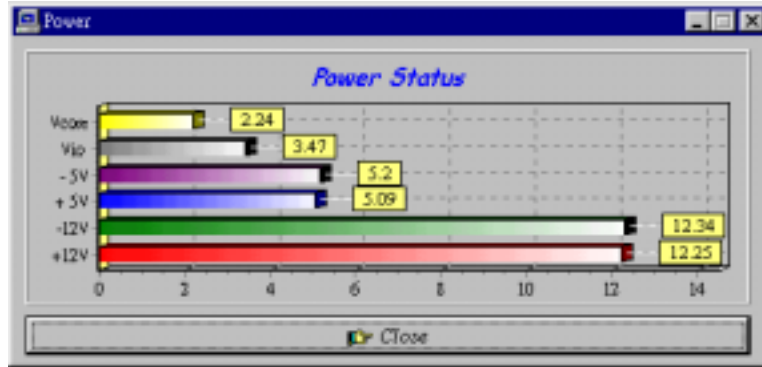

3. Memory - displays the current memory usage status.

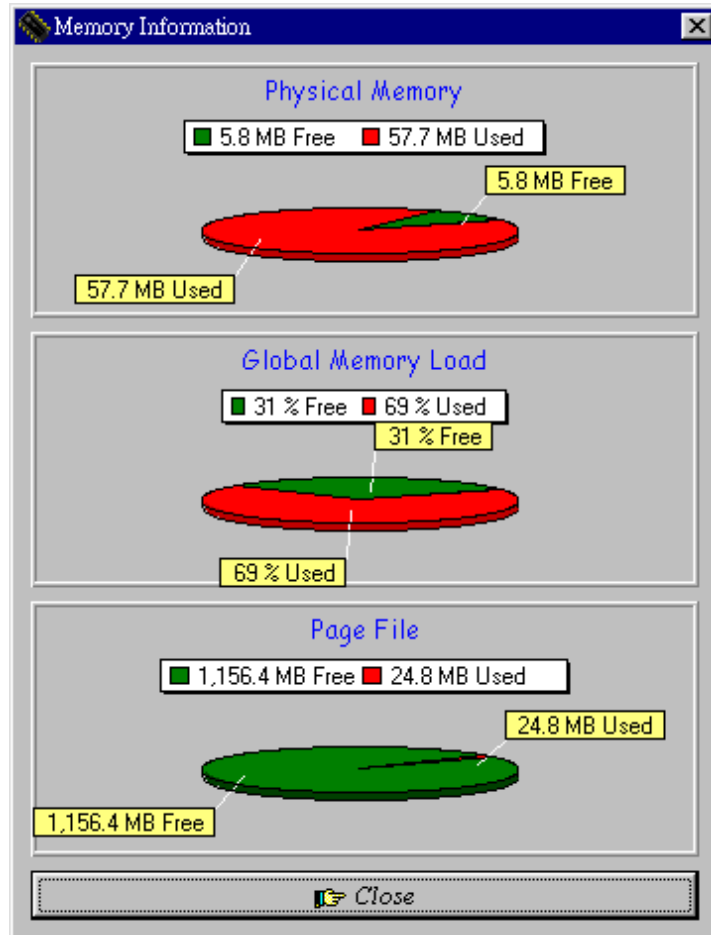

- Fan Speed - displays the current rotational speeds of CPU and Chassis fans.

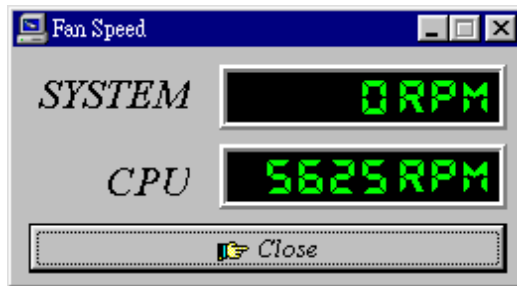

- Disk - displays the supported disk formats and disk space.

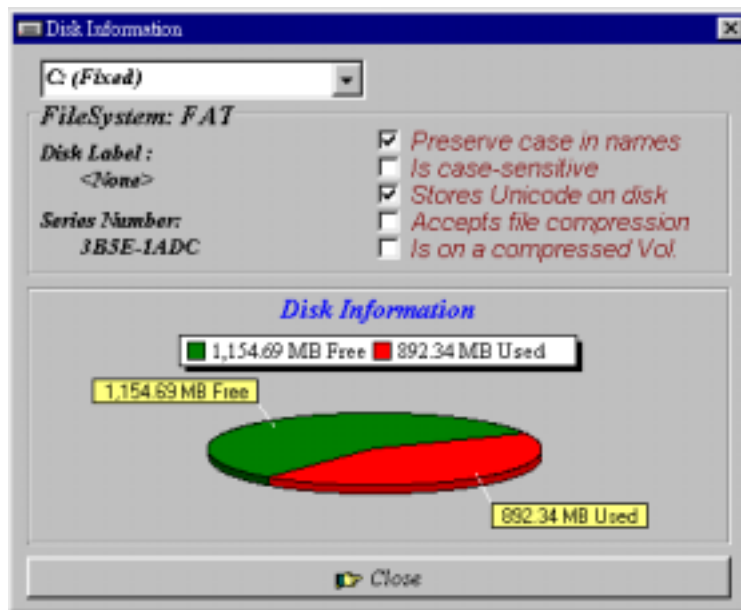

- Heat - displays the CPU and system temperatures.

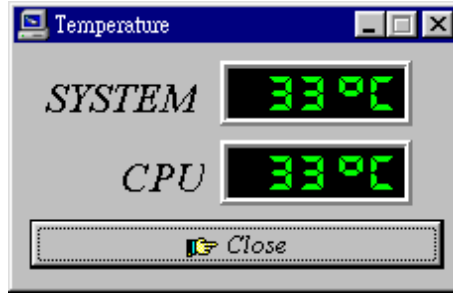

- Error Log - displays errors occurring after System Monitor is started.

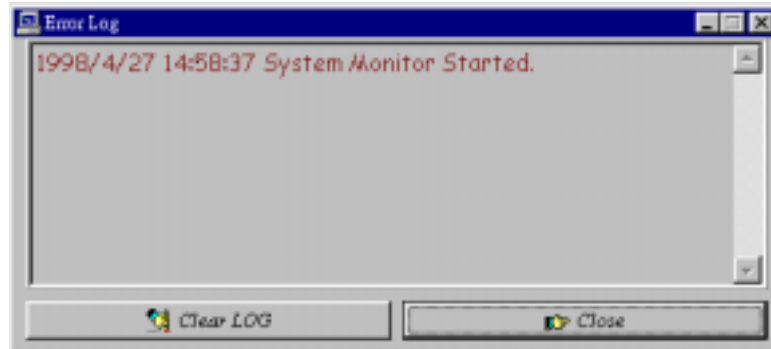

8. Setting - sets the values at which an alarm is sounded.

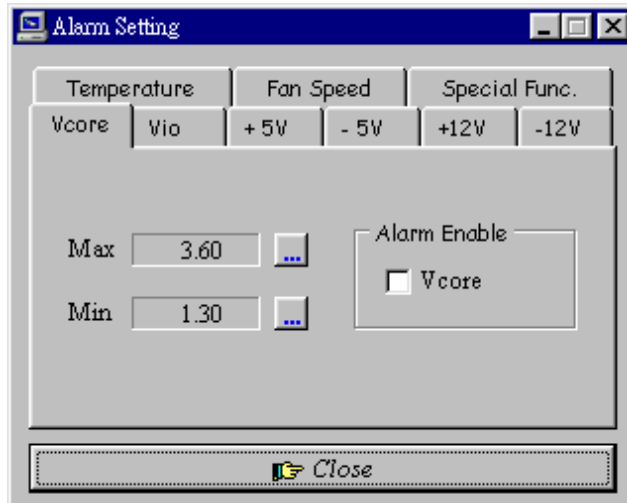

Voltage : the acceptable voltage range between the "MAX" and "MIN" value.

Temperature : temperature threshold.

Fan Rotation Speed : the minimum rotation speed.

NOTE: Intel has defined a margin of difference for the voltages as below:

12 Volts - 10% (10.8V ~ 13.2V)

5 Volts - 5% (4.75 ~ 5.25%)

Vio - 5% (Vio for P54C CPU is 3.5V. Vio for P55C is 3.3V.)

Vcore- 5%

8

LANDesk Client Manager

This chapter gives a brief introduction to the optional LANDesk® Client Manager (LDCM) utility, as well as the installation procedures.

The following items are covered in this chapter:

Introduction	96
Installation	97
Installing the Local Version of LDCM	98
Installing the Administrative Version of LDCM	100

Introduction

LANDesk Client Manager (LDCM 3.1) provides the capability for managing components (network interface cards, memory, printers, software applications, etc.) within a PC system. It uses the Desktop Management Interface (DMI) standard established by the Desktop Management Task Force (DMTF). Manageable components can be viewed, monitored, and administrated across multiple platforms, either locally or remotely on a network.

The LDCM package has been implemented in two different ways: a user (client/local) version and an administrative version (Remote Companion). The user version provides the ability to only manage the local PC. The administrative version allows a network administrator to manage the local PC and other PC nodes on the network. This means that the administrative version has the ability to gather information about remote PCs, as well as remotely controlling the PCs. The remote access is based upon granted rights by the managed client.

LDCM provides the user with self-help diagnostics, including a PC health meter, local alerting of potential problems, and hardware and software inventory. Automatic polling and alerting of memory and hardware conditions and predictive failure mechanisms minimize downtime and increase effective troubleshooting. LDCM can take periodic “snapshots” of critical configuration files for easy change management and restoration when needed.

To use LDCM, your computer must meet the following requirements:

- Operating System: Windows 95, Windows NT 3.51, or Windows NT4.0
- Memory: about 200KB
- Disk Storage Space: 3-5MB
- Hardware System: a DMI BIOS is required for full LDCM functionality

For network computers, the following requirements also apply:

- Protocols: IPX or IP (WinSock-enabled) communication protocol loaded on the client
- Hardware Interfaces: a network card for communication on the network

Installation

The optional LANDesk utility that comes with the CPU card runs in Windows NT or Windows 95 operating system.

Upon entering the Windows NT 4.0 or Windows 95 environment, insert the CD. Windows will autorun the installation program and show the following screen.

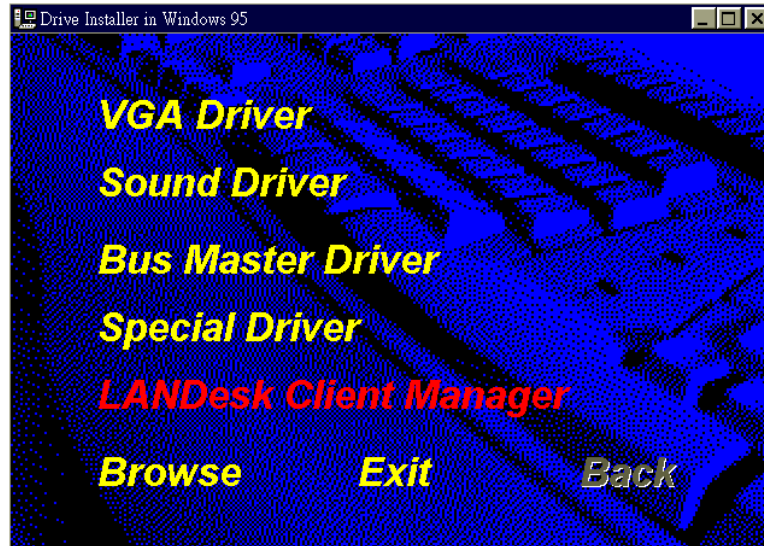

NOTE: During Setup, you will be asked to install Internet Explorer 3.02 in order to continue, or else Setup will be aborted. LDCM supports various languages and will default to English if it is unable to load 'language.dl'..

Installing the Local Version of LDCM

Double Click on 'LANdesk Client Manager' in the initial screen and the following screen will appear. Double click on the local version of LANdesk Client Manager.



When the Welcome screen appears, click on "Next" to continue with Setup.

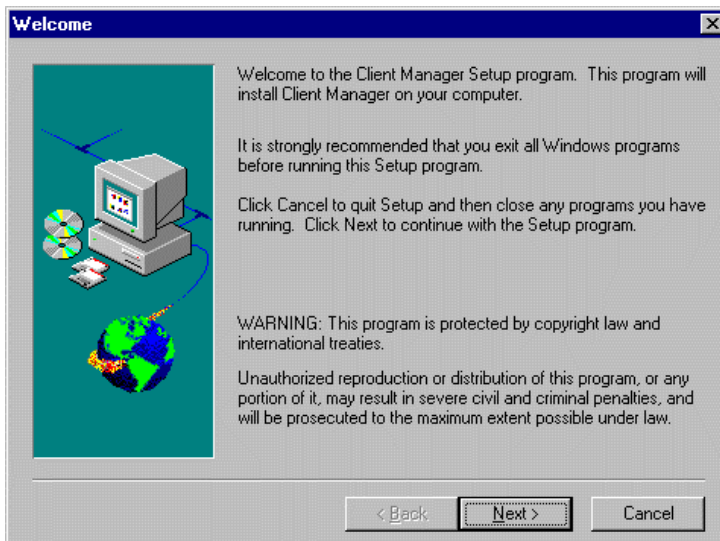

Choose the directory location where Setup will install LANdesk Client Manager. Click “Browse” if you want to change the directory suggested. Otherwise, click “Next” to start installing LDCM.

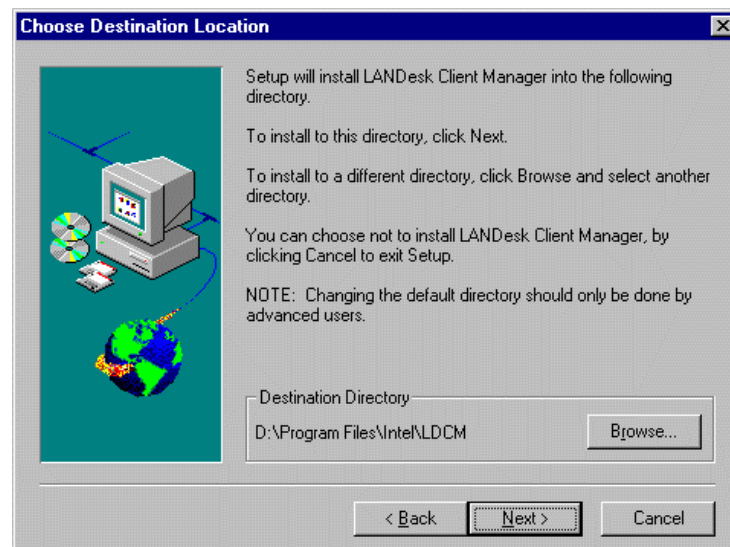

When Setup is finished, changes will have been made to the file AUTOEXEC.BAT. Restart your computer for the changes to take effect.

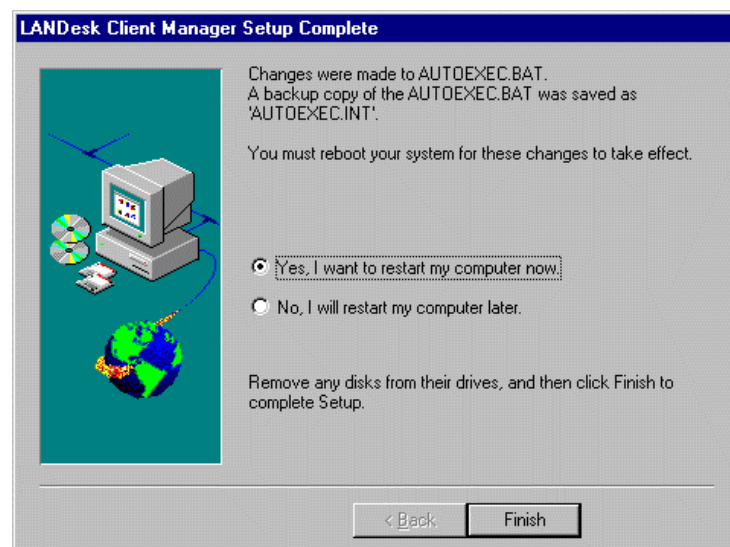

Installing the Administrative Version of LDCM

After double clicking on 'LANdesk Client Manager' in the initial screen, select the administrative version of the LDCM and the Welcome screen below will appear. Click on "Next" to continue.

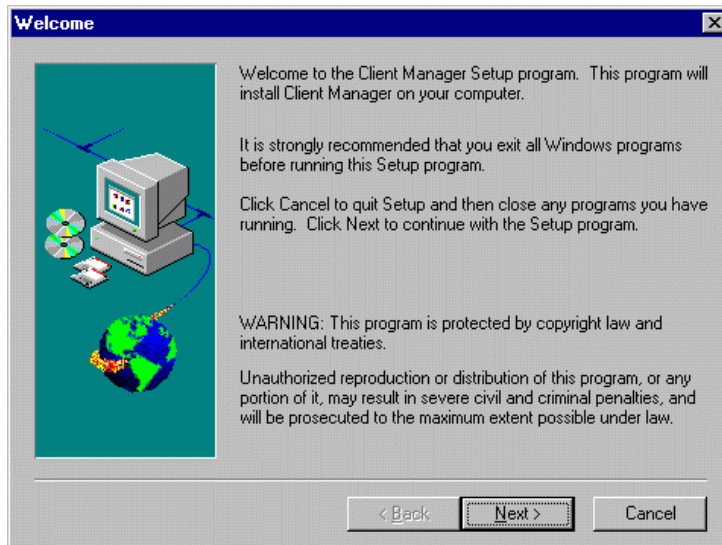

The screen below allows you to install the documentation in Adobe Acrobat format and the Adobe Acrobat Reader software. Select the options you need and click on "Next" to start the installation.

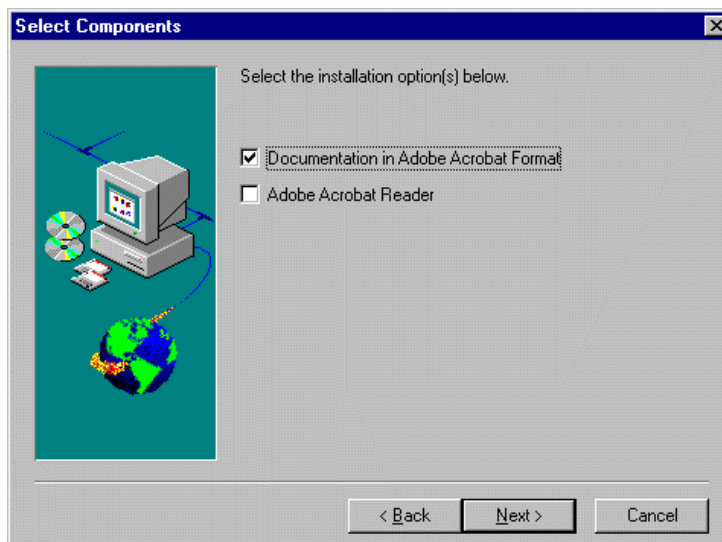

After LANDesk Client Manager Setup is complete, restart your computer to be able to use the LANDesk Client Manager.

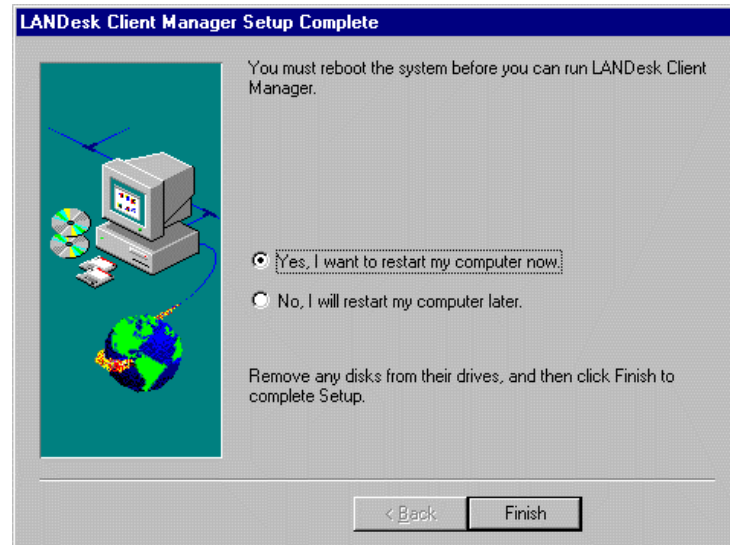

Appendix

- A. I/O Port Address Map**
- B. Interrupt Request Lines (IRQ)**
- C. Retention Mechanism**

A. I/O Port Address Map

Each peripheral device in the system is assigned a set of I/O port addresses which also becomes the identity of the device. There is a total of 1K port address space available. The following table lists the I/O port addresses used on the Industrial CPU Card.

Address	Device Description
000h - 01Fh	DMA Controller #1
020h - 03Fh	Interrupt Controller #1
040h - 05Fh	Timer
060h - 06Fh	Keyboard Controller
070h - 07Fh	Real Time Clock, NMI
080h - 09Fh	DMA Page Register
0A0h - 0BFh	Interrupt Controller #2
0C0h - 0DFh	DMA Controller #2
0F0h	Clear Math Coprocessor Busy Signal
0F1h	Reset Math Coprocessor
1F0h - 1F7h	IDE Interface
278 - 27F	Parallel Port #2(LPT2)
2F8h - 2FFh	Serial Port #2(COM2)
2B0 - 2DF	Graphics adapter Controller
378h - 3FFh	Parallel Port #1(LPT1)
360 - 36F	Network Ports
3B0 - 3BF	Monochrome & Printer adapter
3C0 - 3CF	EGA adapter
3D0 - 3DF	CGA adapter
3F0h - 3F7h	Floppy Disk Controller
3F8h - 3FFh	Serial Port #1(COM1)

B. Interrupt Request Lines (IRQ)

There are a total of 15 IRQ lines available on the Industrial CPU Card. Peripheral devices use interrupt request lines to notify CPU for the service required. The following table shows the IRQ used by the devices on the Industrial CPU Card.

Level	Function
IRQ0	System Timer Output
IRQ1	Keyboard
IRQ2	Interrupt Cascade
IRQ3	Serial Port #2
IRQ4	Serial Port #1
IRQ5	Parallel Port #2
IRQ6	Floppy Disk Controller
IRQ7	Parallel Port #1
IRQ8	Real Time Clock
IRQ9	Software Redirected to Int 0Ah
IRQ10	Reserved
IRQ11	Reserved
IRQ12	Reserved
IRQ13	80287
IRQ14	Primary IDE
IRQ15	Secondary IDE

Retention Mechanism

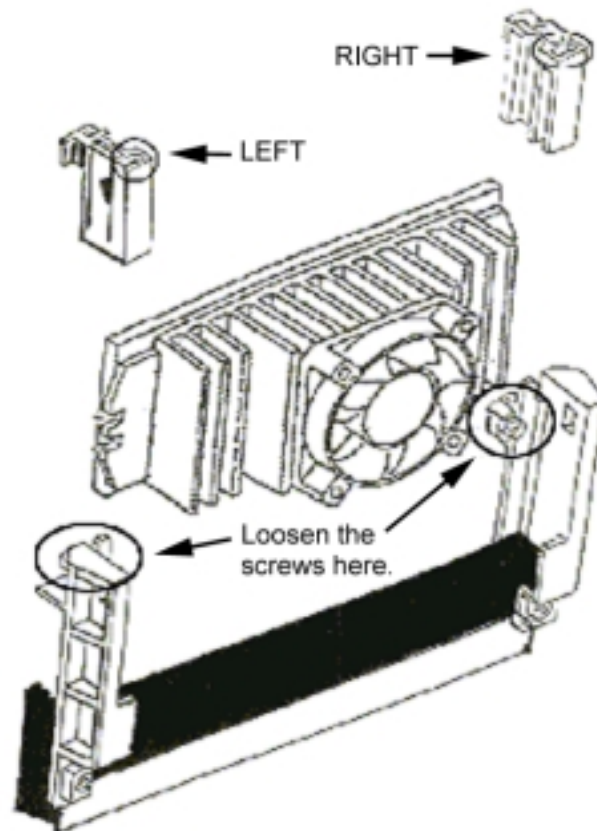

The retention mechanism that comes with the CPU card accommodates all kinds of Pentium II processors. For SECC2 (OLGA and OPGA) and SEPP types, use the two caps on both ends after installing the processor to secure the installation. SECC types do not require these caps.

When installing SECC2 and SEPP type processors, you have to loosen the two upper screws (See figure) attaching the retention mechanism to the PCB before installing and before removing the processor. Remember to fasten the screws after installation and after removal.