



# CERTIFICATE

The TÜV CERT Certification Body  
for QM Systems of RWTÜV Systems GmbH

hereby certifies in accordance with TÜV CERT  
procedure that

**ELITEGROUP COMPUTER SYSTEMS CO., LTD.  
ECS MANUFACTURING (SHENZHEN) CO., LTD.  
ELITE TECHNOLOGY (SHENZHEN) CO., LTD.**

2F, No. 240, Sec. 1, Nei Hu Road, Taipei, Taiwan 114  
No. 22, Alley 38, Lane 91, Sec. 1, Nei Hu Road, Taipei, Taiwan 114  
No. 20 & No. 26, Free Trade Zone, Shatoujiao, Shenzhen City, Guangdong Province, China

has established and applies a quality system for

**Design, Manufacturing and Sales of Mainboards,  
Personal Computers, Notebooks and Peripheral Cards**

An audit was performed, Report No. 2.5-1585/2000

Proof has been furnished that the requirements according to  
**ISO 9001 : 2000 / EN ISO 9001 : 2000 / JIS Q 9001 : 2000 / ANSI/ASQC Q9001 : 2000**

are fulfilled. The certificate is valid until 27 January 2007

Certificate Registration No. 04100 2000 1325

The company has been certified since 2000



Essen, 04.03.2004

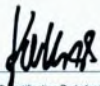

  
The TÜV CERT Certification Body for QM Systems  
of RWTÜV Systems GmbH



# ISO14001 CERTIFICATE

Certificate No.: 061-04-EI-0065-R1-L

We hereby certify that

**ECS MANUFACTURING (SHANZHEN) CO., LTD.**

by reason of its

**Environmental Management System**

has been awarded this certificate for  
compliance with the standard

**ISO14001:1996**

The Environmental Management System

applies in the following area:

**ECS MANUFACTURING (SHANZHEN) CO., LTD.**

located at No. 20 & 26 (except 1F, 2F), Free Trade Zone,

Shatuojiao, Shenzhen City, Guangdong Province, P. R. China.

is engaged in manufacturing of Mother Board and Peripheral Card,  
and interrelated managerial activities.

Date of issue: 28th Sept. 2004

Date of expiry: 27th Sept. 2007

Signed by:



**SHENZHEN SOUTHERN CERTIFICATION CO., LTD.**

## Preface

### Copyright

This publication, including all photographs, illustrations and software, is protected under international copyright laws, with all rights reserved. Neither this manual, nor any of the material contained herein, may be reproduced without written consent of the author.

Version 1.0

### Disclaimer

The information in this document is subject to change without notice. The manufacturer makes no representations or warranties with respect to the contents hereof and specifically disclaims any implied warranties of merchantability or fitness for any particular purpose. The manufacturer reserves the right to revise this publication and to make changes from time to time in the content hereof without obligation of the manufacturer to notify any person of such revision or changes.

### Trademark Recognition

Microsoft, MS-DOS and Windows are registered trademarks of Microsoft Corp.

MMX, Pentium, Pentium-II, Pentium-III, Celeron are registered trademarks of Intel Corporation.

Other product names used in this manual are the properties of their respective owners and are acknowledged.

### Federal Communications Commission (FCC)

This equipment has been tested and found to comply with the limits for a Class B digital device, pursuant to Part 15 of the FCC Rules. These limits are designed to provide reasonable protection against harmful interference in a residential installation. This equipment generates, uses, and can radiate radio frequency energy and, if not installed and used in accordance with the instructions, may cause harmful interference to radio communications. However, there is no guarantee that interference will not occur in a particular installation. If this equipment does cause harmful interference to radio or television reception, which can be determined by turning the equipment off and on, the user is encouraged to try to correct the interference by one or more of the following measures:

- Reorient or relocate the receiving antenna.
- Increase the separation between the equipment and the receiver.
- Connect the equipment onto an outlet on a circuit different from that to which the receiver is connected.
- Consult the dealer or an experienced radio/TV technician for help.

Shielded interconnect cables and a shielded AC power cable must be employed with this equipment to ensure compliance with the pertinent RF emission limits governing this device. Changes or modifications not expressly approved by the system's manufacturer could void the user's authority to operate the equipment.

## Preface

## Declaration of Conformity

This device complies with part 15 of the FCC rules. Operation is subject to the following conditions:

- This device may not cause harmful interference, and
- This device must accept any interference received, including interference that may cause undesired operation.





## Canadian Department of Communications

This class B digital apparatus meets all requirements of the Canadian Interference-causing Equipment Regulations.

Cet appareil numérique de la classe B respecte toutes les exigences du Règlement sur le matériel brouilleur du Canada.

## About the Manual

The manual consists of the following:

<b>Chapter 1</b> <b>Introducing the Motherboard</b>	Describes features of the motherboard. Go to  page 1
<b>Chapter 2</b> <b>Installing the Motherboard</b>	Describes installation of motherboard components. Go to  page 7
<b>Chapter 3</b> <b>Using BIOS</b>	Provides information on using the BIOS Setup Utility. Go to  page 23
<b>Chapter 4</b> <b>Using the Motherboard Software</b>	Describes the motherboard software Go to  page 47

## Preface

## **TABLE OF CONTENTS**

---



---

Preface	i
<b>Chapter 1</b>	<b>1</b>
<b>Introducing the Motherboard</b>	<b>1</b>
Introduction.....	1
Features.....	2
Motherboard Components.....	4
<b>Chapter 2</b>	<b>7</b>
<b>Installing the Motherboard</b>	<b>7</b>
Safety Precautions.....	7
Choosing a Computer Case.....	7
Installing the Motherboard in a Case.....	7
Checking Jumper Settings.....	8
<i>Setting Jumpers.....</i>	<i>8</i>
<i>Checking Jumper Settings.....</i>	<i>9</i>
<i>Jumper Settings.....</i>	<i>9</i>
Connecting Case Components.....	10
<i>Front Panel Header.....</i>	<i>11</i>
Installing Hardware.....	12
<i>Installing Memory Modules.....</i>	<i>12</i>
<i>Installing a Hard Disk Drive/CD-ROM/SATA Hard Drive.....</i>	<i>15</i>
<i>Installing Add-on Cards.....</i>	<i>17</i>
<i>Connecting Optional Devices.....</i>	<i>19</i>
Connecting I/O Devices.....	21
<b>Chapter 3</b>	<b>23</b>
<b>Using BIOS</b>	<b>23</b>
About the Setup Utility.....	23
<i>The Standard Configuration.....</i>	<i>23</i>
<i>Entering the Setup Utility.....</i>	<i>23</i>
<i>Updating the BIOS.....</i>	<i>25</i>
Using BIOS.....	25
<i>Standard CMOS Features.....</i>	<i>26</i>
<i>Advanced BIOS Features.....</i>	<i>28</i>

<i>Advanced Chipset Features</i> .....	31
<i>Integrated Peripherals</i> .....	34
<i>Power Management Setup</i> .....	37
<i>PNP/PCI Configurations</i> .....	41
<i>PC Health Status</i> .....	42
<i>Frequency/Voltage Control</i> .....	43
<i>Load Fail-Safe Defaults</i> .....	44
<i>Load Optimized Defaults</i> .....	44
<i>Set Supervisor/User Password</i> .....	44
<i>Save &amp; Exit Setup Option</i> .....	45
<i>Exit Without Saving</i> .....	45

<b>Chapter 4</b>	<b>47</b>
<b>Using the Motherboard Software</b>	<b>47</b>
About the Software CD-ROM.....	47
Auto-installing under Windows 98/ME/2000/XP.....	47
<i>Running Setup</i> .....	48
Manual Installation.....	50
Utility Software Reference.....	50

## **Chapter 1**

### ***Introducing the Motherboard***

---

#### **Introduction**

Thank you for choosing C7VCM2 motherboard of great performance and with enhanced function. This motherboard has onboard C7 processor with a Mini-ITX form factor of 170 x 170 mm.

The motherboard integrates the VIA CN700 Northbridges and VT8237R Plus Southbridge. The Northbridge supports a Front Side Bus (FSB) frequency of 400 MHz. The memory controller supports DDR2 memory DIMM frequencies of 533/400. It supports one DDR2 Socket with up to maximum memory of 1 GB.

The VT8237R Plus Southbridge on this motherboard supports one PCI slot which is PCI 2.2 compliant. It implements eight USB ports with data transfers up to 480 Mb/s. Two onboard IDE connectors support four IDE devices in Ultra ATA 133/100/66/33 mode. The southbridge complies with Serial ATA Specification Revision 1.0 with transfer rate up to 1.5 Gb/s per channel.

There is an advanced full set of I/O ports in the rear panel, including PS/2 ports for mouse and keyboard, one serial ports, one parallel port, one VGA port, one optional LAN port, four back-panel USB2.0 ports, and two audio jacks for microphone and line-out.

## Features

### Processor

This motherboard uses onboard C7 processor that carries the following features:

- Accommodates VIA C7 processor
- Supports a system bus (FSB) of 400 MHz

### Chipset

The CN700 Northbridge (NB) and VT8237R Plus Southbridge (SB) chipsets are based on an innovative and scalable architecture with proven reliability and performance.

- CN700(NB)**
  - Supports 400 MHz FSB VIA C7 Processor
  - Supports Host dynamic bus inversion (DBI)
  - Supports AGP v3.5 compliant 8x/4x transfer modes with Fast write
  - Supports Advanced 64-bit SDRAM controller supporting DDR2 and DDR400/333/226 SDRAM
  - Supports Integrated UniChrome Pro 3D/2D Graphics & Video Controller
- VT8237R Plus(SB)**
  - Compliant with UltraDMA-133/100/66/33 Master Mode EIDE Controller supporting four Enhanced IDE devices
  - Supports eight USB ports with data transfers up to 480 Mb/s
  - Supports AC'97 2.3 specification
  - Compliant with Serial ATA Specification Revision 1.0

### Memory

- Supports DDR2 533/400 memory bus
- Supports one Un-Buffered DIMM
- Maximum installed memory is 1 GB

### Audio

- Compliant with the AC'97 v2.3 CODEC
- Supports 6-channel audio CODEC designed for PC multimedia systems
- Provides three analog line-level stereo inputs with 5-bit volume control: LINE\_IN, CD, AUX
- Meets Microsoft WHQL/WLP 2.0 audio requirements

### Onboard LAN

The onboard LAN provides the following features:

- Supports 10/100 Mb/s N-Way Auto negotiation operation
- Half/Full duplex capability
- Supports Wake-On-LAN (WOL) function and remote wake-up

### Onboard Giga LAN (Optional)

The onboard Giga LAN provides the following features:

- Integrated 10/100/1000 transceiver
- Supports PCI v2.3, 32-bit, 33/66MHz
- Supports fully with IEEE802.3, IEEE802.3u and IEEE802.3ab

**Introducing the Motherboard**



## Expansion Options

The motherboard comes with the following expansion options:

- One 32-bit PCI slot
- Two IDE connectors which support four IDE devices
- Two 7-pin SATA connectors

The motherboard supports Ultra DMA bus mastering with transfer rates of 133/100/66/33MB/s.

## Integrated I/O

The motherboard has a full set of I/O ports and connectors:

- Two PS/2 ports for mouse and keyboard
- One serial port
- One parallel port
- One VGA port
- Four back-panel USB2.0 ports
- One LAN port (optional)
- Audio jacks for microphone and line-out

## BIOS Firmware

This motherboard uses Award BIOS that enables users to configure many system features including the following:

- Power management
- CPU parameters
- CPU and memory timing

The firmware can also be used to set parameters for different processor clock speeds.



*Some hardware specifications and software items are subject to change without prior notice.*

## Introducing the Motherboard



*Table of Motherboard Components*

<b>LABEL</b>	<b>COMPONENTS</b>
1. DDRH1	240-pin DDR2 SDRAM slot
2. ATX_POWER2	Standard 20-pin ATX power connector
3. IDE2	Secondary IDE connector
4. IDE1	Primary IDE connector
5. PANEL1	Front Panel switch/LED header
6. SATA1~2	Serial ATA connectors
7. CLR_CMOS1	Clear CMOS jumper
8. PCI1	32-bit add-on card slot
9. AUDIO1	Front panel Audio header
10. F_USB1~2	Front Panel USB headers
11. IR1	Infrared header
12. COM2	Onboard Serial port header
13. CPUFAN1	CPU cooling fan connector

This concludes Chapter 1. The next chapter explains how to install the motherboard.

**6**

***Memo***

**Introducing the Motherboard**

## **Chapter 2**

### ***Installing the Motherboard***

---

#### **Safety Precautions**

- Follow these safety precautions when installing the motherboard
- Wear a grounding strap attached to a grounded device to avoid damage from static electricity
- Discharge static electricity by touching the metal case of a safely grounded object before working on the motherboard
- Leave components in the static-proof bags they came in
- Hold all circuit boards by the edges. Do not bend circuit boards

#### **Choosing a Computer Case**

There are many types of computer cases on the market. The motherboard complies with the specifications for the Mini-ITX system case. First, some features on the motherboard are implemented by cabling connectors on the motherboard to indicators and switches on the system case. Make sure that your case supports all the features required. Secondly, this motherboard supports one or two floppy diskette drives and four enhanced IDE drives. Make sure that your case has sufficient power and space for all drives that you intend to install.

Most cases have a choice of I/O templates in the rear panel. Make sure that the I/O template in the case matches the I/O ports installed on the rear edge of the motherboard.

This motherboard carries an Mini-ITX form factor of 170 x 170 mm. Choose a case that accommodates this form factor.

#### **Installing the Motherboard in a Case**

Refer to the following illustration and instructions for installing the motherboard in a case.

Most system cases have mounting brackets installed in the case, which correspond the holes in the motherboard. Place the motherboard over the mounting brackets and secure the motherboard onto the mounting brackets with screws.

Ensure that your case has an I/O template that supports the I/O ports and expansion slots on your motherboard.

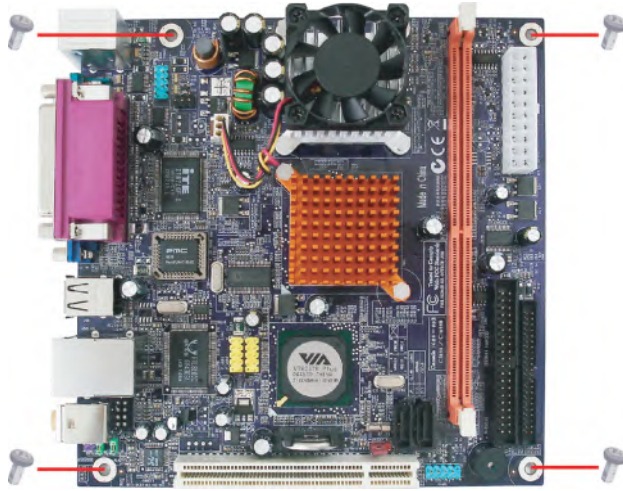

*Do not over-tighten the screws as this can stress the motherboard.*

## Checking Jumper Settings

This section explains how to set jumpers for correct configuration of the motherboard.

### *Setting Jumpers*

Use the motherboard jumpers to set system configuration options. Jumpers with more than one pin are numbered. When setting the jumpers, ensure that the jumper caps are placed on the correct pins.

The illustrations show a 2-pin jumper. When the jumper cap is placed on both pins, the jumper is **SHORT**. If you remove the jumper cap, or place the jumper cap on just one pin, the jumper is **OPEN**.



**SHORT**



**OPEN**

This illustration shows a 3-pin jumper. Pins 1 and 2 are **SHORT**.

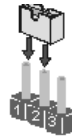

## Installing the Motherboard

### Checking Jumper Settings

The following illustration shows the location of the motherboard jumpers. Pin 1 is labeled.

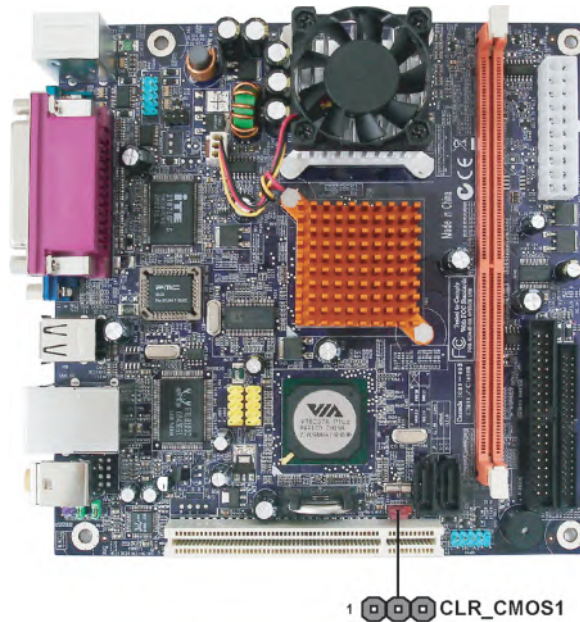

### Jumper Settings

Jumper	Type	Description	Setting (default)	
CLR_CMOS1	3-pin	CLEAR CMOS	1-2: NORMAL 2-3: CLEAR CMOS Before clearing the CMOS, make sure to turn the system off.	 CLR_CMOS1



To avoid the system instability after clearing CMOS, we recommend users to enter the main BIOS setting page to “Load Optimal Defaults” and then “Save Changes and Exit”.

## Installing the Motherboard

## Connecting Case Components

After you have installed the motherboard into a case, you can begin connecting the motherboard components. Refer to the following:

- 1 Connect the CPU cooling fan cable to **CPUFAN1**.
- 2 Connect the case switches and indicator LEDs to the **PANEL1**.
- 3 Connect the standard power supply connector to **ATX\_POWER1**.

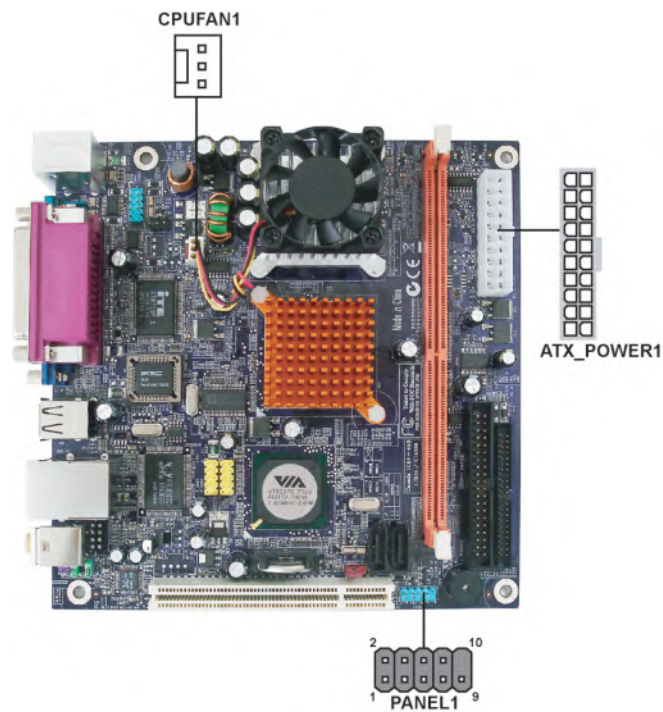

### CPU\_FAN1: FAN Power Connector

Pin	Signal Name	Function
1	GND	System Ground
2	+12V	Power +12V
3	Sense	Sensor

## Installing the Motherboard



### ATX\_POWER1: ATX 20-pin Power Connector

Pin	Signal Name	Pin	Signal Name
1	VCC3	11	VCC3
2	VCC3	12	-12V
3	GND	13	GND
4	VCC	14	PS-ON#
5	GND	15	GND
6	VCC	16	GND
7	GND	17	GND
8	PWROK	18	-5V
9	5VSB	19	VCC
10	+12V	20	VCC

### Front Panel Header

The front panel header (PANEL1) provides a standard set of switch and LED headers commonly found on ATX or micro-ATX cases. Refer to the table below for information:

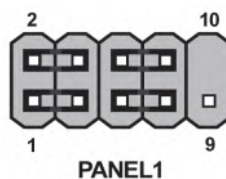

Pin	Signal Name	Function	Pin	Signal Name	Function
1	HD_LED_P	Hard Disk LED(+)	2	FP PWR/SLP	*MSG LED(+)
3	HD_LED_N	Hard disk LED(-)	4	FP PWR/SLP	*MSG LED(-)
5	RST_SW_N	Reset Switch(-)	6	PWR_SW_P	Power Switch(+)
7	RST_SW_P	Reset Switch(+)	8	PWR_SW_N	Power Switch(-)
9	RSVD_DNU	Reserved	10	Key	No pin

\* MSG LED (dual color or single color)

### Hard Drive Activity LED

Connecting pins 1 and 3 to a front panel mounted LED provides visual indication that data is being read from or written to the hard drive. For the LED to function properly, an IDE drive should be connected to the onboard IDE interface. The LED will also show activity for devices connected to the SCSI (hard drive activity LED) connector.

## Installing the Motherboard

**Power/Sleep/Message waiting LED**

Connecting pins 2 and 4 to a single or dual-color, front panel mounted LED provides power on/off, sleep, and message waiting indication.

**Reset Switch**

Supporting the reset function requires connecting pin 5 and 7 to a momentary-contact switch that is normally open. When the switch is closed, the board resets and runs POST.

**Power Switch**

Supporting the power on/off function requires connecting pins 6 and 8 to a momentary-contact switch that is normally open. The switch should maintain contact for at least 50 ms to signal the power supply to switch on or off. The time requirement is due to internal debounce circuitry. After receiving a power on/off signal, at least two seconds elapses before the power supply recognizes another on/off signal.

**Installing Hardware****Installing Memory Modules**

This motherboard accommodates one memory module. It can support one 240-pin DDR2 533/400 DDR2 SDRAM. The total memory capacity is 1 GB.

**DDR2 SDRAM memory module table**

Memory module	Memory Bus
<i>DDR2 400</i>	<i>200MHz</i>
<i>DDR2 533</i>	<i>266MHz</i>

You must install one module in the slot. The module can be installed with 1 GB; total memory capability is 1 GB.



*Do not remove any memory module from its antistatic packaging until you are ready to install it on the motherboard. Handle the modules only by their edges. Do not touch the components or metal parts. Always wear a grounding strap when you handle the modules.*

**Installing the Motherboard**

## Installation Procedure

Refer to the following to install the memory modules.

- 1 This motherboard supports unbuffered DDR2 SDRAM only.
- 2 Push the latches on each side of the DIMM slot down.
- 3 Align the memory module with the slot. The DIMM slots are keyed with notches and the DIMMs are keyed with cutouts so that they can only be installed correctly.
- 4 Check that the cutouts on the DIMM module edge connector match the notches in the DIMM slot.
- 5 Install the DIMM module into the slot and press it firmly down until it seats correctly. The slot latches are levered upwards and latch on to the edges of the DIMM.

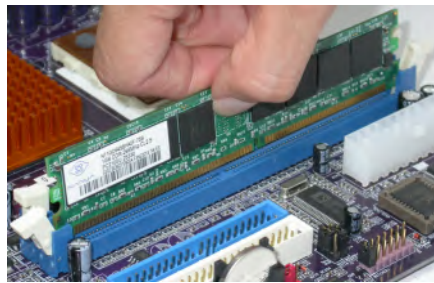

## Installing the Motherboard

**Table A: DDR2 (memory module) QVL (Qualified Vendor List)**

The following DDR2 memory modules have been tested and qualified for use with this motherboard.

Type	Size	Vendor	Module Name
DDR2 400	256 MB	Samsung	M378T3354BZ0-CCC K4T51163QB-ZCCC
	512MB	Samsung	M378T6553BG0-CCC K4T51083QB-GCCC
		TwinMos	Samsung K4T51083QB-GCCC
DDR2 533	256 MB	Corsair	Aeneon AET94F-370
		Corsair	VC256MB533D2 4PB11D9CHM
		Eipida	Eipida E2508AA-DF-E
		Eipida	Japan E2508AA-T7F-E
		Hynix	Hynix HY5PS121621
		Kingmax	Hynix HY5PS121621
		Kingston	Elpida E5116F-5C-E
		Kingston	Infineon KVR533D2N4/256 HYB18T512260AF-3.7
		Nanya	Nanya NT5TU32M16AG-37B
		Ramaxel	Elpida D5116AF-5C-E
		Ramaxel	5PB4 D9DCD
		Twinmos	Elpida 8D22IB-ED
	512MB	Corsair	Samsung K4T51083QB-ZCD5
		Corsair	VS512MB533D2 64M8CEC
		Eipida	Eipida 04180WB01
		Hynix	Hynix HY5PS12821
		Infineon	HY818T512800AF37 33346778
		Kingston	Hynix HYB18T512800AF37
		Kingston	Hynix HY5PS12821
		Kingston	Nanya NT5TU64M8AE-37B
		Ramaxel	Elpida E5108AG-5C-E
		Ramaxel	5PB32D9DCDN
		Samsung	PC2-4200U-4444-10-B1 K4T51083QF-ZCD5
		Samsung	PC2-4200U-4444-12-DS K4T51083QC
		Twinmos	Elpida E5108AB-5C-E
		Twinmos	Samsung 8D22JB-KM
		1GB	Apacer
	Apacer		K4T51083QC
	Geil		A016E2864T2AG8AKT5H120001
	Infineon		HY818T512800AF37 33344539
	Kingmax		KKEA88E4AAKG-37
	UMAX		U2S12D30TP-5C

## Installing the Motherboard

### ***Installing a Hard Disk Drive/CD-ROM/SATA Hard Drive***

This section describes how to install IDE devices such as a hard disk drive and a CD-ROM drive.

#### **About IDE Devices**

Your motherboard has a primary and secondary IDE channel interface (IDE1 and IDE2). An IDE ribbon cable supporting two IDE devices is bundled with the motherboard.



*You must orient the cable connector so that the pin1 (color) edge of the cable corresponds to the pin 1 of the I/O port connector.*

#### **IDE1: Primary IDE Connector**

The first hard drive should always be connected to IDE1.

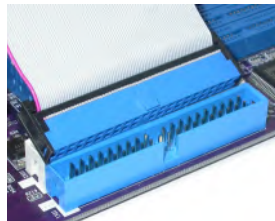

#### **IDE2: Secondary IDE Connector**

The second drive on this controller must be set to slave mode. The configuration is the same as IDE1.

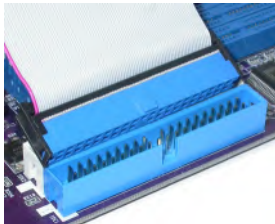

IDE devices enclose jumpers or switches used to set the IDE device as MASTER or SLAVE. Refer to the IDE device user's manual. Installing two IDE devices on one cable, ensure that one device is set to MASTER and the other device is set to SLAVE. The documentation of your IDE device explains how to do this.

#### **About UltraDMA**

This motherboard supports UltraDMA 133/100/66/33. UDMA is a technology that accelerates the performance of devices in the IDE channel. To maximize performance, install IDE devices that support UDMA and use 80-pin IDE cables that support UDMA 133/100/66/33.

## **Installing the Motherboard**

### About SATA Connectors

Your motherboard features two SATA connectors supporting a total of two drives. SATA refers to Serial ATA (Advanced Technology Attachment) is the standard interface for the IDE hard drives which are currently used in most PCs. These connectors are well designed and will only fit in one orientation. Locate the SATA connectors on the motherboard and follow the illustration below to install the SATA hard drives.

### Installing Serial ATA Hard Drives

To install the Serial ATA (SATA) hard drives, use the SATA cable that supports the Serial ATA protocol. This SATA cable comes with an SATA power cable. You can connect either end of the SATA cable to the SATA hard drive or the connector on the motherboard.



**SATA cable** (optional)



**SATA power cable** (optional)

Refer to the illustration below for proper installation:

- 1 Attach either cable end to the connector on the motherboard.
- 2 Attach the other cable end to the SATA hard drive.
- 3 Attach the SATA power cable to the SATA hard drive and connect the other end to the power supply.



*This motherboard does not support the "Hot-Plug" function.*

## Installing the Motherboard

### *Installing Add-on Cards*

The slots on this motherboard are designed to hold expansion cards and connect them to the system bus. Expansion slots are a means of adding or enhancing the motherboard's features and capabilities. With these efficient facilities, you can increase the motherboard's capabilities by adding hardware that performs tasks that are not part of the basic system.

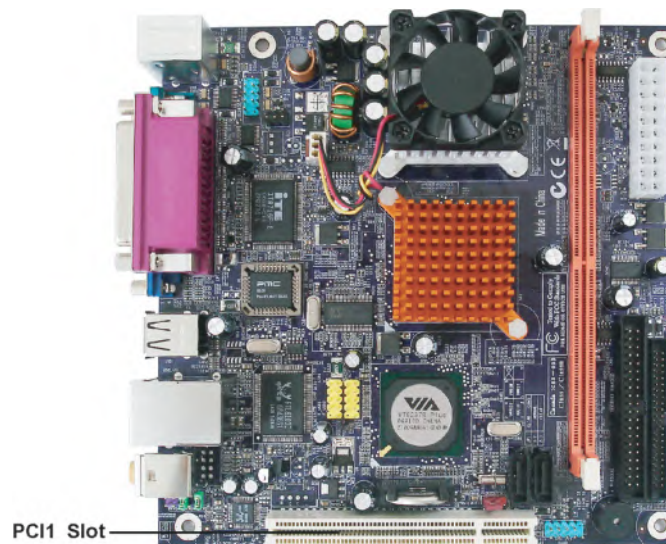

**PCI1 Slot** This motherboard is equipped with one PCI slot. PCI stands for Peripheral Component Interconnect and is a bus standard for expansion cards, which for the most part, is a supplement of the older ISA bus standard. The PCI slot on this board is PCI v2.2 compliant.



*Before installing an add-on card, check the documentation for the card carefully. If the card is not Plug and Play, you may have to manually configure the card before installation.*

## **Installing the Motherboard**

Follow these instructions to install an add-on card:

- 1 Remove a blanking plate from the system case corresponding to the slot you are going to use.
- 2 Install the edge connector of the add-on card into the expansion slot. Ensure that the edge connector is correctly seated in the slot.
- 3 Secure the metal bracket of the card to the system case with a screw.

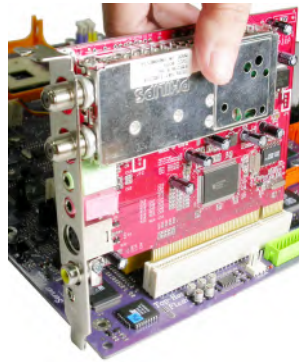

*For some add-on cards, for example graphics adapters and network adapters, you have to install drivers and software before you can begin using the add-on card.*

## Installing the Motherboard



### Connecting Optional Devices

Refer to the following for information on connecting the motherboard's optional devices:

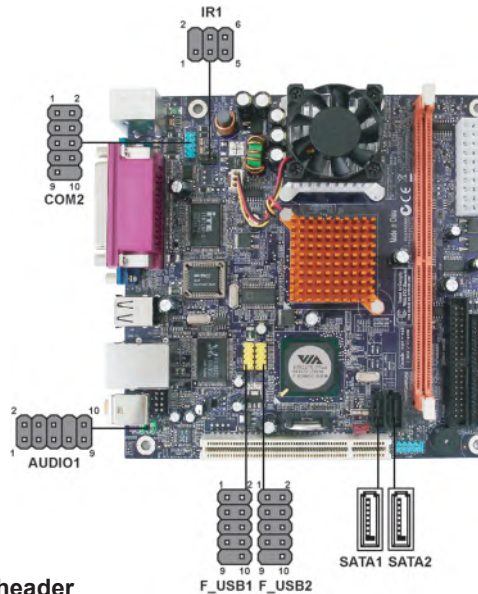

#### IR1: Infrared header

Pin	Signal Name	Function
1	Not Assigned	Not assigned
2	Key	No pin
3	+5V	IR Power
4	GND	Ground
5	IR_TX	IrDA serial output
6	IR_RX	IrDA serial input

#### COM2: Onboard serial port header

Connect a serial port extension bracket to this header to add a second serial port to your system.

Pin	Signal Name	Function
1	NDCDC/NDCDD	Data Carrier Detect
2	NSINC/NSIND	Serial Input
3	NSOUTC/NSOUTD	UART B Serial Output
4	NDTRC/NDTRD	UART B Data Terminal Ready
5	Ground	Ground
6	NDSRC/NDSRD	Data Set Ready
7	NRTSC/NRTSD	RART B Request to Send
8	NCTSC/NCTSD	Clear to Send
9	XNRI3/XNRI4	Ring Indicator
10	Key	No pin

**AUDIO1: Front Panel Audio header**

This header allows the user to install auxiliary front-oriented microphone and line-out ports for easier access.

Pin	Signal Name	Function
1	AUD_MIC	Front Panel Microphone input signal
2	AUD_GND	Ground used by Analog Audio Circuits
3	AUD_MIC_BIAS	Microphone Power
4	AUD_VCC	Filtered +5V used by Analog Audio Circuits
5	AUD_FPOUT_R	Right Channel Audio signal to Front Panel
6	AUD_RET_R	Right Channel Audio signal to Return from Front Panel
7	HP_ON	Reserved
8	Key	No Pin
9	AUD_FPOUT_L	Left Channel Audio signal to Front Panel
10	AUD_RET_L	Left Channel Audio signal to Return from Front Panel

**F\_USB1/2: Front Panel USB headers**

The motherboard has four USB ports installed on the rear edge I/O port array. Additionally, some computer cases have USB ports at the front of the case. If you have this kind of case, use auxiliary USB connector to connect the front-mounted ports to the motherboard.

Pin	Signal Name	Function
1	VCC	Power
2	VCC	Power
3	USBP2-N	Negative data signal of
4	USBP3-N	Positive data signal of
5	USBP2-P	Positive data signal of
6	USBP3-P	Negative data signal of
7	GND	System
8	GND	System
9	Key	No pin
10	OC#	Over current detection of



*Please make sure that the USB cable has the same pin assignment as indicated above. A different pin assignment may cause damage or system hang-up.*

**SATA1/2: Serial ATA connectors**

These connectors are used to support the new Serial ATA devices for the highest data transfer rates (1.5 Gb/s), simpler disk drive cabling and easier PC assembly. It eliminates limitations of the current Parallel ATA interface. But maintains register compatibility and software compatibility with Parallel ATA.

Pin	Signal Name	Pin	Signal Name
1	Ground	2	TX+
3	TX-	4	Ground
5	RX-	6	RX+
7	Ground	-	-

## Installing the Motherboard

## Connecting I/O Devices

The backplane of the motherboard has the following I/O ports:

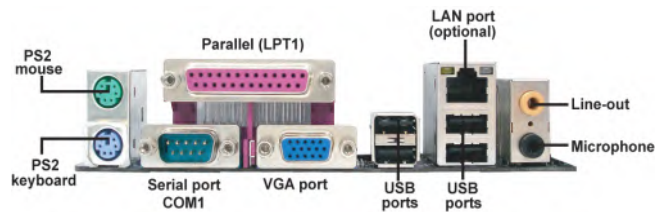

- PS2 Mouse** Use the upper PS/2 port to connect a PS/2 pointing device.
- PS2 Keyboard** Use the lower PS/2 port to connect a PS/2 keyboard.
- Parallel Port (LPT1)** Use the LPT1 to connect printer or other parallel communications devices.
- Serial Ports (COM1)** Use the COM ports to connect serial devices such as mice or fax/modems.
- VGA Port** Connect your monitor to the VGA port.
- LAN Port (optional)** Connect an RJ-45 jack to the LAN port to connect your computer to the Network.
- USB Ports** Use the USB ports to connect USB devices.
- Audio Ports** Use the two audio ports to connect audio devices. The first jack is for stereo line-out signal. The second jack is for microphone.

This concludes Chapter 2. The next chapter covers the BIOS.

## Installing the Motherboard

***Memo***

**Installing the Motherboard**

## **Chapter 3**

### ***Using BIOS***

---

#### **About the Setup Utility**

The computer uses the latest Award BIOS with support for Windows Plug and Play. The CMOS chip on the motherboard contains the ROM setup instructions for configuring the motherboard BIOS.

The BIOS (Basic Input and Output System) Setup Utility displays the system's configuration status and provides you with options to set system parameters. The parameters are stored in battery-backed-up CMOS RAM that saves this information when the power is turned off. When the system is turned back on, the system is configured with the values you stored in CMOS.

The BIOS Setup Utility enables you to configure:

- Hard drives, diskette drives and peripherals
- Video display type and display options
- Password protection from unauthorized use
- Power Management features

The settings made in the Setup Utility affect how the computer performs. Before using the Setup Utility, ensure that you understand the Setup Utility options.

This chapter provides explanations for Setup Utility options.

#### ***The Standard Configuration***

A standard configuration has already been set in the Setup Utility. However, we recommend that you read this chapter in case you need to make any changes in the future.

This Setup Utility should be used:

- when changing the system configuration
- when a configuration error is detected and you are prompted to make changes to the Setup Utility
- when trying to resolve IRQ conflicts
- when making changes to the Power Management configuration
- when changing the password or making other changes to the Security Setup

#### ***Entering the Setup Utility***

When you power on the system, BIOS enters the Power-On Self Test (POST) routines. POST is a series of built-in diagnostics performed by the BIOS. After the POST routines are completed, the following message appears:

**Press DEL to enter SETUP**

Pressing the delete key accesses the BIOS Setup Utility:

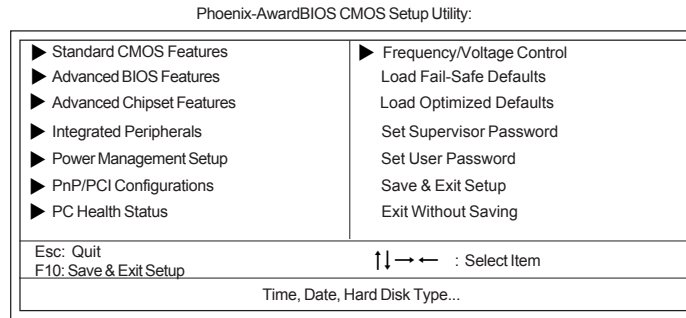
***BIOS Navigation Keys***

The BIOS navigation keys are listed below:

KEY	FUNCTION
←↑↓→	Move
Enter	Select
+/-/PU/PD	Value
ESC	Exits the current menu
F1	General Help
F2	Item Help
F5	Previous Values
F6	Fail-Safe Defaults
F7	Optimized Defaults
F10	Save

## Using BIOS

### ***Updating the BIOS***

You can download and install updated BIOS for this motherboard from the manufacturer's Web site. New BIOS provides support for new peripherals, improvements in performance, or fixes for known bugs. Install new BIOS as follows:

- 1 If your motherboard has a BIOS protection jumper, change the setting to allow BIOS flashing.
- 2 If your motherboard has an item called Firmware Write Protect in Advanced BIOS features, disable it. (Firmware Write Protect prevents BIOS from being overwritten.)
- 3 Create a bootable system disk. (Refer to Windows online help for information on creating a bootable system disk.)
- 4 Download the Flash Utility and new BIOS file from the manufacturer's Web site. Copy these files to the system diskette you created in Step 3.
- 5 Turn off your computer and insert the system diskette in your computer's diskette drive. (You might need to run the Setup Utility and change the boot priority items on the Advanced BIOS Features Setup page, to force your computer to boot from the floppy diskette drive first.)
- 6 At the A:\ prompt, type the Flash Utility program name and press <Enter>.
- 7 Type the filename of the new BIOS in the "File Name to Program" text box. Follow the onscreen directions to update the motherboard BIOS.
- 8 When the installation is complete, remove the floppy diskette from the diskette drive and restart your computer. If your motherboard has a Flash BIOS jumper, reset the jumper to protect the newly installed BIOS from being overwritten.

### **Using BIOS**

When you start the Setup Utility, the main menu appears. The main menu of the Setup Utility displays a list of the options that are available. A highlight indicates which option is currently selected. Use the cursor arrow keys to move the highlight to other options. When an option is highlighted, execute the option by pressing <Enter>.

Some options lead to pop-up dialog boxes that prompt you to verify that you wish to execute that option. Other options lead to dialog boxes that prompt you for information.

Some options (marked with a triangle ►) lead to submenus that enable you to change the values for the option. Use the cursor arrow keys to scroll through the items in the submenu.

In this manual, default values are enclosed in parenthesis. Submenu items are denoted by a triangle ►.

## **Using BIOS**

### Standard CMOS Features

This option displays basic information about your system.

Phoenix-AwardBIOS CMOS Setup Utility  
Standard CMOS Features

Date (mm:dd:yy)	Wed, Jan 1 2003	Item Help
Time (hh:mm:ss)	0 : 1 : 0	
▶ IDE Channel 0 Master	[ST3802110A]	Menu Level ▶ Change the day, month, year and century
▶ IDE Channel 0 Slave	[None]	
▶ IDE Channel 1 Master	[None]	
▶ IDE Channel 1 Slave	[None]	
▶ IDE Channel 2 Master	[None]	
▶ IDE Channel 2 Slave	[None]	
▶ IDE Channel 3 Master	[None]	
Video	[EGA/VGA]	
Halt On	[All,But Keyboard]	
Base Memory	640K	
Extended Memory	194560K	
Total Memory	195584K	

↑↓ → ← : Move Enter: Select +/-/PU/PD:Value F10:Save ESC:Exit F1:General Help  
F5:Previous Values F6:Fail-Safe Defaults F7:Optimized Defaults

#### Date and Time

The Date and Time items show the current date and time on the computer. If you are running a Windows OS, these items are automatically updated whenever you make changes to the Windows Date and Time Properties utility.

#### ▶ IDE Devices (None)

Your computer has two IDE channels (Primary and Secondary) and each channel can be installed with one or two devices (Master and Slave). Use these items to configure each device on the IDE channel.

Press <Enter> to display the IDE submenu:

Phoenix-AwardBIOS CMOS Setup Utility  
IDE Channel 0 Master

IDE HDD Auto-Detection	[Press Enter]	Item Help
IDE Channel 0 Master Access Mode	[Auto]	
Capacity	80 GB	Menu Level ▶▶ To auto-detect the HDD's size, head... on this channel
Cylinder	38309	
Head	16	
Precomp	0	
Landing Zone	38308	
Sector	255	

↑↓ → ← : Move Enter: Select +/-/PU/PD:Value F10:Save ESC:Exit F1:General Help  
F5:Previous Values F6:Fail-Safe Defaults F7:Optimized Defaults

#### IDE HDD Auto-Detection (Press Enter)

Press <Enter> while this item is highlighted to prompt the Setup Utility to automatically detect and configure an IDE device on the IDE channel.

**Using BIOS**





*If you are setting up a new hard disk drive that supports LBA mode, more than one line will appear in the parameter box. Choose the line that lists LBA for an LBA drive.*

#### **IDE Channel 0/1 Master/Slave IDE/Extended IDE Drives (Auto)**

Leave this item at Auto to enable the system to automatically detect and configure IDE devices on the channel. If it fails to find a device, change the value to Manual and then manually configure the drive by entering the characteristics of the drive in the items described below. Please noted that if you choose IDE Channel 2/3 Master, the item may change to Extended IDE Drive.

Refer to your drive's documentation or look on the drive casing if you need to obtain this information. If no device is installed, change the value to None.



*Before attempting to configure a hard disk drive, ensure that you have the configuration information supplied by the manufacturer of your hard drive. Incorrect settings can result in your system not recognizing the installed hard disk.*

#### **Access Mode (Auto)**

This item defines ways that can be used to access IDE hard disks such as LBA (Large Block Addressing). Leave this value at Auto and the system will automatically decide the fastest way to access the hard disk drive. If you choose IDE Channel 2/3 Master, the item only have Large and Auto.

Press <Esc> to return to the Standard CMOS Features page.

#### **Video (EGA/VGA)**

This item defines the video mode of the system. This motherboard has a built-in VGA graphics system; you must leave this item at the default value.

#### **Halt On (All,But Keyboard)**

This item defines the operation of the system POST (Power On Self Test) routine. You can use this item to select which types of errors in the POST are sufficient to halt the system.

#### **Base Memory, Extended Memory, and Total Memory**

These items are automatically detected by the system at start up time. These are display-only fields. You cannot make changes to these fields.

Press <Esc> to return to the main menu setting page.

**Advanced BIOS Features**

This option defines advanced information about your system.

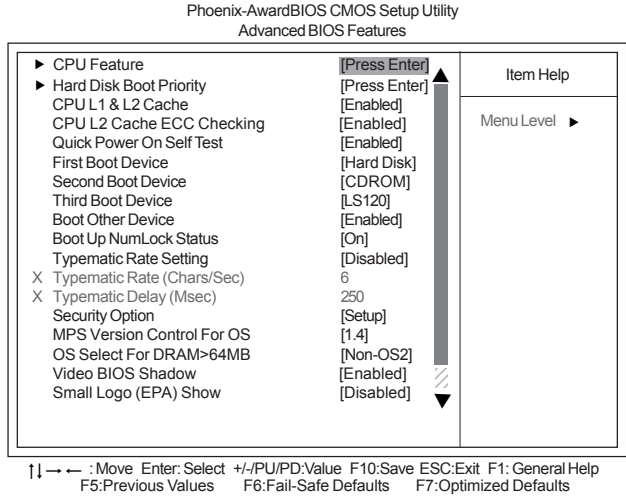

**▶ CPU Features (Press Enter)**

Scroll to this item and press <Enter> to view the following screen:

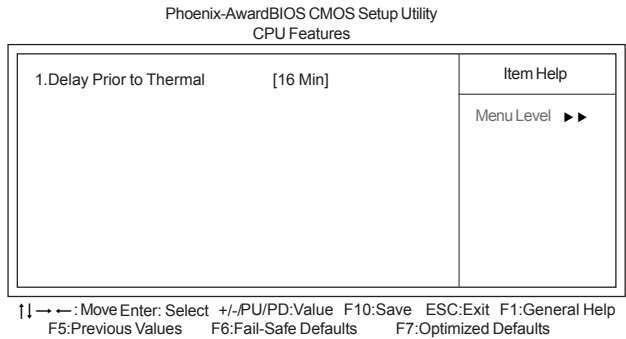

**Delay Prior to Thermal (16 Min)**

Enables you to set the delay time before the CPU enters auto thermal mode.

Press <Esc> to return to the Advanced BIOS Features screen.

### ► Hard Disk Boot Priority (Press Enter)

Scroll to this item and press <Enter> to view the following screen:

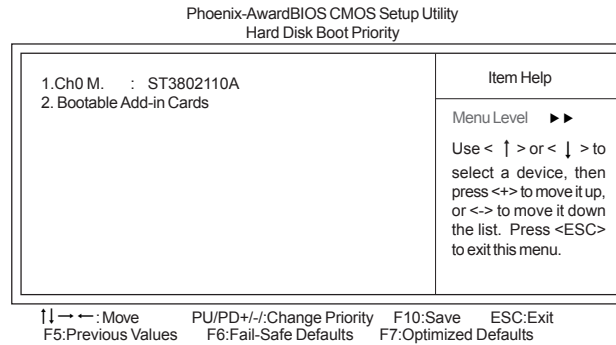

Press <Esc> to return to the Advanced BIOS Features screen.

#### **CPU L1 & L2 Cache (Enabled)**

All processors that can be installed motherboard use CPU internal cache memory to improve performance. This item enables or disables the actual CPU internal level 1/2 cache function. Leave this item at default value for better performance.

#### **CPU L2 Cache ECC Checking (Enabled)**

Enable this item to allow CPU L2 Cache ECC (Error Correcting Code) checking.

#### **Quick Power On Self Test (Enabled)**

Enable this item to shorten the power on testing (POST) and have your system start up faster. You might like to enable this item after you are confident that your system hardware is operating smoothly.

#### **First/Second/Third Boot Device (Hard Disk/CDROM/LS120)**

Use these three items to select the priority and order of the devices that your system searches for an operating system at start-up time.

#### **Boot Other Device (Enabled)**

When enabled, the system searches all other possible locations for an operating system if it fails to find one in the devices specified under the First, Second, and Third boot devices.

#### **Boot Up NumLock Status (On)**

This item defines if the keyboard Num Lock key is active when your system is started.

#### **Typematic Rate Setting (Disabled)**

If this item is enabled, you can use the following two items to set the typematic rate and the typematic delay settings for your keyboard.

- **Typematic Rate (Chars/Sec):** Use this item to define how many characters per second are generated by a held-down key.

## Using BIOS

- **Typematic Delay (Msec):** Use this item to define how many milliseconds must elapse before a held-down key begins generating repeat characters.

**Security Option (Setup)**

If you have installed password protection, this item defines if the password is required at system start up, or if it is only required when a user tries to enter the Setup Utility.

**MPS Version Control For OS (1.4)**

This item specifies which version of MPS of (Multi-Processor Specification) this motherboard will use. Leave this item to its default setting.

**OS Select For DRAM > 64 MB (Non-OS2)**

This item is only required if you have installed more than 64 MB of memory and you are running the OS/2 operating system. Otherwise, leave this item at the default.

**Video BIOS Shadow (Enabled)**

Enable this item to shadow basic BIOS function in ROM in order to invoke these function whenever needs.

**Small Logo (EPA) Show (Disabled)**

Enables or disables the display of the EPA logo during boot.

Press <Esc> to return to the main menu setting page.

### Advanced Chipset Features

These items define critical timing parameters of the motherboard. You should leave the items on this page at their default values unless you are very familiar with the technical specifications of your system hardware. If you change the values incorrectly, you may introduce fatal errors or recurring instability into your system.

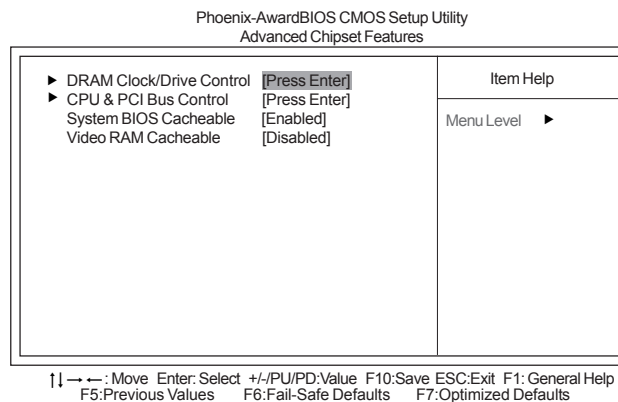

#### ▶ DRAM Clock/Drive Control (Press Enter)

Scroll to this item and press <Enter> to view the following screen:

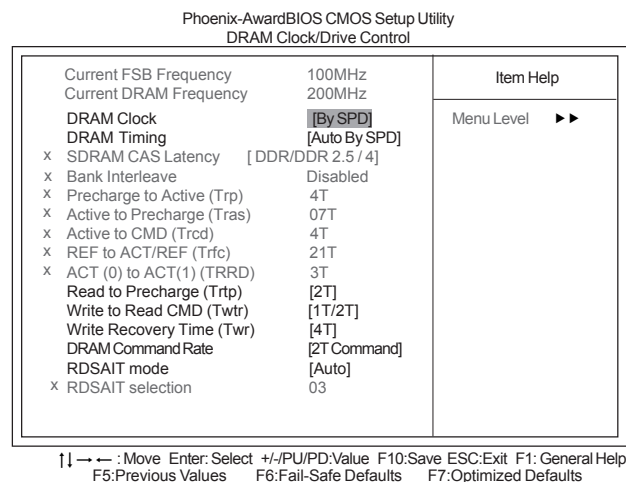

#### Current FSB/DRAM Frequency (100MHz/200MHz)

This item displays current FSB/DRAM frequency.

**DRAM Clock (By SPD)**

This item sets the DRAM clock module.

**DRAM Timing (Auto By SPD)**

This item selects the DRAM timing mode.

- **SDRAM CAS Latency (DDR/DDR 2.5/4):** This item determines the operation of DDR SDRAM memory CAS (column address strobe). It is recommended that you leave this item at the default value. The 2.5T setting requires faster memory that specifically supports this mode.
- **Bank Interleave (Disabled):** Depending on your SDRAM module structure, the 4-Way setting can offer the best performance. If you choose the wrong setting, the computer system will not run in a stable number.
- **Precharge to Active (Trp):** This item specifies the amount of time from a bank precharge request to when it can be activated. It is usually recommended you use the lowest Trp which your RAM and motherboard can run stable with.
- **Active to Precharge (Tras):** This item specifies the amount of time required between an active command to a precharge command.
- **Active to CMD (Trcd):** This item specifies the amount of time in cycles for issuing an active command and the read/write commands.
- **REF to ACT/REF (Trfc):** This item means AutoRefresh period.
- **ACT(0) to ACT(1) (TRRD):** This item means ACT(0) to ACT(1) delay.

**Read to Precharge (Trtp) (2T)**

This item defines the precharge operation always starts one clock following the Read command, independent of CAS Latency.

**Write to Read CMD (Twtr) (1T/2T)**

This item specifies CMD between a valid write command and the next read command.

**Write Recovery Time (Twr) (4T)**

Use this item to specify the time measured from the last write datum is safely registered by the DRAM.

**DRAM Command Rate (2T Command)**

When the host (northbridge) locates the desired memory address, it then processors the wait state of commands.

**RDSAIT mode (Auto)**

This item enable or disable the RDSAIT mode.

- **RDSAIT selection:** This item enable or disable to select the RDSAIT mode.

Press <Esc> to return to the Advanced Chipset Features page.

### ► CPU & PCI Bus Control (Press Enter)

Scroll to this item and press <Enter> to view the following screen:

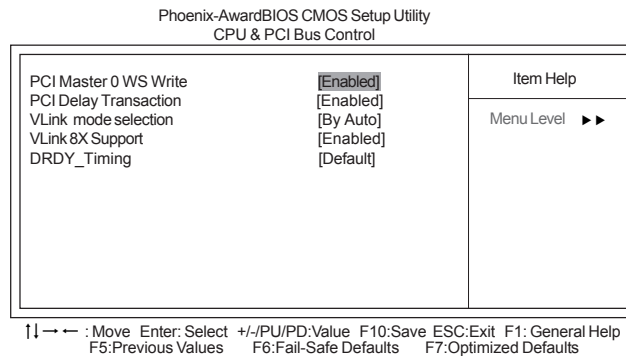

#### **PCI Master 0 WS Write (Enabled)**

This item determines whether the chipsets inserts a delay before any writes from the PCI slots. If it is enabled, write requests to the PCI bus are executed immediately (with zero wait states), if the PCI bus is ready to send data.

#### **PCI Delay Transaction (Enabled)**

This item is used to meet the latency of PCI cycles to and from the ISA bus.

#### **VLink mode selection (By Auto)**

This item controls the data transfer speed between the north and south bridge.

#### **VLink 8X Support (Enabled)**

Use this item to enable or disable VLink 8X support.

#### **DRDY Timing (Default)**

This item specifies the timing of data ready.

Press <Esc> to return to the Advanced Chipset Features page.

#### **System BIOS Cacheable (Enabled)**

This feature is only valid when the system BIOS is shadowed. It enables or disables the caching of the system BIOS ROM at F0000h-FFFFh via the L2 cache. This greatly speeds up accesses to the system BIOS.

#### **Video RAM Cacheable (Disabled)**

Disable or enable this item to read cache data from RAM.

Press <Esc> to return to the main BIOS setting page.

### Integrated Peripherals

These options display items that define the operation of peripheral components on the system's input/output ports.

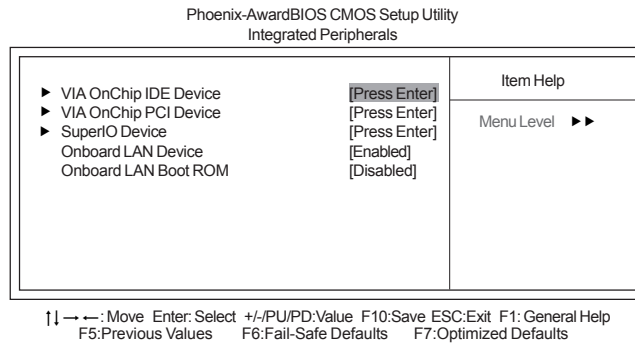

#### ▶ VIA OnChip IDE Device (Press Enter)

Scroll to this item and press <Enter> to view the following screen:

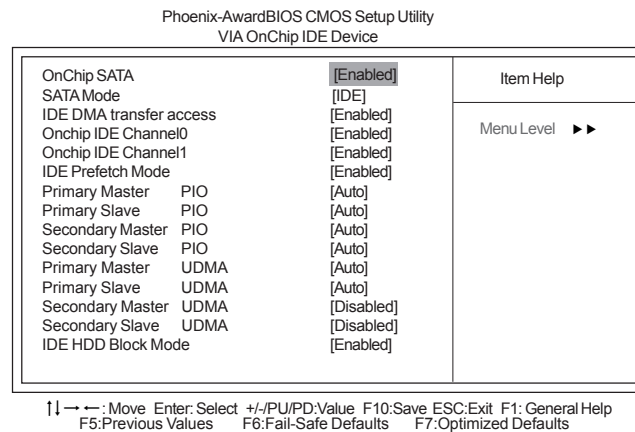

#### **OnChip SATA (Enabled)**

Enables or Disables the build-in on-chip Serial ATA.

#### **SATA Mode (IDE)**

Use this item to select the mode of the Serial ATA.

#### **IDE DMA transfer access (Enabled)**

This item allows you to enable the transfer access of the IDE DMA then burst onto the PCI bus and nonburstable transactions do not.

#### **OnChip IDE Channel0/1 (Enabled)**

Use this item to enable or disable the PCI IDE channels that are integrated on the motherboard.

## Using BIOS



**IDE Prefetch Mode (Enabled)**

The onboard IDE drive interface supports IDE prefetching, for faster drive access. If you install a primary and secondary add-on interface, set this field to Disable if the interface does not support prefetching.

**Primary/Secondary Master/Slave PIO (Auto)**

Each IDE channel supports a master device and a slave device. These four items let you assign the kind of PIO (Programmed Input/Output) was used by the IDE devices. Choose Auto to let the system auto detect which PIO mode is best, or select a PIO mode from 0-4.

**Primary/Secondary Master/Slave UDMA (Auto)**

Each IDE channel supports a master device and a slave device. This motherboard supports UltraDMA technology, which provides faster access to IDE devices.

If you install a device that supports UltraDMA, change the appropriate item on this list to Auto. You may have to install the UltraDMA driver supplied with this motherboard in order to use an UltraDMA device.

**IDE HDD Block Mode (Enabled)**

Enable this field if your IDE hard drive supports block mode. Block mode enables BIOS to automatically detect the optimal number of block read and writes per sector that the drive can support. It also improves the speed of access to IDE devices.

Press <Esc> to return to the Integrated Peripherals page.

**► VIA OnChip PCI Device (Press Enter)**

Scroll to this item and press <Enter> to view the following screen:

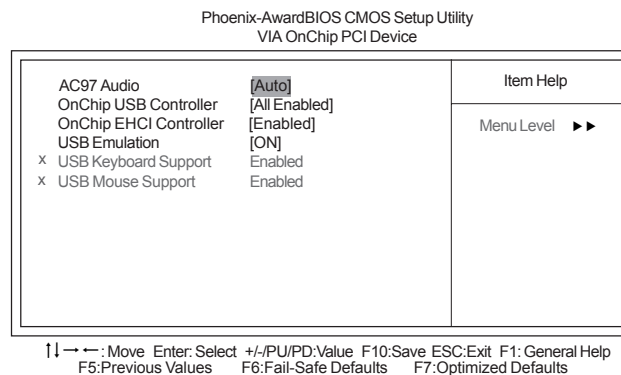
**AC97 Audio (Auto)**

This option allows you to control the onboard AC' 97 audio. Disable this item if you are going to install a PCI audio add-on card.

**OnChip USB Controller (All Enabled)**

This item enables users to enable or disable the onchip USB function, setting it to be USB1.1 or USB2.0 compatible.

**OnChip EHCI Controller (Enabled)**

Enable or disable the Onboard EHCI controller.

**Using BIOS**

**USB Emulation (ON)**

- **USB Keyboard Support (Enabled):** Enabled this item if you plan to use a keyboard connected through the USB port in a legacy operating system (such as DOS) that does not support Plug and Play.
- **USB Mouse Support (Enabled):** Enable this item if you plan to use a mouse connected through the USB port in a legacy operating system (such as DOS) that does not support Plug and Play.

Press <Esc> to return to the Integrated Peripherals page.

**► SuperIO Device (Press Enter)**

Scroll to this item and press <Enter> to view the following screen:

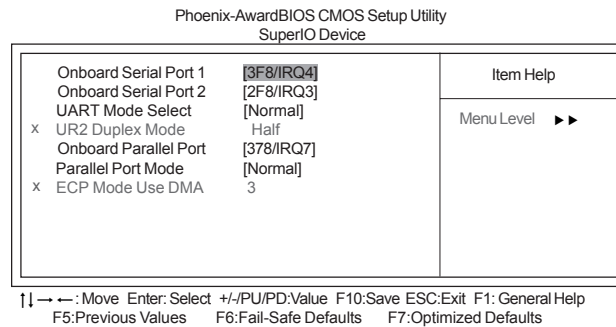
**Onboard Serial Port 1/2 (3F8/IRQ4)(2F8/IRQ3)**

This option is used to assign the I/O address and interrupt request (IRQ) for onboard serial port 1/2 (COM1/2).

**UART Mode Select (Normal)**

- **UR2 Duplex Mode (Half):** This field is available when UART Mode is set to either ASKIR or IrDA. This item enables you to determine the infrared function of the onboard infrared chip. The options are Full and Half (default). Full-duplex means that you transmit and send information simultaneously. Half-duplex is the transmission of data in both directions, but only one direction at a time.

**Onboard Parallel Port (378/IRQ7)**

This option is used to assign the I/O address and interrupt request (IRQ) for the onboard parallel port.

**Parallel Port Mode (Normal)**

Enables you to set the data transfer protocol for your parallel port. There are four options: SPP (Standard Parallel Port), EPP (Enhanced Parallel Port), ECP (Extended Capabilities Port) and ECP+EPP.

- **ECP Mode Use DMA (3):** When the onboard parallel port is set to ECP mode, the parallel port can use DMA 3 or DMA 1.

Press <Esc> to return to the Integrated Peripherals page.

**Using BIOS**

**Onboard LAN Device (Enabled)**

Enables or disables the onboard LAN.

**Onboard LAN Boot ROM (Disabled)**

This item allows you to enable or disable the onboard LAN Boot ROM function.

**Power Management Setup**

This option lets you control system power management. The system has various power-saving modes including powering down the hard disk, turning off the video, suspending to RAM, and software power down that allows the system to be automatically resumed by certain events.

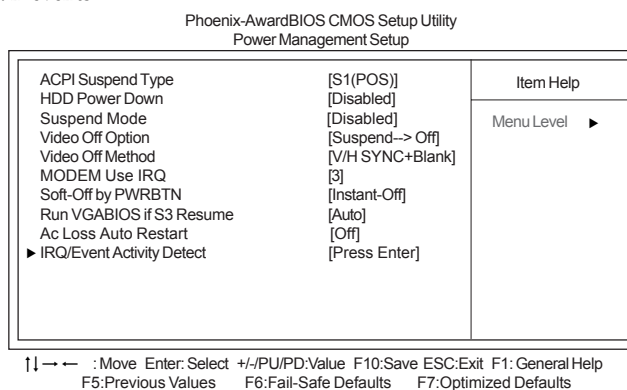
**ACPI Suspend Type (S1(POS))**

Use this item to define how your system suspends. In the default, S3 (STR), the suspend mode is a suspend to RAM, i.e., the system shuts down with the exception of a refresh current to the system memory.

**HDD Power Down (Disabled)**

The IDE hard drive will spin down if it is not accessed within a specified length of time. Options are from 1 Min to 15 Min and Disable.

**Suspend Mode(Disabled)**

The CPU clock will be stopped and the video signal will be suspended if no Power Management events occur for a specified length of time. Full power function will return when a Power Management events is detected.

**Video Off Option (Suspend → Off)**

This option defines if the video is powered down when the system is put into suspend mode.

**Video Off Method (V/H SYNC+Blank)**

This item defines how the video is powered down to save power. This item is set to DPMS (Display Power Management Software) by default.

**MODEM Use IRQ (3)**

If you want an incoming call on a modem to automatically resume the system from a power-saving mode, use this item to specify the interrupt request line (IRQ) that is used by the modem. You might have to connect the fax/modem to the motherboard Wake On Modem connector for this feature to work.

**Using BIOS**

**Soft-Off by PWRBTN (Instant Off)**

Under ACPI (Advanced Configuration and Power management Interface) you can create a software power down. In a software power down, the system can be resumed by Wake Up Alarms. This item lets you install a software power down that is controlled by the power button on your system. If the item is set to Instant-Off, then the power button causes a software power down. If the item is set to Delay 4 Sec. then you have to hold the power button down for four seconds to cause a software power down.

**Run VGABIOS if S3 Resume (Auto)**

This item allows the system to initialize the VGA BIOS from S3 (Suspend to RAM) sleep state.

**Ac Loss Auto Restart (Off)**

This item enables your computer to automatically restart or return to its last operating status.

**► IRQ/Event Activity Detect (Press Enter)**

Scroll to this item and press <Enter> to view the following screen:

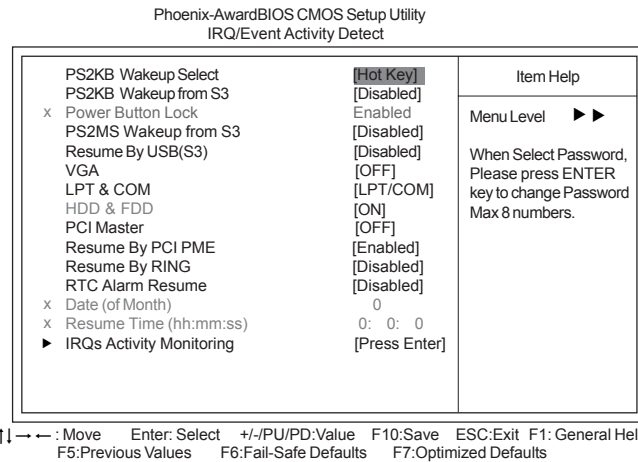
**PS2KB Wakeup Select (Hot Key)**

This item enables you to select any key, hot key or power key to allow keyboard activity to awaken the system.

**PS2KB Wakeup from S3 (Disabled)**

This item enables or disables you to allow keyboard activity to awaken the system from S3 mode.

- **Power Button Lock (Enabled):** If you enabled this item, the system can automatically resume by pressing power key on the keyboard, or typing in the password. You must use an ATX power supply in order to use this feature.

**PS2MS Wakeup from S3 (Disabled)**

This item enables or disables you to allow mouse activity to awaken the system from S3 mode.

## Using BIOS

**Resume by USB (S3) (Disabled)**

This option allows the activity of the USB devices to wake up the system from S3 sleep state.

**VGA (OFF)**

Use this item to enable power management unit to monitor VGA activities.

**LPT & COM (LPT/COM)**

Use this item to enable power management unit to monitor LPT or COM activities.

**HDD & FDD (ON)**

Use this item to enable power management unit to monitor HDD or FDD activities.

**PCI Master (OFF)**

This item enable or disable that the system will be waken up by PCI master command.

**Resume by PCI PME (Enabled)**

This item specifies whether the system will be awakened from power saving modes when activity or input signal of the specified hardware peripheral or component is detected.

**Resume by Ring (Disabled)**

This item specifies whether the system will be awakened from power saving modes when activity or input signal of WOL/WOM/Ring device is detected.

**RTC Alarm Resume (Disabled)**

When set to Enabled, additional fields become available and you can set the date (day of the month), hour, minute and second to turn on your system. When set to 0 (zero) for the day of the month, the alarm will power on your system every day at the specified time.

- **Date of Month:** Use this item to define the date of month when using the RTC alarm to resume the system.
- **Resume Time (hh:mm:ss):** Use this item to define the time when using the RTC alarm to resume the system.

Press <Esc> to return to the Power Management Setup screen.

### ► IRQs Activity Monitoring (Press Enter)

Scroll to this item and press <Enter> to view the following screen:

Phoenix-AwardBIOS CMOS Setup Utility  
IRQs Activity Monitoring

Primary INTR	<b>[ON]</b>	Item Help
IRQ3 (COM 2)	[Disabled]	
IRQ4 (COM 1)	[Enabled]	
IRQ5 (LPT 2)	[Enabled]	
IRQ6 (Floppy Disk)	[Enabled]	
IRQ7 (LPT 1)	[Enabled]	
IRQ8 (RTC Alarm)	[Disabled]	
IRQ9 (IRQ2 Redir)	[Disabled]	
IRQ10 (Reserved)	[Disabled]	
IRQ11 (Reserved)	[Disabled]	
IRQ12 (PS/2 Mouse)	[Enabled]	
IRQ13 (Coprocessor)	[Enabled]	
IRQ14 (Hard Disk)	[Enabled]	
IRQ15 (Reserved)	[Disabled]	

↑↓ → ← : Move Enter: Select +/-/PU/PD: Value F10: Save ESC: Exit F1: General Help  
F5: Previous Values F6: Fail-Safe Defaults F7: Optimized Defaults

The screen enables you to set IRQs that will resume the system from a power saving mode.

Set any IRQ to Enabled to allow activity at the IRQ to wake up the system from a power saving mode.

Press <Esc> to return to the Power Management Setup screen.

## PNP/PCI Configurations

These options configure how PnP (Plug and Play) and PCI expansion cards operate in your system. Both the the ISA and PCI buses on the motherboard use system IRQs (Interrupt ReQuests) and DMAs (Direct Memory Access). You must set up the IRQ and DMA assignments correctly through the PnP/PCI Configurations Setup utility for the motherboard to work properly. Selecting PnP/PCI Configurations on the main program screen displays this menu:

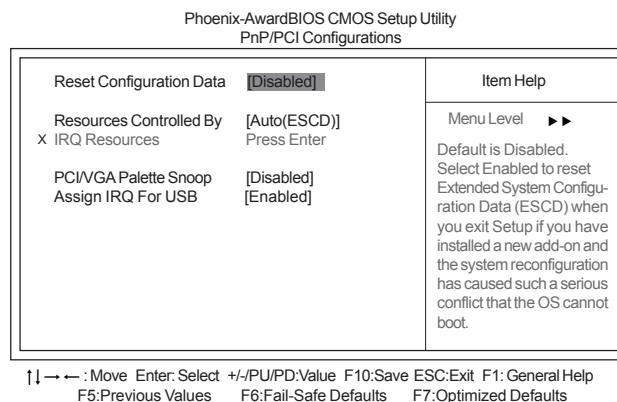

### Reset Configuration Data (Disabled)

If you enable this item and restart the system, any Plug and Play configuration data stored in the BIOS Setup is cleared from memory.

### Resources Controlled By (Auto(ESCD))

You should leave this item at the default Auto (ESCD). Under this setting, the system dynamically allocates resources PCI/VGA Palette Snoop (Disabled) to Plug and Play devices as they are required.

If you cannot get a legacy ISA (Industry Standard Architecture) expansion card to work properly, you might be able to solve the problem by changing this item to Manual, and then opening up the IRQ Resources submenu.

- **IRQ Resources [Press Enter]:** In the IRQ Resources submenu, if you assign an IRQ to Legacy ISA, then that Interrupt Request Line is reserved for a legacy ISA expansion card. Press <Esc> to close the IRQ Resources submenu.

### PCI/VGA Palette Snoop (Disabled)

This item is designed to overcome problems that can be caused by some non-standard VGA cards. This board includes a built-in VGA system that does not require palette snooping so you must leave this item disabled.

### Assign IRQ For USB (Enabled)

Enable or Disable this item when users are to assign IRQ for the USB interface onboard.

## Using BIOS

### PC Health Status

On motherboards that support hardware monitoring, this item lets you monitor the parameters for critical voltages, temperatures and fan speeds.

Phoenix-Award BIOS CMOS Setup Utility  
PC Health Status

Shutdown Temperature	<b>Disabled</b>	Item Help
CPU Vcore	0.99V	
VDIMM	1.85V	Menu Level ▶
CPU Temperature	30°C	
SYSTEM Temperature	39°C	
CPU FAN SPEED	6026 RPM	

↑↓ → ← : Move Enter: Select +/-/PU/PD: Value F10: Save ESC: Exit F1: General Help  
F5: Previous Values F6: Fail-Safe Defaults F7: Optimized Defaults

#### Shutdown Temperature (Disabled)

Enables you to set the maximum temperature the system can reach before powering down.

#### System Component Characteristics

These fields provide you with information about the systems current operating status. You cannot make changes to these field.

- CPU Vcore
- VDIMM
- CPU Temperature
- SYSTEM Temperature
- CPU FAN SPEED



### ***Frequency/Voltage Control***

This item enables you to set the clock speed and system bus for your system. The clock speed and system bus are determined by the kind of processor you have installed in your system.

Phoenix-AwardBIOS CMOS Setup Utility  
Frequency/Voltage Control

Auto Detect PCI Clk <b>[Enabled]</b> Spread Spectrum <b>[+/- 0.20%]</b> CPU Host/AGP/PCI Clock    100/66/33Mhz	Item Help <hr/> Menu Level ▶
--	---------------------------------

↑↓ ← → : Move    Enter: Select    +/-/PU/PD:Value    F10:Save    ESC:Exit    F1: General Help  
 F5:Previous Values    F6:Fail-Safe Defaults    F7:Optimized Defaults

#### **Auto Detect PCI Clk (Enabled)**

When this item is enabled, BIOS will disable the clock signal of free PCI slots.

#### **Spread Spectrum (+/- 0.20%)**

If you enable spread spectrum, it can significantly reduce the EMI (Electro-Magnetic Interference) generated by the system.

#### **CPU Host/AGP/PCI Clock (100/66/33 MHz)**

This item allows you to select the CPU Host/AGP/PCI Clock frequency.

Press <Esc> to return to the main menu setting page.

### ***Load Fail-Safe Defaults***

This option opens a dialog box that lets you install fail-safe defaults for all appropriate items in the Setup Utility. Press <Y> and the <Enter> to install the defaults. Press <N> and then <Enter> to not install the defaults. The fail-safe defaults place no great demands on the system and are generally stable. If your system is not functioning correctly, try installing the fail-safe defaults as a first step in getting your system working properly again. If you only want to install fail-safe defaults for a specific option, select and display that option, and then press <F6>.

### ***Load Optimized Defaults***

This option opens a dialog box that lets you install optimized defaults for all appropriate items in the Setup Utility. Press <Y> and then <Enter> to install the defaults. Press <N> and then <Enter> to not install the defaults. The optimized defaults place demands on the system that may be greater than the performance level of the components, such as the CPU and the memory. You can cause fatal errors or instability if you install the optimized defaults when your hardware does not support them. If you only want to install setup defaults for a specific option, select and display that option, and then press <F7>.

### ***Set Supervisor/User Password***

When this function is selected, the following message appears at the center of the screen to assist you in creating a password.

#### **ENTER PASSWORD**

Type the password, up to eight characters, and press <Enter>. The password typed now will clear any previously entered password from CMOS memory. You will be asked to confirm the password. Type the password again and press <Enter>. You may also press <Esc> to abort the selection.

To disable password, just press <Enter> when you are prompted to enter password. A message will confirm the password being disabled. Once the password is disabled, the system will boot and you can enter BIOS Setup freely.

#### **PASSWORD DISABLED**

If you have selected “**System**” in “Security Option” of “BIOS Features Setup” menu, you will be prompted for the password every time the system reboots or any time you try to enter BIOS Setup.

If you have selected “**Setup**” at “Security Option” from “BIOS Features Setup” menu, you will be prompted for the password only when you enter BIOS Setup.

Supervisor Password has higher priority than User Password. You can use Supervisor Password when booting the system or entering BIOS Setup to modify all settings. Also you can use User Password when booting the system or entering BIOS Setup but can not modify any setting if Supervisor Password is enabled.

### ***Save & Exit Setup***

Highlight this item and press <Enter> to save the changes that you have made in the Setup Utility and exit the Setup Utility. When the Save and Exit dialog box appears, press <Y> to save and exit, or press <N> to return to the main menu.

### ***Exit Without Saving***

Highlight this item and press <Enter> to discard any changes that you have made in the Setup Utility and exit the Setup Utility. When the Exit Without Saving dialog box appears, press <Y> to discard changes and exit, or press <N> to return to the main menu.



*If you have made settings that you do not want to save, use the “Exit Without Saving” item and press <Y> to discard any changes you have made.*

This concludes Chapter 3. Refer to the next chapter for information on the software supplied with the motherboard.

***Memo***

**Using BIOS**

## Chapter 4

### ***Using the Motherboard Software***

---

#### **About the Software CD-ROM**

The support software CD-ROM that is included in the motherboard package contains all the drivers and utility programs needed to properly run the bundled products. Below you can find a brief description of each software program, and the location for your motherboard version. More information on some programs is available in a README file, located in the same directory as the software.

 *Never try to install all software from folder that is not specified for use with your motherboard.*

Before installing any software, always inspect the folder for files named README.TXT, INSTALL.TXT, or something similar. These files may contain important information that is not included in this manual.

#### **Auto-installing under Windows 98/ME/2000/XP**

The Auto-install CD-ROM makes it easy for you to install the drivers and software for your motherboard.

 *If the Auto-install CD-ROM does not work on your system, you can still install drivers through the file manager for your OS (for example, Windows Explorer). Refer to the Utility Folder Installation Notes later in this chapter.*

The support software CD-ROM disc loads automatically under Windows 98/ME/2000/XP. When you insert the CD-ROM disc in the CD-ROM drive, the autorun feature will automatically bring up the install screen. The screen has three buttons on it, Setup, Browse CD and Exit.

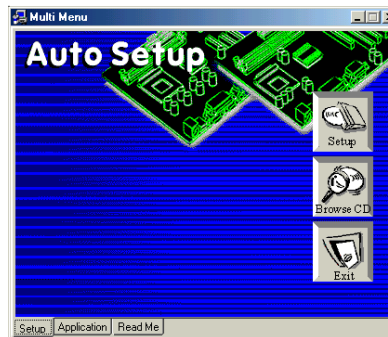

 *If the opening screen does not appear; double-click the file "setup.exe" in the root directory.*

### **Using the Motherboard Software**

### Setup Tab

<b>Setup</b>	Click the <b>Setup</b> button to run the software installation program. Select from the menu which software you want to install.
<b>Browse CD</b>	<p>The <b>Browse CD</b> button is the standard Windows command that allows you to open Windows Explorer and show the contents of the support CD.</p> <p>Before installing the software from Windows Explorer, look for a file named README.TXT, INSTALL.TXT or something similar. This file may contain important information to help you install the software correctly.</p> <p>Some software is installed in separate folders for different operating systems, such as DOS, WIN NT, or WIN98/95. Always go to the correct folder for the kind of OS you are using.</p> <p>In install the software, execute a file named SETUP.EXE or INSTALL.EXE by double-clicking the file and then following the instructions on the screen.</p>
<b>Exit</b>	The <b>EXIT</b> button closes the Auto Setup window.

### Application Tab

Lists the software utilities that are available on the CD.

### Read Me Tab

Displays the path for all software and drivers available on the CD.

### Running Setup

Follow these instructions to install device drivers and software for the motherboard:

1. Click **Setup**. **The installation program begins:**

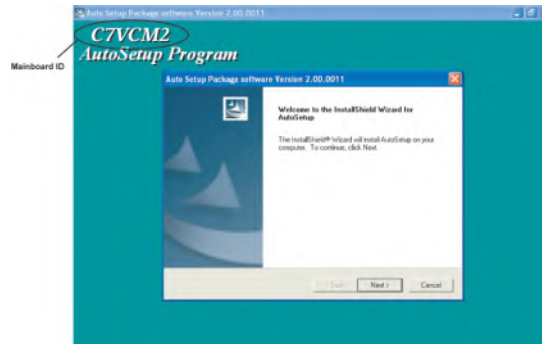

*The following screens are examples only. The screens and driver lists will be different according to the motherboard you are installing.*

The motherboard identification is located in the upper left-hand corner.

## Using the Motherboard Software

2. Click **Next**. The following screen appears:



3. Check the box next to the items you want to install. The default options are recommended.
4. Click **Next** run the Installation Wizard. An item installation screen appears:

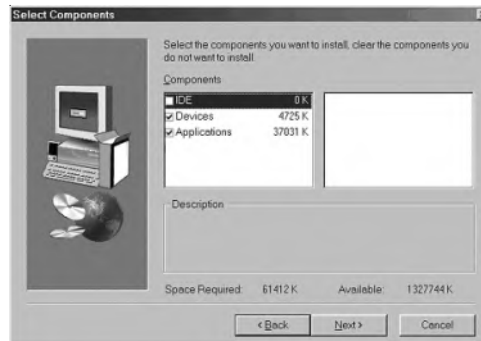

5. Follow the instructions on the screen to install the items.

Drivers and software are automatically installed in sequence. Follow the onscreen instructions, confirm commands and allow the computer to restart a few times to complete the installation.

## Using the Motherboard Software

## Manual Installation

Insert the CD in the CD-ROM drive and locate the PATH.DOC file in the root directory. This file contains the information needed to locate the drivers for your motherboard.

Look for the chipset and motherboard model; then browse to the directory and path to begin installing the drivers. Most drivers have a setup program (SETUP.EXE) that automatically detects your operating system before installation. Other drivers have the setup program located in the operating system subfolder.

If the driver you want to install does not have a setup program, browse to the operating system subfolder and locate the readme text file (README.TXT or README.DOC) for information on installing the driver or software for your operating system.

## Utility Software Reference

All the utility software available from this page is Windows compliant. They are provided only for the convenience of the customer. The following software is furnished under license and may only be used or copied in accordance with the terms of the license.



*These software(s) are subject to change at anytime without prior notice.  
Please refer to the support CD for available software.*

This concludes Chapter 4.

## Using the Motherboard Software