

AV41P/AV41PN
Intel Pentium 4/Celeron
478-pin Processor
with 400/533 MHz FSB
Based MAINBOARD
User's Manual

Shuttle® AV41P/AV41PN

**Intel Pentium 4/Celeron
478-pin Processor
with 400/533 MHz FSB
Based Mainboard
Manual Version 1.0**

Copyright

Copyright© 2002 by Shuttle® Inc. All Rights Reserved.

This publication, including all photos, illustrations, and software, is protected under international copyright laws, with all rights reserved. Reproducing any of the material contained herein is prohibited without the consent of the publisher.

Disclaimer

Shuttle® Inc. shall not be liable for any incidental or consequential damages resulting from the performance or use of this product.

This company makes no representations or warranties regarding the contents of this manual. Information in this manual has been carefully checked for reliability; however, no guarantee is given as to the correctness of the contents. In the interest of continued product improvement, this company reserves the right to revise the manual or include changes in the specifications of the product described within it at any time without notice and without obligation to notify any person of such revision or changes. The information contained in this manual is provided for general use by the customers.

Trademarks

Shuttle is a registered trademark of Shuttle Inc.

VIA is a registered trademark of VIA Corporation.

Intel, Pentium, and Celeron are registered trademarks of Intel Corporation.

PS/2 is a registered trademark of IBM Corporation.

AMI is a registered trademark of AMI Software Inc.

Microsoft and Windows are registered trademarks of Microsoft Corporation.

General Notice: Other product names used in this manual are ascribed to their respective owners and acknowledged.

TABLE OF CONTENTS

WHAT'S IN THE MANUAL	5
Quick Reference	5
About This Manual	5
1 INTRODUCTION	6
1.1 TO DIFFERENT USERS	6
FIRST-TIME DIY SYSTEM BUILDER	6
EXPERIENCED DIY USER	6
SYSTEM INTEGRATOR	6
1.2 ITEM CHECKLIST:	7
2 FEATURES	8
2.1 SPECIFICATIONS	8
3 HARDWARE INSTALLATION	11
3.1 STEP-BY-STEP INSTALLATION	11
STEP 1 CPU Installation	12
STEP 2 Set Jumpers	14
STEP 3 Install DDRs/SDRs System Memory	14
STEP 4 Install Internal Peripherals in System Case	15
STEP 5 Mount the Mainboard on the Computer Chassis	16
STEP 6 Connect Front-Panel Switches/LEDs/USBs	17
STEP 7 Connect IDE and Floppy Disk Drives	18
STEP 8 Connect Other Internal Peripherals	18
STEP 9 Connect the Power Supply	19
STEP 10 Install Add-on Cards in Expansion Slots	20
STEP 11 Connect External Peripherals to Back-Panel	21
STEP 12 System Boot Up For the First-Time	22
STEP 13 Install Drivers & Software Components	23

3.2 JUMPER SETTINGS	24
JUMPERS & CONNECTORS GUIDE	25
<i>Jumpers</i>	
Clear CMOS Setting (JBAT1)	28
DRAM Voltage Setting (JP1)	29
DDR/SDR DRAM Type Selector Setting (J2A/B/C/D & J3A/B/C/D)	29
Wake On Keyboard/USB Activity Setting (JP2)	30
CPU Clock Setting (JP1A1/JP1B1)	30
<i>Back-Panel Connectors</i>	
PS/2 Keyboard & PS/2 Mouse Connectors	31
USB1/USB2 Port Connectors	31
LAN Port Connector (AV41PN Only)	31
COM1/COM2 Port Connectors	31
Parallel Port Connector	32
Line-Out Port Connector	32
Line-In Port Connector	32
Mic-In Port Connector	32
MIDI/Game Port Connector	32
<i>Front-Panel Connectors</i>	
HDD LED Connector (HD_LED)	33
Green LED Connector (SP_LED)	33
Hardware Reset Connector (RST)	34
ATX Power On/Off Switch Connector (PW_BN)	34
Extended USB Headers (USB1/USB2)	35
Front-Panel Line-Out/Mic-In Header (PANEL1)	35
<i>Internal Peripheral Connectors</i>	
Enhanced IDE and Floppy Connectors	36

<i>Other Connectors</i>	
ATX Power Supply Connector (CN5)	37
Cooling Fan Connectors (CPU_FAN/SYSTEM_FAN)	38
Audio CD_IN Connectors (CD1/CD2)	38
IR Header (SIR1)	38
Wake-On-Modem (WOM1) Connector	39
Wake-On-LAN (WOL1) Connector	39
Internal Speaker Header (SPK1)	40
Sleep Switch Header (J12)	40
LAN LED Indicator Header (J16) (AV41PN Only)	40
3.3 SYSTEM MEMORY CONFIGURATION	41
INSTALL MEMORY	41
UPGRADE MEMORY	41
4 SOFTWARE UTILITY	42
4.1 Mainboard CD Overview	42
4.2 Install Mainboard Software	43
4.2.A Install VIA Chipset Driver	44
4.2.B Install Audio Driver	45
4.2.C Install USB 2.0 Driver	46
4.2.D Install LAN Driver (AV41PN Only)	46
4.3 View the User's Manual	47
5 BIOS SETUP	48
5.1 ENTER the BIOS	48
5.2 THE MAIN MENU	49
STANDARD CMOS SETUP	51
ADVANCED SETUP	52

POWER MANAGEMENT SETUP	55
PCI / PLUG AND PLAY SETUP	57
LOAD OPTIMAL SETTINGS	58
LOAD BEST PERFORMANCE SETTINGS	58
FEATURES SETUP	59
CPU PNP SETUP	61
HARDWARE MONITOR	62
CHANGE PASSWORD	63
EXIT	64

WHAT'S IN THE MANUAL

Quick Reference

Hardware Installation >> Step-by-Step	Page 11
Jumper Settings >> A Closer Look	Page 24
Software Utility >> How to Install	Page 42
BIOS Setup >> How to Configure	Page 48

About This Manual

For First-Time DIY System Builder	Page 6
For Experienced DIY User	Page 6
For System Integrator	Page 6

1 INTRODUCTION

1.1 To Different Users

First-Time DIY System Builder

Welcome to the DIY world! Building your own computer system is not as difficult as you may think. To make your first computer DIY experience successful, right from the start, we have designed the **3.1 Hardware Installation** section in a step-by-step fashion for all the first-time DIY system builders. Prior to installation, we also suggest you to read the whole manual carefully to gain a complete understanding of your new Shuttle AV41P/AV41PN mainboard.

Experienced DIY User

Congratulate on your purchase of the Shuttle AV41P/AV41PN mainboard. You will find that installing your new Shuttle AV41P/AV41PN mainboard is just easy. Bundled with an array of onboard functions, the highly-integrated AV41P/AV41PN mainboard provides you with a total solution to build the most stable and reliable system. Refer to sections **3.2 Jumper Settings** and **Chapter 4 Drivers/Software Utilities** to find out how to get the best out of your new mainboard. **Chapter 5 BIOS Setup** also contains the relevant information on how to tune up your system to achieve higher performance.

System Integrator

You have wisely chosen this mainboard to construct your system. This mainboard incorporates all the state-of-the-art technology of the P4X333 chipset from VIA. It integrates the most advanced functions you can find to date in a compact ATX board.

This manual is all-purpose for two kinds of mainboards: AV41P and AV41PN. The main difference between them is that AV41PN is equipped with an onboard LAN. In the manual, if there are some standards, characteristics, equipment, or software adopted only by AV41PN, it will be highlighted in brackets.

1.2 Item Checklist:

Check all items with your AV41P/AV41PN mainboard to make sure nothing is missing. The complete package should include:

- * One piece of the AV41P/AV41PN mainboard

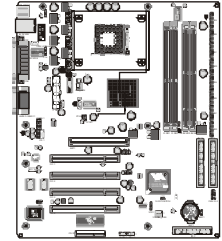

- * One piece of ATA **133/100/66** Ribbon Cable



- * One piece of Floppy Ribbon Cable

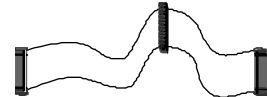

- * I/O Shielding (**AV41PN only**)



- * One piece of twin-port USB Cable (**optional**)

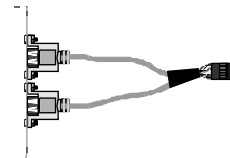

- * AV41P/AV41PN User's Manual



- * One piece of Bundled CD-ROM with containing:

- AV41P/AV41PN user's manual in PDF format
- VIA chipset driver
- Audio driver
- USB 2.0 driver
- LAN driver (**AV41PN only**)
- AMI Flashing Utility



2 FEATURES

This mainboard is carefully designed for the demanding PC user who wants high performance and maximum intelligent features in a compact package.

2.1 Specifications

* CPU Support

Intel Pentium 4/Celeron, 478-pin processors with 400/533 MHz FSB.

* Chipset

Features VIA P4X333 N.B. and VIA VT8235 S.B..

* Built-in Ethernet LAN (AV41PN only)

Built-in 10BaseT/100BaseTX Ethernet LAN.

VT8235 integrates Fast Ethernet MAC and VT6103 LAN PHY in compliance with IEEE802.3u 100BASE-TX, 10BASE-T and ANSI X3.263 TP-PMD standards.

In compliance with ACPI 1.0 and the Network Device Class Power Management 1.0.

* AC'97 Audio Codec

Compliant with AC'97 2.1 specifications.

Supports 16-bit stereo full-duplex CODEC and three analog line-level stereo inputs.

* Versatile Memory Support

Two **184-pin DIMM** slots to support up to 2GB of PC1600, PC2100, or PC2700, compliant **DDR** SDRAM module.

Two **168-pin DIMM** slots to support up to 2GB of PC100 or PC133, compliant **SDR** SDRAM module.

* Expansion Slots

Provide four 32-bit PCI slots, one AGP slot that supports up to 4X AGP device, and one CNR (Communications and Networking Riser) slot.

* 6 USB 2.0 Interfaces Onboard

➤ 2 x USB connectors on back-panel and two sets of dual USB port headers on board.

* I/O Interface

Provides a variety of I/O interfaces:

- 1 x Floppy interface for 3.5-inch FDD with 720KB, 1.44MB, or 2.88MB format or for 5.25-inch FDD with 360K or 1.2MB format.
- 1 x PS/2 Mouse connector.
- 1 x PS/2 Keyboard connector.
- 1 x RJ45 LAN connector. **(AV41PN only)**
- 1 x DB25 parallel connector that supports SPP, EPP, and ECP.
- 2 x DB9 serial connectors 16C550 UART compatible.
- 1 x Infrared communication port.
(Serial port COM2 can also be redirected to an external IrDA Adapter for wireless connection.)
- 1 x DB15 MIDI/Game port.
- 1 x Line-Out port.
- 1 x Line-In port.
- 1 x Mic-In port.

* PCI Bus Master IDE Controller Onboard

Two UltraDMA **133/100/66** Bus Master Dual-Channel IDE ports provide support to a maximum of four IDE devices (one Master and one Slave per channel). The IDE Bus implements data transfer speeds of up to **133/100/66** MB/sec and also supports Enhanced PIO Modes.

80-pin Cable Backward Compatible Legacy ATAPI Devices, ATAPI IDE CD-ROM, CD-R, CD-RW, and LS-120 Supports.

* ATX Power Supply Connector

ATX power supply unit can connected to the onboard 20-pin Pentium 4 standard ATX power connector, supporting Suspend and Soft-On/Off by dual-function power button.

* Advanced Configuration and Power Interface

Features three power-saving modes: S1 (Snoop), S4 (Suspend to DISK), and S5 (Soft-Off). ACPI provides more efficient energy-saving features controlled by your operating system that supports OS direct Power Management (OSPM) functionality.

* System BIOS

Provides licensed AMI BIOS that supports power management, wake-up alarms, CPU parameters and memory timing, and CPU and memory timing.

* **ATX Form Factor**

System board conforms to the ATX specification.

Board dimension: 305mm x 244mm.

* **Advanced Features**

- **Low EMI** - Built in spread spectrum and automatic clock shut-off of unused PCI/SDRAMS slots to reduce EMI.
- **Dual Function Power Button** - The system can be in one of two states, one is Suspend mode and the other is Soft-Off mode. Pushing the power button for less than 4 seconds places the system into Suspend mode. When the power button is pressed for longer than 4 seconds, the system enters Soft-Off mode.
- **Wake-On-LAN (WOL)** - The onboard WOL connector can be attached to a network card that supports this function to wake up the system via LAN.
- **Modem Ring Power-On** - The system can be powered on automatically by the activation of modem ring.
- **CPU Clock Setting** - This item allows users to adjust CPU Host Clock in BIOS.
- **CPU Multiplier Setting** - This item allows users to adjust CPU Multiplier in BIOS.

* **Intelligent Features**

- **Voltage Monitoring** - Monitors various voltages of key elements, such as the CPU, and other critical system voltage levels to ensure stable current passing through mainboard components.
- **Fan Status Monitoring** - To prevent CPU from overheating, the CPU fan is monitored for RPM and failure. (CPU Cooling FAN with RPM sensor is required.)
- **Temperature Monitoring** - This item allows users to make sure whether the CPU or system runs in a suitable temperature.

3 HARDWARE INSTALLATION

Before removing or installing any of these devices including CPU, DIMMs, Add-On Cards, Cables, please make sure to unplug the onboard power connector.

This section outlines how to install and configure your mainboard. Refer to the following mainboard layout to help you to identify various jumpers, connectors, slots, and ports. Then follow these steps designed to guide you through a quick and correct installation of your system.

3.1 Step-by-Step Installation

Accessories Of the AV41P/AV41PN Mainboard

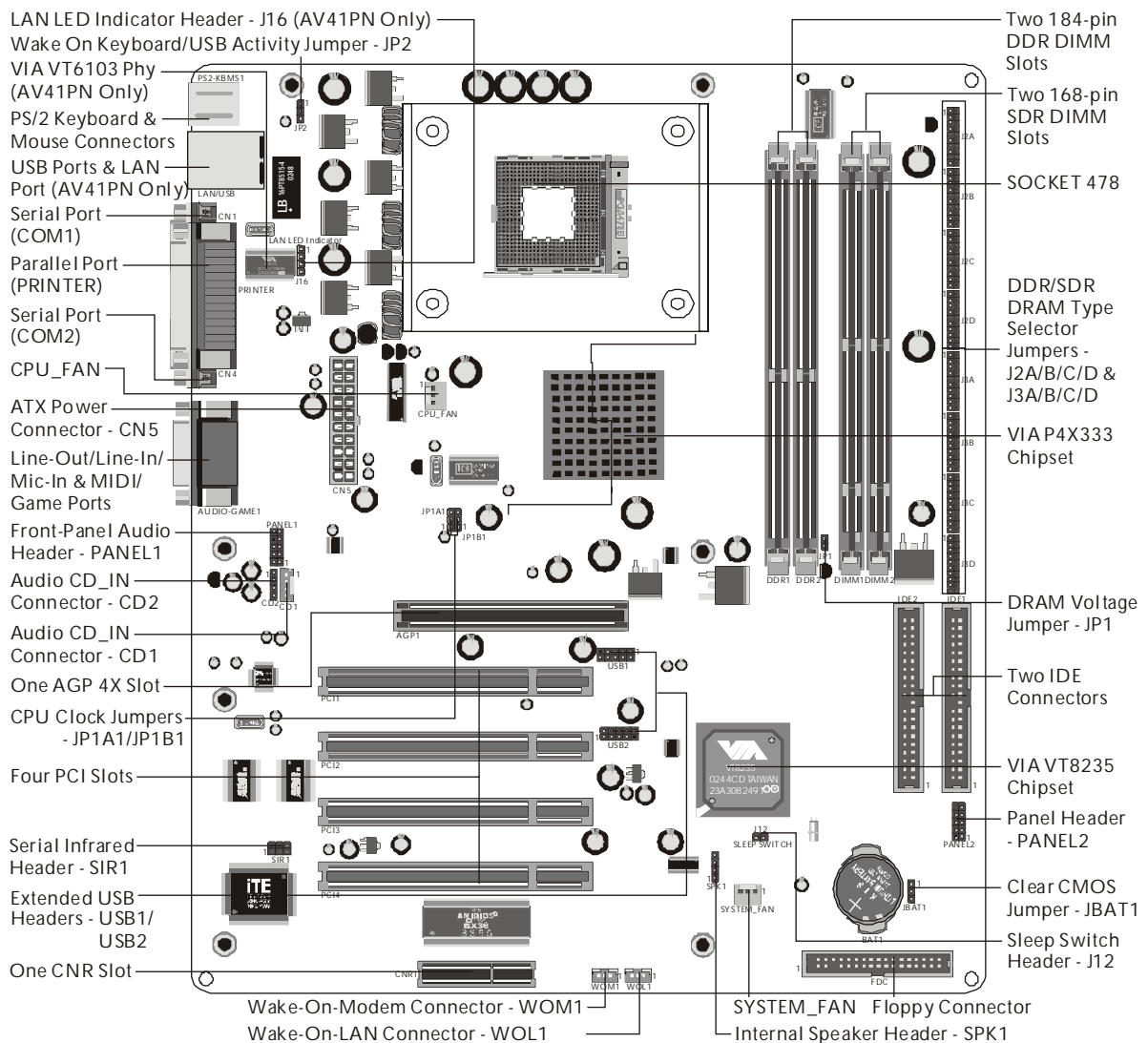

Step 1

CPU Installation:

This mainboard supports Intel Pentium 4/Celeron Socket 478 series CPU. Please follow the steps as follows to finish CPU installation.

Note the CPU orientation when you plug it into CPU socket.

1. Pull up the CPU socket lever to 90-degree angle.

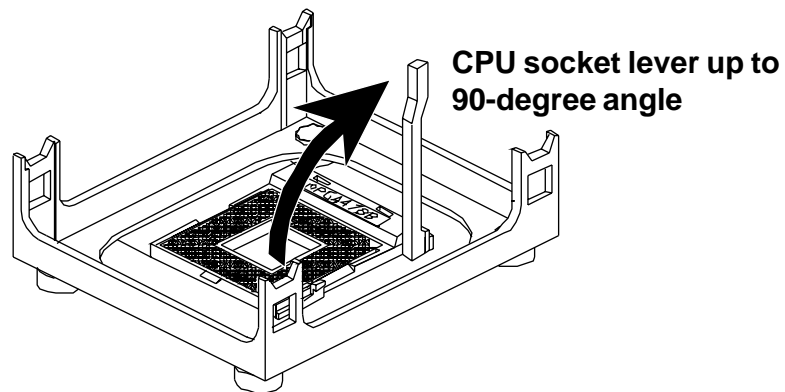

2. Locate Pin 1 in the socket and look for a black dot or cut edge on the CPU upper interface. Match Pin 1 and cut edge, and insert the CPU into the socket.

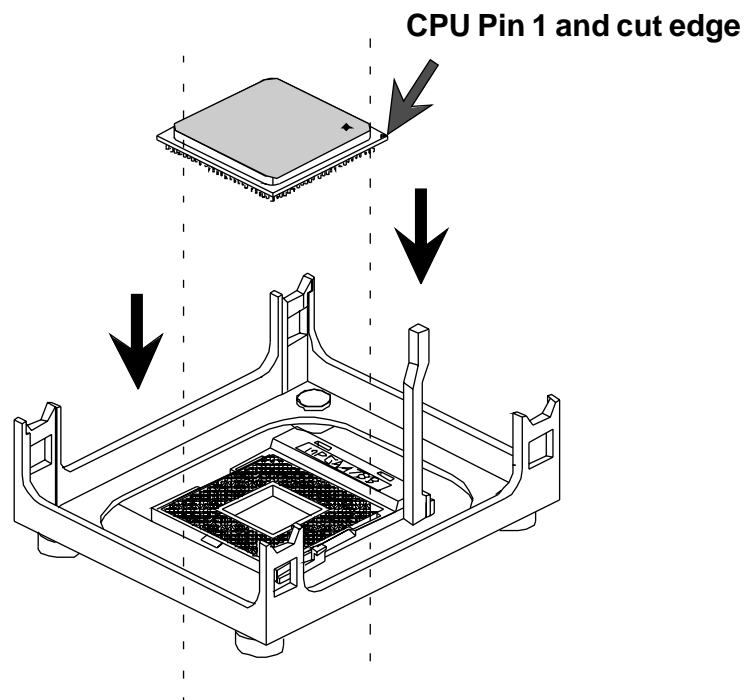

3. Press down the CPU socket lever and finish CPU installation.

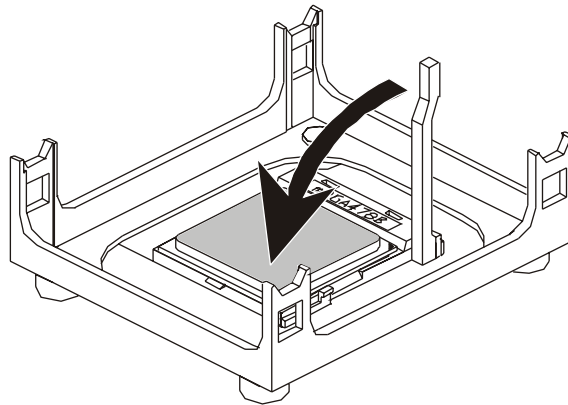

Note: The CPU might be damaged if you do not match the CPU socket Pin 1 and cut edge well.

4. Intel Pentium 4/Celeron processors require a set of heatsink and fan to cool down the processor. You need to purchase a heatsink and fan if they are not bundled with your CPU. Required is that install the set and plug its cable in the CPU fan power connector. Note that there are kinds of CPU fan connectors. Normally, if your mainboard supports a hardware monitoring function, a 3-pin fan power connector can have your system detect the CPU fan's speed. A CPU fan with a 2-pin or 4-pin fan power connector does not support the detection of the CPU fan's speed, and must directly be connected to the system's power supply unit.

Step 2.

Set Jumpers

The default jumper settings have been set for the common usage standard of this mainboard. Therefore, you do not need to reset the jumpers unless you require special adjustments as any of the following cases:

- Clear CMOS setting
- DRAM voltage setting
- DDR/SDR DRAM type selector setting
- Wake on keyboard/USB activity setting
- CPU clock setting

For first-time DIY system builders, we recommend that you not change the default jumper settings if you are not totally familiar with the mainboard configuration procedures. The factory-set default settings are tuned for optimum system performance. For the advanced users who wish to customize their system, section **3.2 Jumper Settings** will provide detailed information on how to configure your AV41P/AV41PN mainboard manually.

Step 3

Install DDRs/SDRs System Memory

To install memory, insert DDR/SDR memory module(s) in DIMM slot(s). Note that DDR/SDR modules are directional and will not go in the DIMM slots unless properly oriented. After the module is fully inserted into the DIMM slot, lift the clips of both sides of the DIMM slot to lock the module in place.

DDR SDRAM

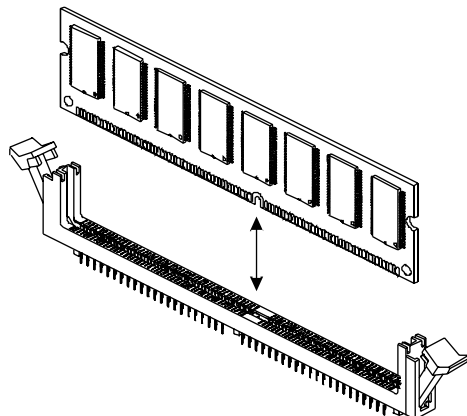

SDR SDRAM

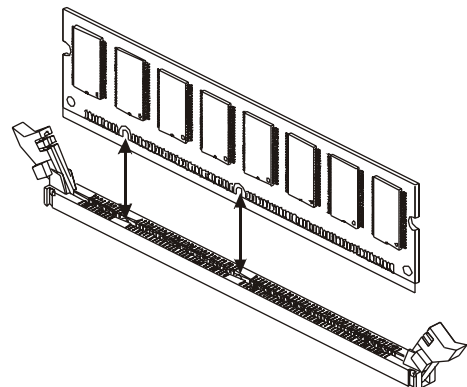

Step 4

Install Internal Peripherals in System Case

Before you install and connect the mainboard into your system case, we recommend that you first assemble all the internal peripheral devices into the computer housing, including but not limited to the hard disk drive (IDE/HDD), floppy disk drive (FDD), CD-ROM drive, and ATX power supply unit. This will greatly facilitate in making the connections to the mainboard described below.

To install IDE & FDD drives, follow this procedure:

1. Set the required jumpers on each device according to the instructions provided by the manufacturer. (IDE devices, HDD, and CD-ROM have to set jumpers to Master or Slave mode depending on whether you install more than one device of each kind.)
2. Connect IDE cable and FDD cable on the back-panel of the internal peripheral devices to the corresponding headers on board. Note that the cable should be oriented with its colored stripe (usually red or magenta) connected to pin#1 both on the mainboard IDE or FDD connector and on the device as well.
3. Connect an available power cable from your system power supply unit to the back-panel of each peripheral device. Note that the power cable is directional and cannot fit in if not properly positioned.

Step 5

Mount the Mainboard on the Computer Chassis

1. You may find that there are a lot of different mounting hole positions both on your computer chassis and on the mainboard. To choose correct mounting holes, the key point is to keep the back-panel of the mainboard in a close fit with your system case, as shown below.

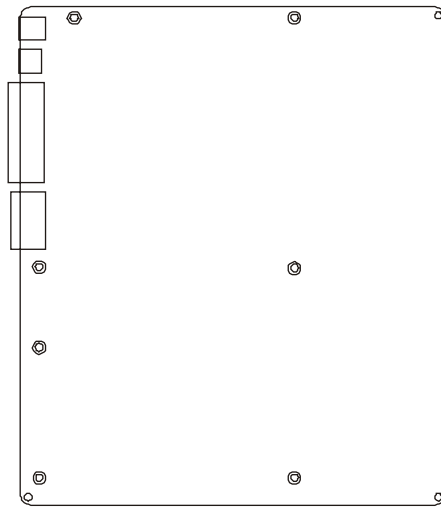

2. After deciding on the proper mounting holes, position the studs between the frame of the chassis and the mainboard. The studs are used to fix the mainboard and to keep a certain distance between the system's chassis and the mainboard, in order to avoid any electrical shorts between the board and the metal frame of the chassis. (If your computer case is already equipped with mounting studs, you will need to tighten screws to attach the mainboard.)

Note: In most computer housings, you will be able to find 4 or more attachment points to install mounting studs and then fix the mainboard. If there are not enough matching holes, then make sure to install at least 4 mounting studs to ensure proper attachment of the mainboard.

Step 6

Connect Front-Panel Switches/LEDs/USBs

You can find there are several different cables already existing in the system case and originating from computer's front-panel devices (HDD LED, Green LED, reset switch, power switch, or USB devices etc.). These cables serve to connect the front-panel switches, LEDs, and USB headers to mainboard's front-panel connector groups (Panel2 and USB1/USB2), as shown below.

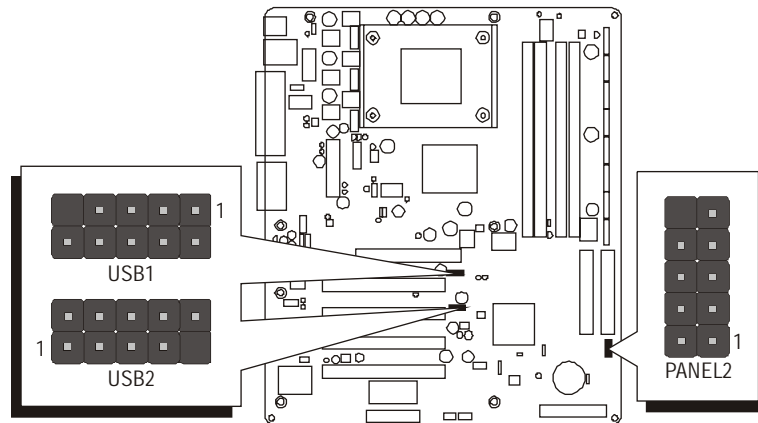

PANEL2

1. HDD LED (HD_LED)
2. Green LED (SP_LED)
3. Reset Switch (RST)
4. Power Switch (PW_BN)

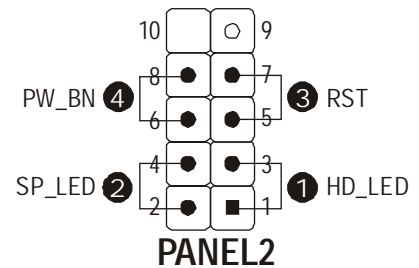

5. Extended USB headers (USB1/USB2)

⑤

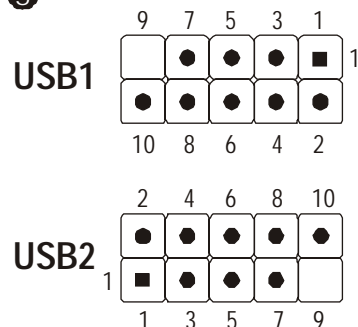

- | | |
|-------------------|-------------------|
| 1=VREG_FP_USBPWR0 | 2=VREG_FP_USBPWR0 |
| 3=USB_FP_P0- | 4=USB_FP_P1- |
| 5=USB_FP_P0+ | 6=USB_FP_P1+ |
| 7=GND | 8=GND |
| 9=KEY | 10=USB_FP_OC0 |

Step 7

Connect IDE and Floppy Disk Drives

1. IDE cable connectors

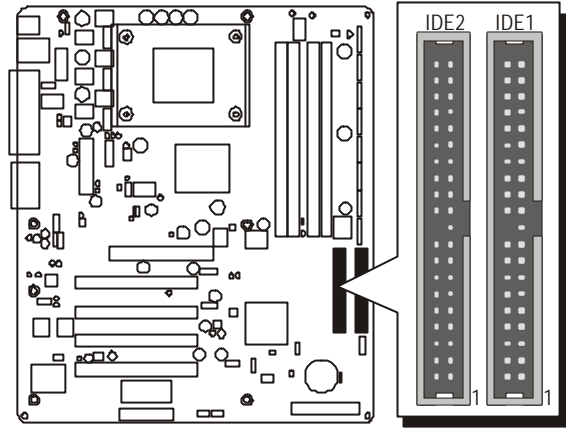

2. Floppy cable connector

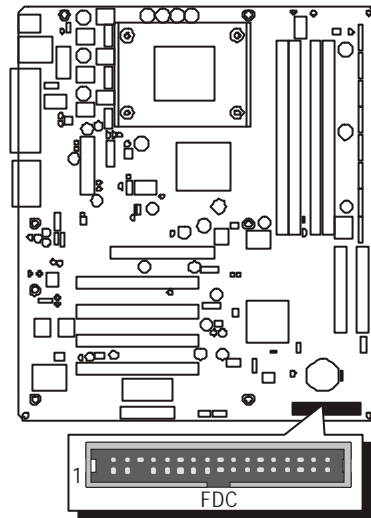

Step 8

Connect Other Internal Peripherals

1. Audio CD_IN connectors (CD1/CD2)

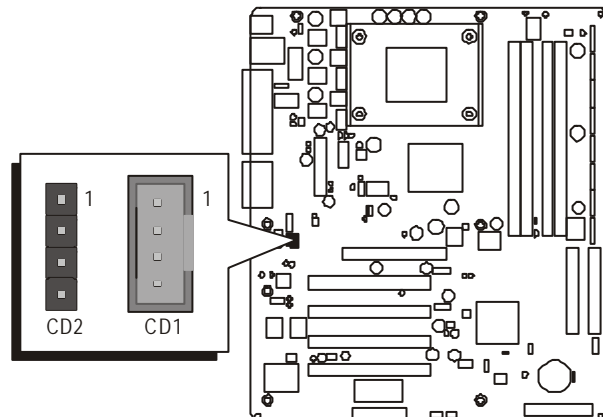

2. Front-panel audio header (PANEL1)

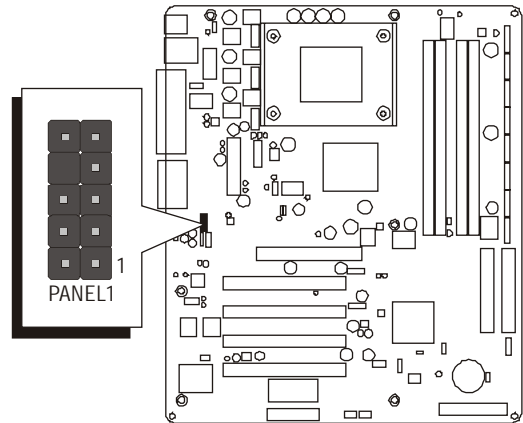

3. IR header (SIR1)

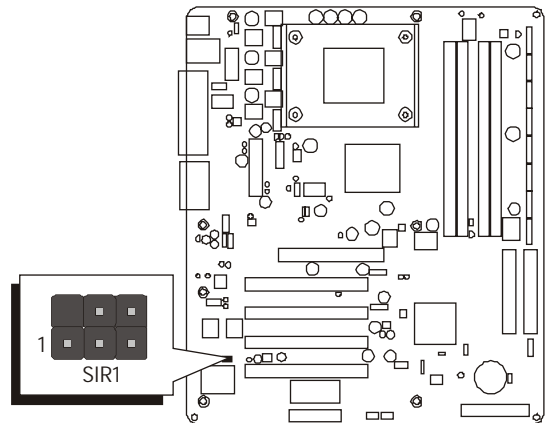

Step 9

Connect the Power Supply

1. System power connector

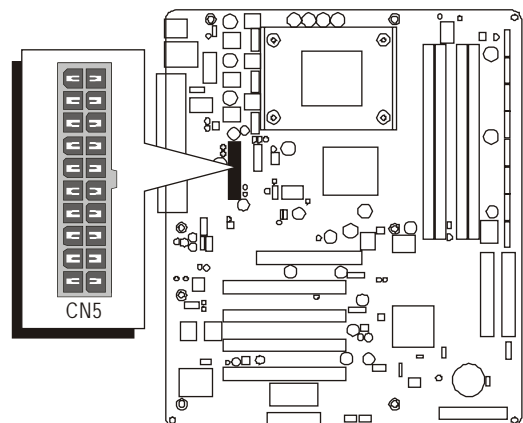

Step 10

Install Add-on Cards in Expansion Slots

1. AGP card

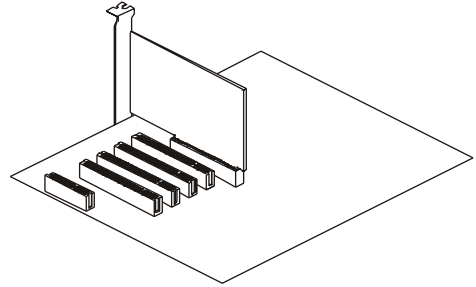

2. PCI card

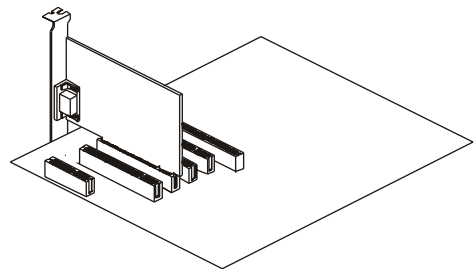

3. CNR card

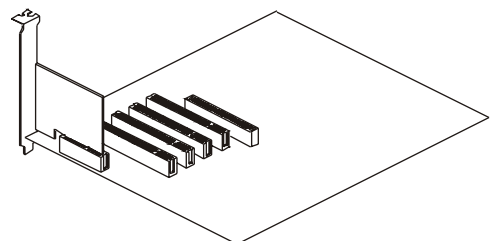

Step 11

Connect External Peripherals to Back-Panel

You are now ready to put the computer case back together and get on to the external peripheral connections to your system's back-panel.

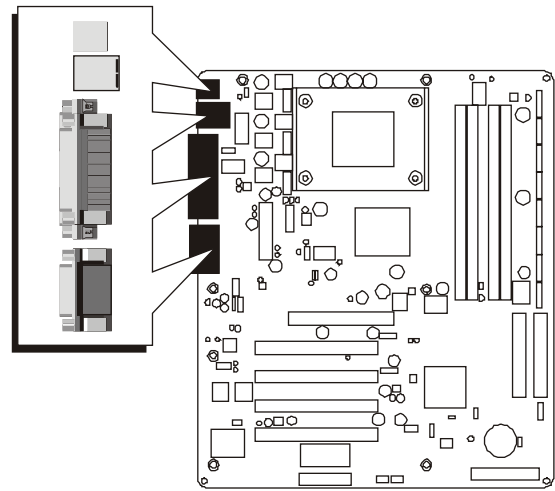

1. PS/2 Mouse & PS/2 Keyboard Ports
2. LAN Port (**AV41PN only**)
3. USB Ports1/2
4. Parallel Port
5. COM1/COM2 Ports
6. MIDI/Game Port
7. Audio Line-Out/Line-In/Mic-In Ports

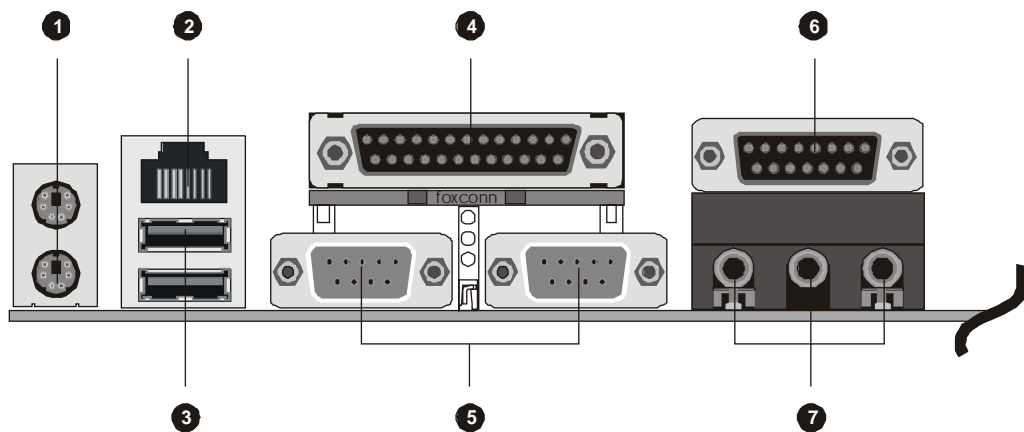

Step 12

System Boot Up For the First-Time

To ensure your system completely and correctly installed, please refer to the above installation steps once again before first booting up your system.

1. Insert a system-bootable floppy disk (DOS 6.2X, Windows 9X/NT, or others), which contains the FDISK and FORMAT utilities.
2. Turn on the system power.
3. First, you need to use the FDISK utility to create a primary partition of the hard disk. You can also add an extended partition if your primary partition does not use all of the available hard disk space. If you choose to add an extended partition, you will have to create one or more logical partitions to occupy all the space available to the extended partition. The FDISK utility will assign a drive letter (i.e. C:, D:, E:,.....) to each partition shown in the FDISK program. After the FDISK procedure, reboot your system by using the same disk.

Note: DOS 6.2X and Windows 95A can only support up to 2.1GB of HDD partition. If you use the FDISK utility with one of the operating systems mentioned above, you can only install your HDD into any partitions no larger than 2.1GB.

4. Now, use the FORMAT utility to format all the partitions you've created. When formatting the primary partition (C:), key in the command, "FORMAT C:/S."

Note: FORMAT C:/S can transfer all the necessary system files into the primary partition of your hard disk. Afterwards, your HDD will become a bootable drive.

5. Install all the necessary drivers for CD-ROM, Mouse, etc.
6. Setup the complete operating system according to your OS installation guide.

Step 13

Install Drivers & Software Components

Please note that all the system utilities and drivers are designed for Win 9x/2000/ME/XP/NT operating systems only. Make sure your operating system is already installed before running the driver's installation CD-ROM programs.

1. Insert the bundled AV41P/AV41PN CD-ROM into your CD-ROM drive. The autorun program will display the driver's main installation window on screen.
2. Choose "Install AV41P Mainboard Driver" bar to run into sub-menu for AV41P setup.
3. Choose "Install AV41PN Mainboard Driver" bar to run into sub-menu for AV41PN setup.
4. Choose "Install VIA Chipset Driver" and complete it.
5. Choose "Install Audio Driver" and complete it.
6. Choose "Install USB2.0 Driver" and complete it.
7. Choose "Install LAN Driver" and complete it. **(AV41PN only)**
8. Exit from the autorun driver's installation program.

⊗ Please refer to section **Chapter 4 Software Utility** to install drivers.

3.2 Jumper Settings

Several hardware settings are made through the use of mini jumpers to connect jumper pins on the mainboard. Pin #1 could be located at any corner of each jumper, you just find the location with a white right angle which stands for pin 1#. There are several types of pin 1# shown as below:

3-pin and multi (> 3) pin jumpers shown as following:

Pin #1 to the left:



Pin #1 on the top:





Pin #1 to the right:



Pin #1 on the bottom:



Jumpers with two pins are shown as  for Close [On] or  for Open [Off]. To short jumper pins, simply place a plastic mini jumpers over the desired pair of pins.

Caution!

1. Do not remove the mainboard from its antistatic protective packaging until you are ready to install it.
2. Carefully hold the mainboard by its edges and avoid touching its components. When putting the mainboard down, place it on top of its original packaging film, on an even surface, and components side up.
3. Wear an antistatic wrist strap or take other suitable measures to prevent electrostatic discharge (ESD) whenever handling this equipment.

Jumpers & Connectors Guide

Use the mainboard layout on page 11 to locate CPU socket, memory banks, expansion slots, jumpers and connectors on the mainboard during the installation. The following list will help you to identify jumpers, slots, and connectors along with their assigned functions:

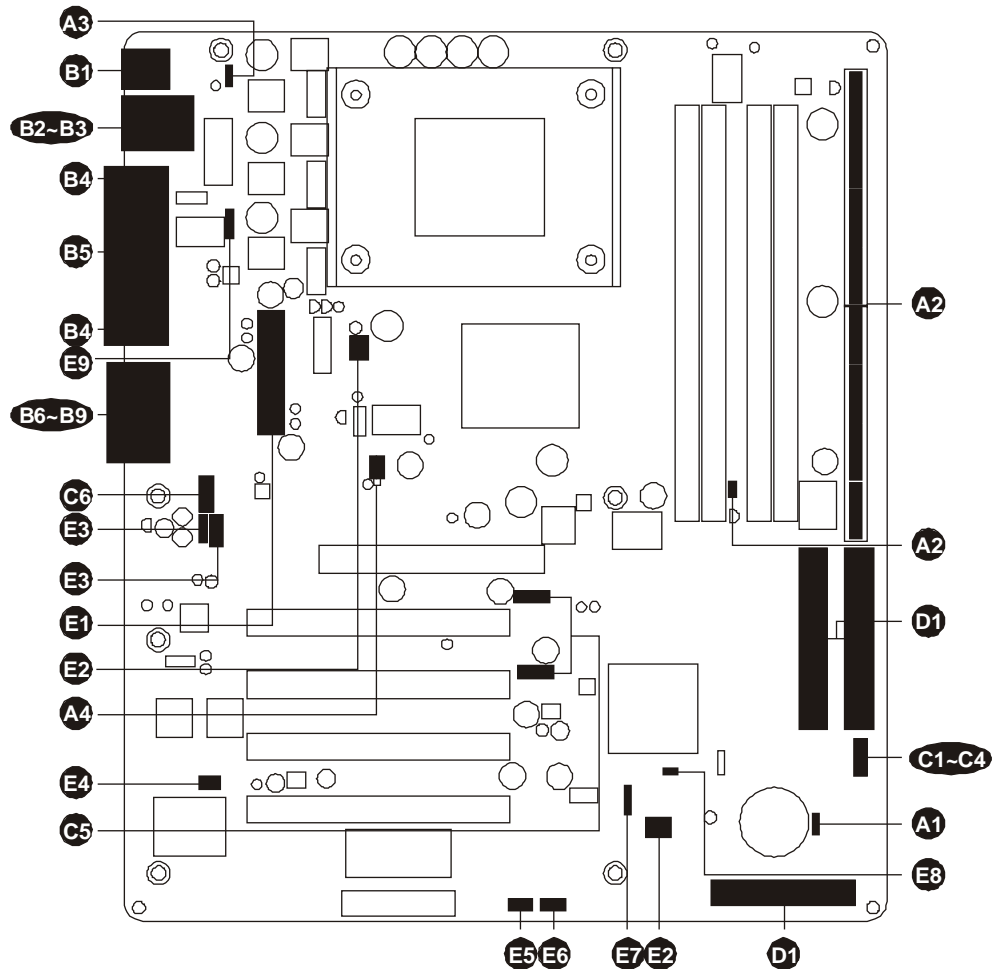

CPU/Memory/Expansion Slots

- | | |
|-----------------|---|
| Socket 478 | : CPU Socket for Intel Pentium 4/Celeron processors |
| DDR1/2 | : Two 184-pin DIMM Slots for 128, 256, 512 MB, and 1GB of 2.5V DDR SDRAM
(The total installed memory does not exceed 2GB.) |
| DIMM1/2 | : Two 168-pin DIMM Slots for 128, 256, 512 MB, and 1GB of 3.3V SDR SDRAM
(The total installed memory does not exceed 2GB.) |
| Expansion Slots | : Four 32-bit PCI Slots; one AGP Slot; one CNR Slot |

Jumpers

A1	JBAT1	: Clear CMOS setting
A2	JP1	: DRAM voltage setting
A2	J2A/B/C/D & J3A/B/C/D	: DDR/SDR DRAM type selector setting
A3	JP2	: Wake on keyboard/USB activity setting
A4	JP1A1/JP1B1	: CPU clock setting

Back-Panel Connectors

B1	KB	: PS/2 keyboard port
B1	MS	: PS/2 mouse port
B2	USB1/USB2	: 2 USB(Universal Serial Bus) ports
B3	LAN	: RJ45 LAN port (AV41PN only)
B4	COM1/COM2	: Serial ports 1/2 (DB9 male)
B5	PRINTER	: Parallel port (DB25 female)
B6	LINE-OUT	: Line-Out port
B7	LINE-IN	: Line-In port
B8	MIC-IN	: Mic-In port
B9	MIDI/GAME	: MIDI/Game port

Front-Panel Connectors

C1	HDD	: IDE drive active LED
C2	SPD-LED	: Green LED
C3	RESET	: Hardware reset switch
C4	POWER ON/OFF	: ATX power on/off momentary type switch
C5	USB1/USB2	: Extended USB headers
C6	PANEL1	: Front-panel audio header

Internal Peripheral Connectors

D1	FDC	: Floppy disk drive interface
D1	IDE1	: IDE primary interface (dual-channel)
D1	IDE2	: IDE secondary interface (dual-channel)

Other Connectors

E1	CN5	: ATX power connector
E2	CPU_FAN	: CPU fan connector
E2	SYSTEM_FAN	: System fan connector
E3	CD1/CD2	: Audio CD_IN connectors

Ⓔ4	SIR1	: IR header
Ⓔ5	WOM1	: Wake-On-Modem connector
Ⓔ6	WOL1	: Wake-On-LAN connector
Ⓔ7	SPK1	: Internal speaker header
Ⓔ8	J12	: Sleep switch header
Ⓔ9	J16	: LAN LED Indicator header (AV41PN only)

🔑 Jumpers

Ⓐ Clear CMOS Setting (JBAT1)

JBAT1 is used to clear CMOS data. Clearing CMOS will result in the permanently erasing previous system configuration settings and the restoring original (factory-set) system settings.

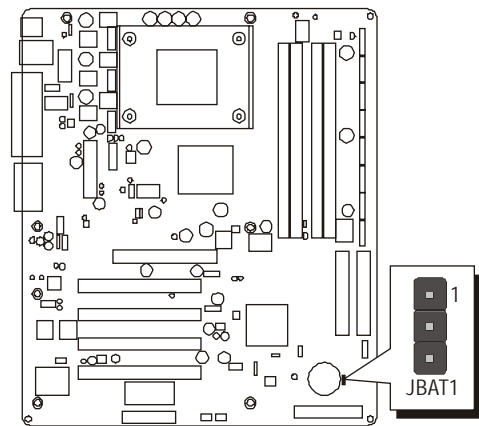
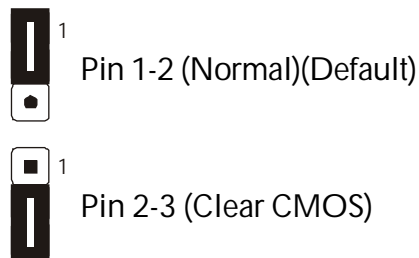

- Step 1.** Turn off the system power (PC-> Off).
- Step 2.** Remove ATX Power cable from ATX Power connector.
- Step 3.** Remove jumper cap from JBAT1 pins 1-2.
- Step 4.** Place the jumper cap on JBAT1 pins 2-3 for a few seconds.
- Step 5.** Return the jumper cap to pins 1-2.
- Step 6.** Plug ATX Power cable into ATX Power connector.
- Step 7.** Turn on the system power (PC-> On).

A2 DRAM Voltage Setting (JP1)

JP1 is set to select voltage of DRAM.

 Pin 1-2 (Short: 3V SDR) (Default)

 Pin 1-2 (Open: 2.5V DDR)

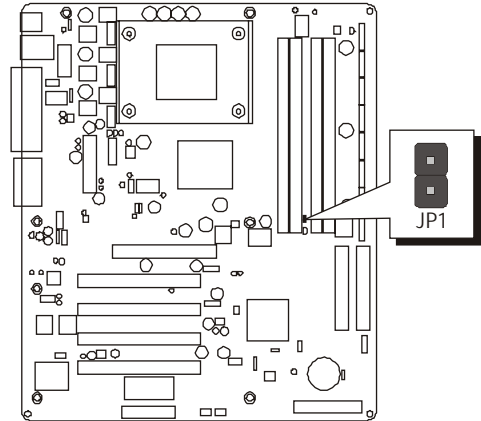

A2 DDR/SDR DRAM Type Selector Setting (J2A/B/C/D & J3A/B/C/D)

J2A/B/C/D and J3A/B/C/D are set to select the type of DDR or SDR DRAM.

Note: You may use DDR or SDR SDRAM, but you can't use them simultaneously.

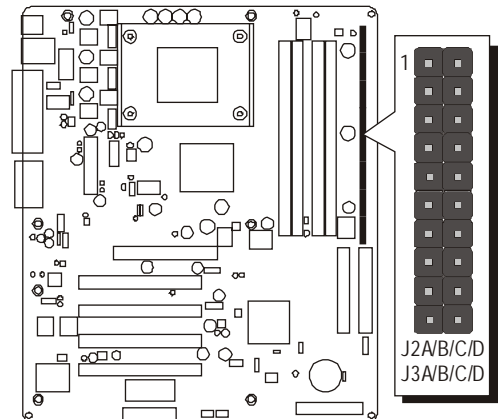

When DDR SDRAM is installed, please short all J2A/B/C/D and J3A/B/C/D pins.



When SDR SDRAM is installed, please open all J2A/B/C/D and J3A/B/C/D pins.

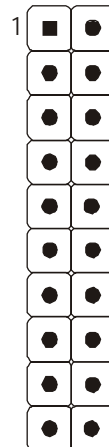

A3 Wake On Keyboard/USB Activity Setting (JP2)

This jumper enables any keyboard activity to power up a system which is previously in a standby or sleep state.

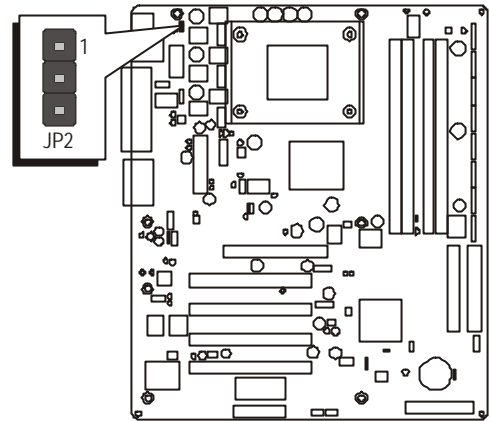
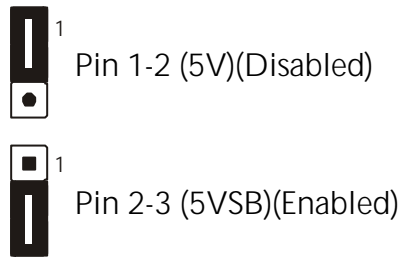

A4 CPU Clock Setting (JP1A1/JP1B1)

This jumper enables user to select CPU frequency.

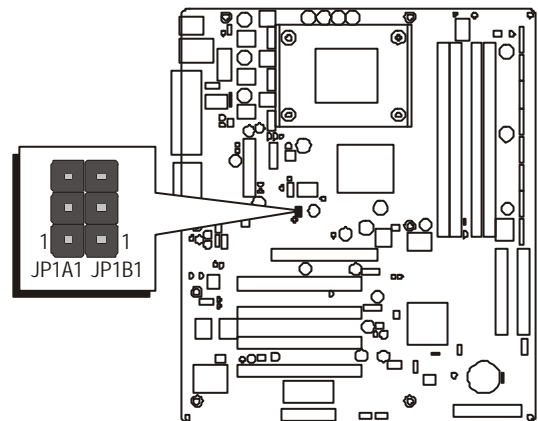
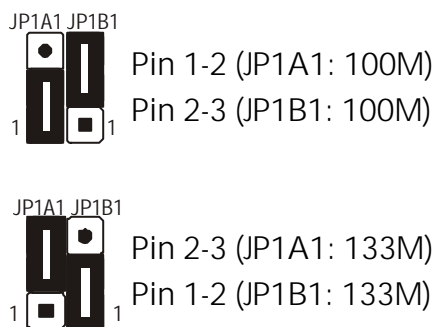

☛ **Back-Panel Connectors**

B1 PS/2 Keyboard & PS/2 Mouse Connectors

Two 6-pin female PS/2 Keyboard & PS/2 Mouse connectors are located on the rear panel of the mainboard. Depending on the computer housing you use (desktop or tower), the PS/2 Mouse connector is situated at the top of the PS/2 Keyboard connector when the mainboard is laid into a desktop, as opposed to a tower where the PS/2 Mouse connector is located at the right of the PS/2 Keyboard's. Plug the PS/2 Keyboard and PS/2 Mouse jacks into their corresponding connectors.

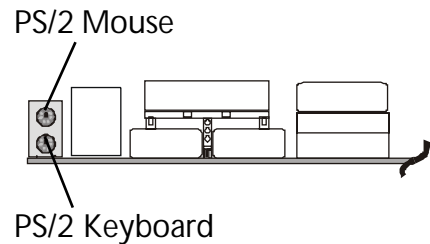

B2 USB1/USB2 Port Connectors

This mainboard offers 2 USB ports on front-panel. Plug each USB device jack into an available USB1/USB2 connector.

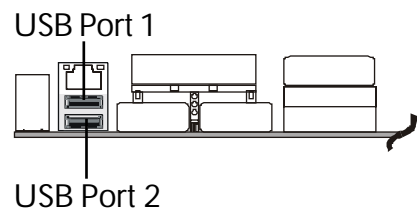

B3 LAN Port Connector (AV41PN only)

This mainboard can accommodate one device on LAN.
Attach a 10/100 base-T cable to the RJ45 at the back-panel of your computer.

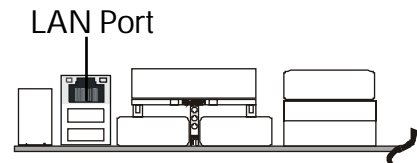

B4 COM1/COM2 Port Connectors

This mainboard can accommodate two serial devices on COM1/COM2. Attach a serial device cable to the DB9 serial port COM1/COM2 on the back-panel of your computer.

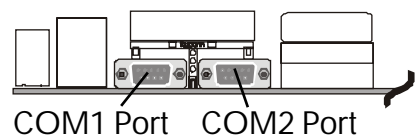

B5 Parallel Port Connector

One DB25 female parallel connector is located on the rear panel of the mainboard. Plug the connection cable from your parallel device (printer, scanner, etc.) into this connector.

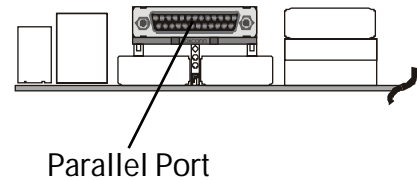

B6 Line-Out Port Connector

Line-Out is a stereo output port through which the combined signal of all internal and external audio sources on the board is output. It can be connected to 1/8-inch TRS stereo headphones or to amplified speakers.

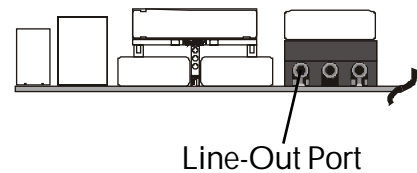

B7 Line-In Port Connector

Line-In is a stereo line-level input port that accepts a 1/8-inch TRS stereo plug. It can be used as a source for digital sound recording, a source to be mixed with the output, or both.

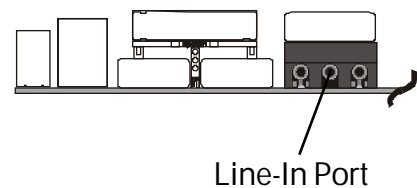

B8 Mic-In Port Connector

Mic-In is a 1/8-inch jack that provides a mono input. It can use a dynamic mono or stereo microphone with a resistance of not more than 600 Ohms.

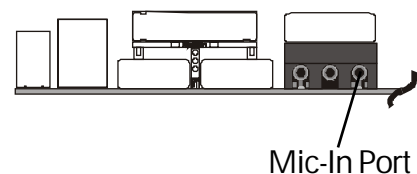

B9 MIDI/Game Port Connector

The MIDI/Game port is a 15-pin female connector. This port can be connected to any IBM PC compatible game with a 15-pin D-sub connector.

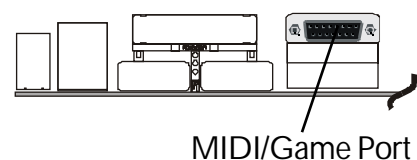

MIDI Instrument Connection

You will need a MIDI adapter to connect a MIDI compatible instrument to the sound card. The MIDI adapter can in turn be connected to the Joystick/MIDI port. You will also need the MIDI sequencing software to run MIDI instruments with your computer into this connector.

👉 **Front-Panel Connectors**

🕒 **HDD LED Connector (HD_LED)**

Attach the connector cable from the IDE device LED to the 2-pin (HD_LED) header. The HDD LED lights up whenever an IDE device is active.

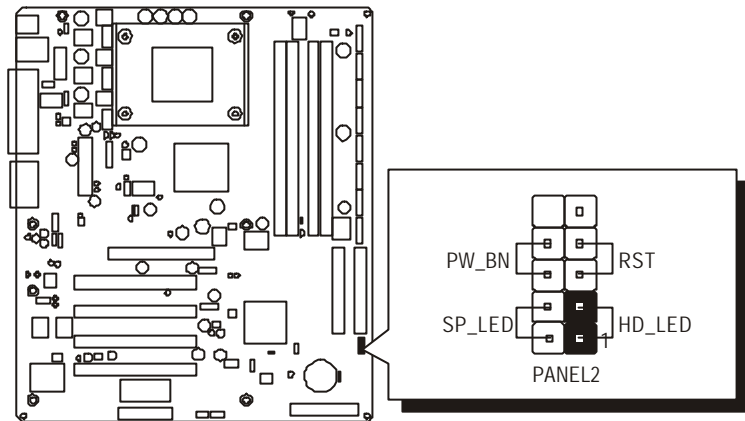

Note : Please notice all the LED connectors are directional. If your chassis's LED does not light up during running, please change it to an opposite direction.

🕒 **Green LED Connector (SP_LED)**

The Green LED indicates that the system is currently in one of the power saving modes (Doze/Standby/Suspend). When the system resumes to a normal operation mode, the Green LED will go off. Attach a 2-pin Green LED cable to (SP_LED) header.

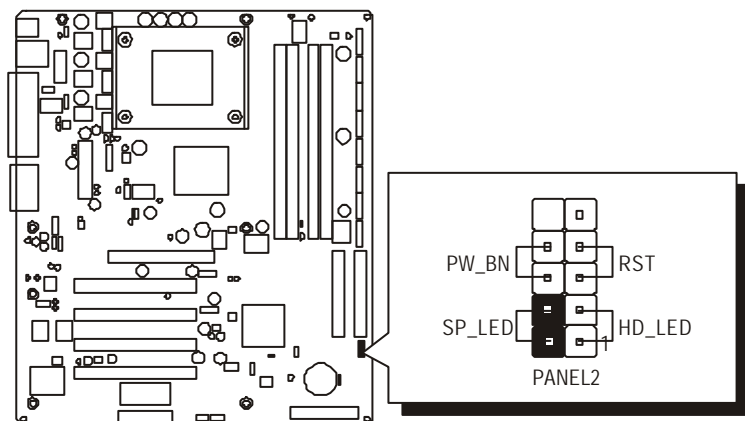

③ Hardware Reset Connector (RST)

Attach the 2-pin hardware reset switch cable to the (RST) header. Pressing the reset switch causes the system to restart.

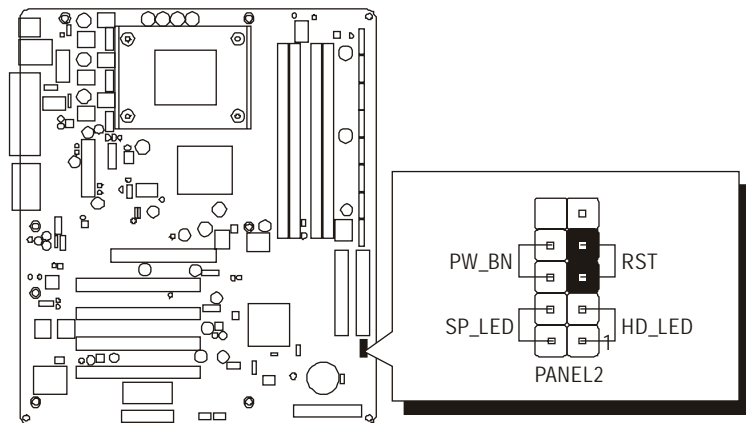

④ ATX Power On/Off Switch Connector (PW_BN)

The Power On/Off Switch is a momentary type switch used for turning on or off the system ATX power supply. Attach the connector cable from the Power Switch to the 2-pin (PW_BN) header on the mainboard.

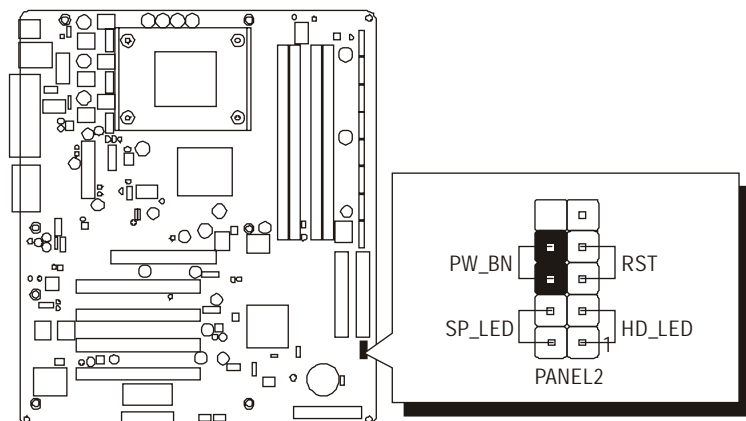

⑤ Extended USB Headers (USB1/USB2)

These headers are used to connect cables to USB connectors mounted on front-panel or back-panel. The USB cable is optional at the time of purchase.

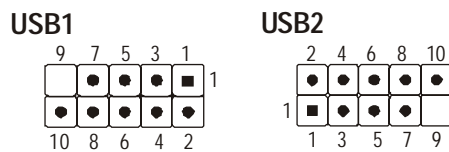

Pin Assignments:

1=VREG_FP_USBPWR0	2=VREG_FP_USBPWR0
3=USB_FP_P0-	4=USB_FP_P1-
5=USB_FP_P0+	6=USB_FP_P1+
7=GND	8=GND
9=KEY	10=USB_FP_OC0

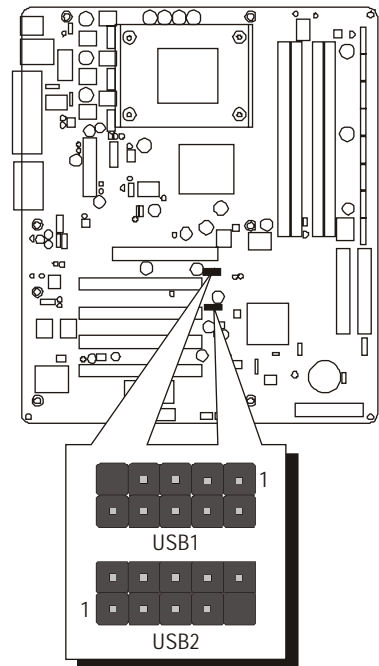

⑥ Front-Panel Line-Out/Mic-In Header (PANEL1)

This header allows users to install an auxiliary Front-Oriented Line_Out/Mic-In port for easier access. Either the Line-Out/Mic-In port connector on back-panel or PANEL1 header is available at the same time. If you would like to use this header, please remove all jumpers from this header and install your special extra Line_Out/Mic-In cable instead. Two mini jumpers must be setted on pins 5-6 and pins 9-10, when this header is not used.

Pin Assignments:

10	9	1=MIC IN	2=GND
8	7	3=VCCM	4=+5V AUDIO
6	5	5=LINE OUT (R)	6=LINE OUT (R)
4	3	7=NC	8=EMPTY
2	1	9=LINE OUT (L)	10=LINE OUT (L)

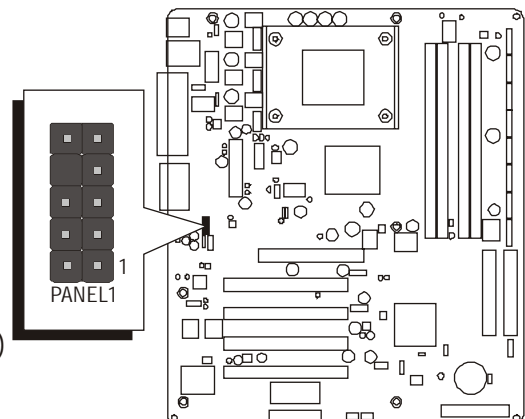

☞ *Internal Peripheral Connectors*

① **Enhanced IDE and Floppy Connectors**

AV41P/AV41PN mainboard features two 40-pin dual-channel IDE device connectors (IDE1/IDE2), providing support for up to four IDE devices, such as CD-ROM and Hard Disk Drive (HDD). This mainboard also includes one 34-pin floppy disk controller (FDC) to accommodate the Floppy Disk Drive (FDD). Moreover, this mainboard comes with one 80-pin ATA **133/100/66** ribbon cable to connect IDE HDD, and one 34-pin ribbon cable for FDD

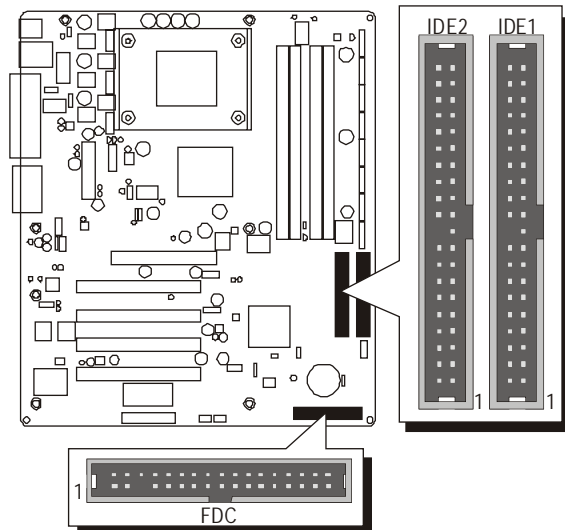

Important: Ribbon cables are directional; therefore, connect the red cable stripe to the same side.

Other Connectors

ATX Power Supply Connector (CN5)

This motherboard uses 20-pin standard Pentium 4 ATX power header (CN5). Please make sure you plug it in the right direction.

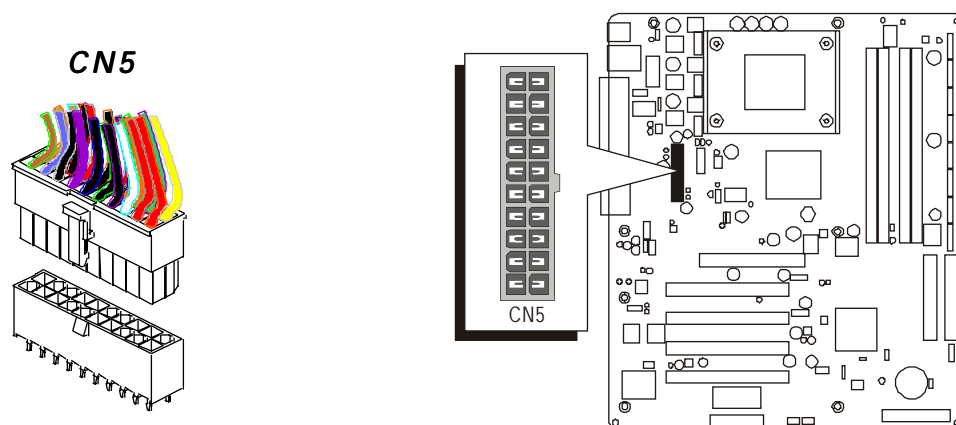

A traditional ATX system remains in the power-off stage when AC power resumes from power failure. However, it is inconvenient for a network server or workstation if there is not an UPS to execute power-on. Thus, this motherboard supports an AC Power Auto Recovery function to solve this problem. You may enable the function, "Restore On AC/Power Loss," in the sub-menu of "Power Management Setup" within the BIOS setup program.

- | | |
|----------------|---|
| Note 1: | The ATX power connector is directional and will not go in unless the guides match perfectly, making sure that pin#1 is properly positioned. |
| Note 2: | Make sure the latch of the ATX power connector clicks into place to ensure a solid attachment. |
| Note 3: | Your ATX power supply must be supplied to ACPI +5V standby power and at least 720mA compatible. |
| Note 4: | Make sure your power supply have enough power for higher speed processor installed. |

E2 Cooling Fan Connectors (CPU_FAN/SYSTEM_FAN)

AV41P/AV41PN mainboard provides two onboard 12V cooling fan power connectors to support CPU (CPU_FAN), and System (SYSTEM_FAN) cooling fans.

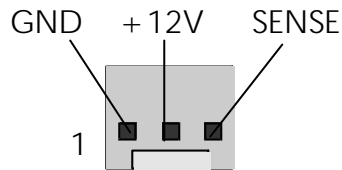

Note: Both cable wiring and type of plug may vary, which depend on the fan maker. Keep in mind that the red wire should always be connected to the +12V header and the black wire to the ground (GND) header.

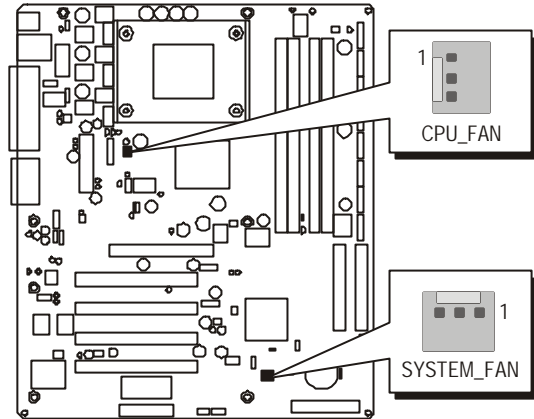

E3 Audio CD_IN Connectors (CD1/CD2)

Ports CD1/CD2 are used to attach audio connector cables from the CD-ROM/DVD-ROM drives.

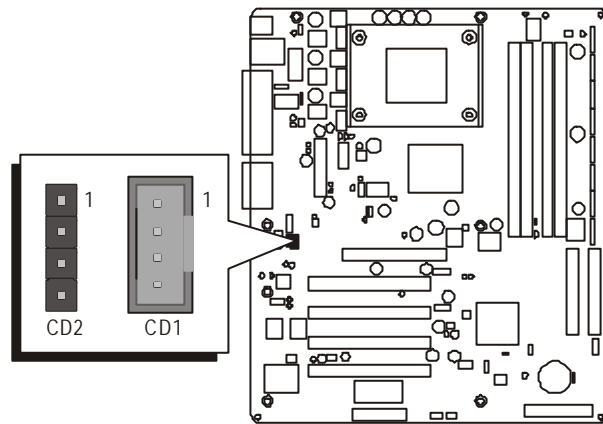

E4 IR Header (SIR1)

The mainboard supports a Serial Infrared (SIR) data port. Infrared ports allow the wireless exchange of information between your computer and similarly equipped devices such as printers, laptops, Personal Digital Assistants (PDAs), and other computers.

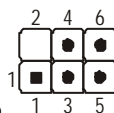

Pin Assignments:

- 1=N/A 2=KEY
- 3=+5V 4=GND
- 5=IRTX 6=IRRX

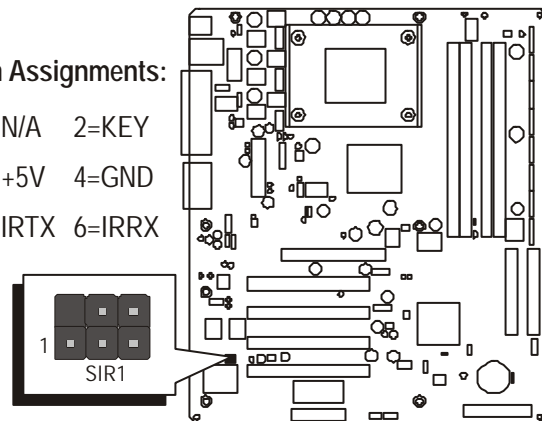

E5 Wake-On-Modem Connector (WOM1)

If you have installed a modem, use the cable provided with the modem to plug into the mainboard WOM1 connector. This enables the Wake-On-Modem (WOM) feature. When your system is in a power-saving mode, any modem signal automatically resumes the system. You must enable this item using the Power Management page of the Setup Utility.

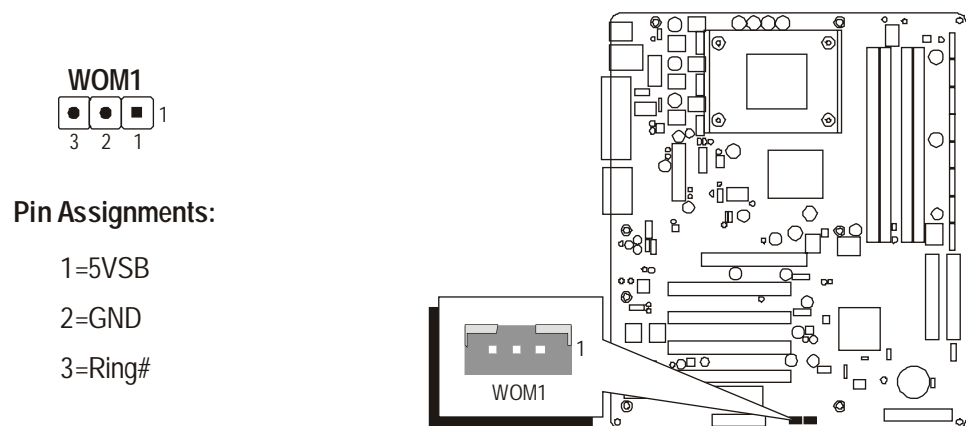

E6 Wake-On-LAN Connector (WOL1)

Attach a 3-pin connector through the LAN card which supports the Wake-On-LAN (WOL1) function. This function lets users wake up the connected system through the LAN card.

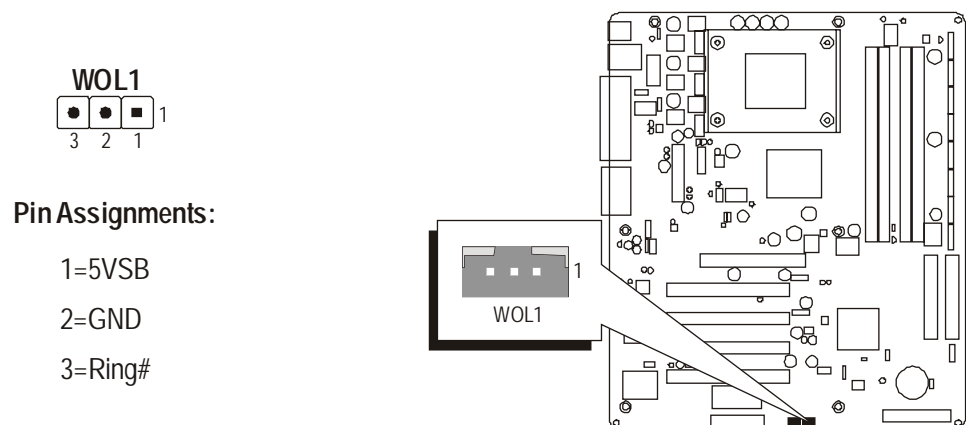

E7 Internal Speaker Header (SPK1)

Attach the PC speaker cable from the case to the 4-pin speaker connector (SPK1).



Pin Assignments:

- 1=SPKR
- 2=NC
- 3=GND
- 4=+5V

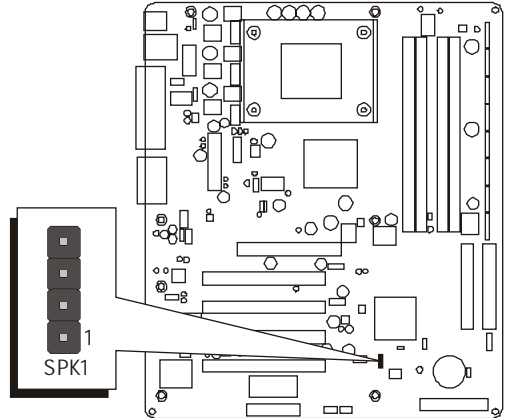

E8 Sleep Switch Header (J12)

This header is connected to the sleep button for suspending the computer's activity if pushing the button. Or, the computer is automatically suspended after passing a period of time.

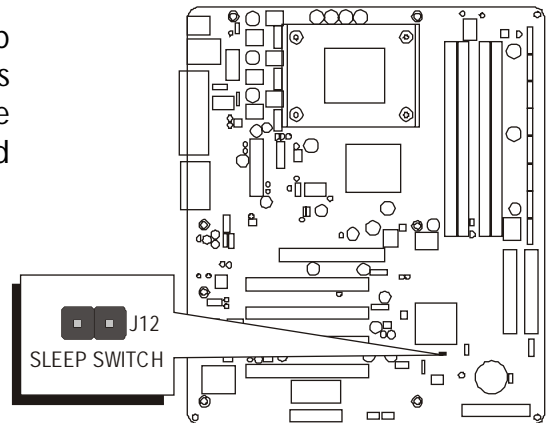

E9 LAN LED Indicator Header (J16) (AV41PN Only)

This connected is attached to LAN device that needs a LED indicator.

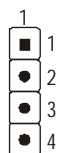

Pin Assignments:

- 1=Link LED
- +2=Link LED
- +3=ACT LED
- 4=ACT LED

Note: The plus sign (+) indicates a pin which must be connected to a positive voltage.

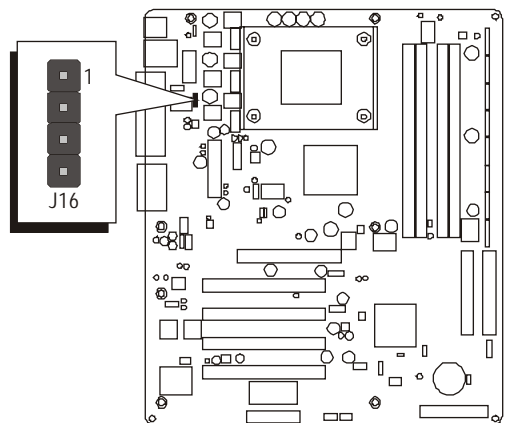

3.3 System Memory Configuration

The AV41P/AV41PN mainboard has two 184-pin and two 168-pin DIMM slots that allow you to install from 64MB up to 2GB of system memory. Each 184-pin DIMM (Dual In-line Memory Module) slot can accommodate 64MB, 128MB, 256MB, 512MB, and 1GB of PC1600/PC2100 compliant 2.5V single or double side 64-bit wide data path DDR SDRAM modules. Each 168-pin DIMM slot can accommodate 64MB, 128MB, 256MB, 512MB, and 1GB of PC100/PC133 compliant 3.3V single or double side 64-bit wide data path SDR SDRAM modules.

Install Memory:

Install memory in any or all of the slots and in any combination shown as follows.

DDR SDRAM

DIMM Slot	Memory Modules	Module Quantity
DDR 1	64MB, 128MB, 256MB, 512MB and 1GB 184-pin 2.5V DDR SDRAM DIMM	x 1
DDR 2	64MB, 128MB, 256MB, 512MB and 1GB 184-pin 2.5V DDR SDRAM DIMM	x 1

SDR SDRAM

DIMM Slot	Memory Modules	Module Quantity
DIMM 1	64MB, 128MB, 256MB, 512MB and 1GB 168-pin 3.3V SDR SDRAM DIMM	x 1
DIMM 2	64MB, 128MB, 256MB, 512MB and 1GB 168-pin 3.3V SDR SDRAM DIMM	x 1

Important: *You can choose 184-pin DDR SDRAM or 168-pin SDR SDRAM to boot, but the system doesn't start if you use both of them at the same time!*

Note: You need to set jumpers to configure memory by jumper JP1 & J2A/B/C/D & J3A/B/C/D. Please refer to page 29. You can check the total system memory value in the BIOS Standard CMOS Setup menu.

Upgrade Memory:

You can easily upgrade the system memory by inserting additional DRAM modules in available DIMM slots. The total system memory is calculated by simply adding up the memory in all DIMM slots. After upgrade, the new system memory value will automatically be computed and displayed in the field "Standard CMOS Setup" of BIOS setup program.

4 SOFTWARE UTILITY

4.1 Mainboard CD Overview

Note: The CD contents attached in AV41P/AV41PN mainboard are subject to change without notice.

To start your mainboard CD disc, just insert it into your CD-ROM drive and the CD AutoRun screen should appear. If the AutoRun screen does not appear, double click or run D:\Autorun.exe (assuming that your CD-ROM drive is drive D:).

Navigation Bar Description:

- ☞ **Install AV41P Mainboard Driver** - Installing VIA Chipset, Audio, and USB 2.0 drivers.
- ☞ **Install AV41PN Mainboard Driver** - Installing VIA Chipset, Audio, USB 2.0, and LAN drivers.
- ☞ **Manual** - AV41P/AV41PN mainboard user's manual in PDF format.
- ☞ **Link to Shuttle Homepage** - Link to Shuttle website homepage.
- ☞ **Browse this CD** - Allows you to see contents of this CD.
- ☞ **Quit** - Close this CD.

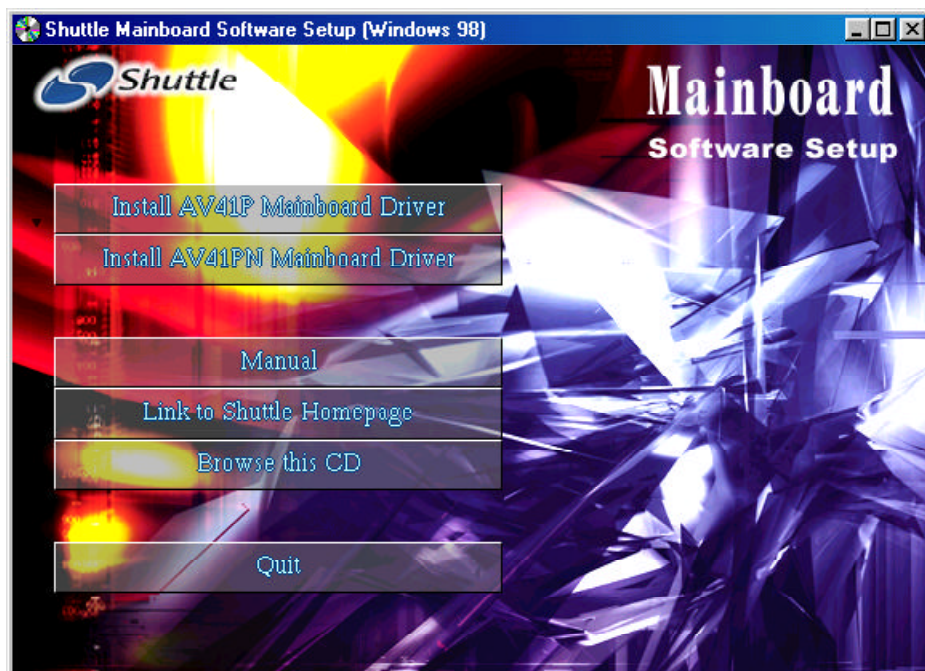

4.2 Install Mainboard Software

Insert the attached CD into your CD-ROM drive and the CD AutoRun screen should appear. If the AutoRun screen does not appear, double click on Autorun icon in **My Computer** to bring up **Shuttle Mainboard Software Setup** screen.

Select using your pointing device (e.g. mouse) on the "Install Mainboard Driver" bar to run into sub-menu.

The **Mainboard AV41P Driver** include:

- [4.2.A] Install VIA Chipset Driver
- [4.2.B] Install Audio Driver
- [4.2.C] Install USB 2.0 Driver



The **Mainboard AV41PN Driver** include:

- [4.2.A] Install VIA Chipset Driver
- [4.2.B] Install Audio Driver
- [4.2.C] Install USB 2.0 Driver
- [4.2.D] Install LAN Driver



4.2.A Install VIA Chipset Driver

Select using your pointing device (e.g. mouse) on the "Install VIA Chipset Driver" bar to install VIA chipset driver.

AV41P



AV41PN



Once you made your selection, a Setup window run the installation automatically.

When the copying files is done, make sure you **reboot** the system to take the installation effect.

4.2.B Install Audio Driver

Select using your pointing device (e.g. mouse) on the "Install Audio Driver" bar to install AC'97 Audio driver.

AV41P



AV41PN



Once you made your selection, a Setup window run the installation automatically.

When the copying files is done, make sure you **reboot** the system to take the installation effect.

4.2.C Install USB 2.0 Driver

Select using your pointing device (e.g. mouse) on the "Install USB 2.0 Driver" bar to install USB 2.0 driver.

AV41P

Once you made your selection, a Setup window run the installation automatically. When the copying files is done, make sure you **reboot** the system to take the installation effect.

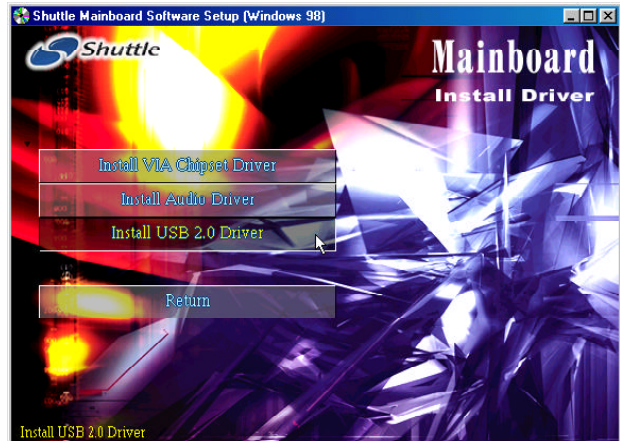

AV41PN

Once you made your selection, a Setup window run the installation automatically. When the copying files is done, make sure you **reboot** the system to take the installation effect.

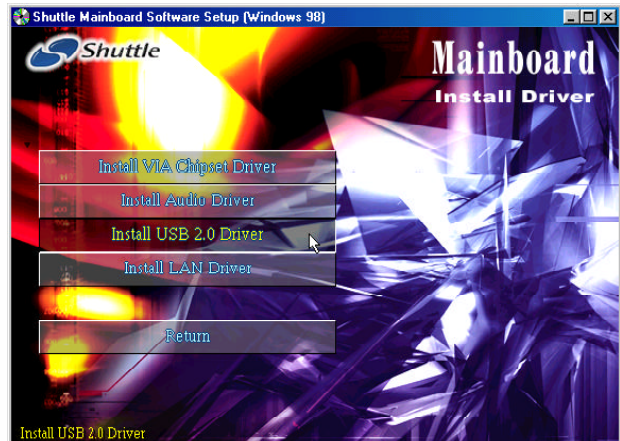

4.2.D Install LAN Driver (AV41PN only)

Select using your pointing device (e.g. mouse) on the "Install LAN Driver" bar to install LAN driver.

Once you made your selection, a Setup window run the installation automatically. When the copying files is done, make sure you **reboot** the system to take the installation effect.

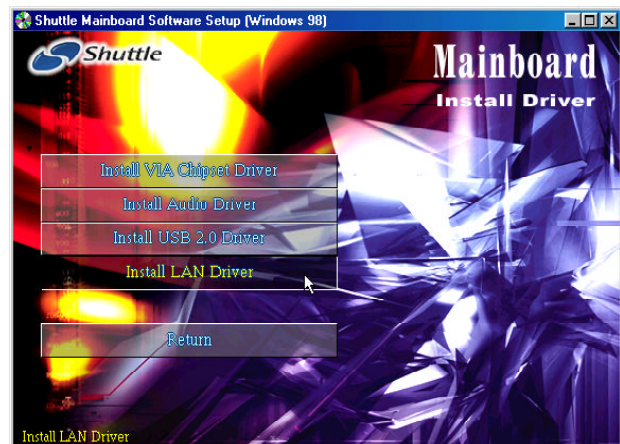

4.3 View the User's Manual

Insert the attached CD into your CD-ROM drive and the CD AutoRun screen should appear. If the AutoRun screen does not appear, double click on AutoRun icon in **My Computer** to bring up **Shuttle Mainboard Software Setup** screen.

Select using your pointing device (e.g. mouse) on the "Manual" bar.

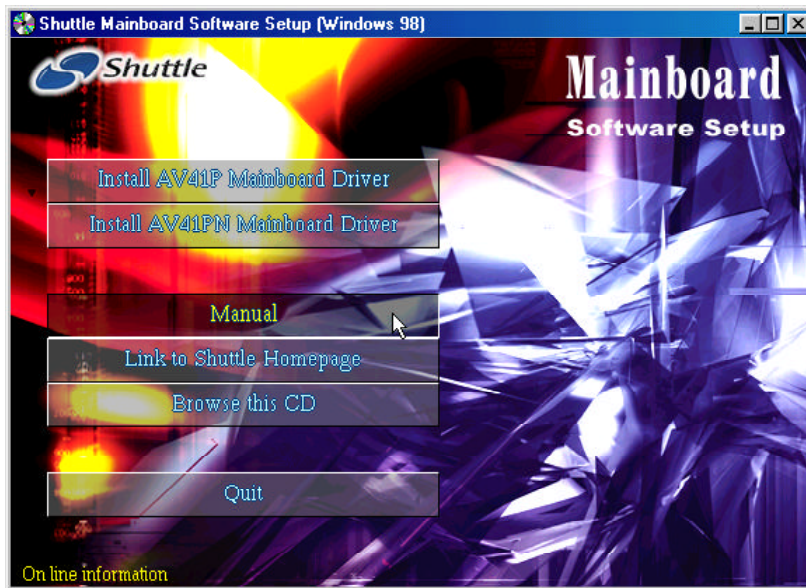

Then **Online Information** windows will appear on your screen. Click on the "Install Acrobat Reader" bar if you need to install acrobat reader.



Then click on "AV41P/AV41PN Manual" bar to view user's manual.

5 BIOS SETUP

AV41P/AV41PN mainboard's BIOS ROM has a built-in setup program that allows users to modify the basic system configuration. The information is stored in battery-backed RAM so that it is retained even if the system power turns off.

The system BIOS manages and executes a variety of related hardware functions in the system, including:

System date and time

Hardware execution sequence

Power management functions

Allocation of system resources

5.1 Enter the BIOS

To enter the BIOS (Basic Input/Output System) utility, please follow these two steps:

- Step 1.** Turn on the computer, and the system will perform its POST (Power-On Self Test) routine checks.
- Step 2.** As you see the message "Hit **F2** if you want to run setup.", press < F2 > key immediately.

Note 1. If you miss to enter BIOS (the message disappears before you can respond) and want to enter BIOS setup again, restart the system by pressing the < RESET > switch on computer's front-panel, or simultaneously pressing the < Ctrl > , < Alt > , < Del > keys.

- Step 3.** As you enter the BIOS program, the CMOS Setup Utility will show you the Main Menu, as shown in the next section.

5.2 The Main Menu

Once you enter the AMIBIOS(tm) CMOS Setup Utility, the Main Menu will appear on the screen. The Main Menu allows you to select from several setup functions and two exit choices. Use the arrow keys to select among the items and press < Enter > to accept and enter the sub-menu.

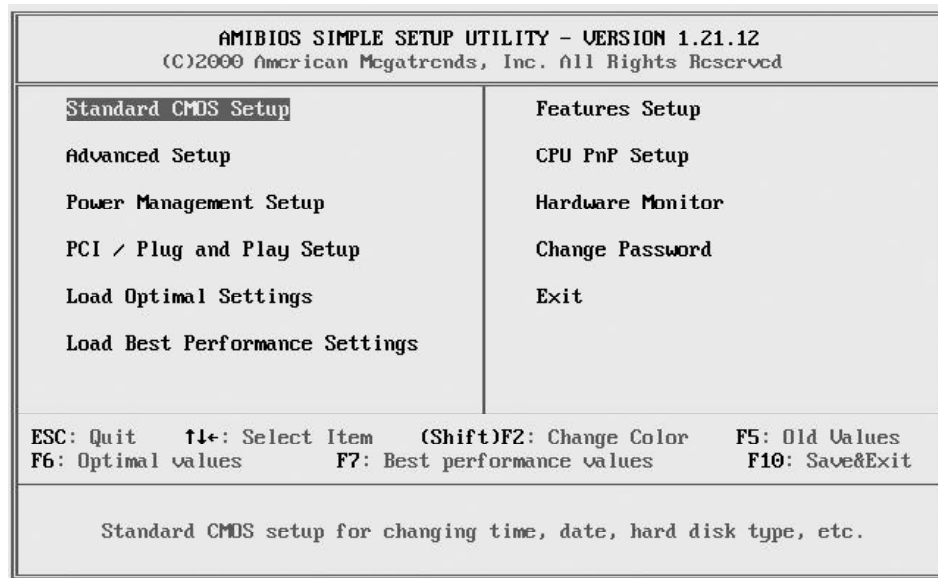

Note that a brief description of each highlighted selection appears at the bottom of the screen.

Standard CMOS Setup

This setup page includes all items in a standard compatible BIOS.

Advanced Setup

This setup page includes all items of Advanced features.

Power Management Setup

This setup page includes all items of Power Management features.

PCI / Plug and Play Setup

This page sets some of the parameters for devices installed on the PCI bus and devices that use the system plug and play capability.

Load Optimal Settings

Optimal settings load the values required by the System for the fail-safe performance. However, you can change the parameter through each Setup Menu.

Load Best Performance Settings

Fail Safe settings load the values required by the system for the best performance. However, you can change the parameter through each Setup Menu.

Features Setup

This setup page includes all items of peripheral features.

CPU PnP Setup

This setup page includes all items of CPU PnP features.

Hardware Monitor

This setup page includes all items of Hardware Monitor features.

Change Password

Change, set, or disable password. It allows you to limit access to the system and Setup, or just to Setup.

Exit

Save all the CMOS values changed to CMOS and exit setup.

Standard CMOS Setup

The items in Standard CMOS Setup Menu are divided into 8 categories. Each category includes no, one or more than one setup items. Use the arrow keys to highlight the item and then use the < PgUp > or < Pg-Dn > keys to select the value you want in each item.

AMIBIOS SETUP - STANDARD CMOS SETUP									
(C)2000 American Megatrends, Inc. All Rights Reserved									
Date (mm/dd/yyyy): Sun Dec 22, 2002									
Time (hh/mm/ss) : 20:56:43									
	Type	Size	Cyln	Head	WPcom	Sec	Modc	Modc	Modc
Pri Master	: Auto								
Pri Slave	: Auto								
Sec Master	: Auto								
Sec Slave	: Auto								
Floppy Drive A: Not Installed									
Floppy Drive B: Not Installed									
Month:	Jan - Dec	ESC : Exit							
Day:	01 - 31	↑ : Select Item							
Year:	1980 - 2099	PU/PD/+/- : Modify							
		(Shift)F2 : Color							
		F3 : Detect All HDD							

Date < mm > < dd > < yyyy >

Set the system date. Note that the 'Day' automatically changes when you set the date.

Time < hh : mm : ss >

The time is converted based on the 24-hour military-time clock. For example, 5 p.m. is 17:00:00.

Pri Master

Options are in its sub-menu. Press < Enter > to enter the sub-menu.

Pri Slave

Options are in its sub-menu. Press < Enter > to enter the sub-menu.

Sec Master

Options are in its sub-menu. Press < Enter > to enter the sub-menu.

Sec Slave

Options are in its sub-menu. Press < Enter > to enter the sub-menu.

Floppy Drive A/B

Select the type of floppy disk drive installed in your system.

- The choice: None, 360K, 5.25 in, 1.2M, 5.25 in, 720K, 3.5 in, 1.44M, 3.5 in, 2.88M, 3.5 in, 360K, 5.25 in, 1.2M, 5.25 in, 720K, 3.5 in, 1.44M, 3.5 in, or 2.88M, 3.5 in.

Advanced Setup

This section allows you to configure your system for basic operation. You have the opportunity to select the system's default speed, boot-up sequence, keyboard operation, shadowing, and security.

AMIBIOS SETUP - ADVANCED SETUP			
(C)2000 American Megatrends, Inc. All Rights Reserved			
Quick Boot	Disabled	AGP Aperture Size	256MB
1st Boot Device	Disabled	Auto Detect DIMM/PCI Clk	Disabled
2nd Boot Device	Disabled	CLK GEN Spread Spectrum	Disabled
3rd Boot Device	Disabled		
Try Other Boot Devices	Yes		
S.M.A.R.T. for Hard Disks	Disabled		
BootUp Num-Lock	Off		
Floppy Drive Swap	Disabled		
Floppy Drive Seck	Disabled		
Password Check	Setup		
Boot To OS/2	No		
L2 Cache	Disabled		
System BIOS Cacheable	Disabled		
SDRAM Timing by SPD	Disabled		
SDRAM Frequency	100MHz		
SDRAM CAS# Latency	3		
SDRAM Bank Interleave	Disabled		
AGP Mode	4x		
AGP Comp. Driving	Manual		
Manual AGP Comp. Driving	00		
		ESC : Quit	↑↓← : Select Item
		F1 : Help	PU/PD/+/+/- : Modify
		F5 : Old Values	(Shift)F2 : Color
		F6 : Load Optimal Values	
		F7 : Load Best Performance Values	

Quick Boot

If you enable this item, the system starts up more quickly by elimination of some of the power on test routines.

- The choice: Enabled or Disabled.

1st/2nd/3rd Boot Device

Use these items to determine the device order the computer uses to look for an operating system to load at start-up time.

- The choice: CDROM, SCSI, NETWORK, BBS-0, BBS-1, BBS-2, BBS-3, USB FDD, USB CDROM, USB HDD, USB RMD-FDD, USB RMD-HDD, Disabled, IDE-0, IDE-1, IDE-2, IDE-3, Floppy, ZIP A:/LS120, or ATAPI ZIP C:.

Try Other Boot Devices

If you enable this item, the system will also search for other boot devices if it fails to find an operating system from the first two locations.

- The choice: Yes or No.

S.M.A.R.T. for Hard Disks

Enable this item if any IDE hard disks support the S.M.A.R.T. (Self-Monitoring, Analysis and Reporting Technology) feature.

- The choice: Enabled or Disabled.

BootUp Num-Lock

This item determines if the Num Lock key is active or inactive at system start-up time.

- The choice: Off or On.

Floppy Drive Swap

If you have two diskette drives installed and you enable this item, drive A becomes drive B and drive B becomes drive A.

- The choice: Enabled or Disabled.

Floppy Drive Seek

If you enable this item, your system will check all floppy disk drives at start up. Disable this item unless you are using an old 360KB drive.

- The choice: Enabled or Disabled.

Password Check

If you have entered a password for the system, use this item to determine, if the password is required to enter the Setup Utility (*Setup*) or required both at start-up and to enter the Setup Utility (*Always*).

- The choice: Setup or Always.

Boot to OS/2

Enable this item if you are booting the OS/2 operating system and you have more than 64MB of system memory installed.

- The choice: YES or No.

L2 Cache

Leave these items enabled since all the processors that can be installed on this board have internal L1/L2 cache memory.

- The choice: Enabled or Disabled.

System BIOS Cacheable

If you enable this item, a segment of the system BIOS will be copied to main memory for faster execution.

- The choice: Enabled or Disabled.

SDRAM Timing By SPD

This item allows you to enable or disable the SDRAM timing defined by the Serial Presence Detect electrical.

- The choice: Enabled or Disabled.

SDRAM Frequency

This item determines frequency of SDRAM memory.

- The choice: Auto, 100MHz, or 133 MHz.

SDRAM CAS# Latency

This item determines the operation of SDRAM memory CAS (column address strobe). It is recommended that you leave this item at the default value.

- The choice: 3, 2.5, or 2.

SDRAM Bank Interleave

Enable this item to increase SDRAM memory speed. When enabled, separate memory banks are set for odd and even addresses and the next byte of memory can be accessed while the current byte is being refreshed.

- The choice: Disabled, 2-Way, or 4-Way.

AGP Mode

This item provides the OnBoard VGA mode with three options of 1,2,4 multiplied frequency.

- The choice: 4X, 2X, or 1X.

AGP Comp. Driving

When AGP Driving is set to Manual, use this item to set the AGP current driving value.

- The choice: Auto or Manual.

Manual AGP Comp. Driving

Use this item to signal driving current on AGP cards to auto or manual. Some AGP cards need stronger than normal driving current in order to operate. We recommend that you set this item to the default.

- The choice: 00-99, 0A(~ 9A)-0F(~ 9F), A0(~ F0)-A9(~ F9), or AA(~ FA)-AF(~ FF).

AGP Aperture Size

This item defines an AGP for the graphics. Leave this item at the default value 64MB.

- The choice: 4MB, 8MB, 16MB, 32MB, 64MB, 128MB, or 256MB.

Auto Detect DIMM/PCI CLK

When this item is enabled, BIOS will disable the clock signal of free DIMM/PCI slots.

- The choice: Enabled or Disabled.

CLK GEN Spread Spectrum

Use this item to set the system bus spread spectrum for the installed processor.

- The choice: Enabled or Disabled.

 **Power Management Setup**

AMIBIOS SETUP - POWER MANAGEMENT SETUP	
(C)2000 American Megatrends, Inc. All Rights Reserved	
ACPI Aware O/S	No
Power Management	Disabled
Suspend Time Out	Disabled
Hard Disk Time Out	Disabled
Restore On AC/Power Loss	Power Off
Resume On RTC Alarm	Disabled
RTC Alarm Date	Every Day
RTC Alarm Hour	00
RTC Alarm Minute	00
RTC Alarm Second	00
PCIPMEMOLRing Power On	Disabled

ESC : Quit	↑↓ : Select Item
F1 : Help	PU/PD/+/- : Modify
F5 : Old Values	(Shift)F2 : Color
F6 : Load Optimal Values	
F7 : Load Best Performance Values	

ACPI Aware O/S

This item defines ACPI (Advanced Configuration and Power management Interface) and is unselectable.

Power Management

Use this item to enable or disable a power management scheme. If you enable power management, you can use the items below to set the power management operation. Both APM and ACPI are supported.

- The choice: Enabled or Disabled.

Suspend Time Out (Min.)

This sets the timeout for Suspend mode in minutes. If the time selected passes without any system activity, the computer will enter power-saving Suspend mode.

- The choice: Disabled, 1, 2, 4, 8, 10, 20, 30, 40, 50, or 60.

Hard Disk Time Out (Min.)

This item sets up the timeout to power down the hard disk driver, if there is no hard disk activity after passing the preset period of time.

- The choice: Disabled, or 1, 2, 3, 4, 5, 6, 7, 8, 9, 10, 11, 12, 13, 14, or 15.

Restore On AC/Power Loss

This allow you to set whether you want your system to reboot after power has been interrupted.

- The choice: Power off, Power on, or Last state.

Resume On RTC Alarm (Date/Hour/Minute/Second)

The system can be turned off with a software command. If you enable this item, the system can automatically resume at a fixed time based on the system's RTC (realtime clock). Use the items below this one to set the date and time of the wake-up alarm. You must use an ATX power supply in order to use this feature.

- The choice: Enabled or Disabled.

PCI PME\WOL\Ring Power On

The system can be turned off with a software command. If you enable this item, the system can automatically resume if there is an incoming call on the Modem/PCI modem/LAN card. You must use an ATX power supply in order to use this feature.

- The choice: Enabled or Disabled.

PCI/Plug and Play Setup

AMIBIOS SETUP - PCI / PLUG AND PLAY SETUP	
(C)2000 American Megatrends, Inc. All Rights Reserved	
Plug and Play Aware O/S	No
Primary Graphics Adapter	PCI
Allocate IRQ to PCI VGA	Yes
PCI IDE BusMaster	Disabled
ESC : Quit ↑↓ : Select Item	
F1 : Help PU/PD/+/- : Modify	
F5 : Old Values (Shift)F2 : Color	
F6 : Load Optimal Values	
F7 : Load Best Performance Values	

Plug and Play Aware O/S

Enable this item if you are using an O/S that supports Plug and Play such as Windows 95 or 98.

- The choice: Yes or No.

Primary Graphics Adapter

This item indicates if the primary graphics adapter uses the PCI or the AGP bus. The default AGP setting still lets the onboard display work and allows the use of a second display card installed in an AGP slot.

- The choice: AGP or PCI.

Allocate IRQ to PCI VGA

If this item is enabled, an IRQ will be assigned to the PCI VGA graphics system. You set this value to No to free up an IRQ.

- The choice: Yes or No.

PCI IDE BusMaster

This item enables or disables the DMA under DOS mode. We recommend you to leave this item at the default value.

- The choice: Enabled or Disabled.

 **Load Optimal Settings**

When you press < Enter > on this item, you will get a confirmation dialog box with a message similar to:

Load Optimal settings (Y/N) ? N

Pressing 'Y' the Setup Utility loads a set of fail-safe default values. These default values are not very demanding and they should allow your system to function with most kinds of hardware and memory chips.

 **Load Best Performance Settings**

When you press < Enter > on this item, you will get a confirmation dialog box with a message similar to:

Load best performance settings (Y/N) ? N

Pressing 'Y' the Setup Utility loads a set of best-performance default values. These default values are quite demanding and your system might not function properly if you are using slower memory chips or other low-performance components.

Features Setup

AMIBIOS SETUP - FEATURES SETUP	
(C)2000 American Megatrends, Inc. All Rights Reserved	
OnBoard FDC	Auto
OnBoard Serial PortA	Auto
OnBoard Serial PortB	Auto
Serial Port2 Mode	Normal
OnBoard Parallel Port	Auto
Parallel Port Mode	SPP
Parallel Port IRQ	Auto
Parallel Port DMA	1
OnBoard Game Port	
OnBoard MIDI Port	
MIDI Port IRQ	1
OnBoard IDE	
Audio Device	+i^i2i
Modem Device	+i^i2i
Ethernet Device	Disabled
OnBoard LAN Boot ROM	Disabled
USB Controller	Disabled
USB Device Legacy Support	Disabled
ThumbDrive Support for DOS	Disabled
ESC : Quit ↑↓ : Select Item	
F1 : Help PU/PD/+/- : Modify	
F5 : Old Values (Shift)F2 : Color	
F6 : Load Optimal Values	
F7 : Load Best Performance Values	

OnBoard FDC

Use this item to enable or disable the onboard floppy disk drive interface.

- The choice: Enabled, Auto, or Disabled.

OnBoard Serial PortA/PortB

Use this item to assign port addresses for the onboard COM1/COM2 serial ports. Please have this item disabled as an IR device is installed.

- The choice: Disabled, 3F8h/COM1, 2F8h/COM2, 3E8h/COM3, 2E8h/COM4, or Auto.

Serial Port2 Mode

Use this item to define IR modes for an installed IR device.

- The choice: Normal or ASKIR.

OnBoard Parallel Port

Use this item to enable or disable the onboard LPT1 parallel port, and to assign a port address. The Auto setting will detect and available address.

- The choice: Auto, Disabled, 378h, 278h, or 3BCh.

Parallel Port Mode

Use this item to set the parallel port mode. You can select SPP (Standard Parallel Port), ECP (Extended Capabilities Port), EPP (Enhanced Parallel Port), or ECP + EPP.

- The choice: SPP, EPP, ECP, or EPP + ECP.

Parallel Port IRQ

Use this item to assign IRQ to the parallel port a port address.

- The choice: 7 or 5.

Parallel Port DMA

Use this item to assign a DMA channel to the parallel port.

- The choice: N/A.

OnBoard Game Port

This item enables or disables the I/O address for the GAME port.

- The choice: 201h, 209h, or Disabled.

OnBoard MIDI Port

Use this item to enable or disable the onboard MIDI port, and to assign a port address.

- The choice: 300h, 330h, or Disabled.

MIDI Port IRQ

Use this item to assign an IRQ to the MIDI port.

- The choice: 10, 11, or 5.

OnBoard IDE

Use this item to enable or disable the onboard IDE channel.

- The choice: Both, Disabled, Primary, or Secondary.

Audio Device

This item enables or disables the AC'97 audio chip.

- The choice: Enabled or Disabled.

Modem Device

This item enables or disables the MC'97 modem chip.

- The choice: Enabled, Disabled, or Auto.

Ethernet Device (AV41PN only)

This item enables or disables the onboard Ethernet LAN.

- The choice: Enabled or Disabled.

OnBoard LAN Boot ROM (AV41PN only)

Use this item to enable or disable the onboard LAN boot ROM.

- The choice: Enabled or Disabled.

USB Controller

Use this item to enable or disable USB ports.

- The choice: Enabled or Disabled.

USB Device Legacy Support

This item allows you to enable the USB device, if you have installed a USB device on the system board.

- The choice: Enabled or Disabled.

ThumbDrive Support for DOS

This item allows user to use ThumbDvive under DOS Environment.

- The choice: Disabled or Enabled.

CPU PnP Setup

This page helps you manually configure the mainboard for the CPU. The system will automatically detect the type of installed CPU and make the appropriate adjustments to the items on this page.

AMIBIOS SETUP - CPU PnP SETUP	
(C)2000 American Megatrends, Inc. All Rights Reserved	
CPU BRAND	INTEL
CPU Type	Pentium 4
CPU Ratio	8.0x
CPU Frequency	100MHz
ESC : Quit ↑↓ : Select Item	
F1 : Help PU/PD/+/- : Modify	
F5 : Old Values (Shift)F2 : Color	
F6 : Load Optimal Values	
F7 : Load Best Performance Values	

CPU BRAND

This item show the Brand of CPU installed in your system.

CPU Type

This item show the Type of CPU installed in your system.

CPU Ratio

This item show the Ratio Selection of CPU installed in your system.

- The choice: 8.0X or 10.0X ~ 24.0X.

CPU Frequency

This item show the Frequency of CPU installed in your system.

Hardware Monitor

On mainboards that support hardware monitoring, this item lets you monitor the parameters for critical voltages, critical temperatures, and fan speeds:

AMIBIOS SETUP - HARDWARE MONITOR	
(C)2000 American Megatrends, Inc. All Rights Reserved	
--≡ System Hardware ≡--	
Vcore	1.568 V
Vcc2.5V	2.528 V
Vcc3.3V	3.312 V
Vcc5V	4.892 V
+12V	12.096 V
-12V	-11.639 V
SB5V	4.972 V
VBAT	3.376 V
SYSTEM Fan Speed	0 RPM
CPU FAN Speed	4560 RPM
POWER Temperature	35°C/95°F
SYSTEM Temperature	31°C/87°F
CPU Temperature	44°C/111°F
ESC	: Quit
F1	: Help
F5	: Old Values
F6	: Load Optimal Values
F7	: Load Best Performance Values
↑↓	: Select Item
PU/PD/+/-	: Modify
(Shift)F2	: Color

System Hardware

These fields provide you with information about the systems current operating status. You cannot make changes to these fields.

The fields include

- Vcore
- Vcc2.5V
- Vcc3.3V
- Vcc5V
- + 12V
- 12V
- SB5V
- VBAT
- System Fan Speed
- CPU FAN speed
- POWER Temperature
- SYSTEM Temperature
- CPU Temperature

Change Password

If you highlight this item and press Enter, a dialog box appears which lets you enter a password. You can enter no more than six letters or numbers. Press Enter after you have typed in the password. A second dialog box asks you to retype the password for confirmation. Press Enter after you have retyped it correctly. The password is then required to access the Setup Utility or for that and at start-up, depending on the setting of the Password Check item in Advanced Setup.

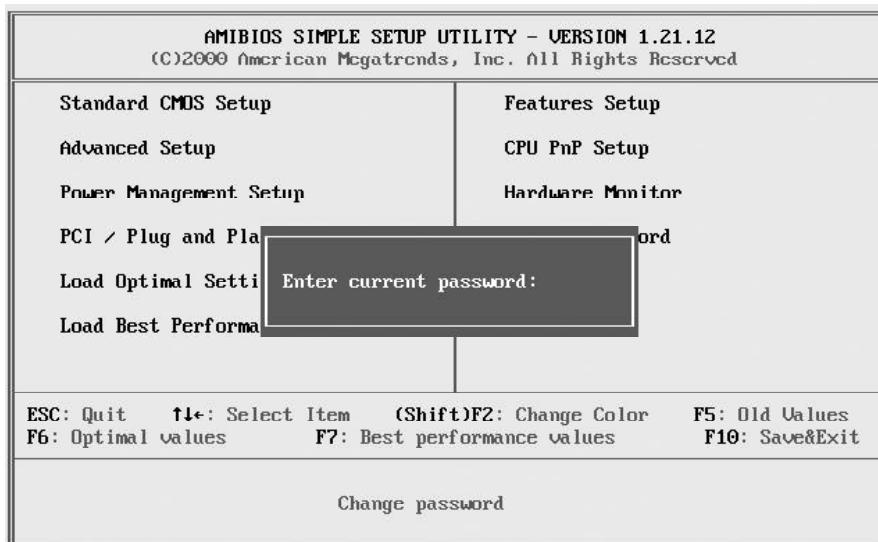

Enter Password

Type the password up to six characters, and press < Enter > . The password typed now will clear any previously entered password from CMOS memory. You will be asked to confirm the password. Type the password again and press < Enter > . You may also press < Esc > to abort the selection and not enter a password. To disable password, just press < Enter > when you are prompted to enter password. A message will confirm the password being disabled. Once the password is disabled, the system will boot and you can enter Setup freely.

Password Disabled

If you select System at Security Option of BIOS Features Setup Menu, you will be prompted in entering the password whenever the system is rebooted or you try to enter Setup. If you select Setup at Security Option of BIOS Features Setup Menu, you will be prompted only when you try to enter Setup.

Warning : Retain a record of your password in a safe place. If you forget the password, the only way to access the system is to clear CMOS, please refer to "Clear CMOS" on page 28.

 **Exit**

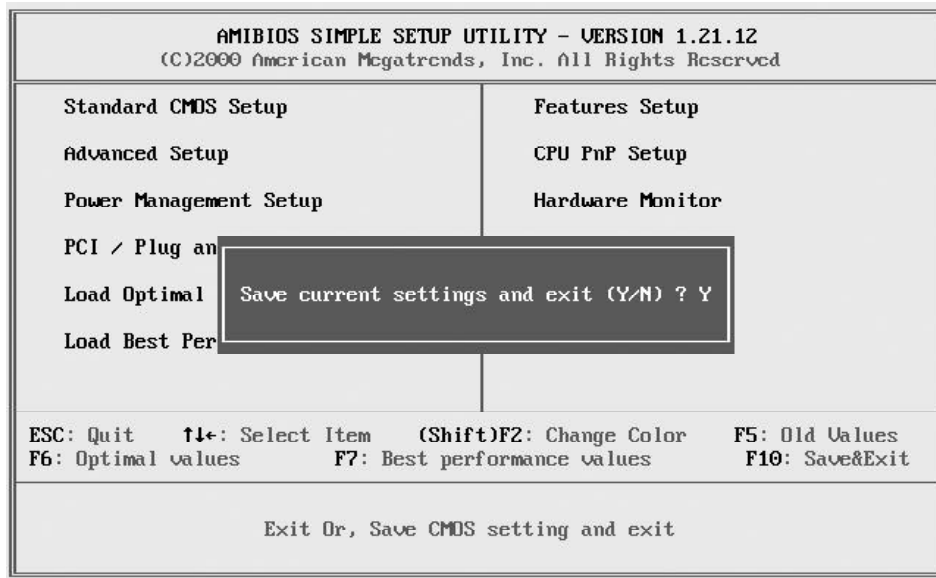

Highlight this item and press < Enter > to save the changes that you have made in the Setup Utility configuration and exit the program.

Save current settings and exit (Y/N) ? Y

Pressing "Y" stores the selections made in the menus of CMOS - a special section of memory that stays on after you turn your system off. The next time you boot your computer, the BIOS configures your system according to the Setup selections stored in CMOS. After saving the values the system is restarted again.

Pressing "N" to exit from Setup without storing in CMOS any change. The previous selections remain in effect. This exits from the Setup Utility and restarts your computer.