

Table of Contents

JUMPER COMPONENT LOCATION DIAGRAM.....	A
CHAPTER 1 INTRODUCTION.....	2
1-1 SYSTEM FEATURES.....	3
1-2 CHECK LIST OF THE PACKING	4
CHAPTER 2 INSTALLATION	5
2-1 INSTALLATION PROCEDURES	5
2-2 CPU INSTALLATION.....	6
2-3 SYSTEM MEMORY INSTALLATION.....	12
2-4 SRAM INSTALLATION	14
2-5 OTHER JUMPERS AND CONNECTORS DESCRIPTION	15
2-6 IDE DRIVER INSTALLATION.....	20
CHAPTER 3 AWARD BIOS SETUP	21
3-1 UPDATE BIOS PROCEDURES	22
3-2 AWARD SYSTEM BIOS CONFIGURATION SETUP.....	23
APPENDIX A	47

CHAPTER 1 INTRODUCTION

This manual describes how to configure the ATC-1020+ mainboard for different environments. It's an overview of the layout and features of the mainboard, and also provides information for changing the configuration or system environment.

This manual is divided into two sections :

PART ONE includes page A and two chapters as following:

Page A contains layout diagram of the mainboard. Please refer to it when you configure the system.

Chapter 1 is an overview of the mainboard features and packing contents.

Chapter 2 describes how to upgrade and to change hardware configurations such as memory size, CPU type, and lists of jumper settings and connectors.

PART TWO includes chapter 3 which contains Award BIOS description.

Chapter 3 is the user's guide of AWARD BIOS setup utility, Flash ROM BIOS update procedure. The figure described in this chapter are default settings.

Your system dealer will set up the mainboard according to your demand of computer. It means that the current settings of your mainboard may not be the same as the defaults shown in this user's manual. If you need to change your configuration, please ask your dealer first, be sure it doesn't void your system warranty, or ask for your dealer to do it for you.

REMARK

Intel® is a registered trademark of Intel Corporation.

MS-DOS® is a registered trademark of Microsoft Corporation.

All other brands and product names are trademarks registered trademarks of their respective companies.

1-1 SYSTEM FEATURES

- ☐ Pentium level CPU operating at 75 MHz to 200MHz with 321-pin ZIF socket 7 and scalability to accept processor in the future.
- ☐ Support Intel Pentium MMX™ (166~233MHz), AMD-K6™ (166~233MHz), Cyrix M2 processor.
- ☐ INTEL 82430VX PCiset.
- ☐ Built-in Switching Voltage Regulator for high speed processor.
- ☐ Using four 72-pin SIMM sockets, provides two banks of 64-bit wide path up to 128MB addressing page mode DRAMs.
- ☐ Support two types of DRAM including EDO (Extended Data Out), or FPM (Fast Page Mode).
- ☐ Support four PCI bus master revision 2.1, 5V interface compliant slots and three 16-bit ISA slots.
- ☐ Dual Master IDE connectors support up to four devices in two channels for connection of high capacity hard disk drive, CD-ROM, tape backup etc..
- ☐ AT style keyboard connector and PS/2 mouse cable connector.
- ☐ Winbond 83877 high-speed Multi-I/O chipset.
- ☐ Support Infrared transfer (IrDA TX/RX) connector.
- ☐ One FDC port supports two devices up to 2.88MB.
- ☐ Two 16550A fast UARTs compatible serial ports.
- ☐ One EPP/ECP mode parallel port.
- ☐ Form Factor Dimension is 220mm x 280mm (8.66" x 11.02").

1-2 CHECK LIST OF THE PACKING

The mainboard comes securely packed in a durable box and shipping carton. If any of the above items are missing or damaged, please contact your supplier.

Each mainboard contains:

<u>Q'TY</u>	<u>Description</u>
1	Mainboard : ATC-1020+.
1	Diskette : Enhanced IDE driver (3.5").
1	Cable : Enhanced IDE connector.
1	Cable : F.D.D. connector.
1	Cable : Serial port.
1	Cable : Serial/Parallel.
1	Manual : User's manual.

NOTE : Leave the mainboard in its original packaging until you are ready to install it.

CHAPTER 2 INSTALLATION

2-1 INSTALLATION PROCEDURE

Before installing the computer, please prepare all components such as CPU, DRAM; peripherals such as hard disk devices, keyboard, CD-ROM drive; and accessories such as cables. Then, install the system as following :

1. Plug CPU, heat sink, cooling fan, and DRAM modules in the mainboard.
2. Set jumpers based on your configuration.
3. Plug add-on cards in PCI/ISA slots.
4. Connect cables to peripherals, power supply..
5. Make sure all components and devices are well connected.
Turn on the power and setup System BIOS according to your system configuration.
6. Install peripheral, add-on card drivers and test them.
7. If all of above procedures are success, turn-off the power then plug all of them into your computer case.

2-2 CPU INSTALLATION

ATC-1020+ supports Pentium level CPU up to 233MHz. For installation, please notice CPU pin 1 must align with the ZIF socket 7 Pin 1 location. Before you install or upgrade your CPU, please read CPU guide from CPU manufacturer to make sure the CPU voltage specification. Then choose the right installation in the 2-2-1 based on your CPU type/brand and follow the description to setup jumpers. If your CPU is not in the list of 2-2-1, please refer to 2-2-2 and 2-2-3 for installation.

2-2-1 CPU TYPE SELECTION

A. INTEL PENTIUM CPU (P54C)

CPU Core Voltage	VRE	STD
JP11	1-2**	3-4*

* STD : 3.135V ~ 3.600V

** VRE : 3.400V ~ 3.600V

(The fourth line of the mark on the under-side of the processor contains a code that identifies the voltage level type. V is VRE, S is standard.)

Intel Pentium CPU,
the first letter after '/'
denotes voltage



INTERNAL CPU CLOCK	JP4	JP5	JP6	JP9	JP10	Ext.x Frq.
75MHz	close	open	open	1-2	1-2	50x1.5
90MHz	close	close	open	1-2	1-2	60x1.5
100MHz	close	open	close	1-2	1-2	66x1.5
120MHz	close	close	open	1-2	2-3	60x2.0
133MHz	close	open	close	1-2	2-3	66x2.0
150MHz	close	close	open	2-3	2-3	60x2.5
166MHz	close	open	close	2-3	2-3	66x2.5
180MHz	close	close	open	2-3	1-2	60x3.0
200MHz	close	open	close	2-3	1-2	66x3.0

**B. INTEL PENTIUM PROCESSOR WITH MMX™
TECHNOLOGY (P55C)**

JP11	9-10
-------------	------

INTERNAL CPU CLOCK	JP4	JP5	JP6	JP9	JP10	Ext.x Frq.
166MHz	close	open	close	2-3	2-3	66x2.5
200MHz	close	open	close	2-3	1-2	66x3.0
233MHz	close	open	close	1-2	1-2	66x3.5

※ The location of JP11

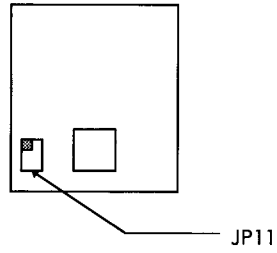

C. Cyrix 6x86(028) CPU

CPU	JP11
Cyrix 6x86 (028)	1-2

INTERNAL CPU CLOCK	JP4	JP5	JP6	JP9	JP10	Ext.x Frq.
PR120+ @ 100MHz	close	open	open	1-2	2-3	50x2.0
PR150+ @ 120MHz	close	close	open	1-2	2-3	60x2.0
PR166+ @ 133MHz	close	open	close	1-2	2-3	66x2.0
PR200+ @ 150MHz	open	close	close	1-2	2-3	75x2.0

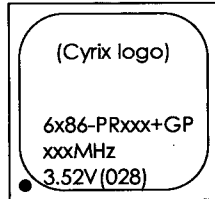

The button line of the mark on the processor contains a code 028 that identifies the voltage level type. If the code is 016 or others, or no marking then please contact your dealer.

D. Cyrix 6x86L CPU

CPU	JP11
Cyrix 6x86L	9-10

INTERNAL CPU CLOCK	JP4	JP5	JP6	JP9	JP10	Ext.x Frq.
PR120+ @ 100MHz	close	open	open	1-2	2-3	50x2.0
PR133+ @ 110MHz	close	close	close	1-2	2-3	55x2.0
PR150+ @ 120MHz	close	close	open	1-2	2-3	60x2.0
PR166+ @ 133MHz	close	open	close	1-2	2-3	66x2.0
PR200+ @ 150MHz	open	close	close	1-2	2-3	75x2.0

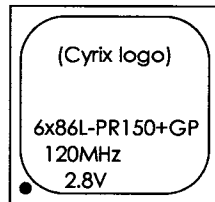

The mark on the processor contains as the sample in the left. The code-name 6x86L is dual voltage mode processor, you should set JP11 to 2-3.

E. AMD-K5 CPU

CPU	JP11
AMD K5	1-2

CPU CLOCK RATING	JP4	JP5	JP6	JP9	JP10	Ext.x.Frq.
PR75ABR	close	open	open	1-2	1-2	50x1.5
PR90ABQ	close	close	open	1-2	1-2	60x1.5
PR100ABQ	close	open	close	1-2	1-2	66x1.5
PR120ABQ	close	close	open	1-2	1-2	80x1.5
PR133ABQ	close	open	close	1-2	1-2	66x1.5
PR166ABQ	close	open	close	2-3	2-3	66x2.5

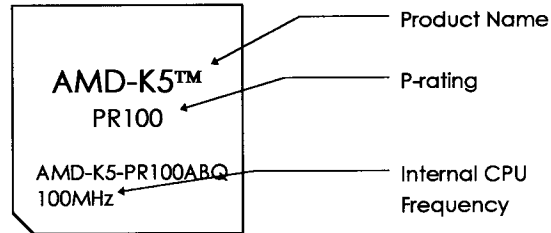

F. AMD-K6 CPU

AMD K6-PR166/PR200

JP11	5-6
------	-----

INTERNAL CPU CLOCK	JP4	JP5	JP6	JP9	JP10	Ext.x Frq.
AMD K6-PR166	close	open	close	2-3	2-3	66x2.5
AMD K6-PR200	close	open	close	2-3	1-2	66x3.0

AMD K6-PR233

JP11	7-8
------	-----

INTERNAL CPU CLOCK	JP4	JP5	JP6	JP9	JP10	Ext.x Frq.
AMD K6-PR233	close	open	close	1-2	1-2	66x3.5

2-2-2 CPU VOLTAGE SETTING

ATC-1020+ can auto detected single or dual CPU voltage power supply type without jumper setting. JP11 is used for various CPU voltage value types, please refer to CPU's marking on/under CPU and its user's manual.

CPU CORE VOLTAGE		JP11
INTEL	P54C STD	3-4
	P54C VRE	1-2
	P55C 2.8V	9-10
Cyrix	6x86 ₍₀₂₈₎	1-2
	6x86L	9-10
AMD	K5	1-2
	K6-PR166/200	7-8
	K6-PR233	5-6

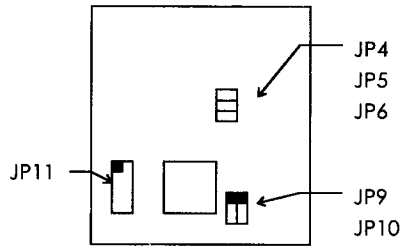
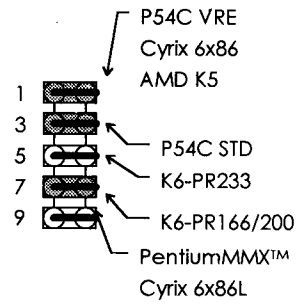

JP11	1- 2	3- 4	5- 6	7- 8	9- 10
Vcore	3.5V	3.3V	3.2V	2.9V	2.8V

2-2-3 CPU CLOCK SETTING

The following setting is for new release CPUs.

EXTERNAL CPU CLOCK	JP4	JP5	JP6
50(MHz)	close	open	open
55(MHz)	close	close	close
60(MHz)	close	close	open
66(MHz)	close	open	close
75(MHz)	open	close	close

External
CPU Clock :

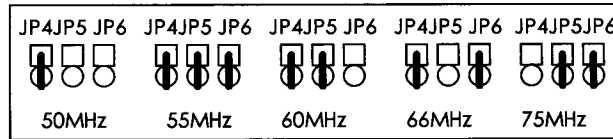

INTERNAL CPU CLOCK	JP9	JP10
INTEL EXTERNAL CLOCK X 1.5	1-2	1-2
INTEL EXTERNAL CLOCK X 2.0	1-2	2-3
INTEL EXTERNAL CLOCK X 2.5	2-3	2-3
INTEL EXTERNAL CLOCK X 3.0	2-3	1-2
INTEL EXTERNAL CLOCK X 3.5	1-2	1-2

Internal
CPU Clock :

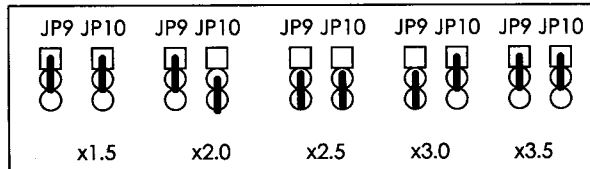

2-3 SYSTEM MEMORY INSTALLATION

ATC-1020+ provides four 72-pin SIMM sockets for system memory expansion from 4MB to 128MB. These four SIMMs are arranged to two banks, Bank0 (SIM 1, 2) and Bank1(SIM 3, 4), please refer to page A. Each bank provides 64-bit wide data path.

The mainboard accepts Fast Page Mode DRAM, and EDO Mode (Extended Data Out) DRAM, with a speed at least 70 nanosecond. You should plug DRAM modules into two sockets (same bank) or four sockets at one time. Each pair of modules must be the same size, type, and speed; No matter single-side or double-side module. Please plug in Bank 0 firstly if you only have 2 modules. The mainboard supports mixing of EDO and fast page mode DRAM among different banks, please plug EDO in Bank 0.

Also this mainboard provides one optional 168-pin DIMM socket for Synchronous DRAM expansion. It's not recommended to install the SDRAM and EDO or Fast Paged mode memory within a system. Changing EDO/FPM DRAM to SDRAM, you don't have to adjust jumper setting or BIOS value, nor change SDRAM to EDO/FPM DRAM. (※ Please make sure the SDRAM plugged-in fully, to prevent contact loss.)

※ System Memory Combinations Options ※

BANK0 SIM 1, 2	BANK1 SIM 3, 4	Total Memory SIM 1- 4
4MBx2	-	8MB
-	4MBx2	8MB
8MBx2	-	16MB
-	8MBx2	16MB
4MBx2	4MBx2	16MB

- continue -

BANK0 SIM 1, 2	BANK1 SIM 3, 4	Total Memory SIM 1- 4
4MBx2	8MBx2	24MB
8MBx2	4MBx2	24MB
16MBx2	-	32MB
-	16MBx2	32MB
8MBx2	8MBx2	32MB
4MBx2	16MBx2	40MB
16MBx2	4MBx2	40MB
8MBx2	16MBx2	48MB
16MBx2	8MBx2	48MB
32MBx2	-	64MB
-	32MBx2	64MB
16MBx2	16MBx2	64MB
4MBx2	32MBx2	72MB
32MBx2	4MBx2	72MB
8MBx2	32MBx2	80MB
32MBx2	8MBx2	80MB
16MBx2	32MBx2	96MB
32MBx2	16MBx2	96MB
32MBx2	32MBx2	128MB

2-4 SRAM INSTALLATION

ATC-1020 is built-in 256KB or 512KB Sync. Pipeline Burst SRAM on board and provides a COAST slot for further expansion.

※ Cache Memory Combinations Options ※

SRAM TYPE	SRAM SIZE	DATA SRAM	TAG SRAM
Synchronous on board	256KB	32K32 x 2pcs	16K8 or
	512KB	64K32 x 2pcs	32K8 x 1pc
Synchronous module	256KB	32K32 x 2pcs	16K8 or 32K8 x 1pc

※ Upgrade Procedure :

For upgrading your Sync. SRAM from 256KB to 512KB by using COAST Module, you should plug-in the KIT-256 module, then set JP17 to "open" (disable the original TAG on board). You must use KIT-256 for upgrading your system to 512KB Sync. SRAM , please contact your system dealer about its information. It does not need any BIOS value adjustments for upgrading the SRAM size.

On Board TAG	JP17
Disable	open
Enable	close

(If your module is without TAG RAM, please set JP17 "close".)

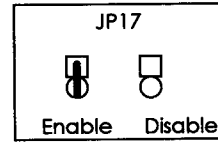

2-5 OTHER JUMPERS AND CONNECTORS DESCRIPTION

The locations of following jumpers are indicated in page A.

Jumper	Function	Remark
JP8	CMOS	open: Normal * close: Clear CMOS
JP7	ATBUS CLK	open: PCI CLK/3 for external CPU clock 50MHz close: PCI CLK/4 for external * * CPU clock 60, 66MHz

"*" is default setting.

"* *" is fixed default setting.

The locations of following connectors are indicated in page A. When you plug a cable into the following I/O connectors, you should have the pin 1 edge of the cable aligned with the pin 1 end of the connector.

CONN1 : speaker, power LED, reset, SMI, turbo LED, and IDE LED connectors.

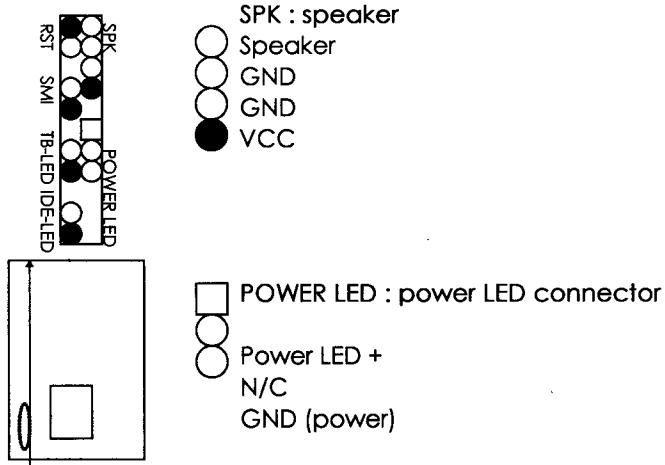

RST : Reset connector



SMI : SMI lead



TB-LED : Turbo LED indicator, LED on when system runs higher speed

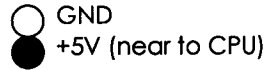

IDE-LED : IDE devices indicator LED connector, LED stays ON indicates on-board IDE devices in operation.

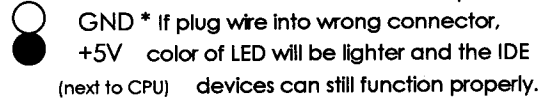

FAN1 : CPU cooling fan connector. Wire with +12V voltage (most likely red wire) must be plugged into pin2, and GROUND wires (most likely black wires) must be plugged into pin1 and/or pin3. Please confirm the wire color representation with your supplier.

CAUTION: Plug wire into wrong connector will DAMAGE fan and mainboard.

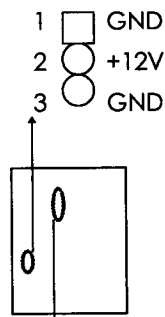

IR1 : Infrared module connector.

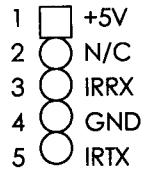

USB1 : USB connector; Universal Serial Bus; this is used to connect USB devices through an optional dual head cable with a iron plane.

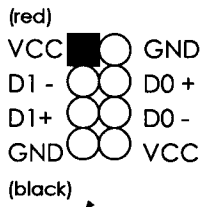

CAUTION: Plug wire into wrong connector will DAMAGE USB devices and mainboard.

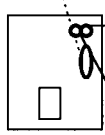

KB1 : 5-pin AT style compatible keyboard connector.

PS/2 : PS/2 mouse connector, which is used to connect an optional cable.

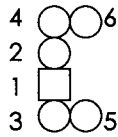

pin1 : data
pin2 : N/C
pin3 : GND
pin4 : VCC
pin5 : clock
pin6 : N/C

PW1 : +5 Voltage power supply connector.

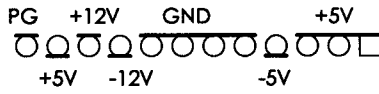
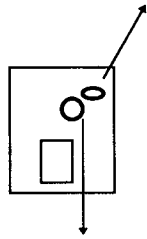

COM1/COM2

COM1/COM2 : these two connectors are used to connect serial port cables.

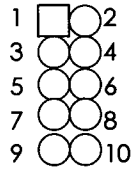

pin	signal name
1	DCD
2	Serial In
3	Serial Out
4	DTR
5	GND
6	DSR
7	RTS
8	CTS
9	RI
10	N/C

FDC : this connector is used to connect floppy disk drive through cable.

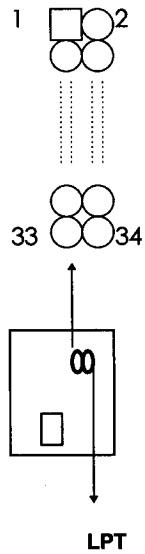

pin	signal	pin	signal
2	RWC-	20	STEP-
4	reserved	22	Write Data
6	FDEDIN	24	Write Gate
8	Index-	26	Track 00-
10	Motor EnableA-	28	Write Protect-
12	Drive Sele.B-	30	Read Data-
14	Drive Sele.A-	32	Side 1 Sele.-
16	Motor EnableB-	34	DisketteChange
18	DIR-		
All of odd pins are ground			

LPT : this connector is used to connect parallel port cable.

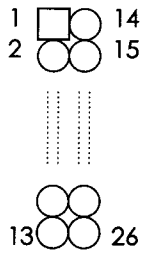

pin	signal	pin	signal
1	STROBE-	10	ACK-
2	Data Bit 0	11	BUSY
3	Data Bit 1	12	PE
4	Data Bit 2	13	SLCT
5	Data Bit 3	14	Auto Feed-
6	Data Bit 4	15	ERROR-
7	Data Bit 5	16	INIT-
8	Data Bit 6	17	SLCT IN-
9	Data Bit 7	26	N/C
pin18 -- pin25 are ground			

IDE1/IDE2 : these two connectors are used to connect IDE devices through IDE cables, up to 4 devices.

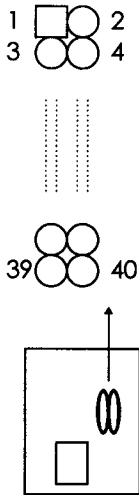

pin	signal	pin	signal
1	Reset IDE	21	DDRQ0(1)
2	GND	22	GND
3	Host Data 7	23	I/O Write-
4	Host Data 8	24	GND
5	Host Data 6	25	I/O Read-
6	Host Data 9	26	GND
7	Host Data 5	27	IORDY
8	Host Data 10	28	N/C
9	Host Data 4	29	DDAK0-(1-)
10	Host Data 11	30	GND
11	Host Data 3	31	IRQ14*
12	Host Data 12	32	IOCS16-
13	Host Data 2	33	Addr 1
14	Host Data 13	34	N/C
15	Host Data 1	35	Addr 0
16	Host Data 14	36	Addr 2
17	Host Data 0	37	ChipSele. 1P-
18	Host Data 15	38	ChipSele. 3P-
19	GND	39	Activity
20	Key	40	GND

*
IDE1: pin31 is IRQ14;
IDE2: pin31 is IRQ15
or MIRQ0

2-6 IDE DRIVER INSTALLATION

The IDE driver installation procedure is printed on the label of diskette as following :

Setup for DOS/Windows :

1. Starting MS-Windows 3.1 (or 3.11)
2. Select Program Manager, File/RUN, then type "A:\setup.exe"
3. Exit MS-Windows, turn power off; then turn power on.

Setup for Windows 95 :(if you use Windows95 4.00.950b or later version, you do not need to install this driver)

1. Starting Windows 95
2. Select "START", "RUN".
3. Type "A:\WIN95\SETUP.EXE".
4. Restart computer, then follow the instructions on your screen to install new IDE driver we offer in the 3.5" diskette
5. Exit Windows 95, turn power off; then turn power on.

Make sure your HDD follow the EATA standard, and your CD-ROM follow the ATAPI standard. When you plug-in the IDE devices, please plug your first and second devices into IDE 1 port (Master then Slave), then plug third and forth devices into IDE 2 port. If you have CD-ROM driver, please set it after hard disk devices as the last device. For example, if you have 2 HDDs and 1 CD-ROM, you should set HDD1 and HDD2 in IDE1 Master and Slave, set CD-ROM in IDE 2 Master.

Primary Master	Primary Slave	Secondary Master	Secondary Slave	
ATA				no ATAPI
ATA		ATAPI		disk & CD-ROM
ATA	ATAPI			use only one cable
ATA		ATAPI	ATAPI	CD-ROM and a tape or two CD-ROMs

CHAPTER 3 AWARD BIOS SETUP

This chapter explains the system BIOS setup, and how to update new BIOS. All BIOS screens showed in the following pages are default values, your system dealer will set up these values according to your demand of computer.

ATC-1020+ uses Flash ROM to make BIOS easier to be updated by the floppy disk-based program and to committe Microsoft Windows 95 plug & play feature.

If you would like to update CMOS date also, please set JP8.

open	NORMAL *
close	CLEAR CMOS

* is default setting

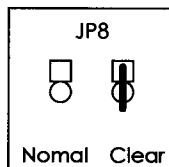

※ JP19 Setting is for Update System BIOS by using Intel Flash ROM only.

JP9 : Intel Flash ROM update

1-2	Enable
2-3	Disable *

* is default setting

When you need to update Intel brand Flash ROM you should set JP19 to '1-2'. After you finish updating, set JP19 to '2-3' again.

※ If the mainboard uses non-Intel Flash ROM, then JP19 will be wired (2-3) in factory.

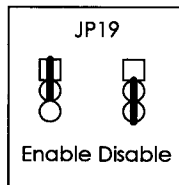

3-1 UPDATE BIOS PROCEDURES

If the BIOS needs to be updated, it can be obtained on a diskette from your system supplier. The BIOS diskette includes 3 files:

"awdfash.exe" -- BIOS update utility program
"awdfash.doc"
"(update BIOS filename with version number).rom"

The update procedures are as following:

1. Boot the system to DOS mode in a normal manner.
2. Insert the updated diskette to drive A (or B).
3. Change working directory to floppy drive, A or B, which contains the update BIOS diskette. -- Type "a:\\" or "b:\\", "ENTER".
4. Run the BIOS update utility -- Type "awdfash", "ENTER".
5. Type "(update BIOS file name with version number).rom", ENTER.
6. Type "N" when the screen displays the message : " Do you want to save BIOS (Y/N) ?".
7. Type "Y" when the screen shows the message : " Are you sure to program (Y/N) ?".
8. Follow instructions displayed on the screen. DO NOT remove the update BIOS diskette from the floppy drive nor turn the system power off until the BIOS update is completed.
9. Exit the utility and turn the system power off, set JP8 to 'close' to clear the CMOS. After about 10 seconds, set JP8 to 'open' (remove the jumper cap), become the normal status.
10. Turn the system power on and test your system working properly or not.

3-2 AWARD SYSTEM BIOS CONFIGURATION SETUP

The following pages explain how to set up the system configuration (CMOS) under the AWARD BIOS. The SETUP program is stored in the Read-Only-Memory (ROM) on the mainboard. Enter the SETUP procedure, press the key when the system is booting up. The following main menu will appear. Please select " STANDARD CMOS SETUP" to enter the next screen.

ROM PCI/ISA BIOS (2A59GA29)
CMOS SETUP UTILITY
AWARD SOFTWARE, INC.

STANDARD CMOS SETUP	INTEGRATED PERIPHERALS
BIOS FEATURES SETUP	SUPERVISOR PASSWORD
CHIPSET FEATURES SETUP	USER PASSWORD
POWER MANAGEMENT SETUP	IDE HDD AUTO DETECTION
PNP/PCI CONFIGURATION	SAVE & EXIT SETUP
LOAD BIOS DEFAULTS	EXIT WITHOUT SAVING
LOAD SETUP DEFAULTS	
ESC: Quit	↑↓→←:Select Item
F10: Save & Exit Setup	(Shift) F2 : Change Color
Time, Date, Hard Disk Type	

The section on the bottom of the main menu explains how to control this screen. The other one section displays the items highlighted in the list.

This screen records some basic hardware information, and set the system clock and error handling. These records can be lost or corrupted if the on-board battery is failed or weak.

ROM PCI/ISA BIOS (2A59GA29)
 CMOS SETUP UTILITY
 AWARD SOFTWARE, INC.

STANDARD CMOS SETUP	INTEGRATED PERIPHERALS
BIOS FEATURES SETUP	SUPERVISOR PASSWORD
CHIPSET FEATURES SETUP	USER PASSWORD
POWER MANAGEMENT SETUP	IDE HDD AUTO DETECTION
PNP/PCI CONFIGURATION	SAVE & EXIT SETUP
LOAD BIOS DEFAULTS	EXIT WITHOUT SAVING
LOAD SETUP DEFAULTS	
ESC: Quit	↑↓→←:Select Item
F10: Save & Exit Setup	(Shift) F2 : Change Color
Time, Date, Hard Disk Type	

ROM PCI/ISA BIOS (2A59GA29)
 STANDARD CMOS SETUP
 AWARD SOFTWARE, INC.

Date (mm:dd:yy) : Fri, Jun 14 1996								
Time(hh:mm:ss) : 13 : 7 : 14								
HARD DISKS	TYPE	SIZE	CYLS	HEAD	PRECOMP	LANDZ	SECTOR	MODE
Primary Master :	Auto	0	0	0	0	0	0	Auto
Primary Slave :	Auto	0	0	0	0	0	0	Auto
Secondary Master :	Auto	0	0	0	0	0	0	Auto
Secondary Slave :	Auto	0	0	0	0	0	0	Auto
Drive A : 1.44M, 3.5 in.					Base Memory : 640K			
Drive B : None					Extended memory : 64512K			
Video : EGA/VGA					Other Memory : 384K			
Halt On: All Errors					Total Memory : 65536K			
ESC :	Quit	↑↓→←:Select Item			PU/PD/+/- : Modify			
F1 :	Help	(Shift) F2 : Change Color						

Date mm is month, dd is date, yy is year.

date	from 1 to 31
month	from Jan. to Dec.
year	from 1900 to 2099

Time hh is hour, mm is minute, ss is second.

hh	from 0 to 23 (24-hour military -time)
mm	from 1 to 59
ss	from 1 to 59

Primary Master The categories identify the types of 2 channels that have been installed in the computer. There are 45 predefined types and 4 user definable types are for Enhanced IDE BIOS. Type 1 to 45 are predefined. Type 'user' is user-definable. Press PgUp/PgDn to select a numbered hard disk type or type the number and press <Enter>. If you select 'Auto' BIOS will auto-detect the HDD & CD-ROM Drive at the POST stage and showing the IDE for HDD & CD-ROM Drive. If you select 'user', you will need to know the device information listed below. Enter the information directly from the keyboard and press <Enter>. This information should be from your hard disk vender or dealer. If the controller of HDD interface is ESDI, the selection shall be 'Type 1'; is SCSI, the selection shall be 'None'. If the device has not been installed select 'NONE' and press <Enter>.

Type	drive type
SIZE	automatically adjusts
CYLS	number of cylinders
HEAD	number of heads
PRECOMP	write precom
LANDZ	landing zone
SECTOR	number of sectors
MODE	mode type

Drive A
Drive B

The category identifies the types of floppy disk drive A or drive B that have been installed in the computer.

None	No floppy drive installed
360K, 5.25 in	5.25" PC-type 360KB capacity
1.2M, 5.25 in	5.25" AT-type 1.2MB capacity
720K, 3.5 in	3.5" double-side 720KB capacity
1.44M, 3.5 in	3.5" double-side 1.44MB capacity
2.88M, 3.5 in	3.5" double-side 2.88MB capacity

Video

The category selects the type of video adapter used for the primary system monitor. Although secondary monitors are supported, you do not have to select the type in Setup.

Halt On

The category determines whether the computer will stop if an error is detected during power up.

No errors	When the BIOS detects a non-fatal error the system will be stopped and you will be prompted
All errors	The system boot will not be stopped for any error that may be detected
All, But Keyboard	The system boot will not stop for a keyboard error, it will stop for all other errors
All, But Diskette	The system boot will not stop for a disk error, it will stop for all other errors
All, But Disk/Key	The system boot will not stop for a disk or keyboard error, it will stop for all other errors

Memory

The category is display-only which is determined by POST (Power On Self Test) of the BIOS.

Base Memory The value of the base memory is typically 512K or 640K based on the memory installed on the mainboard.

Extended Memory How much extended memory is present during the POST. This is the amount of memory located above 1MB in the CPU's memory address map.

Other Memory This refers to the memory located in the 640K to 1024K address space. The BIOS is the most frequent user of this RAM area since this is where it shadows RAM.

This screen is a list of system configuration options. Some of them are defaults required by the mainboard's design, others depend on the features of your system.

ROM PCI/ISA BIOS (2A59GA29)

CMOS SETUP UTILITY

AWARD SOFTWARE, INC.

STANDARD CMOS SETUP	INTEGRATED PERIPHERALS
BIOS FEATURES SETUP	SUPERVISOR PASSWORD
CHIPSET FEATURES SETUP	USER PASSWORD
POWER MANAGEMENT SETUP	IDE HDD AUTO DETECTION
PNP/PCI CONFIGURATION	SAVE & EXIT SETUP
LOAD BIOS DEFAULTS	EXIT WITHOUT SAVING
LOAD SETUP DEFAULTS	
ESC: Quit	↑↓→←:Select Item
F10: Save & Exit Setup	(Shift) F2 : Change Color
Virus, Protection, Boot Sequence	

ROM PCI/ISA BIOS (2A59GA29)

BIOS FEATURES SETUP

AWARD SOFTWARE, INC.

Virus Warning : Disabled	Video BIOS Shadow : Enabled
CPU Internal Cache : Enabled	C8000-CBFFF Shadow : Disabled
External Cache : Enabled	CC000-CFFFF Shadow : Disabled
Quick Power On Self Test : Disabled	D0000-D3FFF Shadow : Disabled
Boot Sequence : A, C, SCSI	D4000-D7FFF Shadow : Disabled
Swap Floppy Drive : Disabled	D8000-DBFFF Shadow : Disabled
Boot Up Floppy Seek : Enabled	DC000-DFFFF Shadow : Disabled
Boot Up NumLock Status : On	
Boot Up System Speed : High	
Gate A20 Option : Fast	
Typematic Rate Setting : Disabled	
Typematic Rate(Chars/Sec) : 6	Esc : Quit ↑↓→←:Select Item
Typematic Delay(Msec) : 250	F1 : Help PU/PD/+/- : Modify
Security Option : Setup	F5 : Old Values (SHIFT)F2 : Color
PCI/VGA Palette Snoop : Disabled	F6 : Load BIOS Defaults
OS/2 select for DRAM>64MB : Non-OS2	F7 : Load Setup Defaults
Report No FDD for Win95 : No	

Virus Warning When this item is enabled, the BIOS will monitor the boot sector and partition table of the hard disk drive for any attempt at modification. If an attempt is made, the BIOS will halt the system and the following error message will appear. Many disk diagnostic programs which attempt to access the boot sector table can cause the above warning message. If you will be running such a program, we recommend that you first disable Virus Protection beforehand.

<p>! WARNING !</p> <p>Disk boot sector is to be modified Type 'Y' to accept write or 'N' to abort write Award Software, Inc.</p>

Enabled	Activates automatically when the system boots up causing a warning message to appear when anything attempts to access the boot sector or hard disk partition table.
Disabled	No warning message will appear when anything attempts to access the boot sector or hard disk partition table.

CPU These two categories speed up memory access. However, it depends on CPU/chipset design. The default value is 'enabled'.

Internal Cache

External Cache

Quick Power On Self Test This category speeds up Power On Self Test after you power up the computer. If you set Enabled, BIOS will shorten or skip some check items during POST.

Boot Sequence This category determines which drive to search first for the disk operating system (i.e.,DOS).

Swap Floppy Drive This item allows you to determine whether enable the swap floppy drive or not.

Boot Up Floppy Seek During POST, BIOS will determine if the floppy disk drive installed is 40 tracks (360K) or 80 tracks (720K, 1.2M, 1.44M)

Enabled	BIOS searches for floppy disk drive to determine if it is 40 or 80 tracks
Disabled	BIOS will not search for the type of floppy disk drive by track number

Boot Up NumLock Status This allows you to determine the default state of the numeric keypad. By default, the system boots up with NumLock on.

Boot Up System Speed Selects the default system speed - the normal operating speed at power up.

Gate A20 Option This entry allows you to select how the gate A20 is handled. The gate A20 is a device used to address memory above 1 MB. Normal is keyboard; Fast is chipset.

Typematic Rate Setting This determines if the typematic rate is to be used. When disabled, continually holding down a key on your keyboard will generate only one instance.

Typematic Rate (Chars/Sec) When the typematic rate is enabled, this section allows you select the rate at which the keys are accelerated.

6	6 characters per second
8	8 characters per second
10	10 characters per second
12	12 characters per second
15	15 characters per second
20	20 characters per second
24	24 characters per second
30	30 characters per second

Typematic Delay (Msec) When the typematic rate is enabled, this section allows you select the delay between when the key was first depressed and when the acceleration begins.

250	250 msec
500	500 msec
750	750 msec
1000	1000 msec

Security Option This category allows you to limit access to the system and Setup, or just to Setup

System	The system will not boot and access to Setup will be denied if the correct password is not entered at the prompt
Setup	The system will boot, but access to Setup will be denied if the correct password is not entered at the prompt

To disable security, select PASSWORD SETTING at Main Menu and then you will be asked to enter password. Do not type anything and just press <Enter>, it will disable security. Once the security is disabled, the system will boot and you can enter Setup freely.

**PCI/VGA
Palette Snoop**

It determines whether the MPEG ISA/VESA
VGA cards can work with PCI/VGA or not.

Enabled	When PCI/VGA working with MPEG ISA/VESA VGA Card
Disabled	When PCI/VGA not working with MPEG ISA/VESA VGA Card

**OS Select for
DRAM > 64MB**

This item allows you to access the memory
that over 64MB in OS/2

**Video BIOS
Shadow**

Determines whether video BIOS will be copied to
RAM. However it is optional depending on
chipset design. Video Shadow will increase the
video speed.

**C8000 - CBFFF
Shadow
DC000 - DFFFF
Shadow**

These categories determine whether option
ROMs will be copied to RAM. An example of
such option ROM would be support of onboard
SCSI.

This screen controls the setting for the chipset on the mainboard.

ROM PCI/ISA BIOS (2A59GA29)
 CMOS SETUP UTILITY
 AWARD SOFTWARE, INC.

STANDARD CMOS SETUP	INTEGRATED PERIPHERALS
BIOS FEATURES SETUP	SUPERVISOR PASSWORD
CHIPSET FEATURES SETUP	USER PASSWORD
POWER MANAGEMENT SETUP	IDE HDD AUTO DETECTION
PNP/PCI CONFIGURATION	SAVE & EXIT SETUP
LOAD BIOS DEFAULTS	EXIT WITHOUT SAVING
LOAD SETUP DEFAULTS	
ESC: Quit	↑↓→←:Select Item
F10: Save & Exit Setup	(Shift) F2 : Change Color
AT Clock, DRAM Timmings	

ROM PCI/ISA BIOS (2A59GA29)
 CHIPSET FEATURES SETUP
 AWARD SOFTWARE, INC.

Auto Configuration	: Enabled	Delay Transaction	: Enabled
DRAM Timing	: 70ns		
DRAM RAS# Precharge Time	: 4		
DRAM R/W Leadoff Timing	: 6		
Fast RAS to CAS Delay	: 3		
DRAM Read Burst (EDO/FP)	: x333/X444		
DRAM Write Burst Timing	: x333		
Fast MA to RAS# Delay CLK	: 1		
Fast EDO Path Select	: Disabled		
Refresh RAS# Assertion	: 5 Clks		
ISA Bus Clock	: PCICLK/4		
System BIOS Cacheable	: Disabled		
Video BIOS Cacheable	: Disabled		
8-bit I/O Recovery Time	: 3	Esc: Quit	:Select Item
16-bit I/O Recovery Time	: 2	F1 : Help	PU/PD/+/-:Modify
Memory Hole At 15M-16M	: Disabled	F5 : Old Values (Shift)	F2 :Color
Peer Concurrency	: Enabled	F6 :Load BIOS Defaults	
Passive Release	: Enabled	F7 :Load Setup Defaults	

<u>Auto Configuration</u>	Pre-defined values for DRAM, cache... timing according to CPU type & system clock. When this item is enabled, the pre-defined items will become SHOW-ONLY.
<u>DRAM Timing</u>	The DRAM speed is controlled by the DRAM timing Registers. The timings programmed into this register are dependent on the system design.
<u>DRAM RAS# Precharge Time</u>	DRAM must continually be refreshed or it will lose its data. Normally, DRAM is refreshed entirely as the result of a single request. This option allows you to determine the number of CPU clocks allocated for the Row Address Strobe to accumulate its charge before the DRAM is refreshed. If insufficient time is allowed, refresh may be incomplete and data lost.
<u>Fast RAS# to CAS# Delay</u>	When DRAM is refreshed, both rows and columns are addressed separately. This setup item allows you to determine the timing of the transition from RAS to Column Address Strobe (CAS).
<u>DRAM Read Burst (EDO/FP) DRAM Write Burst Timing</u>	This sets the timing for burst mode read (or writes) from DRAM. Burst read and write requests are generated by the CPU in four separate parts. The first part provides the location within the DRAM where the read or write is to take place while the remaining three parts provide the actual data. The lower the timing numbers, the faster the system will address memory.
<u>ISA Bus Clock</u>	This item allows you to select the PCI clock type. Choices are PCI CLK/3; PCI CLK/4
<u>System BIOS Cacheable</u>	When enabled, accesses to the system BIOS ROM addressed at F0000H-FFFFFH are cached, provided that the cache controller is enabled.

**Video BIOS
Cacheable**

As with changing the system BIOS above, enabling the Video BIOS cache will cause access to video BIOS addressed at C0000H to C7FFFH to be cached, if the cache controller is also enabled.

**8-bit I/O
Recovery Time**

The recovery time is the length of time, measured in CPU clocks, which the system will delay after the completion of an I/O request. This item allows you to determine the recovery time allowed for 8-bit I/O. Choices are from NA, 1 to 8 CPU clocks.

**16-bit I/O
Recovery Time**

This item allows you to determine the recovery time allowed for 16-bit I/O. Choices are from NA, 1 to 4 CPU clocks.

**Memory Hole At
15M-16M**

In order to improve performance, certain space in memory can be reserved for ISA cards. This memory must be mapped into the memory below 16MB.

This screen controls the 'green' features of this mainboard.

ROM PCI/ISA BIOS (2A59GA29)
 CMOS SETUP UTILITY
 AWARD SOFTWARE, INC.

STANDARD CMOS SETUP	INTEGRATED PERIPHERALS
BIOS FEATURES SETUP	SUPERVISOR PASSWORD
CHIPSET FEATURES SETUP	USER PASSWORD
POWER MANAGEMENT SETUP	IDE HDD AUTO DETECTION
PNP/PCI CONFIGURATION	SAVE & EXIT SETUP
LOAD BIOS DEFAULTS	EXIT WITHOUT SAVING
LOAD SETUP DEFAULTS	
ESC: Quit	↑↓→←:Select Item
F10: Save & Exit Setup	(Shift) F2 : Change Color
Sleep Timer, Suspend Timer,	

ROM PCI/ISA BIOS (2A59GA29)
 POWER MANAGEMENT SETUP
 AWARD SOFTWARE, INC.

Power Management	: Disabled	IRQ3 (COM 2)	: OFF
PM Control by APM	: Yes	IRQ4 (COM 1)	: OFF
Video Off Method	: V/H SYNC	IRQ5 (LPT 2)	: OFF
	+Blank	IRQ6 (Floppy Disk)	: OFF
		IRQ7 (LPT 1)	: OFF
Doze Mode	: Disabled	IRQ8 (RTC Alarm)	: OFF
Standby Mode	: Disabled	IRQ9 (IRQ2 Redir)	: OFF
Suspend Mode	: Disabled	IRQ10 (Reserved)	: OFF
HDD Power Down	: Disabled	IRQ11 (Reserved)	: OFF
		IRQ12 (PS/2 Mouse)	: OFF
		IRQ13 (Coprocessor)	: OFF
Wake Up Events in Doze & Standby		IRQ14 (Hard Disk)	: OFF
IRQ3 (Wake-Up Event)	: OFF	IRQ15 (Reserved)	: OFF
IRQ4 (Wake-Up Event)	: OFF		
IRQ8 (Wake-Up Event)	: OFF	Esc: Quit	↑↓→← :Select Item
IRQ12(Wake-Up Event)	: OFF	F1 : Help	PU/PD/+/- : Modify
		F5 : Old Values	(Shift) F2: Color
		F6 : Load BIOS Defaults	
		F7 : Load Setup Defaults	

Power Management

This category allows you to select the type (or degree) of power saving and is directly related to the following modes : Doze; Standby; Suspend; HDD Power Down.

Disabled	No power management. Disables all 4 modes
Min. Power Saving	Minimum power management. Doze=1hr.; Standby=1hr.; Suspend=1hr.; HDD Power Down=15min
Max. Power Saving	Maximum power management only available for SL CPU's. Doze=1 min.; Standby=1min.; Suspend=1min.; HDD Power Down=1 min
User Defined	Allows you to set each mode individually. When not disabled, each of the ranges are from 1min. to 1hr. except for HDD Power Down which ranges from 1 to 15min. and disable

PM Control by APM

When enabled, an Advanced Power Management device will be activated to enhance the Max. Power Saving Mode and stop the CPU internal clock. If the Max. Power Saving is not enabled, this will be present to NO.

Video Off Method

This determines the manner in which the monitor is blanked.

V/H SYNC + Blank	This selection will cause the system to turn off the vertical and horizontal sync. ports and write blanks to the video buffer
Blank Screen	This option only writes blanks to the video buffer
DPMS	Initial display power management signaling

The Following 4 modes are Green PC power saving function which are only user configuration when 'User Defined' power management has been selected.

Doze Mode When enabled and after the set time of system inactivity, the CPU clock will run at slower speed while all other devices still operate at full speed

Standby Mode When enabled and after the set time of system inactivity, the fixed disk drive and the video would be shut off while all other devices still operate at full speed

Suspend Mode When enabled and after the set time of system inactivity, all devices except the CPU will be shut off

HDD Power Down When enabled and after the set time of system inactivity, the hard disk drive will be powered down while all other devices remain active

**Wake Up Events
In Doze & Standby**

**Power Down &
Resume Events** These are I/O events whose occurrence can prevent the system from entering a power saving mode or can awaken the system from such a mode. In effect, the system remains alert for anything which occurs to a device which is configured as On, even when the system is in a power down mode. When an I/O device wants to gain the attention of the operating system, it signals this by causing an IRQ (Interrupt ReQuests) to occur. When the operating system is ready to respond to the request, it interrupts itself and performs the service. When set off, activity will neither prevent the system from going into a power management mode nor awaken it.

IRQ3 ~ IRQ15

This screen configures the PCI Bus slots.

ROM PCI/ISA BIOS (2A59GA29)
 CMOS SETUP UTILITY
 AWARD SOFTWARE, INC.

STANDARD CMOS SETUP	INTEGRATED PERIPHERALS
BIOS FEATURES SETUP	SUPERVISOR PASSWORD
CHIPSET FEATURES SETUP	USER PASSWORD
POWER MANAGEMENT SETUP	IDE HDD AUTO DETECTION
PNP/PCI CONFIGURATION	SAVE & EXIT SETUP
LOAD BIOS DEFAULTS	EXIT WITHOUT SAVING
LOAD SETUP DEFAULTS	
ESC: Quit	↑↓→←:Select Item
F10: Save & Exit Setup	(Shift) F2 : Change Color
IRQ Settings, Latency Timers,	

ROM PCI/ISA BIOS (2A59GA29)
 PNP/PCI CONFIGURATION
 AWARD SOFTWARE, INC.

Resources Controlled by : Auto	PCI IRQ Actived by : Level
Reset Configuration Data : Disabled	PCI IDE IRQ Map to : PCI-AUTO
	Primary IDE INT# : A
	Secondary IDE INT# : B
	Esc: Qui ↑↓→← :Select Item
	F1 : Help PU/PD/+/- : Modify
	F5 : Old Values (Shift) F2: Color
	F6 : Load BIOS Defaults
	F7 : Load Setup Defaults

<u>Resource Controlled by</u>	The Award Plug and Play BIOS has the capacity to automatically configure all of the boot and Plug and Play compatible devices. However, this capability means absolutely nothing unless you are using a Plug and Play OS such as Windows 95 Choices are Auto and Manual
<u>Reset Configuration Data</u>	This item allows you to determine reset the configuration data or not.
<u>PCI IRQ Activated By</u>	This sets the method by which the PCI bus recognizes that an IRQ service is being requested by a device. Under all circumstances, you should retain the default configuration unless advised otherwise by your system's manufacturer. Choices are Level and Edge
<u>PCI IDE IRQ Map To</u>	This allows you to configure your system to the type of IDE disk controller in use. If you have equipped your system with a PCI controller, changing this allows you to specify which slot has the controller and which PCI interrupt (A,B,C,D) is associated with the connected hard disk. Select 'PCI Auto' allows the system to automatically determine how your IDE disk system is configured.

This section page includes all the items of IDE hard drive and Programmed Input/Output features. See also Section "Chipset FeaturesSetup".

ROM PCI/ISA BIOS (2A59GA29)
 CMOS SETUP UTILITY
 AWARD SOFTWARE, INC.

STANDARD CMOS SETUP	INTEGRATED PERIPHERALS
BIOS FEATURES SETUP	SUPERVISOR PASSWORD
CHIPSET FEATURES SETUP	USER PASSWORD
POWER MANAGEMENT SETUP	IDE HDD AUTO DETECTION
PNP/PCI CONFIGURATION	SAVE & EXIT SETUP
LOAD BIOS DEFAULTS	EXIT WITHOUT SAVING
LOAD SETUP DEFAULTS	
ESC: Quit	↑↓→←:Select Item
F10: Save & Exit Setup	(Shift) F2 : Change Color
Time, Date, Hard Disk Type	

ROM PCI/ISA BIOS (2A59GA29)
 INTEGRATED PERIPHERALS
 AWARD SOFTWARE, INC.

IDE HDD Block Mode : Enabled	ECP Mode Use DMA : 3
IDE 32-bit Transfer Mode : Enabled	
IDE Primary Master PIO : Auto	
IDE Primary Slave PIO : Auto	
IDE Secondary Master PIO : Auto	
IDE Secondary Slave PIO : Auto	
On-Chip Primary PCI IDE : Enabled	
On-Chip Secondary PCI IDE : Enabled	
PCI Slot IDE 2nd Channel : Enabled	
USB Controller : Disabled	
Onboard FDD Controller : Enabled	
Onboard Serial Port 1 : Auto	
Onboard Serial Port 2 : Auto	Esc: Quit ↑↓→← :Select Item
UART 2 Mode : Standard	F1 : Help PU/PD/+/- : Modify
Onboard Parallel Port : 378H/IRQ7	F5 : Old Values (Shift) F2: Color
Onboard Parallel Mode : ECP	F6 : Load BIOS Defaults
	F7 : Load Setup Defaults

IDE HDD Block Mode This allows your HD controller to use the fast block mode to transfer data to and from your HD drive

Enabled	IDE controller uses block mode
Disabled	IDE controller uses standard mode

IDE Primary Master/Slave PIO PIO - Programmed Input/Output, it allows the BIOS to tell the controller what it wants and then let the controller and the CPU perform the complete task by themselves. This simpler and more faster. Your system supports five mods, 0 - 4, which primarily differ in timing. When Auto is selected, the BIOS will select the best available mode.

On-Chip Primary PCI IDE This setup item allows you either to enable or disable the primary/secondary controller. You might choose to disable the controller if you were to add a higher performance or specialized controller.

On-Chip Secondary PCI IDE This item allows you designate an IDE controller controller board insert into one of the physical PCI slots as your secondary IDE

Enabled	External IDE controller designated as the secondary controller
Disabled	No IDE controller occupying a PCI slot

The last step is 'save and exit'. If you select this item and press 'Y', then these records will be saved in the CMOS memory on the mainboard. It will be checked every time when you turn your computer on.

ROM PCI/ISA BIOS (2A59GA29)
 CMOS SETUP UTILITY
 AWARD SOFTWARE, INC.

STANDARD CMOS SETUP	INTEGRATED PERIPHERALS
BIOS FEATURES SETUP	SUPERVISOR PASSWORD
CHIPSET FEATURES SETUP	USER PASSWORD
POWER MANAGEMENT SETUP	IDE HDD AUTO DETECTION
PNP/PCI CONFIGURATION	SAVE & EXIT SETUP
LOAD BIOS DEFAULTS	EXIT WITHOUT SAVING
LOAD SETUP DEFAULTS	
ESC: Quit	↑↓→←:Select Item
F10: Save & Exit Setup	(Shift) F2 : Change Color
Time, Date, Hard Disk Type	

STANDARD CMOS SETUP	INTEGRATED PERIPHERALS
BIOS FEATURES SETUP	SUPERVISOR PASSWORD
CHIPSET FEATURES SETUP	USER PASSWORD
POWER MANAGEMENT SETUP	IDE HDD AUTO DETECTION
PNP/PCI CONFIGURATION	SAVE & EXIT SETUP
LOAD BIOS DEFAULTS	EXIT WITHOUT SAVING
LOAD SETUP DEFAULTS	
ESC: Quit	↑↓→←:Select Item
F10: Save & Exit Setup	(Shift) F2 : Change Color
Auto-Configure HDD: Sector, Cylinder, Head	

LOAD BIOS DEFAULTS

When your mainboard has problems and need to debug or troubleshoot the system, you can use this function. The default values loaded only affect the BIOS Features Setup, Chipset Features Setup, Power Management Setup and PNP/PCI Configuration Setup. There is no effect on the Standard CMOS Setup. To use this function, select it from main menu and press <Enter>. A line will appear on the screen asking if you want to load the BIOS default values. Press <Yes> and <Enter> then the BIOS default values will be loaded.

LOAD SETUP DEFAULTS

This allows you load optimal settings which are stored in the BIOS ROM. The default values loaded only affect the BIOS Features Setup, Chipset Features Setup, Power Management Setup and PNP/PCI Configuration Setup. There is no effect on the Standard CMOS Setup. To use this function, select it from main menu and press <Enter>. A line will appear on the screen asking if you want to load the Setup default values. Press <Yes> and <Enter> then the Setup default values will be loaded.

SUPERVISOR PASSWORD / USER PASSWORD

This allows you to set the password. the mainboard defaults password disabled.

Enter/Change password : Enter the current password, at the prompt key-in your new password (up to eight alphanumeric characters), press <Enter>. At the next prompt, confirm the new password by typing it and press <Enter> again.

Disable password : Press <Enter> key instead of entering a new password when the 'Enter Password' dialog box appears. A message will appear confirming that the password is disable.

If you set both supervisor and user passwords, only the supervisor password allows you to enter the BIOS SETUP program.

CAUTION :If you forget your password, you must disable the CMOS by turning power off and set JP8 'close'. Then reload the system. Please refer to page 13.

IDD HDD AUTO DETECTION

This allows you to detect IDE hard drivers' parameters and enter them into 'Standard CMOS Setup' automatically.

If the auto-detected parameters displayed do not match the ones that should be used for your hard drive, do not accept them. Press <N> to reject the values and enter the correct ones manually on the Standard CMOS Setup screen.

SAVE & EXIT SETUP

This allows you to save the new setting values in the CMOS memory and continue with the booting process. Select what you want to do, press <Enter>.

EXIT WITHOUT SAVING

This allows you to exit the BIOS setup utility without recording any new values or changing old ones.

※ Control Key Description ※

UP ARROW	↑	Move to previous item
DOWN ARROW	↓	Move to next item
LEFT ARROW	←	Move to the item in the left hand
RIGHT ARROW	→	Move to the item in the right hand
Esc KEY	Esc	Main Menu : Quit and not save changes Setup menu : Exit current page and return to main menu
PgUp KEY		Increase the numeric value or make changes
PgDn KEY		Decrease the numeric value or make changes
F1 KEY	Help	General help
F2 KEY	<Shift>+F2	Change color from total 16 colors
F5 KEY	Old Value	Restore the pervious CMOS value from CMOS
F6 KEY	Load BIOS default	Load the default CMOS value from BIOS default table
F7 KEY	Load setup default	Load Setup default
F10 KEY	Save & Exit Setup	Save all the CMOS changes and Exit setup, only for Main Menu

APPENDIX A

※※TECHNICAL SUPPORT REQUEST FORM※※

If the mainboard doesn't function properly, please complete the following information and return it to your system dealer. If the further information is needed, please attach this separating sheets.

Model No : ATC-1020+ Date of Purchase : _____

Serial No : _____

HARDWARE :

	BRAND	MODEL	SPEED	Q'TY
CPU				
SIM Module				
PB. Cache on Board				
TAG SRAM				
Sync. SRAM Module				

SIMM : _____ MB (__ EDO, __ FastPage)

Hard Disk Interface Controller : __ IDE, __ SCSI

Hard Disk Brand : _____, Model : _____, Capacity : _____

Display Controller Brand : _____, Model : _____

Controller Chip Brand : _____, Model : _____

AWARD SYSTEM BIOS: Version _____ Date Code _____

Keyboard BIOS: Brand _____

Other Add-on Cards Information:



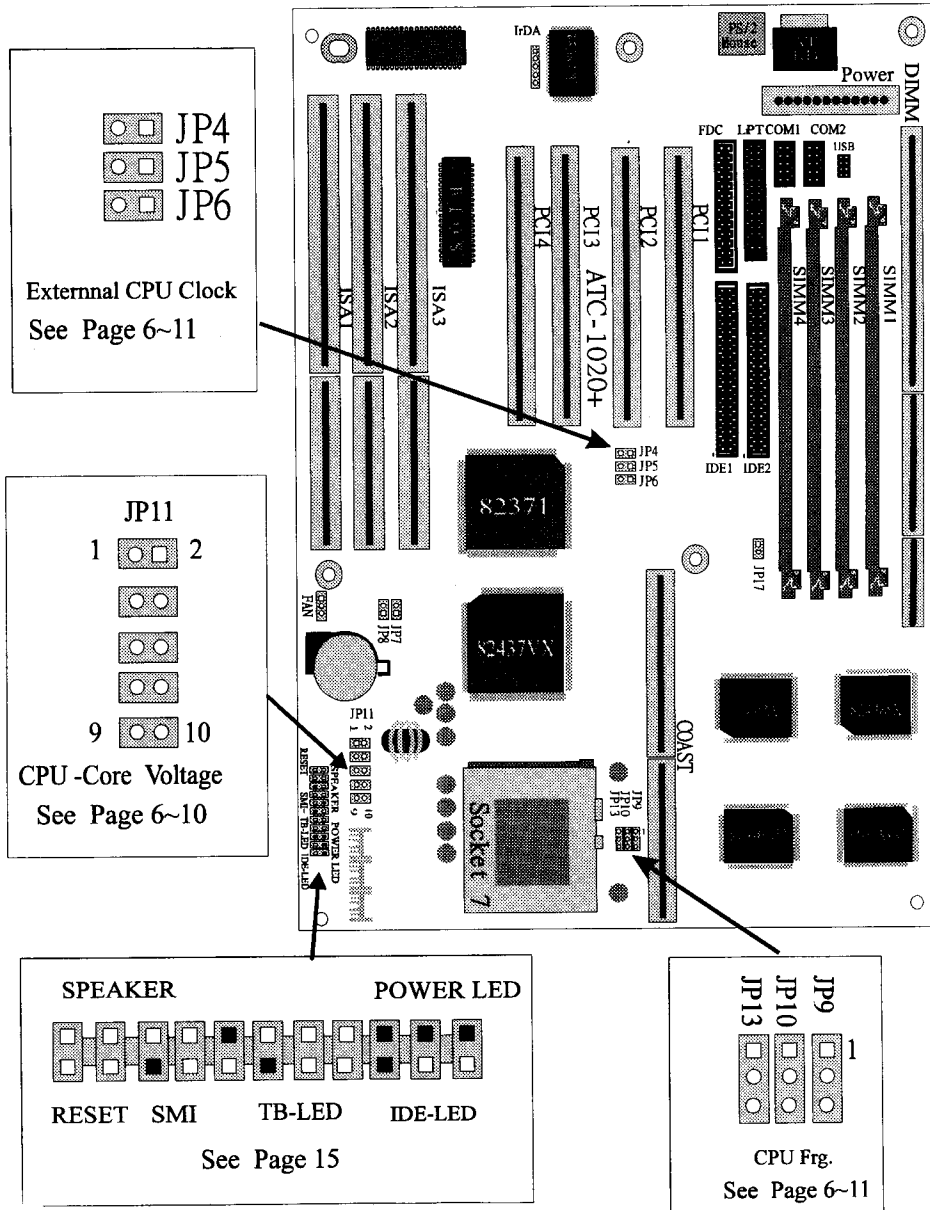

Add-on Card	Bus Interface	Model	Remark

Error Description :

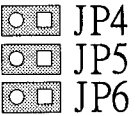
ATC-1020+ Intel 430VX Mainboard Component Location Diagram



 JP4
 JP5
 JP6
 External CPU Clock
 See Page 6~11

JP11
 1  2

 9  10
 CPU-Core Voltage
 See Page 6~10

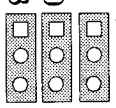
SPEAKER POWER LED

 RESET SMI TB-LED IDE-LED
 See Page 15

JP9 JP10 JP13

 CPU Frig.
 See Page 6~11

A