

AM37S

MAINBOARD MANUAL

DOC No.: M02A10

Rev. :A0

Date : 11, 2002

Part No. : 25-12192-00

Handling Precautions

Warning:

1. Static electricity may cause damage to the integrated circuits on the motherboard. Before handling any motherboard outside of its protective packaging, ensure that there is no static electric charge in your body.
2. There is a danger of explosion if the battery is incorrectly replaced. Replace only with the same or an equivalent type recommended by the manufacturer.
3. Discard used batteries according to the manufacturer's instructions.
4. Never run the processor without the heatsink properly and firmly attached. PERMANENT DAMAGE WILL RESULT!

Observe the following basic precautions when handling the motherboard or other computer components:

- Wear a static wrist strap which fits around your wrist and is connected to a natural earth ground.
- Touch a grounded or anti-static surface or a metal fixture such as a water pipe.
- Avoid contacting the components on add-on cards, motherboards, and modules with the *golden fingers* connectors plugged into the expansion slot. It is best to handle system components by their mounting brackets.

The above methods prevent static build-up and cause it to be discharged properly.

Trademark

All trademarks mentioned in this manual are registered properly of the respective owners.

Handling Precautions

This manual may not, in whole or in part, be photocopied, reproduced, transcribed, translated, or transmitted in whatever form without the written consent of the manufacturer, except for copies retained by the purchaser for personal archival purposes.

Quick Reference (German)	G-1
Quick Reference (French)	F-1
Quick Reference (Spanish)	S-1
Quick Reference (Japanese)	J-1
Quick Reference (Chinese)	C-1
Quick Reference (Simplified Chinese)	SC-1

Chapter 1 Overview

Package Checklist	1-2
The AM37S Mainboard	1-3
Main Features	1-4
FIC Unique Innovation for Users (NOVUS) - Enhanced Mainboard Features and System Support	1-6

Chapter 2 Installation Procedures

Quick Reference (from Page 2-2 to 2-4)	2-2
Mainboard Layout	2-2
1). Clear CMOS, Clear Password, FSB Speed Select	2-3
2). Front Panel Block Cable Connection	2-3
3). CPU Fan Installation	2-4
1). Set System Jumpers	2-4
Clear CMOS: CLR_CMOS	2-4
Clear Password: CLR_PWD	2-5
FSB Frequency Select: FSB	2-6
2). Install Memory Modules	2-6
3). Install the CPU	2-7
4). Install Expansion Cards	2-8
5). Connect Devices	2-9
Floppy Diskette Drive Connector	2-9
IDE Device Connectors	2-10
ATX Power Connectors	2-10
Fan Connectors	2-11
SPDIF_OUT Connector	2-11
Wake-On-Ring Connector	2-12

Wake-On-Lan Connector	2-12
CD Audio-In Connectors	2-13
SIRQ Connector	2-13
Front Panel Block and IR Connector	2-14
PS/2 Keyboard and Mouse Connector	2-15
Serial Port Connectors	2-15
Universal Serial Bus Connectors	2-16
Printer Connector	2-16
Audio I/O Jacks	2-17
Video Graphics Accelerator Connector	2-17
LAN Connector (optional)	2-18

Chapter 3 BIOS Setup

CMOS Setup Utility	3-1
Standard CMOS Setup	3-2
Advanced BIOS Features	3-4
Advanced Chipset Features	3-8
Integrated Peripherals	3-11
Power Management Setup	3-15
PnP/PCI Configurations	3-19
PC Health Status	3-20
Frequency/Voltage Control	3-21
Load Fail-Safe Defaults	3-22
Load Optimized Defaults	3-22
Supervisor/User Password	3-22
Save and Exit Setup	3-22
Exit without Saving	3-22

Overview

The new 1stMainboard® AM37S™ is an Micro ATX sized motherboard supporting the latest generation of AMD® processors at industry leading speeds. By utilizing DDR (Double Data Rate) transfer rate the 100/133 MHz system bus effectively reaches Front Side Bus speeds of 200/266 MHz. The board provides users with an ATA133 data transaction for hard drives and allows up to 2 GB memory totally by 2 PC100/133 SDRAM DIMM sockets.

The AM37S is based around the high performance KM266™ core chip with VIA VT8235™ as a South Bridge. The video functions supported by KM266 provides you with a photo-realistic 3D experience suitable for the most robust 3D games and software environments. AC97 Codec that embedded in VT8235, ensures high quality video and audio effect. The mainboard features onboard audio with either 2-channel or 5.1-channel.

The mainboard also comes equipped with the new NOVUS® range of innovative features that assist in the installation and maintenance. The features include *Easy Key*, which provides instant keyboard access to the BIOS for adjustments to Clock and Default settings and the *BIOS Guardian* is an Anti Virus utility that prevents viruses from damaging your system BIOS and rendering your system inoperative.

Expansion is provided by 1 AGP 4X and 3 PCI slots. In addition, the 1stMainboard is equipped standard I/O connections include 2 serial ports (1 by pinheader), 1 parallel port, 1 VGA port, 1 PS/2 mouse and keyboard connector, 6 USB 2.0 ports (2 ports by one pinheader), 1 IR port by pinheader, and 1 media connector (Line-In, Line-Out, Mic-In, 1 front audio).

Package Checklist

If you discover any item below was damaged or lost, please contact your vendor.

- The mainboard
- This user manual
- One FDD cable
- CD software
- One ATA100 cable
- I/O shielding

IMPORTANT: AMD CPU HEAT SINK INSTALLATION



Be ware finish heat sink install. Before you boot system, please check the heat sink is complete contact with die of CPU.

The poor contact will bring about over heat, it may damage your processor.

It is strongly recommended that at least a 250-watt ATX power pupply be used for this motherboard. Make sure that your ATX power supply can supply at least 20 amperes on teh +5-Volt lead and 10mA on the +5-Volt standby lead (+5VSB). Your system may become unstable / unreliable and may experience difficulty in powering up if your power supply is inadequate.



NOTE: Software driver/utility CD that contains patch files, onboard video/audio chip drivers, related online help and other useful information can be found in your mainboard package.

Please install it right after your Windows operating system installation is done. Place the CD in the drive, an operating menu will appears in your monitor. Please select *Auto Installation*. It will automatically detect which software tools (patch files, drivers) that the mainboard needs. Press **OK** button to go through the whole installation procedure in a very straight forward and easy way. It also provides you with a custom way to select wanted patch files and software drivers that for onboard chips use. **The top menu of the CD lists all the functions that allowed by this board.**

The AM37S Mainboard

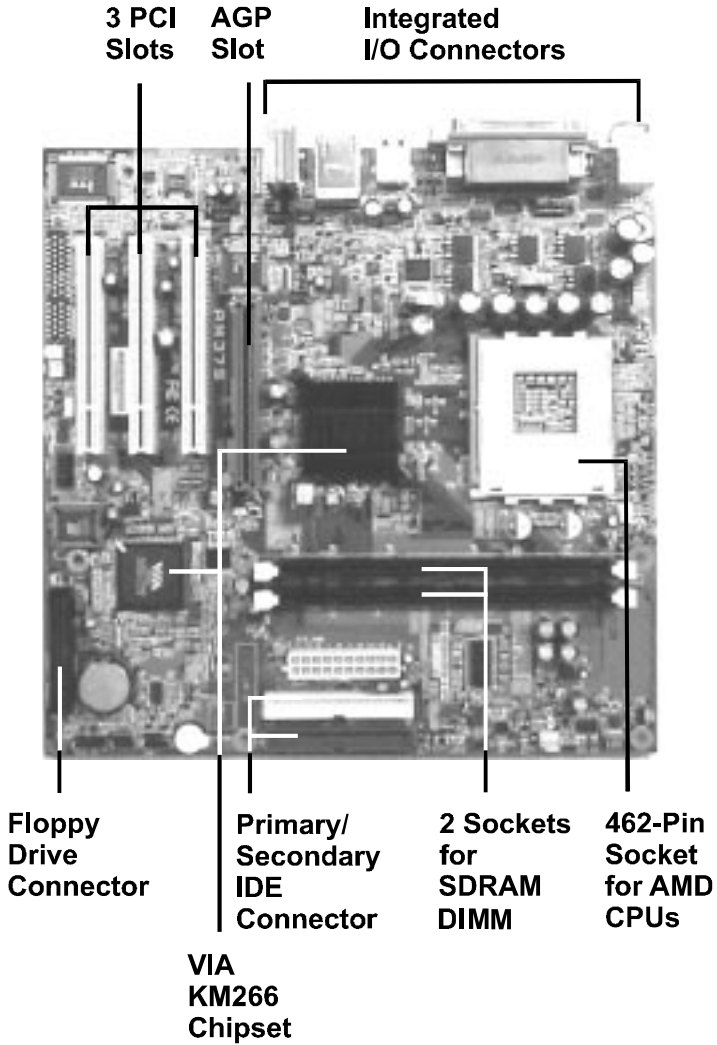

Main Features

- Easy Installation

BIOS with support for Plug and Play, auto detection of IDE hard drives, LS-120 drives, IDE ZIP drives, Windows 98SE, Windows ME, Windows NT, Windows 2000, Windows XP, and OS/2.

- Leading Edge Chipset

VIA KM266 is a single-chip North Bridge for AMD CPUs with 200/266 MHz Front Side Bus with AGP and PCI plus advanced memory controller that supports DDR266/200 SDRAM. VIA VT8235 is a V-Link client highly integrated controller that supports PC99-compliant system. The VT8235 also supports ATA100/133 protocol.

- Advanced High Performance Memory Controller

Accepts up to 1GB DRAM using two DIMMs of 32, 64, 128, 256, 512MB with support for lightning-fast PC100/133 SDRAM.

- AMD Processors Support

Athlon XP: 1500+ to 2600+* and up* at 266 MHz FSB;
Athlon: 900 MHz to 1.4 GHz and up* at 200 MHz FSB;
1.0 GHz to 1.4 GHz at 266 MHz FSB;
Duron: 900 MHz to 1.3 GHz and up* at 200 MHz FSB
(*: not tested yet)

- Enhanced PCI Bus Master IDE Controller with UltraDMA/33/66/100/133 Support

Integrated Enhanced PCI Bus Master IDE controller features two dual-channel connectors that up to four Enhanced IDE devices, including CD-ROM and Tape Backup Drives, as well as Hard Disk Drives supporting the new UltraDMA/133 Mode 6 protocol, standard PIO Mode 3, PIO Mode 4, DMA Mode 2, DMA Mode 4, UltraDMA/100 Mode 5 devices are also supported.

-
- **AGP and PCI Expansion Slots**

One AGP Bus and three PCI Bus expansion slots provided the room to install a full range of add-on cards.
 - **Compact Onboard Audio Subsystem**

Embedded in VIA VT82335, an integrated high bandwidth V-Link client controller, direct sound AC97 audio subsystem. UltraDMA master mode EIDE controller, USB controller, ACPI enhanced power management, and PC99 compliant. The onboard AC97 Codec chip has two options: either supports 2-channel or 5.1-channel audio feature. If the latter one onboard, the Microphone/Line_In/Line_Out can be used as audio output.
 - **Super Multi Input/Output (I/O) Support**

Integrated Plug and Play multi-I/O chipset features two high-speed UART 16550 compatible serial ports, one EPP/ECP capable parallel port, one IR port, and one HDD connector.
 - **Convenient Rear Panel USB Connection Support**

Four USB 2.0 ports integrated in the rear I/O panel and two extra USB 2.0 ports for either front or rear panel connection allow convenient and high-speed Plug and Play connections to the growing number of USB 2.0 compliant peripheral devices on the market.
 - **Onboard Accelerated Graphics Port (AGP)**

The motherboard is installed one 32-bit AGP 4X bus with a dedicated 66MHz/133MHz path from the graphics card to the system memory offering much greater bandwidth than the 32-bit PCI bus does. AGP enabled 3D graphics cards can directly access main memory across this fast path instead of using local memory.
 - **LAN Support (optional)**

Onboard optional LAN controller with one optional LAN jack integrated with other rear panel I/O connectors provides users with a convenient connection with network environment.

FIC Unique Innovation for Users (NOVUS) - Enhanced Mainboard Features and System Support

- BIOS Guardian

BIOS Guardian effectively acts as a fire-wall against viruses that can attack the BIOS while the system is running and by default is enabled.



WARNING:

BIOS Guardian must be disabled before reflash BIOS.



NOTE:

Please read Page 3-7 for detail information.

- Easy Key

Instead of completing the multi-layered BIOS setup process these 3 Easy Key functions provide direct access to Sub-Menu when completing BIOS settings adjustments.

Easy-Keys are as follows:

Ctrl + c: To enter clock settings menu.

Ctrl + p: To load Performance Default settings and restart.

Ctrl + f: To load Fail-Safe Default settings and restart.

Installation Procedures

The mainboard has several user-adjustable jumpers on the board that allow you to configure your system to suit your requirements. This chapter contains information on the various jumper settings on your mainboard.

To set up your computer, you must complete the following steps:

- Step 1 - **Set system jumpers**
- Step 2 - **Install memory modules**
- Step 3 - **Install the Central Processing Unit (CPU)**
- Step 4 - **Install expansion cards**
- Step 5 - **Connect ribbon cables, cabinet wires, and power supply**
- Step 6 - **Set up BIOS software**
- Step 7 - **Install supporting software tools**



WARNING: Excessive torque may damage the mainboard. When using an electric screwdriver on the mainboard, make sure that the torque is set to the allowable range of 5.0 ~ 8.0kg/cm.

Mainboard components contain very delicate Integrated Circuit (IC) chips. To prevent static electricity from harming any of the sensitive components, you should follow the following precautions whenever working on the computer:

1. Unplug the computer when working on the inside.
2. Hold components by the edges and try not to touch the IC chips, leads, or circuitry.
3. Wear an anti-static wrist strap which fits around the wrist.
4. Place components on a grounded anti-static pad or on the bag that came with the component whenever the components are separated from the system.

Quick Reference (from Page 2-2 to 2-4) Mainboard Layout

Chapter 2
Installation
Procedures

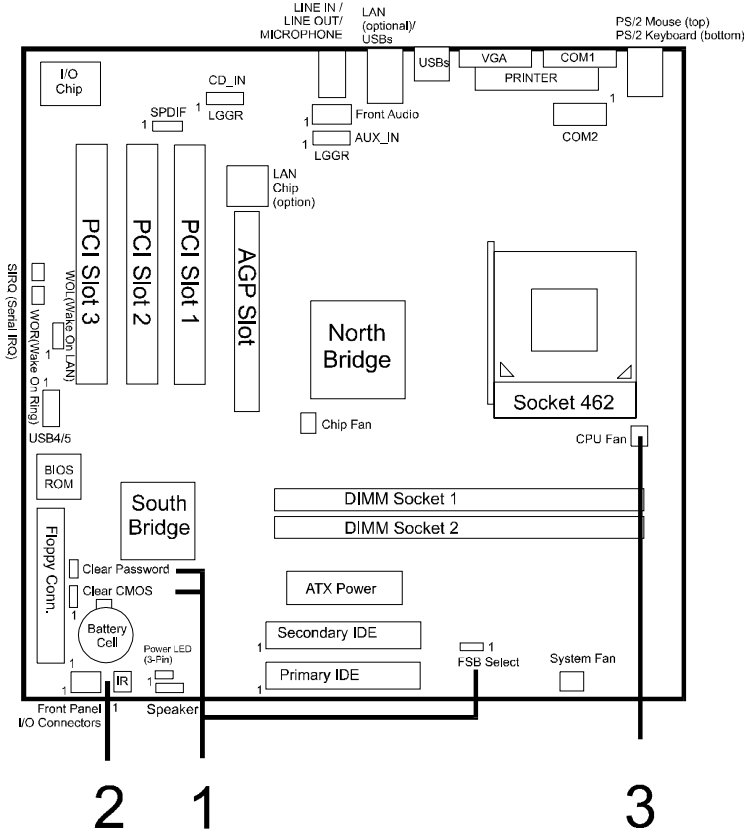

* When link to Line_Out jack, please use a speaker that with amplifier.

1). Clear CMOS, Clear Password, FSB Speed Select

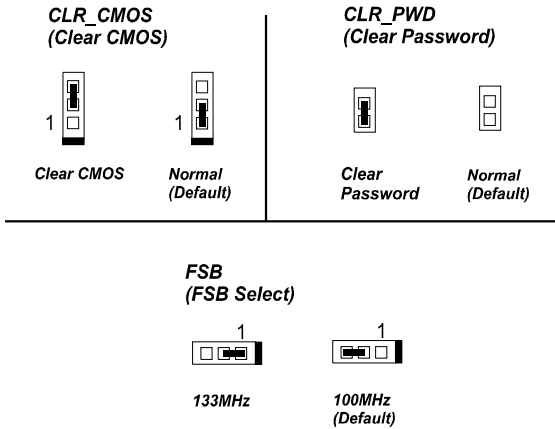

2). Front Panel Block Cable Connection

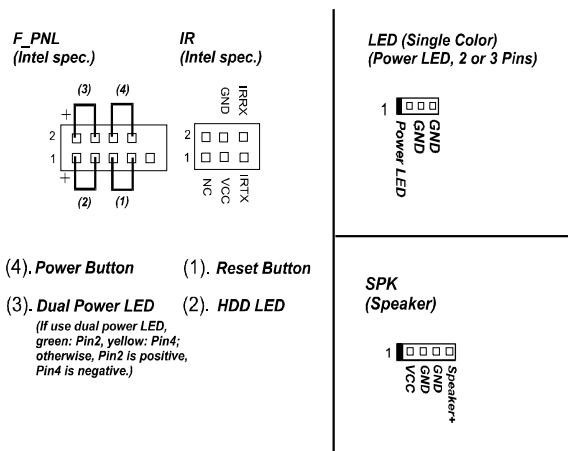

3). CPU Fan Installation



CAUTION:

1. The heatsink and fan you installed must be approved by AMD.
2. The mainboard must be placed on a solid place to avoid shaking while install the heatsink and fan on the board.
3. The heatsink must be contact with the CPU top tightly.
4. Never run the processor without the heatsink properly and firmly attached. PERMANENT DAMAGE WILL RESULT!

Without sufficient air circulation, the CPU may overheat resulting in damage to both the CPU and the mainboard.

Damage may occur to the mainboard and/or the CPU fan if these pins are used incorrectly. These are not jumpers, do not place jumper caps over these pins.

1). Set System Jumpers



NOTE: Users are not encouraged to change the jumper settings not listed in this manual. Changing the jumper settings improperly may adversely affect system performance.

Clear CMOS: CLR_CMOS

- (1) Turn off your computer
- (2) Place the jumper cap onto the pinpair 2-3 at least 6 seconds to clear CMOS
- (3) Place the jumper cap onto the pinpair 1-2 to Normal
- (4) Turn on your computer until CMOS checksum error appears
- (5) Hold down the **Delete** key when boots
- (6) Enter the BIOS Setup to re-enter user preferences, save it and exit.

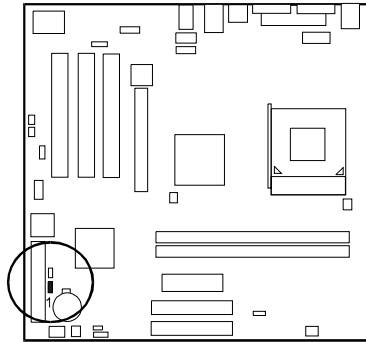
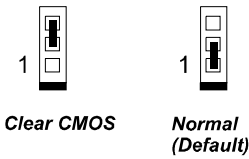

Clear Password: CLR_PWD

- (1). Turn off your computer
- (2). Short this jumper by placing a jumper cap on it
- (3). Turn on your computer
- (4). Hold down the Delete key during boot and enter BIOS Setup to clear password
- (5). Save the password setting and exit
- (5). Turn off your computer
- (6). Remove the jumper cap
- (7). Turn on your computer for the new password to take effect.

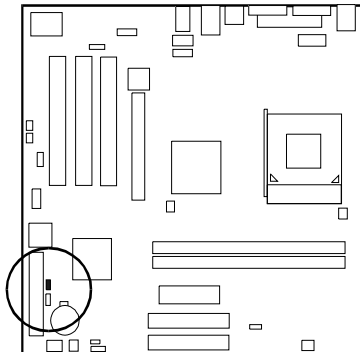
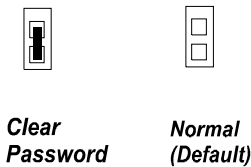

FSB Frequency Select: FSB

This jumper allows you to select the front side bus frequency of the board.

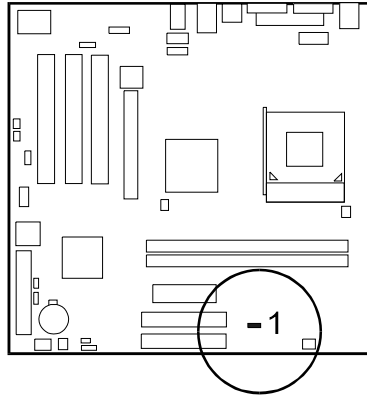
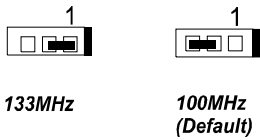

2). Install Memory Modules

1. Locate the DIMM slots on the mainboard.
2. Install the DIMM straight down into the DIMM slot using both hands.
3. The clip on both ends of the DIMM slot will close up to hold the DIMM in place when the DIMM reaches the slot bottom.

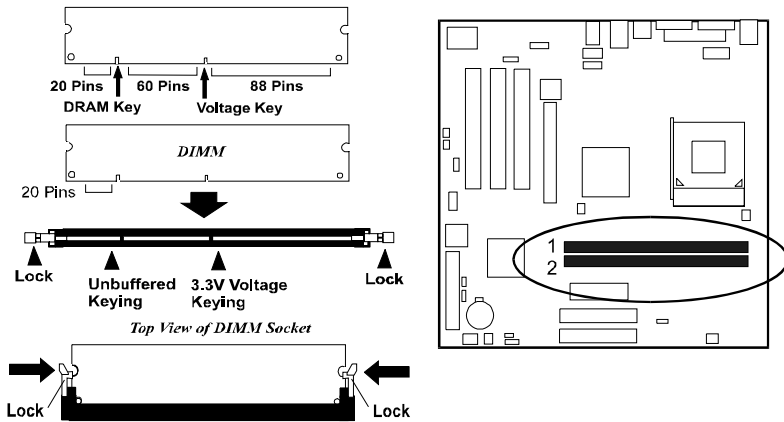

Press the clips with both hands to remove the memory module.

3). Install the CPU

The AMD CPU module resides in the socket on the board. Please follow the steps introduced below to complete the CPU installation.

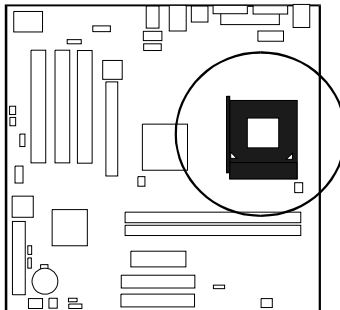

CAUTION:

1. The heat sink and fan you installed must be approved by AMD.
2. The mainboard must be placed on a solid place to avoid shaking while install the heat sink and fan on the board.
3. The heat sink must be contact with the CPU top tightly.
4. Never run the processor without the heat sink properly and firmly attached. PERMANENT DAMAGE WILL RESULT!

To install the CPU, do the following:

1. Lift the lever on the side of the CPU socket.
2. Handle the chip by its edges and try not to touch any of the pins.
3. Place the CPU in the socket. The chip has two notches to correctly locate the chip. Align two notches of the processor with the two triangular marks on the socket. Do not force the chip. The CPU should slide easily into the socket.
4. Swing the lever to the down position to lock the CPU in place.
5. Install the cooling fan with heat sink on top of the installed CPU.
6. Place the mainboard (with the CPU, its cooling fan, and heat sink) into the system chassis and affix it with screws.

4). Install Expansion Cards

This section describes how to connect an expansion card to one of your system expansion slots. Expansion cards are printed circuit boards that, when connected to the mainboard, increase the capabilities of your system. For example, expansion cards can provide video and sound capabilities. The mainboard features one AGP 4X and three PCI bus expansion slots.

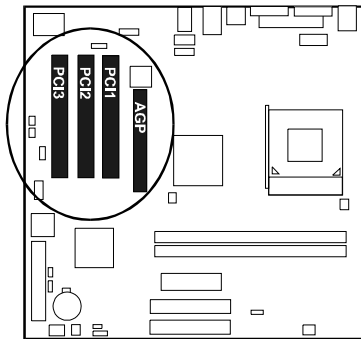

CAUTION: Make sure to unplug the power supply when adding or removing expansion cards or other system components. Failure to do so may cause severe damage to both the mainboard and expansioncards.

Always observe static electricity precautions.

Please read **Handling Precautions** at the start of this manual.

To install an expansion card, follow the steps below:

1. Remove the chassis cover and select an empty expansion slot.
2. Remove the corresponding slot cover from the computer chassis. Unscrew the mounting screw that secures the slot cover and pull the slot cover out from the computer chassis. Keep the slot cover mounting screw nearby.
3. Holding the edge of the peripheral card, carefully align the edge connector with the expansion slot.
4. Push the card firmly into the slot. Push down on one end of the expansion card, then the other. Use this rocking motion until the add-on card is firmly seated inside the expansion slot.
5. Secure the board with the mounting screw removed in Step 2. Make sure that the card has been placed evenly and completely into the expansion slot.
6. Replace the computer system cover.
7. Setup the BIOS if necessary.
8. Install the necessary software drivers for the expansion card.

5). Connect Devices

Floppy Diskette Drive Connector

This connector provides the connection with your floppy disk drive. The red stripe of the ribbon cable must be the same side with the Pin 1.

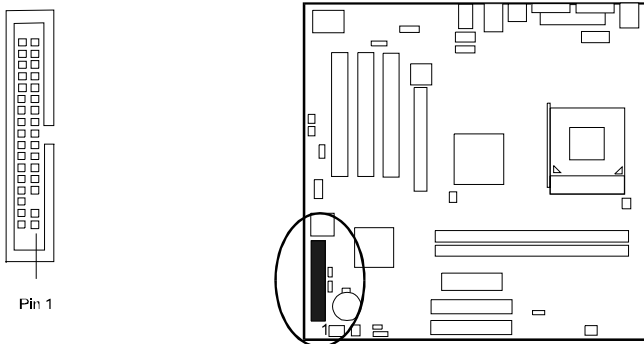

Fan Connectors

The connector, CPU_FAN, is linked to the CPU fan to lower the CPU temperature. The CHIP_FAN connector can be used by North Bridge cooling fan. The SYS_FAN connector allows you to link with the cooling fan on the system case to lower the system temperature.

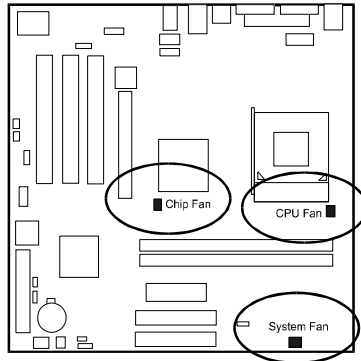
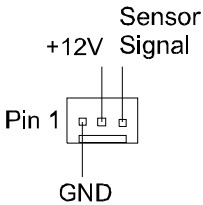

**Chapter 2
Installation
Procedures**

SPDIF_OUT Connector

The mainboard equipped a 1x3 pinhead. It is used for audio output that with SPDIF spec. .

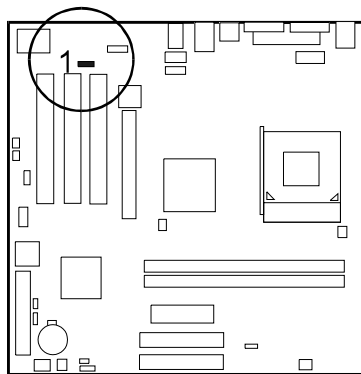
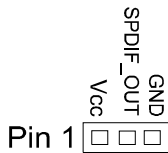

Wake-On-Ring Connector

The 2-pin connector allows you to link with your modem card which outputs a WOR signal; the system can be turned on from the power-off status by a remote phone call via the modem card.

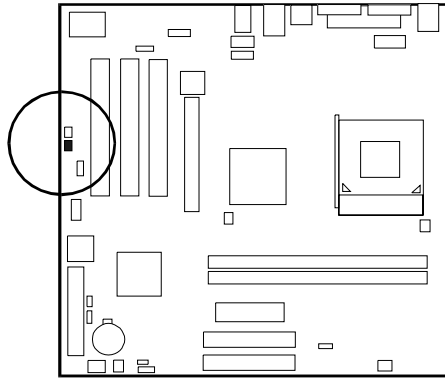
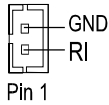

Wake-On-Lan Connector

This 3-pin connector allows the remote servers to manage the system that installed this mainboard via your network adapter which also supports WOL.

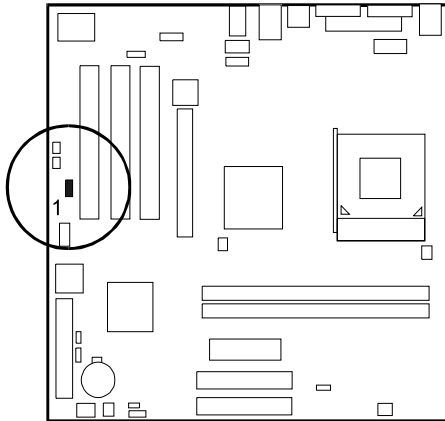
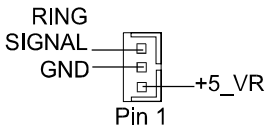

CD Audio-In Connectors

The CD_IN connector is used as a port for audio input from CD drive. The AUX_IN provided users with one extra audio input port from CD drive.

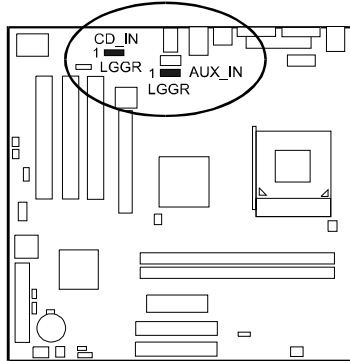

**Chapter 2
Installation
Procedures**

SIRQ Connector

The 2-pin connector provides with a connection for some add-on cards that require a serial IRQ linkage to the mainboard for the system operation use.

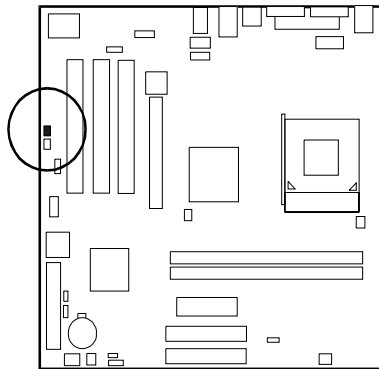

Front Panel Block and IR Connector

This block connector includes the connectors for linking with Power LED (2 pins and 3 pins), HDD LED, power/sleep button, power/sleep LED, reset button on the front panel of the system case. Please identify polarities of plug wires for the case speaker and LEDs. Please ask vendor about this information when you buy them and install the system by yourself. The plug wires polarities of these buttons will not affect the function.

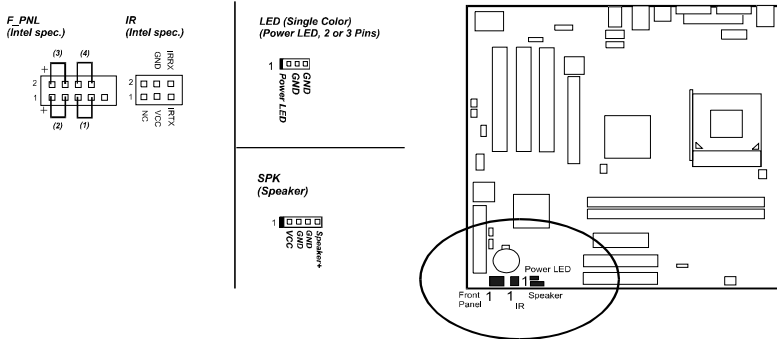

(1) **Reset Switch** is connected to the reset button. Push this switch to reboot the system instead of turning the power button off and on.

(2) **HDD LED** is connected to the IDE device indicator. This LED will blink when the hard disk drives are activated.

(3) Power/Sleep LED (2-Pin/3-Pin)

Please refer to the tables below for the representations of LED states.

Single-Color (2, 3 Pins)

LED	Meaning	State
Off	Off	S4/S5
On	Full On	S0
Flash	Sleep	S1/S3

Dual-Color

LED	Meaning	State
Off	Off	S4/S5
Green	Full On	S0
Yellow	Sleep	S1/S3

(4) **Power Button** is connected with power button. Push this switch allows the system to be turned on and off rather than using the power supply button.

IR is a pinheader that is used for linking with your ID device to allow transmission of data to another system that also supports the IR feature.

Speaker is a pinheader for connecting to speaker.

PS/2 Keyboard and Mouse Connector

These two 6-pin female (PS/2 keyboard is purple color and PS/2 mouse is green color) connectors are used for your PS/2 keyboard and PS/2 mouse.

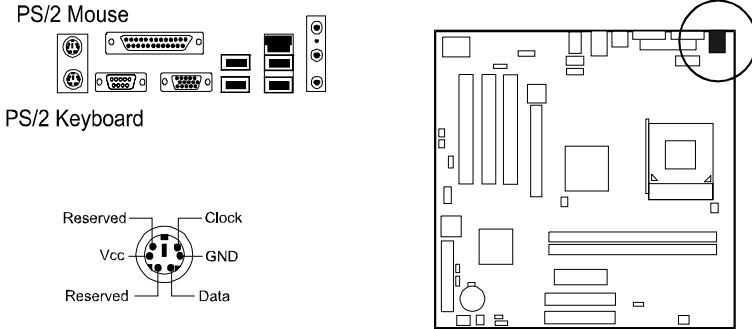

Serial Port Connectors

COM1 (9-pin D-sub male connector with teal color) and COM2 (9-pin male connector) allow you to connect with your devices that use serial ports, such as a serial mouse or an external modem.

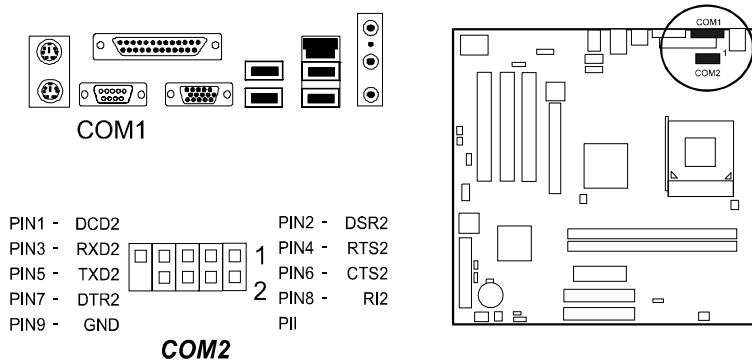

Universal Serial Bus Connectors

These four USB black jacks integrated on the edge of the board are used for linking with USB 2.0 peripheral devices. This board also provides one USB pinheader (two extra USB 2.0 ports) for either linking with some system cases. Please note that your operating system must support USB features.

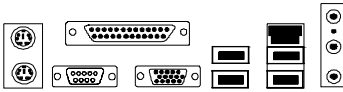

4 USBs

The figure below is the pin assignment of the USB4/5 pinheader.

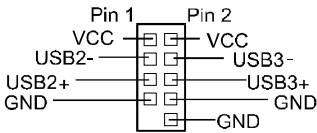

(Intel Spec.)

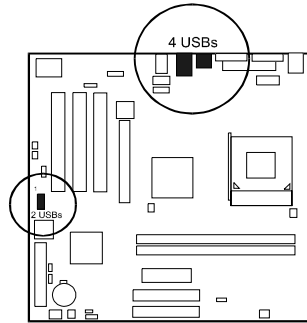

NOTE: The CD in the board package supports Windows XP/2000. For a user who installs Windows 98/ME, please go to VIA site to download the latest USB 2.0 driver.)

Printer Connector

This 25-pin D-Sub female burgundy-colored connector is attached to your printer.

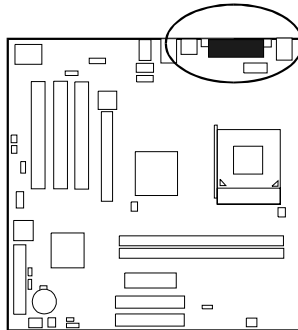
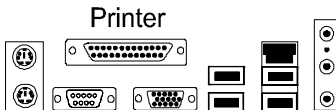

Audio I/O Jacks

LINE_IN (light blue) allows tape players or other audio sources to be recorded by your computer or played through the LINE_OUT. LINE_OUT (lime) can be connected to headphones or preferably powered speakers. MIC_IN (pink) allows microphones to be connected for audio input.

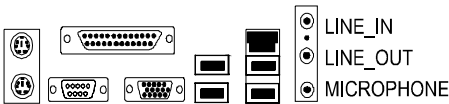

The front audio pin definitions are shown below:

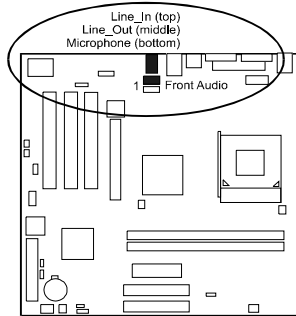
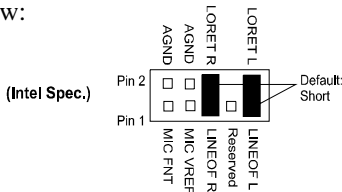

NOTE: When the front headphone is plugged in, the rear audio output will be disabled. If you do not use the front audio pinheader, please keep the pinpair 5-6, 9-10 short as default.



NOTE: If your mainboard has 5.1-channel audio option, the LINE_IN, LINE_OUT, MICROPHONE jacks will be the 5.1-channel audio output.

Video Graphics Accelerator Connector

This 15-pin female D-sub blue connector is connected to your display monitor.

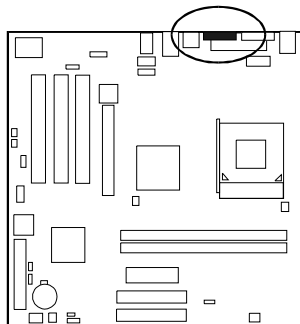
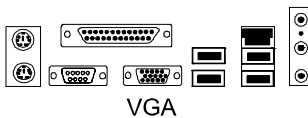

LAN Connector (optional)

The optional RJ45 LAN jack is used for the LAN cable plug.

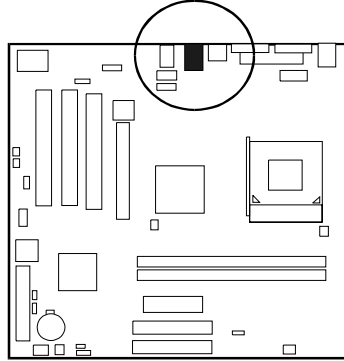
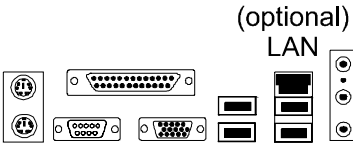

BIOS Setup

The mainboard comes with the chip that Award BIOS that contains the ROM Setup information of your system. (This chip serves as an interface between the processor and the rest of the mainboard components.) This section explains the information contained in the Setup program and tells you how to modify the settings according to your system configuration.

CMOS Setup Utility

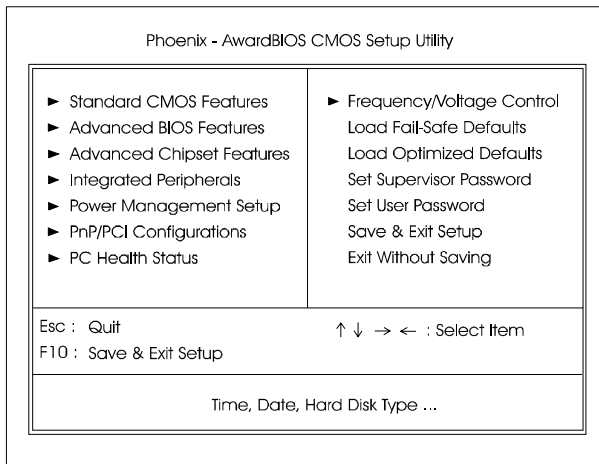

The Setup utility program allows updates to the mainboard configuration settings. The BIOS setup values will be saved in the CMOS. It is executed when the user changes system configuration; user changes system backup battery; or the system detects a configuration error and asks the user to run the Setup program. Use the arrow keys to select and press **Enter** to run the selected program.

Standard CMOS Setup

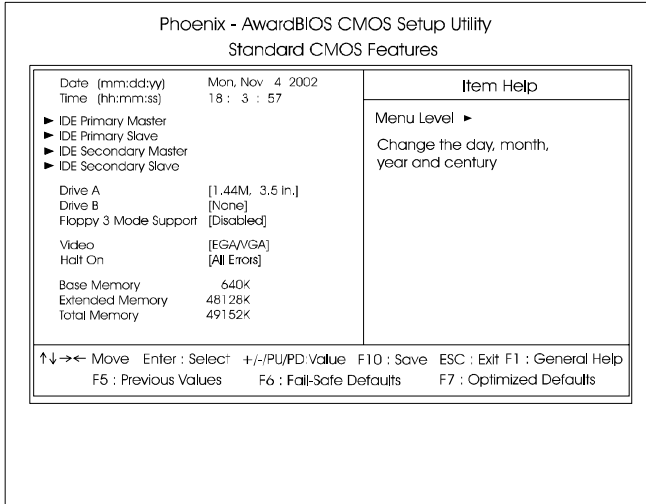

The Standard CMOS Setup screen is displayed above. Each item may have one or more option settings. The system BIOS automatically detects memory size, thus no changes are necessary. Use the arrow keys to highlight the item and then use **PgUp** or **PgDn** keys to select the value you want in each item.

Date

To set the date, highlight the *Date* field and then press **Page Up/Page Down** or +/- keys to set the current date. Follow the month, day and year format.

Time

To set the time, highlight the *Time* field and then press **Page Up/Page Down** or +/- keys to set the current time. Follow the hour, minute, and second format.

Hard Disks

This field records the specifications for all non-SCSI hard drives installed in the system. The onboard PCI IDE connectors provide Primary and Secondary channels for connecting up to four IDE hard disks or other IDE devices. Each channel can support up to two hard disks, the first of which is the *Master* and the second is the *Slave*.

Hard Disk Configurations

Capacity:	The hard disk size. The unit is Bytes.
Cylinder:	The cylinder number of the hard disk.
Head:	The read/write head number of hard disk.
Precomp:	The cylinder number at which the disk drive changes the write current.
Landing Zone:	The cylinder number that the disk drive heads (read/write) are seated when the disk drive is parked.
Sector:	The sector number of each track defined on the hard disk.

Drive A / Drive B

This field records the types of floppy drives installed in the system. To enter the configuration value for a particular drive, highlight its corresponding field and then select the drive type using the **left-** or **right-arrow** key.

Floppy 3 Mode Support

This is a Japanese standard floppy type drive. The standard stores 1.2MB in a 3.5 inch diskette.

Video

Set this field to the type of video display card installed in the system.

Halt On

This field determines which types of errors will cause the system to halt.

Advanced BIOS Features

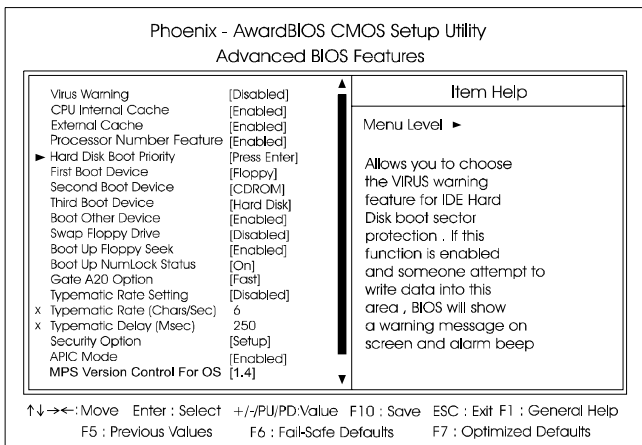

Virus Warning

This feature will prompt uses a warning message, when any write boot sector commend executed. The options are: Enabled, Disabled.

CPU Internal Cache

When enabled, improves the system performance. Disable this item when testing or trouble-shooting. The options are: Enabled, Disabled.

External Cache

When enabled, supports CPU L2 cache. This feature allows you to disable the cache function when the system performance is unstable to run some software. The options are: Enabled, Disabled.

Processor Number Feature

If a Pentium III processor is installed on this mainboard, the system BIOS will allow other utilities to access the Intel Pentium III serial number while this feature set at Enabled. The options are: Enabled, Disabled.

Hard Disk Boot Priority

This feature will auto detect all hard disks of bootable device on the system. It also allows users to select hard disk device booting priority.

First/Second/Third Boot Device

This feature allows user to select the boot device priority. The options are: Floppy, LS120, Hard Disk, CDROM, ZIP100, USB-FDD, USB-ZIP, USB-CDROM, USB-HDD, LAN, Disabled.

Boot Other Device

This feature allows user to select the boot device priority. The options are: Enabled, Disabled.

Swap Floppy Drive

Allows you to switch the order in which the operating system accesses the floppy drives. The options are: Enabled, Disabled.

Boot Up Floppy Seek

When enabled, assigns the BIOS to perform floppy diskette drive tests by issuing the time-consuming seek commands. The options are: Enabled, Disabled.

Boot Up Numlock Status

When set to On, allows the BIOS to automatically enable the Num Lock Function when the system boots up. The options are: On, Off.

Gate A20 Option

When set at Fast, allows a faster access response of address Line No. 20. The options are: Fast, Normal.

Typematic Rate Setting

The term typematic means that when a keyboard key is held down, the character is repeatedly entered until the key is released. The options are: Disabled, Enabled.

Typematic Rate (Chars/Sec)

This feature is available only if the above item, Typematic Rate Setting, is set at Enabled. Sets the rate of a character repeat when the key is held down. The options are: 6, 8, 10, 12, 15, 20, 24, 30.

Typematic Delay (Msec)

This feature is available only if the item, Typematic Rate Setting, is set at Enabled. Sets the delay time before a character is repeated. The options are: 250, 500, 750, 1000 millisecond.

Security Option

Allows to set the security level of the system. The options: Setup, System.

APIC Mode

Allows you to decide if the system enters the APIC (Advanced Programmable Interrupt Controller) mode or not for more IRQs can be released. The options are: Enabled, Disabled.

MPS Version Control For OS

When two CPUs onboard (not this board) this feature allows you to select MPS (Multi-Processor Spec.) version control for OS when logo test executes. The options are: 1.1, 1.4.

OS Select For DRAM > 64MB

If your operating system (OS) is OS/2, select the option OS2. Otherwise, stay with the default setting Non-OS2. The options are: Non-OS2, OS2.

HDD S.M.A.R.T. Capability

S.M.A.R.T. stands for Self-Monitoring and Analysis Reporting Technology which allows your hard disk drive to report any read/write errors and issues a warning with LDCM installed. The options: Disabled, Enabled.

Report No FDD For WIN 95

When the field under the Standard CMOS Setup Menu for Drive A and/or Drive B is set at None, users must set this field is set at Yes for it to function properly. Otherwise, set at No, even if field for Drive A and/or Drive B is set at None, system will still detect and recognize of a floppy drive(s). The options are: Yes, No.

Video BIOS Shadow

Enabling this feature will copy the video BIOS to shadow RAM, it will improve the system performance. The options are: Enabled, Disabled.

BIOS Guardian

It allows the system to prevent computer viruses. Users will need to disable it to update BIOS. The options are: Enabled, Disabled.



NOTE: Please disable this BIOS feature about BIOS Guardian before you start to reflash BIOS.

BIOS Guardian and Reflash BIOS

BIOS Guardian by default is enabled, thus effectively acts as a fire-wall against viruses that can attack the BIOS while the system is running. It must be disabled before reflash BIOS.

The steps below show you how to off and on BIOS Guardian when reflash BIOS:

1. Press **Del** key while booting. Go to *CMOS Setup Utility* menu.
2. Go to *Advanced BIOS Features* submenu.
3. Set the feature *BIOS Guardian* at Disabled.
4. Save the setting and exit. The system restarts.
5. POST screen holds. A message about BIOS Guardian shows.
6. Press Space bar.
7. Reflash BIOS. Restart the system after complete it.
8. POST screen holds. A message about BIOS Guardian shows.
9. Press **G** key. The feature BIOS Guardian will be enabled again.

Advanced Chipset Features

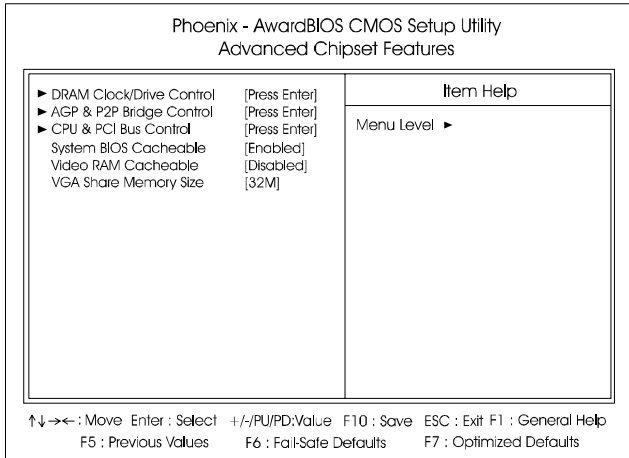

DRAM Clock/Drive Control

Current FSB Frequency, Current DRAM Frequency

This item allows you to get current FSB and DRAM frequencies.

DRAM Clock

The feature allows users to select the DRAM clock.

The options are: 100 MHz, 133 MHz, By SPD.

DRAM Timing

This feature allows user to select the way to set DRAM timing.

The options are: By SPD, Manual.

DRAM CAS Latency

If the CAS latency of your installed memory module is 2 Cycle, The selection 2 will enhance system performance. The options are: 3, 2.

Bank Interleave

This item allows users to select the bank interleave function of DRAM, when the feature DRAM Timing By SPD set at Disabled.

The options are: Disabled, 2 Bank, 4 Bank.

Precharge to Active (Trp)

This item allows users to set the clock time from Precharge to Active command. The options are: 2T, 3T

Active to Precharge (Tras)

This item allows users to set the clock time from Active to Precharge command. The options are: 5T, 6T

Active to CMD (Trcd)

This item allows users to set the clock time from Active to Read/Write Delay command. The options are: 2T, 3T

DRAM Burst Length

This item allows users to set DRAM burst length.
The options are: 4, 8.

DRAM Queue Depth

This item allows users to set DRAM queue depth.
The options are: 2 level, 4 level, 3 level.

DRAM Command Rate

This item allows users to set Address Time After command.
The options are: 2T Command, 1T Command.

AGP & P2P Bridge Control

AGP Aperture Size

It allows you to select the main memory frame size for AGP use.
The options are: 256M, 128M, 64M, 32M, 16M, 8M, 4M.

AGP Mode

This feature allows users to select the AGP mode when an AGP add-on card installed. The options are: 4X, 2X, 1X.

AGP Driving Control / AGP Driving Value

These two features allow user to improve the performance of AGP card manually by pressing Page Down/Page UP key if necessary.
The options of AGP Driving Control are: Auto, Manual.

AGP Fast Write

This feature allows you to set AGP fast write mode.
The options are: Disabled, Enabled.

AGP Master 1 WS Write

When enabled, the AGP bus master write access to DRAMs will add one wait-state cycle. The options are: Enabled, Disabled.

AGP Master 1 WS Read

When enabled, the AGP bus master read access to the DRAMs will add one wait-state cycle. The options are: Disabled, Enabled.

CPU & PCI Bus Control

PCI1/2 Master 0 WS Write

When enabled, allows a zero-wait-state-cycle delay when the PCI1/2 master drive writes data to DRAM. The options are: Enabled, Disabled.

PCI1/2 Post Write

When enabled, allows the CPU to PCI1/2 master drive excutes post write.
The options are: Enabled, Disabled.

PCI Delay Transaction

Enable this feature to abort the current PCI master cycle and to accept the new PCI master request, it reaccepts the original PCI master and returns the PCI data phase to the original PCI master. The options are: Disabled, Enabled.

System BIOS Cacheable

When enabled, allows the ROM area F000H-FFFFH to be cacheable when cache controller is activated. The options are: Enabled, Disabled.

Video RAM Cacheable

When enabled, allows the video RAM area to be cacheable.
The options are: Enabled, Disabled.

VGA Share Memory Size

It allows user to select the frame buffer size of VGA share memory.
The options are: Disabled, 8M, 16M, 32M.

Integrated Peripherals

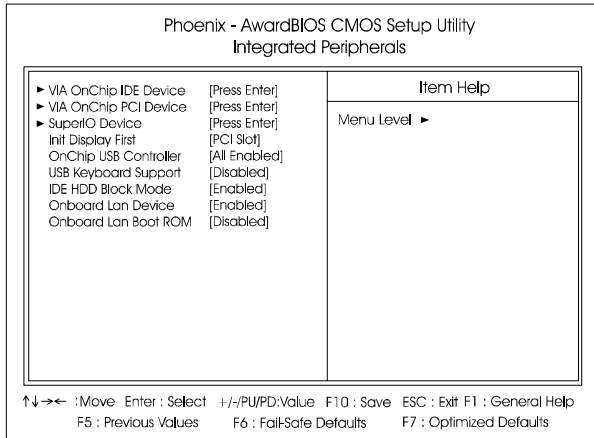

VIA OnChip IDE Device

OnChip IDE Channel0

When enabled, allows you to use the onboard primary PCI IDE. If a hard disk controller card is used, set at Disabled.

The options are: Enabled, Disabled.

OnChip IDE Channel1

When enabled, allows you to use the onboard secondary PCI IDE. If a hard disk controller card is used, set at Disabled.

The options are: Enabled, Disabled.

IDE Prefetch Mode

When set at Enabled, it allows data to be posted to and prefetched from the primary IDE data ports. Data prefetching is initiated when a data port read occurs. The read prefetch eliminates latency to the IDE data ports and allows them to be performed back to back for the highest possible PIO data transfer rates. The first data port read of a sector is called the demand read. Subsequent data port reads from the sector are called prefetch reads. The demand read and all prefetch reads must be of the same size (16 or 32 bits).

The options are: Enabled, Disabled.

Primary Master PIO

Allows an automatic or a manual configuration of the PCI primary IDE hard disk (master) mode. The options are: Auto, Mode 0, Mode 1, Mode 2, Mode 3, Mode 4.

Primary Slave PIO

Allows an automatic or a manual configuration of the PCI primary IDE hard disk (slave) mode. The options are: Auto, Mode 0, Mode 1, Mode 2, Mode 3, Mode 4.

Secondary Master PIO

Allows an automatic or a manual configuration of the PCI secondary IDE hard disk (master) mode. The options are: Auto, Mode 0, Mode 1, Mode 2, Mode 3, Mode 4.

Secondary Slave PIO

Allows an automatic or a manual configuration of the PCI secondary IDE hard disk (slave) mode. The options are: Auto, Mode 0, Mode 1, Mode 2, Mode 3, Mode 4.

Primary Master UDMA

Allows you to select the first PCI IDE channel of the first master hard disk mode or to detect it by the BIOS if the hard disk supports UDMA (Ultra DMA, faster than DMA). The options are: Auto, Disabled.

Primary Slave UDMA

Allows you to select the first PCI IDE channel of the first slave hard disk mode or to detect it by the BIOS if the hard disk supports UDMA (Ultra DMA, faster than DMA). The options are: Auto, Disabled.

Secondary Master/Slave UDMA

Allows you to select the second PCI IDE channel of the secondary master/slave hard disk mode or to detect it by the BIOS if the hard disk supports UDMA (Ultra DMA, faster than DMA). The options are: Auto, Disabled.

VIA OnChip PCI Device

VIA-3058 AC97 Audio

It allows users to disable AC97 link in South Bridge.
The options are: Auto, Disabled.

SuperIO PCI Device

Onboard FDC Controller

When enabled, the floppy diskette drive (FDD) controller is activated.
The options are: Enabled, Disabled.

Onboard Serial Port 1

If the serial port 1 uses the onboard I/O controller, you can modify your serial port parameters. If an I/O card needs to be installed, COM3 and COM4 may be needed. The options are: Disabled, 3F8/IRQ4, 2F8/IRQ3, 3E8/IRQ4, 2E8/IRQ3.

Onboard Serial Port 2

If the serial port 2 uses the onboard I/O controller, you can modify your serial port parameters. If an I/O card needs to be installed, COM3 and COM4 may be needed. The options are: Disabled, 3F8/IRQ4, 2E8/IRQ3, 3E8/IRQ4, 2F8/IRQ3.

UART Mode Select

This field allows the users to configure what IR mode the 2nd serial port should use. The default is Normal.
The options are: Normal, IrDA, ASKIR, SCR.

UR2 Duplex Mode

Allows you to select the IR modes.
The options are: Half, Full.

Onboard Parallel Port

Allows you to select from a given set of parameters if the parallel port uses the onboard I/O controller.
The options are: Disabled, 378/IRQ7, 278/IRQ5, 3BC/IRQ7.

Parallel Port Mode

Allows you to connect with an advanced printer via the port mode it supports. The options are: SPP, EPP, ECP, ECP+EPP.

ECP Mode Use DMA

This feature allows you to select Direct Memory Access (DMA) channel if the ECP mode selected. The options are: 1, 3.

Init Display First

When you install a PCI VGA card on the board, this feature allows you to select the first initiation of the monitor display from PCI or onboard AGP. The options are: PCI Slot, AGP.

OnChip USB Controller

Disable this option if you are not using the onboard USB feature. The options are: All Disabled, All Enabled.

USB Keyboard Support

When a USB keyboard is installed, please set at Enabled. The options are: Disabled, Enabled.

IDE HDD Block Mode

When enabled, the system executes read/write requests to hard disk in block mode. The options are: Enabled, Disabled.

Onboard Lan Device

This feature allows users to enable or disable the onboard Lan device. The options are: Enabled, Disabled.

Onboard Lan Boot ROM

This feature allows users to enable or disable the onboard Lan boot ROM to boot system. The options are: Enabled, Disabled.

Power Management Setup

Phoenix - AwardBIOS CMOS Setup Utility		Item Help
ACPI function	[Enabled]	
ACPI Suspend Type	[S3(STR)]	
Power Management Option	[User Define]	Menu Level ▶
HDD Power Down	[Disable]	
Suspend Mode	[Disable]	
Video Off Option	[Suspend -> Off]	
Video Off Method	[DPMS Support]	
MODEM Use IRQ	[3]	
Soft-Off by PWRBTN	[Instant-Off]	
State After Power Failure	[Auto]	
▶ IRQ/Event Activity Detect	[Press Enter]	

↑↓→←: Move Enter : Select +/-/PU/PD: Value F10 : Save ESC : Exit F1 : General Help
 F5 : Previous Values F6 : Fail-Safe Defaults F7 : Optimized Defaults

ACPI function

This item allows you to disable the ACPI function.
The options are: Enabled, Disabled.

ACPI Suspend Type

This item allows you to select ACPI suspend types.
The options are: S1(POS), S3 (STR), S1&S3.

Power Management

This item allows you to adjust the power management features.
Select User Define for configuring your own power management features. Min Saving initiates all predefined timers in their minimum values. Max Saving, on the other hand, initiates maximum values. The options are: User Define, Min Saving, Max Saving.

HDD Power Down

The option lets the BIOS turn the HDD motor off when system is in Suspend mode. Selecting 1 Min..15 Min allows you define the HDD idle time before the HDD enters the Power Saving Mode.
The options 1 Min..15 Min will not work concurrently. When HDD is in the Power Saving Mode, any access to the HDD will wake the HDD up.
The options are: Disable, 1 Min..15 Min.

Suspend Mode

When disabled, the system will not enter Suspend mode. The specified time option defines the idle time the system takes before it enters Suspend mode. The options are: Disable, 1, 2, 4, 6, 8, 10, 20, 30, 40 Min, 1 Hour.

Video Off Option

This feature provides the selections of the video display power saving mode. The option *Suspend -> Off* allows the video display to go blank if the system enters Suspend mode. The option *Always On* allows the video display to stay in Standby mode even when the system enters Doze or Suspend mode. The options are: Always On, Suspend -> Off.

Video Off Method

The option *Blank Screen* allows the BIOS to blank off screen display by turning off the red-green-blue signals. *V/H SYNC+Blank* allows the BIOS to blank off screen display by turning off the V-Sync and H-Sync signals sent from add-on VGA card. *DPMS Support* allows the BIOS to blank off screen display by your add-on VGA card which supports DPMS (Display Power Management Signaling function).

The options are: Blank Screen, V/H SYNC+Blank, DPMS Support.

MODEM Use IRQ

This feature allows you to select the IRQ# to meet your modem IRQ#.

The options are: NA, 3, 4, 5, 7, 9, 10, 11.

Soft-Off by PWR-BTTN

The selection *Delay 4 Sec.* will allow the system shut down after 4 seconds after the power button is pressed. The selection *Instant-Off* will allow the system shut down immediately once the power button is pressed.

The settings are: Delay 4 Sec, Instant-Off.

State After Power Failure

The item allows you to select the state that your personal computer returns to after a power failure. If set at Auto, the system will automatically go back to the state that before its power failure. If set at On, the system will restart after power failure. If set at Off, the system will not boot after a power failure. The settings are: Auto, On, Off.

IRQ/Event Activity Detect

USB Resume From S3

When set at Enabled, it allows USB devices that linked with the system to activate the system from ACPI S3 power saving mode.

The options are Disabled, Enabled.

VGA

When set at On, any VGA activity will awake the system.

The options are: OFF, ON.

LPT & COM

When *LPT/COM* is selected, any access of LPT and COM ports will awake the system. Likewise, either *LPT* or *COM* is chosen, the system will be awoken by any activity of LPT or COM port.

The options are: LPT/COM, LPT, COM, NONE.

HDD & FDD

When it is set at ON, any access happened at hard drives and floppy drives will awake the system. The options are: OFF, ON.

PCI Master

To set this feature at ON activates that Power Management feature (PM) wake-up event for the PCI bus master card.

The options are: OFF, ON.

PowerOn by PCI Card

When set at Enabled, any PCI-PM event awakes the system from a PCI-PM controlled state.

The options are Disabled, Enabled.

Modem Ring Resume

An input signal on the serial Ring Indicator (RI) line (in other words, an incoming call on the modem) awakens the system from a soft off state.

The options are: Enabled, Disabled.

RTC Alarm Resume

Enabled allows you to set the time the system will be turned on from the system power-off status. The options are: Enabled, Disabled.

Date (of Month)

This feature allows you to set the day of the alarm starts when the RTC Alarm Resume From Soft Off is set to be Enabled. The options are: 0, 1..31.

Resume Time (hh:mm:ss)

If an ATX power supply is installed and when RTC Alarm Resume is Enabled, this feature allows you to set the time of the alarm starts when the RTC Alarm Resume From Soft Off is set to be Enabled.

The options are: hh (*hour*) - 0, 1, 2,..., 23; mm (*minute*) - 0, 1, 2,...,59; ss (*second*) - 0, 1, 2,...,59.

Primary INTR

If set at ON, the Primary interrupt (the Primary option in the feature of IRQ# Acitivity) will make the power management wake up the system.

The options are: ON, OFF.

IRQs Activity Monitoring

After the time period which you set, the system advances from doze mode to suspend mode in which the CPU clock stops and the screen display is off. At this moment, if the IRQ activity occurs, the system goes back to full-on mode directly.

If the IRQ activity which is defined as Non Primary takes place, the system remains off until the corresponding IRQ handler finishes.

The options of IRQ 3, 4, 5, 6, 7, 8, 9, 10, 11, 12, 13, 14, 15 are: Enabled, Disabled.

PnP/PCI Configurations

Phoenix - AwardBIOS CMOS Setup Utility		
PnP/PCI Configurations		
PNP OS Installed	[No]	Item Help
Reset Configuration Data	[Disabled]	
Resources Controlled By x IRQ Resources	[Auto][ESCD] Press Enter	Menu Level ► Select Yes if you are using a Plug and Play capable operating system Select No if you need the BIOS to configure non-boot devices
PCI/VGA Palette Snoop	[Disabled]	
Assign IRQ For VGA	[Enabled]	
Assign IRQ For USB	[Enabled]	
INT Pin 1 Assignment	[Auto]	
INT Pin 2 Assignment	[Auto]	
INT Pin 3 Assignment	[Auto]	
INT Pin 4 Assignment	[Auto]	

↑↓ → ← : Move Enter : Select +/-/PU/PD: Value F10 : Save ESC : Exit F1 : General Help
 F5 : Previous Values F6 : Fail-Safe Defaults F7 : Optimized Defaults

PNP OS Installed

If your operating system is a Plug-and-Play one, such as Windows NT, Windows 95, select Yes. The options are: No, Yes.

Reset Configuration Data

Enabling it to reset the system Extended System Configuration Data (ESCD) when you exit Setup if you have installed a new add-on card and the system reconfiguration has caused such a serious conflict that the operating system can not boot. The options are: Disabled, Enabled.

Resources Controlled By

If set at Auto, the BIOS arranges all system resources. If there exists conflict, select Manual. The options are: Auto (ESCD), Manual.

The manual options of **IRQ- /DMA-** assigned to are: PCI/ISA PnP, Legacy ISA.

PCI/VGA Palette Snoop

Set this feature to be enabled if any ISA adapter card installed in the system requires the VGA palette snoop function.

The options are: Disabled, Enabled.

Assign IRQ For VGA

If your PCI VGA card devices do not need an IRQ, select Disabled; therefore, an IRQ can be released for the system use.

The options are: Enabled, Disabled.

Assign IRQ For USB

If your USB devices do not need an IRQ, select Disabled; therefore, an IRQ can be released for the system use.

The options are: Enabled, Disabled.

INT Pin 1/2/3/4 Assignment

This feature allows you to assign the PCI IRQ numbers for PCI slots. Selecting the default, Auto, allows the PCI controller to automatically allocate the IRQ numbers.

The options are: Auto, 3, 4, 5, 7, 9, 10, 11, 12, 14, 15.

PC Health Status

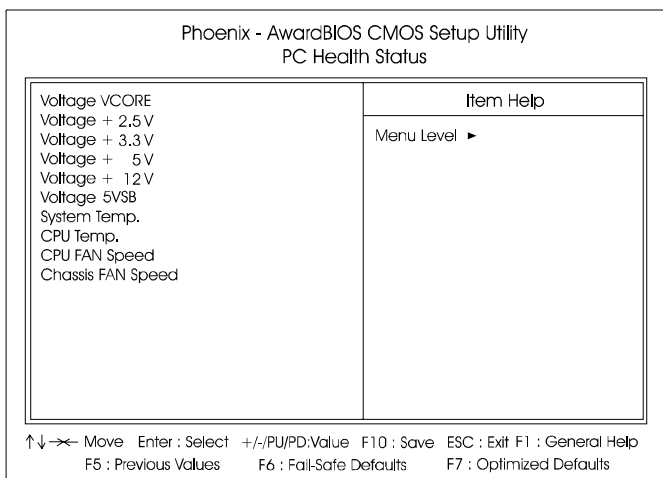

Voltage VCORE / Voltage + 2.5 V / Voltage +3.3 V / Voltage +5 V / Voltage +12 V / Voltage 5VSB / Voltage 5VSB / SYSTEM Temp. / CPU Temp. / CPU FAN Speed / Chassis FAN Speed

These items allow end users and technicians to monitor data provided by the BIOS on this mainboard. It is not user-configurable.

Frequency/Voltage Control

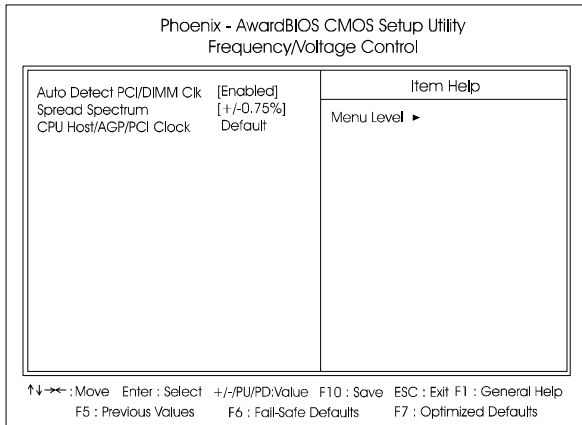

Auto Detect DIMM/PCI Clk

When enabled, BIOS will detect the PCI slot and DIMM slot. If no any device in, BIOS will auto disable its clock.

The options are: Enabled, Disabled.

Spread Spectrum

This feature is used to select the spread Spectrum range or disable it.

The options are: Disabled and all allowed ranges in percentage.

Load Fail-Safe Defaults

This submenu is selected to diagnose the problem after the computer boots, if the computer will not boot. These settings do not give optimal performance.

Load Optimized Defaults

This submenu is selected for default settings which provide the best system performance.

Supervisor/User Password

To enable the Supervisor/User passwords, select the item from the Standard CMOS Setup. You will be prompted to create your own password. Type your password up to eight characters and press Enter. You will be asked to confirm the password. Type the password again and press Enter. To disable password, press Enter twice when you are prompted to enter a password. A message appears, confirming the password is disabled.

Under the BIOS Feature Setup, if *Setup* is selected under the Security Option field and the Supervisor/User Password is enabled, you will be prompted password every time you try to enter the CMOS Setup Utility. If *System* is selected and the Supervisor/User Password is enabled, you will be requested to enter the Password every time when you reboot the system or enter the CMOS Setup utility.

Save and Exit Setup

After you have made changes under Setup, press Esc to return to the main menu. Move cursor to Save and Exit Setup or press F10 and then press Y to change the CMOS Setup. If you did not change anything, press Esc again or move cursor to Exit Without Saving and press Y to retain the Setup settings. The following message will appear at the center of the screen to allow you to save data to CMOS and exit the setup utility: **SAVE to CMOS and EXIT (Y/N)?**

Exit without Saving

If you select this feature, the following message will appear at the center of the screen to allow you to exit the setup utility without saving CMOS modifications: **Quit Without Saving (Y/N)?**