

# **6BX/ZX/VIA86/VIA86P**

## **User's Manual Version 1.4**

The information presented in this publication has been made carefully for reliability; however, no responsibility is assumed for inaccuracies. Specifications are subject to change without notice.

IBM, PC/AT, and PC/XT are trademarks of International Business Machines Corporation.

Pentium is a trademark of Intel Corporation

AWARD is a registered trademark of Award Software Inc.

MS-MOS and WINDOWS NT are registered trademarks of Microsoft Corporation.

**Trademarks and/or registered trademarks are the properties of their respective owners.**

---

## Table of Contents

|                  |  |           |
|------------------|--|-----------|
| <b>Chapter 1</b> | <b>Introduction .....</b>                  | <b>1</b>  |
|                  | <b>How this manual is organized .....</b>  | <b>1</b>  |
|                  | <b>Package checklist .....</b>             | <b>2</b>  |
| <b>Chapter 2</b> | <b>Features .....</b>                      | <b>3</b>  |
|                  | <b>Features of the mainboard .....</b>     | <b>3</b>  |
|                  | <b>The mainboard layout .....</b>          | <b>6</b>  |
| <b>Chapter 3</b> | <b>Installation .....</b>                  | <b>7</b>  |
|                  | <b>System Installation Setups .....</b>    | <b>9</b>  |
|                  | <b>Static Electricity Precaution .....</b> | <b>9</b>  |
|                  | <b>Jumper Settings .....</b>               | <b>10</b> |
|                  | <b>System Memory (DIMM moduleS) .....</b>  | <b>14</b> |
|                  | <b>DIMM Memory Installation .....</b>      | <b>15</b> |
|                  | <b>Wake Up On LAN .....</b>                | <b>16</b> |
|                  | <b>Central Processing Unit (CPU) .....</b> | <b>17</b> |
|                  | <b>Removing the Processor .....</b>        | <b>20</b> |
|                  | <b>Installing OEM Processor .....</b>      | <b>21</b> |
|                  | <b>Clearance Requirements .....</b>        | <b>23</b> |
|                  | <b>Fan Exhaust .....</b>                   | <b>23</b> |
|                  | <b>External Connectors .....</b>           | <b>24</b> |

## Chapter 1

# 1

# Introduction

## How This Manual is Organized

---

This manual is divided into the following sections:

- Chapter 1 Introduction** : Manual information and checklist.
- Chapter 2 Features** : Information and Specifications concerning this mainboard.
- Chapter 3 Installation** : Instructions on setting up the board.

## Package Checklist

---

Please check that your package is complete . If you discover any item damaged or missing , please contact with your retailer immediately.

- ⌚ The 6BX86 / 6ZX86 / 6VIA86 / 6VIA86P mainboard.
- ⌚ Retention Mechanism & Heatsink Support.
- ⌚ 1 x IDE ribbon cable.
- ⌚ 1 x UDMA66 IDE ribbon cable. ( option )
- ⌚ 1 x floppy ribbon cable.
- ⌚ 6BX86 / 6ZX86 / 6VIA86 / 6VIA86P support software:
  - Flash Memory Write utility to update the FLASH BIOS.
  - Desktop Management Interface (DMI) utility.
  - MD9241 Hardware monitor AP. ( option )
- ⌚ This user's Manual

## Chapter 2

# 2

# Features

## Features of the 6BX86 / 6ZX86 / 6VIA86 / 6VIA86P M/B

---

The 6BX86 / 6ZX86 / 6VIA86 / 6VIA86P is designed for the PC user's who want many new key features processed by the fastest CPU in a economic package. This mainboard :

- ⌘ **New general CPU support :**
  - Solt1 support to 866 MHz processor.
  - Socket 370 Celeron ( 533MHz ,677MHz(1.5V) )processor.
  - Socket 370 Coppermine (500MHz~800MHz)processor.
- ⌘ **Intel Chipset :**
  - Intel 440 BX PCIsset™ /Intel 440 BX PCIsset™ /VIA APOLLO PRO/PRO133 chips with I/O subsystems.



### **Biggest memory capacity :**

**6BX86/6VIA86/6VIA86P** is equipped with three DIMM socket to support (16MB, 32MB, 64MB, 128MB,256MB) 168 pin 3.3v EDO RAM Module Maximum memory up to 768MB or 3.3v SDRAM. Maximum memory up to 768MB.

**6ZX86** is equipped with two DIMM socket to support 168 pin 3.3v SDRAM SPD(Special Presence Detect).Maximum memory up to 512MB.



### **AGP for fast VGA solution :**

AGP (Accelerator Graphic Port) will enhance & improve display performance and Application. The bus speed is 66 MHz 2x Mode.



### **ISA & PCI Expansion Slot :**

Provide two 16 bit ISA, and three 32 bit PCI slots.



### **PCI Bus Master IDE Controller :**

Comes with an on-board PCI Bus Master IDE controller with two connectors that supports four IDE devices in two channels, enable to transfer data at much faster rate, and supports Enhanced IDE devices such as Tape Backup and CD-ROM devices (ATAPI). This controller supports PIO modes 3 and 4 (16.6MB/sec. ), and Ultra DMA 33/66 (**only 6VIA86P**) (33MB/66MB Sec. ) , also supports ZIP100 and LS-120. BIOS supports IDE CD-ROM or SCSI bootup.



### **Super Multi-I/O :**

Provides two high-speed UART2 serial compatible ports (match NS16C550A compatible) and one parallel port with SPP,EPP and ECP capabilities. UART2 can also be directed from COM2 to the Infrared Module for wireless connections. Two floppy drives of either 5.25" or 3.5" (1.25MB,1.44MB or 2.88MB) are also supported without an external card.

- ∞ **CPU built-in Level 2 Cache :**  
0K/128K/256K/512KB Pipeline Burst Level 2 cache in the Pentium II/III Single Edge Contact (SEC) cartridge.
- ∞ **Desktop Management Interface(DMI):**  
Supports DMI through BIOS which allows hardware to communicate within a standard protocol and create a higher level of capability. (Required DMI- enabled components).
- ∞ **Advanced Configuration of Power management Interface (ACPI) :**  
Support ACPI function BIOS which allows System to control seriously power management.
- ∞ **Thermal detect (MD9241) :(Optional)**  
The system's BIOS will sense CPU's temperature through MD9241 on board. The User can watch what current temperature of CPU is & current CPU FAN status is from Win System. The user will watch the indication on Win 95/98 environment.
- ∞ **IrDa Port :**  
Support this serial fast communication up to 115.2Kbps.
- ∞ **Support Power on by modem/ Alarm on/ LAN Wake Up :**  
Support System power up from Modem ring up or timer or LAN Wake Up of System. Required enabled in Ring on by modem and Alarm on and LAN Wake Up in BIOS.
- ∞ To support CPU FAN ON/OFF and LED indicator under SUSPEND mode.
- ∞ To support CPU temperature and Alarm system by warning with sound.

# The 6BX86 / 6ZX86 / 6VIA86 / 6VIA86P M/B Layout

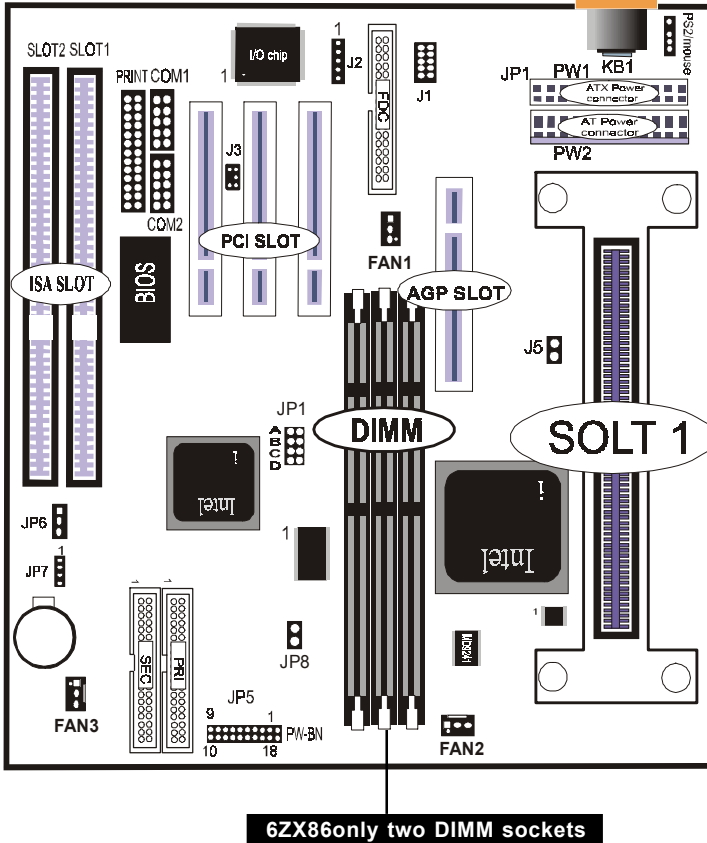



## Chapter 3

# 3

# Installation

## Jumper

| <b>Jumper</b>                       | <b>Refer to page</b> |
|-------------------------------------|----------------------|
| ◆ JP1 - CPU BUS frequency selection | 11                   |
| ◆ FAN1 - FAN CONN. for AGP          | 25                   |
| ◆ FAN2 - FAN CONN. for CPU          | 25                   |
| ◆ FAN3 - FAN CONN. for CHASSIS      | 25                   |
| ◆ JP7 - Real time Clock RTC clean   | 10                   |
| ◆ JP6 - LAN Card Wake Up            | 16                   |

## Expansion Slot

## Which page

- ◆ SEC (Single Edge Connector) CPU SLOT 1 17
- ◆ 168 pin DIMM Socket 15
- ◆ AGP (Accelerator Graphic port) SLOT
- ◆ PCI SLOT 1,2,3 -32bits PCI SLOT
- ◆ ISA SLOT1,2 - 16bits ISA SLOT

## Connectors

## Refer to page

- ◆ PW1/PW2 - ATX/AT Power Connector 30
- ◆ PS2/Mouse - PS/2 Mouse port. 25
- ◆ KB1 - AT Keyboard port 25
- ◆ J1 - USB Port 25
- ◆ COM1 - COM 1 serial port 25
- ◆ PRINT - Parallel port 25
- ◆ COM2 - COM 2 serial port 25
- ◆ FDC - FLOPPY connector 25
- ◆ IDE1 - Primary IDE connector 27
- ◆ IDE2 - Secondary IDE connector 27
- ◆ JP5 - HDD LED 27
- ◆ JP5 - Reset Switch 29
- ◆ JP5 - Speaker Connector 29
- ◆ JP5 - Power LED 28
- ◆ PW-BN - ATX Power switch 30
- ◆ J2 - IrDA connector 29

## System Installation Setup

---

Before using your computer, you must finish the following steps:

1. Set jumpers on mainboard
2. Install SDRAM module.
3. Install the Pentium II/III Processor.
4. Connect Ribbon Cables, Cabinet Wires, and Power supply.
5. Install Add on Cards.
6. Setup the BIOS software.

## Static Electricity Precaution

---





- ⌚ Keep the mainboard and other system components in their anti-static packaging until you are ready to install them.
- ⌚ Do all preparative work on a static-free surface with the main board components facing up.
- ⌚ Unplug your computer when working on the inside.
- ⌚ Wear an Anti-static wrist strap.
- ⌚ Hold the system components, boards or cards by its edges only. Be careful not to touch any of IC chips, circuitry, contacts or connections, especially gold contacts on the mainboard.

# Jumper Settings

---

## Jumpers

Several hardware settings are made through the use of jumper caps to connect jumper pins (Jxx) on the mainboard. See "Map of the mainboard" for locations of jumpers.



The jumper settings will be described numerically such as [----], [1-2], [2-3] for no connection, connect pins 1 & 2, and connect pins 2 & 3 respectively. Pin 1 for our mainboard is always on top one or on the left when holding the mainboard with the keyboard away from yourself. "P1" is written besides pin 1 on jumper with three pins. The jumpers will also be shown graphically such as  to connect pin 1 & 2 and  to connect 2 & 3. Jumpers with two pins will be shown as  for Short (on) and  for Open (off). For manufacturing simplicity it may be sharing pins from other groups. Use the diagrams in this manual instead of following the pin layout on the board. Settings with two jumper numbers require that both jumpers be moved together. To connect the pin, simply place a plastic jumper cap over the two pins as diagrammed.

### Real Time Clock (RTC) RAM - JP7 :

The CMOS RAM is powered by the onboard button cell battery. To clear the RTC data:

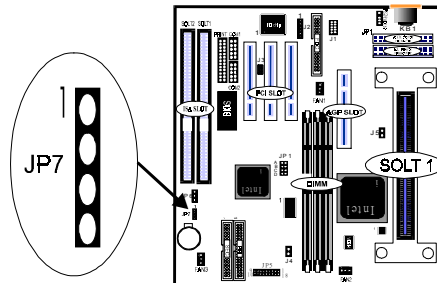
- (1) Turn off your computer,
- (2) Move this jumper to "3-4Pin Clear Data",
- (3) Move the jumper back to "Default",
- (4) Turn on your computer,
- (5) Hold down <Delete > during bootup and enter BIOS setup to re-enter user Preferences.



| Programming           | JP7 CMOS clear  |   |
|-----------------------|-----------------|---|
| Enabled ( clear CMOS) | [3-4]           |  |
| Normal                | [2-3] (Default) |  |
| External Battery      | [1-4]           |  |

**ATX Power Bottom Switch- PW-BN :**

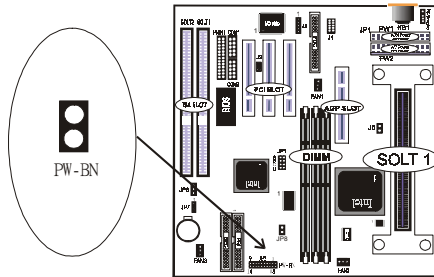

**System Temperature FAN Connector - FAN1 , FAN2 :**

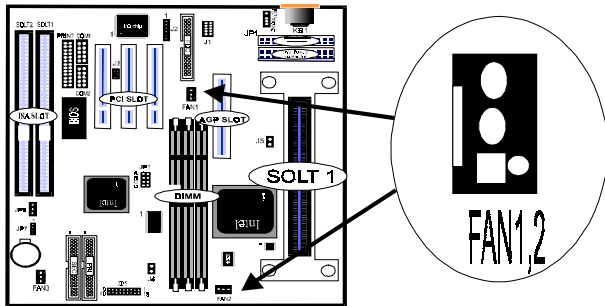

**CPU External (BUS) Frequency Selection (see Table3-1) :**

The CPU External (Bus) Frequency has something wrong with 66/100Mhz. If you want to change External (Bus) Frequency , Please follow these steps :

First enter/choose "BIOS" System. Second, choose "CPU Host clock" which is under the "Chipset Feature Setup ". Third ,you can change the Frequency with the follaring numbers such as 66,75,83,100,112and 133 for replacement,Default is auto Sensor.



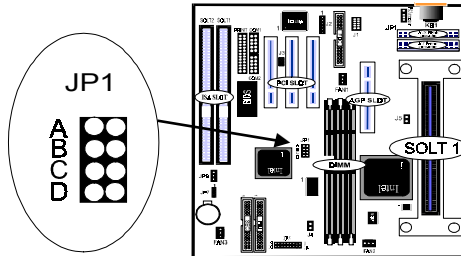

### CPU to BUS Frequency Ratio- JP1 :

These jumpers set the frequency ratio between the Internal frequency of the CPU and the External frequency (Called the BUS Clock) within the CPU. These must be set together with the above jumpers CPU External (BUS) Frequency Selection.



Set the jumpers by the Internal speed of the Intel CPU as follows:

| CPU    | ModelRatio | BUS Freq | JP1 |
|--------|------------|----------|-----|
| 233MHZ | 3.5X       | 66.6MHZ  |     |
| 266MHZ | 4.0X       | 66.6MHZ  |     |
| 300MHZ | 4.5X       | 66.6MHZ  |     |
| 333MHZ | 5.0X       | 66.6MHZ  |     |
| 366MHZ | 5.5X       | 66.6MHZ  |     |
| 400MHZ | 6.0X       | 66.6MHZ  |     |
| CPU    | ModelRatio | BUS Freq | JP1 |
| 350MHZ | 3.5X       | 100 MHZ  |     |
| 400MHZ | 4.0X       | 100 MHZ  |     |
| 450MHZ | 4.5X       | 100 MHZ  |     |
| 500MHZ | 5.0X       | 100 MHZ  |     |
| 550MHZ | 5.5X       | 100 MHZ  |     |
| 600MHZ | 6.0X       | 100 MHZ  |     |

| <b>CPU</b>    | <b>ModelRatio</b> | <b>BUS Freq</b> | <b>JP1</b>   |
|---------------|-------------------|-----------------|--|
| <b>600MHZ</b> | <b>4.5X</b>       | <b>133MHZ</b>   | <br>A B C D |
| <b>666MHZ</b> | <b>5.0X</b>       | <b>133MHZ</b>   | <br>A B C D |
| <b>733MHZ</b> | <b>5.5X</b>       | <b>133MHZ</b>   | <br>A B C D |
| <b>800MHZ</b> | <b>6.0X</b>       | <b>133MHZ</b>   | <br>A B C D |

**Table 3-1**

**NOTE:**

Most of the CPU frequency are locked by the manufacturer. This motherboard is able to auto-detect the CPU frequency.

## System Memory ( DIMM Module)

---

This **6BX86/6VIA86/6VIA86P** mainboard supports, three 168 pins DIMM (Dual Inline Memory Module) (**6ZX86 supports two DIMMs**) of 16 MB, 32 MB, 64 MB, 128 MB ,256MB to form a memory size between 16MB to 256MB.

The DRAM can be either 45ns,50ns,or 60ns 3.3v SDRAM,and 3.3v Enhanced Data Output (EDO) RAM.

Install memory in any or all Banks in Combination:

| Bank         | Memory module                         |
|--------------|---------------------------------------|
| DIMM 1       | 16MB,32MB,64MB,128MB,256MB            |
| ( Bank 0-1 ) | 168 pin,3.3v SDRAM / EDO RAM          |
| DIMM 2       | 16MB,32MB,64MB,128MB,256MB            |
| ( Bank 2-3 ) | 168 pin 3.3v,SDRAM / EDO RAM          |
| DIMM 3       | 16MB,32MB,64MB,128MB,256MB            |
| ( Bank 4-5 ) | 168 pin 3.3v,SDRAM / EDO RAM          |
|              | <b>Total System Memory(Max 768MB)</b> |

### Note :

- ◆ The DIMM Slot does not support any 5v EDO DIMM module.
- ◆ The DIMM Slot does not support any 5v SDRAM DIMM module.
- ◆ Memory speed setup is required through "Auto Configuration" in BIOS chipset Setup of BIOS SOFTWARE. If several speed memorious are used, You must set Auto Configuration to low. Example If both 50ns, 60ns are used, Please set Auto configuration to 60ns.
- ◆ It's allowed any DIMM module put in any DIMM slot. It's allowed there are different capacity DIMM module in all DIMM slot.



# DIMM Memory Installation

Insert the module (s) as shown. Because the number pins are different on either side of the breaks, the module will only fit in the orientation as shown. SDRAM DIMM modules have different pin contacts on each side and therefore have a higher pin density.

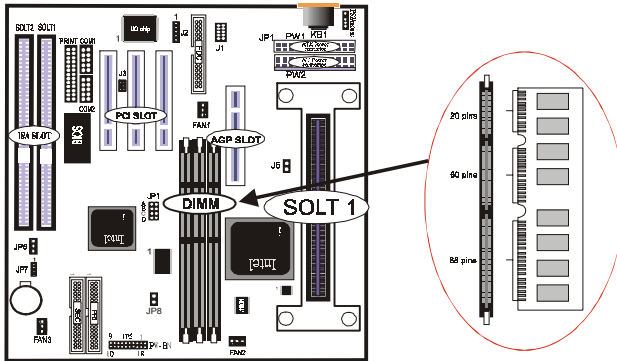

## 168 Pin DIMM Memory Socket

The Dual Inline Memory Module (DIMM) memory module must be 3.3v Extended Data Output (EDO) DRAM or SDRAM. You can identify the type of DIMM module by the illustration below:

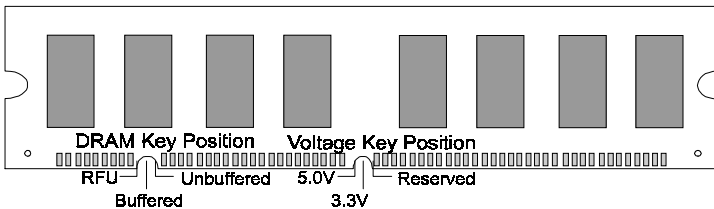

## 168 Pin DRAM DIMM Notch Key Definitions

The notch on the DIMM module will shift between left, center, or right to identify the type and also to prevent the wrong type to be inserted into the DIMM slot on the Mainboard. You must ask your retailer for Specifications before purchasing.

**Four clock signals are supported on this mainboard**

## Wake Up On LAN (3-pin WOL)

This connector connects LAN cards and a Wake On LAN output. When the system is in soft-off mode LAN activity will power on the system.

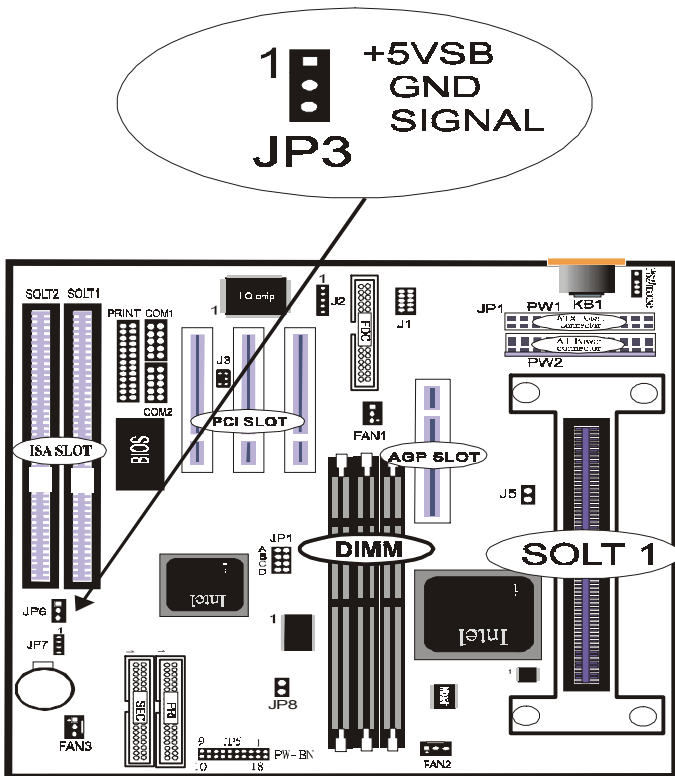

### IMPORTANT:

Requires an ATX power supply with at least 720ma +5 volt standby power.

## Central Processing Unit (CPU)

---

This main board provides a Single Edge Contact (SEC) slot for Pentium II/III processor packaged in an SEC cartridge. The SEC slot is not compatible with other non-Pentium II/III Processors.

### Installing the Retention Mechanism

The Mainboard package includes a Retention Mechanism. The Retention Mechanism is used to hold an Intel Pentium II/III Processor to the Intel Slot 1 connector. Make sure the system board is on a workbench (not in a chassis).

To install the Retention Mechanism, follow the steps below:

1. The Retention Mechanism package includes a Retention Mechanism with captive nut and four captive screws.

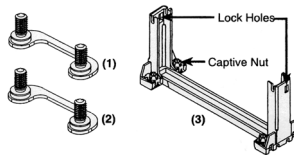

2. Hold the Retention Mechanism upright and position it above the Intel Slot 1 connector.
3. Insert the captive screws attached from underneath the mainboard as shown, and four screws 2 mount bridges directly.

### Note:

- ◆ Don't forget to attach the screw seal before inserting.
- ◆ Nut is built into the base of Retention Mechanism. It's convenient to tighten screw directly.

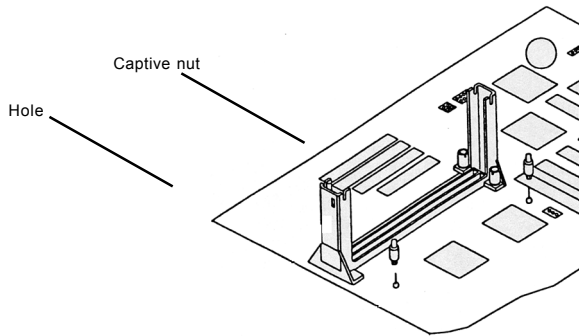

### Installing Boxed Processor

1. Mount the two black plastic pegs onto the system board. /these pegs will be used to attach the fan heatsink supports. Notice that one hole and the base of one peg are larger than the other hole and peg base. Push each peg into its hole firmly until you hear it “ Click” into place.

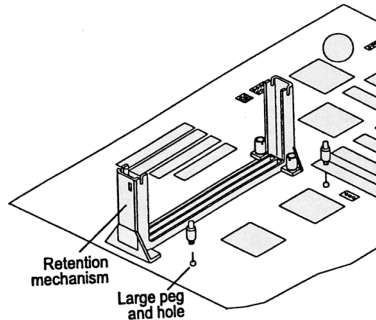

2. Slide a black plastic heatsink support onto each outside edge of the fan heatsink, making sure that the hole and clip are on the outside edge of the support. (If the supports are reversed, the holes will not line up with the pegs on the main board). Slide each heatsink support toward the center of the processor until the support is seat

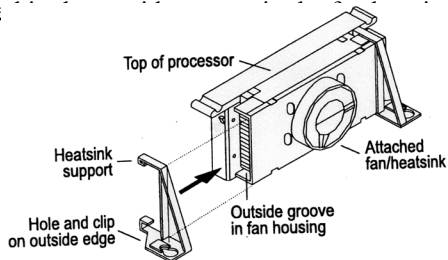

- Slide the clip (A) as shown on each support toward the processor, exposing the hole that will fit over the peg on the mainboard . Push the latches (B) on the processor toward the center of the processor until they click into place.
- Hold the processor so that the fan shroud is facing toward the pegs on the main board. Slid the Processor ( C ) into the Retention Mechanism and slide the supports onto the pegs. Make sure that the pegs on the main board slide into the holes in the heatsink support and that alignment notch I the processor fit over the plug in Slot 1. Push the processor down firmly, with even pressure on both sides of the top, until it is seated

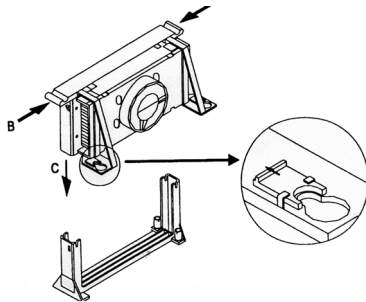

- Slide the clips on the support (A) forward until they click into place to hold the pegs securely. (Apply slight pressure on the peg and push the peg toward the clip while pushing the click forward) Push the latches in the processor ( B ) outward until they click into place in the Retention Mechanism. The latches must be secured for proper electrical of the processor.

- Attach the small end of the power cable to the three-pin connector in the processor, then attach the large end to the three-pin connector on the main board.

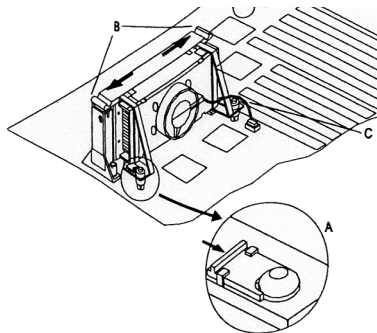

## Removing the Processor

---

To Remove the processor from the system board, follow these steps (the reverse of the installation processor) :

1. Disconnect the fan power cable from the main board. (We recommend that you leave the cable connected to the processor) .
2. Slide the clips on the supports backward to release the pegs in the mainboard . Push the latches on the processor toward the center of the processor until they click into place.
3. Lift one end of the processor until it is free from SLOT 1. Lift the other end of the processor until it is freed from SLOT 1. Lift the entire processor (with the fan heatsink support attached) until it is freed from the Retention Mechanism.
4. Remove the heatsink support pegs from the mainboard and discard them . With one hand, squeeze together the two halves of the peg on the bottom side of the mainboard . With the other hand, pull the peg out of the hole in the mainboard . Do not reuse the pegs.

### **Caution :**

**When handling the processor, avoid pressing directly on the label area of the fan. When removing the processor, avoid pressing down on the system board or components. Instead, press down on the plastic connectors.**

## Installing OEM Processor

If you are using Intel Pentium II/III Processor in OEM package, Please follow the steps below:

1. Your OEM package may include the following items :

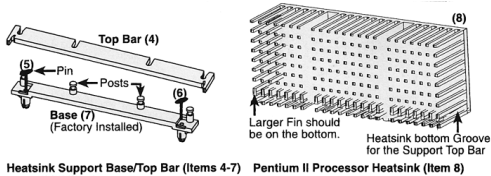

### Note :

- ◆ Make sure your heatsink is attached with a fan to prevent overheating the processor.
- ◆ Contact your heatsink manufacture to check whether your processor requires a Heatsink Support (HSS) installed on the mainboard.

2. Push the HSS top bar sideways to free the HSS Top bar from the retaining "tabs" of the HSS Base.

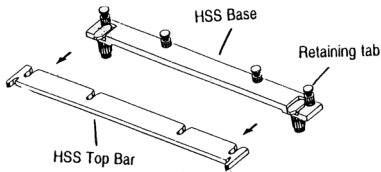

3. Remove the HSS Pins located on the each end of the HSS base.

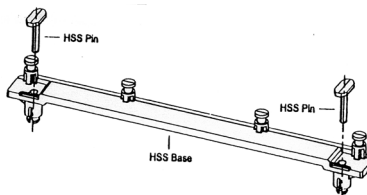

4. Install the HSS Base by pushing each side down firmly into the holes on the mainboard. (HSS Base can only be installed in one direction). Make sure it locks into place.
5. Replace the HSS Pins on each end of the HSS Base. These pins will insert through the HSS Base to secure it to the mainboard.
6. Hold the processor and push the latches toward the center of processor until they click into place.

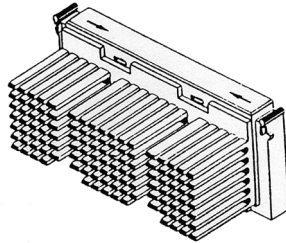

7. Hold the processor so that the heatsink is facing toward the HSS base on the moainboard. Slide the processor into the Retention Mechanism. Make sure that the alignment notch in the processor fits into the Plug & Play in SLOT 1. Push the processor down firmly, with even pressure on both sides of the top, until it is seated.

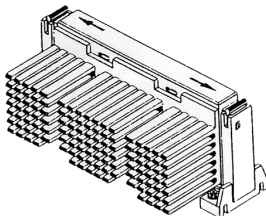

8. Push the latches on the processor outward until they click into place in the Retention Mechanism. The latches must be secured for proper electrical of the processor.

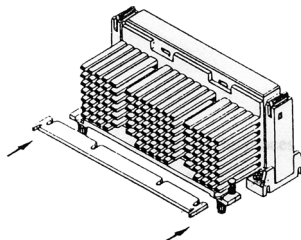

9. Slide the HSS Top bar into the heatsink until it locks into place.



10. Attach the small end of the power cable to three-pin connector in the processor, then attach the large the large end to the three-pin connector on the main board.

## **Clearance Requirements**

---

To maintain proper airflow once the processor is installed on the mainboard, the processor and fan heatsink require certain space clearances. The clearance above the processor must be at least 0.3 inch. The clearance on at least 3 of 4 sides of the processor and fan heatsink must be at least 0.2 inch. All cables (for Floppy drive, Hard drive, CD-ROM, and so on) must be routed clear of the processor and its airspace.

## **Fan Exhaust**

---

The processor must be kept cool by using a processor with heatsink and fan attached . The temperature of the air filled with the fan/ heatsink cannot exceed 45 °C(113 °F) . The ambient or room temperature must be below 37 °C ( 99 °F) .

## EXTERNAL CONNECTORS

Both Ribbon cable and Connectors on board are with direction signs to avoid that user insert wrong direction. On other hand, the ribbon cables should always be connected with the red stripe on the pin 1 of side of the connector.

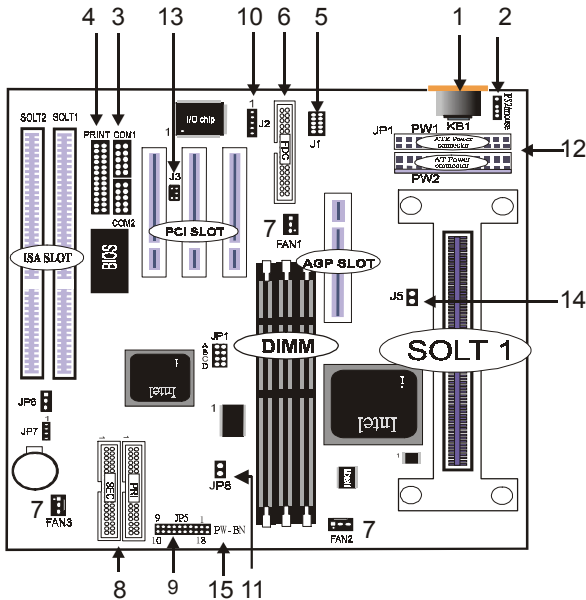

- |                                  |                                      |
|----------------------------------|--------------------------------------|
| 1. AT Keyboard Port              | 9. JP5 Control Panel                 |
| 2. PS/2 Mouse Port               | 10. IR Port                          |
| 3. Serial Port COM1,2            | 11. JP8 (Turbo Pin Selector 100/133) |
| 4. Parallel Printer Port         | 12. ATX Power Connector              |
| 5. Universal Serial Bus Port 1,2 | 13. SB-LINK                          |
| 6. Floppy Driver Connector       | 14. JS (Turbo Pin selector 66/100)   |
| 7. FAN 1,2,3 Connector           | 15. Power Button                     |
| 8. IDE Connectors                |                                      |

**1. AT Keyboard port**

This connection is for a standard keyboard using an AT size (Large DIN) plug . This connector will not allow standard at PS/2 keyboard plugs (mini DIN).

**2. PS/2 Mouse port**

This system will direct IRQ12 to PS/2 mouse.

**3. Serial Port COM 1 and COM 2 port**

The two serial ports can be used for pointing devices or other serial devices. See "Onboard Serial Port" in chipset Feature Setup of the BIOS SOFTWARE.

**4. Parallel Printer port**

You can enable the parallel port and choose the IRQ through " Onboard Parallel Port" in Chipset. Feature Setup of the BIOS SOFTWARE.

**5. Universal Serial BUS Ports 1 & 2**

Two USB ports are available for connecting USB devices.

**6. Floppy drive connector**

This connector supports the provided floppy drive ribbon cable. After connecting the single end to the board, connect the two plus on the other end to the floppy drives.

## 7. FAN1 , FAN2 , FAN3 CPU Cooling Fan (FAN/PWR)

These connectors support cooling fans of 500mAmp (6Watt) or less. Orientate the fans so that the heatsink fins allow airflow to go across the onboard heatsink(s) instead of the expansion slots. Depending on the fan manufacturer, the wiring and plug may be different. The red wire should be positive, while the black should be ground. Connect the fan's plug to the board taking into consideration the polarity of this connector.

### **NOTE :**

The "Rotation" signal is to be used only by a specially designed fan with rotation signal.

### **WARNING :**

The CPU and/or motherboard will overheat if there is no air flowing across the CPU and onboard heatsinks. Damage may occur to the motherboard and/or the CPU fan if there pins are incorrectly used. These are not jumpers, do not place jumper caps over these pins.

## 8. Primary / Secondary IDE connectors (Two 40-pin Blocks)

These connectors support the provided IDE hard disk ribbon cable. After connecting the single end to the board, connect the two plugs at the other end to your hard disk no space(s) . If you install two hard disks, you must configure the second drive to Slave mode by setting its jumper setting. BIOS now supports SCSI device or IDE CD-ROM boot up (see "HDD Sequence SCSI/IDE First" & "Boot Sequence" in the BIOS Features Setup of the BIOS SOFTWARE) (Pin 20 is removed to prevent inserting in the wrong orientation when using ribbon cables with pin 20 plugged) .

**Tip** : You may configure two hard disks to be both Masters using one ribbon cable on the primary IDE connector. You may install one operating system on an IDE drive and another on a SCSI drive and select the right one through BIOS Feature Setup.

**IMPORTANT :** ( only for 6VIA86P )

UltraDMA/66 IDE device must use an 80pin IDE cable.

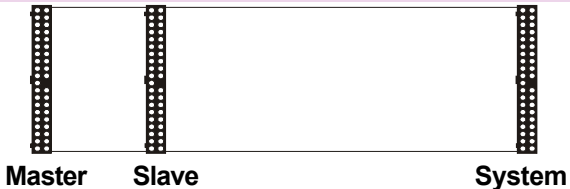

## 9. JP5

### a. IDE activity LED (HD\_LED)

This connector supplies power to the cabinet's IDE activity LED. Read and write activity by devices connected to the Primary or Secondary IDE connectors will cause the LED to light up.

### b. Power LED Lead (PW\_LED)

The system power LED lights when the system's power is on.

### c. SMI Suspend Switch Lead (SMI)

This allows the user to manually place the system into a suspend mode or "Green" mode where systematic activity will be instantly decreased to save electricity and expand the life of certain components when the system is not in use. This 2-pin connector (see the figure below) connects to the case-mounted suspend switch. If you do not have a switch for the connector, you may use the "Turbo Switch" since it does not have a function. SMI is activated when it detects a short to open moment and therefore leaving it shorted will not cause any problems. It may require one or two pushes depending on the position of the switch. Wake-up can be controlled by settings in the BIOS but the keyboard will always allow wake-up (the SMI lead cannot wake-up the system). If you want to use this connector, "Suspend Switch" in the Power Management Setup of the BIOS SOFTWARE section should be on the default setting of Enable.

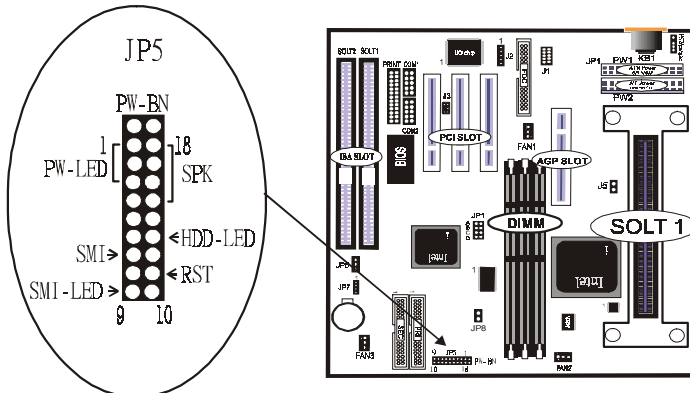

d. **SMI Suspend LED**

e. **Reset Switch Lead (RST)**

This 2-pin connector connects to the case-mounted reset switch for rebooting your computer without having to turn off your power switch. This is a preferred method of rebooting in order to prolong the life of the system's power supply.

f. **System Power LED (PANEL)**

The system power LED lights when the system's power is on (same as above Power LED).

g. **Speaker Connector (SPEAKER)**

This 4-pin connector connects to the case-mounted speaker.

**10. IrDA/Fast IR-Compliant infrared module connector (IR)**

This connector supports the optional wireless transmitting and receiving infrared module. This module mounts to a small opening on system cases that support this feature. You must also configure the setting through "UART2 Use Infrared" in Chipset Feature Setup to select whether UART2 is directed for use with COM2 or IrDA. Use the five pins as shown on the Back View and connect a ribbon cable from the module to the motherboard according to the pin definitions.

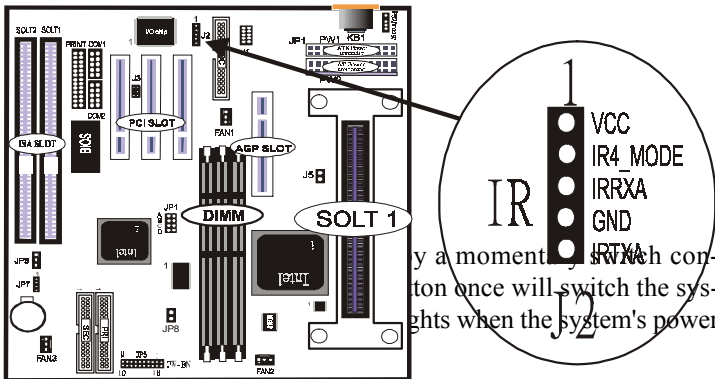

## 11. ATX Power Supply Connector (20-pin block) - PW1

This connector connects to a ATX power supply. The plug from the power supply will only insert in one orientation because of the different hole sizes. Find the proper orientation and push down firmly making sure that the pins are aligned.

### IMPORTANT:

Make sure that the ATX power supply can take at least 10mAmp load on the 5Volt standby lead (5VSB). You may experience difficulty in powering on your system without this.

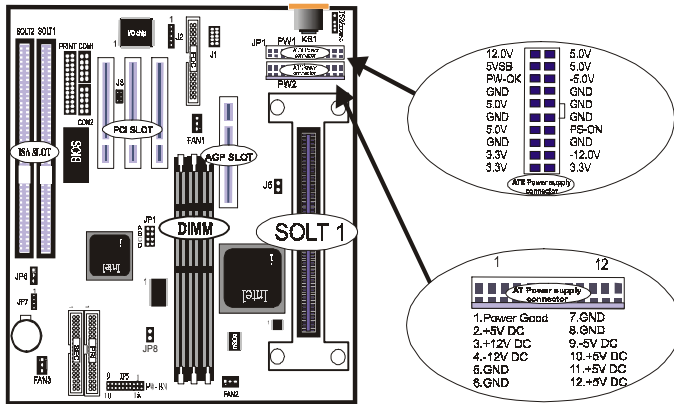



Date :    /    /

## Guarantee Sheet/Technical Fault Report

M/B Model No.: \_\_\_\_\_ Vender \_\_\_\_\_  
Serial No. : \_\_\_\_\_  
Date of Purchasing: \_\_\_\_\_  
Hardware Configuration Used :

|            |  |
|------------|--|
| CPU        |  |
| RAM        |  |
| Video Card |  |
| Hard Drive |  |
| Other Card |  |

Diagnostic Software Used :

|  |
|--|
|  |
|--|

Fault Description :

|  |
|--|
|  |
|--|

Technical Support :

WWW : [www.acorp.com.tw](http://www.acorp.com.tw)

FAE : [fae@acorp.com.tw](mailto:fae@acorp.com.tw)