

CONTENTS

QUICK JUMPER & CONNECTOR SETTING	A
CHECK LIST OF THE PACKAGING.....	B
CONNECTORS DESCRIPTION	C
TABLE OF CONTENTS	1
HOW TO USE THIS MANUAL.....	2
CHAPTER 1 System Feature	3
1-1 Introduction	3
1-2 System Specifications	3
1-3 Features Highlight	4
1-3-1 Software Power Off Control	4
1-3-2 Fan Off Control.....	4
1-3-3 Running 100MHz CPU Bus (JP11).....	5
1-3-4 SB-Link Sideband Signals.....	6
1-3-5 Modem Ring On.....	6
1-3-6 Keyboard & PS/2 Mouse Power On (JP9)	7
1-3-7 Wake-On-LAN	8
1-3-8 Ultra DMA 66 Cable	8
CHAPTER 2 Installation.....	9
2-1 Installation Procedure	9
2-2 CPU Installation	9
2-2-1 Core/Bus Freq. Ratio	9
2-2-2 CPU Setting.....	10
2-3 System Memory Installation	12
2-4 VIA IDE Driver Setup.....	13
CHAPTER 3 Award BIOS Setup	15
3-1 Update BIOS Procedure	16
3-1-2 Update Microcode API	17
3-2 Award System BIOS Configuration Setup	18
Appendix A How to Install Pentium® II/III 、 Celeron™ and Processors with SECC2 Package	
Appendix B Technical Support Request Form	
HOW TO USE THIS MANUAL	

This manual is written in a user-friendly style. It would be advisable for users to read it in an orderly sequence :

1. For Hardware Information:

Read **Page A: QUICK JUMPER & CONNECTOR SETTING**, **Page B: CHECK LIST OF THE PACKAGING** and **Page C: CONNECTORS DESCRIPTION**.

2. For Mainboard and System Features:

Read “**Chapter 1 System Features**” in detail, and you will find helpful information on mainboard and system features. Especially, when you want to do some feature setup, detailed instructions are provided therein to help you through.

3. For CPU, Memory and Drivers Installation:

Read “**Chapter 2 Installation**” for your CPU, memory and application drivers installation. Detailed instructions are provided to guide all kinds of users.

4. For BIOS Update and Setup:

Read “**Chapter 3 Award BIOS Setup**” for updating your mainboard BIOS and setting up your BIOS Configuration.

5. For Installing Pentium®II/III, Celeron or Processors with SECC2 Package:

Read **APPENDIX A** for setting up Intel Pentium®III, Pentium®II, Celeron™, or processors with SECC2 package.

6. For other Technical Support:

Read **APPENDIX B**, fill and send the Request Form to your dealer for other technical support.

It is often heard that the default setting on a mainboard is not what user expects. A user-friendly manual would be the handiest assistant to help change the on-board configuration or default setting. In case this manual cannot solve all your problems, please ask your dealer for help and be sure the warranty on your system is still valid.

REMARK: Intel® is a registered trademark of Intel Corporation.

All other brands and product names are registered trademarks of their respective companies.

CHAPTER 1 SYSTEM FEATURES

1-1 Introduction

ATC6240V mainboard is designed to run with VIA Apollo 133 (693A + 596B) chipset to enhance the performance and extraordinary value of the Intel Pentium® II/III and Celeron™ processor-powered PC. It is mounted with Slot 1 supporting 66MHz, 100MHz and 133MHz Front Side Bus CPU. To enhance its memory and peripheral support, 4 DIMM sockets and 5 PCI slots are mounted on board. In addition, 1 AGP and 2 ISA slots can satisfy some exceptional users' requirements.

1-2 System Specifications

- ☐ CPU Slot supporting Intel Pentium® III CPU 450Mhz to 733MHz, Pentium® II CPU 233MHz to 450MHz and Intel Celeron™ CPU 266MHz to 466MHz.
- ☐ VIA VT82C693A + VT82C596B AGP/PCIsset.
- ☐ Four 168-pin DIMM sockets in four banks of 64-bit wide path up to 1.5GB unbuffered SDRAM (with parity chip ECC support).
- ☐ Built-in Switching Voltage Regulator.(VRM 8.2 SPEC.)
- ☐ One AGP slot, two 16-bit ISA slots and five PCI slots compliance with reversion 2.2 of the PCI Local Bus specification.
- ☐ Dual Master IDE connectors supporting Ultra DMA/66 (66MB/sec), up to four devices in two channels for connecting of high capacity hard disk, CD-ROM, LS-120MB floppy drive, tape backup etc.
- ☐ Winbond 83977 high-speed Ultra Multi-I/O chipset.
- ☐ ATX Power Connector.
- ☐ USB (Universal Serial Bus) Connector supporting up to 127 peripheral devices.
- ☐ PS/2 Keyboard Connector and PS/2 Mouse Connector.
- ☐ Infrared Transfer (IrDA TX/RX) Connector.
- ☐ One FDD Port supporting two devices available for 1.2MB, 1.44MB and 2.88MB.
- ☐ Two 16550A fast UARTs compatible Serial Ports.
- ☐ One EPP/ECP mode Parallel Printer Port.
- ☐ Software Power Off Control; Modem Ring On; SB-Link; Keyboard & PS/2 Mouse Power On; Wake-On-LAN functions.
- ☐ ATX Form Factor; Hardware Dimension is 305mm x 190mm. (12" x 7.48")

1-3 Features Highlight

1-3-1 Software Power Off Control

The mainboard design supports Software Power Off Control feature through the SMM code in the BIOS under Windows 95/98, and MS-DOS operation system environment.

First, you should connect the power switch cable to the connector “PS-ON” on the mainboard. In the BIOS screen of POWER MANAGEMENT SETUP’, choose “User Define” (or “Min. Power Saving” or “Max. Power Saving”) in ‘Power Manager’ and pick up “Yes” in ‘PM Control by APM’.

In Windows 95/98, if you would like to power off the system, you just need to choose “shutdown the computer ?” in the “Shut Down Windows“ from Windows 95/98. Then the system power will be off directly, and become to the stand-by status. If you would like to restart the system, just press the power switch button, and the system will be powered on.

Note : If you are going to leave your system idle for several days, we suggest you use hardware power off to shutdown your system.

Status	Power LED Light	Turbo LED Light
Software power off control	Flash (JP5, pin1-2) Light off (JP5, pin2-3)	Light off
APM mode	Light on	Light on
System running	Light on	Light on

* Under Software power off control, the status of Power LED Light depends on the setting of JP5. If you set JP5 to “pin1-2” position, it is blinking. Otherwise, it is light off.

1-3-2 Fan Off Control

With fan-off function, the CPU cooling fan can turn off automatically even when the system is in suspend mode. This function is able to reduce energy consumption and system noise.

Because it is a feature of advanced BIOS, you should set this option enabled through “Power Management Setup” from the BIOS setup screen.

1-3-3 Running 100 MHz CPU Bus (with JP11)

The mainboard provides **Jumper 11** that allows you to set your CPU host clock and perform CPU overclock function. There are two ways to set CPU host clock at ‘closed’ and ‘open’. When setting ‘closed’, the system will automatically detect the CPU host clock, for instance 66MHz and 100MHz. Another way is to set **Jumper 11** at ‘open’ for 66MHz CPU overclock to 100MHz.

We recommend that users should use Intel Pentium® II/III 100 MHz CPU, running at 350, 400, 450 and 500MHz internal clock speed. Moreover, the SDRAM memory module must be 8 nano-second (Maximum Frequency 125 MHz) speed of memory –die or less. However, based on Intel’s design, we don’t recommend users to run over 100MHz CPU host bus.

Please note that the default setting of Jumper 11 is ‘closed’.

Jumper 11	BASE CLK
Closed	Base clock autodetected
Open	To be overclocked

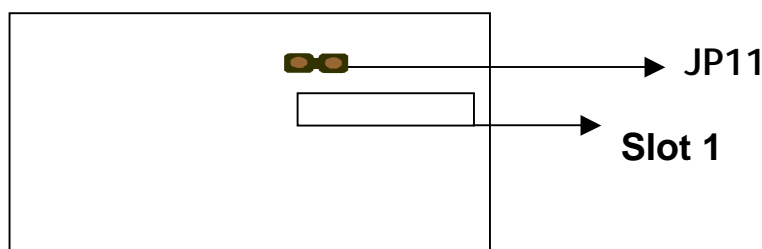

★ In view of Intel’s specific design, overclocking to 100MHz or higher is not necessarily successful. If you want to overclock your CPU base, please set “CPU Host/PCI Clock” in “CHIPSET FEATURES SETUP” in the BIOS setup screen. After set to higher base, if the system cannot boot up, you should shut down your computer, and restart it with the ‘Insert’ key pressed down to clear up the set frequency. It will then operate at the default frequency.

1-3-4 SB-Link Sideband Signals

In order to migrate the legacy Sound Blaster compatible audio to the PCI bus, EMU8008 incorporates a pair of SB-Link request/grant sideband signals (PCPCIR EQN and PCPCIGNTN) to interface to the PCI bus. SB-Link is a mechanism that was defined and developed by Intel as a docking solution which allows ISA slots to exist in docking stations connected to desktop PC PCI bus.

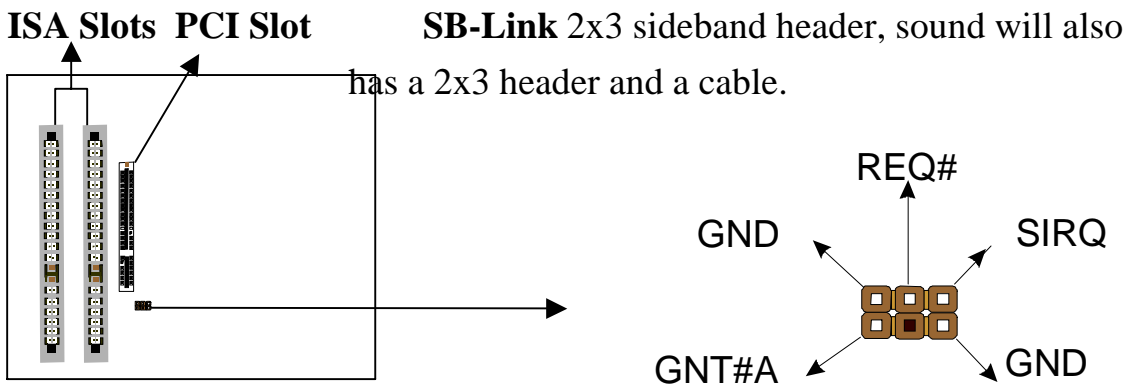

1-3-5 Modem Ring On

With Modem Ring On function, the computer can wake up remotely through the connected modem. This function enables users to access their computer data from anywhere in the world. But users have to set “Resume by Ring” with ‘enabled’ in “Power Management Setup” from the BIOS setup screen.

1-3-6 Keyboard & PS/2 Mouse Power On (with JP9)

With ATX Power Supply and Jumper 9 set to Pin 1-2 closed, ATC6240V Mainboard is enabled to Keyboard & PS/2 Mouse Power On functions :

JP 9	KB & PS/2 Mouse Wakeup
1-2	Enable
2-3	Disable

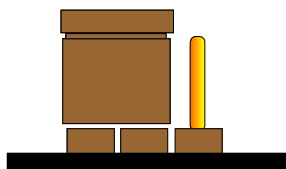

(a) Enable (1-2 closed)

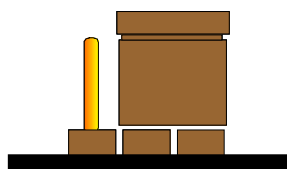

(b) Disable (2-3 closed)

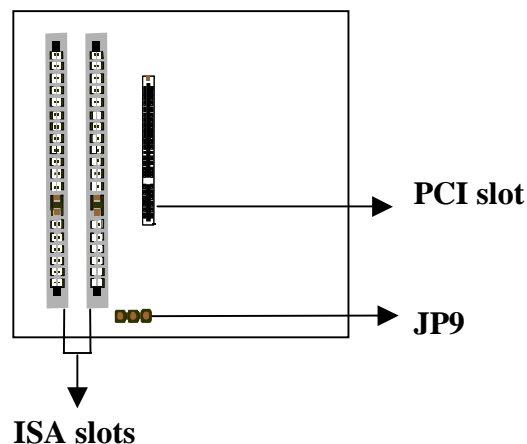

The default Power On function is “Button Only”. That means, we can only turn our computer on and off by pressing the “Power Button”. If we want to enable KB & PS/2 Mouse Power On function, we first have to set JP9 to Pin 1-2 closed, and then go to “Power On Function” in “Integrated Peripherals” of Award BIOS Setup. At the line “Power On Function”, we can press “Page Up” or Page Down” to make the following selections:

1. Password(via Keyboard):

When user selects “Password”, it will show “Enter Password:”. After user has typed the password, screen will show “ Confirm Password:” and user has to type the same password to confirm it. Save selection and shut down system. Now computer will only be powered on by entering correct password.

In case the set password is forgotten, carry out “Clear CMOS” (Page 15) to clear password, or computer can not be powered on.

2. Hot Key (via Keyboard):

When user selects this option, screen will show another line : “Hot Key Power ON : Ctrl-F1”. User can select from “Ctrl-F1” to “Ctrl-F12” as Hot Key by pressing PageUp / PageDown. After fixing Hot Key, save selection and shut down system. Now computer will only be powered on by pressing the correct Hot Key.

3. Mouse Left, Mouse Right (via PS/2 Mouse):

This function is available via PS/2 mouse only. User can select either “Mouse Left” or “Mouse Right” from the “Power On Function” line. After picking either option, save selection and shut down system. Now computer will only be powered on by double-clicking the correct PS/2 Mouse button.

Do not slide the mouse when you click; or you can't power on the system.

4. Button Only (via Power Button): “Button Only” is default setting, at which computer can only be on/off via Power Button.

1-3-7 Wake-On-LAN

The remote Wake-On-LAN (WOL) mode of operation is a mechanism that uses Advanced Micro Device Magic Packet technology to power on a sleeping workstation on the network. This mechanism is accomplished when the LAN card receives a specific packet of information, called a Magic Packet, addressed to the node on the network. For additional protection, Secure ON is an optional security feature that can be added to the Magic Packet that requires a password to power on the sleeping workstation. When LAN card is in remote Wake-On-LAN mode, main system power can be shut down leaving power only for the LAN card and auxiliary power recondition.

The LAN card performs no network activities while in the remote Wake-On-LAN mode of operation. It only monitors the network for receipt of a Magic Packet. If a Magic Packet is addressed to the LAN card on the network, the LAN card wake up the system. If the Secure ON feature has been enabled, the password added to the Magic Packet is also verified prior to waking up the system.

You should select two kinds of PCI Ethernet cards with WOL function. One is Intel and the other is with PME signal supporting. And you can set “Wake Up On LAN” this function enabled through “ Power Management Setup” from the BIOS setup screen.

1-3-8 Ultra DMA 66 Cable

Ultra DMA 66 cable (40-pin connector & 80-line cable) is packaged which supports both UDMA 33 & UDMA 66 on the mainboard. And the Ultra DMA 66 color coded connectors for connection are shown as bellow:

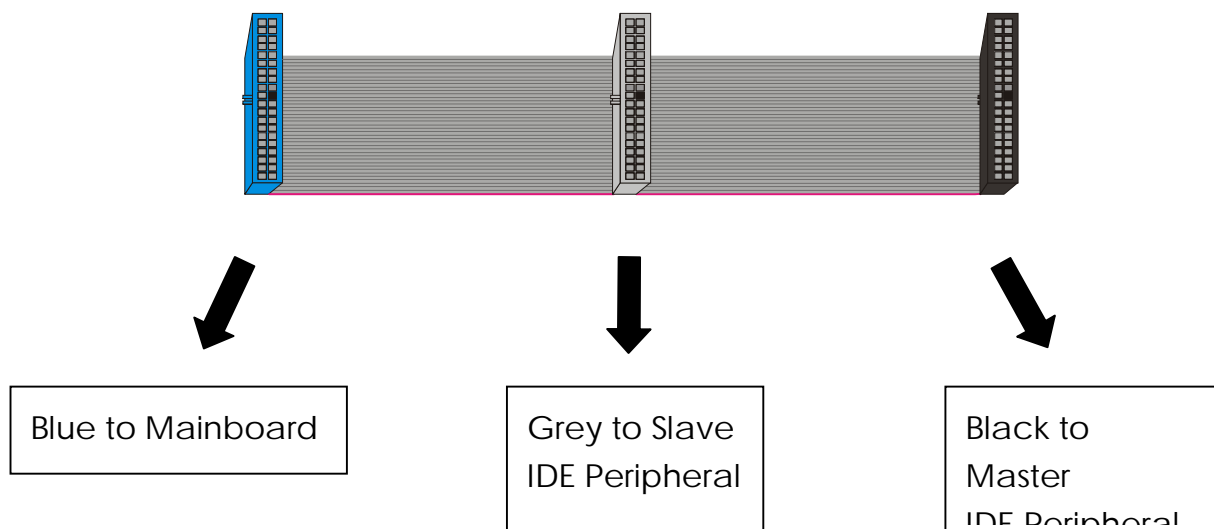

CHAPTER 2 INSTALLATION

2-1 INSTALLATION PROCEDURE

Before installing the computer, please prepare all components such as CPU, DRAM; peripherals such as hard disk, keyboard, CD-ROM and accessories such as cables. Then, install the system as following:

- ❶ Plug CPU/ heat sink (refer to Pentium® II/III & Celeron™ installation guide, **Appendix A**), and DRAM modules on the mainboard.
- ❷ Set DIP switch & jumpers based on your configuration.
- ❸ Plug add-on cards into PCI/ISA slots, if needed.
- ❹ Connect cables to peripheral devices, especially for power supply.
- ❺ Make sure all components and devices are well connected, turn on the power and setup System BIOS based on your configuration.
- ❻ Install peripheral devices, add-on card drivers and test them.
- ❼ If all of above procedures are running successfully, turn the power off and screw the chassis cover to the chassis, and then connect external devices which are cabled to the system.

2-2 CPU INSTALLATION





The mainboard has built-in VID (Voltage Identify) function to automatically detect CPU voltages. Thus you do not have to set the CPU voltage setting.

2-2-1 CPU Core/Bus Freq. Ratio :





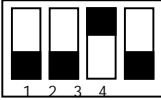
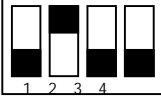
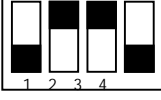
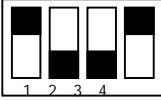

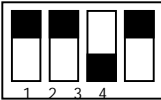



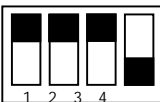
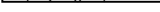

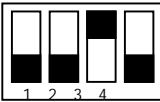

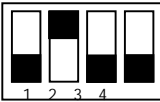

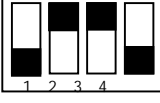



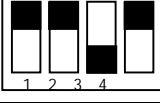

SW1	1-1	1-2	1-3	1-4
3.0x	ON	ON	OFF	OFF
3.5x	ON	ON	ON	OFF
4.0x	OFF	OFF	OFF	OFF
4.5x	OFF	OFF	ON	OFF
5.0x	OFF	ON	OFF	OFF
5.5x	OFF	ON	ON	OFF
6.0x	ON	OFF	OFF	ON
6.5x	ON	OFF	ON	ON
7.0x	ON	ON	OFF	ON
7.5x	ON	ON	ON	ON
8.0x	OFF	OFF	OFF	ON

2-2-2 CPU Setting

a. For 233~333MHz Intel Pentium® II & 266~466MHz Celeron™ CPUs.

INTERNAL CPU CLOCK	SW1
<p>233MHz (66x3.5)</p>	<p>ON </p> <p>OFF</p>
<p>266MHz (66x4.0)</p>	<p>ON </p> <p>OFF</p>
<p>300MHz (66x4.5)</p>	<p>ON </p> <p>OFF</p>
<p>333MHz (66x5.0)</p>	<p>ON </p> <p>OFF</p>
<p>366MHz (66x5.5)</p>	<p>ON </p> <p>OFF</p>
<p>400MHz (66x6.0)</p>	<p>ON </p> <p>OFF</p>
<p>433MHz (66x6.5)</p>	<p>ON </p> <p>OFF</p>
<p>466MHz (66x7.0)</p>	<p>ON </p> <p>OFF</p>

b. For 350~450MHz Intel Pentium® II and 450~733MHz Pentium® III CPUs.

INTERNAL CPU CLOCK	SW1
<p>350MHz (100x3.5)</p>	<p>ON </p> <p>OFF </p>
<p>400MHz (100x4.0)</p>	<p>ON </p> <p>OFF </p>
<p>450MHz (100x4.5)</p>	<p>ON </p> <p>OFF </p>
<p>500MHz (100x5.0)</p>	<p>ON </p> <p>OFF </p>
<p>550MHz (100x5.5)</p>	<p>ON </p> <p>OFF </p>
<p>600MHz (100x6.0)</p>	<p>ON </p> <p>OFF </p>
<p>650MHz (100x6.5)</p>	<p>ON </p> <p>OFF </p>
<p>700MHz (100x7.0)</p>	<p>ON </p> <p>OFF </p>
<p>533MHz (133x4.0) (for Mod.6240V-01)</p>	<p>ON </p> <p>OFF </p>
<p>600MHz (133x4.5) (for Mod.6240V-01)</p>	<p>ON </p> <p>OFF </p>
<p>677MHz (133x5.0) (for Mod.6240V-01)</p>	<p>ON </p> <p>OFF </p>
<p>733MHz (133x5.5) (for Mod.6240V-01)</p>	<p>ON </p> <p>OFF </p>

2-3 SYSTEM MEMORY INSTALLATION

The ATC6240V provides four 168-pin DIMM sockets for system memory expansion from 8MB to 1.5GB Unbuffered SDRAM. These four DIMMs are arranged to four banks, please refer to page A.

Bank/DIMM	Memory Module	Total Memory
Bank0/DIMM1	8/16/32/64/128/256/512MB	8MB~512MB
Bank1/DIMM2	8/16/32/64/128/256/512MB	8MB~512MB
Bank2/DIMM3	8/16/32/64/128/256MB	8MB~256MB
Bank3/DIMM4	8/16/32/64/128/256MB	8MB~256MB
Total System Memory		8MB~1.5GB

DRAM type, size, parity supported:

- ⌚ Unbuffered SDRAM with SPD
- ⌚ Both parity or non-parity are available.
- ⌚ 3.3V, Single/double-side, 8/16/32/64/128/256/512Mbytes

-
- ◆ *For 66MHz host bus CPUs use 12ns or faster DIMM module;*
 - ◆ *For 100MHz host bus CPUs use 10ns or faster and PC-100 compliant modules .*
 - ◆ *Please insert 512MB memory module to DIMM 1 and DIMM2.*
-

⌚ SPD (Serial Presence Detect)

This EPROM contains speed and design information of the memory module. The mainboard may get optimal performance via accessing the data of SPD.

⌚ ECC (Error Check and Correction)

This mainboard can support the ECC function while utilizing parity modules. To enable this function, users must set “DRAM Data Integrity Mode” to “ECC” through “Chipset Features Setup” from the BIOS setup screen. All in all, ECC’s function is to detect and correct the errors of transfer data.

2-4 VIA IDE DRIVER SETUP

The VIA IDE drivers are enclosed into the VIA Utility CD. Use this CD ROM for installation of the VIA drivers.

2-4-1 Setup for Windows 9x :

1. Starting Windows system.
2. Insert the VIA Utility CD ROM into your CD-ROM Drive. If the VIA Driver Setup Main Menu does not appear automatically, just point to “My Computer” and click the CD ROM icon to open the VIA Utility CD ROM directly.
3. In a second, the “VIA Service Pack v.xx main menu shows up.
4. To start VIA drivers setup, point to the “VIA Integrated Setup” and click on it.
5. User-friendly Setup screens will appear one by one , guiding you to finish the complete setup.
6. Among the guiding screens, the “Select Components” screen (as shown below) will show you the programs to be installed into your system. New users are recommended to install all of them

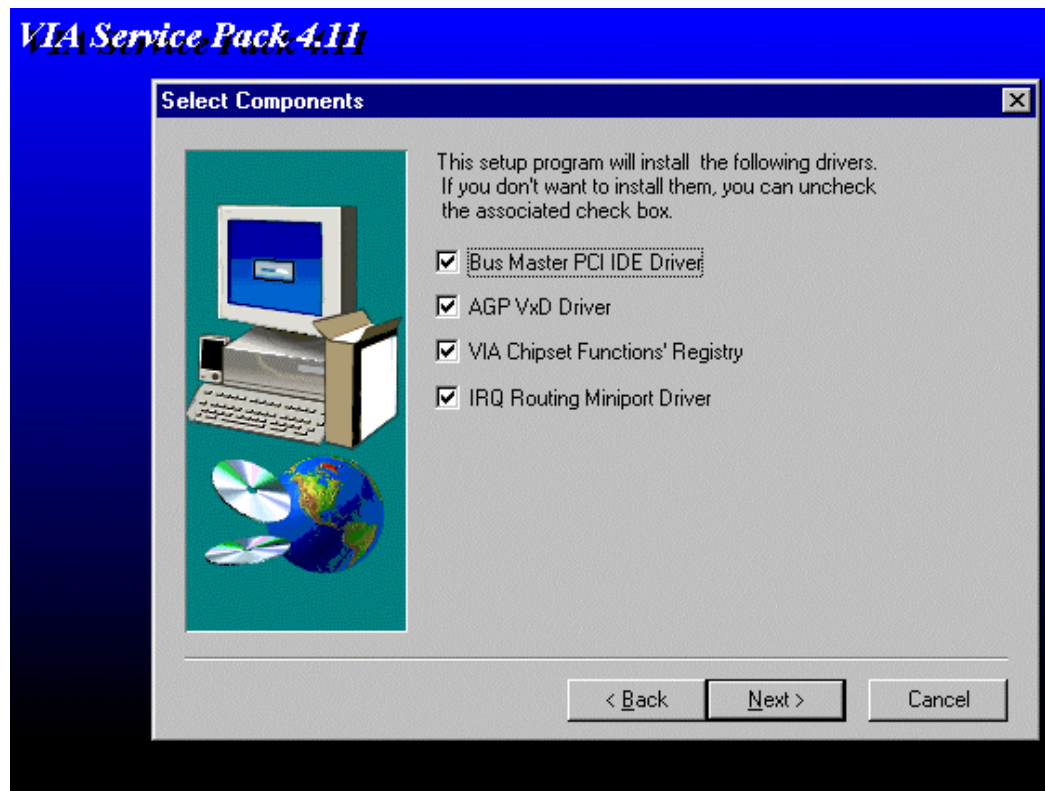

7. When the “Setup complete” screen appears, click “Finish” to restart your computer so as to put the just installed drivers into effect.

2-4-2 Setup for Windows NT 4.0

The VIA IDE drivers for WinNT are also enclosed into the VIA Utility CD. Use this CD ROM for installation of the VIA drivers for WinNT.

1. Starting Windows NT 4.0.
2. Insert the VIA Utility CD ROM into your CD-ROM Drive, point to “My Computer” and click the CD ROM icon to open the VIA Utility CD ROM directly.
3. In a second, the “VIA Service Pack v.xx main menu shows up as below:

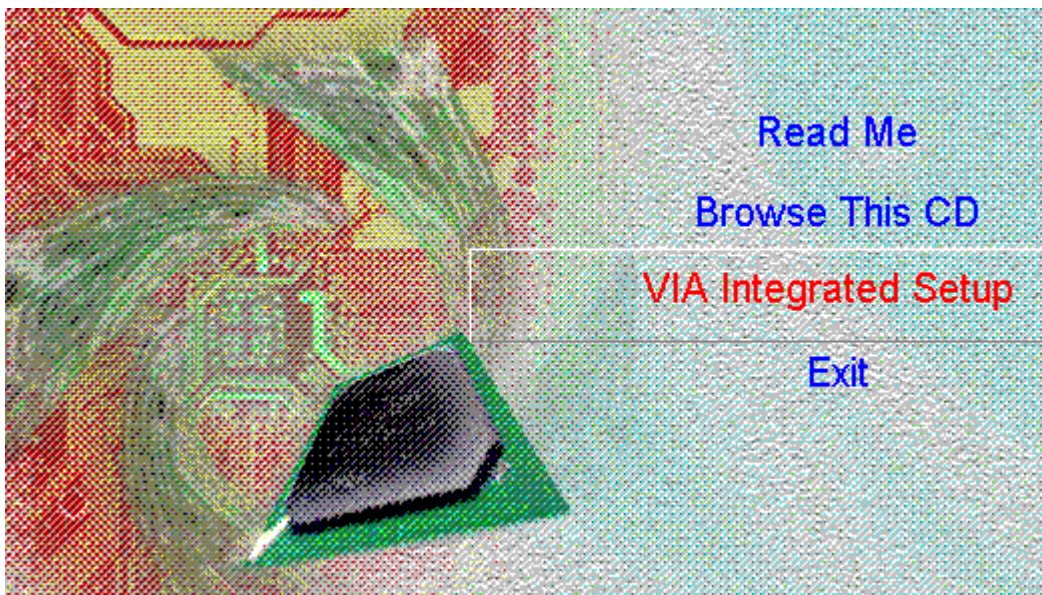

4. Point to “VIA Integrated Setup” and click on it to start setup right away.
5. Successive screens with user-friendly instructions will appear to guide you through the whole setup.
6. When the “Setup complete” screen appears, click “Finish” to restart your computer so as to put the just installed drivers into effect.

CHAPTER 3 AWARD BIOS SETUP

Award BIOS manufacturer provides access to the system BIOS through the hardware and software on the mainboard. The hardware consists of a Flash ROM and the software is a group of programs that are installed in the ROMBIOS along with all the other data the BIOS must contain.

After the BIOS is updated, if you want to clear the old setup data stored in the CMOS, then you can clear CMOS.

NOTE : In case CMOS should be cleared, unplug the power cord, set Jumper 8 2-3 closed for at least 5 seconds, put it back to 1-2 position and plug the power cord again.

	JP8
Normal	1-2
Clear CMOS	2-3

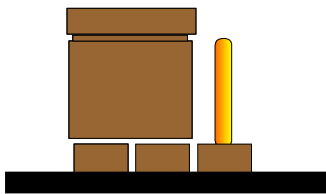

Normal (Pin 1-2 closed)

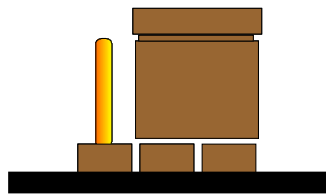

Clear CMOS (Pin 2-3 closed)

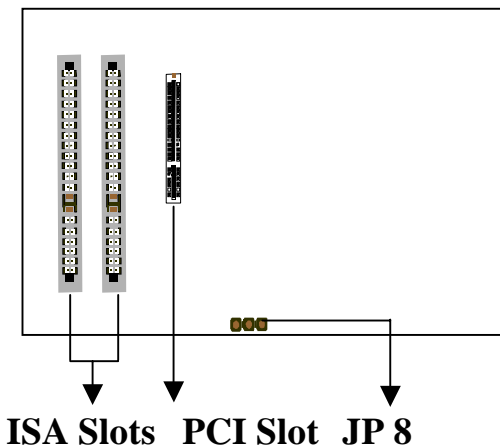

3-1 UPDATE BIOS PROCEDURE

If the BIOS needs to be updated, you can get a CD or diskette with the updated BIOS utility in the package. The BIOS-update diskette or All-In-One CD includes two files:

“awdfash.exe” and “awdfash.doc”.

And the new or updated Award BIOS file should be obtained from your system manufacturer or dealer.

The updating procedure is as the following:

1. Before updating your BIOS, please load the above-mentioned files to root directory “C” or a floppy drive diskette.
2. Boot the system to DOS mode in a normal manner.
3. Under “C” or Drive “A” (where your BIOS update files should be), type awdfash.exe and press “Enter”
4. The following screen will instantly appear, on which you should enter the file name of the new or updated BIOS.

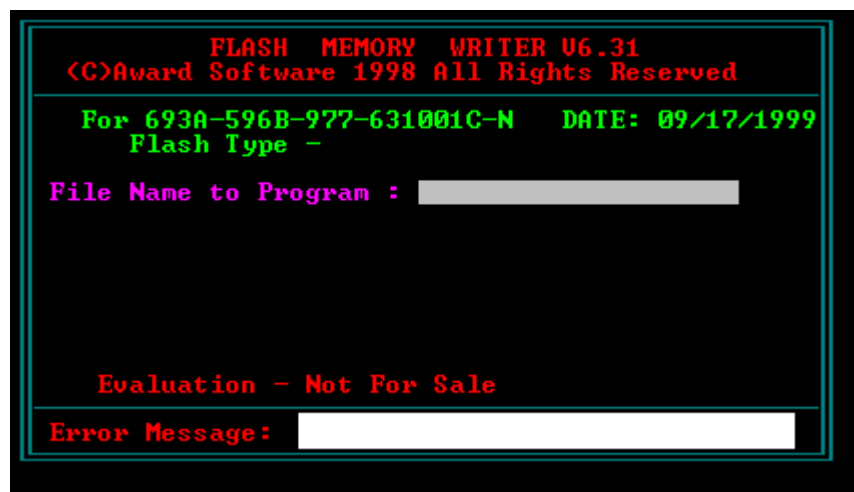

5. After you have entered the file name, press “Enter”. And on the “Error Message” row shows “Do you want to save BIOS (Y/N)”.
6. Type “N” but do not press “Enter”. And the message : " Are you sure to program (Y/N) ?" will appear at once.
7. Type “Y” but do not press “Enter”.
8. BIOS updating process will start at once until you see the message “Reset System or power off to accomplish update process”.
9. Press “F1” button to restart your system, and the updating process is complete.

3-1-2 UPDATE MICROCODE API

Intel also provides MICROCODE API (Applications Programming Interface) for Pentium® II/III processor-based mainboard-users to update data block in BIOS quickly and easily. (You can find this utility in the diskette or All-In-One CD in the package.)

The BIOS code on the Pentium® II/III processor-based mainboard contains data that is specific to each silicon stepping of the processor. Integrators must ensure that this BIOS stepping data matches the processor stepping used. When the BIOS does not contain stepping data that matches the processor stepping, integrators must update the data in the BIOS before shipping the system. Usually, System is updated by replacing the entire BIOS with a new revision of BIOS that contains the correct stepping data.

Intel's BIOS updating API allows just the stepping data within the BIOS to be updated as needed. Mainboards that contain a BIOS with the Intel-defined BIOS updating API can be quickly and easily updated, if required, without obtaining a complete BIOS upgrade. Using this utility, integrators can easily verify that the correct stepping data is present in all mainboards. However, if the stepping data requires updating, the mainboard BIOS must contain the Intel-defined BIOS updating API, otherwise a complete BIOS upgrade is required from the mainboard vendor.

Since API program can only be executed under **DOS Real Mode**, you must **enter Real Mode first** and load the API program to Drive C.

To load the program to C by following steps:

- (1) Type "md c:\api" and press Enter. Directory "api" is made in Drive C now.
- (2) Insert the Driver/Utility diskette or CD into Drive A or CD ROM Drive E.
- (3) Then type "copy a:\api*. * c:\api" or "copy e:\api*. * c:\api" and press Enter.
(API program is loaded to Drive C now.)
- (4) Type "C:\api \checkup" to execute this program.

The main menu should now be displayed, showing the following four options :

- 1) Check and load updated
- 2) Specify stepping data file [current : pep.pdb]
- 3) Help
- 4) Quit without loading updated

Select 1 to know the stepping filename, select 2 to load right patch code, then select 1 to update proper patch code. Then cold boot (mechanical power off) system to continue. For more information, please refer to "CHECKUP.HLP" file.

3-2 SYSTEM BIOS CONFIGURATION SETUP

The following pages explain how to set up the BIOS configuration under the Award BIOS. The SETUP program is stored in the Read-Only-Memory (ROM) on the mainboard. To do the SETUP procedure, press the key when the system is booting up. The following main menu will appear. Please select " STANDARD CMOS SETUP" to enter the next screen.

ROM PCI/ISA BIOS
CMOS SETUP UTILITY
AWARD SOFTWARE, INC.

STANDARD CMOS SETUP	INTEGRATED PERIPHERALS
BIOS FEATURES SETUP	SUPERVISOR PASSWORD
CHIPSET FEATURES SETUP	USER PASSWORD
POWER MANAGEMENT SETUP	IDE HDD AUTO DETECTION
PNP/PCI CONFIGURATION	SAVE & EXIT SETUP
LOAD BIOS DEFAULTS	EXIT WITHOUT SAVING
LOAD SETUP DEFAULTS	
ESC: Quit	↑↓→←:Select Item
F10: Save & Exit Setup	(Shift) F2 : Change Color
Time, Date, Hard Disk Type	

The section on the bottom of the main menu explains how to control this screen. The other section displays the items highlighted in the list.

STANDARD CMOS SETUP This screen records some basic hardware information, and sets the system clock and error handling. These records can be lost or corrupted if the on-board battery has failed or is weak.

ROM PCI/ISA BIOS
STANDARD CMOS SETUP
 AWARD SOFTWARE, INC.

Date (mm:dd:yy) : Mon, Sep 13 1999	
Time(hh:mm:ss) : 13 : 37 : 14	
HARD DISKS TYPE SIZE CYLS HEAD PRECOMP LANDZ SECTOR MODE	
Primary Master : Auto	0 0 0 0 0 0 0 Auto
Primary Slave : Auto	0 0 0 0 0 0 0 Auto
Secondary Master : Auto	0 0 0 0 0 0 0 Auto
Secondary Slave : Auto	0 0 0 0 0 0 0 Auto
Drive A : 1.44M, 3.5 in.	
Drive B : None	Base Memory : 640K
Floppy 3 Mode Support : Disabled	Extended memory : 7168K
Video : EGA/VGA	Other Memory : 384K
Halt On: All Errors	-----
	Total Memory : 8192K
ESC : Quit ↑↓→←:Select Item PU/PD/+/- : Modify	
F1 : Help (Shift) F2 : Change Color	

Date The date format is <day>,<date>,<month>,<year>. Press<F3> to show the calendar.

day	The day, from Sun to Sat, determined by the BIOS and is displayed-only
date	The date, from 1 to 31
month	The month, Jan. through Dec.
year	The year, from 1900 to 2099

Time The time format is <hour><minute><second>. The time is calculated based on the 24-hour military-time clock. For example, 1p.m. is 13:00:00.

Primary Master Primary; Slave Secondary Master Secondary Slave

These categories identify the types of the 2 channels that have been installed in the computer. There are 45 predefined types and 4 user definable types for Enhanced IDE BIOS. Type 1 to 45 which are predefined. Type 'user' which is user-definable. Press PgUp/PgDn to select a numbered hard disk type or type the number and press <Enter>.

If you select '**Auto**', the BIOS will detect the HDD & CD-ROM Drive automatically at the POST stage and show the IDE for HDD & CD-ROM Drive. If you select '**user**', you will need to know the information listed below. This information should be from your hard disk vender or dealer. Then enter the figure directly and press <Enter>. If the controller of the HDD interface is ESDI, the selection shall be '**Type 1**'; if SCSI, the selection shall be '**None**'. If no device is installed select '**NONE**' and press <Enter>.

Type	drive type
SIZE	automatically adjusts
CYLS	number of cylinders
HEAD	number of heads
PRECOMP	write precom
LANDZ	landing zone
SECTOR	number of sectors
MODE	mode type

Drive A, Drive B This category identifies the types of floppy disk drive A or drive B that has been installed in the computer.

None	No floppy drive installed
360K, 5.25 in	5.25" PC-type 360KB capacity
1.2M, 5.25 in	5.25" AT-type 1.2MB capacity
720K, 3.5 in	3.5" double-side 720KB capacity
1.44M, 3.5 in	3.5" double-side 1.44MB capacity
2.88M, 3.5 in	3.5" double-side 2.88MB capacity

Floppy 3 Mode Support This is the Japanese standard floppy drive. This standard stores 1.2MB in a 3.5" diskette.

Video This category selects the type of video adapter used for the primary system monitor. Although secondary monitors are supported, you do not have to select the type in Setup.

EGA/VGA	Enhanced Graphics Adapter/Video Graphics Array. For EGA, VGA, SEGA, SVGA or PGA monitor adapters
CGA 40	Color Graphics Adapters, power up in 40 column mode
CGA 80	Color Graphics Adapters, power up in 80 column mode
MONO	Monochrome adapter, includes high resolution monochrome adapters

Halt On This category determines whether the computer will stop if an error is detected during power up.

No errors	The system boot will not be stopped for any error that may be detected.
All errors	When the BIOS detects a non-fatal error, the system will be stopped and you will be prompted.
All, But Keyboard	The system boot will not stop for a keyboard error. It will stop for all other errors.
All, But Diskette	The system boot will not stop for a disk error. It will stop for all other errors.
All, But Disk/Key	The system boot will not stop for a disk or keyboard error. It will stop for all other errors.

Memory This category is displayed only which is determined by POST (Power On Self Test) of the BIOS.

Base Memory The POST will determine the amount of base (or conventional) memory installed in the system. The value of the base memory is typically 512K or 640K based on the memory installed on the motherboard.

Extended Memory How much extended memory is present during the POST. This is the amount of memory located above 1MB in the CPU's memory address map.

Other Memory This refers to the memory located in the 640K to 1024K address space. This is memory that can be used for different applications. DOS uses this area to load device drivers in an effort to keep as much base memory free for application programs. The BIOS is the most frequent user of this RAM area since this is where it shadows RAM.

BIOS FEATURES SETUP This screen is a list of system configuration options. Some of them are defaults required by the mainboard's design, others depend on the features of your system.

ROM PCI/ISA BIOS
BIOS FEATURES SETUP
 AWARD SOFTWARE, INC.

Virus Warning	: Disabled	Video BIOS Shadow	: Enabled
CPU L1 Cache	: Enabled	C8000-CBFFF Shadow	: Disabled
CPU L2 Cache	: Enabled	CC000-CFFFF Shadow	: Disabled
CPU L2 Cache ECC Checking	: Enabled	D0000-D3FFF Shadow	: Disabled
Processor Number Feature	: Enabled	D4000-D7FFF Shadow	: Disabled
Quick Power On Self Test	: Enabled	D8000-DBFFF Shadow	: Disabled
Boot Sequence	: A,C,SCSI	DC000-DFFFF Shadow	: Disabled
Swap Floppy Drive	: Disabled		
Boot Up Floppy Seek	: Enabled		
Boot Up NumLock Status	: On		
IDE HDD Block Mode	: Disabled		
Gate A20 Option	: Normal		
Memory Parity/ECC Check	: Disabled		
Security Option	: Setup	Esc : Quit	↑↓→←:Select Item
PCI/VGA Palette Snoop	: Disabled	F1 : Help	PU/PD/+/- : Modify
OS Select for DRAM>64MB	: Non-OS2	F5 : Old Values (SHIFT)	F2 : Color
HDD S.M.A.R.T. capability	: Disabled	F6 : Load BIOS Defaults	
Report No FDD For WIN 95	: No	F7 : Load Setup Defaults	

Virus Warning When this item is enabled, the Award BIOS will monitor the boot sector and partition table of the hard disk drive for any attempt at modification. If an attempt is made, the BIOS will halt the system and the following error message will appear.

Afterwards, if necessary, you will be able to run an anti-virus program to locate and remove the problem before any damage is done.

! WARNING !

Disk boot sector is to be modified
 Type 'Y' to accept write or 'N' to abort write
 Award Software, Inc.

Enabled	Activates automatically when the system boots up. If anything attempts to access the boot sector or hard disk, partition table will cause a warning message to appear.
Disabled	No warning message will appear when anything attempts to access the boot sector or hard disk partition table.

Many disk diagnostic programs which attempt to access the boot sector table can cause the above warning message. If you will be running such a program, we recommend that you first disable Virus Protection beforehand.

CPU L1 Cache, L2 Cache These two categories speed up memory access. However, it depends on CPU/chipset design. The default value is ‘enabled’.

CPU L2 Cache ECC Checking When this item is enabled, it means the system supports Error Checking and Correcting (ECC) memory which can guard against data corruption.

Processor Number Feature The Processor Serial Number serves as an identifier for the Processor and its system and thus adds to the system security features. When this feature is “Enabled”, the Processor Serial Number is detectable and can be utilized in information Management etc. When “Disabled”, the Processor Serial Number is not detectable. This feature is built in Pentium® III Processor only.

Quick Power On Self Test This category speeds up Power On Self Test after you power up the computer. If you set “Enabled”, BIOS will shorten or skip some items under check during POST.

Boot Sequence This category determines which drive to search first for the Disk Operating System (i.e., DOS). The system will search those drives in order, Ex.: C, CDROM, A: System will first search for hard disk drive then CDROM drive, and the last is floppy disk drive.

Note: C is primary master; D is primary slave; E is secondary master, F is secondary slave.

Swap Floppy Drive This item allows you to determine whether to enable the swap floppy drive or not. The choice : Enabled/ Disabled.

Boot Up Floppy Seek During POST, the BIOS will determine if the floppy disk drive installed is 40 tracks (360K) or 80 tracks (720K, 1.2M, 1.44M)

Enabled	BIOS searches for floppy disk drive to determine if it is 40 or 80 tracks.
Disabled	BIOS will not search for the type of floppy disk drive by track number.

Boot Up NumLock Status This allows you to determine the default state of the numeric keypad. By default, the system boots up with NumLock on.

On	Keypad is for numeric keys.
Off	Keypad is for arrow keys.

IDE HDD Block Mode This allows your HD controller to use the fast block mode to transfer data to and from your HD drive.

Enabled	IDE controller uses block mode .
Disabled	IDE controller uses standard mode.

Gate A20 Option This entry allows you to select how the gate A20 is handled. The gate A20 is a device used to address memory above 1 MB. Initially, the gate A20 was handled via a pin on the keyboard. Today, while keyboards still provide this support, it is more common and much faster for the system chipset to provide support for gate A20. Normal is keyboard; Fast is chipset.

Memory Parity/ECC Check Select parity, ECC or Disabled depending on the type of DRAM installed in your system. The choice: ECC, Parity, Disabled.

Security Option This category allows you to limit access to the system and Setup, or just to Setup.

System	The system will not boot and access to Setup will be denied if the correct password is not entered at the prompt
Setup	The system will boot, but access to Setup will be denied if the correct password is not entered at the prompt

To disable the security, select PASSWORD SETTING at Main Menu, and then you will be asked to enter password. Do not type anything and just press <Enter>, it will disable the security. Once the security is disabled, the system will boot and you can enter Setup freely.

PCI/VGA Palette Snoop It determines whether the MPEG ISA/VESA VGA cards can work with PCI/VGA or not.

Enabled	When PCI/VGA working with MPEG ISA/VESA VGA Card
Disabled	When PCI/VGA not working with MPEG ISA/VESA VGA Card

OS Select for DRAM > 64MB This item allows you to access the memory that is over 64MB in OS/2. The choice : Non-OS2, OS2

HDD S.M.A.R.T. Capability Select Enabled if your Hard disk supports S.M.A.R.T.(Safe-Monitoring Analysis and Reporting Technology) function

Report No FDD For WIN 95 Set this item to Yes, BIOS will report FDD to Win95. If in standard CMOS setup, set Drive A to none and set this item to yes. Inside Win95, My Computer and File manager Disk(A:) will show Removable Disk (A:).

Video BIOS Shadow Determines whether video BIOS will be copied to RAM. However it is optional depending on chipset design. Video Shadow will increase the video speed. The choice : Enabled/Disabled

C8000 – CBFFF Shadow; DC000 – DFFFF Shadow These categories determine whether option ROMs will be copied to RAM. An example of such option ROM would be the support of onboard SCSI. The choice : Enabled/Disabled

CHIPSET FEATURES SETUP This screen controls the setting for the chipset on the mainboard.

ROM PCI/ISA BIOS
CHIPSET FEATURES SETUP
 AWARD SOFTWARE, INC.

Bank 0/1 DRAM Timing	: SDRAM 10ns	Auto Detect DIMM/PCI Clk	: Enabled
Bank 2/3 DRAM Timing	: SDRAM 10ns	Spread Spectrum Modulated	: Disabled
Bank 4/5 DRAM Timing	: SDRAM 10ns	CPU Host/PCI Clock	: Default
Bank 6/7 DRAM Timing	: SDRAM 10ns		
SDRAM Cycle Length	: 3		
DRAM Clock	: 66MHz		
Memory Hole	: Disabled		
Read Around Write	: Disabled		
Concurrent PCI/Host	: Disable		
System BIOS Cacheable	: Disabled		
Video RAM Cacheable	: Disabled		
AGP Aperture Size (MB)	: 64M		
AGP-2x Mode	: Enabled		
OnChip USB	: Disabled		
USB Keyboard Support	: Disabled		
		Esc: Quit	↑↓→← : Select Item
		F1 : Help	PU/PD/+/-: Modify
		F5 : Old Values	(Shift)F2 : Color
		F6 : Load BIOS Defaults	
		F7 : Load Setup Defaults	

Bank 0/1 , 2/3, 4/5 DRAM Timing Each item is for selection of SDRAM speed. Choices are: 10ns, 8ns, Normal, medium, fast and Turbo. In case a faster choice cannot bring about a smooth system run, a slower choice should be taken. Default is the slowest 10ns.

SDRAM Cycle Length There are 3 cycle lengths for choice: 1,2,3.

DRAM Clock This item is for selecting the desired DRAM Clock:
 “Host Clock” means CPU Host Clock is chosen as the DRAM Clock.
 “HClock – 33MHz” means CPU Host Clock – 33MHz is chosen as the DRAM clock.
 “Hclock + 33MHz” means CPU Host Clock + 33MHz is chosen as the DRAM Clock.

Memory Hole A memory block at 15M – 16M is reserved for choice. If “Disabled” is chosen, it means this memory block is not reserved for special use. If “15M-16M” is chosen, it means, this memory block is reserved for other devices.

Read Around write to enable this item will optimize DRAM read & write. If a memory read is addressed to a location where a memory write is held in a buffer content, the memory read will not be sent to DRAM then.

Concurrent PCI/Host Disabled, the CPU bus will be occupied(BPRI asserted) during the entire PCI operation. Enabled, the CPU bus is only requested before ADS# assertion

System BIOS Cacheable Selecting Enabled allows the caching of the system BIOS ROM at F0000h-FFFFFh, resulting in better system performance. However, if any program writes to this memory area, a system error may result.

Video RAM Cacheable Selecting Enabled allows the caching of the video RAM, resulting in better system performance. However, if any program writes to this memory area, a system error may result.

AGP Aperture Size (MB) Select the size of the AGP aperture. The aperture is a portion of the PCI memory address range dedicated for graphics memory address space. Host cycle that hit the aperture range are forwarded to the AGP without any translation. See www.agpforum.org for AGP information. The choice 4, 8, 16, 32, 64, 128, 256.

OnChip USB If “Enabled”, “USB Keyboard Support” will be provided for choice.

USB Keyboard Support If “OnChip USB” is enabled, this item will appear for choice.

Auto Detect DIMM/PCI Clk If this item is enabled, the unused DIMM and PCI slot clock will be disabled. If this item is disabled the unused DIMM and PCI slot will still get the active clock signal.

Spread Spectrum Modulated Enable / Disable this item, the BIOS will Enable / Disable the clock generator spread spectrum .

CPU Host/PCI Clock Use this item to set CPU base clock frequency which includes 68/34MHz, 75/37MHz, 83/41MHz, 66/33MHz, 103/34MHz, 112/37MHz, 133/33MHz, 100/33MHz, 117/39MHz, 117/29MHz, 124/31MHz, 129/32MHz, 138/34MHz and Default.

Note: After you change the CPU Clock Frequency and the system can not start, please do the following procedures:

- 1. Turn the system off firstly.**
- 2. Turn on the system. Then press and hold the “ Insert ” key at boot.**
- 3. Select the proper frequency in the item of *CPU Host/PCI Clock*.**
- 4. Save and Exit Setup.**

POWER MANAGEMENT SETUP This screen controls the 'green' features of this mainboard.

ROM PCI/ISA BIOS
POWER MANAGEMENT SETUP
 AWARD SOFTWARE, INC.

ACPI function	: Enabled	Primary INTR	: On
Power Management	: User Define	IRQ 3 (COM 2)	: Primary
PM Control by APM	: Yes	IRQ 4 (COM 1)	: Primary
Video Off After	: Suspend	IRQ 5 (LPT2)	: Primary
Video Off Method	: V/H SYNC+Blank	IRQ 6 (Floppy Disk)	: Primary
Modem Use IRQ	: 3	IRQ 7 (LPT 1)	: Primary
Soft-Off by PWR-BTTN	: Delay 4 Sec	IRQ 8 (RTC Alarm)	: Disabled
HDD Power Down	: Disabled	IRQ 9 (IRQ2 Redir)	: Secondary
Doze Mode	: Disabled	IRQ 10 (Reserved)	: Secondary
Suspend Mode	: Disabled	IRQ 11 (Reserved)	: Secondary
** PM Events **		IRQ 12 (PS/2 Mouse)	: Primary
VGA	: Off	IRQ 13 (Coprocessor)	: Disabled
LPT & COM	: LPT/COM	IRQ 14 (Hard Disk)	: Primary
HDD & FDD	: On	IRQ 15 (Reserved)	: Disabled
DMA / Master	: Off	Esc: Quit ↑↓→← :Select Item	
Modem Ring Resume	: Disabled	F1 : Help PU/PD/+/- : Modify	
RTC Alarm Resume	: Disabled	F5 : Old Values (Shift) F2: Color	
		F6 : Load BIOS Defaults	
		F7 : Load Setup Defaults	

ACPI function This item is to set the ACPI (Advanced Configuration Power Interface) function enabled or disabled. The default setting is disabled.

Power Management This category allows you to select the type (or degree) of power saving and is directly related to the following modes : **Doze; Standby; Suspend; HDD Power Down.**

Min. Power Saving	Minimum power management. Doze =1hr.; Standby=1hr.; Suspend=1hr.; HDD Power Down=15min
Max. Power Saving	Doze=1min.; Standby=1min.; Suspend=1min.;HDD Power Down=1min
User Define	Allows you to set each mode individually. Each of the ranges is from 1min. to 1hr. except for HDD Power Down which ranges from 1 to 15min.

If you would like to use **Software Power-off Control** function, you should select **“Yes”** in **PM Control by APM**.

PM Control by APM When enabled, an Advanced Power Management mechanism will be activated to enhance the Max. Power Saving Mode and stop the CPU internal clock. If the Max. Power Saving is not enabled, this will be shown as Yes.

Video off After When enabled, this feature allows the VGA adapter to operate in a power saving mode.

N/A	Monitor will remain on during power saving modes.
Suspend	Monitor is blanked when the system enters the Suspend mode.
Doze	Monitor is blanked when the system enters any power saving mode.

Video Off Method This determines the manner in which the monitor is blanked.

V/H SYNC + Blank	This selection will cause the system to turn off the vertical and horizontal sync. ports and write blanks to the video buffer.
Blank Screen	This option only writes blanks to the video buffer.
DPMS Support	Initial of “Display Power Management Signaling”.

Soft-Off by PWR-BTTN *Instant-off* : When push the power button, the system power will be off immediately. *Delay 4 sec* : when push the power button, it will enter suspend mode. We need to push the power button and hold it for 4 seconds to turn off the power.

The Following 3 modes are Green PC power saving functions which are only user configurable when ‘User Define’ power management has been selected.

➤ **Doze Mode** When enabled and after the set time of system inactivity, the CPU clock will run at slower speed while all other devices still operate at full speed.

➤ **Suspend Mode** When enabled and after the set time of system inactivity, all devices except the CPU will be shut off.

➤ **HDD Power Down** When enabled and after the set time of system inactivity, the hard disk drive will be powered down while all other devices remain active.

Modem Ring Resume Enabled: when system is in suspend mode, it can be waked up by modem. Disabled: it cannot be waked up by modem.

PM Events Events included herein are I/O events whose occurrence can prevent the system from entering a power saving mode or can awaken the system from such a mode. In fact, the system remains alert for anything which occurs on a device which is configured as “ON”, even when the system is in a power down mode. When an I/O device wants to gain the attention of the operating system, it signals this need by causing an “**IRQ**” (Interrupt Request) to occur. When the operating system is ready to respond to the request, it interrupts itself and performs the service. When set to “Off”, device activity will neither prevent the system from going into a power management mode nor awaken the system.

The I/O events included herein are:

VGA, LPT & COM, HDD & FDD, DMA/Master, Modem Ring Resume, RTC Alarm Resume.

Primary INTR This item is to provide setting for IRQ3 to IRQ15. If this item is “ON”, you can set the IRQs with three choices: Primary, Secondary, and Disabled,

PNP/PCI CONFIGURATION This screen configures the PCI Bus slots.

ROM PCI/ISA BIOS
PNP/PCI CONFIGURATION
 AWARD SOFTWARE, INC.

PNP OS Installed	: No	CPU to PCI Write Buffer	: Enabled
Resources Controlled by	: Auto	PCI Dynamic Bursting	: Disabled
Reset Configuration Data	: Disabled	PCI Master 0 WS Write	: Enabled
		PCI Delay Transaction	: Disabled
		PCI # 2 Access # 1 Retry	: Disabled
		AGP Master 1 WS Write	: Disabled
		AGP Master 1 WS Read	: Disabled
		Assign IRQ For USB	: Enabled
		Assign IRQ For VGA	: Disabled
		Esc: Quit	↑↓→← :Select Item
		F1 : Help	PU/PD/+/- : Modify
		F5 : Old Values	(Shift) F2: Color
		F6 : Load BIOS Defaults	
		F7 : Load Setup Defaults	

PNP OS Installed This item allows you to determine PnP OS or not. Choices are Yes or No.

Resources Controlled by The Award Plug and Play BIOS has the capability to automatically configure all of the boot and Plug & Play compliant devices. However, this capability means absolutely nothing unless you are using a Plug and Play OS such as Windows 95. Choices are Auto and Manual.

Reset Configuration Data This item allows you to determine whether to reset the configuration data or not.

CPU to PCI Write Buffer Enable/Disable CPU to PCI POST Write.

PCI Dynamic Bursting Enable/Disable PCI burst operation.

PCI Master 0 WS Write Enable : PCI Master 0 wait state mode.
 Disable : PCI Mater 1 wait state mode.

PCI Delay Transaction This chipset has an embedded 32-bit posted write buffer to support deadly transactions cycles. Select Enabled to support compliance with PCI specification version 2.1. The choice : Enabled, disabled space

PCI #2 Access #1 Retry Enable : PCI #2 will be disconnected if max. retries are attempted without success. Disable : PCI #2 will be disconnected until access finished.

AGP Mater 1 WS Write Enable/Disable AGP master one wait state write.

AGP Mater 1 WS Read Enable/Disable AGP master one wait state read.

Assign IRQ for VGA When this items is enabled, the system will assign an IRQ for VGA. If disabled, VGA occupies no IRQ.

Assign IRQ for USB When this item is enabled, the system will assign an IRQ for USB. If disabled, USB occupies no IRQ.

INTEGRATED PERIPHERALS This section page includes all the items of IDE hard drive and Programmed Input/Output features. See also Section “Chipset Features Setup”.

ROM PCI/ISA BIOS
INTEGRATED PERIPHERALS
 AWARD SOFTWARE, INC.

OnChip IDE Channel 0	: Enabled	UART Mode Select	: Normal
OnChip IDE Channel 1	: Enabled	UART2 Duplex Mode	: Half
IDE Prefetch Mode	: Disabled	RxD , TxD Active	: Hi, Lo
Primary Master PIO	: Auto	IR Transmission Delay	: Enabled
Primary Slave PIO	: Auto	Onboard Parallel Port	: 378/IRQ7
Secondary Master PIO	: Auto	Parallel Port Mode	: ECP
Secondary Slave PIO	: Auto	ECP Mode Use DMA	: 3
Primary Master UDMA	: Auto	EPP Mode Select	: EPP1.7
Primary Slave UDMA	: Auto	PWRON After PWR-Fail	: Off
Secondary Master UDMA	: Auto		
Secondary Slave UDMA	: Auto		
Init Display first	: PCI Slot		
Power On Function	: Button Only	Esc: Quit	↑↓→← : Select Item
KBC Input Clock	: 8 MHz	F1 : Help	PU/PD/+/- : Modify
Onboard FDC Controller	: Enabled	F5 : Old Values	(Shift) F2: Color
Onboard Serial Port 1	: 3F8/IRQ4	F6 : Load BIOS Defaults	
Onboard Serial Port 2	: 3F8/IRQ3	F7 : Load Setup Defaults	

OnChip IDE Channel 0; OnChip IDE Channel 1 This setup item allows you to either enable or disable the primary/secondary controller. You might choose to disable the controller if you want to add higher performance or specialized controller.

IDE Prefetch Mode Enable/Disable IDE Read Prefetch Buffer.

Primary Master/Slave PIO; Secondary Master/Slave PIO

PIO - Programmed Input/Output, it allows the BIOS to tell the controller what it wants and then let the controller and the CPU to complete the task by themselves. This is simpler and faster. Your system supports five modes, 0 - 4, which primarily differ in timing. When **Auto** is selected, the BIOS will select the best available mode.

Primary Master/Slave UDMA; Secondary Master/Slave UDMA Auto, will support the Ultra DMA function. Disabled, will not support the Ultra DMA function.

Init Display First If you set this item to PCI Slot, it will activate the PCI video card first in the multi-displayed environment. The choice: PCI Slot, AGP.

Power On Function The following are choices of Power On functions:

- **KB Power On Password:** This function is available with ATX power only. User can power on the system by setting a password via keyboard. Please refer to Page 5 “Password (via Keyboard) for setting the “Password Power-On “ function. If a set password is forgotten or can not be retrieved, please refer to Page 15 “Clear CMOS” to clear old password and set a new one.
- **Hot Key :** This is also an ATX Power supported function. Please refer to Page 5 “Hot Key (via Keyboard)” for setting this Hot Key Power-on function.
- **Mouse Left, Mouse Right :** This is also an ATX Power supported function. Please refer to Page 5 “Mouse Left, Mouse Right (via PS/2 Mouse)” for setting this PS/2 Power-on function. When using this Power-On function to shut or start your computer, your double-clicking the mouse button should not be interfered by any slight move or slide of the mouse.
- **BUTTON ONLY :** Only pressing power button can power the system.

KBC Input Clock Let user change the keyboard working clock.

On Board FDC Controller This item will enable or disable the floppy disk controller.

On Board Serial Port 1 User can select serial port IRQ. If set to Auto, system will assign an IRQ for it. Note : set to Auto is not recommended.

On Board Serial Port 2 User can select serial port IRQ. If set to Auto, system will assign an IRQ for it. Note : set to Auto is not recommended.

UART Mode Select This lets you select the Infrared mode. Choices are Normal, IrDA, and ASKIR. If you choose IrDA or ASKIR mode, the screen will show another two lines to let you choose ‘RxD TxD Active’ (Hi Lo; Lo Hi; Hi Hi; Lo Lo), and ‘IR Transmission Delay’ (Enabled/Disabled).

On Board Parallel Port Let user select IRQ for parallel port. When Disabled, the parallel port will be disabled.

Parallel Port Mode Let user select parallel port protocol. This item is not recommended to change except user has special request.

ECP Mode Use DMA Select a DMA channel for the port. Choices are 3, 1.

EPP Mode Select Let user select EPP version.

PWRON After PWR-Fail When you set “Former State”, this allows you to set whether you want your system to boot up after the power has been interrupted. Otherwise, “Off” leaves your system off after reapplying power.

ROM PCI/ISA BIOS
CMOS SETUP UTILITY
 AWARD SOFTWARE, INC.

STANDARD CMOS SETUP	INTEGRATED PERIPHERALS
BIOS FEATURES SETUP	SUPERVISOR PASSWORD
CHIPSET FEATURES SETUP	USER PASSWORD
POWER MANAGEMENT SETUP	IDE HDD AUTO DETECTION
PNP/PCI CONFIGURATION	SAVE & EXIT SETUP
LOAD BIOS DEFAULTS	EXIT WITHOUT SAVING
LOAD SETUP DEFAULTS	
ESC: Quit	↑↓→←:Select Item
F10: Save & Exit Setup	(Shift) F2 : Change Color
Time, Date, Hard Disk Type	

ROM PCI/ISA BIOS
CMOS SETUP UTILITY
 AWARD SOFTWARE, INC.

Hard Disks	Type	Size	CYLS	HEAD	PRECOMP	LANDZ	SECTOR	MODE
Primary Master :								
Select Primary Master Option (N=Skip) : N								
	Options	Size	CYLS	Head	PRECOMP	LANDZ	Sector	Mode
	2(Y)	1337	648	64	0	2594	63	LBA
	1	1339	2595	16	65535	2594	63	NORMAL
	3	1338	1297	32	65535	2594	63	LARGE
Note : Some OSes (like SCO-UNIX) must use "Normal" for installation								
ESC : Skip								

The last second item of the main menu is 'save and exit'. If you select this item and press 'Y', then these records will be saved in the CMOS memory on the mainboard. It will be checked every time you turn your computer on.

ROM PCI/ISA BIOS
CMOS SETUP UTILITY
 AWARD SOFTWARE, INC.

STANDARD CMOS SETUP BIOS FEATURES SETUP CHIPSET FEATURES SETUP POWER MANAGEMENT SETUP PNP/PCI CONFIGURATION LOAD BIOS DEFAULTS LOAD SETUP DEFAULTS	INTEGRATED PERIPHERALS SUPERVISOR PASSWORD USER PASSWORD IDE HDD AUTO DETECTION SAVE & EXIT SETUP EXIT WITHOUT SAVING
ESC: Quit F10: Save & Exit Setup	↑↓→←:Select Item (Shift) F2 : Change Color
Time, Date, Hard Disk Type	

ROM PCI/ISA BIOS
CMOS SETUP UTILITY
 AWARD SOFTWARE, INC.

STANDARD CMOS SETUP BIOS FEATURES SETUP CHIPSET FEATURES SETUP POWER MANAGEMENT SETUP PNP/PCI CONFIGURATION LOAD BIOS DEFAULTS	INTEGRATED PERIPHERALS SUPERVISOR PASSWORD USER PASSWORD IDE HDD AUTO DETECTION SAVE & EXIT SETUP <div style="border: 1px solid black; background-color: #cccccc; padding: 2px; margin-top: 5px;"> SAVE to CMOS and EXIT (Y/N):Y </div>
ESC: Quit F10: Save & Exit Setup	↑↓→←:Select Item (Shift) F2 : Change Color
Save Data to CMOS & Exit SETUP	

LOAD BIOS DEFAULTS When your mainboard has problems and needs to trouble shoot the system, you can use this function. The default values loaded only affect the BIOS Features Setup, Chipset Features Setup, Power Management Setup and PNP/PCI Configuration Setup. There is no effect on the Standard CMOS Setup. To use this function, select it from main menu and press <Enter>. A line will appear on the screen asking if you want to load the BIOS default values. Press <Yes> and <Enter> then the BIOS default values will be loaded.

LOAD SETUP DEFAULTS This allows you to load optimal settings which are stored in the BIOS ROM. The default values loaded only affect the BIOS Features Setup, Chipset Features Setup, Power Management Setup and PNP/PCI Configuration Setup. There is no effect on the Standard CMOS Setup. To use this function, select it from main menu and press <Enter>. A line will appear on the screen asking if you want to load the Setup default values. Press <Yes> and <Enter> then the Setup default values will be loaded.

SUPERVISOR PASSWORD / USER PASSWORD This allows you to set the password. The mainboard defaults with password disabled. If you set both supervisor and user passwords, only the supervisor password allows you to enter the BIOS SETUP program.

Enter/Change password : Enter the current password. And at the prompt, key-in your new password (up to eight alphanumeric characters), then press <Enter>. At the next prompt, confirm the new password by typing it again and press <Enter>.

Disable password : Press the <Enter> key instead of entering a new password when the 'Enter Password' dialog box appears. A message will appear for confirming that the password is disabled.



CAUTION: If you forget your password, you must clear CMOS first and restart system in order to set up password again. See "Clear CMOS" on Page 15.

IDE HDD AUTO DETECTION This allows you to detect the IDE hard disk driver's parameters and enter them into 'Standard CMOS Setup' automatically. If the auto-detected parameters displayed do not match the ones that should be used for your hard drive, do not accept them. Press <N> to reject the values and enter the correct ones manually on the Standard CMOS Setup screen.

SAVE & EXIT SETUP This allows you to save the new setting values in the CMOS memory and continue with the booting process. Select what you want to do, press <Enter>.

EXIT WITHOUT SAVING This allows you to exit the BIOS setup utility without recording any new values or changing old ones.

※ Control Key Description ※

UP ARROW	↑	Move to previous item
DOWN ARROW	↓	Move to next item
LEFT ARROW	←	Move to the item in the left hand
RIGHT ARROW	→	Move to the item in the right hand
Esc KEY	Esc	Main Menu : Quit and not save changes Setup menu : Exit current page and return to main menu
PgUp KEY		Increase the numeric value or make changes
PgDn KEY		Decrease the numeric value or make changes
F1 KEY	Help	General help
F2 KEY	< Shift > +F2	Change color from total 16 colors
F5 KEY	Old Value	Restore the pervious CMOS value from CMOS
F6 KEY	Load BIOS default	Load the default CMOS value from BIOS default table
F7 KEY	Load setup default	Load Setup default
F10 KEY	Save & Exit Setup	Save all the CMOS changes and Exit setup, only for Main Menu