



apricot

FT2200

System Guide



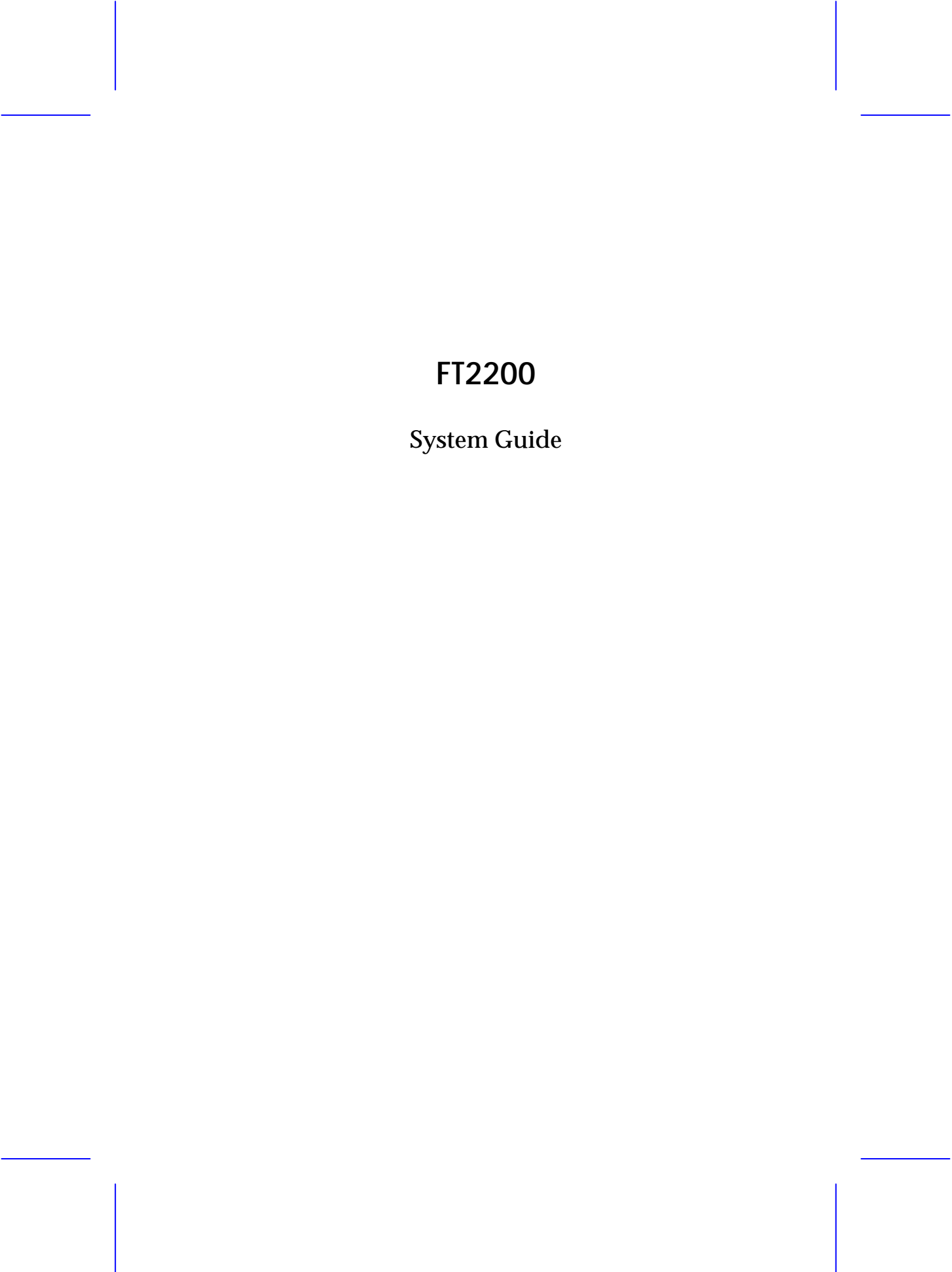

FT2200

System Guide

Intel is a registered trademark of Intel Corporation.

Pentium Pro is a trademark of Intel Corporation.

Other brand and product names are trademarks and/or registered trademarks of their respective holders.

Information contained in this document is subject to change without notice and does not represent a commitment on the part of Apricot Computers Limited. The software described in this manual is furnished under a license agreement. The software may be used or copied only in accordance with the terms of this agreement.

It is against the law to copy any disk supplied for any other purpose than the purchaser's personal use.

All rights reserved; no use or disclosure without written consent.

Copyright © 1996

Published by:
Apricot Computers Limited
3500 Parkside
Birmingham Business Park
B37 7YS

<http://www.apricot.co.uk>



Printed in the United Kingdom

Part no. 15760431 Rev 01

IMPORTANT SAFETY INSTRUCTIONS

1. Read these instructions carefully. Save these instructions for future reference.
2. Follow all warnings and instructions marked on the product.
3. Unplug this product from the wall outlet before cleaning. Do not use liquid cleaners or aerosol cleaners. Use a damp cloth for cleaning.
4. Do not use this product near water.
5. Do not place this product on an unstable cart, stand, or table. The product may fall, causing serious damage to the product.
6. Slots and openings in the cabinet and the back or bottom are provided for ventilation; to ensure reliable operation of the product and to protect it from overheating, these openings must not be blocked or covered. The openings should never be blocked by placing the product on a bed, sofa, rug, or other similar surface. This product should never be placed near or over a radiator or heat register, or in a built-in installation unless proper ventilation is provided.
7. This product should be operated from the type of power indicated on the marking label. If you are not sure of the type of power available, consult your dealer or local power company.
8. This product is equipped with a 3-wire grounding-type plug, a plug having a third (grounding) pin. This plug will only fit into a grounding-type power outlet. This is a safety feature. If you are unable to insert the plug into the outlet, contact your electrician to replace your obsolete outlet. Do not defeat the purpose of the grounding-type plug.

-
9. Do not allow anything to rest on the power cord. Do not locate this product where persons will walk on the cord.
 10. If an extension cord is used with this product, make sure that the total ampere rating of the equipment plugged into the extension cord does not exceed the extension cord ampere rating. Also, make sure that the total rating of all products plugged into the wall outlet does not exceed 15 amperes.
 11. Never push objects of any kind into this product through cabinet slots as they may touch dangerous voltage points or short out parts that could result in a fire or electric shock. Never spill liquid of any kind on the product.
 12. Do not attempt to service this product yourself, as opening or removing covers may expose you to dangerous voltage points or other risks. Refer all servicing to qualified service personnel.
 13. Unplug this product from the wall outlet and refer servicing to qualified service personnel under the following conditions:
 - a. When the power cord or plug is damaged or frayed
 - b. If liquid has been spilled into the product
 - c. If the product has been exposed to rain or water
 - d. If the product does not operate normally when the operating instructions are followed. Adjust only those controls that are covered by the operating instructions since improper adjustment of other controls may result in damage and will often require extensive work by a qualified technician to restore the product to normal condition.
 - e. If the product has been dropped or the cabinet has been damaged
 - f. If the product exhibits a distinct change in performance, indicating a need for service

-
14. Use only the proper type of power supply cord set (provided in your keyboard/manual accessories box) for this unit. It should be a detachable type: UL listed/CSA certified, type SVT/SJT, rated 6A 125V minimum, VDE approved or its equivalent. Maximum length is 15 feet (4.6 meters).

15. The computer uses a safety ground and must be earthed.

The system unit AC power cord is its 'disconnect device'. Ensure that the system unit is positioned close to the AC power outlet and that the plug is easily accessible. The power cord packed with the computer complies with the safety standards applicable in the country in which it is first sold. Use only this power cord. Do not substitute a power cord from any other equipment.

To prevent fire and electric shock, do not expose any part of the computer to rain or moisture and turn off the computer and unplug all power cords before moving or cleaning the system unit, or removing the system top cover.

16. Any CD-ROM drive fitted in this system is classified as a CLASS 1 LASER PRODUCT according to IEC825 Radiation Safety of Laser Products (Equipment Classification: Requirements and User's Guide). The CLASS 1 LASER PRODUCT label is located on the rear of the system unit.

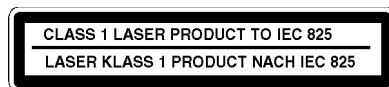

It will be in high visibility colours and bear the details shown above.

Use the CD-ROM drive only as described in this manual. Failure to do so may result in exposure to hazardous radiation.

17. When positioning the system unit, monitor and keyboard, take into account any local or national regulations relating to ergonomic requirements.

18. This product complies with the European safety standard EN60950 and when applicable, will include the national deviations for the country in which it is sold.

19. This product complies with the following European EMC standards:

Emissions EN55022 Class A

Immunity EN50082 Level 1

This product also complies with the following International EMC standards:

VCCI level 1 (Japan)

The applicable standards for the country of sale will be shown on the label fixed to the rear of the system.

20. All interconnecting cables (e.g. Microphone, headphone and speaker) and communication cables should be less than 2 metres in length. If cable extensions are used, ensure adequate earth connections are provided and screened cables are used.

21. This equipment complies with the relevant clauses of following European Directives:

Low voltage Directive 73/23/EEC

EMC Directive 89/336/EEC

CE marking Directive 93/668/EEC

Caution: This system has been tested to comply with CE marking and its strict legal requirements. Use only Apricot tested and approved parts. Failure to do so may result in invalidating both the compliance and your warranty. All expansion cards must carry CE approvals.

22. Power connection information

Typical AC plugs:

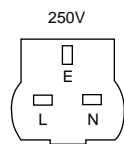

BS1363A

United Kingdom

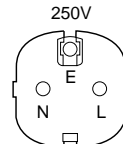

SHUCO

Austria Belgium
Finland France
Germany Holland
Italy Norway
Sweden

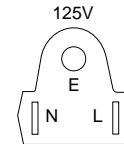

NEMA 5-15P

Taiwan
Thailand
USA
Canada

Procedure:

Note: Any ancillary equipment using an AC power supply cable should be earthed.

The power supplies in the computer and the monitor are correct for the country in which the system is first sold. Do not alter any switch settings on the rear of the system. If you wish to use the computer in another country it may not be suitable, contact your supplier or an authorised Apricot dealer.

- Before connecting up any parts of the system, ensure that the AC supply is switched off or disconnected.
- First connect up the keyboard, mouse, monitor signal cable, and audio cables as appropriate.

-
- Connect up **all** AC cables. (System to supply, system to monitor, all related peripherals.) Then switch on or connect the AC supply.
 - Switch on the monitor first, then the computer followed by the peripherals, such as printer or speakers.
 - If the monitor AC lead is connected to the computer AC outlet, when you come to switch off, the computer power button will switch off the monitor at the same time.

23. Power Cable Connections - UK ONLY

This equipment is supplied with an AC power lead that has a non-removable moulded plug.

Always replace the fuse with one of the same type and rating which is BSA or ASTA approved to BS1362. Always refit the fuse cover, never use the plug with the fuse cover omitted.

24. German Acoustic Noise Regulation: Sound power level is less than 70 dB(A) according to DIN 45635 Part 19 (ISO 7779).

Die Deutsche Akoustische Lärm-Regulierung: Der Grad der Klangstärke ist weniger als 70 dB (A) je nach DIN 45635 Teil 19 (ISO 7779).

About this Manual

Purpose

This system guide aims to give you all the necessary information to enable you to set up and operate the system.

Manual Structure

This system guide consists of five chapters.

Chapter 1 System Introduction

This chapter generally describes the system's unique features and powerful architecture. It includes a brief introduction of the new generation Intel Pentium Pro CPU that forms the heart of the system.

Chapter 2 Setting Up the System

This chapter helps you get started. It illustrates how to prepare the system for installation, connect the cables, and startup the system.

Chapter 3 System Configuration

This chapter describes the six major system components that include the system housing, system board, memory board, front panel board, disk-array backplane boards, and power supply.

Chapter 4 BIOS Utility

This chapter explains the BIOS parameter functions. It tells how to configure the system by setting the parameters.

Chapter 5 Diagnostics and Utilities

This chapter describes how to use the EISA Configuration Utility.

Conventions

The following are the conventions used in this manual:

Text entered by user

Represents text input by the user.

Screen messages

Denotes actual messages that appear onscreen.

a, e, s, etc.

Represent the actual keys that you have to press on the keyboard.



NOTE

Gives bits and pieces of additional information related to the current topic.



WARNING

Alerts you to any damage that might result from doing or not doing specific actions.



CAUTION

Gives precautionary measures to avoid possible hardware or software problems.



IMPORTANT

Reminds you to do specific actions relevant to the accomplishment of procedures.



TIP

Tells how to accomplish a procedure with minimum steps through little shortcuts.

Table of Contents

Chapter 1 System Introduction

1.1	Features	1-1
1.1.1	Intel Pentium Pro Microprocessor	1-1
1.1.2	System Architecture	1-3
1.1.3	SCSI Disk Array	1-5
1.2	External Configuration.....	1-6
1.2.1	Front Panel.....	1-6
1.2.2	Rear Panel	1-8

Chapter 2 Setting Up the System

2.1	Pre-installation Requirements	2-1
2.1.1	Selecting a Site	2-1
2.1.2	Checking the Package Contents.....	2-2
2.1.3	Transporting the System	2-3
2.1.4	Positioning the System Unit	2-4
2.2	Basic Connections	2-6
2.2.1	Keyboard.....	2-6
2.2.2	Mouse	2-7
2.2.3	VGA Monitor.....	2-8
2.2.4	Printer.....	2-9
2.2.5	Power Cables.....	2-10
2.3	System Startup.....	2-11
2.3.1	Turning On the System Power	2-11
2.4	Power-on Problems.....	2-13

Chapter 3 System Configuration

3.1	System Housing	3-1
3.1.1	Internal Structure	3-2
3.1.2	Opening the Housing Panels.....	3-3
3.1.3	ESD Precautions	3-6
3.1.4	Installing External Devices	3-6
3.1.5	Installing a Hot-swappable SCSI Drive.....	3-11
3.1.6	Installing an Expansion Board.....	3-16
3.2	System Board.....	3-18
3.2.1	Layout.....	3-18
3.2.2	Jumpers and Connectors	3-19
3.2.3	Installing a Pentium Pro CPU.....	3-24
3.3	Memory Board.....	3-26
3.3.1	Layout.....	3-26
3.3.2	Rules for Adding Memory	3-26
3.3.3	Memory Configurations	3-27
3.3.4	Installing a SIMM.....	3-28
3.3.5	Removing a SIMM.....	3-29
3.3.6	Installing the Memory Board.....	3-30
3.3.7	Reconfiguring the System	3-32
3.4	SCSI Disk Array Backplane Board	3-33
3.4.1	Features	3-33
3.4.2	Layout.....	3-34
3.4.3	Jumper Settings	3-35
3.4.4	SCSI Hard Disk ID Feature	3-36
3.4.5	Channel Configuration.....	3-37

Chapter 4 BIOS Utility

4.1	Entering Setup	4-2
4.2	Basic System Configuration	4-3
4.2.1	Date and Time	4-4
4.2.2	Diskette Drives	4-5
4.2.3	Hard Disk Drives	4-6
4.2.4	System Memory	4-7
4.2.5	Math Coprocessor	4-7
4.2.6	Video Display	4-8
4.2.7	Communication Settings	4-8
4.2.8	Enhanced IDE Features	4-9
4.2.9	Num Lock After Boot	4-9
4.2.10	Memory Test	4-10
4.2.11	Auto Configuration Mode	4-10
4.2.12	Fast Boot Mode	4-10
4.3	Advanced System Configuration	4-11
4.3.1	Shadow RAM	4-12
4.3.2	L1 and L2 Cache (CPU Cache)	4-12
4.3.3	Memory at 15MB-16MB	4-13
4.4	System Security Setup	4-14
4.4.1	Disk Drive Control	4-14
4.4.2	Onboard Communication Ports	4-16
4.4.3	Onboard PS/2 Mouse (IRQ12)	4-18
4.4.4	Setup Password	4-19
4.4.5	Power On Password	4-20

4.5	PCI System Configuration	4-21
4.5.1	PCI IRQ Setting.....	4-21
4.5.2	VGA Palette Snoop	4-22
4.5.3	Onboard SCSI	4-22
4.6	Non-PnP ISA Card Configuration	4-23
4.6.1	IRQ/DMA	4-25
4.6.2	Expansion ROM Region	4-25
4.6.3	I/O Region	4-25
4.6.4	Local Memory Region	4-25
4.7	Load Setup Default Settings.....	4-26
4.8	Leaving Setup	4-27

Chapter 5 Diagnostics and Utilities

5.1	EISA Configuration Utility v3.0	5-1
5.1.1	Functions.....	5-1
5.1.2	Making Menu Selections	5-2
5.1.3	Getting Help	5-3
5.1.4	Program Menus.....	5-4
5.1.5	Configuring Your Computer for the First Time	5-6
5.1.6	Adding or Removing Boards	5-10
5.1.7	Viewing or Editing Configuration Details ..	5-12
5.2	Remote Diagnostic Management	5-15

List of Figures

1-1	Pentium Pro CPU Architecture	1-2
1-2	System Architecture	1-3
1-3	Front Panel	1-6
1-4	Rear Panel.....	1-8
2-1	Transporting the System	2-3
2-2	Feet Positioning for a Standalone System	2-4
2-3	Feet Positioning for a System Standing Against a Wall	2-5
2-4	Connecting a Keyboard.....	2-6
2-5	Connecting a Mouse.....	2-7
2-6	Connecting a VGA Monitor.....	2-8
2-7	Connecting a Printer.....	2-9
2-8	Power Cables	2-10
2-9	Opening the Upper Front Panel.....	2-11
2-10	System Power On.....	2-12
3-1	System Housing	3-1
3-2	System Internal Components	3-2
3-3	Opening the Upper Front Panel.....	3-3
3-4	Opening the Lower Front Panel.....	3-4
3-5	Opening the Left Panel.....	3-5
3-6	Removing the Upper Front Panel	3-7
3-7	Attaching a 3.5-inch Diskette Drive on the Frame	3-8
3-8	Installing a 3.5-inch Diskette Drive	3-8

List of Figures (continued)

3-9	Attaching the Metal Guides to a CD-ROM Drive	3-9
3-10	Installing a 5.25-inch External Device.....	3-10
3-11	Unlocking the Drive Tray Switch.....	3-11
3-12	Pulling Out a Hot-swap Drive Tray	3-12
3-13	Connecting the Drive Cables (Wide SCSI Drive).....	3-13
3-14	Connecting the Drive Cables (Narrow SCSI Drive).....	3-13
3-15	Installing a Hot-swap Drive Tray.....	3-14
3-16	Locking the Drive Tray Switch	3-15
3-17	Removing a Bracket Cover.....	3-16
3-18	Installing an Expansion Board	3-17
3-19	System Board Layout	3-18
3-20	Jumper and Connector Locations.....	3-19
3-21	VRM Settings for CPU1 (3.3V for 200 MHz).....	3-21
3-22	VRM Settings for CPU2 (3.3V for 200 MHz).....	3-21
3-23	Clock Frequency Ratio Setting (CN15).....	3-23
3-24	Attaching the Heat Sink to the CPU.....	3-24
3-25	Installing a Pentium Pro CPU	3-25
3-26	Memory Board Layout	3-26
3-27	Installing a SIMM	3-28
3-28	Removing a SIMM	3-29
3-29	Inserting the Memory Board	3-30
3-30	Attaching the Board Holding Clamp.....	3-31
3-31	SCSI Disk Array Backplane Board	3-34
3-32	Jumper Settings.....	3-35

List of Figures (continued)

3-33	Single-Channel Configuration.....	3-37
3-34	Dual-Channel Configuration	3-39
5-1	ECU Main Menu	5-3
5-2	Steps in Configuring Your Computer.....	5-4
5-3	Maintain Configuration Diskette.....	5-5
5-4	Important EISA Configuration Information.....	5-6
5-5	Examine Switches or Print Report.....	5-7
5-6	Save and Exit	5-9
5-7	Add or Remove Boards	5-11
5-8	View or Edit Details	5-13

List of Tables

1-1	LED Indicator Description.....	1-7
3-1	Jumper Settings.....	3-20
3-2	Voltage Identification Codes.....	3-22
3-3	Connector Functions	3-23
3-4	Memory Configurations	3-27
3-5	SCSI ID Settings.....	3-36
4-1	Drive Control Settings.....	4-15
4-2	Serial Port 1 Settings.....	4-16
4-3	Serial Port 2 Settings.....	4-16
4-4	Parallel Port Settings.....	4-17
4-5	Parallel Port Operation Mode Settings	4-18
5-1	Keyboard Function Keys	5-2

System Introduction

1.1 Features

This powerful 64-bit dual-processor system is loaded with a host of new and innovative features. It offers a new standard for flexible productivity ideal for local area networks and multiuser server environments.

1.1.1 Intel Pentium Pro Microprocessor

The Intel Pentium Pro CPU is the heart of the system. Designed to work with the Orion chipset composed of a PCI bridge and memory controller, the Pentium Pro running at up to 200 MHz carries a new generation of power not present in its predecessors.

The system board has two CPU sockets to accommodate up to two Intel Pentium Pro CPUs for a dual-processor configuration. This configuration doubles efficiency and reliability thereby upgrading overall system performance. The Pentium Pro supports a wide range of applications running under operating systems such as DOS, Windows, WindowsNT, OS/2, UNIX, and NetWare.

The CPU also incorporates the first-level (L1) and second-level (L2) caches, the advanced peripheral interrupt controller (APIC), and the system bus controller. Figure 1-1 shows the CPU architecture.

First-level and Second-level Cache

The Pentium Pro has a 16-KB first-level and 256/512-KB second-level cache. These caches produce a high hit rate that reduces the processor's external memory bandwidth requirements.

Advanced Peripheral Interrupt Controller (APIC)

The APIC unit inside the CPU along with the I/O APIC unit facilitate multiprocessor interrupt management. The APIC works with multiple I/O subsystems where each subsystem have its own interrupts that help minimize centralized system overhead.

Bus Controller

The bus controller integrated in the Pentium Pro CPU controls the system bus to make it perform its functions efficiently. It ensures that the bus serves as a reliable interconnection between one or two CPUs, I/O bridge, and memory controllers.

Pentium Pro CPU Architecture

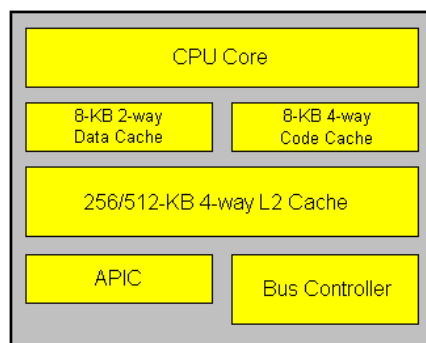

Figure 1-1 Pentium Pro CPU Architecture

1.1.2 System Architecture

The system bus, PCI buses, EISA bus, Orion PCI bridge (OPB), Orion memory controller (OMC), PCI/EISA Bridge (PCEB), and EISA system controller (ESC) comprise the basic system architecture.

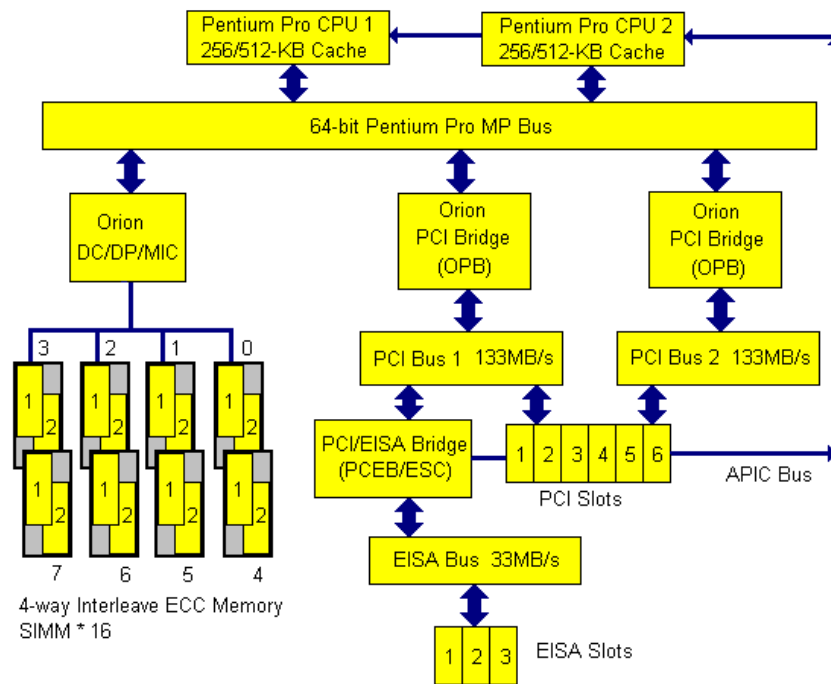

Figure 1-2 System Architecture

System Bus

The system bus is the CPU's major connection to all the system devices, primarily the PCI and EISA bridges, and the memory controllers. It can handle as many as eight outstanding transactions at a time through the transaction pipelining feature in which consecutive tasks from the CPU are queued in and transported to the designated devices on a first-in first-out basis. Pipelining allows for transaction overlapping in different phases as the CPU does not have to wait for each transaction to complete before it issues the next transaction. This produces significant improvement on overall system performance.

The bus architecture supports a number of features that ensure high reliability. It has an 8-bit error correction code (ECC) that protects the data lines and a 2-bit parity code that protects the address lines.

The bus uses the gunning transceiver logic (GTL+), a synchronous latched bus protocol that simplifies timing constraints. This protocol supports higher frequency system designs but requires a low voltage that reduces electromagnetic interference (EMI) resulting to a lower power consumption.

PCI and EISA Buses

The system supports two PCI buses created by the two PCI bridge chipsets (OPB). The PCI buses serve as the links between the PCI bridges and the PCI devices onboard.

The EISA bus connects the EISA devices to the other system devices through the PCI/EISA bridge (PCEB) and the EISA system controller (ESC). The use of the PCEB and ESC maintains compatibility with the EISA environment.

Orion PCI Bridge

The Orion PCI bridge (OPB) is a low-cost I/O subsystem solution for high-performance systems. The OPB translates transactions between the system bus and the PCI buses using 32-byte buffers for inbound and outbound postings. The use of two OPBs in the system creates an architecture that allows faster data transfers.

Orion Memory Controller

The Orion memory controller (OMC) acts as an interface between the system bus and the system memory. It consists of the DRAM control (DC) chip and the data path (DP) chip. The OMC relates to the DRAM array through four memory interface controller (MIC) chips. The OMC supports 256-bit 4-way memory interleaving resulting to a more efficient memory traffic management.

1.1.3 SCSI Disk Array

The system supports an array of eight hot-swappable disk drive trays through an 8-slot SCSI backplane board. The trays accommodate wide and narrow SCSI hard disks. With the AIC-7880 SCSI controller onboard, the transfer rate reaches up to 40 MB per second for ultra SCSI and 20 MB per second for wide SCSI.

1.2 External Configuration

1.2.1 Front Panel

The system front panel is divided into two sections. The upper front panel consists of the diskette/CD-ROM/tape drive bays, power switch, LED indicators, and an embedded reset switch.

The lower part contains the externally accessible hard disk drive bays with eight drive trays for narrow or wide SCSI disk drives. (The basic system may only have a 3.5-inch diskette drive and a CD-ROM drive and no SCSI hard disks installed.)

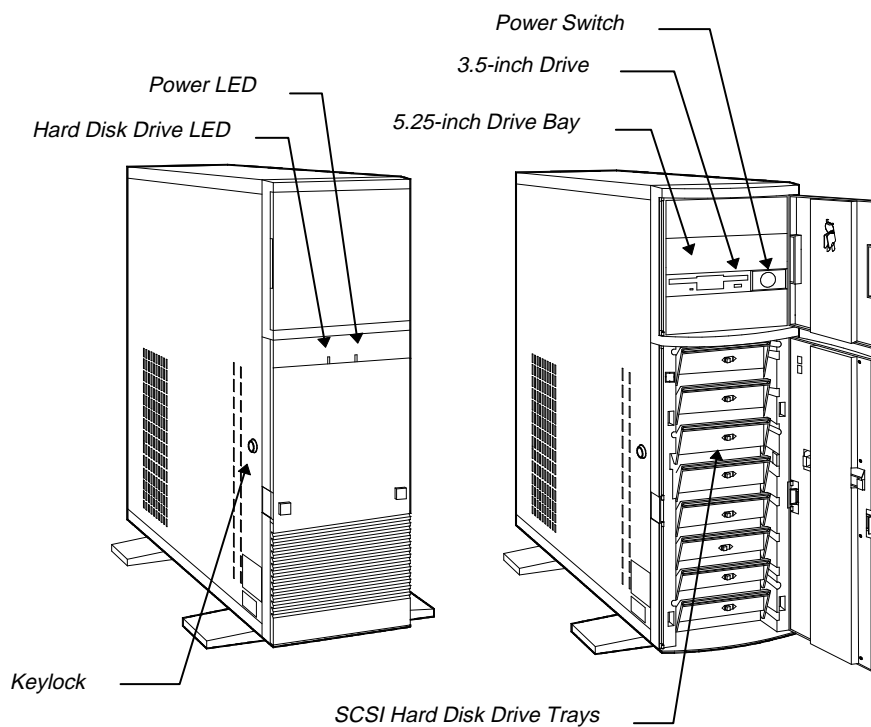

Figure 1-3 Front Panel

Front Panel Features

CD-ROM Drive

The basic system comes with a CD-ROM drive already installed.

3.5-inch Diskette Drive

A 3.5-inch diskette drive also comes with the basic system.

5.25-inch Drive Bays

Two empty 5.25-inch drive bays allow installation of additional devices.

Power Switch



The power switch allows you to turn the system power on or off.

Keylock

The system housing comes with mechanical security lock on the left panel preventing unauthorized access to the internal components.

LED Indicators

Table 1-1 LED Indicator Description

LED Icons	Description
Power Status 	Indicates that power is on. All the power supply modules are in good condition and the system is running on AC power.
Hard Disk Busy 	Indicates that at least one of the hard disks is currently accessing.

1.2.2 Rear Panel

The rear panel includes the connectors for the keyboard, mouse, VGA monitor, printer, and serial devices. Beside the connectors are the monitor and power sockets. On the lower section are the slot openings for expansion boards.

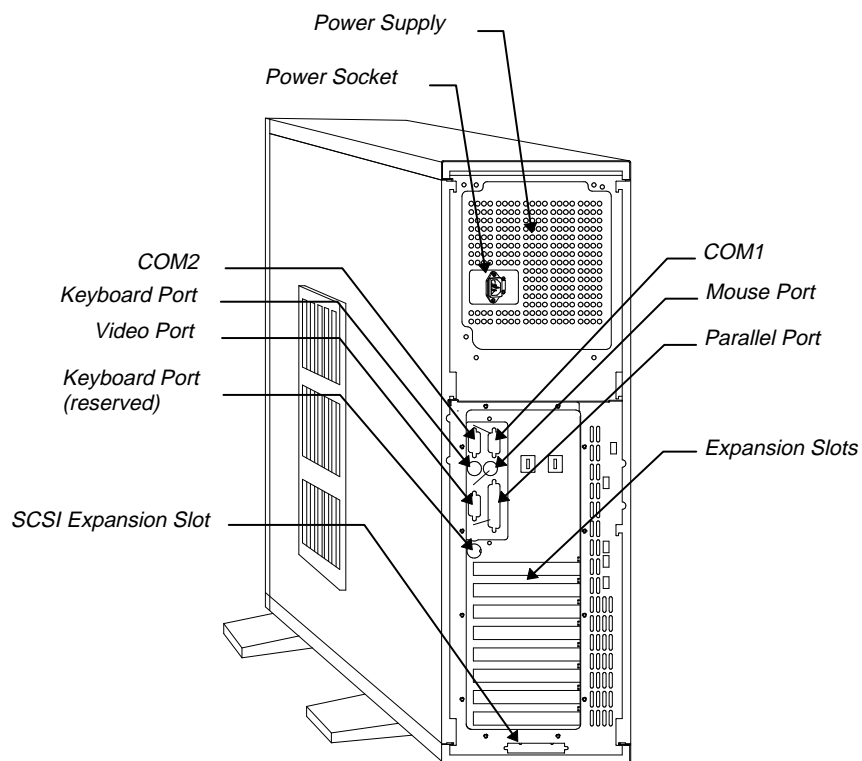

Figure 1-4 Rear Panel

Setting Up the System

This chapter tells how to install and set up the system. It gives instructions on how to select a site for the system, prepare the system for use, connect basic peripherals, and start up the system.

2.1 Pre-installation Requirements

2.1.1 Selecting a Site

Before unpacking and installing the system, select a suitable site for the system for maximum efficiency. The system is suitable to set up in an office environment.

Consider the following factors when choosing a site for the system:

- Near a grounded power outlet
- Clean and dust-free
- Sturdy surface free from vibration
- Well-ventilated and away from sources of heat
- Secluded from electromagnetic fields produced by electrical devices such as air conditioners, radio and TV transmitters, etc.

2.1.2 Checking the Package Contents

Check the following items from the package:

- System Unit
- System Guide
- EISA Configuration Utility
- VGA Manual and Driver Kit
- SCSI Manuals and Driver Kit

If any of the above items is damaged or missing, contact your dealer immediately.

Save the boxes and packing materials for future use.

2.1.3 Transporting the System

The system housing has a handle on top and two wheels behind the feet to facilitate moving to short distances.

When transporting the system, pull out the handle, at the same time lifting the unit front a few inches from the ground. Slide the unit forward with the wheels supporting the rear.

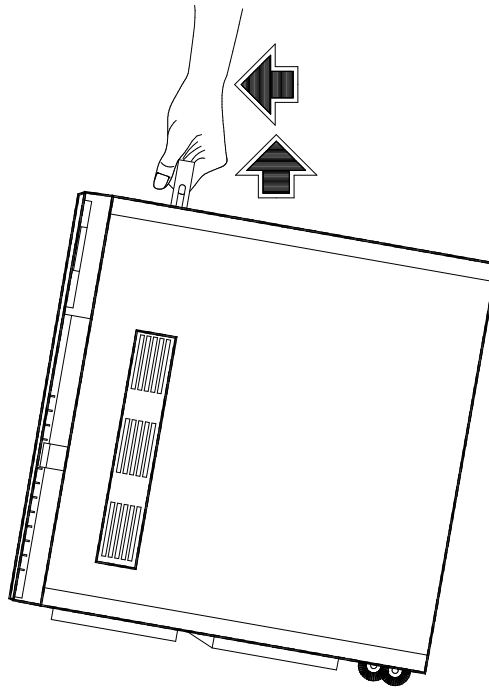

Figure 2-1 Transporting the System

2.1.4 Positioning the System Unit

Before you begin setting up the system, position the system unit either as a standalone or against a wall so it is stable when you connect the cables.

For a standalone system, rotate the feet outward as in Figure 2-2.

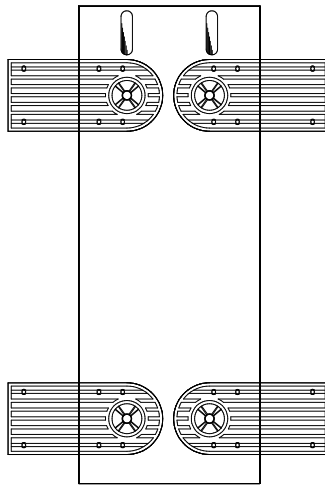

Figure 2-2 Feet Positioning for a Standalone System

If, due to space constraints, you have to put the system close to a wall, you may position it with the fan facing the wall or the fan facing out.

When standing the system with the fan facing a wall, leave a space of 5~10 cm from the wall to allow air circulation, then position the feet as in Figure A.

When standing the system with the fan facing out, you can stand it closer to the wall and position the feet as in Figure B.

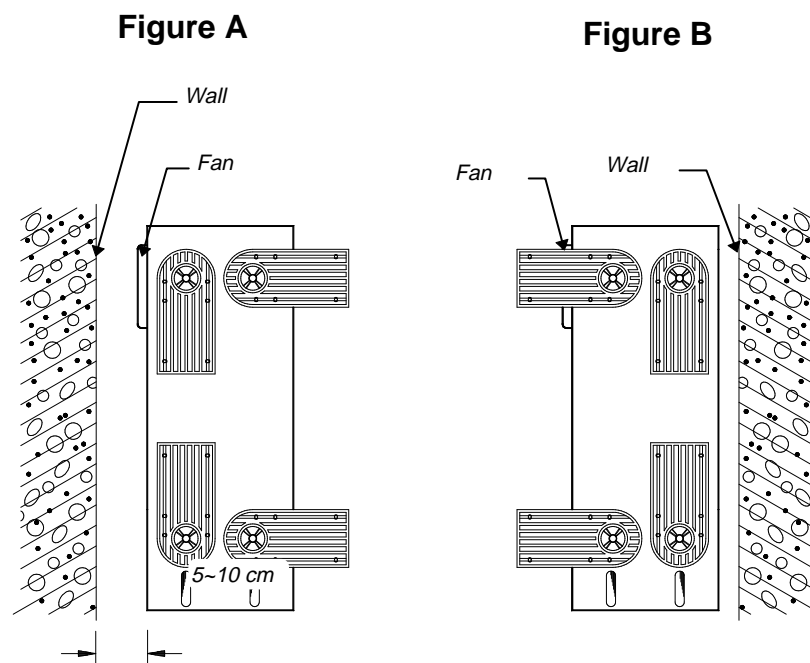

Figure 2-3 Feet Positioning for a System Standing Against a Wall

2.2 Basic Connections

The system unit, keyboard, mouse, and monitor constitute the basic system. Before connecting any other peripherals, connect these peripherals first then apply power to test the basic system if it is running properly.

2.2.1 Keyboard

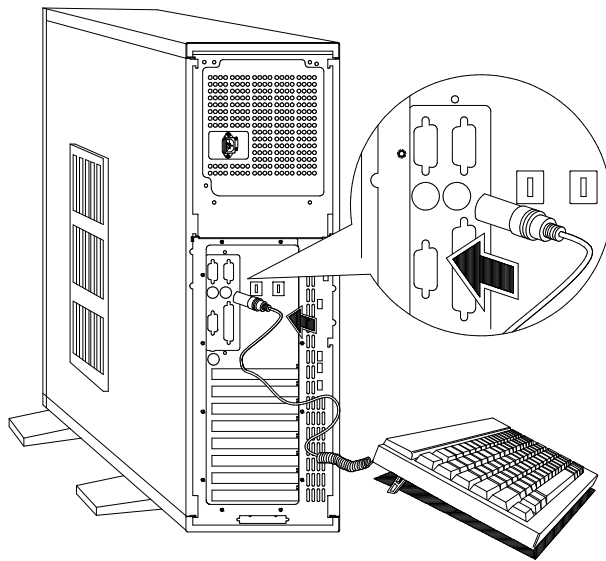

Figure 2-4 Connecting a Keyboard

2.2.2 Mouse

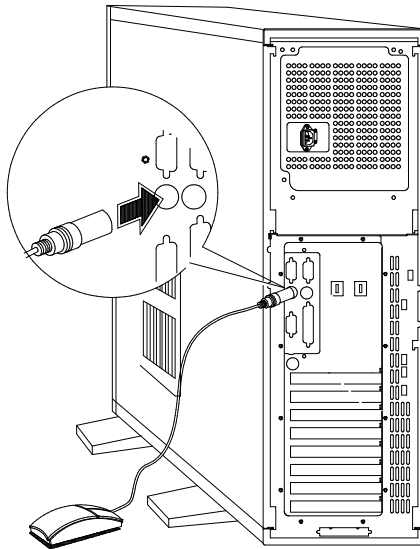

Figure 2-5 Connecting a Mouse

2.2.3 VGA Monitor

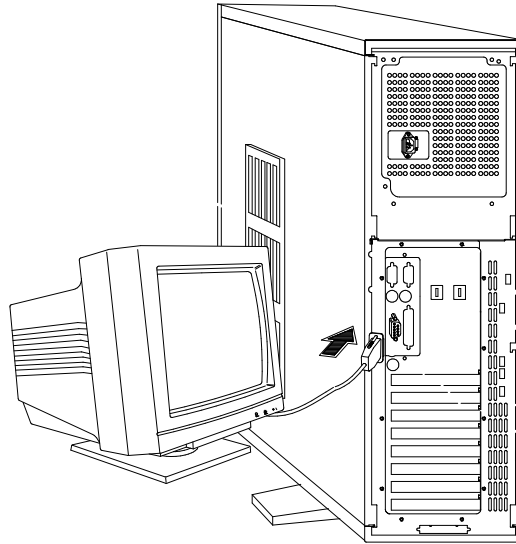

Figure 2-6 Connecting a VGA Monitor

2.2.4 Printer

Should you need to connect a printer to the system in the future, attach the printer cable to the parallel port on the rear panel as in Figure 2-7.

Connecting a printer is optional.

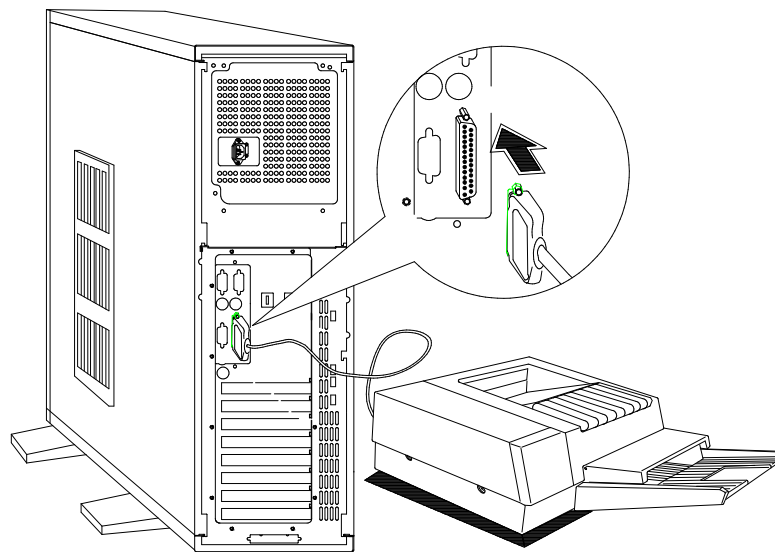

Figure 2-7 Connecting a Printer

2.2.5 Power Cables

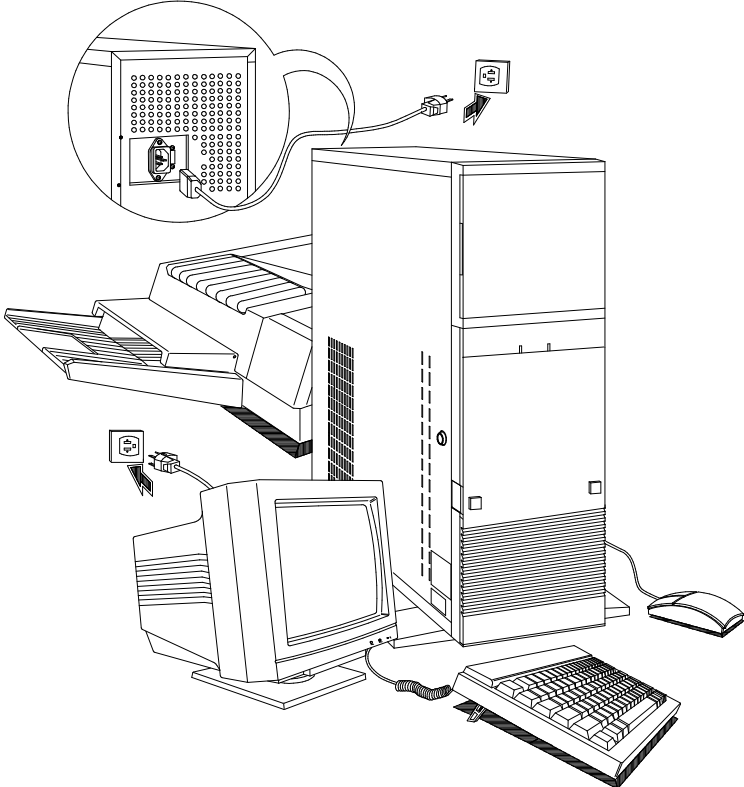

Figure 2-8 Power Cables

2.3 System Startup

After making sure that you have set up the system properly and connected all the required cables, you may now apply power to the system.

2.3.1 Turning On the System Power

The power switch is inside the upper front panel. Hold the right edge of the upper front panel to open it.

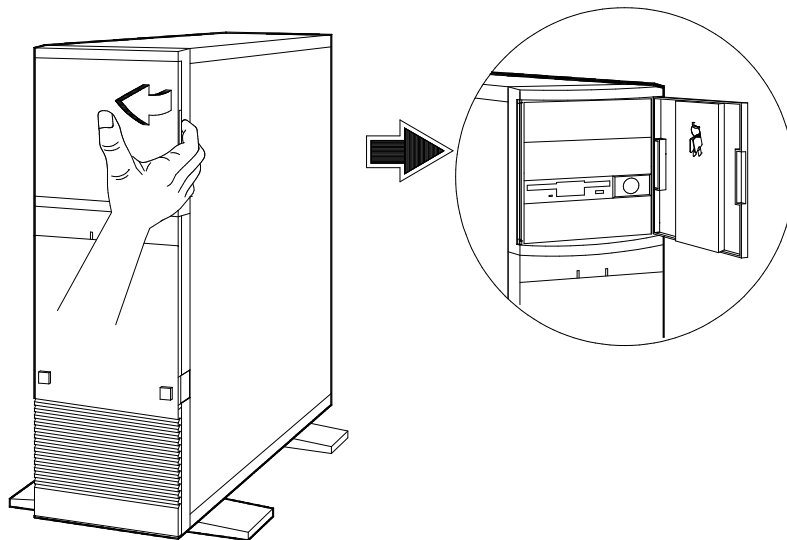

Figure 2-9 Opening the Upper Front Panel

Press the power switch to apply power to the system. The system starts up and performs a series of power-on self-tests (POST).

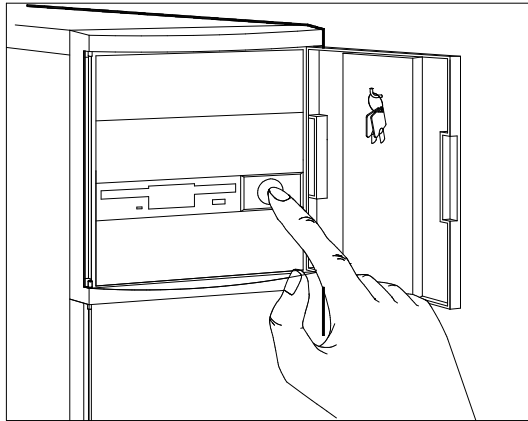

Figure 2-10 System Power On





If the system does not turn on or boot after pressing the power switch, go to the next section for the possible causes of the boot failure.

You can determine if the system is in good condition by checking if the following occurred:

- Power indicator LED on the front panel lights up
- Power, Num Lock, and Caps Lock LED indicators on the keyboard light up

2.4 Power-on Problems

If the system does not boot after you have applied power, check the following factors that might have caused the boot failure.

The pointing symbol () indicates a possible cause of the problem. The check mark () tells you how to correct the problem.

 **The external power cable may be loosely connected.**

- ✓ Check the power cable connection from the power source to the power socket on the rear panel. Make sure that the cable is properly connected.

 **No power comes from the grounded power outlet.**

- ✓ Have an electrician check your power outlet if it is working.

 **Loose or improperly connected internal power cables.**

- ✓ Refer to Chapter 3 for the power cable connections and check the internal cable connections. If you are not confident to perform this task, ask a qualified technician to help you.



If you have gone through the preceding actions and the system still fails to boot, ask your dealer or a qualified technician for assistance.

System Configuration

The system hardware basically consists of six major components: housing, system board, memory board, SCSI disk-array backplane board, and power supply. This chapter discusses the system hardware configuration in detail.

3.1 System Housing

The system housing is a spacious tower chassis that allows future expansion and flexible configuration.

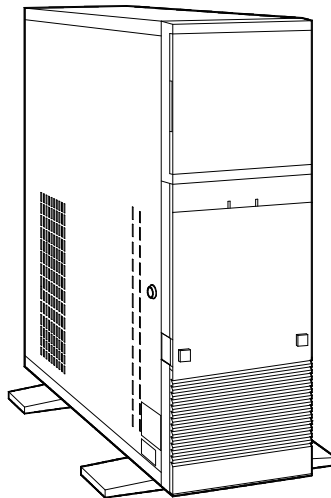

Figure 3-1 System Housing

3.1.1 Internal Structure

The system internal components are accessible by opening the left panel door. The system board, memory board, expansion boards (if any), and the power supply module mainly occupy the housing interior. On the rear end of the housing are the keyboard, mouse, video, parallel, and serial ports, and the slot openings for installation of EISA and PCI expansion boards.

The upper front section accommodates a 3.5-inch and three 5.25-inch drives while the lower section holds the eight hot-swappable SCSI drive trays. These devices on the front section are externally accessible. Right behind the drives is an eight-slot SCSI backplane board that connects the drives to the SCSI interface.

Figure 3-2 shows the components inside the system housing.

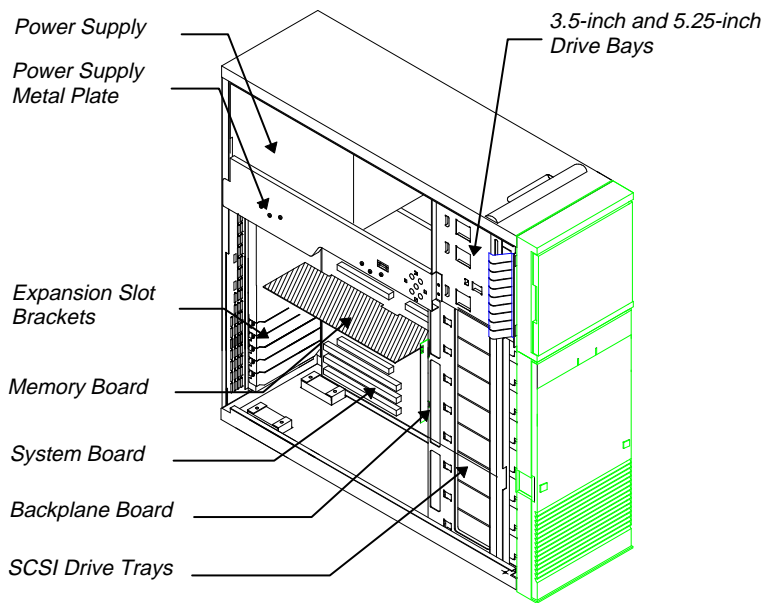

Figure 3-2 System Internal Components

3.1.2 Opening the Housing Panels

The system housing has three doors, two on the front, and one on the left panel. The left panel door has a security lock to prevent unauthorized access to the internal components. The lock also protects the SCSI disk-array hard disks. You cannot open the lower front panel unless you open the left panel security lock.

When installing components, unlock and remove the door or doors that hinder your way.

Upper Front Panel

Check the upper front panel is unlocked, then hold the right edge of the upper front panel and pull it open.

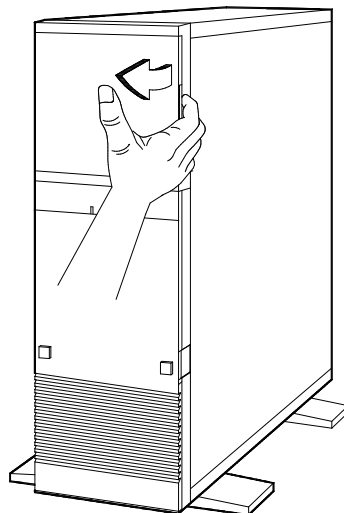

Figure 3-3 Opening the Upper Front Panel

Lower Front Panel

Follow these steps to open the left panel:

1. Unlock the left panel security with the system key.



The system key is attached on the inner side of the upper front panel.

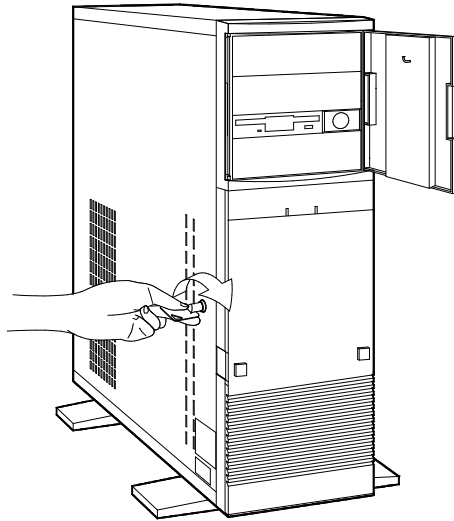

Figure 3-4 Opening the Lower Front Panel

2. Pull the panel open.

Left Panel

Pull on the key to swing the left panel open. If necessary, you may use a screwdriver to pry open the panel.

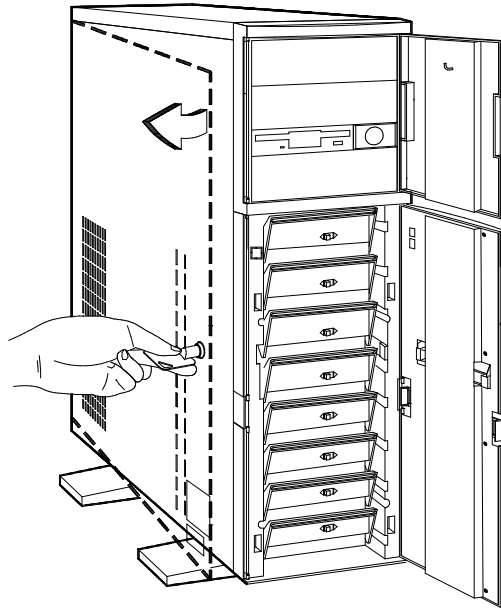

Figure 3-5 Opening the Left Panel

3.1.3 ESD Precautions

Always observe the following ESD (electrostatic discharge) precautions before installing any system component:

1. Do not remove any system component from its packaging unless you are ready to install it.
2. Wear a wrist grounding strap before handling electronic components. Wrist grounding straps are available at most electronic component stores.



DO NOT attempt the procedures in the following sections unless you are confident of your capability to perform them. Otherwise, ask a service technician for assistance.

3.1.4 Installing External Devices

The housing supports one 3.5-inch and three 5.25-inch external devices. The empty drive bays on the upper front panel allow you install additional external devices such as a CD-ROM drive, a digital audio tape (DAT) drive or another hard disk drive.



Your basic system comes with a 3.5-inch diskette drive already installed. Should you need to replace the 3.5-inch diskette drive in the future, refer to the following section on how to install the drive.

3.5-inch Diskette Drive

Follow these steps to install a 3.5-inch diskette drive:

1. Open the lower front panel. Unlock the left panel security if it is locked.
2. Remove the upper front panel including its frame by pressing the latch underside and pulling the panel and frame out.

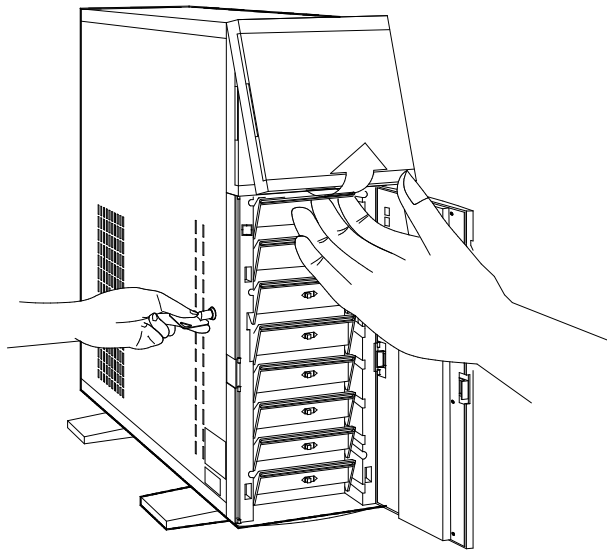

Figure 3-6 Removing the Upper Front Panel

-
3. Remove the screw attaching the 3.5-inch drive frame to the housing.

If you are replacing a previously installed drive, remove the old drive from the frame.

4. Secure a 3.5-inch drive on the frame with four screws.

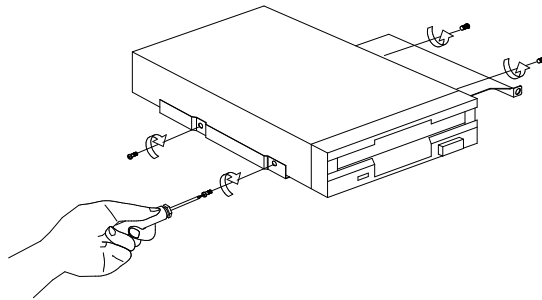

Figure 3-7 Attaching a 3.5-inch Diskette Drive on the Frame

5. Insert the drive into the drive bay and secure it with a screw.

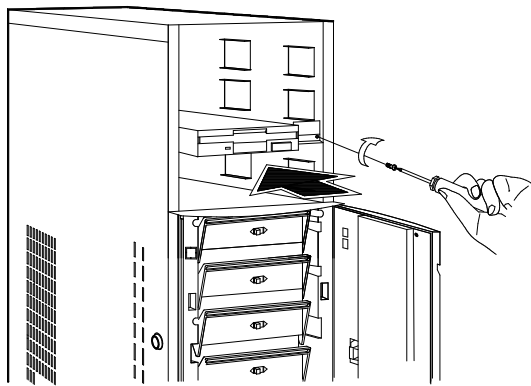

Figure 3-8 Installing a 3.5-inch Diskette Drive

6. Connect the drive power and signal cables.

5.25-inch External Device

Follow these steps to install a 5.25-inch external device:

1. Open the lower front panel. Unlock the left panel security if it is locked.
2. Remove the upper front panel including its frame by pressing the latch underside and pulling the panel and frame out. See Figure 3-6.
3. Attach the metal guides on the sides of the external device, such as a CD-ROM drive, that you wish to install.

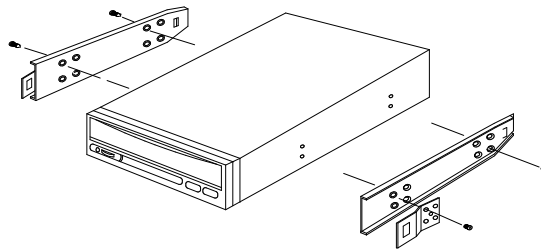

Figure 3-9 Attaching the Metal Guides to a CD-ROM Drive



If you are installing a wide SCSI device, set its ID and terminators before installing it into the drive bay.

See section 3.4 for information on setting the drive ID and terminators.

-
4. Insert the drive into the bay.

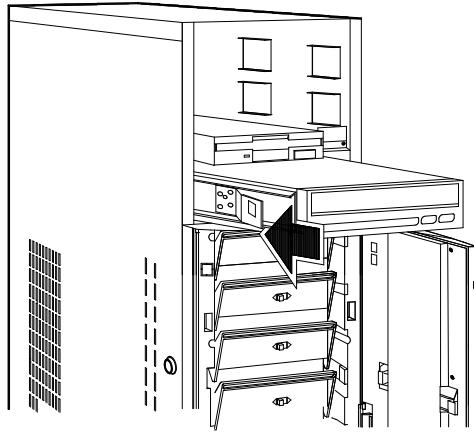

Figure 3-10 Installing a 5.25-inch External Device

5. Connect the drive power and signal cables.

3.1.5 Installing a Hot-swappable SCSI Drive

The system supports hot-swappable drive trays with wide SCSI or narrow SCSI interface board. The installation steps for the wide and narrow SCSI drives are basically the same except for connecting the wide SCSI drive ID cable.



If your system does not come with a backplane board, proceed first to section 3.4 for instructions on installing the board.

Follow these steps to install a hot-swap SCSI drive:

1. Open the lower front door. Unlock the left panel security if it is locked.
2. Push the drive tray switch to the Unlock/Power Off position.

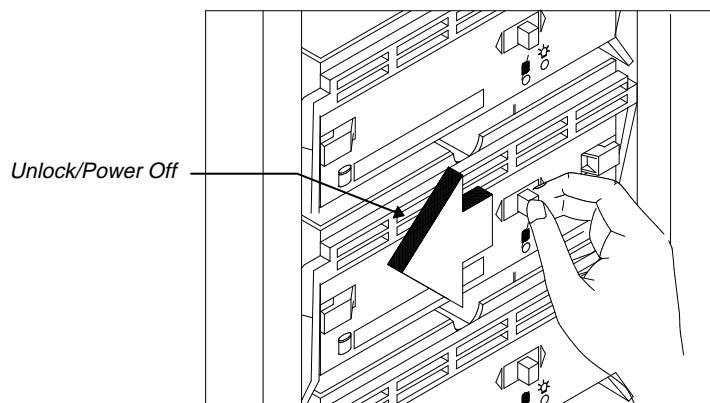

Figure 3-11 Unlocking the Drive Tray Switch

-
3. Hold the handle of a drive tray and pull it downward.
 4. Pull out the drive tray.

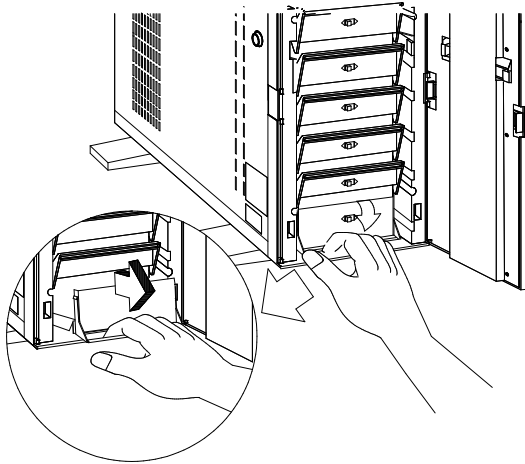

Figure 3-12 Pulling Out a Hot-swap Drive Tray

5. If you are installing a wide SCSI drive, remove the terminators and the drive ID on the drive. The backplane board ID setting feature allows you to set the wide SCSI device IDs on the backplane board.



Make sure that you have set jumpers J3 and J4 on the backplane board for additional SCSI IDs. See section 3.4.4 for information on setting the drive ID.

If you are installing a narrow SCSI drive, remove the terminators on the drive, then set the appropriate drive ID. You may not use the backplane board ID setting feature for narrow SCSI devices unless you connect a drive ID cable.

-
6. Place the drive on the tray and connect the SCSI cable, drive ID cable (for wide SCSI only), and power cable. Make sure that all cables are properly and completely connected.

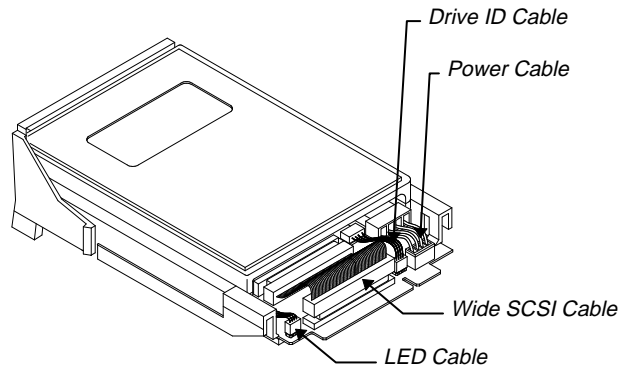

Figure 3-13 Connecting the Drive Cables (Wide SCSI Drive)

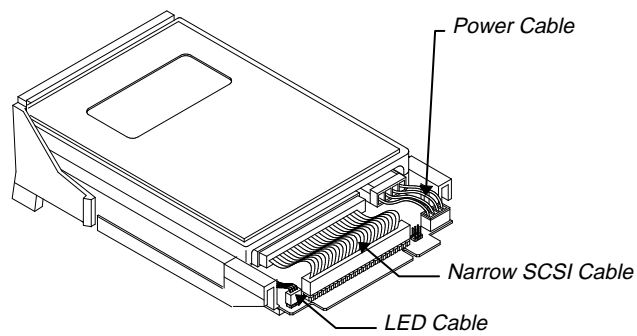

Figure 3-14 Connecting the Drive Cables (Narrow SCSI Drive)

-
7. Insert the tray into the drive bay then push up the drive tray handle into place.



Make sure to push the drive tray handle back after inserting the tray into the bay. Otherwise, the tray does not fit in completely.

8. Push back the drive into the bay until it fits completely into the backplane board slot.

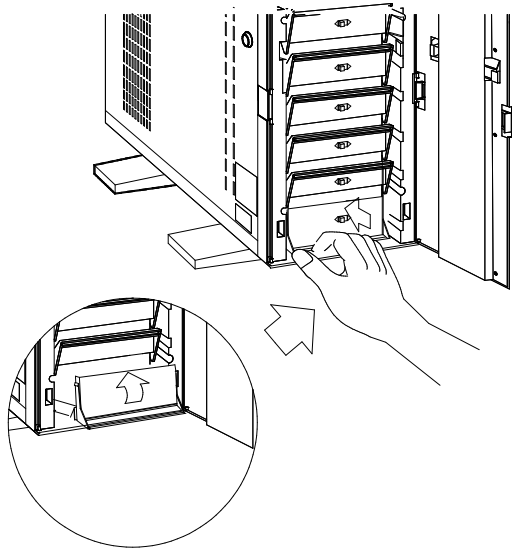

Figure 3-15 Installing a Hot-swap Drive Tray

-
9. Push the drive tray switch to the Lock/Power On position.

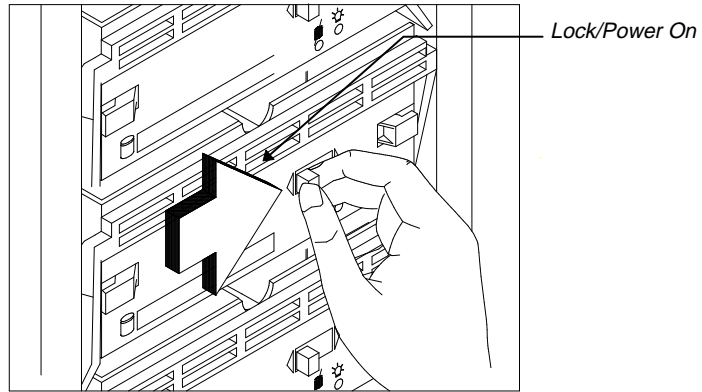

Figure 3-16 Locking the Drive Tray Switch

3.1.6 Installing an Expansion Board

Follow these steps to install an expansion board:

1. Unlock the security lock and open the left panel.
2. Remove the bracket cover opposite an empty PCI or EISA slot. Save the screw for later use.

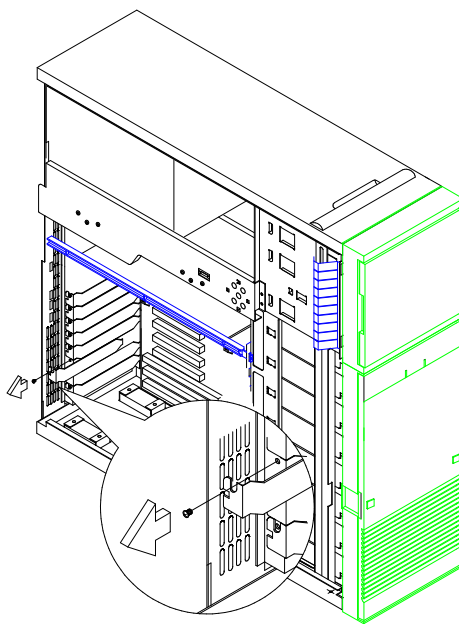

Figure 3-17 Removing a Bracket Cover

-
3. Align the board with the slot and insert the golden finger connector until it fits in completely.
 4. Secure the board with a screw.

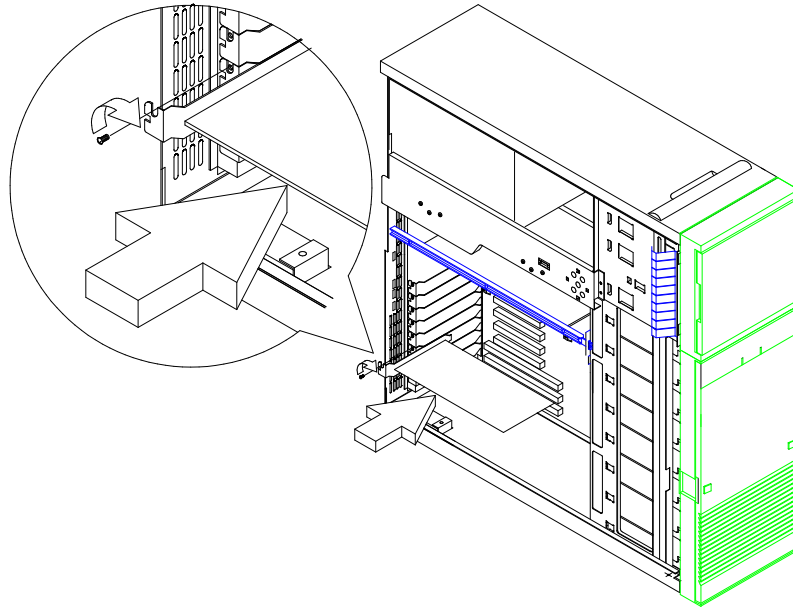

Figure 3-18 Installing an Expansion Board



If you installed an EISA board, run the EISA configuration utility (ECU) to reconfigure the system. See Chapter 5 for information on ECU.

3.2 System Board

The system board carries all the major system components including the two sockets for the Intel Pentium Pro CPUs. Figure 3-19 shows the major components on the system board.

3.2.1 Layout

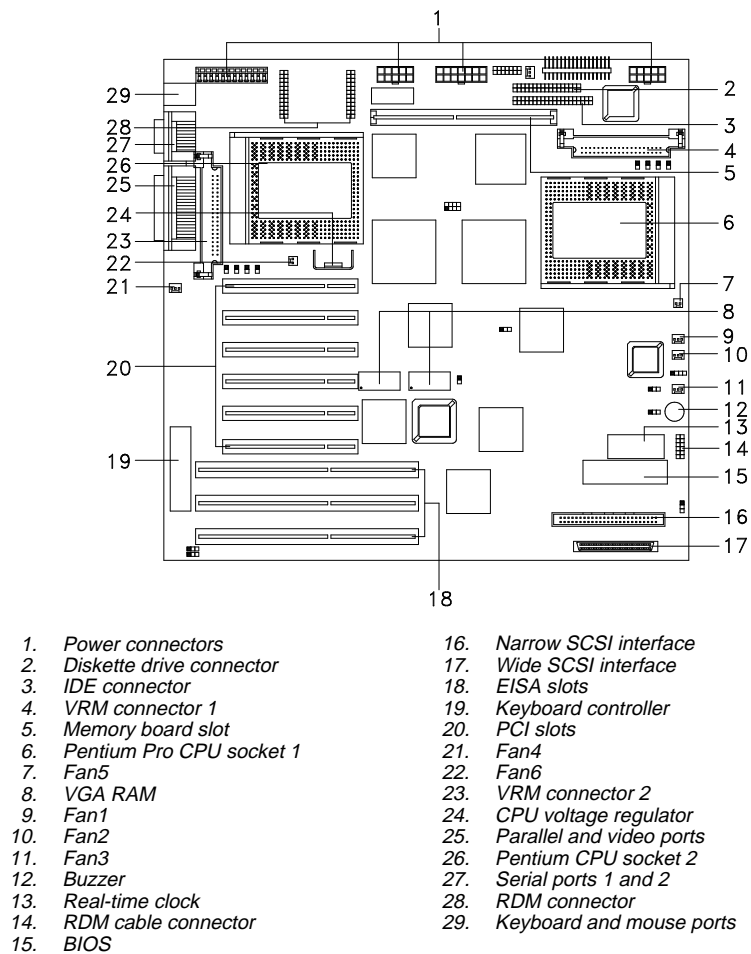

Figure 3-19 System Board Layout

3.2.2 Jumpers and Connectors

Figure 3-20 shows the jumper and connector locations on the system board.

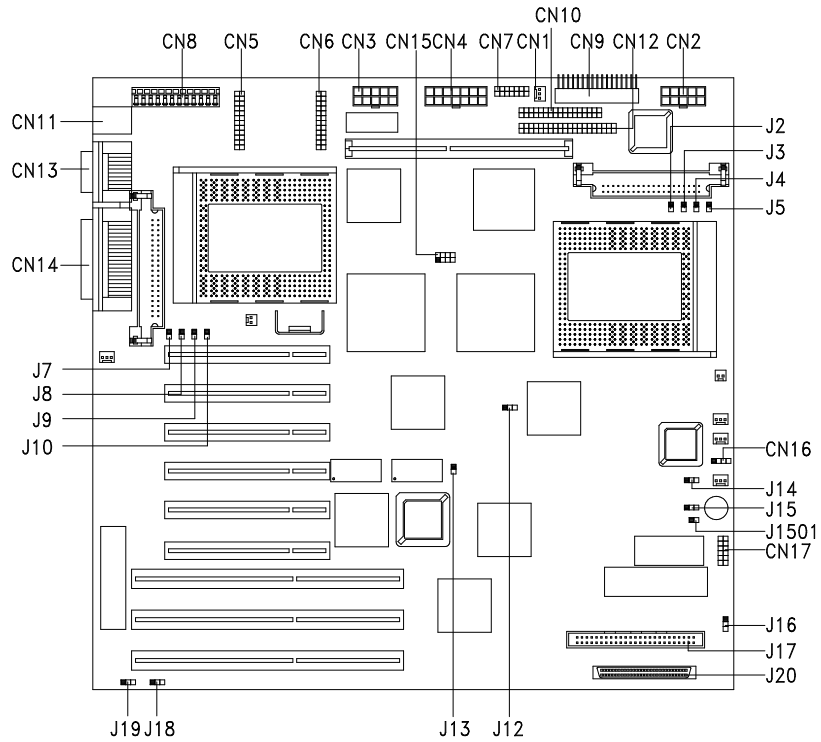

Figure 3-20 Jumper and Connector Locations



The blackened pin of a jumper represents pin 1.

Table 3-1 Jumper Settings

Jumper	Setting	Function
Oscillator Freq. J12	Open 1-2 2-3*	50 MHz 60 MHz 66 MHz
SCSI Feature J13	Open Closed*	Narrow SCSI Wide SCSI and narrow SCSI
ITP Boundary Scan J14 J15	Open** 2-3**	J14 and J15 are for CPU testing purposes only. Note: Do not reconfigure.
SCSI Termination J16	1-2 2-3*	SCSI terminator set to On SCSI terminator switchable to On or Off using the SCSI Setup Utility
Password Security J18	1-2* 2-3	Check password Bypass password
BIOS Logo J19	1-2* 2-3	For models with Acer BIOS For models with OEM BIOS
Sound Output J1501	1-2* Open	Enable buzzer output Disable buzzer output

* Default setting

** Fixed setting. Not user-configurable.

Voltage ID Settings

Figure 3-21 shows the settings of jumpers J2, J3, J4, and J5 to set CPU1 VRM connector (J1) to 3.3V at 200 MHz.

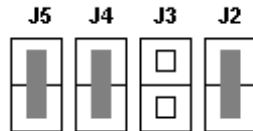

Figure 3-21 VRM Settings for CPU1 (3.3V for 200 MHz)

Figure 3-22 shows the settings of jumpers J7, J8, J9, and J10 to set CPU2 VRM connector (J6) to 3.3V at 200 MHz.

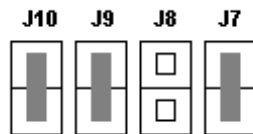

Figure 3-22 VRM Settings for CPU2 (3.3V for 200 MHz)

Table 3-2 lists the voltage identification (VID) code indicated by four binary-weighted inputs.

Table 3-2 Voltage Identification Codes

Pentium Pro Pins				Vccp (VDC)
VID3	VID2	VID1	VID0	
1	1	1	1	No CPU
1	1	1	0	2.1
1	1	0	1	2.2
1	1	0	0	2.3
1	0	1	1	2.4
1	0	1	0	2.5
1	0	0	1	2.6
1	0	0	0	2.7
0	1	1	1	2.8
0	1	1	0	2.9
0	1	0	1	3.0
0	1	0	0	3.1
0	0	1	1	3.2
0	0	1	0	3.3
0	0	0	1	3.4
0	0	0	0	3.5

0 = Processor pin connected to Vss
1 = Open



DO NOT change the settings of the voltage ID jumpers unless you are qualified to do so. Ask a technician if you need help when configuring these jumpers.

Table 3-3 Connector Functions

Connector	Function
CN1	3-pin power connector
CN2	10-pin power connector
CN3	10-pin power connector
CN4	14-pin power connector
CN5	RDM connector
CN6	RDM connector
CN7	Backplane LED connector
CN8	12-pin power connector
CN9	Front panel connector for twin-tower housing
CN10	Diskette drive connector
CN11	PS/2 keyboard/mouse connector
CN12	IDE hard disk connector
CN13	Serial port connector
CN14	Parallel port/VGA port connector
CN16	Hard disk LED connector
CN17	Reset/RDM cable connector
J1	VRM connector 1 (for CPU 1)
J6	VRM connector 2 (for CPU 2)
J17	50-pin narrow SCSI connector
J20	68-pin wide SCSI connector

Figure 3-23 shows the CN15 default setting indicating the clock frequency ratio of 3. Ask a qualified technician when changing the clock frequency ratio.

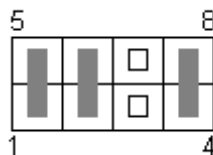

Figure 3-23 Clock Frequency Ratio Setting (CN15)

3.2.3 Installing a Pentium Pro CPU

The basic system includes an Intel Pentium Pro CPU installed in CPU socket 1. A second zero-insertion force (ZIF) CPU socket comes with the board for a dual-processor configuration.

Follow these steps to install a CPU:

1. Release the heat sink locks.
2. Attach the heat sink by sliding its rails along the longer sides of the rectangular Pentium Pro CPU. Make sure that the heat sink completely covers the CPU.
3. Hold the CPU and the heat sink firmly together then slide the locks on the sides of the heat sink to secure the CPU.

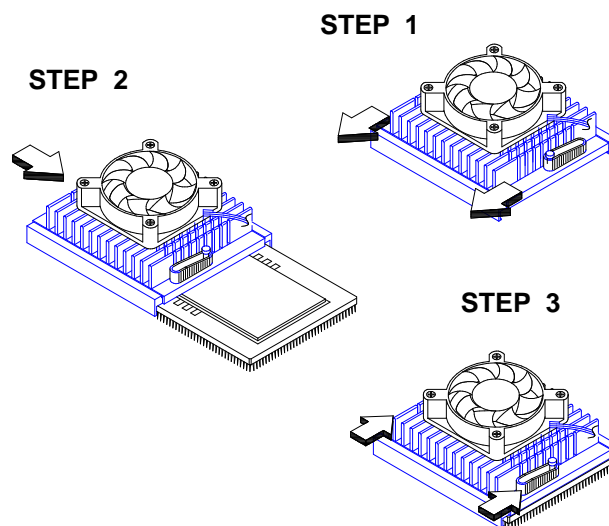

Figure 3-24 Attaching the Heat Sink to the CPU

-
- Lift up the CPU socket lever.
 - Look at the underside of the CPU and note the area where the pins are denser or closely embedded. Gently insert the CPU pins into the socket, matching the denser pins with the denser holes on the socket.



Be careful not to bend any pins.

- Push down the socket lever.
- Connect the CPU fan cable to connector Fan 5 (for CPU 1) or Fan 6 (for CPU 2) on the system board.

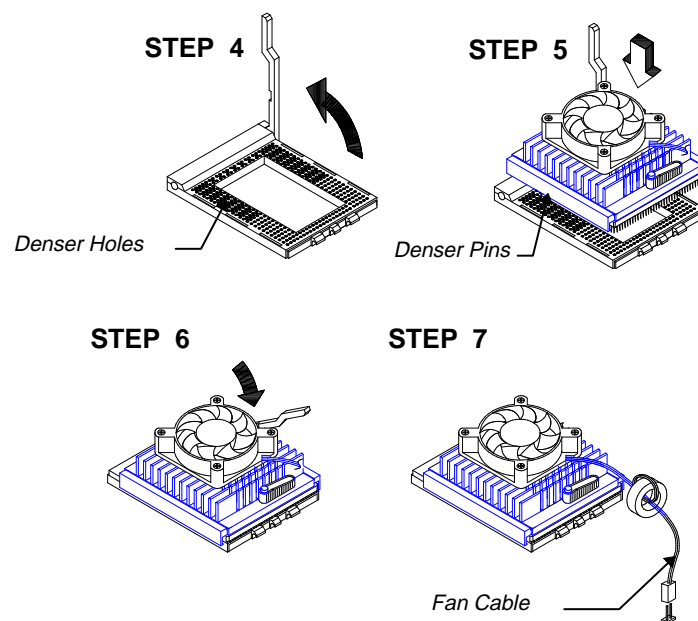

Figure 3-25 Installing a Pentium Pro CPU

3.3 Memory Board

The memory board comes already installed with the basic system. A total of eight memory banks composed of 16 72-pin SIMM sockets reside on the board. The sockets accept 8-MB, 16-MB, 32-MB, and 64-MB SIMMs for a maximum of 1 GB memory configuration.

3.3.1 Layout

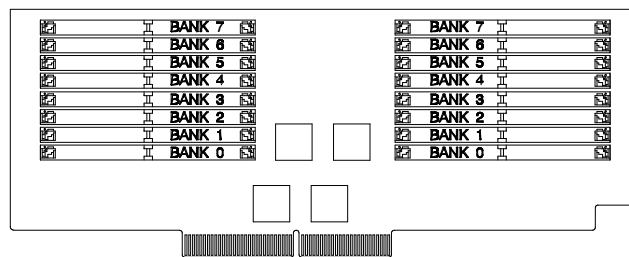

Figure 3-26 Memory Board Layout

3.3.2 Rules for Adding Memory

Adhere to the following rules when you add system memory.

- Always install SIMMs from bank 0. You should use the memory banks consecutively.
- Always install SIMMs in pairs to fill up a bank. For example, for a total memory of 16 MB, install two 8-MB SIMMs in a bank. You can not use a 16-MB SIMM alone for a 16-MB memory.
- Use only fast-page mode parity SIMMs.
- Install SIMMs of the same capacity in a configuration. For example, do not mix an 8-MB SIMM with a 16-MB SIMM.

3.3.3 Memory Configurations

Table 3-4 Memory Configurations

Bank 0	Bank 1	Bank 2	Bank 3	Bank 4	Bank 5	Bank 6	Bank 7	Total Memory
8MB*2								16 MB
8MB*2	8MB*2							32 MB
8MB*2	8MB*2	8MB*2	8MB*2					64 MB
8MB*2	8MB*2	8MB*2	8MB*2	8MB*2	8MB*2	8MB*2	8MB*2	128 MB
16MB*2								32 MB
16MB*2	16MB*2							64 MB
16MB*2	16MB*2	16MB*2	16MB*2					128 MB
16MB*2	16MB*2	16MB*2	16MB*2	16MB*2	16MB*2	16MB*2	16MB*2	256 MB
32MB*2								64 MB
32MB*2	32MB*2							128 MB
32MB*2	32MB*2	32MB*2	32MB*2					256 MB
32MB*2	32MB*2	32MB*2	32MB*2	32MB*2	32MB*2	32MB*2	32MB*2	512 MB
64MB*2								128 MB
64MB*2	64MB*2							256 MB
64MB*2	64MB*2	64MB*2	64MB*2					512 MB
64MB*2	64MB*2	64MB*2	64MB*2	64MB*2	64MB*2	64MB*2	64MB*2	1024 MB

3.3.4 Installing a SIMM

Follow these steps to install a SIMM:

1. Carefully slip a SIMM at a 45° angle into a socket making sure that the curved edge indicating the pin 1 of the SIMM matches pin 1 of the socket.



A SIMM fits only in one direction. If you slip in a SIMM but does not completely fit, you may have inserted it the wrong way. Reverse the orientation of the SIMM.

2. Gently push the SIMM to a vertical position until the pegs of the socket slip into the holes on the SIMM, and the holding clips lock the SIMM into position. The SIMM should be at a 90° angle when installed.

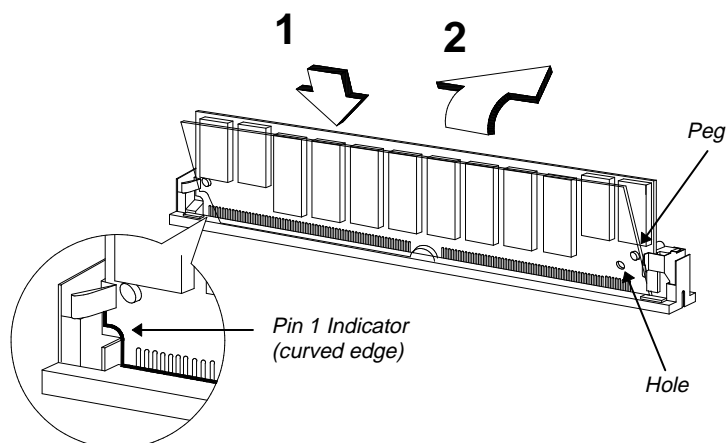

Figure 3-27 Installing a SIMM

3.3.5 Removing a SIMM

Follow these steps to remove a SIMM:

1. Press the holding clips on both sides of the SIMM outward to release it.
2. Move the SIMM to a 45° angle.
3. Pull the SIMM out of the socket.

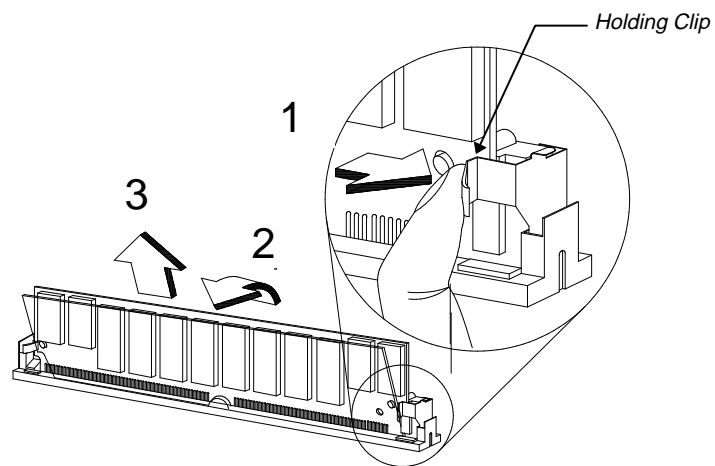

Figure 3-28 Removing a SIMM

3.3.6 Installing the Memory Board

Follow these steps to install the memory board:

1. Align the memory board with the memory board slot on the system board.



Install the memory board with the component side up.

2. Insert the board into the slot until it fits into place.

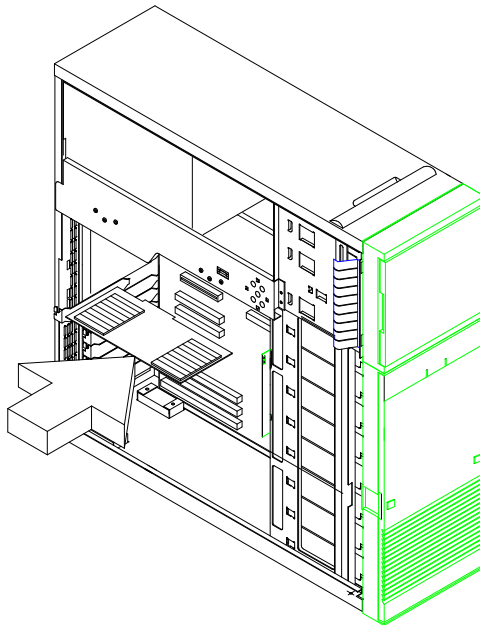

Figure 3-29 Inserting the Memory Board

-
3. Insert one end of the board holding clamp into the hole on the bracket behind the disk drives.
 4. Align the clamp rail with the board edge.
 5. Insert the other end of the clamp into the hole on the rear panel bracket.



Make sure to install the holding clamp properly. It protects the memory board and keeps it in place

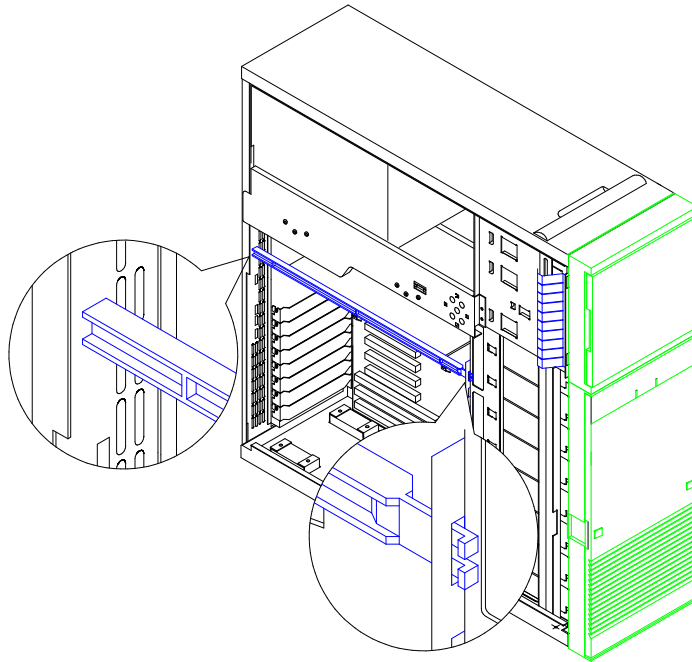

Figure 3-30 Attaching the Board Holding Clamp

3.3.7 Reconfiguring the System

You must enter Setup after installing or removing SIMMs to reconfigure the system.

Follow these steps to reconfigure the system:

1. Turn the system on. A memory error message appears, indicating that the total memory does not match the value stored in CMOS.
2. Press **CTRL** + **ALT** + **ESC** to enter Setup. A warning message appears indicating an incorrect memory configuration.
3. Press **ESC** twice to exit and reboot the system.

The system boots with the new memory configuration.

3.4 SCSI Disk Array Backplane Board

The SCSI disk array backplane board provides a convenient interface between the SCSI drives and the system board. It includes eight SCSI drive slots to accommodate the drive trays, two SCSI channels to connect to the system board or SCSI controller board, and one SCSI channel out for external devices.

3.4.1 Features

The backplane board has the following major features:

- “Hot-swap” feature that allows replacement of a defective hard drive even while the system is in full operation. This feature requires a RAID controller board and RAID drivers.
- Supports wide SCSI or narrow SCSI devices
- Supports mixed configuration of both fast-and-wide (16-bit) and fast-and-narrow (8-bit) SCSI drives in a single channel
- Allows ‘split’ and ‘combine’ SCSI-channel configurations
- SCSI ID strapping that allows wide SCSI HDD ID configuration through the backplane switches instead of configuring the individual drive IDs
- Supports other external SCSI devices through the SCSI channel out interface

3.4.2 Layout

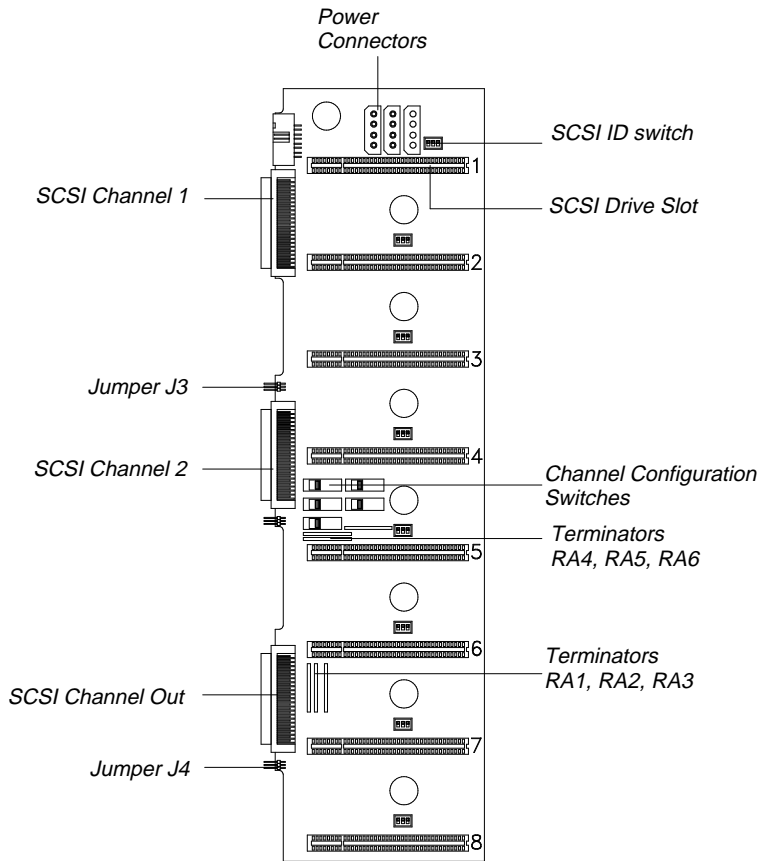

Figure 3-31 SCSI Disk Array Backplane Board

3.4.3 Jumper Settings

The backplane jumpers J3 and J4 allow you to select the terminator power source and set drive IDs. J3 supports the four upper drive slots (slots 1, 2, 3, and 4) on the backplane. J4 supports the four lower drive slots (slots 5, 6, 7, and 8). See section 3.4.4 for details on hard disk ID settings.

Figure 3-32 shows the settings for jumpers J3 and J4. Note that SETTING 2 is the default.

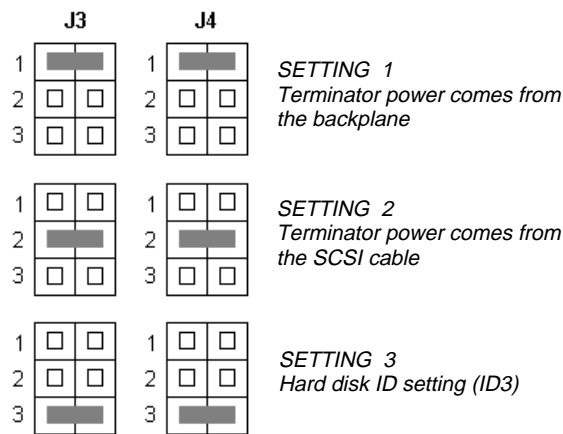

Figure 3-32 Jumper Settings

3.4.4 SCSI Hard Disk ID Feature

You can avail of the ID setting feature by configuring the SCSI ID switches and jumpers J3 and J4 setting 3 on the backplane board. Normally, you can assign seven IDs on the backplane (IDs 0 ~ 6). Closing the Setting 3 pins on jumpers J3 and J4 allow you to set eight additional SCSI drive IDs for the SCSI devices installed in the system.

Table 3-5 shows the SCSI ID switch settings and the corresponding drive IDs depending on J3 and J4 pin settings.

Table 3-5 SCSI ID Settings

Slot No.	SCSI ID Switch Setting	SCSI Device ID	
		J3 J4 Setting 3 Open - Default	J3 J4 Setting 3 Closed
1		0	8
2		1	9
3		2	A
4		3	B
5		0	8
6		1	9
7		2	A
8		3	B



Normally, SCSI ID7 is assigned to the SCSI controller board.

3.4.5 Channel Configuration

You may configure the backplane as single-channel (combine) or dual-channel (split) controller.

Single-Channel Configuration

In a single-channel configuration, channel 1 supports the SCSI devices plugged into slots 1 to 8. Set the channel configuration switches to "Combine". Note that terminators RA1 to 6 are always installed. See Figure 3-31 for the locations of the switches and terminators.

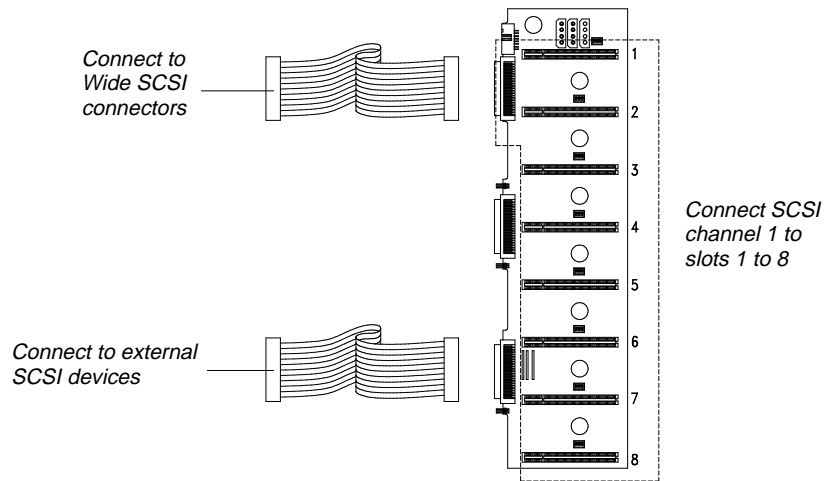

Figure 3-33 Single-Channel Configuration

Dual-Channel Configuration

In a dual-channel configuration, channel 1 supports the devices in slots 1 to 4, and channel 2 supports the devices in slots 5 to 8. Set the channel configuration switches to "Split". Note that terminators RA1 to 6 are always installed. See Figure 3-31 for the locations of the switches and terminators.

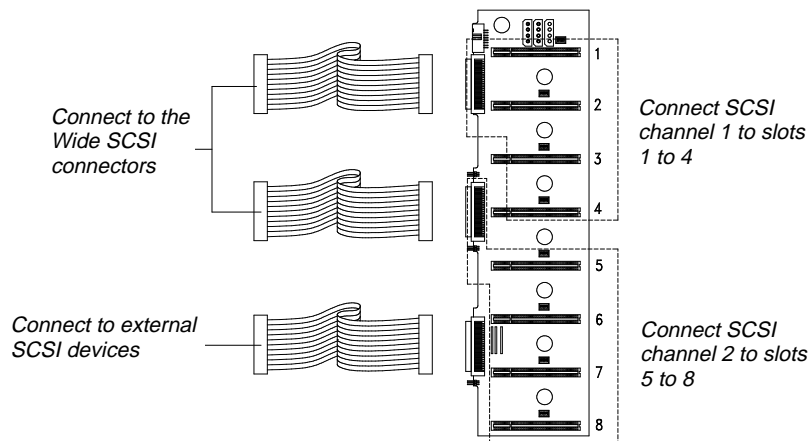

Figure 3-34 Dual-Channel Configuration

Chapter 4

BIOS Utility

The system is already configured by the manufacturer or the dealer. There is no need to run Setup when starting the computer unless you get a configuration error.

The Setup program loads configuration values into the battery-backed nonvolatile memory called CMOS RAM. This memory area is not part of the system RAM.



If you repeatedly receive Run Setup messages, the battery may be bad. In this case, the system cannot retain the configuration values in CMOS. Ask a qualified technician for assistance.

Before you run Setup, have the following information ready:

- **Diskette drive type** The standard type is a 3.5-inch 1.44-MB diskette drive.

4.1 Entering Setup

To enter Setup, press the key combination **CTRL+ALT+ESC** .



*You must press **CTRL+ALT+ESC** while the system is booting. This key combination does not work during any other time.*

The BIOS Utility main menu then appears:

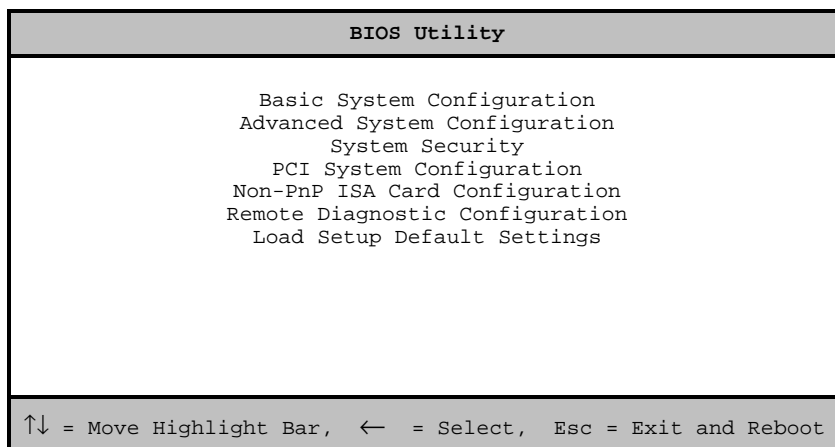

The parameters on the screens show default values. These values may not be the same as those in your system.

The grayed items (denoted with asterisks) on the screens have fixed settings and are not user-configurable.

4.2 Basic System Configuration

Select Basic System Configuration to input configuration values such as date, time, and disk types.

The following screen shows the Basic System Configuration menu.

```
Basic System Configuration                               Page 1/2
Date ..... [MM/DD/YY]
Time ..... [HH:MM:SS]
Diskette Drive A ..... [xx-MB      xx-inch]
Diskette Drive B ..... [xx-MB      xx-inch]

                                Cylinder  Head   Sector
Hard Disk 0 (xxx MB) ..... [Auto]    xx     xx     xx
Hard Disk 1 (xxx MB) ..... [Auto]    xx     xx     xx

*Base Memory ..... [  xxx]  KB
*Extended Memory ..... [ xxxx]  KB
*Total Memory ..... [ xxxx]  KB
*Math Coprocessor ..... [   Installed   ]
*Video Display ..... [VGA/EGA]
```

↑↓ = Move Highlight Bar, → ← = Change Setting
PgDn/PgUp = Move Screen, Esc = Exit

The command line at the bottom of the menu tells you how to highlight items, change settings, and move from one screen to another.

Press **↑** or **↓** on the cursor-edit keypad to highlight the desired parameter.

Press **→** or **←** to select the desired option for a parameter.

Press **PGDN** to move to the next page or **PGUP** to return to the previous page.

Press **ESC** to exit the configuration menu.

The following screen shows page 2 of the Basic System Configuration menu.

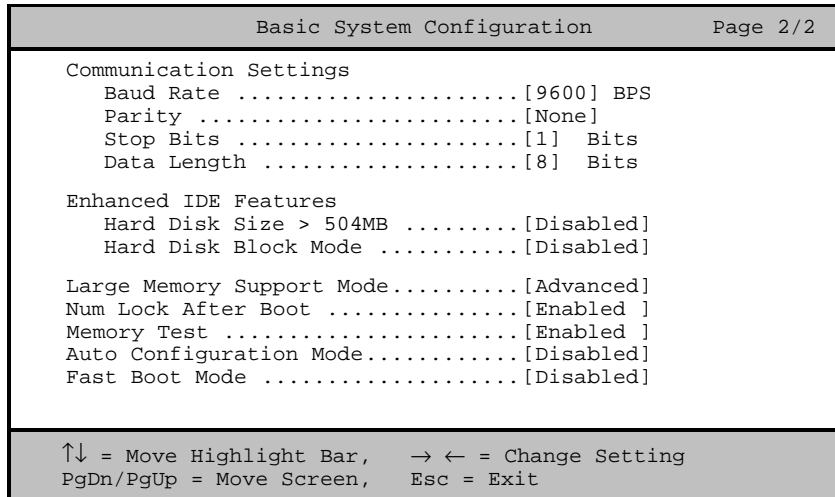



The following sections explain the different parameters and their settings.

4.2.1 Date and Time

The real-time clock keeps the system date and time. After setting the date and time, you need not enter them every time you turn on the system. As long as the internal battery remains good (approximately seven years) and connected, the clock continues to keep the date and time accurately even when the power is off.



Date

Highlight the items on the date parameter and press  or  to set the date following the month-day-year format.

Valid values for month, day, and year are:

- Month 1 to 12
- Day 1 to 31
- Year 00 to 99



Time

Highlight the items on the time parameter and press  or  to set the time following the hour-minute-second format.

Valid values for hour, minute, and second are:

- Hour 00 to 23
- Minute 00 to 59
- Second 00 to 59

4.2.2 Diskette Drives

To enter the configuration value for the first diskette drive (drive A), highlight the Diskette Drive A parameter. Press  or  key to view the options and select the appropriate value.

Possible settings for the Diskette Drive parameters:

- [None]
- [360 KB, 5.25-inch]
- [1.2 MB, 5.25-inch]
- [720 KB, 3.5-inch]
- [1.44 MB, 3.5-inch]
- [2.88 MB, 3.5-inch]

Follow the same procedure for Diskette Drive B. Choose None if you do not have a second diskette drive.

4.2.3 Hard Disk Drives

Move the highlight bar to the hard disk 0 parameter to configure the first hard disk (drive C). Press **→** or **←** to display the hard disk types with their respective values. Select the type that corresponds to your hard disk drive. Follow the same procedure for the other hard disks, if any. Choose **None** if you do not have other drives.

Selecting the “Auto” Option

If you do not know the exact type of your hard disk, select the option **Auto**. During the power-on self-test (POST), when the system performs self-testing and self-initialization before loading the operating system and applications, the BIOS utility automatically determines your hard disk type. You can see the drive type and its values when you enter the BIOS Utility.

	Cylinder	Head	Sector
Hard Disk 0 (xx MB) ... [Auto]	xx	xx	xx

If desired, you can save the values under the option **User**.

	Cylinder	Head	Sector
Hard Disk 0 (xx MB) ... [User]	xx	xx	xx

The next time you boot the system, the BIOS utility does not have to auto-configure your hard disk as it detects the saved disk information during POST.



We recommend that you copy the IDE disk drive values and keep them in a safe place in case you have to reconfigure the disk in the future.

Follow the same procedure to auto-configure other hard disks.

Selecting the “User” Option

There are cases when you cannot use the option `Auto`, instead you have to select `User`. Choose the `User` option when you have installed an hard disk that was previously formatted but does not use the disk native parameters or structure, that is, the disk type may be in the hard disk types list but the number of cylinders, heads, and sectors differ.

Follow these steps to configure a hard disk with the `User` option:

1. Highlight an hard disk parameter.
2. Select the option `User` and press `ENTER`.
3. Type in the number of cylinders, heads, and sectors of the drive under the appropriate columns.



Be sure to have the correct hard disk information beforehand.

4. Choose `YES` when asked if you want to save CMOS data.

4.2.4 System Memory

The system automatically detects the total amount of onboard memory during the POST and sets the memory parameters accordingly. If you install additional memory, the system automatically adjusts the Total Memory parameter to display the new memory size.

4.2.5 Math Coprocessor

The CPU includes a math coprocessor so this parameter shows `Installed` by default.

4.2.6 Video Display

The video display is the monitor on which the operating system prompt appears when you boot the system. The system automatically detects the video mode of your primary display and sets the configuration value accordingly. Values for this parameter are:

- [Monochrome]
- [CGA 40 columns x 25 rows]
- [CGA 80 columns x 25 rows]
- [VGA/EGA]

4.2.7 Communication Settings

The Communication Settings parameters allow you to set the baud rate, parity, stop bit, and data length for the first serial port. The values for this parameter are:

- Baud rate : 110 to 9600 bits per second (bps)
- Parity : odd, even, or none
- Stop bit : 1 or 2 stop bits
- Data length : 7- or 8-bit data word



The baud rate maximum value 9600 bps applies only to POST under UNIX environment. The system I/O chipset SMC 37C665 supports up to 115.2K bps.

4.2.8 Enhanced IDE Features

Hard Disk Size > 504 MB

This enhanced IDE feature works only under DOS and Windows 3.x environments. If enabled, it allows you to use a hard disk with a capacity of more than 504 MB. This is made possible through the Logical Block Address (LBA) mode translation. Other operating systems require this parameter to be set to *Disabled*.

To prevent data loss, set this parameter set to *Enabled* if you are using a hard disk with more than 504 MB capacity that was previously configured through LBA mode. If you use a hard disk configured through cylinder-head-sector (CHS) mode, set this item to *Disabled*.

Hard Disk Block Mode

This function enhances disk performance depending on the hard disk in use. If you set this parameter to *Enabled*, it allows data transfer in block (multiple sectors) by increasing the data transfer rate to 256 bytes per cycle. If your system does not boot after enabling this parameter, change the setting to *Disabled*. This parameter is normally set to *Disabled*.

4.2.9 Num Lock After Boot

This parameter allows you to activate the Num Lock function upon booting. The default setting is *Enabled*.

4.2.10 Memory Test

When set to *Enabled*, this parameter allows the system to perform a RAM test during the POST routine. When set to *Disabled*, the system detects only the memory size and bypasses the test routine. The default setting is *Disabled*.

This item is fixed to *Disabled* and is not user-configurable if you enabled the *Auto Configuration Mode* and the *Fast Boot Mode* parameters on page 2 of the Basic System Configuration menu. See section 4.2.11 and 4.2.12.

4.2.11 Auto Configuration Mode

When enabled, this parameter automatically sets the system configuration values to their optimized settings. At the same time, it causes the *Memory Test* parameter to be fixed to *Disabled* and the shadow RAM regions for system and video BIOS to *Enabled*. See sections 4.2.10 and 4.3.1.

Set this parameter to the default *Enabled* if you do not know the hard disk drive parameters and the onboard communication port configurations.

4.2.12 Fast Boot Mode

When enabled, this parameter allows the system to boot faster by skipping some POST routines. This parameter is enabled by default.

When set to *Enabled*, this parameter causes the *Memory Test* parameter to be fixed to *Disabled*. See sections 4.2.10.

4.3 Advanced System Configuration

The Advanced System Configuration option allows you to configure the advanced system memory functions.



Do not change any settings in the Advanced Configuration if you are not a qualified technician to avoid damaging system.

The following screen shows page one of the Advanced System Configuration parameters.

Advanced System Configuration		Page 1/1
Shadow RAM		
*E0000h - FFFFFh (System BIOS) ...	[Enabled]	
*C0000h - C7FFFh (Video BIOS).....	[Enabled]	
C8000h - CBFFFh	[Disabled]	
CC000h - CFFFFh	[Disabled]	
D0000h - D3FFFh	[Disabled]	
D4000h - D7FFFh	[Disabled]	
D8000h - DBFFFh	[Disabled]	
DC000h - DFFFFh	[Disabled]	
* L1 & L2 Cache (CPU Cache)	[Enabled]	
Cache Scheme	[Write Back]	
Video Buffer Memory Type	[Non-cacheable]	
Memory at 15MB-16MB Reserved for	[System]	Use
↑↓ = Move Highlight Bar, → ← = Change Setting PgDn/PgUp = Move Screen, Esc = Exit		



The grayed parameters (denoted with asterisks) are not user-configurable.

4.3.1 Shadow RAM

The system reserves 384 KB of random access memory (RAM) for the shadow RAM function. This parameter has eight range addresses. When you set these addresses to *Enabled*, the system BIOS, video BIOS, and I/O ROM functions run directly from the shadow RAM for faster operation. When you set them to *Disabled*, the functions run normally from ROM.

The address range E0000h - FFFFFh is for shadowing the system BIOS. This item is always set to *Enabled* and is not user-configurable. The address range C0000h - C7FFFh is for shadowing the video BIOS. This item is fixed to *Enabled*.

The remaining address ranges are for I/O ROM functions.

4.3.2 L1 and L2 Cache (CPU Cache)

This parameter enables or disables the first-level and second-level cache integrated in the Pentium Pro CPU. This item is fixed to *Enabled* and is not user-configurable if you enabled the *Auto configuration Mode* and *Fast Boot Mode* parameters on page 2 of the *Basic System Configuration* menu.

Cache Scheme

This parameter sets the cache to *Write-through* or *Write-back* modes. *Write-back* updates the cache but not the memory when there is a write instruction. It updates the memory only when there is cache miss or an inconsistency between the cache and the memory. *Write-through* updates both the cache and the memory whenever there is a write instruction.

Video Buffer Memory Type

This parameter allows you to enable or disable the video cache buffer feature. When you set this parameter to `USWC`, the uncacheable, speculatable write-combining (USWC) buffer in the CPU temporarily stores video write data. When the USWC buffer is full, the CPU eventually writes the data to the memory address `A0000h~BFFFFh` reserved for video data. Setting to `Non-cacheable` disables this feature.

4.3.3 Memory at 15MB-16MB

To prevent memory address conflicts between the system and expansion boards, reserve this memory range for the use of either the system or an expansion board. Before setting this parameter, check your add-on card manual to determine if your add-on card needs this memory space. If not, set this parameter to `System Use`.

4.4 System Security Setup

The Setup program has a number of security features to prevent unauthorized access to the system and its data.

Enter the Setup program and select System Security. The following screen appears:

```
System Security                                     Page 1/1

Disk Drive Control
Diskette Drive ..... [      Normal      ]
Hard Disk Drive ..... [      Normal      ]
System Boot Drive ..... [Drive A then C]

Onboard Communication Ports
Serial Port 1 Base Address .... [Disabled ]
Serial Port 2 Base Address .... [  2F8h  ]
Parallel Port Base Address .... [378h (IRQ 7)]
Operation Mode ..... [Standard Parallel Port (SPP)] Mode
* ECP DMA Channel ..... [-]

Onboard PS/2 Mouse (IRQ12) ... [Enabled ]

Setup Password ..... [ None ]
Power On Password ..... [ None ]

↑↓ = Move Highlight Bar,   → ← = Change Setting
PgDn/PgUp = Move Screen,  Esc = Exit
```

4.4.1 Disk Drive Control

The disk drive control features allow you to enable or disable the read/write functions of a disk drive. These features can also control the diskette drive or the hard disk drive boot function to prevent loading operating systems or other programs from a certain drive while the other drives are operational.

Table 4-1 lists the drive control settings and their corresponding functions.

Table 4-1 Drive Control Settings

Diskette Drive	
Setting	Description
Normal	Diskette drive functions normally
Write Protect All Sectors	Disables the write function on all sectors
Write Protect Boot Sector	Disables the write function only on boot sector
Disabled	Disables all diskette functions
Hard Disk Drive	
Setting	Description
Normal	Hard disk drive functions normally
Write Protect All Sectors	Disables the write function on all sectors
Write Protect Boot Sector	Disables the write function only on boot sector
Disabled	Disables all hard disk functions
System Boot Drive	
Setting	Description
Drive A then C	System boots from drive A to C
Drive C then A	System boots from drive C to A
C:	System always boots from drive C
A:	System always boots from drive A

4.4.2 Onboard Communication Ports

Serial Port 1 Base Address

This parameter allows you to set the serial port 1 logical base address.

Table 4-2 Serial Port 1 Settings

Setting	Description
3F8h	Serial port 1 with address 3F8h using IRQ4
2F8h	Serial port 1 with address 2F8h using IRQ3
3E8h	Serial port 1 with address 3E8h using IRQ4
2E8h	Serial port 1 with address 2E8h using IRQ3
Disabled	Disables serial port 1

Serial Port 2 Base Address

This parameter allows you to set the serial port 2 logical base address.

Table 4-3 Serial Port 2 Settings

Setting	Description
3F8h	Serial port 2 with address 3F8h using IRQ4
2F8h	Serial port 2 with address 2F8h using IRQ3
3E8h	Serial port 2 with address 3E8h using IRQ4
2E8h	Serial port 2 with address 2E8h using IRQ3
Disabled	Disables serial port 2



If you assign 3F8h to serial port 1, you may only assign 2F8h or 2E8h to serial port 2.

If you assign 2F8h to serial port 1, you may only assign 3F8h or 3E8h to serial port 2.

Parallel Port Base Address

The system has one parallel port. Table 4-4 lists the options for selecting the parallel port address. You also have the option to disable the parallel port.

Table 4-4 *Parallel Port Settings*

Setting	Function
3BCh (IRQ 7)	Corresponds to the parallel port with address 3BCh
378h (IRQ 7)	Corresponds to the parallel port with address 378h
278h (IRQ 5)	Corresponds to the parallel port with address 278h
Disabled	Disables the parallel port

To deactivate the parallel port, select the `Disabled` option. If you install an add-on card that has a parallel port whose address conflicts with the parallel port onboard, the system automatically disables the onboard functions.

Check the parallel port address on the add-on card and change the address to one that does not conflict.

OPERATION MODE

This item allows you to set the operation mode of the parallel port. Table 4-5 lists the different operation modes.

Table 4-5 Parallel Port Operation Mode Settings

Setting	Function
Standard Parallel Port (SPP)	Allows normal speed one-way operation
Standard and Bidirectional	Allows normal speed operation in a two-way mode
Enhanced Parallel Port (EPP)	Allows bidirectional parallel port operation at maximum speed
Extended Capabilities Port (ECP)	Allows parallel port to operate in bidirectional mode and at a speed higher than the maximum data transfer rate

ECP DMA CHANNEL

This item becomes active only if you select [Extended Capabilities Port \(ECP\)](#) for the operation mode parameter. It allows you to select [DMA channel 1](#) or [DMA channel 3](#) depending on the available system resource.

4.4.3 Onboard PS/2 Mouse (IRQ12)

This parameter enables or disables the onboard PS/2 mouse. When set to [Enabled](#), it allows you to use the onboard PS/2 mouse assigned with IRQ12. When set to [Disabled](#), it deactivates the mouse and frees IRQ12 for the use of other devices.

4.4.4 Setup Password

The Setup Password prevents unauthorized access to the BIOS utility.



Set jumper JP18 to pins 1-2 to enable the password function.

Setting a Password

1. Highlight the Setup Password parameter and press the left- or right-arrow key. The password prompt appears:

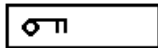

2. Type a password. The password may consist of up to seven characters.



Exercise caution when typing your password because the characters do not appear on the screen.

3. Press **ENTER**. A prompt asks you to retype the password to verify your first entry.



4. Retype the password then press **ENTER**.

After setting the password, the system automatically sets the Setup Password parameter to **Present**. The next time you want to enter the BIOS utility, you must key-in your Setup password.

If You Forget the Password

If you forget your password, you must return the configuration values stored in CMOS to their default values. Should this happen, call your dealer for assistance.

4.4.5 Power On Password

The Power On Password secures your system against unauthorized use. Once you set this password, you have to type it whenever you boot the system. To set this password, follow the same procedure as in setting the Setup password.

4.5 PCI System Configuration

The PCI System Configuration allows you to specify the settings for your PCI devices.

PCI System Configuration		Page 1/1			
PCI IRQ Setting	[Auto]				
		INTA	INTB	INTC	INTD
*PCI Slot 1.....	[--]	[--]	[--]	[--]	[--]
*PCI Slot 2.....	[--]	[--]	[--]	[--]	[--]
*PCI Slot 3.....	[--]	[--]	[--]	[--]	[--]
*PCI Slot 4.....	[--]	[--]	[--]	[--]	[--]
*PCI Slot 5.....	[--]	[--]	[--]	[--]	[--]
*PCI Slot 6.....	[--]	[--]	[--]	[--]	[--]
VGA Palette Snoop	[Disabled]				
Onboard SCSI	[Enabled]				
*Boot Device	[Enabled]				

↑↓ = Move Highlight Bar, → ← = Change Setting
PgDn/PgUp = Move Screen, Esc = Exit

4.5.1 PCI IRQ Setting

This parameter allows for Auto or Manual configuration of PCI devices. If you use plug-and-play (PnP) devices, you can keep the default setting Auto. The system then automatically configures the PnP devices. If your PCI device is not a PnP, you can manually assign the interrupt for each device. Refer to your manual for technical information about the PCI card.







If you set this parameter to Manual and you enabled the onboard SCSI, make sure that you assign the onboard SCSI IRQ to PCI Slot 4.

PCI Slots

These parameters allow you to specify the appropriate interrupt for each of the PCI devices. You can assign IRQ3, IRQ4, IRQ5, IRQ7, IRQ9, IRQ10, IRQ11, IRQ12, IRQ14, or IRQ15 to the slots.



Make sure that the interrupt you assign in any of the PCI slots are not used by other devices to avoid conflicts.

Press  or  to move between fields. Press  or  to select options.

4.5.2 VGA Palette Snoop

PCI devices support the palette snooping technique that enables the device to control access to their palette registers. Set this parameter to `Enabled` if you installed a video card in the ISA bus slot. Set this parameter to `Disabled` if you don't have a video card installed.

4.5.3 Onboard SCSI

This parameter allows you to enable or disable the SCSI feature.

Boot Device

This parameter allows you to enable or disable the onboard SCSI boot priority. Setting this item to `Enabled` allows the onboard SCSI device to be the first priority boot device.

4.6 Non-PnP ISA Card Configuration

The Non-PnP ISA Card Configuration parameters allow you to specify the settings for cards without the plug-and-play (PnP) feature.

Non-PnP ISA Card Configuration		Page 1/3
IRQ/DMA		
IRQ 00....[---]*	IRQ 08 ...[---]*	DMA 0 ...[No]
IRQ 01....[---]*	IRQ 09 ...[No]	DMA 1 ...[No]
IRQ 02....[---]*	IRQ 10 ...[No]	DMA 2 ...[---]*
IRQ 03....[No]	IRQ 11 ...[No]	DMA 3 ...[No]
IRQ 04....[No]	IRQ 12 ...[No]	DMA 4 ...[---]*
IRQ 05....[No]	IRQ 13 ...[---]*	DMA 5 ...[No]
IRQ 06....[---]*	IRQ 14 ...[---]*	DMA 6 ...[No]
IRQ 07....[No]	IRQ 15 ...[No]	DMA 7 ...[No]
Expansion ROM Region		
C8000h - CBFFFh.... [No]	D4000h - D7FFFh.... [No]	
CC000h - CFFFFh.... [No]	D8000h - DBFFFh.... [No]	
D0000h - D3FFFh.... [No]	DC000h - DFFFFh.... [No]	
↑↓ = Move Highlight Bar, → ← = Change Setting PgDn/PgUp = Move Screen, Esc = Exit		



The grayed items (denoted with asterisks) have fixed settings and are not user-configurable.

Non-PnP ISA Card Configuration			Page 2/3
I/O Region			
100h-10Fh .. [No]	200h-20Fh.. [No]	300h-30Fh . [No]	
110h-11Fh .. [No]	210h-21Fh.. [No]	310h-31Fh . [No]	
120h-12Fh .. [No]	220h-22Fh.. [No]	320h-32Fh . [No]	
130h-13Fh .. [No]	230h-23Fh.. [No]	330h-33Fh . [No]	
140h-14Fh .. [No]	240h-24Fh.. [No]	340h-34Fh . [No]	
150h-15Fh .. [No]	250h-25Fh.. [No]	350h-35Fh . [No]	
160h-16Fh .. [No]	260h-26Fh.. [No]	360h-36Fh . [No]	
170h-17Fh .. [No]	270h-27Fh.. [No]	370h-37Fh . [No]	
180h-18Fh .. [No]	280h-28Fh.. [No]	380h-38Fh . [No]	
190h-19Fh .. [No]	290h-29Fh.. [No]	390h-39Fh . [No]	
1A0h-1AFh .. [No]	2A0h-2AFh.. [No]	3A0h-3AFh . [No]	
1B0h-1BFh .. [No]	2B0h-2BFh.. [No]	3B0h-3BFh . [No]	
1C0h-1CFh .. [No]	2C0h-2CFh.. [No]	3C0h-3CFh . [No]	
1D0h-1DFh .. [No]	2D0h-2DFh.. [No]	3D0h-3DFh . [No]	
1E0h-1EFh .. [No]	2E0h-2EFh.. [No]	3E0h-3EFh . [No]	
1F0h-1FFh .. [---]*	2F0h-2FFh.. [No]	3F0h-3FFh . [No]	
↑↓ = Move Highlight Bar, → ← = Change Setting PgDn/PgUp = Move Screen, Esc = Exit			

Non-PnP ISA Card Configuration		Page 3/3
Local Memory Region		
1MB - 2MB	[No]	
2MB - 3MB	[No]	
3MB - 4MB	[No]	
4MB - 5MB	[No]	
5MB - 6MB	[No]	
6MB - 7MB	[No]	
7MB - 8MB	[No]	
8MB - 9MB	[No]	
9MB - 10MB	[No]	
10MB - 11MB	[No]	
11MB - 12MB	[No]	
12MB - 13MB	[No]	
13MB - 14MB	[No]	
15MB - 16MB	[No]	
↑↓ = Move Highlight Bar, → ← = Change Setting PgDn/PgUp = Move Screen, Esc = Exit		



Refer to your non-PnP ISA card manual when setting the following parameters.

4.6.1 IRQ/DMA

This parameter allows you to assign specific IRQ and DMA channels to non-PnP ISA cards. The system will not use such IRQ and DMA channels when it automatically assigns channels to PnP cards.

4.6.2 Expansion ROM Region

This parameter specifies the memory regions available for add-on card use. It allows you to manually assign specific regions to non-PnP cards so that the system will not use those regions anymore when it automatically configures PnP cards.

4.6.3 I/O Region

The items under this parameter allow you to reserve 16-byte memory address ranges for non-PnP cards. When the system configures PnP cards, the address ranges that you marked will not be used anymore.

You can assign memory addresses to non-PnP cards at random as long as you cover the address range required by the card. For example, for a card that requires 178h-188h address, you have to set regions 170h-17Fh and 180h-18Fh to Yes.

4.6.4 Local Memory Region

The items under this parameter allow you to reserve areas in the local memory region for non-PnP cards. When the system configures PnP cards, the memory areas that you marked will not be used anymore.

4.7 Load Setup Default Settings

Use this option to load the default settings for the optimized system configuration. When you load the default settings, some of the parameters are grayed-out with their fixed settings. These grayed parameters are not user-configurable. If you want to change the settings of these items, disable the Fast Boot Mode parameter in the Basic System Configuration menu.

The following dialog box appears when you select Load Setup Default Settings from the main menu.

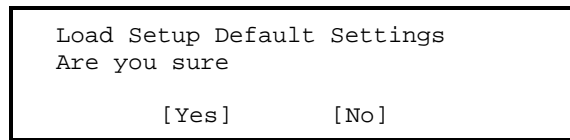

Select [Yes] to load the default settings.

4.8 Leaving Setup

Examine the system configuration values. When you are satisfied that all the values are correct, write them down. Store the recorded values in a safe place. In the future, if the battery loses power or the CMOS chip is damaged, you will know what values to enter when you rerun Setup.

Press **ESC** to leave the system configuration setup. If there is any change in the BIOS utility functions, the following screen appears:

```
Do you want to save CMOS data?
      [Yes]      [No]
```

Use the arrow keys to select your response. Select **Yes** to store the new data in CMOS. Select **No** to retain the old configuration values. Press **ENTER**.

Diagnostics and Utilities

5.1 EISA Configuration Utility v3.0

The EISA Configuration Utility (ECU) is a program that allows you to easily configure your EISA computer. Use this utility when you set up your EISA computer for the first time or any time you change your configuration by adding or removing an EISA or ISA board. The program stores the configuration information the computer's nonvolatile memory where it is available whenever you use your computer.

5.1.1 Functions

The ECU does the following:

















- Supports EISA and ISA boards, PCI devices, and plug-and-play ISA boards.
- Automatically detects EISA boards, PCI devices, and plug-and-play ISA boards installed in the computer.
- Helps you configure ISA board by providing the appropriate switch and jumper settings.
- Notifies you immediately if a conflict occurs during configuration.
- Creates and maintains the System Configuration Information (SCI) file as a backup for the computer's nonvolatile memory.
- Supports configuration (CFG) file extensions.
- Allows you to set the computer's date and time.

5.1.2 Making Menu Selections

You can either use the keyboard or the mouse to make menu selections in the EISA Configuration Utility program.

Using the Keyboard

Table 5-1 Keyboard Function Keys

Key	Function
Tab or 	Moves the cursor to the next field
 + Tab or 	Moves the cursor to the previous field
 or 	Moves the cursor between items within a list
	Selects an item
	Cancels the most recent action
 ,  ,  or 	Scrolls a screen
	Moves the cursor to the top of a list
	Moves the cursor to the bottom of a list
 + 	Moves the cursor to the beginning of a menu
 + 	Moves the cursor to the end of a menu

Using the mouse

Follow these steps to use the mouse when making menu selections:

1. Position the cursor over the desired option then click on the left mouse button to select it.
2. When a sub-menu appears, click on the left button again to make a selection.
3. If a scroll bar appears on the right side of the screen, place the mouse cursor over the arrow at the top or at the bottom of the scroll bar, then click and hold the left mouse button to scroll up or down the page.

5.1.3 Getting Help

The EISA Configuration Utility automatically displays information about each choice on the Main Menu and the second-level menus. The utility also allows you to access an online help once you begin the configuration process.

Press **F1** to display the help menu. Press **ESC** to remove the help menu on the screen.

5.1.4 Program Menus

Follow these steps to use the basic ECU functions:

1. Insert the System Configuration diskette in drive A and turn on the computer. (Reset the system if the power is already on.) The ECU logo screen appears.
2. Press any key to continue. A welcome screen appears.
3. Press **ENTER** to display the main menu.

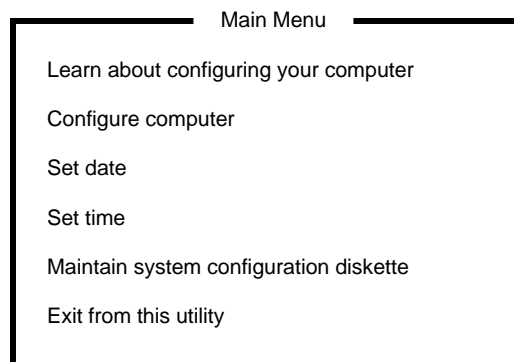

Figure 5-1 ECU Main Menu

Learn About Configuring Your Computer

This item is highlighted when you first enter the main menu. It gives an overview on how to configure your computer with this utility. Press **ENTER** to select this item. Then press the **↑** and **↓** keys to move up or down the text.

Configure Computer

This option allows you to view or change the system configuration. Highlight the option `Configure computer` from the main menu then press **ENTER** to display the following screen.

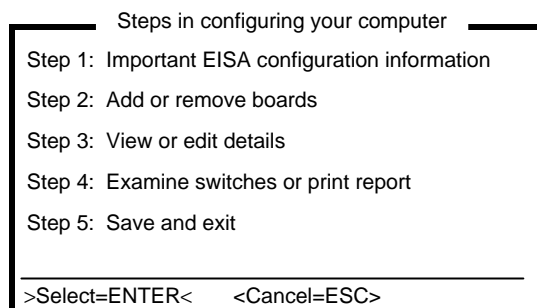

Figure 5-2 Steps in Configuring Your Computer

See section 5.1.5 for more information on configuring your computer.

Setting the Date and Time

The Set Date and Set Time options allow you to set your computer date and time. Once you set the date and time, your computer will keep track of it, even when the power is turned off.



If you want to set the date and time for your computer, you must do so before you configure the system.

Maintain System Configuration Diskette

The System Configuration diskette contains the Configuration Utility and CFG files. When you run the utility to configure your computer, the configuration information is stored in the computer's nonvolatile memory and in a system configuration information (SCI) file, which is stored in the System Configuration diskette.

Select the **Maintain system configuration diskette** option from the main menu to display the following screen.

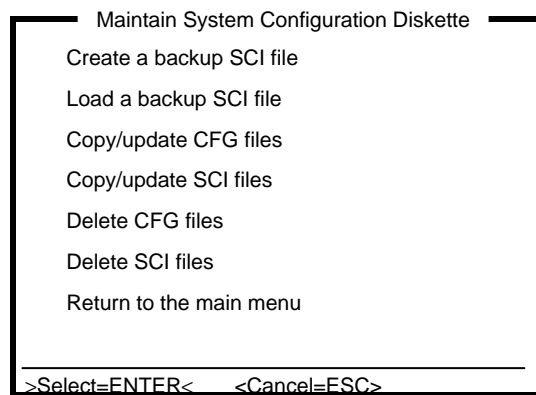

Figure 5-3 Maintain Configuration Diskette

Exit from this Utility

This selection exits the utility. The system reboots. If you do not have an operating system installed on your hard disk, replace the system utilities diskette in the diskette drive with an operating system diskette.



All the ECU screens have a command bar at the bottom to guide through the utility.

5.1.5 Configuring Your Computer for the First Time

Follow these steps when configuring your computer for the first time:

1. Select **Configure computer** from the main menu. See section 5.1.4 on how to access the main menu. The **Steps in configuring your computer** screen appears.
2. Select **Step 1: Important EISA configuration information** from the menu to display the following screen.

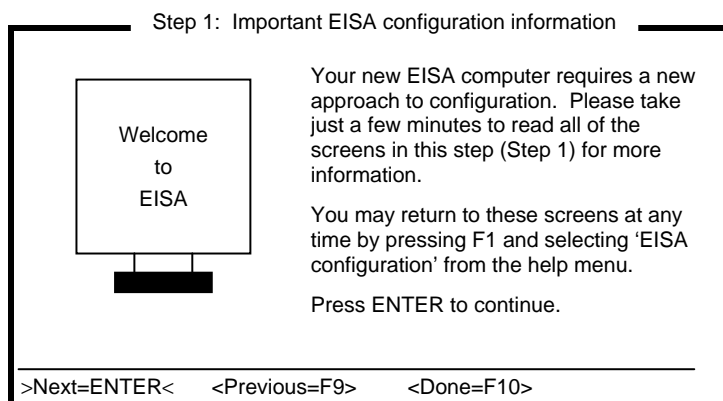

Figure 5-4 Important EISA Configuration Information

3. Read through the information then press **F10** when you are done.
4. Select **Step 4: Examine switches or print report**, then press **ENTER** to display the screen as in Figure 5-5.

Step 4: Examine switches or print report

You must PHYSICALLY verify that the switches and jumpers of each board marked with an arrow (→) are set as required. These settings cannot be detected or changed by this program.

To view the required settings for the highlighted board, press ENTER. Pick up the board and compare its settings to the required settings. Change the board settings to match the required settings.

```
> System AcerAltos Server
Slot 1 (Empty)
Slot 2 (Empty)
Slot 3 (Empty)
Embedded PCI SCSI Controller
```

>View=ENTER< <Print=F7> <Done=F10>

Figure 5-5 Examine Switches or Print Report

5. Notice the boards marked with an arrow on the screen, if any. The arrow indicates that the boards in your computer may have defined jumpers and switches that you must physically verify. It may also mean that there is a software statement with additional information about the board.
6. To view the switch and jumper settings, highlight the board marked with an arrow and press **ENTER**. The switch/jumpers settings screen for the board appears.
7. Scroll through the switch and jumper settings for the board, and press **F10** when you have finished viewing the information.

-
8. To print the information, select Print by pressing **F7**. The Print Settings screen appears.
- If you have a printer attached to your computer, select Print all configuration settings or Print settings for selected board or option then press **ENTER** to print a hard copy of the switch and jumper settings and other configuration information.
 - If you do not have a printer, select Print all configuration settings to a file or Print settings for selected board or option to a file. A Print Information to TXT File screen appears.
 - If you want to print the switch and jumper settings to a different diskette, insert a diskette in drive A and press **ENTER**. Another Print Information to TXT File screen appears. Enter the name of your file or choose an existing filename and press **ENTER**.



If you inserted a different diskette, remember to reinsert the System Configuration diskette after printing is complete.

9. Press **F10** when you are through. The Steps in configuring your computer reappears.

-
10. Select Step 5: Save and exit then press **ENTER**. The following screen appears.

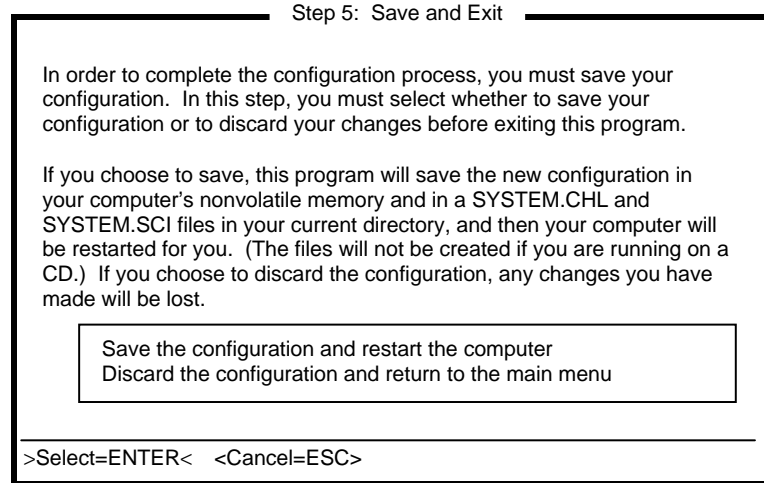

Figure 5-6 Save and Exit

11. To save your changes, select the Save the configuration and restart the computer then press **ENTER**.

To discard the changes, choose the option Discard the configuration and return to the main menu. Any changes that you made are lost.

12. When the reboot screen appears, press **ENTER**.
13. Turn off the computer and remove the System Configuration diskette.

5.1.6 Adding or Removing Boards

Each time you add or remove a board, you must reconfigure the computer using the EISA Configuration Utility program.

Adding Boards



If you are adding a PCI device or a plug-and-play ISA board, proceed to step 5.

PCI devices and plug-and-play (PnP) ISA boards do not require a corresponding CFG file. The configuration information is already stored on the board.

Follow these steps when adding a board:

1. Select `Maintain system configuration diskette` from the main menu then press `ENTER`.
2. From the screen that appears, select `Copy/update CFG files` then press `ENTER`. A list of CFG files from your system configuration diskette appears.



The EISA Configuration Utility uses the CFG file to configure the board into the system without creating conflict with other boards or devices.

3. Select the appropriate CFG files then press `ENTER` to return to `Maintain system configuration diskette` screen.
4. Select the option `Return to the main menu` then press `ENTER`.
5. From the main menu, select the option `Configure computer` then press `ENTER`. The screen `Steps in configuring your computer` appears.

6. Select Step 2: Add or remove boards then press **ENTER** to display the following screen.

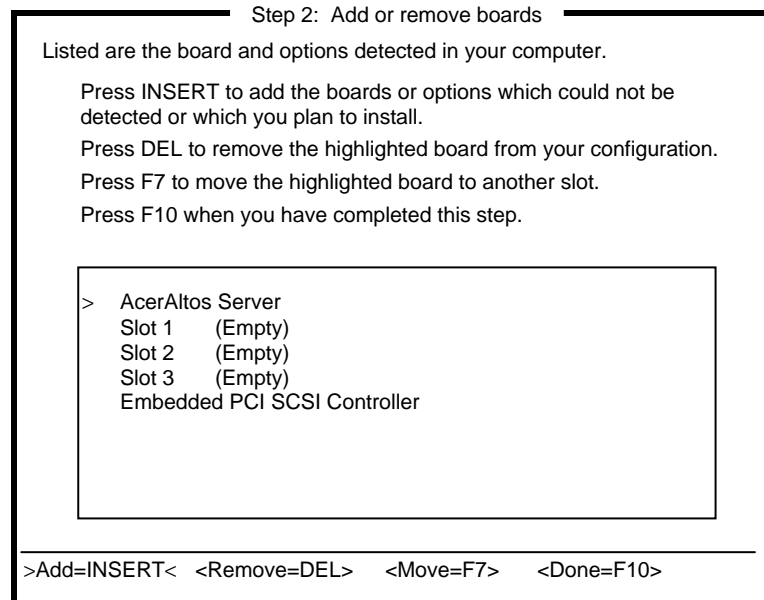

Figure 5-7 Add or Remove Boards

The screen contains the configuration data that the ECU read from your CFG file. It includes the number of EISA slots and device controllers detected.

7. If you want to add or have already added a board, highlight a slot and press **INS** to select an option from the list that appears.
8. Press **F10** when done.
9. Follow steps 4 to 13 in section 5.1.5 to complete your configuration.

Removing a Board

Follow these steps when you remove a board:

1. Do steps 5 and 6 in section 5.1.6.
2. Select the board that you want to remove from the configuration and press **DEL**. A remove confirmation screen appears.
3. Press **ENTER**. The Step 2: Add or remove boards screen reappears.
4. Press **F10** when done.
5. Follow steps 4 to 13 in section 5.1.5 to complete your configuration.

5.1.7 Viewing or Editing Configuration Details

The ECU also allows you to view or edit your system configuration information. You may have to edit your system settings when you add or remove boards, when you made any other hardware changes, or when there are device assignment conflicts.

To view or edit your configuration, simply click on Step 3: View or edit details from the main menu then press **ENTER** to display the screen as in Figure 5-8.

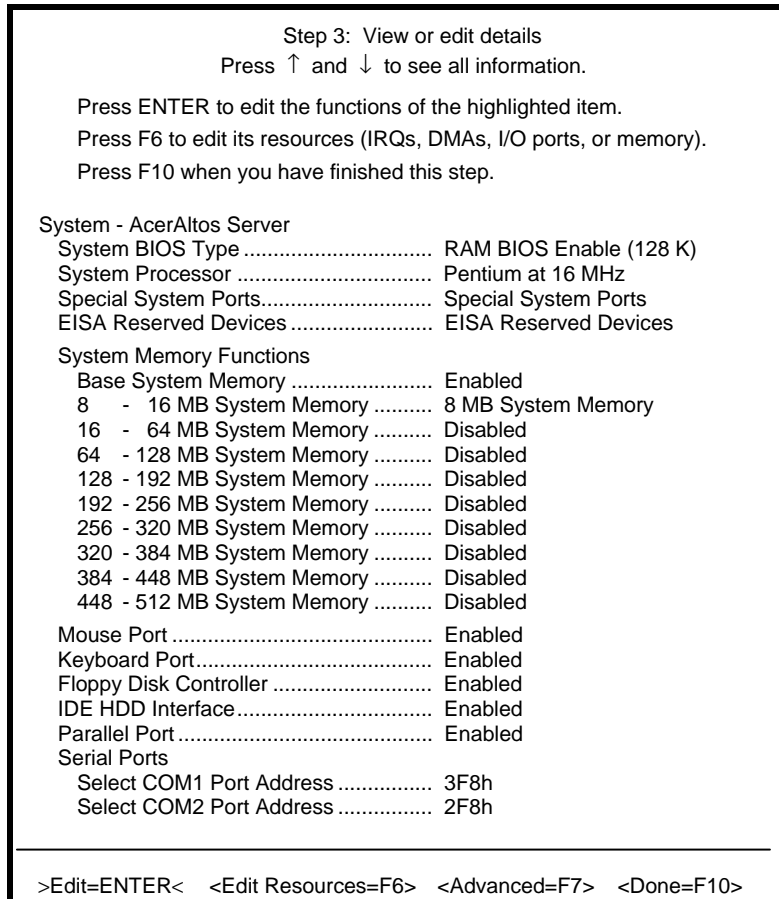

Figure 5-8 View or Edit Details

See the next page for continuation of the above screen.

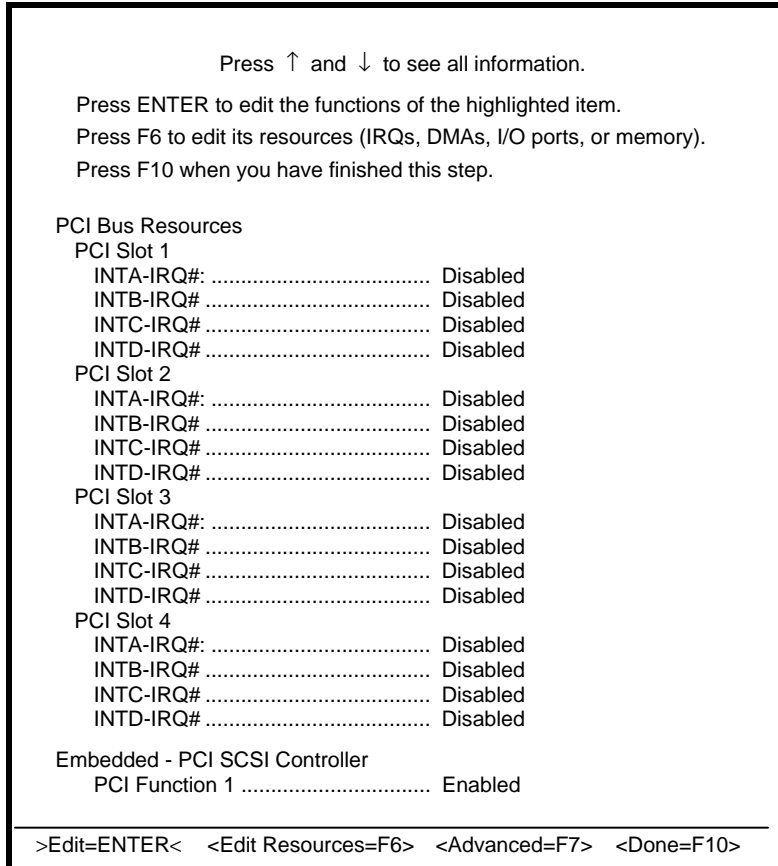

Figure 5-8 View or Edit Details (continued from previous page)



The configuration data on the above screen depend on your CFG file and may not be exactly the same as the one on your actual screen.

5.2 Remote Diagnostic Management

This feature is not available and the RDM mode number should be set to Disabled in the BIOS utility.

System Guide apricot FT2200



15760431



MITSUBISHI ELECTRIC PC DIVISION

APRICOT COMPUTERS LIMITED
3500 PARKSIDE
BIRMINGHAM BUSINESS PARK
BIRMINGHAM B37 7YS
UNITED KINGDOM

The Apricot logo, featuring the word "apricot" in a lowercase, white, sans-serif font with a small leaf-like graphic above the letter 'i'.

<http://www.apricot.co.uk>