

Fast Serial Port Super I/O Floppy Disk Controllers

FEATURES

- 2.88MB Super I/O Floppy Disk Controller
 - Licensed CMOS 765B Floppy Disk Controller
 - Software and Register Compatible to the 82077AA Using SMC's Proprietary Floppy Disk Controller Core
 - Supports Vertical Recording Format
 - 100% IBM® Compatibility
 - Detects All Overrun and Underrun Conditions
 - 48 mA Drivers and Schmitt Trigger Inputs
 - DMA Enable Logic
 - Data Rate and Drive Control Registers
 - Swap Drives A and B
 - Non-Burst Mode DMA Option
 - FDC Primary/Secondary Address Selection
 - 16 Byte Data FIFO
 - Low Power CMOS 0.8 μ Design
- Hardware/Socket Compatible with FDC37C651 and FDC37C661
- Enhanced Digital Data Separator
 - Low Cost Implementation - 24 MHz Crystal
 - No Filter Components Required
 - Ease of Test and Use, Lower System Cost, and Reduced Board Area
 - 1 Mb/s, 500 Kb/s, 300 Kb/s, 250 Kb/s Data Rates
- Supports Floppy Disk Drives and Tape Drives
- Programmable Precompensation Modes
- Parallel Port with ChiProtect™ Circuitry
 - Standard Mode
 - IBM PC/XT®, PC/AT®, and PS/2™ Compatible Bidirectional Parallel Port
 - Incorporates ChiProtect Circuitry for Protection Against Damage Due to Printer Power-On
 - 24 mA Output Drivers
- Serial Ports
 - Two High Speed NS16C550 Compatible UARTs with Send/Receive 16 Byte FIFOs
 - MIDI Compatible
 - Programmable Baud Rate Generator
 - Modem Control Circuitry
- IDE Interface
 - On-Chip Decode and Select Logic Compatible with IBM PC/XT and PC/AT Embedded Hard Disk Drives
 - IDE Primary/Secondary Address Selection
- Supports Four Floppy Drives Directly
- General Purpose 10 Bit Address Decoder
- Game Port Select Logic (FDC37C664 Only)
- 100 Pin QFP Package

TABLE OF CONTENTS

FEATURES	1
GENERAL DESCRIPTION	3
PIN CONFIGURATION	4
DESCRIPTION OF PIN FUNCTIONS	5
FUNCTIONAL DESCRIPTION	21
SUPER I/O REGISTERS	21
HOST PROCESSOR INTERFACE	21
FLOPPY DISK CONTROLLER	22
FLOPPY DISK CONTROLLER INTERNAL REGISTERS	22
COMMAND SET/DESCRIPTIONS	45
INSTRUCTION SET	49
SERIAL PORT (UART)	75
PARALLEL PORT	89
INTEGRATED DRIVE ELECTRONICS INTERFACE	92
CONFIGURATION	96
OPERATIONAL DESCRIPTION	110
MAXIMUM GUARANTEED RATINGS	110
DC ELECTRICAL CHARACTERISTICS	110
TIMING DIAGRAMS	113

Note: This data sheet corresponds to Revision C of the FDC37C663/FDC37C664. The revision letter is denoted by the first character of the date code. For specification changes, if any, for revisions other than Revision C, please contact SMC.

GENERAL DESCRIPTION

The SMC FDC37C663 and FDC37C664 Fast Serial Port Super I/O Floppy Disk Controller ICs utilize SMC's proven SuperCell technology for increased product reliability and functionality. The FDC37C663 is optimized for motherboard applications while the FDC37C664 is oriented towards controller card applications. Both devices support 1 Mb/s data rates for vertical recording operation. The FDC37C663 is hardware compatible with the FDC37C651 and FDC37C661.

The FDC37C663 and FDC37C664 incorporate SMC's true CMOS 765B floppy disk controller, advanced digital data separator, 16 byte data FIFO, two 16C550 compatible UARTs, one parallel port which includes ChiProtect circuitry, IDE interface, on-chip 24 mA AT bus drivers, game port chip select (FDC37C664 only), general purpose address decoder and four floppy direct drive support. The true CMOS 765B core provides 100% compatibility with IBM PC/XT and PC/AT architectures in addition to providing data overflow and underflow protection. The SMC advanced digital data separator incorporates SMC's patented data separator technology, allowing for ease of testing and use. Both on-chip UARTs are

compatible with the NS16C550. The parallel port, the IDE interface and the game port select logic are compatible with IBM PC/XT and PC/AT architectures. The FDC37C663 and FDC37C664 incorporate sophisticated power control circuitry (PCC). The PCC supports multiple low power down modes.

The FDC37C663 Floppy Disk Controller incorporates Software Configurable Logic (SCL) for ease of use. Use of the SCL feature allows programmable system configuration of key functions such as the FDC, parallel port, and UARTs. The parallel port ChiProtect prevents damage caused by the printer being powered when the FDC37C663 or FDC37C664 is not powered.

The FDC37C663 and FDC37C664 do not require any external filter components and are, therefore, easy to use and offer lower system cost and reduced board area. The FDC37C663 and FDC37C664 are software and register compatible to the 82077AA using SMC's proprietary floppy disk controller core.

IBM, PC/XT and PC/AT are registered trademarks and PS/2 is a trademark of International Business Machines Corporation. SMC is a registered trademark and ChiProtect and SuperCell are trademarks of Standard Microsystems Corporation.

PIN CONFIGURATION

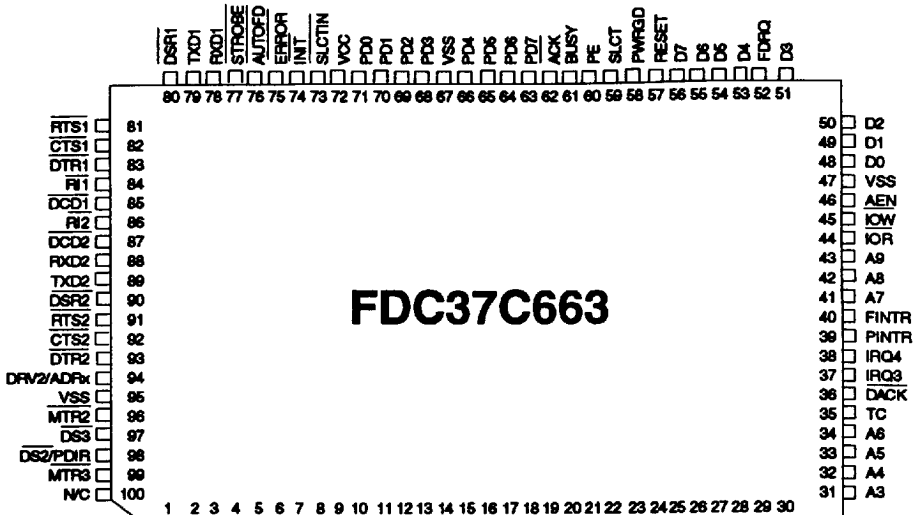

FDC37C663

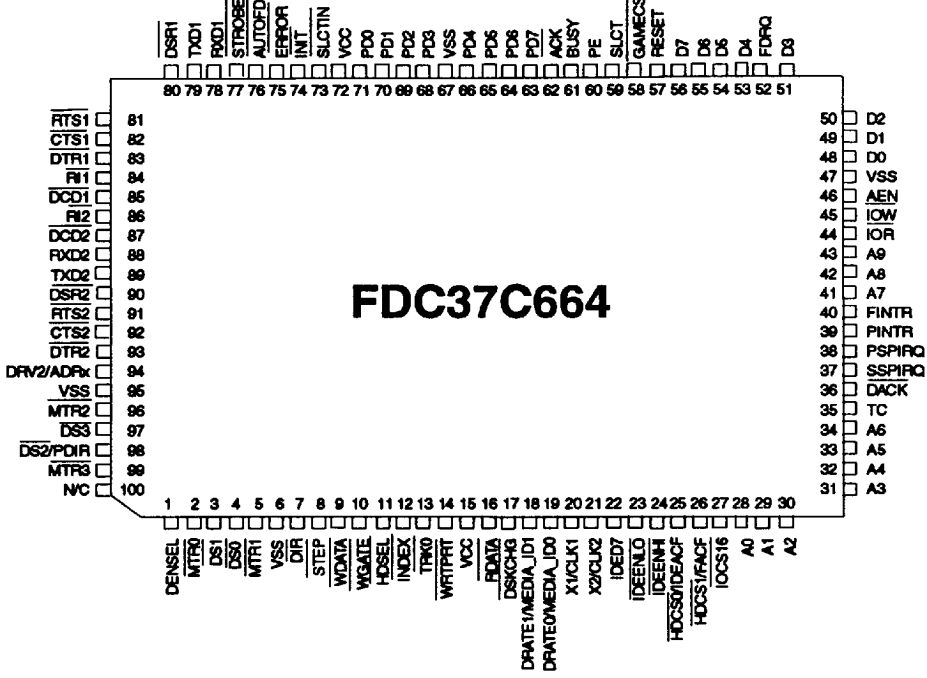

FDC37C664

■ 8564686 0008428 187 ■

DESCRIPTION OF PIN FUNCTIONS

PIN NO.	NAME	SYMBOL	BUFFER TYPE	DESCRIPTION
HOST PROCESSOR INTERFACE				
48-51 53-56	Data Bus 0-7	D0-D7	I/O24	The data bus connection used by the host microprocessor to transmit data to and from the FDC37C663. These pins are in a high-impedance state when not in the output mode.
44	I/O Read	\overline{IOR}	I	This active low signal is issued by the host microprocessor to indicate a read operation.
45	I/O Write	\overline{IOW}	I	This active low signal is issued by the host microprocessor to indicate a write operation.
46	Address Enable	AEN	I	Active high Address Enable indicates DMA operations on the host data bus. Used internally to qualify appropriate address decodes.
28-34 41-43	I/O Address	A0-A9	I	These host address bits determine the I/O address to be accessed during \overline{IOR} and \overline{IOW} cycles. These bits are latched internally by the leading edge of \overline{IOR} and \overline{IOW} .
52	FDC DMA Request	FDRQ	O24	This active high output is the DMA request for byte transfers of data to the host. This signal is cleared on the last byte of the data transfer by the \overline{DACK} signal going low (or by \overline{IOR} going low if \overline{DACK} was already low as in demand mode).
36	$\overline{\text{DMA Acknowledge}}$	\overline{DACK}	I	An active low input acknowledging the request for a DMA transfer of data. This input enables the DMA read or write internally.
35	Terminal Count	TC	I	This signal indicates to the FDC37C663 that data transfer is complete. TC is only accepted when \overline{DACK} is low. In AT and PS/2 model 30 modes, TC is active high and in PS/2 mode, TC is active low.

DESCRIPTION OF PIN FUNCTIONS

PIN NO.	NAME	SYMBOL	BUFFER TYPE	DESCRIPTION
38	Serial Port Interrupt Request	IRQ4	O24	FDC37C663 (Motherboard application): IRQ4 is the interrupt from the Primary Serial Port (PSP) or Secondary Serial Port (SSP) when the PSP or SSP have their address programmed as COM1 or COM3 (as defined in the Configuration Registers). The appropriate interrupt from the Serial Port is enabled/disabled via the Interrupt Enable Register (IER). The interrupt is reset inactive after interrupt service. It is disabled through IER or hardware reset.
	Primary Serial Port Interrupt	PSPIRQ	O24	FDC37C664 (Adapter application): PSPIRQ is a source of PSP interrupt. Externally, it should be connected to either IRQ3 or IRQ4 on PC/AT via jumpers.
37	Serial Port Interrupt Request	IRQ3	O24	FDC37C663 (Motherboard application): IRQ3 is the interrupt from the Primary Serial Port (PSP) or secondary Serial Port (SSP) when the PSP or SSP have their address programmed as COM2 or COM4 (as defined in the Configuration Registers). The appropriate interrupt from the Serial Port is enabled/disabled via the Interrupt Enable Register (IER). The interrupt is reset inactive after interrupt service. It is disabled through IER or hardware reset.
	Secondary Serial Port Interrupt	SSPIRQ	O24	FDC37C664 (Adapter application): SSPIRQ is a source of SSP interrupt. Externally, it should be connected to either IRQ3 or IRQ4 on PC/AT via jumpers.
40	Floppy Controller Interrupt Request	FINTR	O24	This interrupt from the Floppy Disk Controller is enabled/disabled via bit 3 of the Digital Output Register (DOR).
39	Parallel Port Interrupt Request	PINTR	O24	This interrupt from the Parallel Port is enabled/disabled via bit 4 of the Parallel Port Control Register. Refer to configuration register CR1 for more information.

DESCRIPTION OF PIN FUNCTIONS

PIN NO.	NAME	SYMBOL	BUFFER TYPE	DESCRIPTION
57	Reset	RST	IS	This active high signal resets the FDC37C663 and must be valid for 500 ns minimum. The effect on the internal registers is described in the appropriate section. The configuration registers are not affected by this reset. In the FDC37C664, the falling edge of reset latches the jumper configuration. The jumper select lines must be valid 50 ns prior to this edge.
FLOPPY DISK INTERFACE				
16	Read Disk Data	RDATA	IS	Raw serial bit stream from the disk drive, low active. Each falling edge represents a flux transition of the encoded data.
10	Write Gate	WGATE	OD48	This active low high current driver allows current to flow through the write head. It becomes active just prior to writing to the diskette.
9	Write Data	WDATA	OD48	This active low high current driver provides the encoded data to the disk drive. Each falling edge causes a flux transition on the media.
11	Head Select	HSEL	OD48	This high current output selects the floppy disk side for reading or writing. A logic "1" on this pin means side 0 will be accessed, while a logic "0" means side 1 will be accessed.
7	Direction Control	DIR	OD48	This high current low active output determines the direction of the head movement. A logic "1" on this pin means outward motion, while a logic "0" means inward motion.
8	Step Pulse	STEP	OD48	This active low high current driver issues a low pulse for each track-to-track movement of the head.

DESCRIPTION OF PIN FUNCTIONS

PIN NO.	NAME	SYMBOL	BUFFER TYPE	DESCRIPTION
17	Disk Change	$\overline{\text{DSKCHG}}$	IS	This input senses that the drive door is open or that the diskette has possibly been changed since the last drive selection. This input is inverted and read via bit 7 of I/O address 3F7H.
4,3	$\overline{\text{Drive Select 0,1}}$	$\overline{\text{DS0,1}}$	OD48	Active low open drain outputs select drives 0-1. Refer to Note 2.
98	$\overline{\text{Drive Select 2}}$	$\overline{\text{DS2}}$	OD48	Active low open drain output selects drives 2. Refer to Note 2.
97	$\overline{\text{Drive Select 3}}$	$\overline{\text{DS3}}$	OD48	Active low open drain output selects drive 3. Refer to Note 2.
2,5	$\overline{\text{Motor On 0,1}}$	$\overline{\text{MTR0,1}}$	OD48	These active low open drain outputs select motor drives 0-1. Refer to Note 1.
96	$\overline{\text{Motor On 2}}$	$\overline{\text{MTR2}}$	OD48	Motor On 2: Refer to Note 1.
9	$\overline{\text{Motor On 3}}$	$\overline{\text{MTR3}}$	OD48	Motor On 3: Refer to Note 1.
1	Density Select	DENSEL	OD48	Indicates whether a low (250/300 Kb/s) or high (500 Kb/s) data rate has been selected. This is determined by the IDENT bit in Configuration Register 3.
14	$\overline{\text{Write Protected}}$	$\overline{\text{WRTPRT}}$	IS	This active low Schmitt Trigger input senses from the disk drive that a disk is write protected. Any write command is ignored.
13	Track 00	$\overline{\text{TR0}}$	IS	This active low Schmitt Trigger input senses from the disk drive that the head is positioned over the outermost track.
12	Index	INDEX	IS	This active low Schmitt Trigger input senses from the disk drive that the head is positioned over the beginning of a track, as marked by an index hole.

DESCRIPTION OF PIN FUNCTIONS

PIN NO.	NAME	SYMBOL	BUFFER TYPE	DESCRIPTION
19,18	Data Rate 0, Data Rate 1	DRATE0, DRATE1	O8	These two outputs reflect bits 0 and 1 respectively of the Data Rate Register. At power on, these two outputs are in a high impedance state (refer to Table 44).
	Media ID 0, Media ID 1	MEDIA_ID0, MEDIA_ID1	I	In Floppy Enhanced Mode 2 - These bits are the Media ID 0,1 inputs. The value of these bits can be read as bits 6 and 7 of the Floppy Tape register.
SERIAL PORT INTERFACE				
78,88	Receive Data	RXD1, RXD2	I	Receiver serial data input.
79	Transmit Data	TXD1	O4	Transmitter serial data output from Primary Serial Port.
		PCFO	I	FDC37C664 (Adapter Mode): Parallel Port Configuration Control 0. During reset active this input is read and latched to define the address of the Parallel Port.
81	<u>Request to Send</u>	<u>RTS1</u>	O4	Active low Request to Send output for Primary Serial Port. Handshake output signal notifies modem that the UART is ready to transmit data. This signal can be programmed by writing to bit 1 of Modem Control Register (MCR). The hardware reset will reset the <u>RTS</u> signal to inactive mode (high). Forced inactive during loop mode operation.
	Parallel Port Configuration Control	PCF1	I	FDC37C664 (Adapter Mode): Parallel Port Configuration Control 1. During reset active this input is read and latched to define the address of the Parallel Port.

DESCRIPTION OF PIN FUNCTIONS

PIN NO.	NAME	SYMBOL	BUFFER TYPE	DESCRIPTION
91	Request to Send	$\overline{RTS2}$	O4	Active low Request to Send output for Secondary Serial Port. Handshake output signal notifies modem that the UART is ready to transmit data. This signal can be programmed by writing to bit 1 of Modem Control Register (MCR). The hardware reset will reset the \overline{RTS} signal to inactive mode (high). Forced inactive during loop mode operation.
	Secondary Serial Port Configuration Control	S2CF0	I	FDC37C664 (Adapter Mode): Secondary Serial Port Configuration Control 0. During Reset active this input is read and latched to define the address of the Secondary Serial Port.
83	Data Terminal Ready	$\overline{DTR1}$	O4	Active low Data Terminal Ready output for primary serial port. Handshake output signal notifies modem that the UART is ready to establish data communication link. This signal can be programmed by writing to bit 0 of Modem Control Register (MCR). The hardware reset will reset the \overline{DTR} signal to inactive mode (high). Forced inactive during loop mode operation.
	IDE Configuration Control	IDECF	I	FDC37C664 (Adapter Mode): IDE Configuration Control. During reset active this input is read and latched to enable/disable the IDE.

DESCRIPTION OF PIN FUNCTIONS

PIN NO.	NAME	SYMBOL	BUFFER TYPE	DESCRIPTION
93	$\overline{\text{Data Terminal Ready}}$	$\overline{\text{DTR2}}$	O4	Active low Data Terminal Ready output for secondary serial port. Handshake output signal notifies modem that the UART is ready to establish data communication link. This signal can be programmed by writing to bit 0 of Modem Control Register (MCR). The hardware reset will reset the $\overline{\text{DTR}}$ signal to inactive mode (high). Forced inactive during loop mode operation.
	Secondary Serial Port Configuration Control 1	S2CF1	I	FDC37C664 (Adapter Mode): Secondary Serial Port Configuration Control 1. During reset active this input is read and latched to define the address of the Secondary Serial Port.
89	Transmit Data 2	TXD2	O4	Transmitter Serial Data output from Secondary Serial Port.
		FDCCF	I	FDC37C664 (Adapter Mode): Floppy Disk Configuration. This input is read and latched during Reset to enable/disable the Floppy Disk Controller.
82,92	$\overline{\text{Clear to Send}}$	$\overline{\text{CTS1}}$, $\overline{\text{CTS2}}$	I	Active low Clear to Send inputs for primary and secondary serial ports. Handshake signal which notifies the UART that the modem is ready to receive data. The CPU can monitor the status of $\overline{\text{CTS}}$ signal by reading bit 4 of Modem Status Register (MSR). A $\overline{\text{CTS}}$ signal state change from low to high after the last MSR read will set MSR bit 0 to a 1. If bit 3 of Interrupt Enable Register is set, the interrupt is generated when $\overline{\text{CTS}}$ changes state. The $\overline{\text{CTS}}$ signal has no effect on the transmitter. Note: Bit 4 of MSR is the complement of CTS.

DESCRIPTION OF PIN FUNCTIONS

PIN NO.	NAME	SYMBOL	BUFFER TYPE	DESCRIPTION
80,90	$\overline{\text{Data Set Ready}}$	$\overline{\text{DSR1}},$ $\overline{\text{DSR2}}$	I	Active low Data Set Ready inputs for primary and secondary serial ports. Handshake signal which notifies the UART that the modem is ready to establish the communication link. The CPU can monitor the status of $\overline{\text{DSR}}$ signal by reading bit 5 of Modem Status Register (MSR). A $\overline{\text{DSR}}$ signal state change from low to high after the last MSR read will set MSR bit 1 to a 1. If bit 3 of Interrupt Enable Register is set, the interrupt is generated when $\overline{\text{DSR}}$ changes state. Note: Bit 5 of MSR is the complement of $\overline{\text{DSR}}$.
85,87	$\overline{\text{Data Carrier Detect}}$	$\overline{\text{DCD1}},$ $\overline{\text{DCD2}}$	I	Active low Data Carrier Detect inputs for primary and secondary serial ports. Handshake signal which notifies the UART that carrier signal is detected by the modem. The CPU can monitor the status of $\overline{\text{DCD}}$ signal by reading bit 7 of Modem Status Register (MSR). A $\overline{\text{DCD}}$ signal state change from low to high after the last MSR read will set MSR bit 3 to a 1. If bit 3 of Interrupt Enable Register is set, the interrupt is generated when $\overline{\text{DCD}}$ changes state. Note: Bit 7 of MSR is the complement of $\overline{\text{DCD}}$.
84,86	$\overline{\text{Ring Indicator}}$	$\overline{\text{RI1}}, \overline{\text{RI2}}$	I	Active low Ring Indicator input for primary and secondary serial ports. Handshake signal which notifies the UART that the telephone ring signal is detected by the modem. The CPU can monitor the status of $\overline{\text{RI}}$ signal by reading bit 6 of Modem Status Register (MSR). A $\overline{\text{RI}}$ signal state change from low to high after the last MSR read will set MSR bit 2 to a 1. If bit 3 of Interrupt Enable Register is set, the interrupt is generated when $\overline{\text{RI}}$ changes state. Note: Bit 6 of MSR is the complement of $\overline{\text{RI}}$.

DESCRIPTION OF PIN FUNCTIONS

PIN NO.	NAME	SYMBOL	BUFFER TYPE	DESCRIPTION
94	Drive 2	DRV2	I	In PS/2 mode, this input indicates whether a second drive is connected; DRV2 should be low if a second drive is connected. This status is reflected in a read of Status Register A. (Only available in FDC37C663. This pin must not be driven in the FDC37C664)
	$\overline{\text{ADR}}_x$	$\overline{\text{ADR}}_x$	O4	Optional I/O port address decode output. Refer to Configuration registers CR3, CR8 and CR9 for more information. Active low. (Available in FDC37C663 and FDC37C664.) Defaults to tri-state after power-up. This pin has a 30 μ a internal pull-up.
PARALLEL PORT INTERFACE				
73	$\overline{\text{Printer Select Input}}$	$\overline{\text{SLCTIN}}$	OD24	This active low output selects the printer. This is the complement of bit 3 of the Printer Control Register.
74	$\overline{\text{Initiate Output}}$	$\overline{\text{INIT}}$	OD24	This output is bit 2 of the printer control register. This is used to initiate the printer when low.
76	$\overline{\text{Autofeed Output}}$	$\overline{\text{AUTOFD}}$	OD24	This output goes low to cause the printer to automatically feed one line after each line is printed. The $\overline{\text{AUTOFD}}$ output is the complement of bit 1 of the Printer Control Register.
77	$\overline{\text{Strobe Output}}$	$\overline{\text{STROBE}}$	OD24	An active low pulse on this output is used to strobe the printer data into the printer. The $\overline{\text{STROBE}}$ output is the complement of bit 0 of the Printer Control Register.
61	Busy	BUSY	I	This is a status output from the printer, a high indicating that the printer is not ready to receive new data. Bit 7 of the Printer Status Register is the complement of the BUSY input.

DESCRIPTION OF PIN FUNCTIONS

PIN NO.	NAME	SYMBOL	BUFFER TYPE	DESCRIPTION
62	<u>Acknowledge</u>	<u>ACK</u>	I	A low active output from the printer indicating that it has received the data and is ready to accept new data. Bit 6 of the Printer Status Register reads the <u>ACK</u> input.
60	Paper End	PE	I	Another status output from the printer, a high indicating that the printer is out of paper. Bit 5 of the Printer Status Register reads the PE input.
59	Printer Selected Status	SLCT	I	This high active output from the printer indicates that it has power on. Bit 4 of the Printer Status Register reads the SLCT input.
75	<u>Error</u>	<u>ERR</u>	I	A low on this input from the printer indicates that there is a error condition at the printer. Bit 3 of the Printer Status register reads the <u>ERR</u> input.
71-68 66-63	Port Data	PD0-PD7	I/OP24	The bi-directional parallel data bus is used to transfer information between CPU and peripherals.
IDE				
23	<u>IDE Low Byte Enable</u>	<u>IDEENLO</u>	O4	This active low signal is used in both the XT and AT mode. In the AT mode, this pin is active when the IDE is enabled and the I/O address is accessing 1F0H-1F7H and 3F6H-3F7H in primary address mode or 170H-177H and 376H,377H in secondary address mode. In the XT mode, this signal is active for accessing 320H-323H, 8 bit programmed I/O or DMA.
		S1CF1	I	FDC37C664 (Adapter Mode): Primary Serial Configuration 1. Read and latched during reset active to select the address of the Secondary Serial Port.

DESCRIPTION OF PIN FUNCTIONS

PIN NO.	NAME	SYMBOL	BUFFER TYPE	DESCRIPTION
24	<u>IDE High Byte Enable</u>	<u>IDEENHI</u>	O4	This signal is active low only in the AT mode, and when IO16CSB is also active. The I/O addresses for which this pin reacts are 1F0H-1F7H in primary address mode or 170H-177H in secondary address mode. This pin is not used in XT mode.
		S1CF0	I	FDC37C664 (Adapter Mode): Primary Serial Configuration 0. Read and latched during reset active to define the address of the Secondary Serial Port.
25	<u>Hard Disk Chip Select</u>	<u>HDCS0</u>	O24	This is the Hard Disk Chip select corresponding to addresses 1F0H-1F7H in primary address mode or 170H-177H in secondary address mode in the AT mode and addresses 320H-323H in the XT mode.
		IDEACF	I	FDC37C664 (Adapter Mode): IDE Address Control. Refer to FDC37C664 hardware configuration for more information. Read and latched during reset active.
26	<u>Hard Disk Chip Select</u>	<u>HDCS1</u>	O24	This is the Hard Disk Chip select corresponding to 3F6H,3F7H for primary address mode or 376H,377H for secondary address mode in the AT mode and addresses 3F6H,3F7H in the XT mode.
		FACF	I	FDC37C664 (Adapter Mode): Floppy Disk Address Control. Refer to FDC37C664 hardware configuration for more information. Read and latched during reset active.

DESCRIPTION OF PIN FUNCTIONS

PIN NO.	NAME	SYMBOL	BUFFER TYPE	DESCRIPTION
27	I/O 16 Bit Indicator	$\overline{\text{IOCS16}}$	I	This input indicates, in AT mode only, when 16 bit transfers are to take place. This signal is generated by the hard disk interface. Logic "0" = 16 bit mode; logic "1" = 8 bit mode.
		$\overline{\text{HDAck}}$	I	In the XT mode, this is the Hard Disk Controller DMA Acknowledge, low active.
22	IDE Data Bit 7	IDED7	I/O24	IDE data bit 7 in the AT mode. IDED7 transfers data at I/O addresses 1F0H-1F7H (R/W), 3F6 (R/W), 3F7(W). IDED7 should be connected to IDE data bit 7. The FDC37C663 functions as a buffer transferring data bit 7 between the IDE device and the host. During I/O read of 3F7H, IDED7 is the FDC disk change bit. In the XT mode, IDE7 is not used.
MISCELLANEOUS				
58	Power Good	PWRGD	I	FDC37C663 (Motherboard Mode): This input indicates that the power (V_{cc}) is valid. For device operation, PWRGD must be active. When PWRGD is inactive, all inputs to the FDC37C663 are disconnected and put in a low power mode, all outputs are put into high impedance. The contents of all registers are preserved as long as V_{cc} has a valid value. The driver current drain in this mode drops to ISTBY - standby current. This input has a weak pullup resistor to V_{cc} .
	Game Port Chip Select	$\overline{\text{GAMECS}}$	O4	FDC37C664 (Adapter Mode): This is the Game Port Chip Select output - active low. It will go active when the I/O address is 201H.
		PADCF	I	FDC37C664 (Adapter Mode): Parallel Port Mode Control. Refer to FDC37C664 hardware configuration for more information. Read and latched during reset active.

DESCRIPTION OF PIN FUNCTIONS

PIN NO.	NAME	SYMBOL	BUFFER TYPE	DESCRIPTION
20	CLOCK 1	X1/CLK1	ICLK	The external connection for a parallel resonant 24 MHz crystal. A CMOS compatible oscillator is required if crystal is not used.
21	CLOCK 2	X2/CLK2	OCLK	24 MHz crystal. If an external clock is used, this pin should not be connected. This pin should not be used to drive any other drivers.
15,72	Power	V _{CC}		+ 5 Volt supply pin.
6,47, 67,95	Ground	GND		Ground pin.

Note 1: These active low open drain outputs select motor drives 0-3. Four drives can be supported directly. These motor enable bits are controlled by software via the Digital Output Register (DOR). MTR0,1 can be used to directly support 2 drives or can support 4 drives by using an external 2 to 4 decoder.

Note 2: Active low open drain outputs select drives 0-3. Four drives can be supported directly. These drive select outputs are a decode of bits 0 and 1 of the Digital Output Register and qualified by the appropriate Motor Enable Bit of the DOR (bits 4-7). DS0,1 can be used to directly support 2 drives or can support 4 drives by using an external 2 to 4 decoder.

BUFFER TYPE DESCRIPTIONS

BUFFER TYPE	DESCRIPTION
I/O24	Input/output. 24 mA sink; 12 mA source
I/OP24	Input/output. 24 mA sink; 4 mA source
O24	Output. 24 mA sink; 12 mA source
OD48	Open drain. 48 mA sink
O4	Output. 4 mA sink; 2 mA source
O8	Output. 8 mA sink; 4 mA source
OD24	Open drain. 24 mA sink
OCLK	Output to external crystal
ICLK	Input to Crystal Oscillator Circuit (CMOS levels)
I	Input TTL compatible.
IS	Input with Schmitt Trigger.

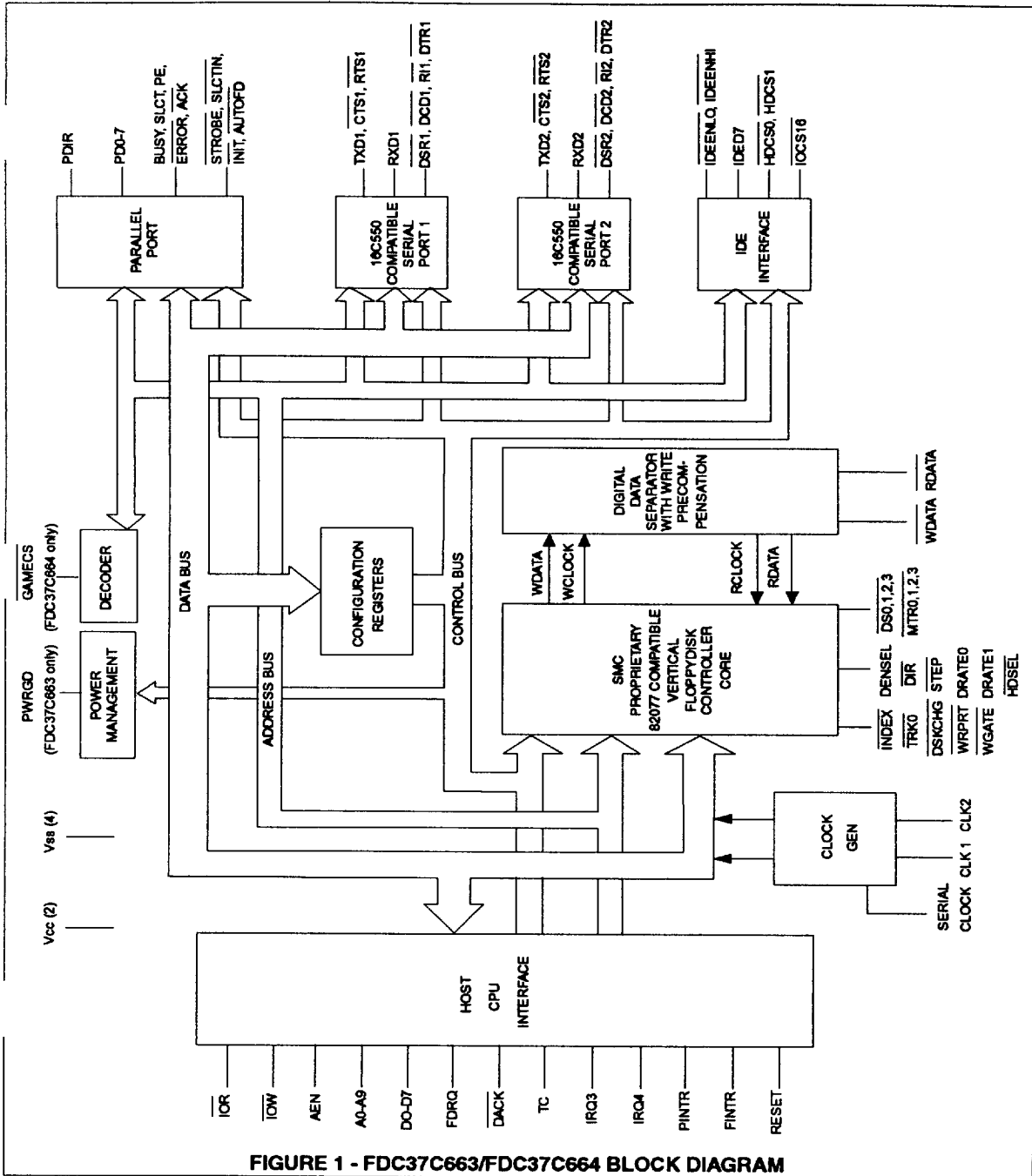

FIGURE 1 - FDC37C663/FDC37C664 BLOCK DIAGRAM

8564686 0008443 493

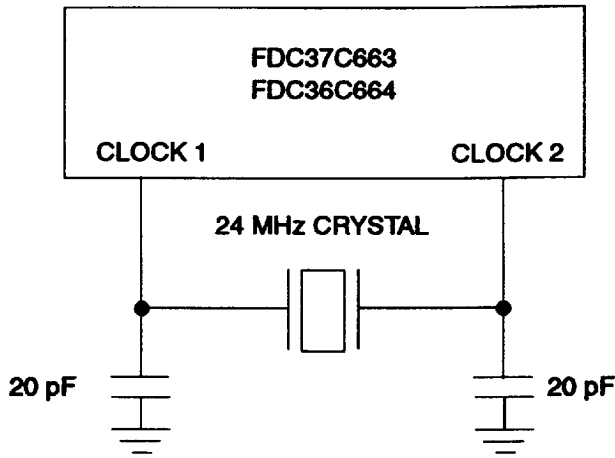

FIGURE 2 - SUGGESTED 24 MHz OSCILLATOR CIRCUIT

FUNCTIONAL DESCRIPTION

SUPER I/O REGISTERS

The address map, shown below in Table 1, shows the addresses of the different blocks of the Super I/O immediately after power up. The base addresses of the FDC, IDE, serial and parallel ports can be moved via the configuration registers. Some addresses are used to access more than one register.

HOST PROCESSOR INTERFACE

The host processor communicates with the FDC37C663/664 through a series of read/write registers. The port addresses for these registers are shown in Table 1. Register access is accomplished through programmed I/O or DMA transfers. All registers are 8 bits wide except the IDE data register at port 1F0H which is 16 bits wide. All host interface output buffers are capable of sinking a minimum of 24 mA.

Table 1 - FDC37C663/664 Block Addresses

ADDRESS	BLOCK NAME	NOTES
3F0, 3F1	Configuration	Write only; Note 1, 2
3F0, 3F1	Floppy Disk	Read only; Address at power up; Note 2
3F2, 3F3, 3F4, 3F5, 3F7	Floppy Disk	Address at power up; Note 2
3F8-3FF	Serial Port Com 1	Address at power up; Note 2
2F8-2FF	Serial Port Com 2	Address at power up; Note 2
278-27A	Parallel Port	Address at power up; Note 2
1F0-1F7, 3F6, 3F7	IDE	AT Mode; Note 2, 3

Note 1: Configuration registers can only be modified in configuration mode, entered only by writing a security code sequence to 3F0. The configuration registers can only be read in configuration mode by accessing 3F1. Access to status registers A and B of the floppy disk is disabled in configuration mode. Outside of configuration mode, a read of 3F0 accesses status register A and a read of 3F1 accesses status register B of the floppy disk.

Note 2: Address at power up; These addresses can be changed in the configuration setup.

Note 3: Addresses 320H-323H and 3F5-3F7H for XT Mode. Selectable in configuration setup.

FLOPPY DISK CONTROLLER

The Floppy Disk Controller (FDC) provides the interface between a host microprocessor and the floppy disk drives. The FDC integrates the functions of the Formatter/Controller, Digital Data Separator, Write Precompensation and Data Rate Selection logic for an IBM XT/AT compatible FDC. The true CMOS 765B core guarantees 100% IBM PC XT/AT compatibility in addition to providing data overflow and underflow protection.

The FDC37C663 and FDC37C664 are compatible to the 82077AA using SMC's proprietary floppy disk controller core.

FLOPPY DISK CONTROLLER INTERNAL REGISTERS

The Floppy Disk Controller contain eight internal registers which facilitate the interfacing between the host microprocessor and the disk drive. Table 2 shows the addresses required to access these registers. Registers other than the ones shown are not supported. The rest of the description assumes that the primary addresses have been selected.

Table 2 - Status, Data and Control Registers

PRIMARY ADDRESS	SECONDARY ADDRESS		REGISTER	
3F0	370	R	Status Register A	SRA
3F1	371	R	Status Register B	SRB
3F2	372	R/W	Digital Output Register	DOR
3F3	373	R/W	Tape Drive Register	TSR
3F4	374	R	Main Status Register	MSR
3F4	374	W	Data Rate Select Register	DSR
3F5	375	R/W	Data (FIFO)	FIFO
3F6	376		Reserved	
3F7	377	R	Digital Input Register	DIR
3F7	377	W	Configuration Control Register	CCR

STATUS REGISTER A (SRA)

Address 3F0 READ ONLY

This register is read-only and monitors the state of the FINTR pin and several disk interface pins,

in PS/2 and Model 30 modes. The SRA can be accessed at any time when in PS/2 mode. In the PC/AT mode the data bus pins D0 - D7 are held in a high impedance state for a read of address 3F0.

PS/2 Mode

	7	6	5	4	3	2	1	0
	INT PENDING	$\overline{\text{DRV2}}$	STEP	$\overline{\text{TRK0}}$	HDSEL	$\overline{\text{INDX}}$	$\overline{\text{WP}}$	DIR
RESET COND.	0	N/A	0	N/A	0	N/A	N/A	0

BIT 0 DIRECTION

Active high status indicating the direction of head movement. A logic "1" indicating inward direction a logic "0" outward.

BIT 1 $\overline{\text{WRITE PROTECT}}$

Active low status of the WRITE PROTECT disk interface input. A logic "0" indicating that the disk is write protected.

BIT 2 $\overline{\text{INDEX}}$

Active low status of the INDEX disk interface input.

BIT 3 HEAD SELECT

Active high status of the HDSEL disk interface input. A logic "1" selects side 1 and a logic "0" selects side 0.

BIT 4 $\overline{\text{TRACK 0}}$

Active low status of the TRK0 disk interface input.

BIT 5 STEP

Active high status of the STEP output disk interface output pin.

BIT 6 $\overline{\text{DRV2}}$

Active low status of the DRV2 disk interface input pin, indicating that a second drive has been installed.

BIT 7 INTERRUPT PENDING

Active high bit indicating the state of the Floppy Disk Interrupt output.

PS/2 Model 30 Mode

	7	6	5	4	3	2	1	0
	INT PENDING	DRQ	STEP F/F	TRKO	$\overline{\text{HSEL}}$	INDX	WP	$\overline{\text{DIR}}$
RESET COND.	0	0	0	N/A	1	N/A	N/A	1

BIT 0 DIRECTION

Active low status indicating the direction of head movement. A logic "0" indicating inward direction a logic "1" outward.

BIT 1 WRITE PROTECT

Active high status of the WRITE PROTECT disk interface input. A logic "1" indicating that the disk is write protected.

BIT 2 INDEX

Active high status of the INDEX disk interface input.

BIT 3 HEAD SELECT

Active low status of the HSEL disk interface input. A logic "0" selects side 1 and a logic "1" selects side 0.

BIT 4 TRACK 0

Active high status of the TRKO disk interface input.

BIT 5 STEP

Active high status of the latched STEP disk interface output pin. This bit is latched with the STEP output going active, and is cleared with a read from the DIR register, or with a hardware or software reset.

BIT 6 DMA REQUEST

Active high status of the DRQ output pin.

BIT 7 INTERRUPT PENDING

Active high bit indicating the state of the Floppy Disk Interrupt output.

STATUS REGISTER B (SRB)

Address F1 READ ONLY

This register is read-only and monitors the state of several disk interface pins, in PS/2 and Model

30 modes. The SRB can be accessed at any time when in PS/2 mode. In the PC-AT mode the data bus pins D0 - D7 are held in a high impedance state for a read of address 3F1.

PS/2 Mode

	7	6	5	4	3	2	1	0
	1	1	DRIVE SELO	WDATA TOGGLE	RDATA TOGGLE	WGATE	MOT EN1	MOT EN0
RESET COND.	1	1	0	0	0	0	0	0

BIT 0 MOTOR ENABLE 0

Active high status of the MTR0 disk interface output pin. This bit is low after a hardware reset and unaffected by a software reset.

BIT 1 MOTOR ENABLE 1

Active high status of the MTR1 disk interface output pin. This bit is low after a hardware reset and unaffected by a software reset.

BIT 2 WRITE GATE

Active high status of the WGATE disk interface output.

BIT 3 READ DATA TOGGLE

Every inactive edge of the RDATA input causes this bit to change state.

BIT 4 WRITE DATA TOGGLE

Every inactive edge of the WDATA input causes this bit to change state.

BIT 5 DRIVE SELECT 0

Reflects the status of the Drive Select 0 bit of the DOR (address 3F2 bit 0). This bit is cleared after a hardware reset, it is unaffected by a software reset.

BIT 6 RESERVED

Always read as a logic "1".

BIT 7 RESERVED

Always read as a logic "1".

PS/2 Model 30 Mode

	7	6	5	4	3	2	1	0
	$\overline{\text{DRV2}}$	$\overline{\text{DS1}}$	$\overline{\text{DS0}}$	WDATA F/F	RDATA F/F	WGATE F/F	$\overline{\text{DS3}}$	$\overline{\text{DS2}}$
RESET COND.	N/A	1	1	0	0	0	1	1

BIT 0 $\overline{\text{DRIVE SELECT 2}}$

Active low status of the DS2 disk interface output.

BIT 1 $\overline{\text{DRIVE SELECT 3}}$

Active low status of the DS3 disk interface output.

BIT 2 WRITE GATE

Active high status of the latched WGATE output signal. This bit is latched by the active going edge of WGATE and is cleared by the read of the DIR register.

BIT 3 READ DATA

Active high status of the latched RDATA output signal. This bit is latched by the inactive going edge of RDATA and is cleared by the read of the DIR register.

BIT 4 WRITE DATA

Active high status of the latched WDATA output signal. This bit is latched by the inactive going edge of WDATA and is cleared by the read of the DIR register. This bit is not gated with WGATE.

BIT 5 $\overline{\text{DRIVE SELECT 0}}$

Active low status of the DS0 disk interface output.

BIT 6 $\overline{\text{DRIVE SELECT 1}}$

Active low status of the DS1 disk interface output.

BIT 7 $\overline{\text{DRV2}}$

Active low status of the DRV2 disk interface input.

DIGITAL OUTPUT REGISTER (DOR)

Address 3F2 READ/WRITE

The DOR controls the drive select and motor enables of the disk interface outputs. It also

contains the enable for the DMA logic and contains a software reset bit. The contents of the DOR are unaffected by a software reset. The DOR can be written to at any time.

	7	6	5	4	3	2	1	0
	MOT EN3	MOT EN2	MOT EN1	MOT EN0	DMAEN	$\overline{\text{RESET}}$	DRIVE SEL1	DRIVE SELO
RESET COND.	0	0	0	0	0	0	0	0

BIT 0 and 1 DRIVE SELECT

These two bits are binary encoded for the four drive selects DS0 -DS3, thereby allowing only one drive to be selected at one time.

BIT 2 $\overline{\text{RESET}}$

A logic "0" written to this bit resets the Floppy disk controller. This reset will remain active until a logic "1" is written to this bit. This software reset does not affect the DSR and CCR registers, nor does it affect the other bits of the DOR register. The minimum reset duration required is 100ns, therefore toggling this bit by consecutive writes to this register is a valid method of issuing a software reset.

BIT 3 DMAEN

PC/AT and Model 30 Mode:

Writing this bit to logic "1" will enable the DRQ, $\overline{\text{DACK}}$, TC and FINTR outputs. This bit being a logic "0" will disable the $\overline{\text{DACK}}$ and TC inputs, and hold the DRQ and FINTR outputs in a high impedance state. This bit is a logic "0" after a reset and in these modes.

PS/2 Mode: In this mode the DRQ, $\overline{\text{DACK}}$, TC and FINTR pins are always enabled. During a reset, the DRQ, $\overline{\text{DACK}}$, TC, and FINTR pins will remain enabled, but this bit will be cleared to a logic "0".

BIT 4 MOTOR ENABLE 0

This bit controls the MTR0 disk interface output. A logic "1" in this bit will cause the output pin to go active.

BIT 5 MOTOR ENABLE 1

This bit controls the MTR1 disk interface output. A logic "1" in this bit will cause the output pin to go active.

BIT 6 MOTOR ENABLE 2

This bit controls the MTR2 disk interface output. A logic "1" in this bit will cause the output pin to go active.

BIT 7 MOTOR ENABLE 3

This bit controls the MTR3 disk interface output. A logic "1" in this bit causes the output to go active.

Table 3 - Drive Activation Values

DRIVE	DOR VALUE
0	1CH
1	2DH
2	4EH
3	8FH

TAPE DRIVE REGISTER (TDR)

Address 3F3 READ/WRITE

This register is included for 82077 software compatibility. The robust digital data separator used in the FDC37C663 does not require its characteristics modified for tape support. The contents of this register are not used internal to the device. The TDR is unaffected by a software reset. Bits 2-7 are tri-stated when read in this mode.

Table 4- Tape Select Bits

TAPE SEL1	TAPE SEL2	DRIVE SELECTED
0	0	None
0	1	1
1	0	2
1	1	3

Table 5 - Internal 4 Drive Decode - Normal

DIGITAL OUTPUT REGISTER						DRIVE SELECT OUTPUTS (ACTIVE LOW)				MOTOR ON OUTPUTS (ACTIVE LOW)			
Bit 7	Bit 6	Bit 5	Bit 4	Bit 1	Bit 0	DS3	DS2	DS1	DS0	MTR3	MTR2	MTR1	MTR0
X	X	X	1	0	0	1	1	1	0	BIT 7	BIT 6	BIT 5	BIT 4
X	X	1	X	0	1	1	1	0	1	BIT 7	BIT 6	BIT 5	BIT 4
X	1	X	X	1	0	1	0	1	1	BIT 7	BIT 6	BIT 5	BIT 4
1	X	X	X	1	1	0	1	1	1	BIT 7	BIT 6	BIT 5	BIT 4
0	0	0	0	X	X	1	1	1	1	BIT 7	BIT 6	BIT 5	BIT 4

Table 6 - Internal 4 Drive Decode - Drives 0 and 1 Swapped

DIGITAL OUTPUT REGISTER						DRIVE SELECT OUTPUTS (ACTIVE LOW)				MOTOR ON OUTPUTS (ACTIVE LOW)			
Bit 7	Bit 6	Bit 5	Bit 4	Bit 1	Bit 0	DS3	DS2	DS1	DS0	MTR3	MTR2	MTR1	MTR0
X	X	X	1	0	0	1	1	0	1	BIT 7	BIT 6	BIT 4	BIT 5
X	X	1	X	0	1	1	1	1	0	BIT 7	BIT 6	BIT 4	BIT 5
X	1	X	X	1	0	1	0	1	1	BIT 7	BIT 6	BIT 4	BIT 5
1	X	X	X	1	1	0	1	1	1	BIT 7	BIT 6	BIT 4	BIT 5
0	0	0	0	X	X	1	1	1	1	BIT 7	BIT 6	BIT 4	BIT 5

Table 7 - External 2 to 4 Drive Decode - Normal

DIGITAL OUTPUT REGISTER						DRIVE SELECT OUTPUTS (ACTIVE LOW)		MOTOR ON OUTPUTS (ACTIVE LOW)	
Bit 7	Bit 6	Bit 5	Bit 4	Bit 1	Bit 0	DST	DS0	MTRT	MTR0
X	X	X	1	0	0	0	0	1	0
X	X	1	X	0	1	0	1	1	0
X	1	X	X	1	0	1	0	1	0
1	X	X	X	1	1	1	1	1	0
X	X	X	0	0	0	0	0	1	1
X	X	0	X	0	1	0	1	1	1
X	0	X	X	1	0	1	0	1	1
0	X	X	X	1	1	1	1	1	1

Table 8 - External 2 to 4 Drive Decode - Drives 0 and 1 Swapped

DIGITAL OUTPUT REGISTER						DRIVE SELECT OUTPUTS (ACTIVE LOW)		MOTOR ON OUTPUTS (ACTIVE LOW)	
Bit 7	Bit 6	Bit 5	Bit 4	Bit 1	Bit 0	DST	DS0	MTRT	MTR0
X	X	X	1	0	0	0	1	1	0
X	X	1	X	0	1	0	0	1	0
X	1	X	X	1	0	1	0	1	0
1	X	X	X	1	1	1	1	1	0
X	X	X	0	0	0	0	1	1	1
X	X	0	X	0	1	0	0	1	1
X	0	X	X	1	0	1	0	1	1
0	X	X	X	1	1	1	1	1	1

Normal Floppy Mode

Normal mode. Register 3F3 contains only bits 0 and 1. When this register is read, bits 2 - 7 are a high impedance.

	DB7	DB6	DB5	DB4	DB3	DB2	DB1	DB0
REG 3F3	Tri-state	Tri-state	Tri-state	Tri-state	Tri-state	Tri-state	tape sel1	tape sel0

Enhanced Floppy Mode 2 (OS2)

Register 3F3 for Enhanced Floppy Mode 2 operation.

	DB7	DB6	DB5	DB4	DB3	DB2	DB1	DB0
REG 3F3	Media ID1	Media ID0	Drive Type ID		Floppy Boot Drive		tape sel1	tape sel0

For this mode, DRATE0 and DRATE1 pins are inputs, and these inputs are gated into bits 6 and 7 of the 3F3 register. These two bits are not affected by a hard or soft reset.

BIT 7 MEDIA ID 1 READ ONLY (Pin 18) (See Table 9)

BIT 6 MEDIA ID 0 READ ONLY (Pin 19) (See Table 10)

BITS 5 and 4 Drive Type ID - These Bits reflect two of the bits of configuration register 6.

Which two bits depends on the last drive selected in the Digital Output Register (3F2). (See Table 11)

BITS 3 and 2 Floppy Boot Drive - These bits reflect the value of configuration register 7 bits 1, 0. Bit 3 = CR7 Bit DB1. Bit 2 = CR7 Bit DB0.

Bits 1 and 0 - Tape Drive Select (READ/WRITE). Same as in Normal and Enhanced Floppy Mode. 1.

Table 9 - Media ID1

DRATE1 Input	MEDIA ID1	
	BIT 7	
Pin 18	CR7-DB3 = 0	CR7-DB3 = 1
0	0	1
1	1	0

Table 10 - Media ID0

DRATE0 Input	MEDIA ID0	
	BIT 6	
Pin 19	CR7-DB2 = 0	CR7-DB2 = 1
0	0	1
1	1	0

Table 11 - Drive Type ID

Digital Output Register		Register 3F3 - Drive Type ID	
Bit 1	Bit 0	Bit 5	Bit 4
0	0	CR6 - Bit 1	CR6 - Bit 0
0	1	CR6 - Bit 3	CR6 - Bit 2
1	0	CR6 - Bit 5	CR6 - Bit 4
1	1	CR6 - Bit 7	CR6 - Bit 6

DATA RATE SELECT REGISTER (DSR)

Address 3F4 WRITE ONLY

This register is write only. It is used to program the data rate, amount of write precompensation, power down status, and software reset. The data rate is programmed using the Configuration Control Register (CCR) not the DSR, for PC/AT and PS/2 Model 30 and

Microchannel applications. Other applications can set the data rate in the DSR. The data rate of the floppy controller is the most recent write of either the DSR or CCR. The DSR is unaffected by a software reset. A hardware reset will set the DSR to 02H, which corresponds to the default precompensation setting and 250kb/s.

	7	6	5	4	3	2	1	0
	S/W RESET	POWER DOWN	0	PRE- COMP2	PRE- COMP1	PRE- COMPO	DRATE SEL1	DRATE SELO
RESET COND.	0	0	0	0	0	0	1	0

BIT 0 and 1 DATA RATE SELECT

These bits control the data rate of the floppy controller. See Table 13 for the settings corresponding to the individual data rates. The data rate select bits are unaffected by a software reset, and are set to 250kb/s after a hardware reset.

BIT 2 through 4 PRECOMPENSATION SELECT

These three bits select the value of write precompensation that will be applied to the WDATA output signal. Table 12 shows the precompensation values for the combination of these bits settings. Track 0 is the default starting track number to start precompensation. this starting track number can be changed by the configure command.

BIT 5 UNDEFINED

Should be written as a logic "0".

BIT 6 LOW POWER

A logic "1" written to this bit will put the floppy controller into Manual Low Power mode. The

floppy controller clock and data separator circuits will be turned off. The controller will come out of manual low power mode after a software reset or access to the Data Register or Main Status Register.

BIT 7 SOFTWARE RESET

This active high bit has the same function as the DOR RESET (DOR bit 2) except that this bit is self clearing.

Table 12 - Precompensation Delays

PRECOMP 432	PRECOMPENSATION DELAY
111	0.00 ns-DISABLED
001	41.67 ns
010	83.34 ns
011	125.00 ns
100	166.67 ns
101	208.33 ns
110	250.00 ns
000	Default (See Table 14)

Table 13 - Data Rates

DRATESEL		DATA RATE	
1	0	MFM	FM
1	1	1 Mbps	Illegal
0	0	500 Kbps	250 Kbps
0	1	300 Kbps	150 Kbps
1	0	250 Kbps	125 Kbps

Table 14 - Default Precompensation Delays

DATA RATE	PRECOMPENSATION DELAYS
1 Mbps	41.67 ns
500 Kbps	125 ns
300 Kbps	125 ns
250 Kbps	125 ns

MAIN STATUS REGISTER

Address 3F4 READ ONLY

The Main Status Register is a read-only register and indicates the status of the disk controller. The Main Status Register can be read at any

time. The MSR indicates when the disk controller is ready to receive data via the Data Register. It should be read before each byte transferring to or from the data register except in DMA mode. NO delay is required when reading the MSR after a data transfer.

7	6	5	4	3	2	1	0
RQM	DIO	NON DMA	CMD BUSY	DRV3 BUSY	DRV2 BUSY	DRV1 BUSY	DRV0 BUSY

BIT 0 - 3 DRV x BUSY

These bits are set to 1s when a drive is in the seek portion of a command, including implied and overlapped seeks and recalibrates.

BIT 4 COMMAND BUSY

This bit is set to a 1 when a command is in progress. This bit will go active after the command byte has been accepted and goes inactive at the end of the results phase. If there is no result phase (Seek, Recalibrate commands), this bit is returned to a 0 after the last command byte.

BIT 5 NON-DMA

This mode is selected in the SPECIFY command and will be set to a 1 during the execution phase of a command. This is for polled data transfers and helps differentiate between the data transfer phase and the reading of result bytes.

BIT 6 DIO

Indicates the direction of a data transfer once a RQM is set. A 1 indicates a read and a 0 indicates a write is required.

BIT 7 RQM

Indicates that the host can transfer data if set to a 1. No access is permitted if set to a 0.

DATA REGISTER (FIFO)

Address 3F5 READ/WRITE

All command parameter information, disk data and result status are transferred between the host processor and the floppy disk controller through the Data Register.

Data transfers are governed by the RQM and DIO bits in the Main Status Register.

The Data Register defaults to FIFO disabled mode after any form of reset. This maintains PC/AT hardware compatibility. The default values can be changed through the Configure command (enable full FIFO operation with threshold control). The advantage of the FIFO is that it allows the system a larger DMA latency without causing a disk error. Table 15 gives several examples of the delays with a

FIFO. The data is based upon the following formula:

$$\text{Threshold \#} \times \left| \frac{1}{\text{DATA RATE}} \times 8 \right| - 1.5 \mu\text{s} = \text{DELAY}$$

At the start of a command, the FIFO action is always disabled and command parameters must be sent based upon the RQM and DIO bit settings. As the command execution phase is entered, the FIFO is cleared of any data to ensure that invalid data is not transferred.

An overrun or underrun will terminate the current command and the transfer of data. Disk writes will complete the current sector by generating a 00 pattern and valid CRC. Reads require the host to remove the remaining data so that the result phase may be entered.

Table 15 - FIFO Service Delay

FIFO THRESHOLD EXAMPLES	MAXIMUM DELAY TO SERVICING AT 1 Mbps DATA RATE
1 byte	$1 \times 8 \mu\text{s} - 1.5 \mu\text{s} = 6.5 \mu\text{s}$
2 bytes	$2 \times 8 \mu\text{s} - 1.5 \mu\text{s} = 14.5 \mu\text{s}$
8 bytes	$8 \times 8 \mu\text{s} - 1.5 \mu\text{s} = 62.5 \mu\text{s}$
15 bytes	$15 \times 8 \mu\text{s} - 1.5 \mu\text{s} = 118.5 \mu\text{s}$

FIFO THRESHOLD EXAMPLES	MAXIMUM DELAY TO SERVICING AT 500 Kbps DATA RATE
1 byte	$1 \times 16 \mu\text{s} - 1.5 \mu\text{s} = 14.5 \mu\text{s}$
2 bytes	$2 \times 16 \mu\text{s} - 1.5 \mu\text{s} = 30.5 \mu\text{s}$
8 bytes	$8 \times 16 \mu\text{s} - 1.5 \mu\text{s} = 126.5 \mu\text{s}$
15 bytes	$15 \times 16 \mu\text{s} - 1.5 \mu\text{s} = 238.5 \mu\text{s}$

DIGITAL INPUT REGISTER (DIR)

Address 3F7 READ ONLY

This register is read-only in all modes.

PC-AT Mode

	7	6	5	4	3	2	1	0
	DSK CHG							
RESET COND.	N/A	N/A	N/A	N/A	N/A	N/A	N/A	N/A

BIT 0 - 6 UNDEFINED

The data bus outputs D0 - 6 will remain in a high impedance state during a read of this register.

BIT 7 DSKCHG

This bit monitors the pin of the same name and reflects the opposite value seen on the disk cable.

PS/2 Mode

	7	6	5	4	3	2	1	0
	DSK CHG	1	1	1	1	DRATE SEL1	DRATE SELO	<u>HIGH DENS</u>
RESET COND.	N/A	N/A	N/A	N/A	N/A	N/A	N/A	1

BIT 0 HIGH DENS

This bit is low whenever the 500 Kbps or 1 Mbps data rates are selected, and high when 250Kbps and 300Kbps are selected.

BITS 1 - 2 DATA RATE SELECT

These bits control the data rate of the floppy controller. See Table 13 for the settings corresponding to the individual data rates. The data rate select bits are unaffected by a

software reset, and are set to 250kb/s after a hardware reset.

BITS 3 - 6 UNDEFINED

Always read as a logic "1"

BIT 7 DSKCHG

This bit monitors the pin of the same name and reflects the opposite value seen on the disk cable.

Model 30 Mode

	7	6	5	4	3	2	1	0
DSK CHG	0	0	0	0	DMAEN	NOPREC	DRATE SEL1	DRATE SELO
RESET COND.	N/A	0	0	0	0	0	1	0

BITS 0 - 1 DATA RATE SELECT

These bits control the data rate of the floppy controller. See Table 13 for the settings corresponding to the individual data rates. The data rate select bits are unaffected by a software reset, and are set to 250kb/s after a hardware reset.

BIT 2 NOPREC

This bit reflects the value of NOPREC bit set in the CCR register.

BIT 3 DMAEN

This bit reflects the value of DMAEN bit set in the DOR register bit 3.

BITS 4 - 6 UNDEFINED

Always read as a logic "0"

BIT 7 DSKCHG

This bit monitors the pin of the same name and reflects the opposite value seen on the pin.

CONFIGURATION CONTROL REGISTER (CCR)

Address 3F7 WRITE ONLY
PC/AT and PS/2 Modes

	7	6	5	4	3	2	1	0
							DRATE SEL1	DRATE SELO
RESET COND.	N/A	N/A	N/A	N/A	N/A	N/A	1	0

BIT 0 and 1 DATA RATE SELECT 0 and 1

These bits determine the data rate of the floppy controller. See Table 13 for the appropriate values.

BIT 2 - 7 RESERVED

Should be set to a logical "0"

PS/2 Model 30 Mode

	7	6	5	4	3	2	1	0
						NOPREC	DRATE SEL1	DRATE SELO
RESET COND.	N/A	N/A	N/A	N/A	N/A	N/A	1	0

BIT 0 and 1 DATA RATE SELECT 0 and 1

These bits determine the data rate of the floppy controller. See Table 13 for the appropriate values.

BIT 2 NO PRECOMPENSATION

This bit can be set by software, but it has no functionality. It can be read by bit 2 of the DSR when in Model 30 register mode. Unaffected by software reset.

BIT 3 - 7 RESERVED

Should be set to a logical "0"

Table 16 shows the state of the DENSEL pin. The DENSEL pin is set high after a hardware reset and is unaffected by the DOR and the DSR resets.

Table 16 - DENSEL Encoding

Data Rate	IDENT	DENSEL
1Mbps	0	0
	1	1
500kbps	0	0
	1	1
300kps	0	1
	1	0
250kbps	0	1
	1	0

STATUS REGISTER ENCODING

During the Result Phase of certain commands, the Data Register contains data bytes that give the status of the command just executed.

Table 17 - Status Register 0

BIT NO.	SYMBOL	NAME	DESCRIPTION
7,6	IC	Interrupt Code	00 - Normal termination of command. The specified command was properly executed and completed without error. 01 - Abnormal termination of command. Command execution was started, but was not successfully completed. 10 - Invalid command. The requested command could not be executed. 11 - Abnormal termination caused by Polling.
5	SE	Seek End	The FDC completed a Seek, Relative Seek, or Recalibrate command (used during a Sense Interrupt command).
4	EC	Equipment Check	The TRKO pin failed to become a "1" after: 1. 80 step pulses in the Recalibrate command. 2. The Relative Seek command caused the FDC to step outward beyond Track 0.
3			Unused. This bit is always "0".
2	H	Head Address	The current head address.
1,0	DS1,0	Drive Select	The current selected drive.

Table 18 - Status Register 1

BIT NO.	SYMBOL	NAME	DESCRIPTION
7	EN	End of Cylinder	The FDC tried to access a sector beyond the final sector of the track (255D). Will be set if TC is not issued after Read or Write Data command.
6			Unused. This bit is always "0".
5	DE	Data Error	The FDC detected a CRC error in either the ID field or the data field of a sector.
4	OR	Overrun/ Underrun	Becomes set if the FDC does not receive CPU or DMA service within the required time interval, resulting in data overrun or underrun.
3			Unused. This bit is always "0".
2	ND	No Data	Any one of the following: 1. Read Data, Read Deleted Data command - the FDC did not find the specified sector. 2. Read ID command - the FDC cannot read the ID field without an error. 3. Read A Track command - the FDC cannot find the proper sector sequence.
1	NW	Not Writable	WP pin became a "1" while the FDC is executing a Write Data, Write Deleted Data, or Format A Track command.
0	MA	Missing Address Mark	Any one of the following: 1. The FDC did not detect an ID address mark at the specified track after encountering the index pulse from the IDX pin twice. 2. The FDC cannot detect a data address mark or a deleted data address mark on the specified track.

Table 19 - Status Register 2

BIT NO.	SYMBOL	NAME	DESCRIPTION
7			Unused. This bit is always "0".
6	CM	Control Mark	Any one of the following: 1. Read Data command - the FDC encountered a deleted data address mark. 2. Read Deleted Data command - the FDC encountered a data address mark.
5	DD	Data Error in Data Field	The FDC detected a CRC error in the data field.
4	WC	Wrong Cylinder	The track address from the sector ID field is different from the track address maintained inside the FDC.
3			Unused. This bit is always "0".
2			Unused. This bit is always "0".
1	BC	Bad Cylinder	The track address from the sector ID field is different from the track address maintained inside the FDC and is equal to FF hex, which indicates a bad track with a hard error according to the IBM soft-sectored format.
0	MD	Missing Data Address Mark	The FDC cannot detect a data address mark or a deleted data address mark.

Table 20- Status Register 3

BIT NO.	SYMBOL	NAME	DESCRIPTION
7			Unused. This bit is always "0".
6	WP	Write Protected	Indicates the status of the WP pin.
5			Unused. This bit is always "1".
4	T0	Track 0	Indicates the status of the TRKO pin.
3			Unused. This bit is always "1".
2	HD	Head Address	Indicates the status of the HDSEL pin.
1,0	DS1,0	Drive Select	Indicates the status of the DS1, DS0 pins.

RESET

There are three sources of system reset on the FDC: the RESET pin of the FDC37C663, a reset generated via a bit in the DOR, and a reset generated via a bit in the DSR. At power on, a Power On Reset initializes the FDC. All resets take the FDC out of the power down state.

All operations are terminated upon a RESET, and the FDC enters an idle state. A reset while a disk write is in progress will corrupt the data and CRC.

On exiting the reset state, various internal registers are cleared, including the Configure command information, and the FDC waits for a new command. Drive polling will start unless disabled by a new Configure command.

RESET Pin (Hardware Reset)

The RESET pin is a global reset and clears all registers except those programmed by the Specify command. The DOR reset bit is enabled and must be cleared by the host to exit the reset state.

DOR Reset vs. DSR Reset (Software Reset)

These two resets are functionally the same. Both will reset the FDC core, which affects drive status information and the FIFO circuits. The DSR reset clears itself automatically while the DOR reset requires the host to manually clear it. DOR reset has precedence over the DSR reset. The DOR reset is set automatically upon a pin reset. The user must manually clear this reset bit in the DOR to exit the reset state.

MODES OF OPERATION

The FDC has three modes of operation, PC/AT mode, PS/2 mode and Model 30 mode. These are determined by the state of the IDENT and MFM bits 6 and 5 respectively of configuration register 3.

PC/AT mode - (IDENT high, MFM a "don't care")

The PC/AT register set is enabled, the DMA enable bit of the DOR becomes valid (FINTR and DRQ can be hi Z), and TC and DENSEL become active high signals.

PS/2 mode - (IDENT low, MFM high)

This mode supports the PS/2 models 50/60/80 configuration and register set. The DMA bit of the DOR becomes a "don't care", (FINTR and DRQ are always valid), TC and DENSEL become active low.

Model 30 mode - (IDENT low, MFM low)

This mode supports PS/2 Model 30 configuration and register set. The DMA enable bit of ther DOR becomes valid (FINTR and DRQ can be hi Z), TC is active high and DENSEL is active low.

DMA TRANSFERS

DMA transfers are enabled with the Specify command and are initiated by the FDC by activating the FDRQ pin during a data transfer command. The FIFO is enabled directly by asserting \overline{DACK} and addresses need not be valid.

Note that if the DMA controller (i.e. 8237A) is programmed to function in verify mode, a pseudo read is performed by the FDC based only on \overline{DACK} . This mode is only available when the FDC has been configured into byte mode (FIFO disabled) and is programmed to do a read. With the FIFO enabled, the FDC can perform the above operation by using the new Verify command; no DMA operation is needed.

CONTROLLER PHASES

For simplicity, command handling in the FDC can be divided into three phases: Command, Execution, and Result. Each phase is described in the following sections.

Command Phase

After a reset, the FDC enters the command phase and is ready to accept a command from the host. For each of the commands, a defined

set of command code bytes and parameter bytes has to be written to the FDC before the command phase is complete. (Please refer to Table 22 for the command set descriptions.) These bytes of data must be transferred in the order prescribed.

Before writing to the FDC, the host must examine the RQM and DIO bits of the Main Status Register. RQM and DIO must be equal to "1" and "0" respectively before command bytes may be written. RQM is set false by the FDC after each write cycle until the received byte is processed. The FDC asserts RQM again to request each parameter byte of the command unless an illegal command condition is detected. After the last parameter byte is received, RQM remains "0" and the FDC automatically enters the next phase as defined by the command definition.

The FIFO is disabled during the command phase to provide for the proper handling of the "Invalid Command" condition.

Execution Phase

All data transfers to or from the FDC occur during the execution phase, which can proceed in DMA or non-DMA mode as indicated in the Specify command.

After a reset, the FIFO is disabled. Each data byte is transferred by an FINT or FDRQ depending on the DMA mode. The Configure command can enable the FIFO and set the FIFO threshold value.

The following paragraphs detail the operation of the FIFO flow control. In these descriptions, <threshold> is defined as the number of bytes available to the FDC when service is requested from the host and ranges from 1 to 16. The parameter FIFOTHR, which the user programs, is one less and ranges from 0 to 15.

A low threshold value (i.e. 2) results in longer periods of time between service requests, but requires faster servicing of the request for both read and write cases. The host reads (writes) from (to) the FIFO until empty (full), then the transfer request goes inactive. The host must be very responsive to the service request. This is the desired case for use with a "fast" system.

A high value of threshold (i.e. 12) is used with a "sluggish" system by affording a long latency period after a service request, but results in more frequent service requests.

Non-DMA Mode - Transfers from the FIFO to the Host

The FINT pin and RQM bits in the Main Status Register are activated when the FIFO contains (16-<threshold>) bytes or the last bytes of a full sector have been placed in the FIFO. The FINT pin can be used for interrupt-driven systems, and RQM can be used for polled systems. The host must respond to the request by reading data from the FIFO. This process is repeated until the last byte is transferred out of the FIFO. The FDC will deactivate the FINT pin and RQM bit when the FIFO becomes empty.

Non-DMA Mode - Transfers from the Host to the FIFO

The FINT pin and RQM bit in the Main Status Register are activated upon entering the execution phase of data transfer commands. The host must respond to the request by writing data into the FIFO. The FINT pin and RQM bit remain true until the FIFO becomes full. They are set true again when the FIFO has <threshold> bytes remaining in the FIFO. The FINT pin will also be deactivated if TC and DACK both go inactive. The FDC enters the result phase after the last byte is taken by the FDC from the FIFO (i.e. FIFO empty condition).

DMA Mode - Transfers from the FIFO to the Host

The FDC activates the DDRQ pin when the FIFO contains (16 - <threshold>) bytes, or the last byte of a full sector transfer has been placed in the FIFO. The DMA controller must respond to the request by reading data from the FIFO. The FDC will deactivate the DDRQ pin when the FIFO becomes empty. FDRQ goes inactive after DACK goes active for the last byte of a data transfer (or on the active edge of IOR, on the last byte, if no edge is present on DACK). A data underrun may occur if FDRQ is not removed in time to prevent an unwanted cycle.

DMA Mode - Transfers from the Host to the FIFO

The FDC activates the FDRQ pin when entering the execution phase of the data transfer commands. The DMA controller must respond by activating the DACK and IOW pins and placing data in the FIFO. FDRQ remains active until the FIFO becomes full. FDRQ is again set true when the FIFO has <threshold> bytes remaining in the FIFO. The FDC will also deactivate the FDRQ pin when TC becomes true (qualified by DACK), indicating that no more data is required. FDRQ goes inactive after DACK goes active for the last byte of a data transfer (or on the active edge of IOW of the last byte, if no edge is present on DACK). A data overrun may occur if FDRQ is not removed in time to prevent an unwanted cycle.

Data Transfer Termination

The FDC supports terminal count explicitly through the TC pin and implicitly through the underrun/overrun and end-of-track (EOT) functions. For full sector transfers, the EOT parameter can define the last sector to be transferred in a single or multi-sector transfer.

If the last sector to be transferred is a partial sector, the host can stop transferring the data in mid-sector, and the FDC will continue to complete the sector as if a hardware TC was received. The only difference between these implicit functions and TC is that they return "abnormal termination" result status. Such status indications can be ignored if they were expected.

Note that when the host is sending data to the FIFO of the FDC, the internal sector count will be complete when the FDC reads the last byte from its side of the FIFO. There may be a delay in the removal of the transfer request signal of up to the time taken for the FDC to read the last 16 bytes from the FIFO. The host must tolerate this delay.

Result Phase

The generation of FINT determines the beginning of the result phase. For each of the commands, a defined set of result bytes has to be read from the FDC before the result phase is complete. These bytes of data must be read out for another command to start.

RQM and DIO must both equal "1" before the result bytes may be read. After all the result bytes have been read, the RQM and DIO bits switch to "1" and "0" respectively, and the CB bit is cleared, indicating that the FDC is ready to accept the next command.

COMMAND SET/DESCRIPTIONS

Commands can be written whenever the FDC is in the command phase. Each command has a unique set of needed parameters and status results. The FDC checks to see that the first byte is a valid command and, if valid, proceeds with the command. If it is invalid, an interrupt

is issued. The user sends a Sense Interrupt Status command which returns an invalid command error. Refer to Table 20 for explanations of the various symbols used. Table 21 lists the required parameters and the results associated with each command that the FDC is capable of performing.

Table 21 - Description of Command Symbols

SYMBOL	NAME	DESCRIPTION															
C	Cylinder Address	The currently selected address; 0 to 255.															
D	Data Pattern	The pattern to be written in each sector data field during formatting.															
DO, D1, D2, D3	Drive Select 0-3	Designates which drives are perpendicular drives on the Perpendicular Mode Command. A "1" indicates a perpendicular drive.															
DIR	Direction Control	If this bit is 0, then the head will step out from the spindle during a relative seek. If set to a 1, the head will step in toward the spindle.															
DS0, DS1	Disk Drive Select	<table border="1"> <thead> <tr> <th>DS1</th> <th>DS0</th> <th>DRIVE</th> </tr> </thead> <tbody> <tr> <td>0</td> <td>0</td> <td>drive 0</td> </tr> <tr> <td>0</td> <td>1</td> <td>drive 1</td> </tr> <tr> <td>1</td> <td>0</td> <td>drive 2</td> </tr> <tr> <td>1</td> <td>1</td> <td>drive 3</td> </tr> </tbody> </table>	DS1	DS0	DRIVE	0	0	drive 0	0	1	drive 1	1	0	drive 2	1	1	drive 3
DS1	DS0	DRIVE															
0	0	drive 0															
0	1	drive 1															
1	0	drive 2															
1	1	drive 3															
DTL	Special Sector Size	By setting N to zero (00), DTL may be used to control the number of bytes transferred in disk read/write commands. The sector size (N = 0) is set to 128. If the actual sector (on the diskette) is larger than DTL, the remainder of the actual sector is read but is not passed to the host during read commands; during write commands, the remainder of the actual sector is written with all zero bytes. The CRC check code is calculated with the actual sector. When N is not zero, DTL has no meaning and should be set to FF HEX.															
EC	Enable Count	When this bit is "1" the "DTL" parameter of the Verify command becomes SC (number of sectors per track).															
EFIFO	Enable FIFO	This active low bit when a 0, enables the FIFO. A "1" disables the FIFO (default).															

Table 21 - Description of Command Symbols

SYMBOL	NAME	DESCRIPTION
EIS	Enable Implied Seek	When set, a seek operation will be performed before executing any read or write command that requires the C parameter in the command phase. A "0" disables the implied seek.
EOT	End of Track	The final sector number of the current track.
GAP		Alters Gap 2 length when using Perpendicular Mode.
GPL	Gap Length	The Gap 3 size. (Gap 3 is the space between sectors excluding the VCO synchronization field).
H/HDS	Head Address	Selected head: 0 or 1 (disk side 0 or 1) as encoded in the sector ID field.
HLT	Head Load Time	The time interval that FDC waits after loading the head and before initializing a read or write operation. Refer to the Specify command for actual delays.
HUT	Head Unload Time	The time interval from the end of the execution phase (of a read or write command) until the head is unloaded. Refer to the Specify command for actual delays.
LOCK		Lock defines whether EFIFO, FIFOTHR, and PRETRK parameters of the CONFIGURE COMMAND can be reset to their default values by a "software Reset". (A reset caused by writing to the appropriate bits of either the DSR or DOR)
MF	MF/FM Mode Selector	A one selects the double density (MF) mode. A zero selects single density (FM) mode.
MT	Multi-Track Selector	When set, this flag selects the multi-track operating mode. In this mode, the FDC treats a complete cylinder under head 0 and 1 as a single track. The FDC operates as this expanded track started at the first sector under head 0 and ended at the last sector under head 1. With this flag set, a multitrack read or write operation will automatically continue to the first sector under head 1 when the FDC finishes operating on the last sector under head 0.

Table 21 - Description of Command Symbols

SYMBOL	NAME	DESCRIPTION														
N	Sector Size Code	<p>This specifies the number of bytes in a sector. If this parameter is "00", then the sector size is 128 bytes. The number of bytes transferred is determined by the DTL parameter. Otherwise the sector size is (2 raised to the "N'th" power) times 128. All values up to "07" hex are allowable. "07" would equal a sector size of 16k. It is the user's responsibility to not select combinations that are not possible with the drive.</p> <table border="1" data-bbox="641 376 1105 601"> <thead> <tr> <th>N</th> <th>SECTOR SIZE</th> </tr> </thead> <tbody> <tr> <td>00</td> <td>128 bytes</td> </tr> <tr> <td>01</td> <td>256 bytes</td> </tr> <tr> <td>02</td> <td>512 bytes</td> </tr> <tr> <td>03</td> <td>1024 bytes</td> </tr> <tr> <td>..</td> <td>...</td> </tr> <tr> <td>07</td> <td>16 Kbytes</td> </tr> </tbody> </table>	N	SECTOR SIZE	00	128 bytes	01	256 bytes	02	512 bytes	03	1024 bytes	07	16 Kbytes
N	SECTOR SIZE															
00	128 bytes															
01	256 bytes															
02	512 bytes															
03	1024 bytes															
..	...															
07	16 Kbytes															
NCN	New Cylinder Number	The desired cylinder number.														
ND	Non-DMA Mode Flag	When set to 1, indicates that the FDC is to operate in the non-DMA mode. In this mode, the host is interrupted for each data transfer. When set to 0, the FDC operates in DMA mode, interfacing to a DMA controller by means of the DRQ and <u>DACK</u> signals.														
OW	Overwrite	The bits D0-D3 of the Perpendicular Mode Command can only be modified if OW is set to 1. OW is defined in the Lock command.														
PCN	Present Cylinder Number	The current position of the head at the completion of Sense Interrupt Status command.														
POLL	Polling Disable	When set, the internal polling routine is disabled. When clear, polling is enabled.														
PRETRK	Precompensation Start Track Number	Programmable from track 00 to FFH.														
R	Sector Address	The sector number to be read or written. In multi-sector transfers, this parameter specifies the sector number of the first sector to be read or written.														
RCN	Relative Cylinder Number	Relative cylinder offset from present cylinder as used by the Relative Seek command.														

Table 21 - Description of Command Symbols

SYMBOL	NAME	DESCRIPTION
SC	Number of Sectors Per Track	The number of sectors per track to be initialized by the Format command. The number of sectors per track to be verified during a Verify command when EC is set.
SK	Skip Flag	When set to 1, sectors containing a deleted data address mark will automatically be skipped during the execution of Read Data. If Read Deleted is executed, only sectors with a deleted address mark will be accessed. When set to "0", the sector is read or written the same as the read and write commands.
SRT	Step Rate Interval	The time interval between step pulses issued by the FDC. Programmable from 0.5 to 8 milliseconds in increments of 0.5 ms at the 1 Mbit data rate. Refer to the SPECIFY command for actual delays.
ST0 ST1 ST2 ST3	Status 0 Status 1 Status 2 Status 3	Registers within the FDC which store status information after a command has been executed. This status information is available to the host during the result phase after command execution.
WGATE	Write Gate	Alters timing of WE to allow for pre-erase loads in perpendicular drives.

INSTRUCTION SET

Table 22 - Instruction Set

READ DATA											
PHASE	R/W	DATA BUS								REMARKS	
		D7	D6	D5	D4	D3	D2	D1	D0		
Command	W	MT	MFM	SK	0	0	1	1	0	Command Codes Sector ID information prior to Command execution.	
	W	0	0	0	0	0	HDS	DS1	DS0		
	W					C					
	W					H					
	W					R					
	W					N					
	W					EOT					
	W					GPL					
	W					DTL					
Execution										Data transfer between the FDD and system.	
Result	R					ST0					Status information after Command execution. Sector ID information after Command execution.
	R					ST1					
	R					ST2					
	R					C					
	R					H					
	R					R					
	R					N					

READ DELETED DATA

PHASE	R/W	DATA BUS								REMARKS	
		D7	D6	D5	D4	D3	D2	D1	D0		
Command	W	MT	MFM	SK	0	1	1	0	0	Command Codes	
	W	0	0	0	0	0	HDS	DS1	DS0		
	W	_____			C	_____					Sector ID information prior to Command execution.
	W	_____			H	_____					
	W	_____			R	_____					
	W	_____			N	_____					
	W	_____			EOT	_____					
	W	_____			GPL	_____					
	W	_____			DTL	_____					
Execution		Data transfer between the FDD and system.									
		Status information after Command execution.									
Result	R	_____			ST0	_____				Sector ID information after Command execution.	
	R	_____			ST1	_____					
	R	_____			ST2	_____					
	R	_____			C	_____					
	R	_____			H	_____					
	R	_____			R	_____					
	R	_____			N	_____					

WRITE DATA										
PHASE	R/W	DATA BUS								REMARKS
		D7	D6	D5	D4	D3	D2	D1	D0	
Command	W	MT	MFM	0	0	0	1	0	1	Command Codes Sector ID information prior to Command execution.
	W	0	0	0	0	0	HDS	DS1	DS0	
	W	_____			C	_____				
	W	_____			H	_____				
	W	_____			R	_____				
	W	_____			N	_____				
	W	_____			EOT	_____				
	W	_____			GPL	_____				
	W	_____			DTL	_____				
Execution										Data transfer between the FDD and system.
Result	R	_____			ST0	_____				Status information after Command execution.
	R	_____			ST1	_____				
	R	_____			ST2	_____				
	R	_____			C	_____				Sector ID information after Command execution.
	R	_____			H	_____				
	R	_____			R	_____				
	R	_____			N	_____				

WRITE DELETED DATA												
PHASE	R/W	DATA BUS								REMARKS		
		D7	D6	D5	D4	D3	D2	D1	D0			
Command	W	MT	MFM	0	0	1	0	0	1	Command Codes		
	W	0	0	0	0	0	HDS	DS1	DS0			
	W	_____				C	_____				Sector ID information prior to Command execution.	
	W	_____				H	_____					
	W	_____				R	_____					
	W	_____				N	_____					
	W	_____				EOT	_____					
	W	_____				GPL	_____					
W	_____				DTL	_____						
Execution										Data transfer between the FDD and system.		
Result	R	_____				ST0	_____				Status information after Command execution.	
	R	_____				ST1	_____					
	R	_____				ST2	_____					
	R	_____				C	_____				Sector ID information after Command execution.	
	R	_____				H	_____					
	R	_____				R	_____					
	R	_____				N	_____					

READ A TRACK												
PHASE	R/W	DATA BUS								REMARKS		
		D7	D6	D5	D4	D3	D2	D1	D0			
Command	W	0	MFM	0	0	0	0	1	0	Command Codes		
	W	0	0	0	0	0	HDS	DS1	DS0			
	W	_____				C	_____					
	W	_____				H	_____					
	W	_____				R	_____					
	W	_____				N	_____					
	W	_____				EOT	_____					
	W	_____				GPL	_____					
Execution	W	_____				DTL	_____				Data transfer between the FDD and system. FDC reads all of cylinders' contents from index hole to EOT.	
	Result	R	_____				ST0	_____				
		R	_____				ST1	_____				
		R	_____				ST2	_____				
		R	_____				C	_____				
		R	_____				H	_____				
		R	_____				R	_____				
R		_____				N	_____					

VERIFY											
PHASE	R/W	DATA BUS								REMARKS	
		D7	D6	D5	D4	D3	D2	D1	D0		
Command	W	MT	MFM	SK	1	0	1	1	0	Command Codes	
	W	EC	0	0	0	0	HDS	DS1	DS0		
	W	_____ C _____									Sector ID information prior to Command execution.
	W	_____ H _____									
	W	_____ R _____									
	W	_____ N _____									
	W	_____ EOT _____									
	W	_____ GPL _____									
W	_____ DTL/SC _____										
Execution										No data transfer takes place.	
Result	R	_____ ST0 _____								Status information after Command execution.	
	R	_____ ST1 _____									
	R	_____ ST2 _____									
	R	_____ C _____								Sector ID information after Command execution.	
	R	_____ H _____									
	R	_____ R _____									
	R	_____ N _____									

VERSION										
PHASE	R/W	DATA BUS								REMARKS
		D7	D6	D5	D4	D3	D2	D1	D0	
Command	W	0	0	0	1	0	0	0	0	Command Code
Result	R	1	0	0	1	0	0	0	0	Enhanced Controller

FORMAT A TRACK												
PHASE	R/W	DATA BUS								REMARKS		
		D7	D6	D5	D4	D3	D2	D1	D0			
Command	W	0	MFM	0	0	1	1	0	1	Command Codes		
	W	0	0	0	0	0	HDS	DS1	DS0			
	W	_____				N	_____				Bytes/Sector	
	W	_____				SC	_____				Sectors/Cylinder	
	W	_____				GPL	_____				Gap 3	
	W	_____				D	_____				Filler Byte	
Execution for Each Sector Repeat:	W	_____				C	_____				Input Sector Parameters	
	W	_____				H	_____					
	W	_____				R	_____					
	W	_____				N	_____					
Result	R	_____				ST0	_____				FDC formats an entire cylinder Status information after Command execution	
	R	_____				ST1	_____					
	R	_____				ST2	_____					
	R	_____				Undefined	_____					
	R	_____				Undefined	_____					
	R	_____				Undefined	_____					

RECALIBRATE										
PHASE	R/W	DATA BUS								REMARKS
		D7	D6	D5	D4	D3	D2	D1	D0	
Command	W	0	0	0	0	0	1	1	1	Command Codes Head retracted to Track 0 Interrupt.
Execution	W	0	0	0	0	0	0	DS1	DS0	

SENSE INTERRUPT STATUS										
PHASE	R/W	DATA BUS								REMARKS
		D7	D6	D5	D4	D3	D2	D1	D0	
Command	W	0	0	0	0	1	0	0	0	Command Codes Status information at the end of each seek operation.
Result	R	_____ STO _____								
	R	_____ PCN _____								

SPECIFY										
PHASE	R/W	DATA BUS								REMARKS
		D7	D6	D5	D4	D3	D2	D1	D0	
Command	W	0	0	0	0	0	0	1	1	Command Codes
	W	_____ SRT _____				_____ HUT _____				
	W	_____ HLT _____							ND	

SENSE DRIVE STATUS										
PHASE	R/W	DATA BUS								REMARKS
		D7	D6	D5	D4	D3	D2	D1	D0	
Command	W	0	0	0	0	0	1	0	0	Command Codes Status information about FDD
Result	W	0	0	0	0	0	HDS	DS1	DS0	
	R	————— ST3 —————								

SEEK										
PHASE	R/W	DATA BUS								REMARKS
		D7	D6	D5	D4	D3	D2	D1	D0	
Command	W	0	0	0	0	1	1	1	1	Command Codes Head positioned over proper cylinder on diskette.
Execution	W	0	0	0	0	0	HDS	DS1	DS0	
	W	————— NCN —————								

CONFIGURE										
PHASE	R/W	DATA BUS								REMARKS
		D7	D6	D5	D4	D3	D2	D1	D0	
Command	W	0	0	0	1	0	0	1	1	Configure Information
Execution	W	0	0	0	0	0	0	0	0	
	W	0	EIS	EFIFO	POLL		————— FIFOTHR —————			
	W	————— PRETRK —————								

RELATIVE SEEK										
PHASE	R/W	DATA BUS								REMARKS
		D7	D6	D5	D4	D3	D2	D1	D0	
Command	W	1	DIR	0	0	1	1	1	1	
	W	0	0	0	0	0	HDS	DS1	DS0	
	W	RCN								

DUMPREG											
PHASE	R/W	DATA BUS								REMARKS	
		D7	D6	D5	D4	D3	D2	D1	D0		
Command	W	0	0	0	0	1	1	1	0	*Note: Registers placed in FIFO	
Execution Result	R	PCN-Drive 0									
	R	PCN-Drive 1									
	R	PCN-Drive 2									
	R	PCN-Drive 3									
	R	SRT					HUT				
	R	HLT									ND
	R	SC/EOT									
	R	LOCK	0	D3	D2	D1	D0	GAP	WGATE		
	R	0	EIS	EFIFO	POLL		FIFOTHR				
	R	PRETRK									

READ ID										
PHASE	R/W	DATA BUS								REMARKS
		D7	D6	D5	D4	D3	D2	D1	D0	
Command	W	0	MFM	0	0	1	0	1	0	Commands
Execution	W	0	0	0	0	0	HDS	DS1	DS0	
Result	R	_____			ST0	_____				Status information after Command execution. Disk status after the Command has completed
	R	_____			ST1	_____				
	R	_____			ST2	_____				
	R	_____			C	_____				
	R	_____			H	_____				
	R	_____			R	_____				
R	_____			N	_____					

PERPENDICULAR MODE										
PHASE	R/W	DATA BUS								REMARKS
		D7	D6	D5	D4	D3	D2	D1	D0	
Command	W	0	0	0	1	0	0	1	0	Command Codes
		OW	0	D3	D2	D1	D0	GAP	WGATE	

INVALID CODES										
PHASE	R/W	DATA BUS								REMARKS
		D7	D6	D5	D4	D3	D2	D1	D0	
Command	W	Invalid Codes								Invalid Command Codes (NoOp - FDC37C663/664 goes into Standby State) STO = 80H
Result	R	STO								

LOCK										
PHASE	R/W	DATA BUS								REMARKS
		D7	D6	D5	D4	D3	D2	D1	D0	
Command	W	LOCK	0	0	1	0	1	0	0	Command Codes
Result	R	0	0	0	LOCK	0	0	0	0	

SC is returned if the last command that was issued was the Format command. EOT is returned if the last command was a Read or Write.

NOTE: These bits are used internally only. They are not reflected in the Drive Select pins. It is the user's responsibility to maintain correspondence between these bits and the Drive Select pins (DOR).

DATA TRANSFER COMMANDS

All of the Read Data, Write Data and Verify type commands use the same parameter bytes and return the same results information, the only difference being the coding of bits 0-4 in the first byte.

An implied seek will be executed if the feature was enabled by the Configure command. This seek is completely transparent to the user. The Drive Busy bit for the drive will go active in the Main Status Register during the seek portion of the command. If the seek portion fails, it will be reflected in the results status normally returned for a Read/Write Data command. Status Register 0 (ST0) would contain the error code and C would contain the cylinder on which the seek failed.

Read Data

A set of nine (9) bytes is required to place the FDC in the Read Data Mode. After the Read Data command has been issued, the FDC loads the head (if it is in the unloaded state), waits the specified head settling time (defined in the Specify command), and begins reading ID Address Marks and ID fields. When the sector address read off the diskette matches with the sector address specified in the command, the FDC reads the sector's data field and transfers the data to the FIFO.

After completion of the read operation from the current sector, the sector address is incremented by one and the data from the next logical sector is read and output via the FIFO. This continuous read function is called "Multi-Sector Read Operation". Upon receipt of TC, or an implied TC (FIFO overrun/underrun), the FDC stops sending data but will continue to read data from the current sector, check the CRC bytes, and at the end of the sector, terminate the Read Data Command.

N determines the number of bytes per sector (see Table 23 below). If N is set to zero, the sector size is set to 128. The DTL value determines the number of bytes to be transferred. If DTL is less than 128, the FDC transfers the specified number of bytes to the host. For reads, it continues to read the entire 128-byte sector and checks for CRC errors. For writes, it completes the 128-byte sector by filling in zeros. If N is not set to 00 Hex, DTL should be set to FF Hex and has no impact on the number of bytes transferred.

Table 23 - Sector Sizes

N	SECTOR SIZE
00	128 bytes
01	256 bytes
02	512 bytes
03	1024 bytes
..	...
07	16 Kbytes

The amount of data which can be handled with a single command to the FDC depends upon MT (multi-track) and N (number of bytes/sector).

The Multi-Track function (MT) allows the FDC to read data from both sides of the diskette. For a particular cylinder, data will be transferred starting at Sector 1, Side 0 and completing the last sector of the same track at Side 1.

If the host terminates a read or write operation in the FDC, the ID information in the result phase is dependent upon the state of the MT bit and EOT byte. Refer to Table 24.

At the completion of the Read Data command, the head is not unloaded until after the Head Unload Time Interval (specified in the Specify command) has elapsed. If the host issues another command before the head unloads, then the head settling time may be saved between subsequent reads.

If the FDC detects a pulse on the INDEX pin twice without finding the specified sector (meaning that the diskette's index hole passes through index detect logic in the drive twice), the FDC sets the IC code in Status Register 0 to "01" indicating abnormal termination, sets the ND bit in Status Register 1 to "1" indicating a sector not found, and terminates the Read Data Command.

After reading the ID and Data Fields in each sector, the FDC checks the CRC bytes. If a

CRC error occurs in the ID or data field, the FDC sets the IC code in Status Register 0 to "01" indicating abnormal termination, sets the DE bit flag in Status Register 1 to "1", sets the DD bit in Status Register 2 to "1" if CRC is incorrect in the ID field, and terminates the Read Data Command. Table 25 describes the effect of the SK bit on the Read Data command execution and results. Except where noted in Table 25, the C or R value of the sector address is automatically incremented (see Table 27).

Table 24 - Effects of MT and N Bits

MT	N	MAXIMUM TRANSFER CAPACITY	FINAL SECTOR READ FROM DISK
0	1	256 x 26 = 6,656	26 at side 0 or 1
1	1	256 x 52 = 13,312	26 at side 1
0	2	512 x 15 = 7,680	15 at side 0 or 1
1	2	512 x 30 = 15,360	15 at side 1
0	3	1024 x 8 = 8,192	8 at side 0 or 1
1	3	1024 x 16 = 16,384	16 at side 1

Table 25 - Skip Bit vs Read Data Command

SK BIT VALUE	DATA ADDRESS MARK TYPE ENCOUNTERED	RESULTS		
		SECTOR READ?	CM BIT OF ST2 SET?	DESCRIPTION OF RESULTS
0	Normal Data	Yes	No	Normal termination. Address not incremented. Next sector not searched for.
0	Deleted Data	Yes	Yes	
1	Normal Data	Yes	No	
1	Deleted Data	No	Yes	

Read Deleted Data

This command is the same as the Read Data command, only it operates on sectors that contain a Deleted Data Address Mark at the beginning of a Data Field.

Table 26 describes the effect of the SK bit on the Read Deleted Data command execution and results.

Except where noted in Table 26, the C or R value of the sector address is automatically incremented (see Table 27).

Table 26 - Skip Bit vs. Read Deleted Data Command

SK BIT VALUE	DATA ADDRESS MARK TYPE ENCOUNTERED	RESULTS		
		SECTOR READ?	CM BIT OF ST2 SET?	DESCRIPTION OF RESULTS
0	Normal Data	Yes	Yes	Address not incremented. Next sector not searched for.
0	Deleted Data	Yes	No	Normal termination.
1	Normal Data	No	Yes	Normal termination. Sector not read ("skipped").
1	Deleted Data	Yes	No	Normal termination.

Read A Track

This command is similar to the Read Data command except that the entire data field is read continuously from each of the sectors of a track. Immediately after encountering a pulse on the INDEX pin, the FDC starts to read all data fields on the track as continuous blocks of data without regard to logical sector numbers. If the FDC finds an error in the ID or DATA CRC check bytes, it continues to read data from the track and sets the appropriate error bits at the end of the command. The FDC compares the ID information read from each sector with the specified value in the command and sets the

ND flag of Status Register 1 to a "1" if there is no comparison. Multi-track or skip operations are not allowed with this command. The MT and SK bits (bits D7 and D5 of the first command byte respectively) should always be set to "0".

This command terminates when the EOT specified number of sectors has not been read. If the FDC does not find an ID Address Mark on the diskette after the second occurrence of a pulse on the IDX pin, then it sets the IC code in Status Register 0 to "01" (abnormal termination), sets the MA bit in Status Register 1 to "1", and terminates the command.

Table 27 - Result Phase Table

MT	HEAD	FINAL SECTOR TRANSFERRED TO HOST	ID INFORMATION AT RESULT PHASE			
			C	H	R	N
0	0	Less than EOT	NC	NC	R + 1	NC
		Equal to EOT	C + 1	NC	01	NC
	1	Less than EOT	NC	NC	R + 1	NC
		Equal to EOT	C + 1	NC	01	NC
1	0	Less than EOT	NC	NC	R + 1	NC
		Equal to EOT	NC	LSB	01	NC
	1	Less than EOT	NC	NC	R + 1	NC
		Equal to EOT	C + 1	LSB	01	NC

NC: No Change, the same value as the one at the beginning of command execution.
 LSB: Least Significant Bit, the LSB of H is complemented.

Write Data

After the Write Data command has been issued, the FDC loads the head (if it is in the unloaded state), waits the specified head load time if unloaded (defined in the Specify command), and begins reading ID fields. When the sector address read from the diskette matches the sector address specified in the command, the FDC reads the data from the host via the FIFO and writes it to the sector's data field.

After writing data into the current sector, the FDC computes the CRC value and writes it into the CRC field at the end of the sector transfer. The Sector Number stored in "R" is incremented by one, and the FDC continues writing to the next data field. The FDC continues this "Multi-Sector Write Operation". Upon receipt of a terminal count signal or if a FIFO over/under run occurs while a data field is being written, then the remainder of the data field is filled with zeros.

The FDC reads the ID field of each sector and checks the CRC bytes. If it detects a CRC error

in one of the ID fields, it sets the IC code in Status Register 0 to "01" (abnormal termination), sets the DE bit of Status Register 1 to "1", and terminates the Write Data command.

The Write Data command operates in much the same manner as the Read Data command. The following items are the same. Please refer to the Read Data Command for details:

- Transfer Capacity
- EN (End of Cylinder) bit
- ND (No Data) bit
- Head Load, Unload Time Interval
- ID information when the host terminates the command
- Definition of DTL when N = 0 and when N does not = 0

Write Deleted Data

This command is almost the same as the Write Data command except that a Deleted Data Address Mark is written at the beginning of the Data Field instead of the normal Data Address

Mark. This command is typically used to mark a bad sector containing an error on the floppy disk.

Verify

The Verify command is used to verify the data stored on a disk. This command acts exactly like a Read Data command except that no data is transferred to the host. Data is read from the disk and CRC is computed and checked against the previously-stored value.

Because data is not transferred to the host, TC (pin 25) cannot be used to terminate this command. By setting the EC bit to "1", an implicit TC will be issued to the FDC. This implicit TC will occur when the SC value has

decremented to 0 (an SC value of 0 will verify 256 sectors). This command can also be terminated by setting the EC bit to "0" and the EOT value equal to the final sector to be checked. If EC is set to "0", DTL/SC should be programmed to OFFH. Refer to Table 27 and Table 28 for information concerning the values of MT and EC versus SC and EOT value.

Definitions:

Sectors Per Side = Number of formatted sectors per each side of the disk.

Sectors Remaining = Number of formatted sectors left which can be read, including side 1 of the disk if MT is set to "1".

Table 28 - Verify Command Result Phase Table

MT	EC	SC/EOT VALUE	TERMINATION RESULT
0	0	SC = DTL EOT ≤ # Sectors Per Side	Success Termination Result Phase Valid
0	0	SC = DTL EOT > # Sectors Per Side	Unsuccessful Termination Result Phase Invalid
0	1	SC ≤ # Sectors Remaining AND EOT ≤ # Sectors Per Side	Successful Termination Result Phase Valid
0	1	SC > # Sectors Remaining OR EOT > # Sectors Per Side	Unsuccessful Termination Result Phase Invalid
1	0	SC = DTL EOT ≤ # Sectors Per Side	Successful Termination Result Phase Valid
1	0	SC = DTL EOT > # Sectors Per Side	Unsuccessful Termination Result Phase Invalid
1	1	SC ≤ # Sectors Remaining AND EOT ≤ # Sectors Per Side	Successful Termination Result Phase Valid
1	1	SC > # Sectors Remaining OR EOT > # Sectors Per Side	Unsuccessful Termination Result Phase Invalid

NOTE: If MT is set to "1" and the SC value is greater than the number of remaining formatted sectors on Side 0, verifying will continue on Side 1 of the disk.

Format A Track

The Format command allows an entire track to be formatted. After a pulse from the IDX pin is detected, the FDC starts writing data on the disk including gaps, address marks, ID fields, and data fields per the IBM System 34 or 3740 format (MFM or FM respectively). The particular values that will be written to the gap and data field are controlled by the values programmed into N, SC, GPL, and D which are specified by the host during the command phase. The data field of the sector is filled with the data byte specified by D. The ID field for each sector is supplied by the host; that is, four data bytes per sector are needed by the FDC for C, H, R, and N (cylinder, head, sector number and sector size respectively).

After formatting each sector, the host must send new values for C, H, R and N to the FDC for the next sector on the track. The R value (sector number) is the only value that must be changed by the host after each sector is formatted. This allows the disk to be formatted with nonsequential sector addresses (interleaving). This incrementing and formatting continues for the whole track until the FDC encounters a pulse on the IDX pin again and it terminates the command.

Table 29 contains typical values for gap fields which are dependent upon the size of the sector and the number of sectors on each track. Actual values can vary due to drive electronics.

FORMAT FIELDS

SYSTEM 34 (DOUBLE DENSITY) FORMAT

GAP4a 80x 4E	SYNC 12x 00	IAM		GAP1 50x 4E	SYNC 12x 00	IDAM		C Y L	H D	S E C	N O	C R C	GAP2 22x 4E	SYNC 12x 00	DATA AM		DATA	C R C	GAP3	GAP 4b
		3x C2	FC			3x A1	FE								3x A1	FB				

SYSTEM 3740 (SINGLE DENSITY) FORMAT

GAP4a 40x FF	SYNC 6x 00	IAM		GAP1 26x FF	SYNC 6x 00	IDAM		C Y L	H D	S E C	N O	C R C	GAP2 11x FF	SYNC 6x 00	DATA AM		DATA	C R C	GAP3	GAP 4b
		FC				FE									FB or FB					

PERPENDICULAR FORMAT

GAP4a 80x 4E	SYNC 12x 00	IAM		GAP1 50x 4E	SYNC 12x 00	IDAM		C Y L	H D	S E C	N O	C R C	GAP2 41x 4E	SYNC 12x 00	DATA AM		DATA	C R C	GAP3	GAP 4b
		3x C2	FC			3x A1	FE								3x A1	FB				

Table 29 - Typical Values for Formatting

	FORMAT	SECTOR SIZE	N	SC	GPL1	GPL2
5.25" Drives	FM	128	00	12	07	09
		128	00	10	10	19
		512	02	08	18	30
		1024	03	04	46	87
		2048	04	02	C8	FF
		4096	05	01	C8	FF
				
	MFM	256	01	12	0A	0C
		256	01	10	20	32
		512*	02	09	2A	50
		1024	03	04	80	F0
		2048	04	02	C8	FF
		4096	05	01	C8	FF
				
3.5" Drives	FM	128	0	0F	07	1B
		256	1	09	0F	2A
		512	2	05	1B	3A
	MFM	256	1	0F	0E	36
		512**	2	09	1B	54
		1024	3	05	35	74

GPL1 = suggested GPL values in Read and Write commands to avoid splice point between data field and ID field of contiguous sections.

GPL2 = suggested GPL value in Format A Track command.

*PC/AT values (typical)

**PS/2 values (typical). Applies with 1.0 MB and 2.0 MB drives.

NOTE: All values except sector size are in hex.

CONTROL COMMANDS

Control commands differ from the other commands in that no data transfer takes place. Three commands generate an interrupt when complete: Read ID, Recalibrate, and Seek. The other control commands do not generate an interrupt.

Read ID

The Read ID command is used to find the present position of the recording heads. The FDC stores the values from the first ID field it is able to read into its registers. If the FDC does not find an ID address mark on the diskette after the second occurrence of a pulse on the INDEX pin, it then sets the IC code in Status Register 0 to "01" (abnormal termination), sets the MA bit in Status Register 1 to "1", and terminates the command.

The following commands will generate an interrupt upon completion. They do not return any result bytes. It is highly recommended that control commands be followed by the Sense Interrupt Status command. Otherwise, valuable interrupt status information will be lost.

Recalibrate

This command causes the read/write head within the FDC to retract to the track 0 position. The FDC clears the contents of the PCN counter and checks the status of the $\overline{\text{TR}0}$ pin from the FDD. As long as the $\overline{\text{TR}0}$ pin is low, the DIR pin remains 0 and step pulses are issued. When the $\overline{\text{TR}0}$ pin goes high, the SE bit in Status Register 0 is set to "1" and the command is terminated. If the $\overline{\text{TR}0}$ pin is still low after 79 step pulses have been issued, the FDC sets the SE and the EC bits of Status Register 0 to "1" and terminates the command. Disks capable of handling more than 80 tracks per side may require more than one Recalibrate command to return the head back to physical Track 0.

The Recalibrate command does not have a result phase. The Sense Interrupt Status command must be issued after the Recalibrate command to effectively terminate it and to provide verification of the head position (PCN). During the command phase of the recalibrate operation, the FDC is in the BUSY state, but during the execution phase it is in a NON-BUSY state. At this time, another Recalibrate command may be issued, and in this manner parallel Recalibrate operations may be done on up to four drives at once.

Upon power up, the software must issue a Recalibrate command to properly initialize all drives and the controller.

Seek

The read/write head within the drive is moved from track to track under the control of the Seek command. The FDC compares the PCN, which is the current head position, with the NCN and performs the following operation if there is a difference:

- PCN < NCN: Direction signal to drive set to "1" (step in) and issues step pulses.
- PCN > NCN: Direction signal to drive set to "0" (step out) and issues step pulses.

The rate at which step pulses are issued is controlled by SRT (Stepping Rate Time) in the Specify command. After each step pulse is issued, NCN is compared against PCN, and when NCN = PCN the SE bit in Status Register 0 is set to "1" and the command is terminated.

During the command phase of the seek or recalibrate operation, the FDC is in the BUSY state, but during the execution phase it is in the NON-BUSY state. At this time, another Seek or Recalibrate command may be issued, and in this manner, parallel seek operations may be done on up to four drives at once.

Note that if implied seek is not enabled, the read and write commands should be preceded by:

- 1) Seek command - Step to the proper track
- 2) Sense Interrupt Status command - Terminate the Seek command
- 3) Read ID - Verify head is on proper track
- 4) Issue Read/Write command.

The Seek command does not have a result phase. Therefore, it is highly recommended that the Sense Interrupt Status command be issued after the Seek command to terminate it and to provide verification of the head position (PCN). The H bit (Head Address) in STO will always return to a "0". When exiting POWERDOWN mode, the FDC clears the PCN value and the status information to zero. Prior to issuing the POWERDOWN command, it is highly recommended that the user service all pending interrupts through the Sense Interrupt Status command.

Sense Interrupt Status

An interrupt signal on FINT pin is generated by the FDC for one of the following reasons:

1. Upon entering the Result Phase of:
 - a. Read Data command
 - b. Read A Track command
 - c. Read ID command
 - d. Read Deleted Data command
 - e. Write Data command
 - f. Format A Track command
 - g. Write Deleted Data command
 - h. Verify command
2. End of Seek, Relative Seek, or Recalibrate command
3. FDC requires a data transfer during the execution phase in the non-DMA mode

The Sense Interrupt Status command resets the interrupt signal and, via the IC code and SE bit

of Status Register 0, identifies the cause of the interrupt.

Table 30 - Interrupt Identification

SE	IC	INTERRUPT DUE TO
0	11	Polling
1	00	Normal termination of Seek or Recalibrate command
1	01	Abnormal termination of Seek or Recalibrate command

The Seek, Relative Seek, and Recalibrate commands have no result phase. The Sense Interrupt Status command must be issued immediately after these commands to terminate them and to provide verification of the head position (PCN). The H (Head Address) bit in STO will always return a "0". If a Sense Interrupt Status is not issued, the drive will continue to be BUSY and may affect the operation of the next command.

Sense Drive Status

Sense Drive Status obtains drive status information. It has no execution phase and goes directly to the result phase from the command phase. Status Register 3 contains the drive status information.

Specify

The Specify command sets the initial values for each of the three internal times. The HUT (Head Unload Time) defines the time from the end of the execution phase of one of the read/write commands to the head unload state. The SRT (Step Rate Time) defines the time interval between adjacent step pulses. Note that the spacing between the first and second step pulses may be shorter than the remaining step pulses. The HLT (Head Load Time) defines the time between when the Head Load signal

goes high and the read/write operation starts. The values change with the data rate speed

selection and are documented in Table 31. The values are the same for MFM and FM.

Table 31 - Drive Control Delays (ms)

	HUT				SRT			
	1M	500K	300K	250K	1M	500K	300K	250K
0	128	256	426	512	8.0	16	26.7	32
1	8	16	26.7	32	7.5	15	25	30
..
E	112	224	373	448	1.0	2	3.33	4
F	120	240	400	480	0.5	1	1.67	2

	HLT			
	1M	500K	300K	250K
00	128	256	426	512
01	1	2	3.3	4
02	2	4	6.7	8
..
7F	126	252	420	504
7F	127	254	423	508

The choice of DMA or non-DMA operations is made by the ND bit. When this bit is "1", the non-DMA mode is selected, and when ND is "0", the DMA mode is selected. In DMA mode, data transfers are signalled by the FDRQ pin. Non-DMA mode uses the RQM bit and the FINT pin to signal data transfers.

Configure

The Configure command is issued to select the special features of the FDC. A Configure command need not be issued if the default values of the FDC meet the system requirements.

Configure Default Values:

- EIS - No Implied Seeks
- EFIFO - FIFO Disabled
- POLL - Polling Enabled
- FIFOTHR - FIFO Threshold Set to 1 Byte
- PRETRK - Pre-Compensation Set to Track 0

EIS - Enable Implied Seek. When set to "1", the FDC will perform a Seek operation before executing a read or write command. Defaults to no implied seek.

EFIFO - A "1" disables the FIFO (default). This means data transfers are asked for on a byte-by-byte basis. Defaults to "1", FIFO disabled. The threshold defaults to "1".

POLL - Disable polling of the drives. Defaults to "0", polling enabled. When enabled, a single interrupt is generated after a reset. No polling is performed while the drive head is loaded and the head unload delay has not expired.

FIFOTHR - The FIFO threshold in the execution phase of read or write commands. This is programmable from 1 to 16 bytes. Defaults to one byte. A "00" selects one byte; "0F" selects 16 bytes.

PRETRK - Pre-Compensation Start Track Number. Programmable from track 0 to 255. Defaults to track 0. A "00" selects track 0; "FF" selects track 255.

Version

The Version command checks to see if the controller is an enhanced type or the older type (765A). A value of 90 H is returned as the result byte.

Relative Seek

The command is coded the same as for Seek, except for the MSB of the first byte and the DIR bit.

DIR Head Step Direction Control

DIR	ACTION
0	Step Head Out
1	Step Head In

RCN Relative Cylinder Number that determines how many tracks to step the head in or out from the current track number.

The Relative Seek command differs from the Seek command in that it steps the head the absolute number of tracks specified in the command instead of making a comparison against an internal register. The Seek command is good for drives that support a maximum of 256 tracks. Relative Seeks cannot be overlapped with other Relative Seeks. Only one Relative Seek can be active at a time. Relative Seeks may be overlapped with Seeks and Recalibrates. Bit 4 of Status Register 0 (EC) will be set if Relative Seek attempts to step outward beyond Track 0.

As an example, assume that a floppy drive has 300 useable tracks. The host needs to read

track 300 and the head is on any track (0-255). If a Seek command is issued, the head will stop at track 255. If a Relative Seek command is issued, the FDC will move the head the specified number of tracks, regardless of the internal cylinder position register (but will increment the register). If the head was on track 40 (d), the maximum track that the FDC could position the head on using Relative Seek will be 295 (D), the initial track + 255 (D). The maximum count that the head can be moved with a single Relative Seek command is 255 (D).

The internal register, PCN, will overflow as the cylinder number crosses track 255 and will contain 39 (D). The resulting PCN value is thus $(RCN + PCN) \text{ mod } 256$. Functionally, the FDC starts counting from 0 again as the track number goes above 255 (D). It is the user's responsibility to compensate FDC functions (precompensation track number) when accessing tracks greater than 255. The FDC does not keep track that it is working in an "extended track area" (greater than 255). Any command issued will use the current PCN value except for the Recalibrate command, which only looks for the TRACK0 signal. Recalibrate will return an error if the head is farther than 79 due to its limitation of issuing a maximum of 80 step pulses. The user simply needs to issue a second Recalibrate command. The Seek command and implied seeks will function correctly within the 44 (D) track (299-255) area of the "extended track area". It is the user's responsibility not to issue a new track position that will exceed the maximum track that is present in the extended area.

To return to the standard floppy range (0-255) of tracks, a Relative Seek should be issued to cross the track 255 boundary.

A Relative Seek can be used instead of the normal Seek, but the host is required to calculate the difference between the current head location and the new (target) head

location. This may require the host to issue a Read ID command to ensure that the head is physically on the track that software assumes it to be. Different FDC commands will return different cylinder results which may be difficult to keep track of with software without the Read ID command.

Perpendicular Mode

The Perpendicular Mode command should be issued prior to executing Read/Write/Format commands that access a disk drive with perpendicular recording capability. With this command, the length of the Gap2 field and VCO enable timing can be altered to accommodate the unique requirements of these drives. Table 31 describes the effects of the WGATE and GAP bits for the Perpendicular Mode command. Upon a reset, the FDC will default to the conventional mode (WGATE = 0, GAP = 0).

Selection of the 500 Kbps and 1 Mbps perpendicular modes is independent of the actual data rate selected in the Data Rate Select Register. The user must ensure that these two data rates remain consistent.

The Gap2 and VCO timing requirements for perpendicular recording type drives are dictated by the design of the read/write head. In the design of this head, a pre-erase head precedes the normal read/write head by a distance of 200 micrometers. This works out to about 38 bytes at a 1 Mbps recording density. Whenever the write head is enabled by the Write Gate signal, the pre-erase head is also activated at the same time. Thus, when the write head is initially turned on, flux transitions recorded on the media for the first 38 bytes will not be preconditioned with the pre-erase head since it has not yet been activated. To accommodate this head activation and deactivation time, the Gap2 field is expanded to a length of 41 bytes. The format field shown on page 66 illustrates

the change in the Gap2 field size for the perpendicular format.

On the read back by the FDC, the controller must begin synchronization at the beginning of the sync field. For the conventional mode, the internal PLL VCO is enabled (VCOEN) approximately 24 bytes from the start of the Gap2 field. But, when the controller operates in the 1 Mbps perpendicular mode (WGATE = 1, GAP = 1), VCOEN goes active after 43 bytes to accommodate the increased Gap2 field size. For both cases, and approximate two-byte cushion is maintained from the beginning of the sync field for the purposes of avoiding write splices in the presence of motor speed variation.

For the Write Data case, the FDC activates Write Gate at the beginning of the sync field under the conventional mode. The controller then writes a new sync field, data address mark, data field, and CRC as shown in Figure 4. With the pre-erase head of the perpendicular drive, the write head must be activated in the Gap2 field to insure a proper write of the new sync field. For the 1 Mbps perpendicular mode (WGATE = 1, GAP = 1), 38 bytes will be written in the Gap2 space. Since the bit density is proportional to the data rate, 19 bytes will be written in the Gap2 field for the 500 Kbps perpendicular mode (WGATE = 1, GAP = 0).

It should be noted that none of the alterations in Gap2 size, VCO timing, or Write Gate timing affect normal program flow. The information provided here is just for background purposes and is not needed for normal operation. Once the Perpendicular Mode command is invoked, FDC software behavior from the user standpoint is unchanged.

The perpendicular mode command is enhanced to allow specific drives to be designated Perpendicular recording drives. This

enhancement allows data transfers between Conventional and Perpendicular drives without having to issue Perpendicular mode commands between the accesses of the different drive types, nor having to change write pre-compensation values.

When both GAP and WGATE bits of the PERPENDICULAR MODE COMMAND are both programmed to "0" (Conventional mode), then D0, D1, D2, D3, and D4 can be programmed independently to "1" for that drive to be set automatically to Perpendicular mode. In this mode the following set of conditions also apply:

1. The GAP2 written to a perpendicular drive during a write operation will depend upon the programmed data rate.
2. The write pre-compensation given to a perpendicular mode drive will be Ons.

3. For D0-D3 programmed to "0" for conventional mode drives any data written will be at the currently programmed write pre-compensation.

Note: Bits D0-D3 can only be overwritten when OW is programmed as a "1". If either GAP or WGATE is a "1" then D0-D3 are ignored.

Software and hardware resets have the following effect on the PERPENDICULAR MODE COMMAND:

1. "Software" resets (via the DOR or DSR registers) will only clear GAP and WGATE bits to "0". D0-D3 are unaffected and retain their previous value.
2. "Hardware" resets will clear all bits (GAP, WGATE and D0-D3) to "0", i.e. all conventional mode.

Table 32 - Effects of WGATE and GAP Bits

WGATE	GAP	MODE	LENGTH OF GAP2 FORMAT FIELD	PORTION OF GAP 2 WRITTEN BY WRITE DATA OPERATION
0	0	Conventional	22 Bytes	0 Bytes
0	1	Perpendicular (500 Kbps)	22 Bytes	19 Bytes
1	0	Reserved (Conventional)	22 Bytes	0 Bytes
1	1	Perpendicular (1 Mbps)	41 Bytes	38 Bytes

LOCK

In order to protect systems with long DMA latencies against older application software that can disable the FIFO the LOCK Command has been added. This command should only be used by the FDC routines, and application software should refrain from using it. If an application calls for the FIFO to be disabled then the CONFIGURE command should be used.

The LOCK command defines whether the EFIFO, FIFOTHR, and PRETRK parameters of the CONFIGURE command can be RESET by the DOR and DSR registers. When the LOCK bit is set to logic "1" all subsequent "software RESETS" by the DOR and DSR registers will not change the previously set parameters to their default values. All "hardware" RESET from the RESET pin will set the LOCK bit to logic "0" and return the EFIFO, FIFOTHR, and PRETRK to

their default values. A status byte is returned immediately after issuing a LOCK command. This byte reflects the value of the LOCK bit set by the command byte.

ENHANCED DUMPREG

The DUMPREG command is designed to support system run-time diagnostics and application software development and debug. To accommodate the LOCK command and the enhanced PERPENDICULAR MODE command the eighth byte of the DUMPREG command has been modified to contain the additional data from these two commands.

COMPATIBILITY

The FDC37C663/664 was designed with software compatibility in mind. It is a fully backwards-compatible solution with the older generation 765A/B disk controllers. The FDC also implements on-board registers for compatibility with the PS/2, as well as PC/AT and PC/XT, floppy disk controller subsystems. After a hardware reset of the FDC, all registers, functions and enhancements default to a PC/AT, PS/2 or PS/2 Model 30 compatible operating mode, depending on how the IDENT and MFM bits are configured by the system bios.

SERIAL PORT (UART)

The FDC37C663 and FDC37C664 incorporate two full function UARTs. They are compatible with the NS16450, the 16450 ACE registers and the NS16550A. The UARTS perform serial-to-parallel conversion on received characters and parallel-to-serial conversion on transmit characters. The data rates are independently programmable from 115.2K baud down to 50 baud. The character options are programmable for 1 start; 1, 1.5 or 2 stop bits; even, odd, sticky or no parity; and prioritized interrupts. The UARTS each contain a programmable baud rate generator that is capable of dividing the input clock or crystal by a number from 1 to 65535. The UARTs are also capable of supporting the MIDI data rate. Refer to the FDC37C663 Configuration Registers and FDC37C664 Hardware Configuration

description for information on disabling, power down and changing the base address of the UARTS. The interrupt from a UART is enabled by programming OUT2 of that UART to a logic "1". OUT2 being a logic "0" disables that UART's interrupt.

REGISTER DESCRIPTION

Addressing of the accessible registers of the Serial Port is shown below. The base addresses of the serial ports are defined by the configuration registers (see Configuration section). The Serial Port registers are located at sequentially increasing addresses above these base addresses. The FDC37C663/664 contains two serial ports, each of which contain a register set as described below.

Table 33 - Addressing the Serial Port

DLAB*	A2	A1	A0	REGISTER NAME
0	0	0	0	Receive Buffer (read)
0	0	0	0	Transmit Buffer (write)
0	0	0	1	Interrupt Enable (read/write)
X	0	1	0	Interrupt Identification (read)
X	0	1	0	FIFO Control (write)
X	0	1	1	Line Control (read/write)
X	1	0	0	Modem Control (read/write)
X	1	0	1	Line Status (read/write)
X	1	1	0	Modem Status (read/write)
X	1	1	1	Scratchpad (read/write)
1	0	0	0	Divisor LSB (read/write)
1	0	0	1	Divisor MSB (read/write)

*NOTE: DLAB is Bit 7 of the Line Control Register

The following section describes the operation of the registers.

RECEIVE BUFFER REGISTER (RB)

Address Offset = 0H, DLAB = 0, READ ONLY

This register holds the received incoming data byte. Bit 0 is the least significant bit, which is transmitted and received first. Received data is double buffered; this uses an additional shift register to receive the serial data stream and convert it to a parallel 8 bit word which is transferred to the Receive Buffer register. The shift register is not accessible.

TRANSMIT BUFFER REGISTER (TB)

Address Offset = 0H, DLAB = 0, WRITE ONLY

This register contains the data byte to be transmitted. The transmit buffer is double buffered, utilizing an additional shift register (not accessible) to convert the 8 bit data word to a serial format. This shift register is loaded from the Transmit Buffer when the transmission of the previous byte is complete.

INTERRUPT ENABLE REGISTER (IER)

Address Offset = 1H, DLAB = 0, READ/WRITE

The lower four bits of this register control the enables of the five interrupt sources of the Serial Port interrupt. It is possible to totally disable the interrupt system by resetting bits 0 through 3 of this register. Similarly, setting the appropriate bits of this register to a high, selected interrupts can be enabled. Disabling the interrupt system inhibits the Interrupt Identification Register and disables any Serial Port interrupt out of the FDC37C663. All other system functions operate in their normal manner, including the Line Status and MODEM Status Registers. The contents of the Interrupt Enable Register are described below.

Bit 0

This bit enables the Received Data Available Interrupt (and timeout interrupts in the FIFO

mode) when set to logic "1".

Bit 1

This bit enables the Transmitter Holding Register Empty Interrupt when set to logic "1".

Bit 2

This bit enables the Received Line Status Interrupt when set to logic "1". The error sources causing the interrupt are Overrun, Parity, Framing and Break. The Line Status Register must be read to determine the source.

Bit 3

This bit enables the MODEM Status Interrupt when set to logic "1". This is caused when one of the Modem Status Register bits changes state.

Bits 4 through 7

These bits are always logic "0".

FIFO CONTROL REGISTER (FCR)

Address Offset = 2H, DLAB = X, WRITE

This is a write only register at the same location as the IIR. This register is used to enable and clear the FIFO's, set the RCVR FIFO trigger level. Note: DMA is not supported.

Bit 0

Setting this bit to a logic "1" enables both the XMIT and RCVR FIFO's. Clearing this bit to a logic "0" disables both the XMIT and RCVR FIFO's and clears all bytes from both FIFO's. When changing from FIFO Mode to non-FIFO (16450) mode, data is automatically cleared from the FIFO's. This bit must be a 1 when other bits in this register are written to or they will not be properly programmed.

Bit 1

Setting this bit to a logic "1" clears all bytes in the RCVR FIFO and resets its counter logic to 0. The shift register is not cleared. This bit is self-clearing.

Bit 2

Setting this bit to a logic "1" clears all bytes in the XMIT FIFO and resets its counter logic to 0. The shift register is not cleared. This bit is self-clearing.

Bit 3

Writing to this bit has no effect on the operation of the UART. The RXRDY and TXRDY pins are not available on this chip.

Bit 4,5

Reserved

Bit 6,7

These bits are used to set the trigger level for the RCVR FIFO interrupt.

Bit 7	Bit 6	RCVR FIFO Trigger Level (BYTES)
0	0	1
0	1	4
1	0	8
1	1	14

INTERRUPT IDENTIFICATION REGISTER (IIR)

Address Offset = 2H, DLAB = X, READ

By accessing this register, the host CPU can determine the highest priority interrupt and its source. Four levels of priority interrupt exist. They are in descending order of priority:

1. Receiver Line Status (highest priority)
2. Received Data Ready

3. Transmitter Holding Register Empty**4. MODEM Status (lowest priority)**

Information indicating that a prioritized interrupt is pending and the source of that interrupt is stored in the Interrupt Identification Register (refer to Interrupt Control Table). When the CPU accesses the IIR, the Serial Port freezes all interrupts and indicates the highest priority pending interrupt to the CPU. During this CPU access, even if the Serial Port records new interrupts, the current indication does not change until access is completed. The contents of the IIR are described below.

Bit 0

This bit can be used in either a hardwired prioritized or polled environment to indicate whether an interrupt is pending. When bit 0 is a logic "0", an interrupt is pending and the contents of the IIR may be used as a pointer to the appropriate internal service routine. When bit 0 is a logic "1", no interrupt is pending.

Bits 1 and 2

These two bits of the IIR are used to identify the highest priority interrupt pending as indicated by the Interrupt Control Table.

Bit 3

In non-FIFO mode, this bit is a logic "0". In FIFO mode this bit is set along with bit 2 when a timeout interrupt is pending.

Bits 4 and 5

These bits of the IIR are always logic "0".

Bits 6 and 7

These two bits are set when the FIFO CONTROL Register bit 0 equals 1.

Table 34 - Interrupt Control Table

FIFO MODE ONLY	INTERRUPT IDENTIFICATION REGISTER			INTERRUPT SET AND RESET FUNCTIONS			
	Bit 3	BIT 2	BIT 1	BIT 0	PRIORITY LEVEL	INTERRUPT TYPE	INTERRUPT SOURCE
0	0	0	1	-	None	None	-
0	1	1	0	Highest	Receiver Line Status	Overflow Error, Parity Error, Framing Error or Break Interrupt	Reading the Line Status Register
0	1	0	0	Second	Received Data Available	Receiver Data Available	Read Receiver Buffer or the FIFO drops below the trigger level.
1	1	0	0	Second	Character Timeout Indication	No Characters Have Been Removed From or Input to the RCVR FIFO during the last 4 Char times and there is at least 1 char in it during this time	Reading the Receiver Buffer Register
0	0	1	0	Third	Transmitter Holding Register Empty	Transmitter Holding Register Empty	Reading the IIR Register (if Source of Interrupt) or Writing the Transmitter Holding Register
0	0	0	0	Fourth	MODEM Status	Clear to Send or Data Set Ready or Ring Indicator or Data Carrier Detect	Reading the MODEM Status Register

LINE CONTROL REGISTER (LCR)

Address Offset = 3H, DLAB = 0, READ/WRITE

This register contains the format information of the serial line. The bit definitions are:

Bits 0 and 1

These two bits specify the number of bits in each transmitted or received serial character. The encoding of bits 0 and 1 is as follows:

BIT 1	BIT 0	WORD LENGTH
0	0	5 Bits
0	1	6 Bits
1	0	7 Bits
1	1	8 Bits

The Start, Stop and Parity bits are not included in the word length.

Bit 2

This bit specifies the number of stop bits in each transmitted or received serial character. The following table summarizes the information.

BIT 2	WORD LENGTH	NUMBER OF STOP BITS
0	--	1
1	5 bits	1.5
1	6 bits	2
1	7 bits	2
1	8 bits	2

Note: The receiver will ignore all stop bits beyond the first, regardless of the number used in transmitting.

Bit 3

Parity Enable bit. When bit 3 is a logic "1", a parity bit is generated (transmit data) or

checked (receive data) between the last data word bit and the first stop bit of the serial data. (The parity bit is used to generate an even or odd number of 1s when the data word bits and the parity bit are summed).

Bit 4

Even Parity Select bit. When bit 3 is a logic "1" and bit 4 is a logic "0", an odd number of logic "1"'s is transmitted or checked in the data word bits and the parity bit. When bit 3 is a logic "1" and bit 4 is a logic "1" an even number of bits is transmitted and checked.

Bit 5

Stick Parity bit. When bit 3 is a logic "1" and bit 5 is a logic "1", the parity bit is transmitted and then detected by the receiver in the opposite state indicated by bit 4.

Bit 6

Set Break Control bit. When bit 6 is a logic "1", the transmit data output (TXD) is forced to the Spacing or logic "0" state and remains there (until reset by a low level bit 6) regardless of other transmitter activity. This feature enables the Serial Port to alert a terminal in a communications system.

Bit 7

Divisor Latch Access bit (DLAB). It must be set high (logic "1") to access the Divisor Latches of the Baud Rate Generator during read or write operations. It must be set low (logic "0") to access the Receiver Buffer Register, the Transmitter Holding Register, or the Interrupt Enable Register.

MODEM CONTROL REGISTER (MCR)

Address Offset = 4H, DLAB = X, READ/WRITE

This 8 bit register controls the interface with the MODEM or data set (or device emulating a MODEM). The contents of the MODEM control register are described below.

Bit 0

This bit controls the Data Terminal Ready ($\overline{\text{DTR}}$) output. When bit 0 is set to a logic "1", the $\overline{\text{DTR}}$ output is forced to a logic "0". When bit 0 is a logic "0", the $\overline{\text{DTR}}$ output is forced to a logic "1".

Bit 1

This bit controls the Request To Send ($\overline{\text{RTS}}$) output. Bit 1 affects the $\overline{\text{RTS}}$ output in a manner identical to that described above for bit 0.

Bit 2

This bit controls the Output 1 (OUT1) bit. This bit does not have an output pin and can only be read or written by the CPU.

Bit 3

Output 2 (OUT2). This bit is used to enable an UART interrupt. When OUT2 is a logic "0", the serial port interrupt output is forced to a high impedance state - disabled. When OUT2 is a logic "1", the serial port interrupt outputs are enabled.

Bit 4

This bit provides the loopback feature for diagnostic testing of the Serial Port. When bit 4 is set to logic "1", the following occur:

1. The TXD is set to the Marking State(logic "1").
2. The receiver Serial Input (RXD) is disconnected.
3. The output of the Transmitter Shift Register is "looped back" into the Receiver Shift Register input.
4. All MODEM Control inputs ($\overline{\text{CTS}}$, $\overline{\text{DSR}}$, $\overline{\text{RI}}$ and $\overline{\text{DCD}}$) are disconnected.
5. The four MODEM Control outputs ($\overline{\text{DTR}}$, $\overline{\text{RTS}}$, and OUT2) are internally connected to the four MODEM Control inputs.
6. The Modem Control output pins are forced inactive high.
7. Data that is transmitted is immediately received.

This feature allows the processor to verify the transmit and receive data paths of the Serial Port. In the diagnostic mode, the receiver and the transmitter interrupts are fully operational. The MODEM Control Interrupts are also operational but the interrupts' sources are now the lower four bits of the MODEM Control Register instead of the MODEM Control inputs. The interrupts are still controlled by the Interrupt Enable Register.

Bits 5 through 7

These bits are permanently set to logic zero.

LINE STATUS REGISTER (LSR)

Address Offset = 5H, DLAB = X, READ/WRITE

Bit 0

Data Ready (DR). It is set to a logic "1" whenever a complete incoming character has been received and transferred into the Receiver Buffer Register or the FIFO. Bit 0 is reset to a logic "0" by reading all of the data in the Receive Buffer Register or the FIFO.

Bit 1

Overrun Error (OE). Bit 1 indicates that data in the Receiver Buffer Register was not read before the next character was transferred into the register, thereby destroying the previous character. In FIFO mode, an overrun error will occur only when the FIFO is full and the next character has been completely received in the shift register, the character in the shift register is overwritten but not transferred to the FIFO. The OE indicator is set to a logic "1" immediately upon detection of an overrun condition, and reset whenever the Line Status Register is read.

Bit 2

Parity Error (PE). Bit 2 indicates that the received data character does not have the correct even or odd parity, as selected by the even parity select bit. The PE is set to a logic "1" upon detection of a parity error and is reset to a logic "0" whenever the Line Status Register

is read. In the FIFO mode this error is associated with the particular character in the FIFO it applies to. This error is indicated when the associated character is at the top of the FIFO.

Bit 3

Framing Error (FE). Bit 3 indicates that the received character did not have a valid stop bit. Bit 3 is set to a logic "1" whenever the stop bit following the last data bit or parity bit is detected as a zero bit (Spacing level). The FE is reset to a logic "0" whenever the Line Status Register is read. In the FIFO mode this error is associated with the particular character in the FIFO it applies to. This error is indicated when the associated character is at the top of the FIFO. The Serial Port will try to resynchronize after a framing error. To do this, it assumes that the framing error was due to the next start bit, so it samples this 'start' bit twice and then takes in the 'data'.

Bit 4

Break Interrupt (BI). Bit 4 is set to a logic "1" whenever the received data input is held in the Spacing state (logic "0") for longer than a full word transmission time (that is, the total time of the start bit + data bits + parity bits + stop bits). The BI is reset after the CPU reads the contents of the Line Status Register. In the FIFO mode this error is associated with the particular character in the FIFO it applies to. This error is indicated when the associated character is at the top of the FIFO. When break occurs only one zero character is loaded into the FIFO. Restarting after a break is received, requires the serial data (RXD) to be logic "1" for at least 1/2 bit time.

Note: Bits 1 through 4 are the error conditions that produce a Receiver Line Status Interrupt whenever any of the corresponding conditions are detected and the interrupt is enabled.

Bit 5

Transmitter Holding Register Empty (THRE). Bit 5 indicates that the Serial Port is ready to accept a new character for transmission. In addition, this bit causes the Serial Port to issue an interrupt when the Transmitter Holding Register interrupt enable is set high. The THRE bit is set to a logic "1" when a character is transferred from the Transmitter Holding Register into the Transmitter Shift Register. The bit is reset to logic "0" whenever the CPU loads the Transmitter Holding Register. In the FIFO mode this bit is set when the XMIT FIFO is empty, it is cleared when at least 1 byte is written to the XMIT FIFO. Bit 5 is a read only bit.

Bit 6

Transmitter Empty (TEMT). Bit 6 is set to a logic "1" whenever the Transmitter Holding Register (THR) and Transmitter Shift Register (TSR) are both empty. It is reset to logic "0" whenever either the THR or TSR contains a data character. Bit 6 is a read only bit. In the FIFO mode this bit is set whenever the THR and TSR are both empty,

Bit 7

This bit is permanently set to logic "0" in the 450 mode. In the FIFO mode, this bit is set to a logic "1" when there is at least one parity error, framing error or break indication in the FIFO. This bit is cleared when the LSR is read if there are no subsequent errors in the FIFO.

MODEM STATUS REGISTER (MSR)

Address Offset = 6H, DLAB = X, READ/WRITE

This 8 bit register provides the current state of the control lines from the MODEM (or peripheral device). In addition to this current state information, four bits of the MODEM Status Register (MSR) provide change information. These bits are set to logic "1" whenever a

control input from the MODEM changes state. They are reset to logic "0" whenever the MODEM Status Register is read.

Bit 0

Delta Clear To Send (DCTS). Bit 0 indicates that the $\overline{\text{CTS}}$ input to the chip has changed state since the last time the MSR was read.

Bit 1

Delta Data Set Ready (DDSR). Bit 1 indicates that the $\overline{\text{DSR}}$ input has changed state since the last time the MSR was read.

Bit 2

Trailing Edge of Ring Indicator (TERI). Bit 2 indicates that the $\overline{\text{RI}}$ input has changed from logic "0" to logic "1".

Bit 3

Delta Data Carrier Detect (DDCD). Bit 3 indicates that the $\overline{\text{DCD}}$ input to the chip has changed state.

NOTE: Whenever bit 0, 1, 2, or 3 is set to a logic "1", a MODEM Status Interrupt is generated.

Bit 4

This bit is the complement of the Clear To Send ($\overline{\text{CTS}}$) input. If bit 4 of the MCR is set to logic "1", this bit is equivalent to $\overline{\text{RTS}}$ in the MCR.

Bit 5

This bit is the complement of the Data Set Ready ($\overline{\text{DSR}}$) input. If bit 4 of the MCR is set to logic "1", this bit is equivalent to DSR in the MCR.

Bit 6

This bit is the complement of the Ring Indicator ($\overline{\text{RI}}$) input. If bit 4 of the MCR is set to logic "1", this bit is equivalent to OUT1 in the MCR.

Bit 7

This bit is the complement of the Data Carrier

Detect ($\overline{\text{DCD}}$) input. If bit 4 of the MCR is set to logic "1", this bit is equivalent to OUT2 in the MCR.

SCRATCHPAD REGISTER (SCR)

Address Offset = 7H, DLAB = X, READ/WRITE

This 8 bit read/write register has no effect on the operation of the Serial Port. It is intended as a scratchpad register to be used by the programmer to hold data temporarily.

PROGRAMMABLE BAUD RATE GENERATOR (AND DIVISOR LATCHES DLH, DLL)

The Serial Port contains a programmable Baud Rate Generator that is capable of taking any clock input (DC to 3 MHz) and dividing it by any divisor from 1 to 65535. This output frequency of the Baud Rate Generator is 16x the Baud rate. Two 8 bit latches store the divisor in 16 bit binary format. These Divisor Latches must be loaded during initialization in order to insure desired operation of the Baud Rate Generator. Upon loading either of the Divisor Latches, a 16 bit Baud counter is immediately loaded. This prevents long counts on initial load. If a 0 is loaded into the BRG registers the output divides the clock by the number 3. If a 1 is loaded the output is the inverse of the input oscillator. If a two is loaded the output is a divide by 2 signal with a 50% duty cycle. If a 3 or greater is loaded the output is low for 2 bits and high for the remainder of the count. The input clock to the BRG is the 24 MHz crystal divided by 13, giving a 1.8462 MHz clock.

Table 35 shows the baud rates possible with a 1.8462 MHz crystal.

Effect Of The Reset on Register File

The Reset Function Table (Table 36) details the effect of the Reset input on each of the registers of the Serial Port.

FIFO INTERRUPT MODE OPERATION

When the RCVR FIFO and receiver interrupts are enabled (FCR bit 0 = "1", IER bit 0 = "1"), RCVR interrupts occur as follows:

- A. The receive data available interrupt will be issued when the FIFO has reached its programmed trigger level; it is cleared as soon as the FIFO drops below its programmed trigger level.
- B. The IIR receive data available indication also occurs when the FIFO trigger level is reached. It is cleared when the FIFO drops below the trigger level.
- C. The receiver line status interrupt (IIR=06H), has higher priority than the received data available (IIR=04H) interrupt.
- D. The data ready bit (LSR bit 0) is set as soon as a character is transferred from the shift register to the RCVR FIFO. It is reset when the FIFO is empty.

When RCVR FIFO and receiver interrupts are enabled, RCVR FIFO timeout interrupts occur as follows:

- A. A FIFO timeout interrupt occurs if all the following conditions exist:
 - at least one character is in the FIFO
 - The most recent serial character received was longer than 4 continuous character times ago. (If 2 stop bits are programmed, the second one is included in this time delay.)
 - The most recent CPU read of the FIFO was longer than 4 continuous character times ago.

This will cause a maximum character received to interrupt issued delay of 160 msec at 300 BAUD with a 12 bit character.

- B. Character times are calculated by using the RCLK input for a clock signal (this makes the delay proportional to the baudrate).

- C. When a timeout interrupt has occurred it is cleared and the timer reset when the CPU reads one character from the RCVR FIFO.

- D. When a timeout interrupt has not occurred the timeout timer is reset after a new character is received or after the CPU reads the RCVR FIFO.

When the XMIT FIFO and transmitter interrupts are enabled (FCR bit 0 = "1", IER bit 1 = "1"), XMIT interrupts occur as follows:

- A. The transmitter holding register interrupt (O2H) occurs when the XMIT FIFO is empty; it is cleared as soon as the transmitter holding register is written to (1 of 16 characters may be written to the XMIT FIFO while servicing this interrupt) or the IIR is read.

- B. The transmitter FIFO empty indications will be delayed 1 character time minus the last stop bit time whenever the following occurs: THRE=1 and there have not been at least two bytes at the same time in the transmitter FIFO since the last THRE=1. The transmitter interrupt after changing FCRO will be immediate, if it is enabled.

Character timeout and RCVR FIFO trigger level interrupts have the same priority as the current received data available interrupt; XMIT FIFO empty has the same priority as the current transmitter holding register empty interrupt.

FIFO POLLED MODE OPERATION

With FCR bit 0 = "1" resetting IER bits 0, 1, 2 or 3 or all to zero puts the UART in the FIFO Polled Mode of operation. Since the RCVR and

XMITTER are controlled separately, either one or both can be in the polled mode of operation.

In this mode, the user's program will check RCVR and XMITTER status via the LSR. LSR definitions for the FIFO Polled Mode are as follows:

- Bit 0 = 1 as long as there is one byte in the RCVR FIFO.
- Bits 1 to 4 specify which error(s) have occurred. Character error status is handled the same way as when in the interrupt

mode, the IIR is not affected since EIR bit 2 = 0.

- Bit 5 indicates when the XMIT FIFO is empty.
- Bit 6 indicates that both the XMIT FIFO and shift register are empty.
- Bit 7 indicates whether there are any errors in the RCVR FIFO.

There is no trigger level reached or timeout condition indicated in the FIFO Polled Mode, however, the RCVR and XMIT FIFO's are still fully capable of holding characters.

Table 35 - Baud Rates Using 1.8462 MHz Clock (24 MHz/13)

DESIRED BAUD RATE	DIVISOR USED TO GENERATE 16X CLOCK	PERCENT ERROR DIFFERENCE BETWEEN DESIRED AND ACTUAL*
50	2304	0.001
75	1536	-
110	1047	-
134.5	857	0.004
150	768	-
300	384	-
600	192	-
1200	96	-
1800	64	-
2000	58	0.005
2400	48	-
3600	32	-
4800	24	-
7200	16	-
9600	12	-
19200	6	-
38400	3	0.030
56000	2	2.86
115200	1	0.16

*Note: The percentage error for all baud rates, except where indicated otherwise, is 0.2%.

Table 36 - Reset Function Table

REGISTER/SIGNAL	RESET CONTROL	RESET STATE
Interrupt Enable Register	RESET	All bits low
Interrupt Identification Reg.	RESET	Bit 0 is high; Bits 1 thru 7 low
FIFO Control	RESET	All bits low
Line Control Reg.	RESET	All bits low
MODEM Control Reg.	RESET	All bits low
Line Status Reg.	RESET	All bits low except 5, 6 high
MODEM Status Reg.	RESET	Bits 0 - 3 low; Bits 4 - 7 input
TXD1, TXD2	RESET	High
INTRPT (RCVR errs)	RESET/Read LSR	Low
INTRPT (RCVR Data Ready)	RESET/Read RBR	Low
INTRPT (THRE)	RESET/ReadIIR/Write THR	Low
OUT2B	RESET	High
RTSB	RESET	High
DTRB	RESET	High
OUT1B	RESET	High
RCVR FIFO	RESET/FCR1 *FCR0/ΔFCR0	All Bits Low
XMIT FIFO	RESET/FCR1 *FCR0/ΔFCR0	All Bits Low

Table 37 - Register Summary for an Individual UART Channel

REGISTER ADDRESS*	REGISTER NAME	REGISTER SYMBOL	BIT 0	BIT 1
ADDR = 0 DLAB = 0	Receive Buffer Register (Read Only)	RBR	Data Bit 0 (Note 1)	Data Bit 1
ADDR = 0 DLAB = 0	Transmitter Holding Register (Write Only)	THR	Data Bit 0	Data Bit 1
ADDR = 1 DLAB = 0	Interrupt Enable Register	IER	Enable Received Data Available Interrupt (ERDAI)	Enable Transmitter Holding Register Empty Interrupt (ETHREI)
ADDR = 2	Interrupt Ident. Register (Read Only)	IIR	"0" if Interrupt Pending	Interrupt ID Bit
ADDR = 2	FIFO Control Register (Write Only)	FCR	FIFO Enable	RCVR FIFO Reset
ADDR = 3	Line Control Register	LCR	Word Length Select Bit 0 (WLS0)	Word Length Select Bit 1 (WLS1)
ADDR = 4	MODEM Control Register	MCR	Data Terminal Ready (DTR)	Request to Send (RTS)
ADDR = 5	Line Status Register	LSR	Data Ready (DR)	Overrun Error (OE)
ADDR = 6	MODEM Status Register	MSR	Delta Clear to Send (DCTS)	Delta Data Set Ready (DDSR)
ADDR = 7	Scratch Register (Note 4)	SCR	Bit 0	Bit 1
ADDR = 0 DLAB = 1	Divisor Latch (LS)	DDL	Bit 0	Bit 1
ADDR = 1 DLAB = 1	Divisor Latch (MS)	DLM	Bit 8	Bit 9

*DLAB is Bit 7 of the Line Control Register (ADDR = 3).

Note 1: Bit 0 is the least significant bit. It is the first bit serially transmitted or received.

Note 2: When operating in the XT mode, this bit will be set any time that the transmitter shift register is empty.

Table 37 - Register Summary for an Individual UART Channel (continued)

BIT 2	BIT 3	BIT 4	BIT 5	BIT 6	BIT 7
Data Bit 2	Data Bit 3	Data Bit 4	Data Bit 5	Data Bit 6	Data Bit 7
Data Bit 2	Data Bit 3	Data Bit 4	Data Bit 5	Data Bit 6	Data Bit 7
Enable Receiver Line Status Interrupt (ELSI)	Enable MODEM Status Interrupt (EMS)	0	0	0	0
Interrupt ID Bit	Interrupt ID Bit (Note 5)	0	0	FIFOs Enabled (Note 5)	FIFOs Enabled (Note 5)
XMIT FIFO Reset	DMA Mode Select (Note 6)	Reserved	Reserved	RCVR Trigger LSB	RCVR Trigger MSB
Number of Stop Bits (STB)	Parity Enable (PEN)	Even Parity Select (EPS)	Stick Parity	Set Break	Divisor Latch Access Bit (DLAB)
OUT1 (Note 3)	OUT2 (Note 3)	Loop	0	0	0
Parity Error (PE)	Framing Error (FE)	Break Interrupt (BI)	Transmitter Holding Register (THRE)	Transmitter Empty (TEMT) (Note 2)	Error in RCVR FIFO (Note 5)
Trailing Edge Ring Indicator (TERI)	Delta Data Carrier Detect (DDCD)	Clear to Send (CTS)	Data Set Ready (DSR)	Ring Indicator (RI)	Data Carrier Detect (DCD)
Bit 2	Bit 3	Bit 4	Bit 5	Bit 6	Bit 7
Bit 2	Bit 3	Bit 4	Bit 5	Bit 6	Bit 7
Bit 10	Bit 11	Bit 12	Bit 13	Bit 14	Bit 15

Note 3: This bit no longer has a pin associated with it.

Note 4: When operating in the XT mode, this register is not available.

Note 5: These bits are always zero in the non-FIFO mode.

Note 6: Writing a one to this bit has no effect. DMA modes are not supported in this chip.

NOTES ON SERIAL PORT OPERATION FIFO MODE OPERATION:

GENERAL

The RCVR FIFO will hold up to 16 bytes regardless of which trigger level is selected.

TX AND RX FIFO OPERATION

The Tx portion of the UART transmits data through TXD as soon as the CPU loads a byte into the Tx FIFO. **The UART will prevent loads to the Tx FIFO if it currently holds 16 characters.** Loading to the Tx FIFO will again be enabled as soon as the next character is transferred to the Tx shift register. These capabilities account for the largely autonomous operation of the Tx.

The UART starts the above operations typically with a Tx interrupt. The chip issues a Tx interrupt whenever the Tx FIFO is empty and the Tx interrupt is enabled, except in the following instance. Assume that the Tx FIFO is empty and the CPU starts to load it. When the first byte enters the FIFO the Tx FIFO empty interrupt will transition from active to inactive. Depending on the execution speed of the service routine software, the UART may be able to transfer this byte from the FIFO to the shift register before the CPU loads another byte. If this happens, the Tx FIFO will be empty again and typically the UART's interrupt line would transition to the active state. This could cause a system with an interrupt control unit to record a Tx FIFO empty condition, even though the CPU is currently servicing that interrupt. **Therefore, after the first byte has been loaded into the FIFO the UART will wait one serial character transmission time before issuing a new Tx FIFO empty interrupt.**

This one character Tx interrupt delay will remain active until at least two bytes have been loaded into the FIFO, concurrently. When the Tx FIFO empties after this condition, the Tx interrupt will be activated without a one character delay.

Rx support functions and operation are quite different from those described for the transmitter. The Rx FIFO receives data until the number of bytes in the FIFO equals the selected interrupt trigger level. At that time if Rx interrupts are enabled, the UART will issue an interrupt to the CPU. The Rx FIFO will continue to store bytes until it holds 16 of them. It will not accept any more data when it is full. Any more data entering the Rx shift register will set the Overrun Error flag. Normally, the FIFO depth and the programmable trigger levels will give the CPU ample time to empty the Rx FIFO before an overrun occurs.

One side-effect of having a Rx FIFO is that the selected interrupt trigger level may be above the data level in the FIFO. This could occur when data at the end of the block contains fewer bytes than the trigger level. No interrupt would be issued to the CPU and the data would remain in the UART. **To prevent the software from having to check for this situation the chip incorporates a timeout interrupt.**

The timeout interrupt is activated when there is a least one byte in the Rx FIFO, and neither the CPU nor the Rx shift register has accessed the Rx FIFO within 4 character times of the last byte. The timeout interrupt is cleared or reset when the CPU reads the Rx FIFO or another character enters it.

These FIFO related features allow optimization of CPU/UART transactions and are especially useful given the higher baud rate capability (256 kbaud).

PARALLEL PORT

The FDC37C663 and FDC37C664 incorporate one IBM XT/AT compatible parallel port. The FDC37C663 and FDC37C664 support the optional PS/2 type bi-directional parallel port (SPP) mode. Refer to the FDC37C663 Configuration Registers and FDC37C664 Hardware Configuration description for information on disabling, power down, changing the base address of the parallel port, and selecting the mode of operation.

The FDC37C663 and FDC37C664 also incorporate SMC's ChiProtect circuitry, which

prevents possible damage to the parallel port due to printer power-up.

The functionality of the Parallel Port is achieved through the use of three addressable ports, with their associated registers and control gating. The control and data port are read/write by the CPU, the status port is read only. The address map of the Parallel Port is shown below:

DATA PORT	BASE ADDRESS + 00H
STATUS PORT	BASE ADDRESS + 01H
CONTROL PORT	BASE ADDRESS + 02H

The bit map of these registers is:

	D0	D1	D2	D3	D4	D5	D6	D7
DATA PORT	PDO	PD1	PD2	PD3	PD4	PD5	PD6	PD7
STATUS PORT	0	0	0	$\overline{\text{ERR}}$	SLCT	PE	$\overline{\text{ACK}}$	$\overline{\text{BUSY}}$
CONTROL PORT	STROBE	AUTOFD	$\overline{\text{INIT}}$	SLC	IRQE	PCD	0	0

IBM XT/AT COMPATIBLE AND BI-DIRECTIONAL MODES

DATA PORT ADDRESS OFFSET = 00H

The Data Port is located at an offset of '00H' from the base address. The data register is cleared at initialization by RESET. During a WRITE operation, the Data Register latches the contents of the data bus with the rising edge of the $\overline{\text{IOW}}$ input. The contents of this register are buffered (non inverting) and output onto the PDO - PD7 ports. During a READ operation, PDO - PD7 ports are buffered (not latched) and output to the host CPU.

STATUS PORT ADDRESS OFFSET = 01H

The Status Port is located at an offset of '01H' from the base address. The contents of this register are latched for the duration of an $\overline{\text{IOR}}$ read cycle. The bits of the Status Port are defined as follows:

BITS 0, 1, 2 - are not implemented as register bits, during a read of the Printer Status Register these bits are a low level.

BIT 3 $\overline{\text{ERR}}$ - ERROR

The level on the $\overline{\text{ERROR}}$ input is read by the CPU as bit 3 of the Printer Status Register. A

logic 0 means an error has been detected; a logic 1 means no error has been detected.

BIT 4 SLCT - PRINTER SELECTED STATUS

The level on the SLCT input is read by the CPU as bit 4 of the Printer Status Register. A logic 1 means the printer is on line; a logic 0 means it is not selected.

BIT 5 PE - PAPER END

The level on the PE input is read by the CPU as bit 5 of the Printer Status Register. A logic 1 indicates a paper end; a logic 0 indicates the presence of paper.

BIT 6 $\overline{\text{ACK}}$ - $\overline{\text{ACKNOWLEDGE}}$

The level on the $\overline{\text{ACK}}$ input is read by the CPU as bit 6 of the Printer Status Register. A logic 0 means that the printer has received a character and can now accept another. A logic 1 means that it is still processing the last character or has not received the data.

BIT 7 $\overline{\text{BUSY}}$ - $\overline{\text{BUSY}}$

The complement of the level on the BUSY input is read by the CPU as bit 7 of the Printer Status Register. A logic 0 in this bit means that the printer is busy and cannot accept a new character. A logic 1 means that it is ready to accept the next character.

CONTROL PORT

ADDRESS OFFSET = 02H

The Control Port is located at an offset of '02H' from the base address. The Control Register is initialized by the RESET input, bits 0 to 5 only being affected; bits 6 and 7 are hard wired low.

BIT 0 STROBE - STROBE

This bit is inverted and output onto the $\overline{\text{STROBE}}$ output.

BIT 1 AUTOFD - AUTOFEED

This bit is inverted and output onto the $\overline{\text{AUTOFD}}$ output. A logic 1 causes the printer to generate a line feed after each line is printed. A logic 0 means no autofeed.

BIT 2 $\overline{\text{INIT}}$ - $\overline{\text{INITIATE OUTPUT}}$

This bit is output onto the $\overline{\text{INIT}}$ output without inversion.

BIT 3 SLCTIN - PRINTER SELECT INPUT

This bit is inverted and output onto the $\overline{\text{SLCTIN}}$ output. A logic 1 on this bit selects the printer; a logic 0 means the printer is not selected.

BIT 4 IRQE - INTERRUPT REQUEST ENABLE

The interrupt request enable bit when set to a high level may be used to enable interrupt requests from the Parallel Port to the CPU. An interrupt request is generated on the IRQ port by a positive going $\overline{\text{ACK}}$ input. When the IRQE bit is programmed low the IRQ is disabled.

BIT 5 PCD - PARALLEL CONTROL DIRECTION

Parallel Control Direction is valid in extended mode only (CR#1 < 3 > = 0). In printer mode, the direction is always out regardless of the state of this bit. In bi-directional mode, a logic 0 means that the printer port is in output mode (write); a logic 1 means that the printer port is in input mode (read).

Bits 6 and 7 during a read are a low level, and cannot be written.

Table 38 - Parallel Port Connector

HOST CONNECTOR	PIN NUMBER	STANDARD
1	77	nStrobe
2-9	71-68, 66-63	PData <0:7 >
10	62	nAck
11	61	Busy
12	60	PE
13	59	Select
14	76	nAutofd
15	75	nError
16	74	nInIt
17	73	nSelectin

n<NAME> = Active Low

INTEGRATED DRIVE ELECTRONICS INTERFACE

The IDE interface enables hard disks with embedded controllers (AT and XT) to be interfaced to the host processor. The following definitions are for reference only. These registers are not implemented in the FDC37C663 and FDC37C664. Access to these registers are controlled by the FDC37C663 and FDC37C664. For more information, refer to the IDE pin descriptions and the ATA specification.

HOST FILE REGISTERS

The HOST FILE REGISTERS are accessed by the AT Host, rather than the Local Processor. There are two groups of registers, the AT Task File, and the Miscellaneous AT Registers.

ADDRESS 1F0H-1F7H; 170H-177H

These AT registers contain the Task File Registers. These registers communicate data, command, and status information with the AT host, and are addressed when $\overline{\text{HDSC0}}$ is low.

ADDRESS 376H/3F6H; 377H/3F7H

These AT registers may be used by the BIOS for drive control. They are accessed by the AT interface when $\overline{\text{HDSC1}}$ is active.

Figure 3 shows the AT Host Register Map of the FDC37C663 and FDC37C664.

FIGURE 3 - HOST PROCESSOR REGISTER ADDRESS MAP (AT MODE)

PRIMARY	SECONDARY	
1F0H 1F7H	170H 177H	TASK FILE REGISTERS
3F6H 3F7H	376H 377H	MISC AT REGISTERS

TASK FILE REGISTERS

Task File Registers may be accessed by the host AT when pin $\overline{\text{HDSC0}}$ is active (low). The Data Register (1F0H) is 16 bits wide; the remaining task file registers are 8 bits wide. The task file registers are ATA and EATA

compatible. Please refer to the ATA and EATA specifications. These are available from:

Global Engineering
2805 McGaw Street
Irvine, CA 92714
(800) 854-7179
(714) 261-1455

COMMAND	D7	D6	D5	D4	D3	D2	D1	D0
RESTORE (RECALIBRATE)	0	0	0	1	r	r	r	r
SEEK	0	1	1	1	r	r	r	r
READ SECTOR	0	0	1	0	D	0	L	T
WRITE SECTOR	0	0	1	1	D	0	L	T
FORMAT TRACK	0	1	0	1	D	0	0	0
READ VERIFY	0	1	0	0	D	0	0	T
DIAGNOSE	1	0	0	1	0	0	0	0
SET PARAMETERS	1	0	0	1	0	0	0	1

Bit definitions:

r: specifies the step rate to be used for the command.

D: If set, 16 bit DMA is to be used for the data transfer. (Optional for high performance)

L: If set, the ECC will be transferred following the data.

T: if set, retries are inhibited for the command.

**AT HOST ADDRESSABLE REGISTERS
(For Reference Only)**

TASK FILE REGISTERS

ADDR	R/W	D15	D14	D13	D12	D11	D10	D9	D8	D7	D6	D5	D4	D3	D2	D1	D0	NAME
000H	R/W	DATA REGISTER (REDIRECTED TO FIFO)																DATA REG

ADDR	R/W	D7	D6	D5	D4	D3	D2	D1	D0	NAME
------	-----	----	----	----	----	----	----	----	----	------

001H	R	BB	CRC	ID	AC	TK	DM	ERROR FLAGS
001H	W	CYLINDER NUMBER + 4						WRITE PRECOMP CYLINDER

002H	R/W	NUMBER OF SECTORS								SECTOR COUNT
------	-----	-------------------	--	--	--	--	--	--	--	--------------

003H	R/W	SECTOR NUMBER								SECTOR NUMBER
------	-----	---------------	--	--	--	--	--	--	--	---------------

004H	R/W	CYLINDER NUMBER (LSB'S)								CYLINDER LOW
------	-----	-------------------------	--	--	--	--	--	--	--	--------------

006H	R/W	CYLINDER NUMBER (MSB'S)								CYLINDER HIGH
------	-----	-------------------------	--	--	--	--	--	--	--	---------------

006H	R/W	DRIVE	HEAD	HEAD, DRIVE			
------	-----	-------	------	-------------	--	--	--

007H	R	BSY	RDY	WF	SC	DRQ	CD	INDEX	ERR	STATUS
007H	W	COMMAND								COMMAND

MISCELLANEOUS AT REGISTERS

ADDR	R/W	D7	D6	D5	D4	D3	D2	D1	D0	NAME
------	-----	----	----	----	----	----	----	----	----	------

3F6H/376H	R	BSY	RDY	WF	SC	DRQ	CD	INDEX	ERR	STATUS
3F6H/376H	W	RESERVED				H33EN	ADPTR RESET	DISABLE IRQ	RE- SERVED	FIXED DISK

3F7H/377H	R	-	WG	RS3	RS2	RST	RS0	DST	DS0	DIGITAL INPUT
3F7H/377H	W	-	-	-	-	-	-	-	-	RESERVED

CONFIGURATION

The configuration of the FDC37C663 within the user system is selected through software selectable configuration registers. The different configurations of the FDC37C664 can be selected through a combination of jumper options and software.

FDC37C663 CONFIGURATION REGISTERS

The configuration registers are used to select programmable options of the FDC. After power up, the FDC is in the default mode. The default modes are identified in the Configuration Mode Register Description. To program the configuration registers, the following sequence must be followed:

1. Enter Configuration Mode.
2. Configure FDC Registers.
3. Exit Configuration Mode.

Enter Configuration Mode

To enter the configuration mode of the FDC37C663, two writes in succession to port 3F0H with 55H data are required. If a write to

another address or port occurs between these two writes, the chip does not enter the configuration mode. It is strongly recommended that interrupts be disabled for the duration of these two writes.

Configure FDC37C663

The FDC37C663 contains SIXTEEN configuration registers, CRO-CRF. These registers are accessed by first writing the number (0-F) of the desired register to port 3F0H and then writing or reading the configuration register through port 3F1H.

Exit Configuration Mode

The configuration mode is exited by writing an AAH to port 3F0H.

Programming Example

The following is an example of a configuration program in Intel 8086 assembly language. For this example, the FDC37C663 is being reset to the default condition after power up.

```

;-----
; ENTER CONFIGURATION MODE
;-----
MOV    DX,3FOH
MOV    AX,055H      ;use 044H for FDC37C664
CLI    ; disable interrupts
OUT    DX,AL
OUT    DX,AL
STI    ; enable interrupts
;-----
; CONFIGURE REGISTERS CRO-CRx
;-----
MOV    DX,3FOH
MOV    AL,00H
OUT    DX,AL ; Point to CRO
MOV    DX,3F1H
MOV    AL,3FH
OUT    DX,AL ; Update CRO
;
MOV    DX,3FOH      ;
MOV    AL,01H
OUT    DX,AL ; Point to CR1
MOV    DX,3F1H
MOV    AL,9FH
OUT    DX,AL ; Update CR1
;
; Repeat for all CRx registers
;
;-----
; EXIT CONFIGURATION MODE
;-----
MOV    DX,3FOH
MOV    AX,0AAH
OUT    DX,AL

```

Table 39 - FDC37C663 Configuration Registers

Default		DB7	DB6	DB5	DB4	DB3	DB2	DB1	DB0	
3BH	CR0	VALID	OSC		FDC EN	FDC PWR	(RESERVED)	IDE AT/XT	IDE EN	
9FH	CR1	LOCK CRx	COM3, 4 ADDR		IRQ POL	PP MODE	PP PWR	Parallel Port Address		
DCH	CR2	UART2 PWR	UART2 EN	UART2 ADDRESS		UART1 PWR	UART1 EN	UART1 ADDRESS		
7BH	CR3	ADR _x /DRV2 EN	IDENT	MFM	DRIVE OPTIONS		(RESERVED)	ENHANCED FDC MODE 2	(RESERVED)	
00H	CR4	(RESERVED)		MIDI 2	MIDI 1	(RESERVED)	(RESERVED)	0	0	
00H	CR5	(RESERVED)	EXTx4	DRV OX1	DEN SEL		DMA MODE	IDE SEC	FDC SEC	
FFH	CR6	Floppy Drive D		Floppy Drive C		Floppy Drive B		Floppy Drive A		
00H	CR7	RESERVED				Media ID Polarity		Floppy Boot Drive		
00H	CR8	ADR7	ADR6	ADR5	ADR4	ADR3	ADR2	ADR1	ADR0	
00H	CR9	RESERVED					ADR10	ADR9	ADR8	
00H	CRA	RESERVED				RESERVED				
TBD	CRB	RESERVED								
TBD	CRC	RESERVED								
64/63H	CRD	0	1	1	0	0	1/0	0/1	0/1	
01H	CRE	0	0	0	0	0	0	1	0	
00H	CRF	TEST MODES - RESERVED								

FDC37C663 Configuration Register Description

The configuration registers consist of seventeen registers, the Configuration Select Register and Configuration Registers 0-F. The configuration select register is written to by writing to port 3FOH. The Configuration Registers 0-F are accessed by reading or writing to port 3F1H.

Configuration Select Register (CSR)

This register can only be accessed when the FDC is in the Configuration Mode. This register, located at port 3FOH, must be initialized upon

entering the Configuration Mode before the configuration registers (CR0-CRF) can be accessed and is used to select which of the Configuration Registers are to be accessed at port 3F1H.

Configuration Registers 0-F

These registers are set to their default values at power up and are not affected by RESET. They are accessed at port 3F1H. Refer to the following descriptions for the function of each configuration register.

8564686 0008522 64T

CRO

This register can only be accessed when the FDC is in the Configuration Mode and after the CSR has been initialized to 00H. The default

value of this register after power up is 3BH for the FDC37C663 and 2BH for the FDC37C664.

Table 40 - CRO

BIT NO.	BIT NAME	DESCRIPTION
0	IDE ENABLE	A high level on this bit, enables the IDE (Default). A low level on this bit disables the IDE.
1	IDE AT/XT	A high level on this bit sets the IDE to AT type (Default). A low level on this bit sets the IDE to XT type.
2	RESR	(This bit is Reserved - set to '0').
3	FDC POWER	A high level on this bit, supplies power to the FDC (Default). A low level on this bit puts the FDC in low power mode.
4	FDC ENABLE	A high level on this bit, enables the FDC (Default for FDC37C663). A low level on this bit disables the FDC (Default for FDC37C663).
5,6	OSC	<u>6 5</u> 0 0 Osc ON, Baud Rate Generator (BRG) Clock Enabled. 0 1 Osc is On, BRG Clock is ON when PWRGD is active. When PWRGD is inactive, Osc is off and BRG Clock is Disabled (Default). 1 0 (same as 0 1 case) 1 1 Osc OFF, BR Generator Clock Disabled
7	VALID	A high level on this software controlled bit indicates that a valid configuration cycle has occurred. The control software must take care to set this bit at the appropriate times. Set to zero after power up.

CR1

This register can only be accessed when the FDC is in the Configuration Mode and after the

CSR has been initialized to 01H. The default value of this register after power up is 9FH.

Table 41 - CR1

BIT NO.	BIT NAME	DESCRIPTION
0,1	Parallel Port Address	These bits are used to select the Parallel Port Address. <u>1 0 Parallel Port Address</u> 0 0 Disabled 0 1 3BCH 1 0 378H 1 1 278H (Default)
2	Parallel Port Power	A high level on this bit, supplies power to the Parallel Port (Default). A low level on this bit puts the Parallel Port in low power mode.
3	Parallel Port Mode	Parallel Port Mode. A high level on this bit, sets the Parallel Port for Printer Mode (Default). A low level on this bit enables the Extended Parallel port modes. Refer to Bits 0 and 1 of CR4
4	IRQ Polarity	A high level on this bit, programs IRQ3, IRQ4, FINTR and (PINTR) for active high, inactive low (Default). A low level on this bit programs IRQ3, IRQ4, FINTR and (PINTR) for active low, inactive hi-Z.
5,6	COM3,4	Select the COM3 and COM4 address. <u>6 5 COM3 COM4</u> 0 0 338H 238H (Default) 0 1 3E8H 2E8H 1 0 2E8H 2E0H 1 1 220H 228H
7	LOCK CRx	A high level on this bit enables the reading and writing of CRO-CRF (Default). A low level on this bit disables the reading and writing of CRO-CRF. Once set to 0, this bit can only be set to 1 by a hard reset or power-up reset.

CR2

This register can only be accessed when the FDC is in the Configuration Mode and after the

CSR has been initialized to 02H. The default value of this register after power up is DCH.

Table 42 - CR2

BIT NO.	BIT NAME	DESCRIPTION
0,1	UART 1 Address Select	These bits select the Primary Serial Port Address. 1 0 COM Port ADDRESS 0 0 COM1 3F8H (Default) 0 1 COM2 2F8H 1 0 COM3 (Refer to CR1, bits 5,6) 1 1 COM4 (Refer to CR1, bits 5,6)
2	UART 1 Enable	A high level on this bit, enables the Primary Serial Port (Default). A low level on this bit disables the Primary Serial Port.
3	UART 1 Power down	A high level on this bit, allows normal operation of the Primary Serial Port (Default). A low level on this bit places the Primary Serial Port into Power Down Mode.
4,5	UART 2 Address Select	These bits select the Secondary Serial Port Address. 5 4 COM Port ADDRESS 0 0 COM1 3F8H 0 1 COM2 2F8H (Default) 1 0 COM3 (Refer to CR1, bits 5,6) 1 1 COM4 (Refer to CR1, bits 5,6)
6	UART 2 Enable	A high level on this bit enables the Secondary Serial Port (Default). A low level on this bit disables the Secondary Serial Port.
7	UART 2 Power down	A high level on this bit, allows normal operation of the Secondary Serial Port (Default). A low level on this bit places the Secondary Serial Port into Power Down Mode.

CR3

This register can only be accessed when the FDC is in the Configuration Mode and the

CSR has been initialized to 03H. The default value after power up is 78H.

Table 43 - CR3

BIT NO.	BIT NAME	DESCRIPTION		
0	RESERVED	Reserved - Read as zero		
1	Enhanced Floppy Mode 2	Bit 1	Floppy Mode - Refer to the description of the TAPE DRIVE REGISTER (TDR) for more information on these modes.	
		0	NORMAL Floppy Mode (Default)	
		1	Enhanced Floppy Mode 2 (OS2)	
2	RESERVED	Reserved - Read as zero		
3	Drive Opt 0	These two bits control the DRATE0 and DRATE1 outputs. The mapping from the DRATE SEL bit of the DSR, DIR AND CCR to the DRATE outputs is shown in Table 44 below. Defaults 1, 1 after power-up. If bit 1 = 1, then bits 3 and 4 become "don't cares".		
4	Drive Opt 1			
5	MFM	IDENT is used in conjunction with MFM to define the interface mode of operation.		
6	IDENT	IDENT	MFM	MODE
		1	1	AT Mode (Default)
		1	0	Reserved
		0	1	PS/2
7	ADRx/DRV2 EN			Model 30

Table 44 - Drive Option 1 and 2

DATA RATE KB/sec	REGISTER SETTINGS		CONFIG. REGISTER		OUTPUTS PINS	
	DRATE SEL 1	DRATE SEL 0	DRIVE OPT 0	DRIVE OPT 1	DRATE1	DRATE0
1000	1	1	0	0	1	1
500	0	0	0	0	0	0
300	0	1	0	0	0	1
250	1	0	0	0	1	0
1000	1	1	1	0	1	1
500	0	0	1	0	1	0
300	0	1	1	0	0	1
250	1	0	1	0	0	0
X	X	X	0	1	TBD	TBD
X	X	X	1	1	INPUT	INPUT

CR4

This register can only be accessed when the FDC is in the Configuration Mode and the CSR has been initialized to 04H. The default value after power up is 00H. The default value after power up is 00H.

Table 45 - CR4 - Parallel and Serial Extended Setup Register

BIT NO.	BIT NAME	DESCRIPTION		
		Bit 1	Bit 0	If CR1 bit 3 is a low level then:
1,0	Parallel Port Extended Modes	0	0	Standard and Bidirectional Modes (SPP) (Default)
		0	1	Reserved
		1	0	Reserved
		1	1	Reserved
2	RESR	(This bit is Reserved - set/read as '0').		
3	RESR	(This bit is Reserved - set/read as '0').		
4	MIDI 1	Serial Clock Select Port 1: A low level on this bit, disables MIDI support, clock = divide by 13 (Default). A high level on this bit enables MIDI support, clock = divide by 12. (Note CR4_3)		
5	MIDI 2	Serial Clock Select Port 2: A low level on this bit, disables MIDI support, clock = divide by 13 (Default). A high level on this bit enables MIDI support, clock = divide by 12. (Note 1)		
6	RESR	(This bit is Reserved - set/read as '0').		
7	RESR	(This bit is Reserved - set/read as '0').		

Note 1: MIDI Support: The Musical Instrumental Digital Interface (MIDI) operates at 31.25Kbaud (+/- 1%) which can be derived from 125KHz. (24MHz/12 = 2MHz, 2MHz/16 = 125KHz).

CR5

This register can only be accessed when the FDC is in the Configuration Mode and the

CSR has been initialized to 05H. The default value after power up is 00H.

Table 46 - CR5- Floppy Disk and IDE Extended Setup Register

BIT NO.	BIT NAME	DESCRIPTION		
0	FDC Secondary	A low level on this bit selects the primary address for the FDC interface (Default). A high level on this bit selects the secondary address space.		
1	IDE Secondary	A low level on this bit selects the primary address for the IDE interface (Default). A high level on this bit selects the secondary address space.		
2	FDC DMA Mode	0 = (default) Burst mode is enabled for the FDC FIFO execution phase data transfers. 1 = Non-Burst mode enabled. The FDRQ and FIRQ pins are strobed once for each byte transferred while the FIFO is enabled.		
4,3	DenSel	Bit 4	Bit 3	Densel output
		0	0	Normal (Default)
		0	1	Reserved
		1	0	1
		1	1	0
5	swap drv 0,1	A high level on this bit, swaps drives and motor sel 0 and 1 of the FDC. A low level on this bit does not (Default).		
6	EXTx4	External 4 drive support: 0 = Internal 4 drive decoder (default). 1 = External 4 drive decoder (External 2 to 4 decoder required).		
7	Reserved	Reserved set/read as zero.		

ADDRESS	BLOCK NAME	NOTES
3F0-3F7	Floppy Disk	Primary address
370-377	Floppy Disk	Secondary address
1F0-1F7, 3F6,3F7	IDE	Primary address
170-177, 376,377	IDE	Secondary address

CR6

This register can only be accessed when the FDC is in the Configuration Mode and after the CSR has been initialized to 06H. The default value of this register after power up is FFH. This register holds the floppy disk drive types for up to four floppy disk drives.

CR7

This register can only be accessed when the FDC is in the Configuration Mode and after the CSR has been initialized to 07H. The default value of this register after power up is 00H. This register holds the value for the floppy boot drive and the polarity of the media ID bits.

CR8

This register can only be accessed when the FDC is in the Configuration Mode and after the CSR has been initialized to 08H. The default value of this register after power up is 00H. This is the lower 8 bits for the ADRx address decode. (Note: All addresses are qualified with AEN.)

CR9

This register can only be accessed when the FDC is in the Configuration Mode and after the CSR has been initialized to 09H. The default value of this register after power up is 00H. This is the upper 3 bits (D2 - MSB, D0 - LSB) for the ADRx address decode. (Note: All addresses are qualified with AEN.)

CRA

Reserved - The contents of these registers are undefined when read.

CRB and CRC

Reserved - The contents of these registers are undefined when read.

CRD

This register can only be accessed when the FDC is in the Configuration Mode and after the CSR has been initialized to 0DH. This register is read only. The default value of this register after power up is 063H for the FDC37C663 and a 064H for the FDC37C664.

CRE

This register can only be accessed when the FDC is in the Configuration Mode and after the CSR has been initialized to 0EH. This register is read only. The default value of this register after power up is 01H. This is used to identify the chip revision level.

CRF

This register can only be accessed when the FDC is in the Configuration Mode and after the CSR has been initialized to 0FH. The default value of this register after power up is 00H.

Table 47 - CRF

BIT NO.	BIT NAME	DESCRIPTION
0	Test 0	Reserved - Set to zero.
1	Test 1	Reserved - Set to zero.
2	Test 2	Reserved - Set to zero.
3	Test 3	Reserved - Set to zero.
4	Test 4	Reserved - Set to zero.
5	Test 5	Reserved - Set to zero.
6	Test 6	Reserved - Set to zero.
7	Test 7	Reserved - Set to zero.

FDC37C664 Hardware Configuration

IDE circuits, FDC and IDE addresses, set the parallel port and serial port addresses and move the configuration register addresses.

The FDC37C664 hardware configuration can select or deselect the parallel, serial, FDC and

PCF1	PCF0	PARALLEL PORT ADDRESS
0	0	Disabled
0	1	3BCH
1	0	378H
1	1	278H

ECPEN	PADCF	PARALLEL PORT MODE
0	0	Printer Mode (output only)
0	1	Bidirectional
1	0	Reserved
1	1	Reserved

S1CF1	S1CF0	PRIMARY SERIAL PORT ADDRESS
0	0	Disabled
0	1	COM3 3E8H
1	0	COM2 2F8H
1	1	COM1 3F8H

S2CF1	S2CF0	SECONDARY SERIAL PORT ADDRESS
0	0	Disabled
0	1	COM4 2E8H
1	0	COM1 3F8H
1	1	COM2 2F8H

IDECF	IDEACF	IDE CONTROL
0	0	Disabled
0	1	Reserved
1	0	Primary
1	1	Secondary

FDCCF	FACF	FDC CONTROL
0	0	Floppy Disabled, Configuration registers at 3F0H and 3F1H and allow override of FDC enable/disable and primary/secondary address in config registers. DRATEx power-up as inputs, allow selection of Enhanced Floppy Mode 2.
0	1	Floppy Disabled, Configuration registers at 370H and 371H and allow override of FDC enable/disable and primary/secondary address in config registers. DRATEx power-up as inputs, allow selection of Enhanced Floppy Mode 2.
1	0	FDC at Primary Address (DRATE0,1 are outputs, Enhanced Floppy Mode 2 not available)
1	1	FDC at Secondary Address (DRATE0,1 are outputs, Enhanced Floppy Mode 2 not available)

FDC37C664 Software Configuration - Differences from FDC37C663

All software configuration options available for the FDC37C663 are available for the FDC37C664 except for those options selected by the hardware configuration pins. The options set by hardware configuration in the FDC37C664 that cannot be changed by software are:

Parallel Port Address (set by PCF1, PCF0)

Parallel Port Mode (Set by PADCF)

Serial Port Address (Set by S1CF1, S1CF0, S2CF1, S2CF0)

IDE Control (Set by IDECF, IDEACF)

FDC Control (if FDCCF=1, Set by FACF, If FDCCF=0 can be changed in software configuration)

The location of the configuration select registers (CSR) can be moved to 370H and the configuration registers 0-F can be accessed at port 371H by setting FDCCF=0 and FACF=1.

To enter the configuration mode of the FDC37C664, two writes in succession to the CSR (port 3F0H or 370H see FDCCF and FACF) with 44H data are required. If a write to another address or port occurs between these two writes, the chip does not enter the

configuration mode. It is strongly recommended that interrupts be disabled for the duration of these two writes. The configuration mode is exited by writing an AAH to the CSR.

In the FDC37C664, the pins used to configure the part should be connected as per the diagram below. This shows how a jumper can be used to set a high (VCC) or a low (GND) into the port for configuration at the end of the reset pulse.

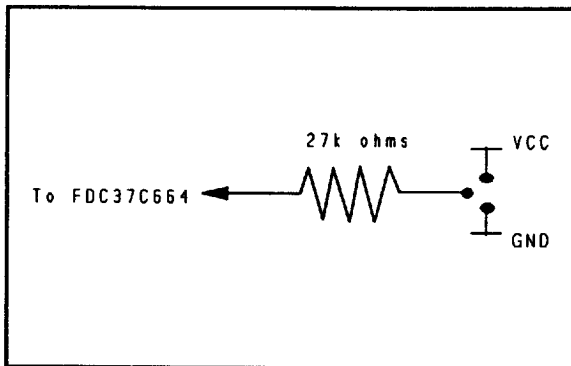

OPERATIONAL DESCRIPTION

MAXIMUM GUARANTEED RATINGS*

Operating Temperature Range	0°C to +70°C
Storage Temperature Range	-55° to +150°C
Lead Temperature Range (soldering, 10 seconds)	+325°C
Positive Voltage on any pin, with respect to Ground	$V_{cc} + 0.3V$
Negative Voltage on any pin, with respect to Ground	-0.3V
Maximum V_{cc}	+7V

*Stresses above those listed above could cause permanent damage to the device. This is a stress rating only and functional operation of the device at any other condition above those indicated in the operation sections of this specification is not implied.

Note: When powering this device from laboratory or system power supplies, it is important that the Absolute Maximum Ratings not be exceeded or device failure can result. Some power supplies exhibit voltage spikes on their outputs when the AC power is switched on or off. In addition, voltage transients on the AC power line may appear on the DC output. If this possibility exists, it is suggested that a clamp circuit be used.

DC ELECTRICAL CHARACTERISTICS ($T_A = 0^\circ C - 70^\circ C$, $V_{cc} = +5.0 V \pm 10\%$)

PARAMETER	SYMBOL	MIN	TYP	MAX	UNITS	COMMENTS
I Type Input Buffer						
Low Input Level	V_{ILI}			0.8	V	TTL Levels
High Input Level	V_{IHI}	2.0			V	
IS Type Input Buffer						
Low Input Level	V_{ILIS}			0.8	V	Schmitt Trigger
High Input Level	V_{IHIS}	2.2			V	Schmitt Trigger
Schmitt Trigger Hysteresis	V_{HYS}		250		mV	
I_{CLK} Input Buffer						
Low Input Level	V_{ILCK}			0.4	V	
High Input Level	V_{HCK}	3.0			V	
Input Leakage (All I and IS buffers except PWRGD)						
Low Input Leakage	I_{IL}	-10		+10	μA	$V_{IN} = 0$
High Input Leakage	I_{IH}	-10		+10	μA	$V_{IN} = V_{CC}$

PARAMETER	SYMBOL	MIN	TYP	MAX	UNITS	COMMENTS
Input Current PWRGD	I_{IL}		-75	-150	μA	$V_{IN} = 0$
I/O24 Type Buffer Low Output Level High Output Level Output Leakage	V_{OL} V_{OH} I_{OL}		2.4	0.5 +10	V V μA	$I_{OL} = 24\text{ mA}$ $I_{OH} = -12\text{ mA}$ $V_{IN} = 0\text{ to }V_{CC}$ (Note 1)
I/OP24 Type Buffer Low Output Level High Output Level Output Leakage	V_{OL} V_{OH} I_{OL}		2.4	0.5 +10	V V μA	$I_{OL} = 24\text{ mA}$ $I_{OH} = 4\text{ mA}$ $V_{IN} = 0\text{ to }V_{CC}$ (Note 1)
O24 Type Buffer Low Output Level High Output Level Output Leakage	V_{OL} V_{OH} I_{OL}		2.4	0.5 +10	V V μA	$I_{OL} = 24\text{ mA}$ $I_{OH} = -12\text{ mA}$ $V_{IN} = 0\text{ to }V_{CC}$ (Note 1)
OD48 Type Buffer Low Output Level Output Leakage	V_{OL} I_{OH}		-10	0.5 +10	V μA	$I_{OL} = 48\text{ mA}$ $V_{OH} = 0\text{ to }V_{CC}$ (Note 2)
O4 Type Buffer Low Output Level High Output Level Output Leakage	V_{OL} V_{OH} I_{OL}		2.4	0.4 +10	V V μA	$I_{OL} = 4\text{ mA}$ $I_{OH} = -1\text{ mA}$ $V_{IN} = 0\text{ to }V_{CC}$ (Note 1)
O8 Type Buffer Low Output Level High Output Level Output Leakage	V_{OL} V_{OH} I_{OL}		2.4	0.4 +10	V V μA	$I_{OL} = 8\text{ mA}$ $I_{OH} = -4\text{ mA}$ $V_{IN} = 0\text{ to }V_{CC}$ (Note 1)

PARAMETER	SYMBOL	MIN	TYP	MAX	UNITS	COMMENTS
OD24 Type Buffer						Note 3
Low Output Level	V_{OL}			0.5	V	$I_{OL} = 24 \text{ mA}$
Output Leakage	I_{OL}	-10		+10	μA	$V_{IN} = 0 \text{ to } V_{CC}$ (Note 1)
Supply Current Active	I_{CC}		35	50	mA	All outputs open.
Supply Current Standby	I_{CBY}		300	500	μA	Note 4
ChiProtect (SLCT, PE, BUSY, ACK, ERROR)	I_{IL}			± 10	μA	Chip in circuit: $V_{CC} = 0\text{V}$ $V_{IN} = 6\text{V Max.}$

Note 1: All output leakages are measured with the current pins in high impedance as defined by the PWRGD pin (FDC37C663 only).

Note 2: Output leakage is measured with the low driving output off, either for a high level output or a high impedance state defined by PWRGD (FDC37C663 only).

Note 3: The IOCHRDY signal has an internal pullup of $-30\mu\text{A}$ typical.

Note 4: Defined by the device configuration with the PWRGD input low.

CAPACITANCE $T_A = 25^\circ\text{C}$; $f_c = 1\text{MHz}$; $V_{CC} = 5\text{V}$

PARAMETER	SYMBOL	LIMITS			UNIT	TEST CONDITION
		MIN	TYP	MAX		
Clock Input Capacitance	C_{IN}			20	pF	All pins except pin under test tied to AC ground
Input Capacitance	C_{IN}			10	pF	
Output Capacitance	C_{OUT}			20	pF	

TIMING DIAGRAMS

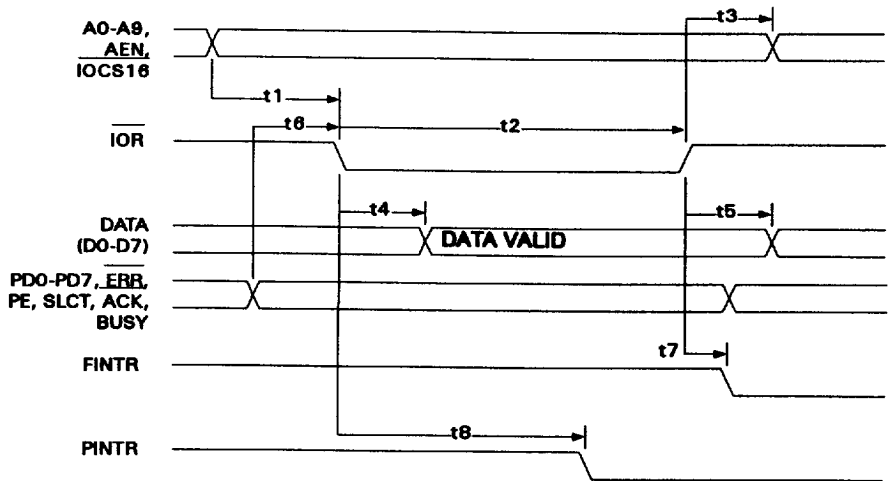

	Parameter	min	typ	max	units
t1	A0-A9, AEN, IOCS16 Set Up to IOR Low	40			ns
t2	IOR Width	150			ns
t3	A0-A9, AEN, IOCS16 Hold from IOR High	10			ns
t4	Data Access Time from IOR Low			100	ns
t5	Data to Float Delay from IOR High	10		60	ns
t6	Port Setup		20		ns
t7	Read Strobe to Clear FINTR		40	55	ns
t8	IOR Active to PINTR Inactive			260	ns

FIGURE 4 - MICROPROCESSOR READ TIMING

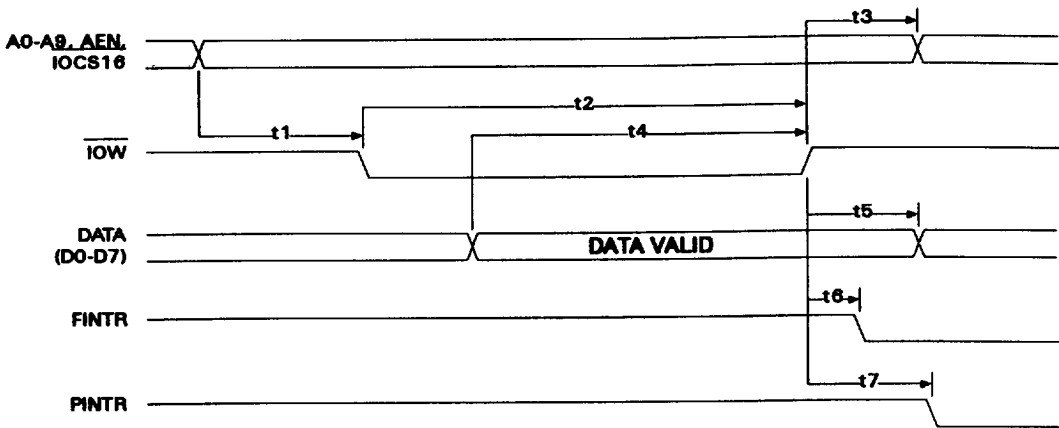

	Parameter	min	typ	max	units
t1	A0-A9, AEN, IOCS16 Set Up to IOW Low	40			ns
t2	IOW Width	150			ns
t3	A0-A9, AEN, IOCS16 Hold from IOW High	10			ns
t4	Data Set Up Time to IOW High	40			ns
t5	Data Hold Time from IOW High	10			ns
t6	Write Strobe to Clear FINTR		40	55	ns
t7	IOW Inactive to PINTR Inactive			260	ns

FIGURE 5 - MICROPROCESSOR WRITE TIMING

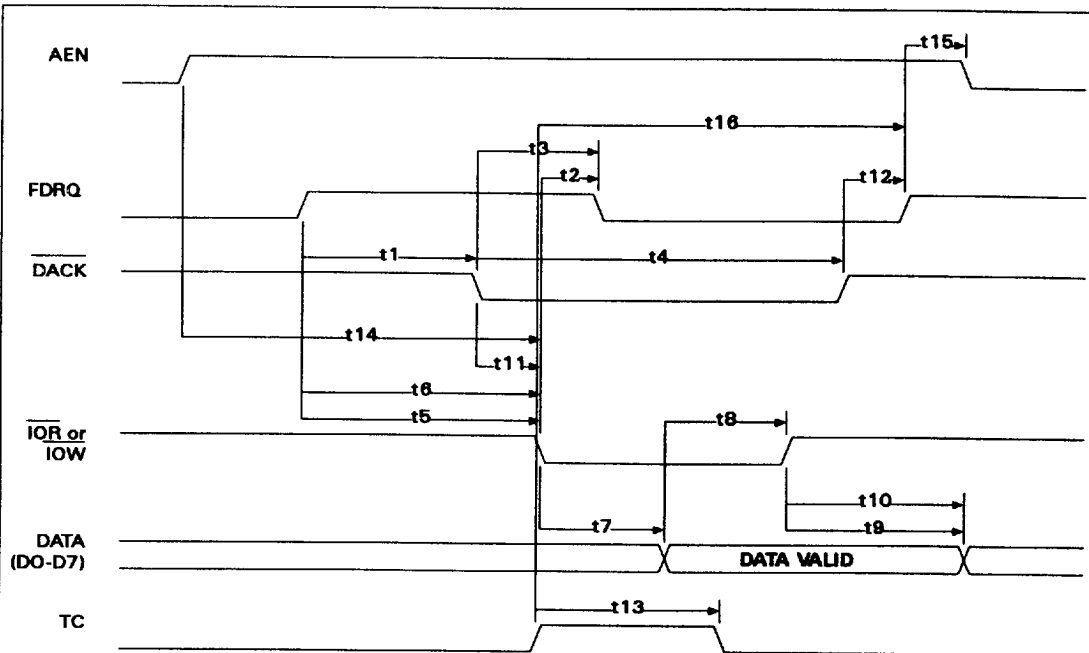

	Parameter	min	typ	max	units
t1	DACK Delay Time from <u>FDRQ High</u>	0			ns
t2	DRQ Reset Delay from <u>IOR or IOW</u>			100	ns
t3	FDRQ Reset Delay from <u>DACK Low</u>			100	ns
t4	DACK Width	150			ns
t5	IOR Delay from <u>FDRQ High</u>	0			ns
t6	IOW Delay from <u>FDRQ High</u>	0			ns
t7	Data Access Time from <u>IOR Low</u>			100	ns
t8	Data Set Up Time to <u>IOW High</u>	40			ns
t9	Data to Float Delay from <u>IOR High</u>	10		60	ns
t10	Data Hold Time from <u>IOW High</u>	10			ns
t11	DACK Set Up to <u>IOR/IOW Low</u>	5			ns
t12	DACK Hold After <u>IOR/IOW High</u>	10			ns
t13	TC Pulse Width	60			ns
t14	AEN Set Up to <u>IOR/IOW</u>	40			ns
t15	AEN Hold from <u>DACK</u>	10			ns
t16	TC Active to <u>PDRQ Inactive</u>			100	ns

FIGURE 6 - DMA TIMING

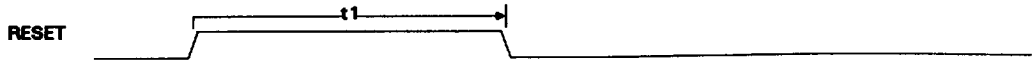

	Parameter	min	typ	max	units
t1	RESET Width	500			ns

FIGURE 7 - RESET TIMING

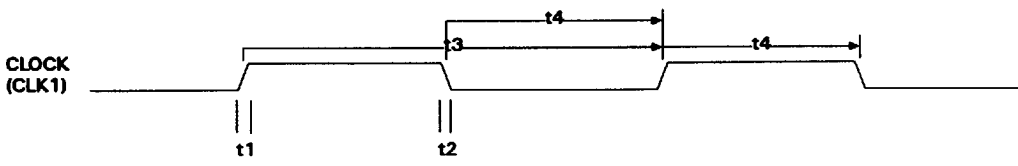

	Parameter	min	typ	max	units
t1	Clock Rise Time (VIN = 0.4 to 3.0)			5	ns
t2	Clock Fall Time (VIN = 3.0 to 0.4)			5	ns
t3	Clock Period	40	41.67		ns
t4	Clock Active (High or Low)	14			ns

FIGURE 8 - CLOCK TIMING

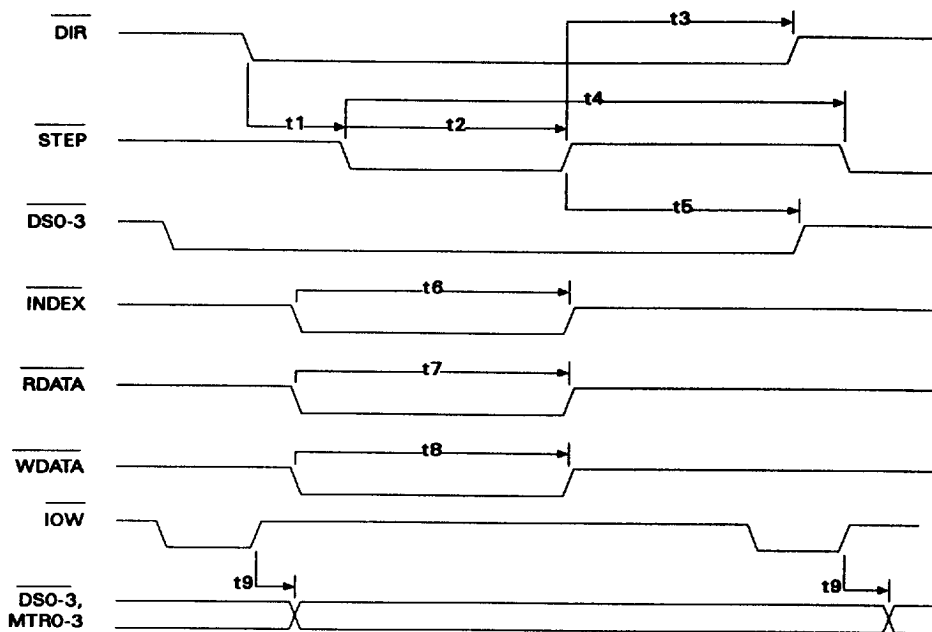

(AT Mode timing only)

	Parameter	min	typ	max	units
t1	DIR Set Up to STEP Low		4		X*
t2	STEP Active Time Low		24		X*
t3	DIR Hold Time After STEP		96		X*
t4	STEP Cycle Time		132		X*
t5	DS0-3 Hold Time from STEP Low		20		X*
t6	INDEX Pulse Width		2		X*
t7	RDATA Active Time Low		40		ns
t8	WDATA Write Data Width Low		.5		Y*
t9	DS0-3, MTR0-3 from End of IOW		25		ns

*X specifies one MCLK period and Y specifies one WCLK period.

MCLK = Controller Clock to FDC (See Table 6).

WCLK = 2 x Data Rate (See Table 6).

FIGURE 9 - DISK DRIVE TIMING

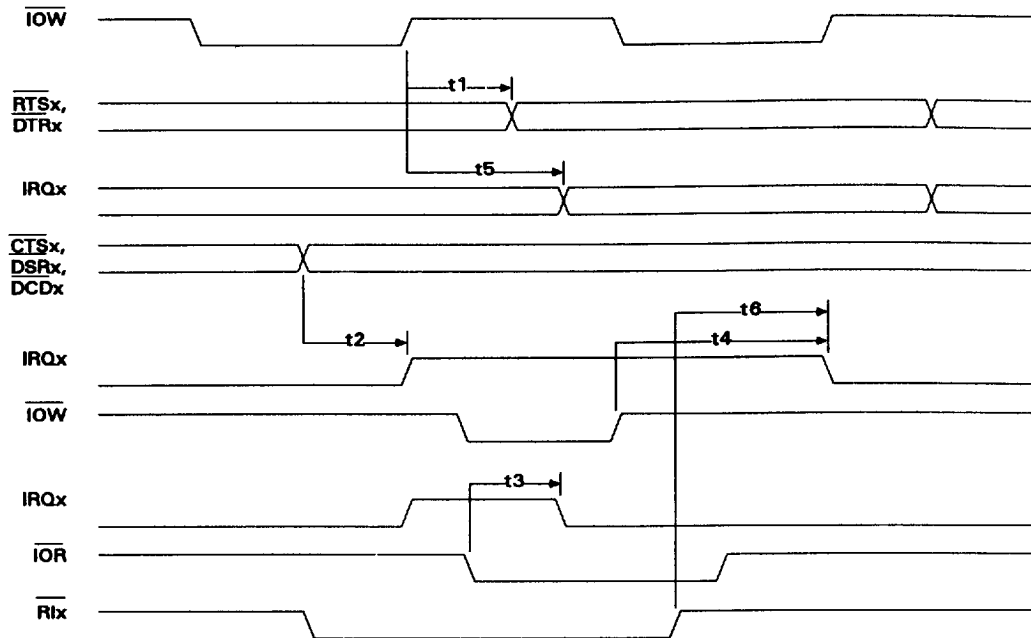

	Parameter	min	typ	max	units
t1	\overline{RTSx} , \overline{DTRx} Delay from \overline{IOW}			200	ns
t2	\overline{IRQx} Active Delay from \overline{CTSx} , \overline{DSRx} , \overline{DCDx}			100	ns
t3	\overline{IRQx} Inactive Delay from \overline{IOR} (Leading Edge)			120	ns
t4	\overline{IRQx} Inactive Delay from \overline{IOW} (Trailing Edge)			125	ns
t5	\overline{IRQx} Inactive Delay from \overline{IOW}	10		100	ns
t6	\overline{IRQx} Active Delay from \overline{Rtx}			100	ns

FIGURE 10 - SERIAL PORT TIMING

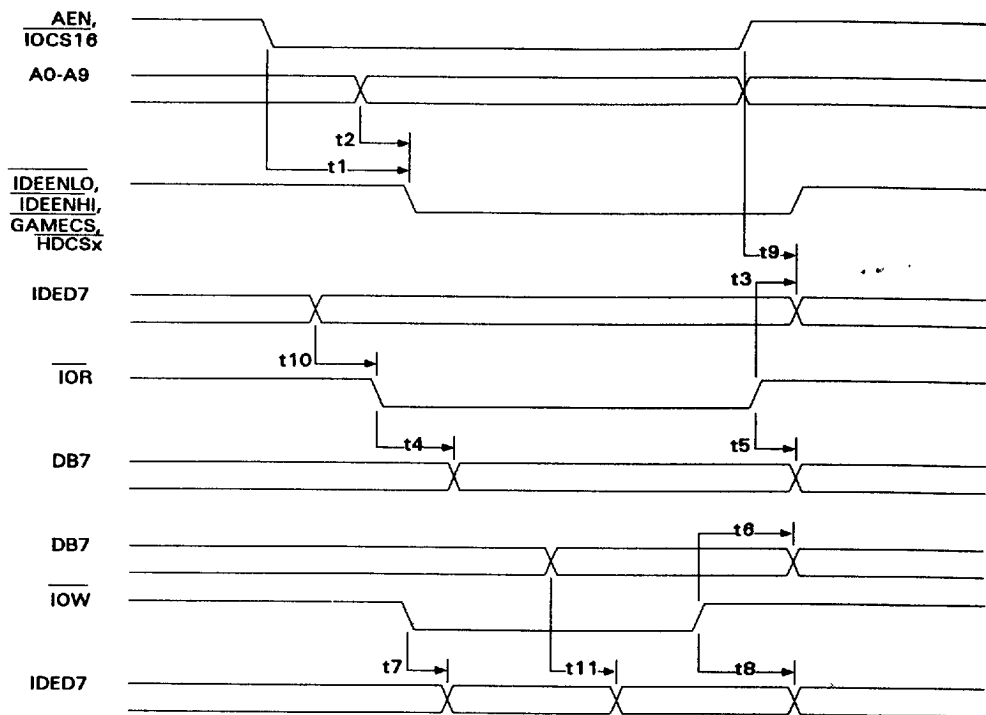

	Parameter	min	typ	max	units
t1	IDEENLO, IDEENHI, GAMECS, HDCSx Delay from AEN, IOCS16			40	ns
t2	IDEENLO, IDEENHI, GAMECS, HDCSx Delay from A0-A9			40	ns
t3	IDED7 Hold Time after IOR	10			ns
t4	DB7 Delay from IOR			60	ns
t5	DB7 Hold Time from IOR	10		60	ns
t6	DB7 Hold Time from IOW	10			ns
t7	IDED7 Delay from Data Bus IOW Active			50	ns
t8	IDED7 Inactive Delay from IOW	10		50	ns
t9	IDEENLO Delay from IDEENHI, IOCS16, AEN			40	ns
t10	IDED7 Set Up Time before IOR	40			ns
t11	IDED7 Delay from DB7, IDED7 in Output Mode			25	ns

FIGURE 11 - IDE INTERFACE TIMING

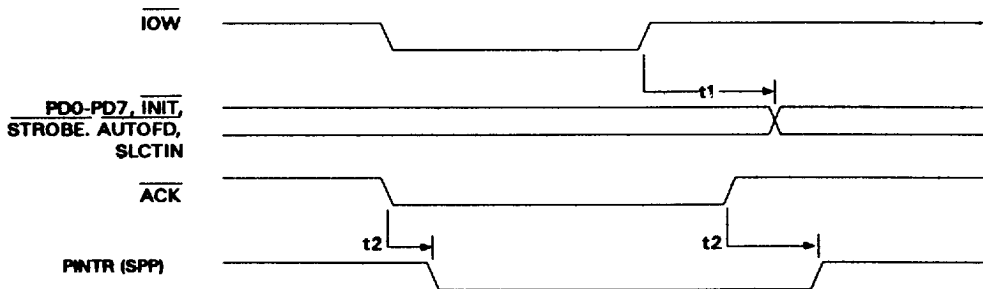

	Parameter	min	typ	max	units
t1	PD0-7, INIT, STROBE, AUTOFD Delay from IOW			100	ns
t2	PINTR Delay from ACK			60	ns

FIGURE 12 - PARALLEL PORT TIMING

