

# Intel<sup>®</sup> 3200 and 3210 Chipset

Datasheet

---

— For the Intel<sup>®</sup> 3200 and 3210 Chipset Memory Controller Hub (MCH)

November 2007

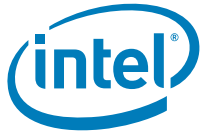

INFORMATION IN THIS DOCUMENT IS PROVIDED IN CONNECTION WITH INTEL® PRODUCTS. NO LICENSE, EXPRESS OR IMPLIED, BY ESTOPPEL OR OTHERWISE, TO ANY INTELLECTUAL PROPERTY RIGHTS IS GRANTED BY THIS DOCUMENT. EXCEPT AS PROVIDED IN INTEL'S TERMS AND CONDITIONS OF SALE FOR SUCH PRODUCTS, INTEL ASSUMES NO LIABILITY WHATSOEVER, AND INTEL DISCLAIMS ANY EXPRESS OR IMPLIED WARRANTY, RELATING TO SALE AND/OR USE OF INTEL PRODUCTS INCLUDING LIABILITY OR WARRANTIES RELATING TO FITNESS FOR A PARTICULAR PURPOSE, MERCHANTABILITY, OR INFRINGEMENT OF ANY PATENT, COPYRIGHT OR OTHER INTELLECTUAL PROPERTY RIGHT. Intel products are not intended for use in medical, life saving, life sustaining, critical control or safety systems, or in nuclear facility applications.

Intel may make changes to specifications and product descriptions at any time, without notice.

Designers must not rely on the absence or characteristics of any features or instructions marked "reserved" or "undefined." Intel reserves these for future definition and shall have no responsibility whatsoever for conflicts or incompatibilities arising from future changes to them.

The Intel® 3200/3210 Memory Controller Hub (MCH) may contain design defects or errors known as errata, which may cause the product to deviate from published specifications. Current characterized errata are available on request.

Contact your local Intel sales office or your distributor to obtain the latest specifications and before placing your product order.

I<sup>2</sup>C is a two-wire communications bus/protocol developed by Philips. SMBus is a subset of the I<sup>2</sup>C bus/protocol and was developed by Intel. Implementations of the I<sup>2</sup>C bus/protocol may require licenses from various entities, including Philips Electronics N.V. and North American Philips Corporation.

No computer system can provide absolute security under all conditions. Intel® Trusted Execution Technology (Intel® TXT) is a security technology under development by Intel and requires for operation a computer system with Intel® Virtualization Technology, a Intel® Trusted Execution Technology-enabled Intel processor, chipset, BIOS, Authenticated Code Modules, and an Intel or other Intel® Trusted Execution Technology compatible measured virtual machine monitor. In addition, Intel® Trusted Execution Technology requires the system to contain a TPMv1.2 as defined by the Trusted Computing Group and specific software for some uses.

Intel, Pentium, Xeon, and the Intel logo are trademarks or registered trademarks of Intel Corporation or its subsidiaries in the United States and other countries.

\*Other names and brands may be claimed as the property of others.

Copyright © 2007, Intel Corporation



# Contents

<b>1</b>	<b>Introduction</b>	15
1.1	Terminology	17
1.2	MCH Overview	20
1.2.1	Host Interface	20
1.2.2	System Memory Interface	20
1.2.3	Direct Media Interface (DMI)	21
1.2.4	PCI Express* Interface	22
1.2.5	MCH Clocking	23
1.2.6	Power Management	23
1.2.7	Thermal Sensor	23
<b>2</b>	<b>Signal Description</b>	25
2.1	Host Interface Signals	26
2.2	System Memory (DDR2) Interface Signals	29
2.2.1	System Memory Channel A Interface Signals	29
2.2.2	System Memory Channel B Interface Signals	30
2.2.3	System Memory Miscellaneous Signals	31
2.3	PCI Express* Interface Signals	31
2.4	Controller Link Interface Signals	32
2.5	Clocks, Reset, and Miscellaneous	32
2.6	Direct Media Interface	33
2.7	Power and Grounds	34
<b>3</b>	<b>System Address Map</b>	35
3.1	Legacy Address Range	38
3.1.1	DOS Range (0h – 9_FFFFh)	38
3.1.2	Expansion Area (C_0000h–D_FFFFh)	39
3.1.3	Extended System BIOS Area (E_0000h–E_FFFFh)	39
3.1.4	System BIOS Area (F_0000h–F_FFFFh)	40
3.1.5	PAM Memory Area Details	40
3.2	Main Memory Address Range (1MB – TOLUD)	40
3.2.1	ISA Hole (15 MB –16 MB)	41
3.2.2	TSEG	42
3.2.3	Pre-allocated Memory	42
3.3	PCI Memory Address Range (TOLUD – 4 GB)	43
3.3.1	APIC Configuration Space (FEC0_0000h–FECF_FFFFh)	45
3.3.2	HSEG (FEDA_0000h–FEDB_FFFFh)	45
3.3.3	FSB Interrupt Memory Space (FEE0_0000–FEEF_FFFF)	45
3.3.4	High BIOS Area	45
3.4	Main Memory Address Space (4 GB to TOUUD)	46
3.4.1	Memory Re-claim Background	47
3.4.2	Memory Reclaiming	47
3.5	PCI Express* Configuration Address Space	47
3.6	PCI Express* Address Space	48
3.7	System Management Mode (SMM)	49
3.7.1	SMM Space Definition	49
3.7.2	SMM Space Restrictions	50
3.7.3	SMM Space Combinations	50
3.7.4	SMM Control Combinations	51
3.7.5	SMM Space Decode and Transaction Handling	51
3.7.6	Processor WB Transaction to an Enabled SMM Address Space	51



3.7.7	SMM Access Through TLB.....	51
3.8	Memory Shadowing.....	52
3.9	I/O Address Space.....	52
3.9.1	PCI Express* I/O Address Mapping.....	53
<b>4</b>	<b>MCH Register Description.....</b>	<b>55</b>
4.1	Register Terminology.....	56
4.2	Configuration Process and Registers.....	57
4.2.1	Platform Configuration Structure.....	57
4.3	Configuration Mechanisms.....	58
4.3.1	Standard PCI Configuration Mechanism.....	58
4.3.2	PCI Express Enhanced Configuration Mechanism.....	59
4.4	Routing Configuration Accesses.....	60
4.4.1	Internal Device Configuration Accesses.....	61
4.4.2	Bridge Related Configuration Accesses.....	62
4.4.2.1	PCI Express Configuration Accesses.....	62
4.4.2.2	DMI Configuration Accesses.....	62
4.5	I/O Mapped Registers.....	63
4.5.1	CONFIG_ADDRESS—Configuration Address Register.....	63
4.5.2	CONFIG_DATA—Configuration Data Register.....	64
<b>5</b>	<b>DRAM Controller Registers (D0:F0).....</b>	<b>65</b>
5.1	Configuration Register Details.....	67
5.1.1	VID—Vendor Identification.....	67
5.1.2	DID—Device Identification.....	67
5.1.3	PCICMD—PCI Command.....	68
5.1.4	PCISTS—PCI Status.....	69
5.1.5	RID—Revision Identification.....	70
5.1.6	CC—Class Code.....	70
5.1.7	MLT—Master Latency Timer.....	70
5.1.8	HDR—Header Type.....	71
5.1.9	SVID—Subsystem Vendor Identification.....	71
5.1.10	SID—Subsystem Identification.....	71
5.1.11	CAPPTR—Capabilities Pointer.....	72
5.1.12	PXPEPBAR—PCI Express* Egress Port Base Address.....	72
5.1.13	MCHBAR—MCH Memory Mapped Register Range Base.....	73
5.1.14	DEVEN—Device Enable.....	74
5.1.15	PCIEXBAR—PCI Express* Register Range Base Address.....	75
5.1.16	DMIBAR—Root Complex Register Range Base Address.....	77
5.1.17	PAM0—Programmable Attribute Map 0.....	78
5.1.18	PAM1—Programmable Attribute Map 1.....	79
5.1.19	PAM2—Programmable Attribute Map 2.....	80
5.1.20	PAM3—Programmable Attribute Map 3.....	81
5.1.21	PAM4—Programmable Attribute Map 4.....	82
5.1.22	PAM5—Programmable Attribute Map 5.....	83
5.1.23	PAM6—Programmable Attribute Map 6.....	84
5.1.24	LAC—Legacy Access Control.....	84
5.1.25	REMAPBASE—Remap Base Address Register.....	85
5.1.26	REMAPLIMIT—Remap Limit Address Register.....	85
5.1.27	SMRAM—System Management RAM Control.....	86
5.1.28	ESMRAMC—Extended System Management RAM Control.....	87
5.1.29	TOM—Top of Memory.....	88
5.1.30	TOUUD—Top of Upper Usable Dram.....	88
5.1.31	BSM—Base of Stolen Memory.....	89
5.1.32	TSEGMB—TSEG Memory Base.....	89
5.1.33	TOLUD—Top of Low Usable DRAM.....	90

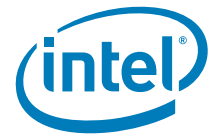

5.1.34	ERRSTS—Error Status	91
5.1.35	ERRCMD—Error Command	93
5.1.36	SMICMD—SMI Command	94
5.1.37	SKPD—Scratchpad Data	94
5.1.38	CAPID0—Capability Identifier	95
5.2	MCHBAR	98
5.2.1	CHDECMISC—Channel Decode Misc	100
5.2.2	C0DRB0—Channel 0 DRAM Rank Boundary Address 0	101
5.2.3	C0DRB1—Channel 0 DRAM Rank Boundary Address 1	102
5.2.4	C0DRB2—Channel 0 DRAM Rank Boundary Address 2	103
5.2.5	C0DRB3—Channel 0 DRAM Rank Boundary Address 3	103
5.2.6	C0DRA01—Channel 0 DRAM Rank 0,1 Attribute	104
5.2.7	C0DRA23—Channel 0 DRAM Rank 2,3 Attribute	105
5.2.8	C0CYCTRPCHG—Channel 0 CYCTRK PCHG	105
5.2.9	C0CYCTRKACT—Channel 0 CYCTRK ACT	106
5.2.10	C0CYCTRKWR—Channel 0 CYCTRK WR	107
5.2.11	C0CYCTRKRDR—Channel 0 CYCTRK READ	108
5.2.12	C0CYCTRKREFR—Channel 0 CYCTRK REFR	108
5.2.13	C0CKECTRL—Channel 0 CKE Control	109
5.2.14	C0REFRCTRL—Channel 0 DRAM Refresh Control	110
5.2.15	C0ECCERRLOG—Channel 0 ECC Error Log	112
5.2.16	C0ODTCTRL—Channel 0 ODT Control	113
5.2.17	C1DRB0—Channel 1 DRAM Rank Boundary Address 0	113
5.2.18	C1DRB1—Channel 1 DRAM Rank Boundary Address 1	114
5.2.19	C1DRB2—Channel 1 DRAM Rank Boundary Address 2	114
5.2.20	C1DRB3—Channel 1 DRAM Rank Boundary Address 3	115
5.2.21	C1DRA01—Channel 1 DRAM Rank 0,1 Attributes	115
5.2.22	C1DRA23—Channel 1 DRAM Rank 2,3 Attributes	115
5.2.23	C1CYCTRPCHG—Channel 1 CYCTRK PCHG	116
5.2.24	C1CYCTRKACT—Channel 1 CYCTRK ACT	117
5.2.25	C1CYCTRKWR—Channel 1 CYCTRK WR	118
5.2.26	C1CYCTRKRDR—Channel 1 CYCTRK READ	118
5.2.27	C1CKECTRL—Channel 1 CKE Control	119
5.2.28	C1REFRCTRL—Channel 1 DRAM Refresh Control	120
5.2.29	C1ECCERRLOG—Channel 1 ECC Error Log	121
5.2.30	C1ODTCTRL—Channel 1 ODT Control	122
5.2.31	EPC0DRB0—EP Channel 0 DRAM Rank Boundary Address 0	123
5.2.32	EPC0DRB1—EP Channel 0 DRAM Rank Boundary Address 1	123
5.2.33	EPC0DRB2—EP Channel 0 DRAM Rank Boundary Address 2	123
5.2.34	EPC0DRB3—EP Channel 0 DRAM Rank Boundary Address 3	124
5.2.35	EPC0DRA01—EP Channel 0 DRAM Rank 0,1 Attribute	124
5.2.36	EPC0DRA23—EP Channel 0 DRAM Rank 2,3 Attribute	125
5.2.37	EPDCYCTRKWRTPRE—EPD CYCTRK WRT PRE	125
5.2.38	EPDCYCTRKWRTACT—EPD CYCTRK WRT ACT	126
5.2.39	EPDCYCTRKWRTWR—EPD CYCTRK WRT WR	126
5.2.40	EPDCYCTRKWRTREF—EPD CYCTRK WRT REF	127
5.2.41	EPDCYCTRKWRTRD—EPD CYCTRK WRT READ	127
5.2.42	EPDCKECONFIGREG—EPD CKE Related Configuration	128
5.2.43	EPDREFCONFIG—EP DRAM Refresh Configuration	129
5.2.44	TSC1—Thermal Sensor Control 1	131
5.2.45	TSC2—Thermal Sensor Control 2	132
5.2.46	TSS—Thermal Sensor Status	134
5.2.47	TSTTP—Thermal Sensor Temperature Trip Point	135
5.2.48	TCO—Thermal Calibration Offset	136
5.2.49	THERM1—Thermal Hardware Protection	137



5.2.50	TIS—Thermal Interrupt Status	137
5.2.51	TSMICMD—Thermal SMI Command	139
5.2.52	PMSTS—Power Management Status	140
5.3	EPBAR	141
5.3.1	EPESD—EP Element Self Description	141
5.3.2	EPLE1D—EP Link Entry 1 Description	142
5.3.3	EPLE1A—EP Link Entry 1 Address	142
5.3.4	EPLE2D—EP Link Entry 2 Description	143
5.3.5	EPLE2A—EP Link Entry 2 Address	143
5.3.6	EPLE3D—EP Link Entry 3 Description	144
5.3.7	EPLE3A—EP Link Entry 3 Address	145
<b>6</b>	<b>Host-Primary PCI Express* Bridge Registers (D1:F0)</b>	<b>147</b>
6.1	VID1—Vendor Identification	149
6.2	DID1—Device Identification	150
6.3	PCICMD1—PCI Command	150
6.4	PCISTS1—PCI Status	152
6.5	RID1—Revision Identification	153
6.6	CC1—Class Code	153
6.7	CL1—Cache Line Size	154
6.8	HDR1—Header Type	154
6.9	PBUSN1—Primary Bus Number	154
6.10	SBUSN1—Secondary Bus Number	155
6.11	SUBUSN1—Subordinate Bus Number	155
6.12	IOBASE1—I/O Base Address	156
6.13	IOLIMIT1—I/O Limit Address	156
6.14	SSTS1—Secondary Status	157
6.15	MBASE1—Memory Base Address	158
6.16	MLIMIT1—Memory Limit Address	159
6.17	PMBASE1—Prefetchable Memory Base Address	160
6.18	PMLIMIT1—Prefetchable Memory Limit Address	161
6.19	PMBASEU1—Prefetchable Memory Base Address Upper	162
6.20	PMLIMITU1—Prefetchable Memory Limit Address Upper	163
6.21	CAPPTR1—Capabilities Pointer	163
6.22	INTRLINE1—Interrupt Line	164
6.23	INTRPIN1—Interrupt Pin	164
6.24	BCTRL1—Bridge Control	164
6.25	PM_CAPID1—Power Management Capabilities	166
6.26	PM_CS1—Power Management Control/Status	167
6.27	SS_CAPID—Subsystem ID and Vendor ID Capabilities	168
6.28	SS—Subsystem ID and Subsystem Vendor ID	168
6.29	MSI_CAPID—Message Signaled Interrupts Capability ID	169
6.30	MC—Message Control	169
6.31	MA—Message Address	170
6.32	MD—Message Data	170
6.33	PE_CAPL—PCI Express* Capability List	170
6.34	PE_CAP—PCI Express* Capabilities	171
6.35	DCAP—Device Capabilities	171
6.36	DCTL—Device Control	172
6.37	DSTS—Device Status	173
6.38	LCAP—Link Capabilities	174
6.39	LCTL—Link Control	176
6.40	LSTS—Link Status	178
6.41	SLOTCAP—Slot Capabilities	179
6.42	SLOTCTL—Slot Control	180

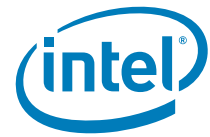

6.43	SLOTSTS—Slot Status	182
6.44	RCTL—Root Control	183
6.45	RSTS—Root Status	184
6.46	PELC—PCI Express Legacy Control	184
6.47	VCECH—Virtual Channel Enhanced Capability Header	185
6.48	PVCCAP1—Port VC Capability Register 1	185
6.49	PVCCAP2—Port VC Capability Register 2	186
6.50	PVCCTL—Port VC Control	186
6.51	VCORCAP—VC0 Resource Capability	187
6.52	VCORCTL—VC0 Resource Control	188
6.53	VCORSTS—VC0 Resource Status	189
6.54	RCLDECH—Root Complex Link Declaration Enhanced	189
6.55	ESD—Element Self Description	190
6.56	LE1D—Link Entry 1 Description	190
6.57	LE1A—Link Entry 1 Address	191
6.58	PESSTS—PCI Express* Sequence Status	191
<b>7</b>	<b>Intel Manageability Engine Subsystem PCI (D3:F0,F3)</b>	<b>193</b>
7.1	HECI Function in ME Subsystem (D3:F0)	193
7.1.1	ID—Identifiers	194
7.1.2	CMD—Command	194
7.1.3	STS—Device Status	195
7.1.4	RID—Revision ID	195
7.1.5	CC—Class Code	195
7.1.6	CLS—Cache Line Size	196
7.1.7	MLT—Master Latency Timer	196
7.1.8	HTYPE—Header Type	196
7.1.9	HECI_MBAR—HECI MMIO Base Address	197
7.1.10	SS—Sub System Identifiers	197
7.1.11	CAP—Capabilities Pointer	198
7.1.12	INTR—Interrupt Information	198
7.1.13	MGNT—Minimum Grant	198
7.1.14	MLAT—Maximum Latency	199
7.1.15	HFS—Host Firmware Status	199
7.1.16	PID—PCI Power Management Capability ID	199
7.1.17	PC—PCI Power Management Capabilities	200
7.1.18	PMCS—PCI Power Management Control And Status	200
7.1.19	MID—Message Signaled Interrupt Identifiers	201
7.1.20	MC—Message Signaled Interrupt Control	201
7.1.21	MA—Message Signaled Interrupt Message Address	202
7.1.22	MUA—Message Signaled Interrupt Upper Address (Optional)	202
7.1.23	MD—Message Signaled Interrupt Message Data	202
7.1.24	HIDM—HECI Interrupt Delivery Mode	203
7.2	KT IO/ Memory Mapped Device Specific Registers [D3:F3]	204
7.2.1	KTRxBR—KT Receive Buffer	204
7.2.2	KTTHR—KT Transmit Holding	205
7.2.3	KTDLLR—KT Divisor Latch LSB	205
7.2.4	KTIER—KT Interrupt Enable	206
7.2.5	KTDLMR—KT Divisor Latch MSB	206
7.2.6	KTIIR—KT Interrupt Identification	207
7.2.7	KTFCR—KT FIFO Control	208
7.2.8	KTLCR—KT Line Control	209
7.2.9	KTMCR—KT Modem Control	210
7.2.10	KTLR—KT Line Status	211
7.2.11	KTMSR—KT Modem Status	212



	7.2.12	KTSCR—KT Scratch	212
<b>8</b>		<b>Host-Secondary PCI Express* Bridge Registers (D6:F0)</b>	
		<b>(Intel® 3210 MCH only)</b>	<b>213</b>
8.1		VID1—Vendor Identification	215
8.2		DID1—Device Identification	216
8.3		PCICMD1—PCI Command	216
8.4		PCISTS1—PCI Status	218
8.5		RID1—Revision Identification	219
8.6		CC1—Class Code	219
8.7		CL1—Cache Line Size	220
8.8		HDR1—Header Type	220
8.9		PBUSN1—Primary Bus Number	220
8.10		SBUSN1—Secondary Bus Number	221
8.11		SUBUSN1—Subordinate Bus Number	221
8.12		IOBASE1—I/O Base Address	222
8.13		IOLIMIT1—I/O Limit Address	222
8.14		SSTS1—Secondary Status	223
8.15		MBASE1—Memory Base Address	224
8.16		MLIMIT1—Memory Limit Address	225
8.17		PMBASE1—Prefetchable Memory Base Address Upper	226
8.18		PMLIMIT1—Prefetchable Memory Limit Address	227
8.19		PMBASEU1—Prefetchable Memory Base Address Upper	228
8.20		PMLIMITU1—Prefetchable Memory Limit Address Upper	229
8.21		CAPPTR1—Capabilities Pointer	230
8.22		INTRLINE1—Interrupt Line	230
8.23		INTRPIN1—Interrupt Pin	230
8.24		BCTRL1—Bridge Control	231
8.25		PM_CAPID1—Power Management Capabilities	232
8.26		PM_CS1—Power Management Control/Status	233
8.27		SS_CAPID—Subsystem ID and Vendor ID Capabilities	234
8.28		SS—Subsystem ID and Subsystem Vendor ID	234
8.29		MSI_CAPID—Message Signaled Interrupts Capability ID	235
8.30		MC—Message Control	235
8.31		MA—Message Address	236
8.32		MD—Message Data	236
8.33		PE_CAPL—PCI Express* Capability List	236
8.34		PE_CAP—PCI Express* Capabilities	237
8.35		DCAP—Device Capabilities	237
8.36		DCTL—Device Control	238
8.37		DSTS—Device Status	239
8.38		LCAP—Link Capabilities	240
8.39		LCTL—Link Control	242
8.40		LSTS—Link Status	244
8.41		SLOTCAP—Slot Capabilities	245
8.42		SLOTCTL—Slot Control	246
8.43		SLOTSTS—Slot Status	248
8.44		RCTL—Root Control	249
8.45		RSTS—Root Status	250
8.46		PELC—PCI Express Legacy Control	250
8.47		VCECH—Virtual Channel Enhanced Capability Header	251
8.48		PVCCAP1—Port VC Capability Register 1	251
8.49		PVCCAP2—Port VC Capability Register 2	252
8.50		PVCCCTL—Port VC Control	252
8.51		VCORCAP—VC0 Resource Capability	253





8.52	VCORCTL—VCO Resource Control	254
8.53	VCORSTS—VCO Resource Status	255
8.54	RCLDECH—Root Complex Link Declaration Enhanced	255
8.55	ESD—Element Self Description	256
8.56	LE1D—Link Entry 1 Description	257
8.57	LE1A—Link Entry 1 Address	257
<b>9</b>	<b>Direct Media Interface (DMI) RCRB</b>	<b>259</b>
9.1	DMIVCECH—DMI Virtual Channel Enhanced Capability	260
9.2	DMIPVCCAP1—DMI Port VC Capability Register 1	260
9.3	DMIPVCCCTL—DMI Port VC Control	261
9.4	DMIVCORCAP—DMI VCO Resource Capability	261
9.5	DMIVCORCTL0—DMI VCO Resource Control	262
9.6	DMIVCORSTS—DMI VCO Resource Status	263
9.7	DMIVC1RCAP—DMI VC1 Resource Capability	263
9.8	DMIVC1RCTL1—DMI VC1 Resource Control	264
9.9	DMIVC1RSTS—DMI VC1 Resource Status	265
9.10	DMILCAP—DMI Link Capabilities	265
9.11	DMILCTL—DMI Link Control	266
9.12	DMILSTS—DMI Link Status	266
<b>10</b>	<b>Functional Description</b>	<b>267</b>
10.1	Host Interface	267
10.1.1	FSB IOQ Depth	267
10.1.2	FSB OoQ Depth	267
10.1.3	FSB GTL+ Termination	267
10.1.4	FSB Dynamic Bus Inversion	267
10.1.5	APIC Cluster Mode Support	268
10.2	System Memory Controller	269
10.2.1	System Memory Organization Modes	269
10.2.1.1	Single Channel Mode	269
10.2.1.2	Dual Channel Modes	269
10.2.2	System Memory Technology Supported	270
10.2.3	Error Checking and Correction	271
10.3	PCI Express*	274
10.3.1	PCI Express* Architecture	274
10.3.1.1	Transaction Layer	274
10.3.1.2	Data Link Layer	274
10.3.1.3	Physical Layer	274
10.4	Thermal Sensor	275
10.4.1	PCI Device 0, Function 0	275
10.4.2	MCHBAR Thermal Sensor Registers	275
10.5	Power Management	276
10.6	Clocking	276
<b>11</b>	<b>Electrical Characteristics</b>	<b>279</b>
11.1	Absolute Minimum and Maximum Ratings	279
11.2	Current Consumption	281
11.3	Signal Groups	282
11.4	Buffer Supply and DC Characteristics	285
11.4.1	I/O Buffer Supply Voltages	285
11.4.2	General DC Characteristics	286
<b>12</b>	<b>Ballout and Package Information</b>	<b>289</b>
12.1	Ballout Information	289
12.2	Package Information	313

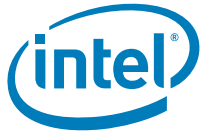

<b>13</b>	<b>Testability</b> .....	315
13.1	XOR Test Mode Initialization.....	315
13.2	XOR Chain Definition.....	316
13.3	XOR Chains.....	317
13.4	XOR Chains.....	318



## Figures

1	Intel® 3210 Chipset System Diagram Example.....	16
2	Intel® 3200 Chipset System Diagram Example.....	17
3	System Address Ranges.....	37
4	DOS Legacy Address Range.....	38
5	Main Memory Address Range.....	41
6	Pre-allocated Memory Example for 64 MB DRAM, 1 MB stolen and 1 MB TSEG.....	42
7	PCI Memory Address Range.....	44
8	Conceptual Platform PCI Configuration Diagram.....	57
9	Memory Map to PCI Express Device Configuration Space.....	60
10	MCH Configuration Cycle Flow Chart.....	61
11	System Clocking Diagram.....	277
12	MCH Ballout Diagram (Top View Left – Columns 45–31).....	290
13	MCH Ballout Diagram (Top View Middle – Columns 30–16).....	291
14	MCH Ballout Diagram (Top View Left – Columns 15–1).....	292
15	MCH Package Drawing.....	313
16	XOR Test Mode Initialization Cycles.....	315

## Tables

1	Intel Specification.....	19
2	Expansion Area Memory Segments.....	39
3	Extended System BIOS Area Memory Segments.....	39
4	System BIOS Area Memory Segments.....	40
5	Transaction Address Ranges – Compatible, High, and TSEG.....	49
6	SMM Space Table.....	50
7	SMM Control Table.....	51
8	DRAM Controller Register Address Map.....	65
9	MCHBAR Register Address Map.....	98
10	DRAM Rank Attribute Register Programming.....	104
11	EPBAR Address Map.....	141
12	Host-PCI Express Bridge Register Address Map (D1:F0).....	147
13	HECI Function in ME Subsystem (D3:F0) Register Address Map.....	193
14	KT IO/Memory Mapped Register Address Map.....	204
15	Host-Secondary PCI Express* Bridge Register Address Map (D6:F0).....	213
16	Direct Media Interface Register Address Map.....	259
17	Host Interface 4X, 2X, and 1X Signal Groups.....	268
18	Sample System Memory Dual Channel Symmetric Organization Mode.....	269
19	Sample System Memory Dual Channel Asymmetric Organization Mode with Intel® Flex Memory Mode Enabled.....	270
20	Sample System Memory Dual Channel Asymmetric Organization Mode with Intel® Flex Memory Mode Disabled.....	270
21	Supported DIMM Module Configurations.....	271
22	Syndrome Bit Values.....	271
23	Absolute Minimum and Maximum Ratings.....	279
24	Current Consumption in S0.....	281
25	Signal Groups.....	283
26	I/O Buffer Supply Voltage.....	285
27	DC Characteristics.....	286
28	MCH Ballout Sorted By Name.....	293
29	MCH Ballout Sorted By Ball.....	303
30	XOR Chain 14 Functionality.....	316
31	XOR Chain Outputs.....	317
32	XOR Chain 0.....	318
33	XOR Chain 1.....	319



34	XOR Chain 2 .....	319
35	XOR Chain 3 .....	319
36	XOR Chain 4 .....	320
37	XOR Chain 5 .....	320
38	XOR Chain 6 .....	321
39	XOR Chain 7 .....	322
40	XOR Chain 8 .....	322
41	XOR Chain 9 .....	323
42	XOR Chain 10 .....	323
43	XOR Chain 11 .....	324
44	XOR Chain 12 .....	324
45	XOR Chain 13 .....	325
46	XOR Chain 14 .....	326



## *Revision History*

---

Revision Number	Description	Revision Date
-001	• Initial release	November 2007



# Intel<sup>®</sup> 3200 and 3210 Chipset MCH Features

- Processor/Host Interface (FSB)
  - Dual-Core Intel<sup>®</sup> Xeon<sup>®</sup> Processor 3000 Series
  - Quad-Core Intel<sup>®</sup> Xeon<sup>®</sup> Processor 3200 Series
  - 800/1067/1333 MT/s (200/266/333 MHz) FSB
  - Hyper-Threading Technology (HT Technology)
  - FSB Dynamic Bus Inversion (DBI)
  - 36-bit host bus addressing
  - 12-deep In-Order Queue
  - 1-deep Defer Queue
  - GTL+ bus driver with integrated GTL termination resistors
  - Supports cache Line Size of 64 bytes
- System Memory Interface
  - One or two channels (each channel consisting of 64 data lines)
  - Single or Dual Channel memory organization
  - DDR2-800/667 frequencies
  - Unbuffered, ECC and non-ECC DDR2 DIMMs
  - Supports 1-Gb, 512-Mb DDR2
  - 8 GB maximum memory
- Direct Media Interface (DMI)
  - Chip-to-chip connection interface to Intel ICH9
  - 2 GB/s point-to-point DMI to ICH9 (1 GB/s each direction)
  - 100 MHz reference clock (shared with PCI Express graphics attach)
  - 32-bit downstream addressing
  - Messaging and Error Handling
- PCI Express\* Interface
  - 3210 MCH supports one x16 PCI Express port or two x8 PCI Express ports
  - 3200 MCH supports one x8 PCI Express port
  - Compatible with the *PCI Express Base Specification, Revision 1.1*
  - Raw bit rate on data pins of 2.5 Gb/s resulting in a real bandwidth per pair of 250 MB/s
- Thermal Sensor
  - Catastrophic Trip Point support
  - Hot Trip Point support for SMI generation
- Power Management
  - ACPI Revision 2.0 compatible power management
  - Supports processor states: C0, C1, C2
  - Supports System states: S0, S1, and S5
  - Supports processor Thermal Management 2
- Package
  - FC-BGA
  - 40 mm × 40 mm package size
  - 1300 balls, located in a non-grid pattern

§



# 1 Introduction

---

The Intel® 3200 and 3210 Chipsets are designed for use with the Dual-Core Intel® Xeon® Processor 3000 Series and Quad-Core Intel® Xeon® Processor 3200 Series in server platforms. The chipset contains two components: 3210/3100 MCH for the host bridge and I/O Controller Hub 9 (ICH9) for the I/O subsystem. The ICH9 is the ninth generation I/O Controller Hub and provides a multitude of I/O related functions. [Figure 1](#) and [Figure 2](#) show example system block diagrams for the Intel® 3200 and 3210 Chipsets.

This document is the datasheet for the Intel® 3200 and 3210 Memory Controller Hub (MCH). Topics covered include; signal description, system memory map, PCI register description, a description of the MCH interfaces and major functional units, electrical characteristics, ballout definitions, and package characteristics.

**Note:** Unless otherwise specified, ICH9 refers to the Intel® 82801IB ICH9 and Intel® 82801IR ICH9R I/O Controller Hub 9 components.

**Note:** The term ICH9 refers to the ICH9 and ICH9R components.

**Note:** In this document, all references to MCH apply to both 3200 MCH and 3210 MCH, unless otherwise noted.

Figure 1. Intel® 3210 Chipset System Diagram Example

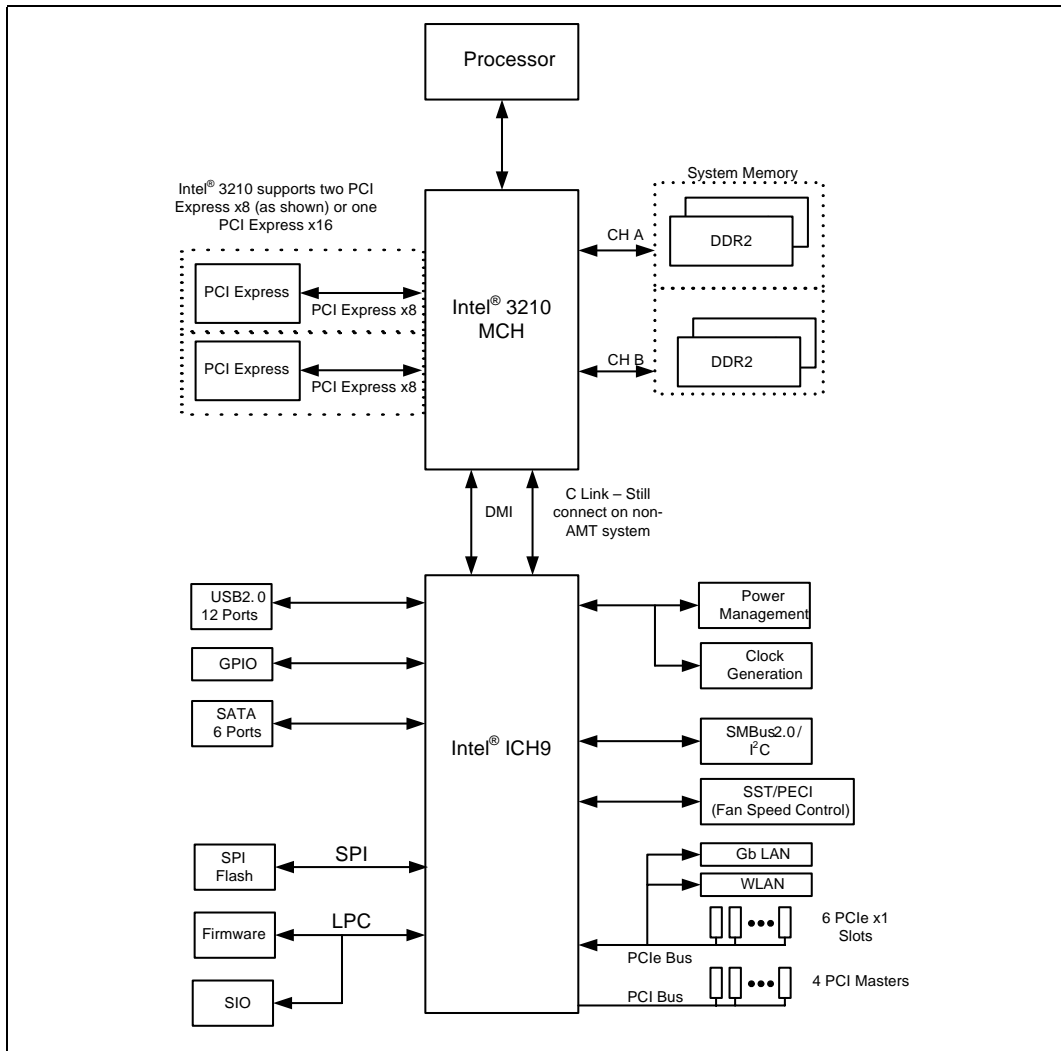
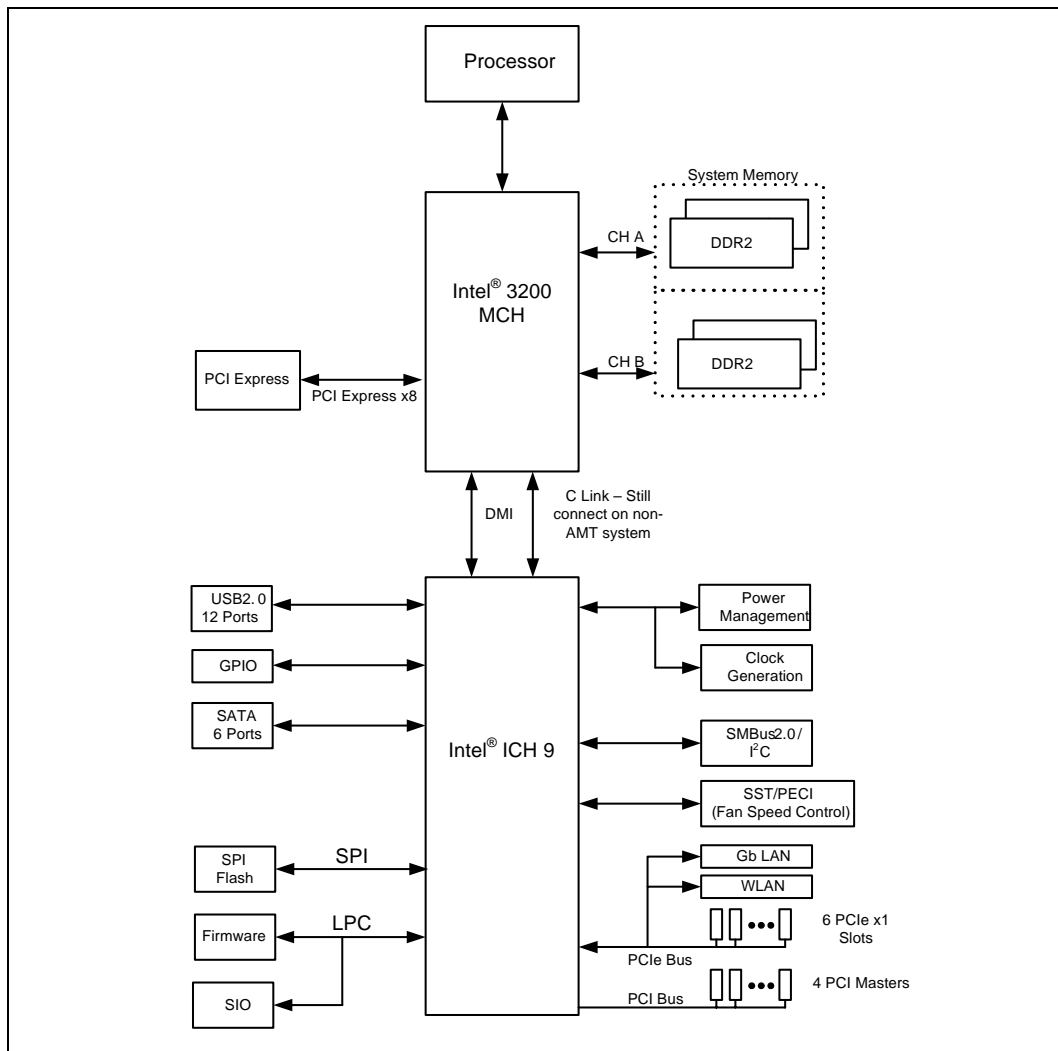





Figure 2. Intel® 3200 Chipset System Diagram Example



## 1.1 Terminology

Term	Description
Chipset / Root – Complex	Used in this specification to refer to one or more hardware components that connect processor complexes to the I/O and memory subsystems. The chipset may include a variety of integrated devices.
CLink	Controller Link is a proprietary chip-to-chip connection between the MCH and ICH. The chipset requires that CLink is connected in the platform.
Core	The internal base logic in the MCH
DBI	Dynamic Bus Inversion
DDR2	A second generation Double Data Rate SDRAM memory technology



Term	Description
DMI	Direct Media Interface is a proprietary chip-to-chip connection between the MCH and ICH. This interface is based on the standard PCI Express* specification.
Domain	A collection of physical, logical or virtual resources that are allocated to work together. Domain is used as a generic term for virtual machines, partitions, etc.
EP	PCI Express Egress Port
FSB	Front Side Bus. Synonymous with Host or processor bus
Full Reset	Full reset is when PWROK is de-asserted. Warm reset is when both RSTIN# and PWROK are asserted.
MCH	Memory Controller Hub component that contains the processor interface, DRAM controller, and PCI Express port. It communicates with the I/O controller hub (Intel® ICH9) over the DMI interconnect. .
Host	This term is used synonymously with processor
INTx	An interrupt request signal where X stands for interrupts A, B, C and D
Intel® ICH9	Ninth generation I/O Controller Hub component that contains the primary PCI interface, LPC interface, USB2.0, SATA, and other I/O functions. For this MCH, the term ICH refers to the ICH9.
IOQ	In Order Queue
MSI	Message Signaled Interrupt. A transaction conveying interrupt information to the receiving agent through the same path that normally carries read and write commands.
OOQ	Out of Order Queueing
PCI Express*	A high-speed serial interface whose configuration is software compatible with the legacy PCI specifications.
Primary PCI	The physical PCI bus that is driven directly by the Intel® ICH9. Communication between Primary PCI and the MCH occurs over DMI. The Primary PCI bus is not PCI Bus 0 from a configuration standpoint.
Rank	A unit of DRAM corresponding to eight x8 SDRAM devices in parallel or four x16 SDRAM devices in parallel, ignoring ECC. These devices are usually, but not always, mounted on a single side of a DIMM.
SCI	System Control Interrupt. Used in ACPI protocol.
SERR	System Error. An indication that an unrecoverable error has occurred on an I/O bus.
SMI	System Management Interrupt. Used to indicate any of several system conditions such as thermal sensor events, throttling activated, access to System Management RAM, chassis open, or other system state related activity.
Intel® TXT	Intel® Trusted Execution Technology (TXT) defines platform level enhancements that provide the building blocks for creating trusted platforms.
VCO	Voltage Controlled Oscillator

**Table 1. Intel Specification**

Document Name	Location
<i>Intel® 3200 and 3210 Chipset Specification Update</i>	<a href="http://www.intel.com/design/chipsets/specupdt/318464.htm">http://www.intel.com/design/chipsets/specupdt/318464.htm</a>
<i>Intel® 3200 and 3210 Chipset Thermal and Mechanical Design Guide</i>	<a href="http://www.intel.com/design/chipsets/designex/318465.htm">http://www.intel.com/design/chipsets/designex/318465.htm</a>
<i>Dual-Core Intel® Xeon Processor 3000 series Thermal and Mechanical Design Guidelines</i>	<a href="http://www.intel.com/design/intarch/designgd/314917.htm">http://www.intel.com/design/intarch/designgd/314917.htm</a>
<i>Intel® I/O Controller Hub 9 (ICH9) Family Thermal Mechanical Design Guide.</i>	<a href="http://www.intel.com/design/chipsets/designex/316974.htm">http://www.intel.com/design/chipsets/designex/316974.htm</a>
<i>Intel® I/O Controller Hub 9 (ICH9) Family Datasheet</i>	<a href="http://www.intel.com/design/chipsets/datashts/316972.htm">http://www.intel.com/design/chipsets/datashts/316972.htm</a>
<i>Designing for Energy Efficiency White Paper</i>	<a href="http://www.intel.com/design/chipsets/applnots/316970.htm">http://www.intel.com/design/chipsets/applnots/316970.htm</a>
<i>Advanced Configuration and Power Interface Specification, Version 2.0</i>	<a href="http://www.acpi.info/">http://www.acpi.info/</a>
<i>Advanced Configuration and Power Interface Specification, Version 1.0b</i>	<a href="http://www.acpi.info/">http://www.acpi.info/</a>
<i>The PCI Local Bus Specification, Version 2.3</i>	<a href="http://www.pcisig.com/specifications">http://www.pcisig.com/specifications</a>
PCI Express* Specification, Version 1.1	<a href="http://www.pcisig.com/specifications">http://www.pcisig.com/specifications</a>



## 1.2 MCH Overview

The role of a MCH in a system is to manage the flow of information between its four interfaces: the processor interface, the system memory interface, the PCI Express interface, and the I/O Controller through DMI interface. This includes arbitrating between the four interfaces when each initiates transactions. It supports one or two channels of DDR2 SDRAM. It also supports the PCI Express based external device attach. The Intel 3200/3210 Chipset platform supports the ninth generation I/O Controller Hub (Intel ICH9) to provide I/O related features.

### 1.2.1 Host Interface

The MCH supports a single LGA775 socket processor. The MCH supports a FSB frequency of 800/1066/1333 MHz. Host-initiated I/O cycles are decoded to PCI Express, DMI, or the MCH configuration space. Host-initiated memory cycles are decoded to PCI Express, DMI or system memory. PCI Express device accesses to non-cacheable system memory are not snooped on the host bus. Memory accesses initiated from PCI Express using PCI semantics and from DMI to system SDRAM will be snooped on the host bus.

#### Processor/Host Interface (FSB) Details

- Supports the Dual-Core Intel® Xeon® Processor 3000 Series and Quad-Core Intel® Xeon® Processor 3200 Series.
- Supports Front Side Bus (FSB) at the following Frequency Ranges:
  - 800/1066/1333MT/s
- Supports FSB Dynamic Bus Inversion (DBI)
- Supports 36-bit host bus addressing, allowing the processor to access the entire 64 GB of the host address space.
- Has a 12-deep In-Order Queue to support up to twelve outstanding pipelined address requests on the host bus
- Has a 1-deep Defer Queue
- Uses GTL+ bus driver with integrated GTL termination resistors
- Supports a Cache Line Size of 64 bytes

### 1.2.2 System Memory Interface

The MCH integrates a system memory DDR2 controller with two, 64-bit wide interfaces. The buffers support SSTL\_1.8 (Stub Series Terminated Logic for 1.8 V) signal interfaces. The memory controller interface is fully configurable through a set of control registers.

#### System Memory Interface Details

- Directly supports one or two channels of DDR2 memory with a maximum of two DIMMs per channel.
- Supports single and dual channel memory organization modes.
- Supports a data burst length of eight for all memory organization modes.
- Supports memory data transfer rates of 667 and 800 MHz for DDR2.
- I/O Voltage of 1.8 V for DDR2.
- Supports both un-buffered ECC and non-ECC DDR2 DIMMs. The MCH does not support memory configurations that mix ECC and non-ECC un-buffered DIMMs.



- Supports maximum memory bandwidth of 6.4 GB/s in single-channel mode or 12.8 GB/s in dual-channel mode assuming DDR2 800 MHz.
- Supports 512-Mb and 1-Gb DDR2 DRAM technologies for x8 and x16 devices.
- Using 512 Mb device technologies, the smallest memory capacity possible is 256 MB, assuming Single Channel Mode with a single x16 single sided un-buffered non-ECC DIMM memory configuration.
- Using 1 Gb device technologies, the largest memory capacity possible is 8 GB, assuming Dual Channel Mode with four x8 double sided un-buffered non-ECC or ECC DIMM memory configurations.  
**Note:** The ability to support greater than the largest memory capacity is subject to availability of higher density memory devices.
- Supports up to 32 simultaneous open pages per channel (assuming 4 ranks of 8 bank devices)
- Supports opportunistic refresh scheme
- Supports Partial Writes to memory using Data Mask (DM) signals
- Supports a memory thermal management scheme to selectively manage reads and/or writes. Memory thermal management can be triggered either by on-die thermal sensor, or by preset limits. Management limits are determined by weighted sum of various commands that are scheduled on the memory interface.

### 1.2.3 Direct Media Interface (DMI)

Direct Media Interface (DMI) is the chip-to-chip connection between the MCH and ICH9. This high-speed interface integrates advanced priority-based servicing allowing for concurrent traffic and true isochronous transfer capabilities. Base functionality is completely software transparent permitting current and legacy software to operate normally.

To provide for true isochronous transfers and configurable Quality of Service (QoS) transactions, the ICH9 supports two virtual channels on DMI: VC0 and VC1. These two channels provide a fixed arbitration scheme where VC1 is always the highest priority. VC0 is the default conduit of traffic for DMI and is always enabled. VC1 must be specifically enabled and configured at both ends of the DMI link (i.e., the ICH9 and MCH).

- A chip-to-chip connection interface to Intel ICH9
- 2 GB/s point-to-point DMI to ICH9 (1 GB/s each direction)
- 100 MHz reference clock (shared with PCI Express)
- 32-bit downstream addressing
- APIC and MSI interrupt messaging support. Will send Intel-defined "End Of Interrupt" broadcast message when initiated by the processor.
- Message Signaled Interrupt (MSI) messages
- SMI, SCI, and SERR error indication



## 1.2.4 PCI Express\* Interface

The 3210 MCH supports either two PCI Express\* 8-lane (x8) ports or one PCI Express 16-lane (x16) port. [Figure 1](#) shows two PCI Express 8-lane (x8) ports (support of one PCI Express 16-lane (x16) port is not shown in figure). The 3200 MCH supports one 8-lane (x8) PCI Express port (see [Figure 2](#)). The 3200/3210 MCHs do not support PCI Express graphics. The PCI Express ports are intended for external device attach. The PCI Express ports are compliant to the *PCI Express\* Base Specification* revision 1.1. The x8 ports operate at a frequency of 2.5 Gb/s on each lane while employing 8b/10b encoding, and support a maximum theoretical bandwidth of 4.0 GB/s in each direction.

The PCI Express interface includes:

- For the 3210 MCH, either two 8-lane PCI Express ports or one 16-lane PCI Express port, compatible to the *PCI Express\* Base Specification*, Revision 1.1.
- For the 3200 MCH, one 8-lane PCI Express port, compatible to the *PCI Express\* Base Specification*, Revision 1.1
- PCI Express frequency of 1.25 GHz resulting in 2.5 Gb/s each direction per lane.
- Raw bit-rate on the data pins of 2.5 Gb/s, resulting in a real bandwidth per pair of 250 MB/s given the 8b/10b encoding used to transmit data across this interface
- Maximum theoretical realized bandwidth on the interface of 4 GB/s in each direction simultaneously, for an aggregate of 8 GB/s when x16.
- PCI Express Enhanced Addressing Mechanism allows for accessing the device configuration space in a flat memory mapped fashion.
- Automatic discovery, negotiation, and training of link out of reset.
- Supports traditional PCI style traffic (asynchronous snooped, PCI ordering) Hierarchical PCI-compliant configuration mechanism for downstream devices (i.e., normal PCI 2.3 Configuration space as a PCI-to-PCI bridge).
- Supports “static” lane numbering reversal. This method of lane reversal is controlled by a Hardware Reset strap, and reverses both the receivers and transmitters for all lanes (e.g., TX[15]->TX[0], RX[15]->RX[0]). This method is transparent to all external devices and is different than lane reversal as defined in the PCI Express Specification. In particular, link initialization is not affected by static lane reversal.



### 1.2.5 MCH Clocking

- Differential host clock of 200/266/333 MHz. Supports FSB transfer rates of 800/1066/1333 MT/s.
- Differential memory clocks of 333/400/533 MHz. Supports memory transfer rates of DDR2-667 and DDR2-800.
- The PCI Express\* PLL of 100 MHz Serial Reference Clock generates the PCI Express core clock of 250 MHz.
- All of the above clocks are capable of tolerating Spread Spectrum clocking.
- Host, memory, and PCI Express PLLs are disabled until PWROK is asserted.

### 1.2.6 Power Management

- MCH Power Management support includes: SMRAM space remapping to A0000h (128 KB)
- Supports extended SMRAM space above 256 MB, and cacheable (cacheability controlled by processor)
- ACPI Rev 1.0b compatible power management
- Supports processor states: C0, C1, and C2
- Supports System states: S0, S1, and S5
- Supports processor Thermal Management 2 (TM2)
- Supports Manageability states M0, M1–S5, M0ff–S5, M0ff-M1

### 1.2.7 Thermal Sensor

MCH Thermal Sensor support includes:

- Catastrophic Trip Point support for emergency clock gating for the MCH
- Hot Trip Point support for SMI generation









## 2 Signal Description

This chapter provides a detailed description of MCH signals. The signals are arranged in functional groups according to their associated interface.

The following notations are used to describe the signal type.

Signal Type	Description
PCI Express*	PCI Express interface signals. These signals are compatible with PCI Express 1.1 Signaling Environment AC Specifications and are AC coupled. The buffers are not 3.3 V tolerant. Differential voltage spec = $( D+ - D- ) * 2 = 1.2 \text{ Vmax}$ . Single-ended maximum = 1.25 V. Single-ended minimum = 0 V.
DMI	Direct Media Interface signals. These signals are compatible with PCI Express 1.1 Signaling Environment AC Specifications, but are DC coupled. The buffers are not 3.3 V tolerant. Differential voltage spec = $( D+ - D- ) * 2 = 1.2 \text{ Vmax}$ . Single-ended maximum = 1.25 V. Single-ended minimum = 0 V.
CMOS	CMOS buffers. 1.5 V tolerant.
COD	CMOS Open Drain buffers. 3.3 V tolerant.
HVCMOS	High Voltage CMOS buffers. 3.3 V tolerant.
HVIN	High Voltage CMOS input-only buffers. 3.3 V tolerant.
SSTL_1.8	Stub Series Termination Logic. These are 1.8 V output capable buffers. 1.8 V tolerant.
A	Analog reference or output. May be used as a threshold voltage or for buffer compensation.
GTL+	Gunning Transceiver Logic signaling technology. Implements a voltage level as defined by $V_{TT}$ of 1.2 V and/or 1.1 V.



## 2.1 Host Interface Signals

Note: Unless otherwise noted, the voltage level for all signals in this interface is tied to the termination voltage of the Host Bus ( $V_{TT}$ ).

Signal Name	Type	Description										
FSB_ADSB	I/O GTL+	<b>Address Strobe:</b> The processor bus owner asserts FSB_ADSB to indicate the first of two cycles of a request phase. The MCH can assert this signal for snoop cycles and interrupt messages.										
FSB_BNRB	I/O GTL+	<b>Block Next Request:</b> Used to block the current request bus owner from issuing new requests. This signal is used to dynamically control the processor bus pipeline depth.										
FSB_BPRIB	O GTL+	<b>Priority Agent Bus Request:</b> The MCH is the only Priority Agent on the processor bus. It asserts this signal to obtain the ownership of the address bus. This signal has priority over symmetric bus requests and will cause the current symmetric owner to stop issuing new transactions unless the FSB_LOCKB signal was asserted.										
FSB_BREQ0B	O GTL+	<b>Bus Request 0:</b> The MCH pulls the processor bus' FSB_BREQ0B signal low during FSB_CPURSTB. The processors sample this signal on the active-to-inactive transition of FSB_CPURSTB. The minimum setup time for this signal is 4 HCLKs. The minimum hold time is 2 HCLKs and the maximum hold time is 20 HCLKs. FSB_BREQ0B should be tristated after the hold time requirement has been satisfied.										
FSB_CPURSTB	O GTL+	<b>CPU Reset:</b> The FSB_CPURSTB pin is an output from the MCH. The MCH asserts FSB_CPURSTB while RSTINB (PCIRST# from the ICH) is asserted and for approximately 1 ms after RSTINB is de-asserted. The FSB_CPURSTB allows the processors to begin execution in a known state.										
FSB_DBSYB	I/O GTL+	<b>Data Bus Busy:</b> Used by the data bus owner to hold the data bus for transfers requiring more than one cycle.										
FSB_DEFERB	O GTL+	<b>Defer:</b> Signals that the MCH will terminate the transaction currently being snooped with either a deferred response or with a retry response.										
FSB_DINVB_[3:0]	I/O GTL+ 4x	<p><b>Dynamic Bus Inversion:</b> Driven along with the FSB_DB_[63:0] signals. Indicates if the associated signals are inverted or not. FSB_DINVB_[3:0] are asserted such that the number of data bits driven electrically low (low voltage) within the corresponding 16 bit group never exceeds 8.</p> <table border="0"> <tr> <td><b>FSB_DINVB_x</b></td> <td><b>Data Bits</b></td> </tr> <tr> <td>FSB_DINVB_3</td> <td>FSB_DB_[63:48]</td> </tr> <tr> <td>FSB_DINVB_2</td> <td>FSB_DB_[47:32]</td> </tr> <tr> <td>FSB_DINVB_1</td> <td>FSB_DB_[31:16]</td> </tr> <tr> <td>FSB_DINVB_0</td> <td>FSB_DB_[15:0]</td> </tr> </table>	<b>FSB_DINVB_x</b>	<b>Data Bits</b>	FSB_DINVB_3	FSB_DB_[63:48]	FSB_DINVB_2	FSB_DB_[47:32]	FSB_DINVB_1	FSB_DB_[31:16]	FSB_DINVB_0	FSB_DB_[15:0]
<b>FSB_DINVB_x</b>	<b>Data Bits</b>											
FSB_DINVB_3	FSB_DB_[63:48]											
FSB_DINVB_2	FSB_DB_[47:32]											
FSB_DINVB_1	FSB_DB_[31:16]											
FSB_DINVB_0	FSB_DB_[15:0]											
FSB_DRDYB	I/O GTL+	<b>Data Ready:</b> Asserted for each cycle that data is transferred.										



Signal Name	Type	Description
FSB_AB_[35:3]	I/O GTL+ 2x	<b>Host Address Bus:</b> FSB_AB_[35:3] connect to the processor address bus. During processor cycles, the FSB_AB_[35:3] are inputs. The MCH drives FSB_AB_[35:3] during snoop cycles on behalf of DMI and PCI Express initiators. FSB_AB_[35:3] are transferred at 2x rate. Note that the address is inverted on the processor bus. The values are driven by the MCH between PWROK assertion and FSB_CPURSTINB de-assertion to allow processor configuration.
FSB_ADSTBB_[1:0]	I/O GTL+ 2x	<b>Host Address Strobe:</b> The source synchronous strobes used to transfer FSB_AB_[31:3] and FSB_REQB_[4:0] at the 2x transfer rate. <b>Strobe</b> <b>Address Bits</b> FSB_ADSTBB_0              FSB_AB_[16:3], FSB_REQB_[4:0] FSB_ADSTBB_1              FSB_AB_[31:17]
FSB_DB_[63:0]	I/O GTL+ 4x	<b>Host Data:</b> These signals are connected to the processor data bus. Data on FSB_DB_[63:0] is transferred at a 4x rate. Note that the data signals may be inverted on the processor bus, depending on the FSB_DINVB_[3:0] signals.
FSB_DSTBPB_[3:0] FSB_DSTBNB_[3:0]	I/O GTL+ 4x	<b>Differential Host Data Strobes:</b> The differential source synchronous strobes used to transfer FSB_DB_[63:0] and FSB_DINVB_[3:0] at the 4x transfer rate. Named this way because they are not level sensitive. Data is captured on the falling edge of both strobes. Hence, they are pseudo-differential, and not true differential. <b>Strobe</b> <b>Data Bits</b> FSB_DSTB[P,N]B_3      FSB_DB_[63:48], HDINVB_3 FSB_DSTB[P,N]B_2      FSB_DB_[47:32], HDINVB_2 FSB_DSTB[P,N]B_1      FSB_DB_[31:16], HDINVB_1 FSB_DSTB[P,N]B_0      FSB_DB_[15:0], HDINVB_0
FSB_HITB	I/O GTL+	<b>Hit:</b> Indicates that a caching agent holds an unmodified version of the requested line. Also, driven in conjunction with FSB_HITMB by the target to extend the snoop window.
FSB_HITMB	I/O GTL+	<b>Hit Modified:</b> Indicates that a caching agent holds a modified version of the requested line and that this agent assumes responsibility for providing the line. Also, driven in conjunction with FSB_HITB to extend the snoop window.
FSB_LOCKB	I GTL+	<b>Host Lock:</b> All processor bus cycles sampled with the assertion of FSB_LOCKB and FSB_ADSB, until the negation of FSB_LOCKB must be atomic, i.e. <i>no DMI or PCI Express access</i> to DRAM are allowed when FSB_LOCKB is asserted by the processor.
FSB_REQB_[4:0]	I/O GTL+ 2x	<b>Host Request Command:</b> Defines the attributes of the request. FSB_REQB_[4:0] are transferred at 2x rate. Asserted by the requesting agent during both halves of Request Phase. In the first half the signals define the transaction type to a level of detail that is sufficient to begin a snoop request. In the second half the signals carry additional information to define the complete transaction type. The transactions supported by the MCH Host Bridge are defined in the Host Interface section of this document.



Signal Name	Type	Description																		
FSB_TRDYB	O GTL+	<b>Host Target Ready:</b> Indicates that the target of the processor transaction is able to enter the data transfer phase.																		
FSB_RSB_[2:0]	O GTL+	<p><b>Response Signals:</b> Indicates type of response according to the table at left:</p> <table border="1"> <thead> <tr> <th>Encoding</th> <th>Response Type</th> </tr> </thead> <tbody> <tr> <td>000</td> <td>Idle state</td> </tr> <tr> <td>001</td> <td>Retry response</td> </tr> <tr> <td>010</td> <td>Deferred response</td> </tr> <tr> <td>011</td> <td><i>Reserved (not driven by MCH)</i></td> </tr> <tr> <td>100</td> <td><i>Hard Failure (not driven by MCH)</i></td> </tr> <tr> <td>101</td> <td>No data response</td> </tr> <tr> <td>110</td> <td>Implicit Writeback</td> </tr> <tr> <td>111</td> <td>Normal data response</td> </tr> </tbody> </table>	Encoding	Response Type	000	Idle state	001	Retry response	010	Deferred response	011	<i>Reserved (not driven by MCH)</i>	100	<i>Hard Failure (not driven by MCH)</i>	101	No data response	110	Implicit Writeback	111	Normal data response
Encoding	Response Type																			
000	Idle state																			
001	Retry response																			
010	Deferred response																			
011	<i>Reserved (not driven by MCH)</i>																			
100	<i>Hard Failure (not driven by MCH)</i>																			
101	No data response																			
110	Implicit Writeback																			
111	Normal data response																			
FSB_RCOMP	I/O A	<b>Host RCOMP:</b> Used to calibrate the Host GTL+ I/O buffers. This signal is powered by the Host Interface termination rail (VTT). Connects to FSB_XRCOMP11N in the package.																		
FSB_SCOMP	I/O A	<b>Slew Rate Compensation:</b> Compensation for the Host Interface for rising edges.																		
FSB_SCOMPB	I/O A	<b>Slew Rate Compensation:</b> Compensation for the Host Interface for falling edges.																		
FSB_SWING	I/O A	<b>Host Voltage Swing:</b> These signals provide reference voltages used by the FSB RCOMP circuits. FSB_XSWING is used for the signals handled by FSB_XRCOMP.																		
FSB_DVREF	I/O A	<b>Host Reference Voltage:</b> Reference voltage input for the Data signals of the Host GTL interface.																		
FSB_ACCVREF	I/O A	<b>Host Reference Voltage:</b> Reference voltage input for the Address signals of the Host GTL interface.																		



## 2.2 System Memory (DDR2) Interface Signals

### 2.2.1 System Memory Channel A Interface Signals

Signal Name	Type	Description
DDR_A_CK	O SSTL-1.8	<b>SDRAM Differential Clocks:</b> — DDR2: Three per DIMM
DDR_A_CKB	O SSTL-1.8	<b>SDRAM Inverted Differential Clocks:</b> — DDR2: Three per DIMM
DDR_A_CSB_[3:0]	O SSTL-1.8	<b>DDR2 Device Rank 3, 2, 1, and 0 Chip Select</b>
DDR_A_CKE_[3:0]	O SSTL-1.8	<b>DDR2 Clock Enable:</b> (1 per Device Rank)
DDR_A_ODT_[3:0]	O SSTL-1.8	<b>DDR2 On Die Termination:</b> (1 per Device Rank)
DDR_A_MA_[14:0]	O SSTL-1.8	<b>DDR2 Address Signals [14:0]</b>
DDR_A_BS_[2:0]	O SSTL-1.8	<b>DDR2 Bank Select</b>
DDR_A_RASB	O SSTL-1.8	<b>DDR2 Row Address Select signal</b>
DDR_A_CASB	O SSTL-1.8	<b>DDR2 Column Address Select signal</b>
DDR_A_WEB	O SSTL-1.8	<b>DDR2 Write Enable signal</b>
DDR_A_DQ_[63:0]	I/O SSTL-1.8	<b>DDR2 Data Lines</b>
DDR_A_CB_[7:0]	I/O SSTL-1.8	<b>ECC Check Byte</b>
DDR_A_DM_[7:0]	O SSTL-1.8	<b>DDR2 Data Mask</b>
DDR_A_DQS_[8:0]	I/O SSTL-1.8	<b>DDR2 Data Strobes</b>
DDR_A_DQSB_[8:0]	I/O SSTL-1.8	<b>DDR2 Data Strobe Complements</b>



## 2.2.2 System Memory Channel B Interface Signals

Signal Name	Type	Description
DDR_B_CK	O SSTL-1.8	<b>SDRAM Differential Clocks:</b> — DDR2: Three per DIMM
DDR_B_CKB	O SSTL-1.8	<b>SDRAM Inverted Differential Clocks:</b> — DDR2: Three per DIMM
DDR_B_CSB_[3:0]	O SSTL-1.8	<b>DDR2 Device Rank 3, 2, 1, and 0 Chip Select</b>
DDR_B_CKE_[3:0]	O SSTL-1.8	<b>DDR2 Clock Enable:</b> (1 per Device Rank)
DDR_B_ODT_[3:0]	O SSTL-1.8	<b>DDR2 Device Rank 3, 2, 1, and 0 On Die Termination</b>
DDR_B_MA_[14:0]	O SSTL-1.8	<b>DDR2 Address Signals [14:0]</b>
DDR_B_BS_[2:0]	O SSTL-1.8	<b>DDR2 Bank Select</b>
DDR_B_RASB	O SSTL-1.8	<b>DDR2 Row Address Select signal</b>
DDR_B_CASB	O SSTL-1.8	<b>DDR2 Column Address Select signal</b>
DDR_B_WEB	O SSTL-1.8	<b>DDR2 Write Enable signal</b>
DDR_B_DQ_[63:0]	I/O SSTL-1.8	<b>DDR2 Data Lines</b>
DDR_B_CB_[7:0]	I/O SSTL-1.8	<b>ECC Check Byte</b>
DDR_B_DM_[7:0]	O SSTL-1.8	<b>DDR2 Data Mask</b>
DDR_B_DQS_[8:0]	I/O SSTL-1.8	<b>DDR2 Data Strobes</b>
DDR_B_DQSB_[8:0]	I/O SSTL-1.8	<b>DDR2 Data Strobe Complements</b>



### 2.2.3 System Memory Miscellaneous Signals

Signal Name	Type	Description
DDR_RCOMPXPD	I/O A	<b>System Memory Pull-down RCOMP</b>
DDR_RCOMPXPU	I/O A	<b>System Memory Pull-up RCOMP</b>
DDR_RCOMPYPD	I/O A	<b>System Memory Pull-down RCOMP</b>
DDR_RCOMPYPU	I/O A	<b>System Memory Pull-up RCOMP</b>
DDR_VREF	I A	<b>System Memory Reference Voltage</b>
DDR_RCOMPVOH	I A	<b>System Memory Pull-up Reference Signal</b>
DDR_RCOMPVOL	I A	<b>System Memory Pull-down Reference Signal</b>

## 2.3 PCI Express\* Interface Signals

Signal Name	Type	Description
PEG_RXN_[15:0] PEG_RXP_[15:0]	I/O PCIE	<b>Primary PCI Express Receive Differential Pair</b> For the 3200 MCH, a maximum width of x8 is supported. The upper 8 lanes are used for static lane reversal. This also applies to the 3210 MCH in dual x8 mode. For the 3210 MCH in single x16 mode, the MCH supports a maximum width of x16 where all lanes are used.
PEG_TXN_[15:0] PEG_TXP_[15:0]	O PCIE	<b>Primary PCI Express Transmit Differential Pair</b> For the 3200 MCH, a maximum width of x8 is supported. The upper 8 lanes are used for static lane reversal. This also applies to the 3210 MCH in dual x8 mode. For the 3210 MCH in single x16 mode, the MCH supports a maximum width of x16 where all lanes are used.
PEG2_RXN_[15:0] PEG2_RXP_[15:0] (3210 MCH only)	I/O PCIE	<b>Secondary PCI Express Receive Differential Pair</b> Note: When using the 3210 MCH in dual x8 mode, the MCH supports a maximum width of x8. The upper 8 lanes are used for static lane reversal. For the 3200 MCH, these signals are No Connects.
PEG2_TXN_[15:0] PEG2_TXP_[15:0] (3210 MCH only)	O PCIE	<b>Secondary PCI Express Transmit Differential Pair</b> Note: When using the 3210 MCH in dual x8 mode, the MCH supports a maximum width of x8. The upper 8 lanes are used for static lane reversal. For the 3200 MCH, these signals are No Connects.
EXP_COMPO	I A	<b>Primary PCI Express Output Current Compensation</b>



Signal Name	Type	Description
EXP_COMP1	I A	<b>Primary PCI Express Input Current Compensation</b>
EXP2_COMPO (3210 MCH only)	I A	<b>Secondary PCI Express Output Current Compensation</b> This signal is a No Connect for the 3200 MCH.
EXP2_COMP1 (3210 MCH only)	I A	<b>Secondary PCI Express Input Current Compensation</b> This signal is a No Connect for the 3200 MCH.

## 2.4 Controller Link Interface Signals

Signal Name	Type	Description
CL_DATA	I/O CMOS	<b>Controller Link Data (Bi-directional)</b>
CL_CLK	I/O CMOS	<b>Controller Link Clock (Bi-directional)</b>
CL_VREF	I CMOS	<b>Controller Link VREF</b>
CL_RST#	I CMOS	<b>Controller Link Reset (Active low)</b>

## 2.5 Clocks, Reset, and Miscellaneous

Signal Name	Type	Description
HPL_CLKINP HPL_CLKINN	I CMOS	<b>Differential Host Clock In:</b> These pins receive a differential host clock from the external clock synthesizer. This clock is used by all of the MCH logic that is in the Host clock domain.
EXP_CLKINP EXP_CLKINN	I CMOS	<b>Differential Primary PCI Express Clock In:</b> These pins receive a differential 100 MHz Serial Reference clock from the external clock synthesizer. This clock is used to generate the clocks necessary for the support of Primary PCI Express and DMI.
EXP2_CLKINP EXP2_CLKINN (3210 MCH only)	I CMOS	<b>Differential Secondary PCI Express Clock In:</b> These pins receive a differential 100 MHz Serial Reference clock from the external clock synthesizer. This clock is used to generate the clocks necessary for the support of Secondary PCI Express. Note: For the 3200 MCH, this signal pair is not used since only one 8-lane (x8) PCI Express port is supported.
RSTINB	I SSTL	<b>Reset In:</b> When asserted this signal will asynchronously reset the MCH logic. This signal is connected to the PCIRST# output of the ICH. All PCI Express output signals and DMI output signals will also tri-state compliant to PCI Express Rev 1.1 specification. This input should have a Schmitt trigger to avoid spurious resets. This signal is required to be 3.3 V tolerant.





Signal Name	Type	Description
CL_PWROK	I/O SSTL	<b>CL Power OK:</b> When asserted, CL_PWROK is an indication to the MCH that core power (VCC_CL) has been stable for at least 10 us.
EXP_SLR	I CMOS	<b>PCI Express* Static Lane Reversal/Form Factor Selection:</b> MCH's PCI Express lane numbers are reversed to differentiate BTX and ATX form factors 0 = MCH PCI Express lane numbers are reversed (BTX) 1 = Normal operation (ATX)
BSEL[2:0]	I CMOS	<b>Bus Speed Select:</b> At the de-assertion of PWROK, the value sampled on these pins determines the expected frequency of the bus.
PWROK	I/O SSTL	<b>Power OK:</b> When asserted, PWROK is an indication to the MCH that core power has been stable for at least 10 us.
ICH_SYNCB	O HVC MOS	<b>ICH Sync:</b> This signal synchronizes the MCH with the ICH.
ALLZTEST	I GTL+	<b>All Z Test:</b> This signal is used for chipset Bed of Nails testing to execute All Z Test. It is used as output for XOR Chain testing.
XORTEST	I GTL+	<b>XOR Chain Test:</b> This signal is used for chipset Bed of Nails testing to execute XOR Chain Test.
TEST[3:0]	I/O A	<b>In Circuit Test:</b> These pins should be connected to test points on the motherboard. They are internally shorted to the package ground and can be used to determine if the corner balls on the MCH are correctly soldered down to the motherboard. These pins should NOT connect to ground on the motherboard. If TEST[3:0] are not going to be used, they should be left as no connects.

## 2.6 Direct Media Interface

Signal Name	Type	Description
DMI_RXP_[3:0] DMI_RXN_[3:0]	I DMI	<b>Direct Media Interface:</b> Receive differential pair (RX). MCH-ICH serial interface input
DMI_TXP_[3:0] DMI_TXN_[3:0]	O DMI	<b>Direct Media Interface:</b> Transmit differential pair (TX). MCH-ICH serial interface output



## 2.7 Power and Grounds

Name	Voltage	Description
VCC	1.25 V	Core Power
VTT	1.1 V/1.2 V	Processor System Bus Power
VCC_EXP	1.25 V	PCI Express* and DMI Power
VCC_DDR	1.8 V	DDR2 System Memory Power
VCC_CKDDR	1.8V	DDR2 System Clock Memory Power
VCC3_3	3.3 V	3.3 V CMOS Power
VCCAPLL_EXP	1.25 V	Primary PCI Express PLL Analog Power
VCCAPLL_EXP2	1.25 V	Secondary PCI Express PLL Analog Power
VCCA_hplL	1.25 V	Host PLL Analog Power
VCCA_mpl	1.25 V	System Memory PLL Analog Power
VCCABG_EXP	3.3 V	PCI Express* Analog Power
VCC_CL	1.25 V	Controller Link Aux Power
VSS	0 V	Ground

§ §



## 3 System Address Map

---

The MCH supports 64 GB (36 bit) of host address space and 64 KB+3 of addressable I/O space. There is a programmable memory address space under the 1 MB region which is divided into regions which can be individually controlled with programmable attributes such as Disable, Read/Write, Write Only, or Read Only. Attribute programming is described in the Register Description section. This section focuses on how the memory space is partitioned and what the separate memory regions are used for. I/O address space has simpler mapping and is explained near the end of this section.

The MCH supports PCI Express\* upper pre-fetchable base/limit registers. This allows the PCI Express unit to claim IO accesses above 36 bit, complying with the PCI Express Specification. Addressing of greater than 8 GB is allowed on either the DMI Interface or PCI Express interface. The MCH supports a maximum of 8 GB of DRAM. No DRAM memory will be accessible above 8 GB.

In the following sections, it is assumed that all of the compatibility memory ranges reside on the DMI Interface. The MCH does not remap APIC or any other memory spaces above TOLUD (Top of Low Usable DRAM). The TOLUD register is set to the appropriate value by BIOS. The reclaim base/reclaim limit registers remap logical accesses bound for addresses above 4 GB onto physical addresses that fall within DRAM.

The Address Map includes a number of programmable ranges:

- Device 0
  - PXPEPBAR – Egress port registers. Necessary for setting up VC1 as an isochronous channel using time based weighted round robin arbitration. (4 KB window)
  - MCHBAR – Memory mapped range for internal MCH registers. For example, memory buffer register controls. (16 KB window)
  - PCIEXBAR – Flat memory-mapped address spaced to access device configuration registers. This mechanism can be used to access PCI configuration space (0–FFh) and Extended configuration space (100h–FFFh) for PCI Express devices. This enhanced configuration access mechanism is defined in the PCI Express specification. (64 MB, 128 MB, or 256 MB window).
  - DMIBAR – This window is used to access registers associated with the Direct Media Interface (DMI) register memory range. (4 KB window)
- Device 1
  - MBASE1/MLIMIT1 – PCI Express port non-prefetchable memory access window.
  - PMBASE1/PLIMIT1 – PCI Express port prefetchable memory access window.
  - PMUBASE/PMULIMIT – PCI Express port upper prefetchable memory access window
  - IOBASE1/IOLIMIT1 – PCI Express port I/O access window.



- Device 3
  - ME Control
- Device 6, Function 0 (Intel 3210 MCH only)
  - MBASE1/MLIMIT1 – PCI Express port non-prefetchable memory access window.
  - PMBASE1/PMLIMIT1 – PCI Express port prefetchable memory access window.
  - PMUBASE/PMULIMIT – PCI Express port upper prefetchable memory access window
  - IOBASE1/IOLIMIT1 – PCI Express port I/O access window.

The rules for the above programmable ranges are:

1. ALL of these ranges MUST be unique and NON-OVERLAPPING. It is the BIOS or system designers' responsibility to limit memory population so that adequate PCI, PCI Express, High BIOS, and PCI Express Memory Mapped space, and APIC memory space can be allocated.
2. In the case of overlapping ranges with memory, the memory decode will be given priority. This is an Intel Trusted Execution Technology requirement. It is necessary to get Intel TET protection checks, avoiding potential attacks.
3. There are NO Hardware Interlocks to prevent problems in the case of overlapping ranges.
4. Accesses to overlapped ranges may produce indeterminate results.
5. The only peer-to-peer cycles allowed below the top of Low Usable memory (register TOLUD) are DMI Interface to PCI Express range writes.

Figure 3 represents system memory address map in a simplified form.



Figure 3. System Address Ranges

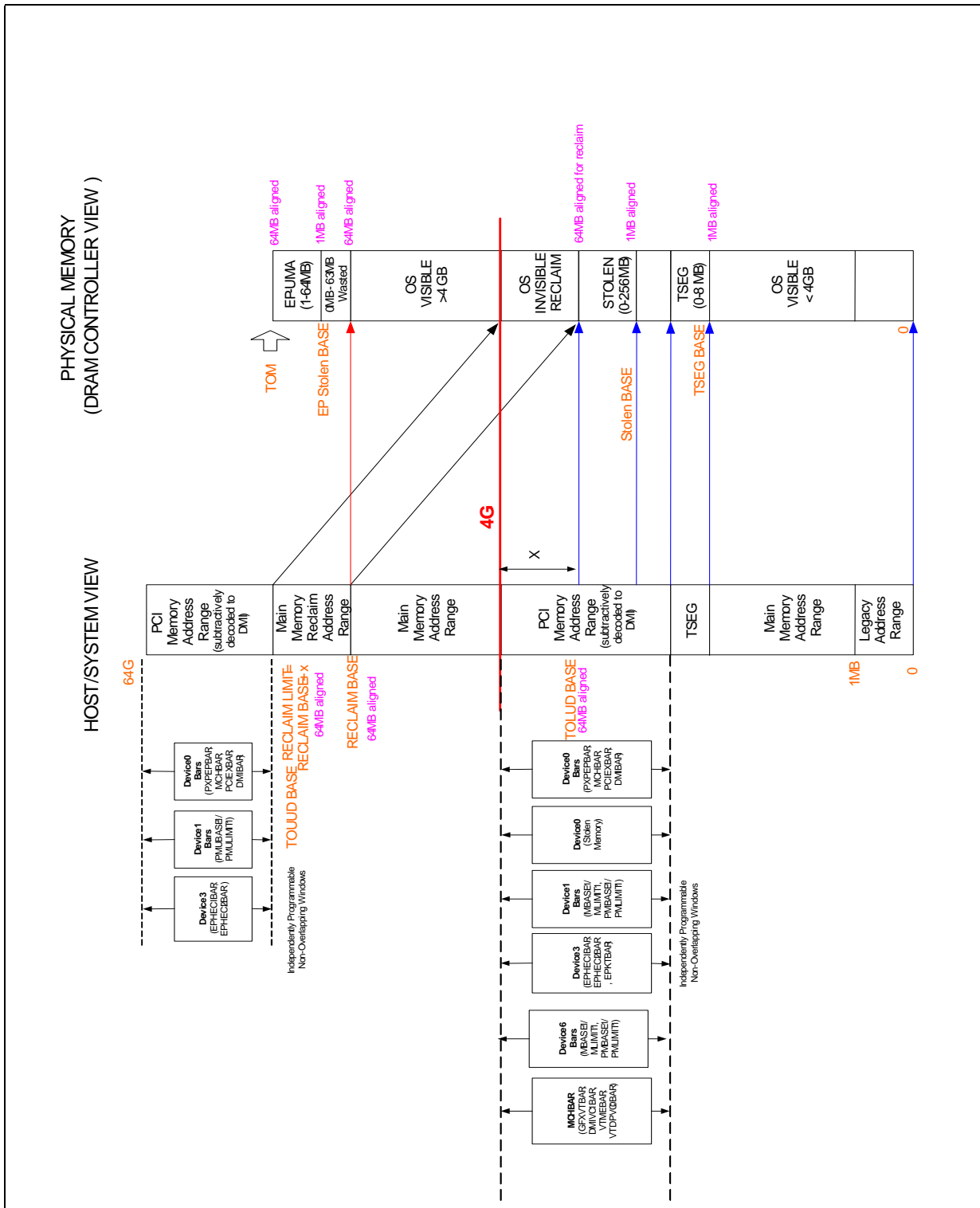

NOTE: Do not follow the EP UMA requirement.

### 3.1 Legacy Address Range

This area is divided into the following address regions:

- 0 - 640 KB – DOS Area
- 640 - 768 KB – Legacy Video Buffer Area
- 768 - 896 KB in 16 KB sections (total of 8 sections) – Expansion Area
- 896 -960 KB in 16 KB sections (total of 4 sections) – Extended System BIOS Area
- 960 KB - 1 MB Memory – System BIOS Area

Figure 4. DOS Legacy Address Range

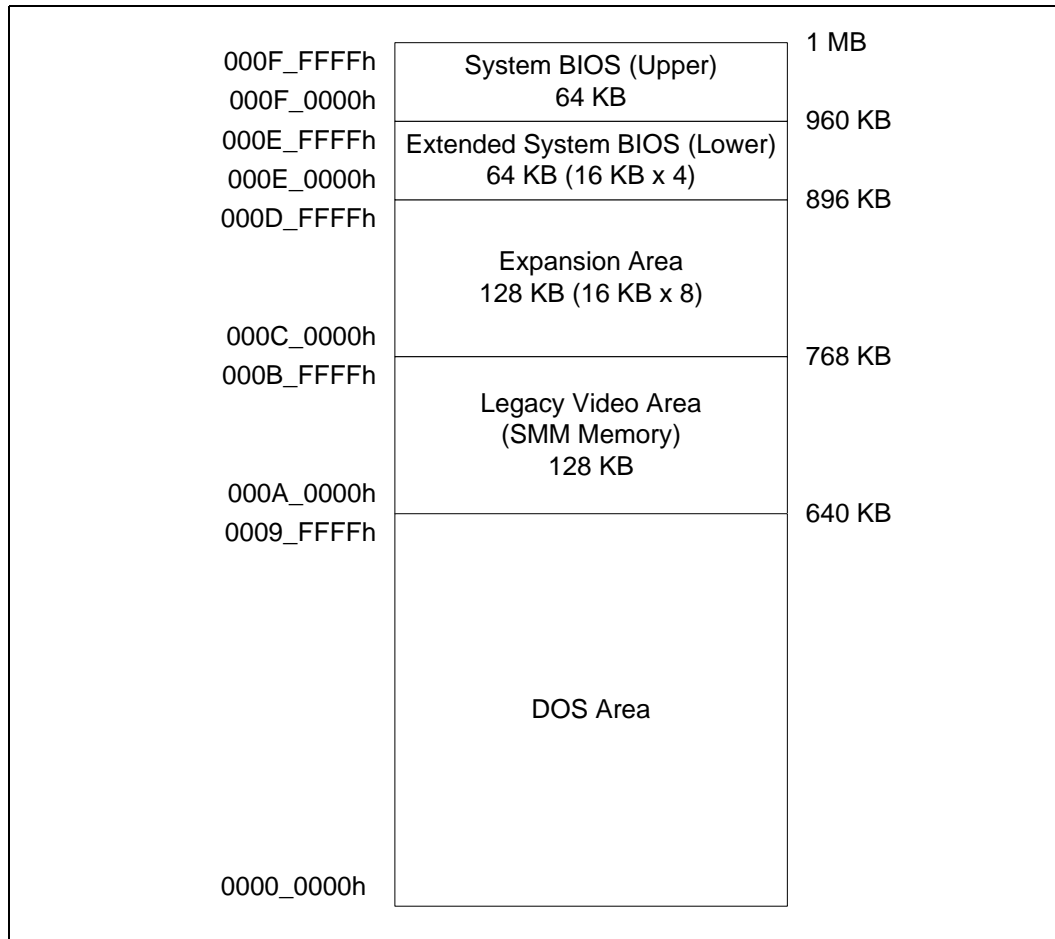

#### 3.1.1 DOS Range (0h – 9\_FFFFh)

The DOS area is 640 KB (0000\_0000h – 0009\_FFFFh) in size and is always mapped to the main memory controlled by the MCH.



### 3.1.2 Expansion Area (C\_0000h-D\_FFFFh)

This 128 KB ISA Expansion region (000C\_0000h – 000D\_FFFFh) is divided into eight 16 KB segments. Each segment can be assigned one of four Read/Write states: read-only, write-only, read/write, or disabled. Typically, these blocks are mapped through MCH and are subtractive decoded to ISA space. Memory that is disabled is not remapped.

Non-snooped accesses from PCI Express or DMI to this region are always sent to DRAM.

**Table 2. Expansion Area Memory Segments**

Memory Segments	Attributes	Comments
0C0000h – 0C3FFFh	WE RE	Add-on BIOS
0C4000h – 0C7FFFh	WE RE	Add-on BIOS
0C8000h – 0CBFFFh	WE RE	Add-on BIOS
0CC000h – 0CFFFFh	WE RE	Add-on BIOS
0D0000h – 0D3FFFh	WE RE	Add-on BIOS
0D4000h – 0D7FFFh	WE RE	Add-on BIOS
0D8000h – 0DBFFFh	WE RE	Add-on BIOS
0DC000h – 0DFFFFh	WE RE	Add-on BIOS

### 3.1.3 Extended System BIOS Area (E\_0000h–E\_FFFFh)

This 64 KB area (000E\_0000h – 000E\_FFFFh) is divided into four 16 KB segments. Each segment can be assigned independent read and write attributes so it can be mapped either to main DRAM or to DMI Interface. Typically, this area is used for RAM or ROM. Memory segments that are disabled are not remapped elsewhere.

Non-snooped accesses from PCI Express or DMI to this region are always sent to DRAM.

**Table 3. Extended System BIOS Area Memory Segments**

Memory Segments	Attributes	Comments
0E0000h – 0E3FFFh	WE RE	BIOS Extension
0E4000h – 0E7FFFh	WE RE	BIOS Extension
0E8000h – 0EBFFFh	WE RE	BIOS Extension
0EC000h – 0EFFFFh	WE RE	BIOS Extension



### 3.1.4 System BIOS Area (F\_0000h–F\_FFFFh)

This area is a single 64 KB segment (000F\_0000h – 000F\_FFFFh). This segment can be assigned read and write attributes. It is by default (after reset) Read/Write disabled and cycles are forwarded to DMI Interface. By manipulating the Read/Write attributes, the MCH can “shadow” BIOS into the main DRAM. When disabled, this segment is not remapped.

Non-snooped accesses from PCI Express or DMI to this region are always sent to DRAM.

Table 4. System BIOS Area Memory Segments

Memory Segments	Attributes	Comments
0F0000h – 0FFFFFh	WE RE	BIOS Area

### 3.1.5 PAM Memory Area Details

The 13 sections from 768 KB to 1 MB comprise what is also known as the PAM Memory Area.

The MCH does not handle IWB (Implicit Write-Back) cycles targeting DMI. Since all memory residing on DMI should be set as non-cacheable, there will normally not be IWB cycles targeting DMI. However, DMI becomes the default target for processor and DMI originated accesses to disabled segments of the PAM region. If the MTRRs covering the PAM regions are set to WB or RD it is possible to get IWB cycles targeting DMI. This may occur for processor originated cycles (in a DP system) and for DMI originated cycles to disabled PAM regions.

For example, say that a particular PAM region is set for “Read Disabled” and the MTRR associated with this region is set to WB. A DMI master generates a memory read targeting the PAM region. A snoop is generated on the FSB and the result is an IWB. Since the PAM region is “Read Disabled” the default target for the Memory Read becomes DMI. The IWB associated with this cycle will cause the MCH to hang.

Non-snooped accesses from PCI Express or DMI to this region are always sent to DRAM.

## 3.2 Main Memory Address Range (1MB – TOLUD)

This address range extends from 1 MB to the top of Low Usable physical memory that is permitted to be accessible by the MCH (as programmed in the TOLUD register). All accesses to addresses within this range will be forwarded by the MCH to the DRAM unless it falls into the optional TSEG, or optional ISA Hole.





Figure 5. Main Memory Address Range

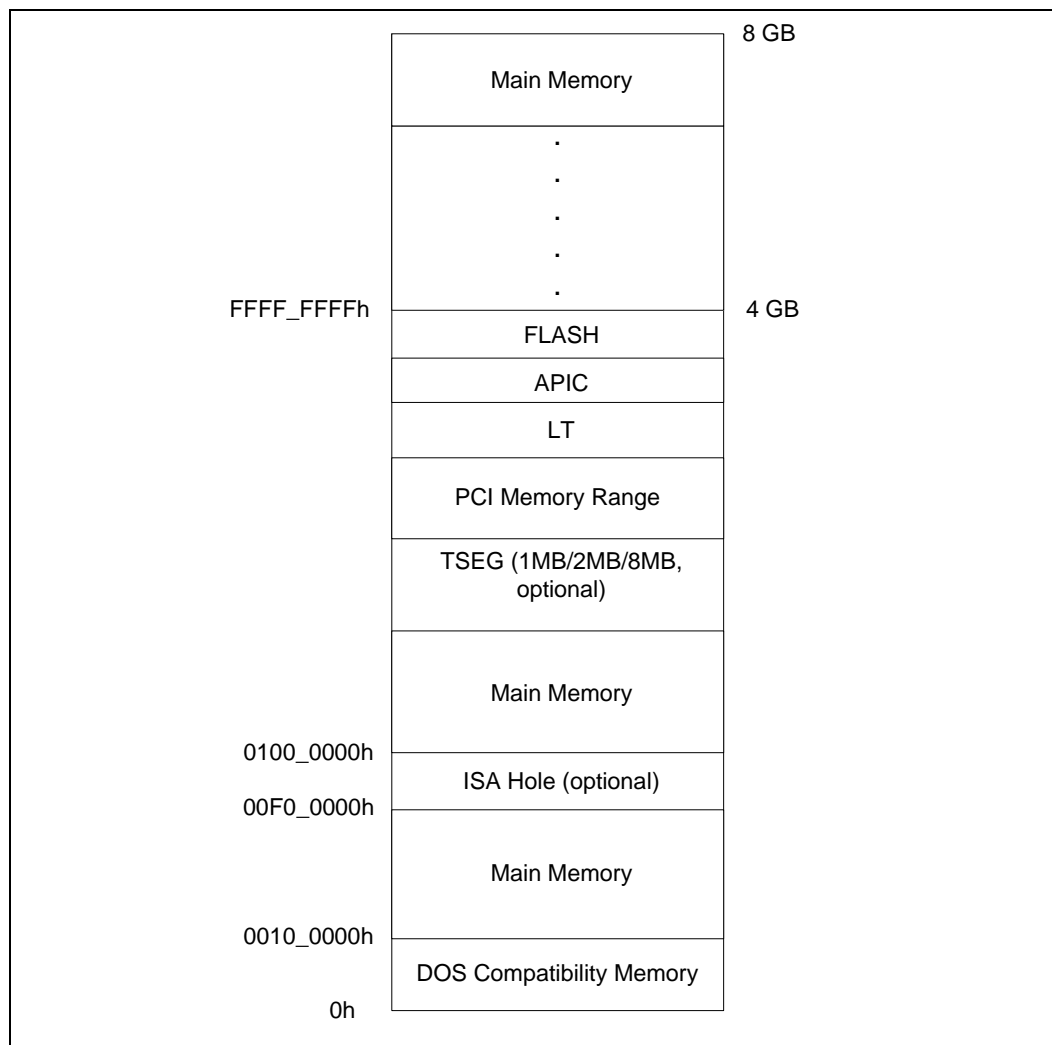

### 3.2.1 ISA Hole (15 MB –16 MB)

A hole can be created at 15 MB–16 MB as controlled by the fixed hole enable in Device 0 space. Accesses within this hole are forwarded to the DMI Interface. The range of physical DRAM memory disabled by opening the hole is not remapped to the top of the memory – that physical DRAM space is not accessible. This 15–16 MB hole is an optionally enabled ISA hole.

The ISA Hole is used by validation and customer SV teams for some of their test cards. That is why it is being supported. There is no inherent BIOS request for the 15–16 MB window.



### 3.2.2 TSEG

TSEG is optionally 1 MB, 2 MB, or 8 MB in size. TSEG is below stolen memory, which is at the top of Low Usable physical memory (TOLUD). SMM-mode processor accesses to enabled TSEG access the physical DRAM at the same address. Non-processor originated accesses are not allowed to SMM space. PCI Express, and DMI originated cycles to enabled SMM space are handled as invalid cycle type with reads and writes to location 0 and byte enables turned off for writes. When the extended SMRAM space is enabled, processor accesses to the TSEG range without SMM attribute or without WB attribute are also forwarded to memory as invalid accesses (see table 8). Non-SMM-mode Write Back cycles that target TSEG space are completed to DRAM for cache coherency. When SMM is enabled the maximum amount of memory available to the system is equal to the amount of physical DRAM minus the value in the TSEG register which is fixed at 1 MB, 2 MB, or 8 MB.

### 3.2.3 Pre-allocated Memory

Voids of physical addresses that are not accessible as general system memory and reside within system memory address range (< TOLUD) are created for SMM-mode, and stolen memory. **It is the responsibility of BIOS to properly initialize these regions.** The following table details the location and attributes of the regions. Enabling/Disabling these ranges are described in the MCH Control Register Device 0 (GCC).

Figure 6. Pre-allocated Memory Example for 64 MB DRAM, 1 MB stolen and 1 MB TSEG

Memory Segments	Attributes	Comments
0000_0000h – 03CF_FFFFh	R/W	Available System Memory 61 MB
03D0_0000h – 03DF_FFFFh	SMM Mode Only - processor Reads	TSEG Address Range & Pre-allocated memory



### 3.3 PCI Memory Address Range (TOLUD – 4 GB)

This address range, from the top of low usable DRAM (TOLUD) to 4 GB is normally mapped to the DMI Interface.

Device 0 exceptions are:

- Addresses decoded to the egress port registers (PXPEPBAR)
- Addresses decoded to the memory mapped range for internal MCH registers (MCHBAR)
- Addresses decoded to the flat memory-mapped address spaced to access device configuration registers (PCIEXBAR)
- Addresses decoded to the registers associated with the Direct Media Interface (DMI) register memory range. (DMIBAR)

With PCI Express port, there are two exceptions to this rule.

- Addresses decoded to the PCI Express Memory Window defined by the MBASE1, MLIMIT1, registers are mapped to PCI Express.
- Addresses decoded to the PCI Express prefetchable Memory Window defined by the PMBASE1, PMLIMIT1, registers are mapped to PCI Express.

In an Intel ME configuration, there are exceptions to this rule:

1. Addresses decoded to the ME Keyboard and Text MMIO range (EPKTBAR)
2. Addresses decoded to the ME HECI MMIO range (EPHEC1BAR)
3. Addresses decoded to the ME HECI2 MMIO range (EPHEC12BAR)

Some of the MMIO Bars may be mapped to this range or to the range above TOUUD.

There are sub-ranges within the PCI Memory address range defined as APIC Configuration Space, FSB Interrupt Space, and High BIOS Address Range. The exceptions listed above for the PCI Express ports ***MUST NOT*** overlap with these ranges.

Figure 7. PCI Memory Address Range

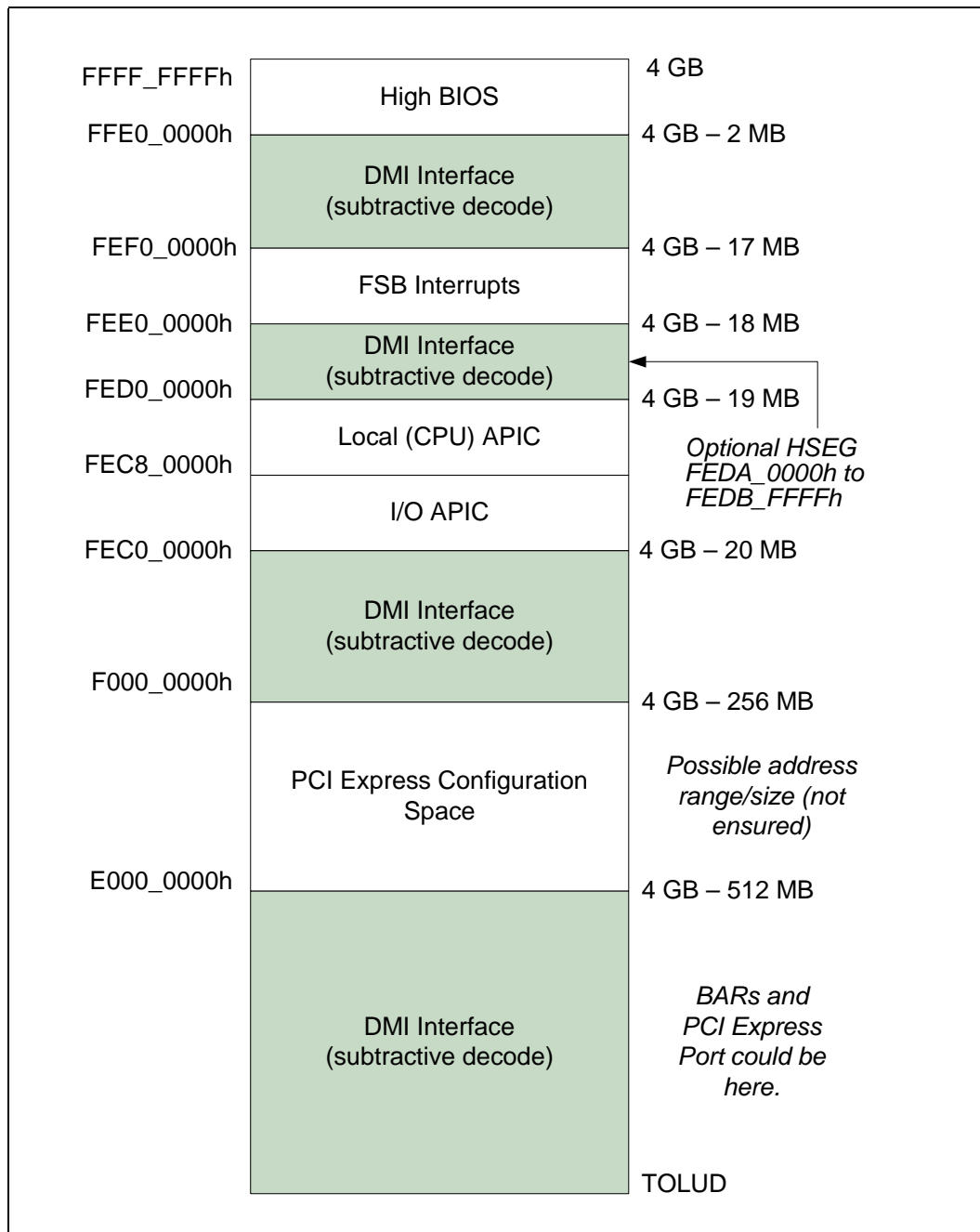



### 3.3.1 APIC Configuration Space (FEC0\_0000h–FECF\_FFFFh)

This range is reserved for APIC configuration space. The I/O APIC(s) usually reside in the ICH portion of the chipset.

The IOAPIC spaces are used to communicate with IOAPIC interrupt controllers that may be populated in the system. Since it is difficult to relocate an interrupt controller using plug-and-play software, fixed address decode regions have been allocated for them. Processor accesses to the default IOAPIC region (FEC0\_0000h to FEC7\_FFFFh) are always forwarded to DMI.

The MCH optionally supports additional I/O APICs behind the PCI Express port. When enabled via the PCI Express Configuration register (Device 1 Offset 200h), the PCI Express port will positively decode a subset of the APIC configuration space – specifically FEC8\_0000h thru FECF\_FFFFh. Memory request to this range would then be forwarded to the PCI Express port. When disabled, any access within entire APIC Configuration space (FEC0\_0000h to FECF\_FFFFh) is forwarded to DMI.

### 3.3.2 HSEG (FEDA\_0000h–FEDB\_FFFFh)

This optional segment from FEDA\_0000h to FEDB\_FFFFh provides a remapping window to SMM Memory. It is sometimes called the High SMM memory space. SMM-mode processor accesses to the optionally enabled HSEG are remapped to 000A\_0000h – 000B\_FFFFh. Non-SMM-mode processor accesses to enabled HSEG are considered invalid and are terminated immediately on the FSB. The exceptions to this rule are Non-SMM-mode Write Back cycles which are remapped to SMM space to maintain cache coherency. PCI Express and DMI originated cycles to enabled SMM space are not allowed. Physical DRAM behind the HSEG transaction address is not remapped and is not accessible. All cacheline writes with WB attribute or Implicit write backs to the HSEG range are completed to DRAM like an SMM cycle.

### 3.3.3 FSB Interrupt Memory Space (FEE0\_0000–FEEF\_FFFF)

The FSB Interrupt space is the address used to deliver interrupts to the FSB. Any device on PCI Express or DMI may issue a Memory Write to 0FEEx\_xxxxh. The MCH will forward this Memory Write along with the data to the FSB as an Interrupt Message Transaction. The MCH terminates the FSB transaction by providing the response and asserting HTRDYB. This Memory Write cycle does not go to DRAM.

### 3.3.4 High BIOS Area

The top 2 MB (FFE0\_0000h – FFFF\_FFFFh) of the PCI Memory Address Range is reserved for System BIOS (High BIOS), extended BIOS for PCI devices, and the A20 alias of the system BIOS. The processor begins execution from the High BIOS after reset. This region is mapped to DMI Interface so that the upper subset of this region aliases to 16 MB–256 KB range. The actual address space required for the BIOS is less than 2 MB but the minimum processor MTRR range for this region is 2 MB so that full 2 MB must be considered.



### 3.4 Main Memory Address Space (4 GB to TOUUD)

The MCH supports 36 bit addressing. The maximum main memory size supported is 8 GB total DRAM memory. A hole between TOLUD and 4 GB occurs when main memory size approaches 4 GB or larger. As a result, TOM, and TOUUD registers and RECLAIMBASE/RECLAIMLIMIT registers become relevant.

The new reclaim configuration registers exist to reclaim lost main memory space. The greater than 32 bit reclaim handling will be handled similar to other MCHs.

Upstream read and write accesses above 36-bit addressing will be treated as invalid cycles by PCI Express and DMI.

#### Top of Memory

The “Top of Memory” (TOM) register reflects the total amount of populated physical memory. This is NOT necessarily the highest main memory address (holes may exist in main memory address map due to addresses allocated for memory-mapped I/O above TOM). TOM is used to allocate the Intel Management Engine’s stolen memory. The Intel ME stolen size register reflects the total amount of physical memory stolen by the Intel ME. The ME stolen memory is located at the top of physical memory. The ME stolen memory base is calculated by subtracting the amount of memory stolen by the Intel ME from TOM.

The Top of Upper Usable Dram (TOUUD) register reflects the total amount of addressable DRAM. If reclaim is disabled, TOUUD will reflect TOM minus Intel ME stolen size. If reclaim is enabled, then it will reflect the reclaim limit. Also, the reclaim base will be the same as TOM minus ME stolen memory size to the nearest 64 MB alignment.

TOLUD register is restricted to 4 GB memory (A[31:20]), but the MCH can support up to 16 GB, limited by DRAM pins. For physical memory greater than 4 GB, the TOUUD register helps identify the address range in between the 4 GB boundary and the top of physical memory. This identifies memory that can be directly accessed (including reclaim address calculation) which is useful for memory access indication, early path indication, and trusted read indication. When reclaim is enabled, TOLUD must be 64 MB aligned, but when reclaim is disabled, TOLUD can be 1 MB aligned.

C1DRB3 cannot be used directly to determine the effective size of memory as the values programmed in the DRBs depend on the memory mode (stacked, interleaved). The Reclaim Base/Limit registers also can not be used because reclaim can be disabled. The CODRB3 register is used for memory channel identification (channel 0 vs. channel 1) in the case of stacked memory.



### 3.4.1 Memory Re-claim Background

The following are examples of Memory Mapped IO devices are typically located below 4 GB:

- High BIOS
- HSEG
- TSEG
- XAPIC
- Local APIC
- FSB Interrupts
- Mbase/Mlimit
- Memory Mapped IO space that supports only 32 B addressing

The MCH provides the capability to re-claim the physical memory overlapped by the Memory Mapped I/O logical address space. The MCH re-maps physical memory from the Top of Low Memory (TOLUD) boundary up to the 4 GB boundary to an equivalent sized logical address range located just below the Intel ME's stolen memory.

### 3.4.2 Memory Reclaiming

An incoming address (referred to as a logical address) is checked to see if it falls in the memory re-map window. The bottom of the re-map window is defined by the value in the RECLAIMBASE register. The top of the re-map window is defined by the value in the RECLAIMLIMIT register. An address that falls within this window is reclaimed to the physical memory starting at the address defined by the TOLUD register. The TOLUD register must be 64M aligned when RECLAIM is enabled, but can be 1M aligned when reclaim is disabled.

## 3.5 PCI Express\* Configuration Address Space

There is a device 0 register, PCIEXBAR, which defines the base address for the configuration space associated with all devices and functions that are potentially a part of the PCI Express root complex hierarchy. The size of this range will be programmable for the MCH. BIOS must assign this address range such that it will not conflict with any other address ranges.

See the configuration portion of this document for more details.



## 3.6 PCI Express\* Address Space

The MCH can be programmed to direct memory accesses to the PCI Express interface when addresses are within either of two ranges specified via registers in MCH's Device 1 configuration space.

- The first range is controlled via the Memory Base Register (MBASE) and Memory Limit Register (MLIMIT) registers.
- The second range is controlled via the Pre-fetchable Memory Base (PMBASE) and Pre-fetchable Memory Limit (PMLIMIT) registers.

Conceptually, address decoding for each range follows the same basic concept. The top 12 bits of the respective Memory Base and Memory Limit registers correspond to address bits A[31:20] of a memory address. For the purpose of address decoding, the MCH assumes that address bits A[19:0] of the memory base are zero and that address bits A[19:0] of the memory limit address are FFFFh. This forces each memory address range to be aligned to 1MB boundary and to have a size granularity of 1 MB.

The MCH positively decodes memory accesses to PCI Express memory address space as defined by the following equations:

$$\text{Memory\_Base\_Address} \leq \text{Address} \leq \text{Memory\_Limit\_Address}$$

$$\text{Prefetchable\_Memory\_Base\_Address} \leq \text{Address} \leq \text{Prefetchable\_Memory\_Limit\_Address}$$

The window size is programmed by the plug-and-play configuration software. The window size depends on the size of memory claimed by the PCI Express device. Normally these ranges will reside above the Top-of-Low Usable-DRAM and below High BIOS and APIC address ranges. They MUST reside above the top of low memory (TOLUD) if they reside below 4 GB and MUST reside above top of upper memory (TOUUD) if they reside above 4 GB or they will steal physical DRAM memory space.

It is essential to support a separate Pre-fetchable range in order to apply USWC attribute (from the processor point of view) to that range. The USWC attribute is used by the processor for write combining.

Note that the MCH Device 1 memory range registers described above are used to allocate memory address space for any PCI Express devices sitting on PCI Express that require such a window.

The PCICMD1 register can override the routing of memory accesses to PCI Express. In other words, the memory access enable bit must be set in the device 1 PCICMD1 register to enable the memory base/limit and pre-fetchable base/limit windows.

For the MCH, the upper PMUBASE1/PMULIMIT1 registers have been implemented for PCI Express Spec compliance. The MCH locates MMIO space above 4 GB using these registers.





## 3.7 System Management Mode (SMM)

System Management Mode uses main memory for System Management RAM (SMM RAM). The MCH supports: Compatible SMRAM (C\_SMRAM), High Segment (HSEG), and Top of Memory Segment (TSEG). System Management RAM space provides a memory area that is available for the SMI handlers and code and data storage. This memory resource is normally hidden from the system OS so that the processor has immediate access to this memory space upon entry to SMM. MCH provides three SMRAM options:

- Below 1 MB option that supports compatible SMI handlers.
- Above 1 MB option that allows new SMI handlers to execute with write-back cacheable SMRAM.
- Optional TSEG area of 1 MB, 2 MB, or 8 MB in size. The TSEG area lies below stolen memory.

The above 1 MB solutions require changes to compatible SMRAM handlers code to properly execute above 1 MB.

**Note:** DMI Interface and PCI Express masters are not allowed to access the SMM space.

### 3.7.1 SMM Space Definition

SMM space is defined by its **addressed** SMM space and its DRAM SMM space. The addressed SMM space is defined as the range of bus addresses used by the processor to access SMM space. DRAM SMM space is defined as the range of physical DRAM memory locations containing the SMM code. SMM space can be accessed at one of three transaction address ranges: Compatible, High, and TSEG. The Compatible and TSEG SMM space is not remapped and therefore the addressed and DRAM SMM space is the same address range. Since the High SMM space is remapped the addressed and DRAM SMM space is a different address range. Note that the High DRAM space is the same as the Compatible Transaction Address space. [Table 5](#) describes three unique address ranges.

- Compatible Transaction Address
- High Transaction Address
- TSEG Transaction Address

**Table 5. Transaction Address Ranges – Compatible, High, and TSEG**

SMM Space Enabled	Transaction Address Space	DRAM Space (DRAM)
Compatible	000A_0000h to 000B_FFFFh	000A_0000h to 000B_FFFFh
High	FEDA_0000h to FEDB_FFFFh	000A_0000h to 000B_FFFFh
TSEG	(TOLUD–STOLEN–TSEG) to TOLUD–STOLEN	(TOLUD–STOLEN–TSEG) to TOLUD–STOLEN



### 3.7.2 SMM Space Restrictions

If any of the following conditions are violated, the results of SMM accesses are unpredictable and may cause the system to hang:

1. The Compatible SMM space **must not** be set-up as cacheable.
2. High or TSEG SMM transaction address space **must not** overlap address space assigned to system DRAM, or to any "PCI" devices (including DMI Interface and PCI-Express). This is a BIOS responsibility.
3. Both D\_OPEN and D\_CLOSE **must not** be set to 1 at the same time.
4. When TSEG SMM space is enabled, the TSEG space **must not** be reported to the OS as available DRAM. This is a BIOS responsibility.
5. Any address translated through the GMADR TLB must not target DRAM from A\_0000–F\_FFFFh.

### 3.7.3 SMM Space Combinations

When High SMM is enabled (G\_SMRAME=1 and H\_SMRAM\_EN=1) the Compatible SMM space is effectively disabled. Processor originated accesses to the Compatible SMM space are forwarded to PCI Express; otherwise they are forwarded to the DMI Interface. PCI Express and DMI Interface originated accesses are **never** allowed to access SMM space.

Table 6. SMM Space Table

Global Enable G_SMRAME	High Enable H_SMRAM_EN	TSEG Enable TSEG_EN	Compatible (C) Range	High (H) Range	TSEG (T) Range
0	X	X	Disable	Disable	Disable
1	0	0	Enable	Disable	Disable
1	0	1	Enable	Disable	Enable
1	1	0	Disabled	Enable	Disable
1	1	1	Disabled	Enable	Enable



### 3.7.4 SMM Control Combinations

The G\_SMFRAME bit provides a global enable for all SMM memory. The D\_OPEN bit allows software to write to the SMM ranges without being in SMM mode. BIOS software can use this bit to initialize SMM code at powerup. The D\_LCK bit limits the SMM range access to only SMM mode accesses. The D\_CLS bit causes SMM (both CSEG and TSEG) data accesses to be forwarded to the DMI Interface or PCI Express. The SMM software can use this bit to write to video memory while running SMM code out of DRAM.

Table 7. SMM Control Table

G_SMFRAME	D_LCK	D_CLS	D_OPEN	Processor in SMM Mode	SMM Code Access	SMM Data Access
0	x	X	x	x	Disable	Disable
1	0	X	0	0	Disable	Disable
1	0	0	0	1	Enable	Enable
1	0	0	1	x	Enable	Enable
1	0	1	0	1	Enable	Disable
1	0	1	1	x	Invalid	Invalid
1	1	X	x	0	Disable	Disable
1	1	0	x	1	Enable	Enable
1	1	1	x	1	Enable	Disable

### 3.7.5 SMM Space Decode and Transaction Handling

Only the processor is allowed to access SMM space. PCI Express and DMI Interface originated transactions are not allowed to SMM space.

### 3.7.6 Processor WB Transaction to an Enabled SMM Address Space

Processor Writeback transactions (REQa[1]# = 0) to enabled SMM Address Space must be written to the associated SMM DRAM even though D\_OPEN=0 and the transaction is not performed in SMM mode. This ensures SMM space cache coherency when cacheable extended SMM space is used.

### 3.7.7 SMM Access Through TLB

Accesses through TLB address translation to enabled SMM DRAM space are not allowed. Writes will be routed to Memory address 000C\_0000h with byte enables de-asserted and reads will be routed to Memory address 000C\_0000h. If a TLB translated address hits enabled SMM DRAM space, an error is recorded.

PCI Express and DMI Interface originated accesses are **never** allowed to access SMM space directly or through the TLB address translation. If a TLB translated address hits enabled SMM DRAM space, an error is recorded.

PCI Express and DMI Interface write accesses through GMADR range will be snooped. Accesses to GMADR linear range (defined via fence registers) are supported. PCI Express and DMI Interface tileY and tileX writes to GMADR are not supported. If, when translated, the resulting physical address is to enabled SMM DRAM space, the request will be remapped to address 000C\_0000h with de-asserted byte enables.



PCI Express and DMI Interface read accesses to the GMADR range are not supported therefore will have no address translation concerns. PCI Express and DMI Interface reads to GMADR will be remapped to address 000C\_0000h. The read will complete with UR (unsupported request) completion status.

Fetches are always decoded (at fetch time) to ensure not in SMM (actually, anything above base of TSEG or 640 K–1 M). Thus, they will be invalid and go to address 000C\_0000h, but that isn't specific to PCI Express or DMI; it applies to processor. Also, since the GMADR snoop would not be directly to the SMM space, there wouldn't be a writeback to SMM. In fact, the writeback would also be invalid (because it uses the same translation) and go to address 000C\_0000h.

### 3.8 Memory Shadowing

Any block of memory that can be designated as read-only or write-only can be "shadowed" into MCH DRAM memory. Typically this is done to allow ROM code to execute more rapidly out of main DRAM. ROM is used as a read-only during the copy process while DRAM at the same time is designated write-only. After copying, the DRAM is designated read-only so that ROM is shadowed. Processor bus transactions are routed accordingly.

### 3.9 I/O Address Space

The MCH does not support the existence of any other I/O devices beside itself on the processor bus. The MCH generates either DMI Interface or PCI Express bus cycles for all processor I/O accesses that it does not claim. Within the host bridge, the MCH contains two internal registers in the processor I/O space, Configuration Address Register (CONFIG\_ADDRESS) and the Configuration Data Register (CONFIG\_DATA). These locations are used to implement configuration space access mechanism.

The processor allows 64 K+3 bytes to be addressed within the I/O space. The MCH propagates the processor I/O address without any translation on to the destination bus and therefore provides addressability for 64K+3 byte locations. Note that the upper 3 locations can be accessed only during I/O address wrap-around when processor bus HAB\_16 address signal is asserted. HAB\_16 is asserted on the processor bus whenever an I/O access is made to 4 bytes from address 0FFFDh, 0FFFEh, or 0FFFFh. HAB\_16 is also asserted when an I/O access is made to 2 bytes from address 0FFFFh.

The I/O accesses (other than ones used for configuration space access) are forwarded normally to the DMI Interface bus unless they fall within the PCI Express I/O address range as defined by the mechanisms explained below. I/O writes are NOT posted. Memory writes to ICH or PCI Express are posted. The PCICMD1 register can disable the routing of I/O cycles to the PCI Express.

The MCH responds to I/O cycles initiated on PCI Express or DMI with an UR status. Upstream I/O cycles and configuration cycles should never occur. If one does occur, the request will route as a read to Memory address 000C\_0000h so a completion is naturally generated (whether the original request was a read or write). The transaction will complete with an UR completion status.

I/O reads that lie within 8-byte boundaries but cross 4-byte boundaries are issued from the processor as 1 transaction. The MCH will break this into 2 separate transactions. I/O writes that lie within 8-byte boundaries but cross 4-byte boundaries are assumed to be split into 2 transactions by the processor.



### 3.9.1 PCI Express\* I/O Address Mapping

The MCH can be programmed to direct non-memory (I/O) accesses to the PCI Express bus interface when processor initiated I/O cycle addresses are within the PCI Express I/O address range. This range is controlled via the I/O Base Address (IOBASE) and I/O Limit Address (IOLIMIT) registers in MCH Device 1 configuration space.

Address decoding for this range is based on the following concept. The top 4 bits of the respective I/O Base and I/O Limit registers correspond to address bits A[15:12] of an I/O address. For the purpose of address decoding, the MCH assumes that lower 12 address bits A[11:0] of the I/O base are zero and that address bits A[11:0] of the I/O limit address are FFFh. This forces the I/O address range alignment to 4 KB boundary and produces a size granularity of 4 KB.

The MCH positively decodes I/O accesses to PCI Express I/O address space as defined by the following equation:

$$\text{I/O\_Base\_Address} \leq \text{Processor I/O Cycle Address} \leq \text{I/O\_Limit\_Address}$$

The effective size of the range is programmed by the plug-and-play configuration software and it depends on the size of I/O space claimed by the PCI Express device.

Note that the MCH Device 1 and/or Device 6 I/O address range registers defined above are used for all I/O space allocation for any devices requiring such a window on PCI Express.

The PCICMD1 register can disable the routing of I/O cycles to PCI Express.







## 4 MCH Register Description

---

The MCH contains two sets of software accessible registers, accessed via the Host processor I/O address space: Control registers and internal configuration registers.

- Control registers are I/O mapped into the processor I/O space, which control access to PCI and PCI Express configuration space (see [Chapter 6](#)).
- Internal configuration registers residing within the MCH are partitioned into two logical device register sets (“logical” since they reside within a single physical device). The first register set is dedicated to Host Bridge functionality (i.e., DRAM configuration, other chipset operating parameters and optional features). The second register block is dedicated to Host-to-PCI Express Bridge functions (controls PCI Express interface configurations and operating parameters).

The MCH internal registers (I/O Mapped, Configuration and PCI Express Extended Configuration registers) are accessible by the processor. The registers that reside within the lower 256 bytes of each device can be accessed as Byte, Word (16-bit), or DWord (32-bit) quantities, with the exception of CONFIG\_ADDRESS, which can only be accessed as a DWord. All multi-byte numeric fields use “little-endian” ordering (i.e., lower addresses contain the least significant parts of the field). Registers that reside in bytes 256 through 4095 of each device may only be accessed using memory-mapped transactions in DWord (32-bit) quantities.

Some of the MCH registers described in this section contain reserved bits. These bits are labeled “Reserved”. Software must deal correctly with fields that are reserved. On reads, software must use appropriate masks to extract the defined bits and not rely on reserved bits being any particular value. On writes, software must ensure that the values of reserved bit positions are preserved. That is, the values of reserved bit positions must first be read, merged with the new values for other bit positions and then written back. Note the software does not need to perform read, merge, and write operation for the Configuration Address Register.

In addition to reserved bits within a register, the MCH contains address locations in the configuration space of the Host Bridge entity that are marked either “Reserved” or “Intel Reserved”. The MCH responds to accesses to “Reserved” address locations by completing the host cycle. When a “Reserved” register location is read, a zero value is returned. (“Reserved” registers can be 8-, 16-, or 32-bits in size). Writes to “Reserved” registers have no effect on the MCH. Registers that are marked as “Intel Reserved” must not be modified by system software. Writes to “Intel Reserved” registers may cause system failure. Reads from “Intel Reserved” registers may return a non-zero value.

Upon a Full Reset, the MCH sets its entire set of internal configuration registers to predetermined default states. Some register values at reset are determined by external strapping options. The default state represents the minimum functionality feature set required to successfully bringing up the system. Hence, it does not represent the optimal system configuration. It is the responsibility of the system initialization software (usually BIOS) to properly determine the DRAM configurations, operating parameters and optional system features that are applicable, and to program the MCH registers accordingly.



## 4.1 Register Terminology

The following table shows the register-related terminology that is used.

Item	Description
RO	Read Only bit(s). Writes to these bits have no effect.
RO/S	Read Only / Sticky. Writes to these bits have no effect. These are status bits only. Bits are not returned to their default values by "warm" reset, but will be reset with a cold/complete reset (for PCI Express related bits, a cold reset is "Power Good Reset" as defined in the PCI Express specification).
RS/WC	Read Set / Write Clear bit(s). These bits are set to '1' when read and then will continue to remain set until written. A write of '1' clears (sets to '0') the corresponding bit(s) and a write of '0' has no effect.
R/W	Read / Write bit(s). These bits can be read and written.
R/WC	Read / Write Clear bit(s). These bits can be read. Internal events may set this bit. A write of '1' clears (sets to '0') the corresponding bit(s) and a write of '0' has no effect.
R/WC/S	Read / Write Clear / Sticky bit(s). These bits can be read. Internal events may set this bit. A write of '1' clears (sets to '0') the corresponding bit(s) and a write of '0' has no effect. Bits are not cleared by "warm" reset, but will be reset with a cold/complete reset (for PCI Express related bits a cold reset is "Power Good Reset" as defined in the <i>PCI Express Specification</i> ).
R/W/L	Read / Write / Lockable bit(s). These bits can be read and written. Additionally, there is a bit (which may or may not be a bit marked R/W/L) that, when set, prohibits this bit field from being writeable (bit field becomes Read Only).
R/W/K	Read / Write / Key bit(s). These bits can be read and written by software. Additionally this bit when set, prohibits some other bit field(s) from being writeable (bit fields become Read Only).
R/W/L	Read / Write / Lockable bit(s). These bits can be read and written. Additionally there is a bit (which may or may not be a bit marked R/W/L) that, when set, prohibits this bit field from being writeable (bit field becomes Read Only).
R/W/S	Read / Write / Sticky bit(s). These bits can be read and written. Bits are not cleared by "warm" reset, but will be reset with a cold/complete reset (for PCI Express related bits a cold reset is "Power Good Reset" as defined in the <i>PCI Express Specification</i> ).
R/WSC	Read / Write Self Clear bit(s). These bits can be read and written. When the bit is '1', hardware may clear the bit to '0' based upon internal events, possibly sooner than any subsequent read could retrieve a '1'.
R/WSC/L	Read / Write Self Clear / Lockable bit(s). These bits can be read and written. When the bit is '1', hardware may clear the bit to '0' based upon internal events, possibly sooner than any subsequent read could retrieve a '1'. Additionally there is a bit (which may or may not be a bit marked R/W/L) that, when set, prohibits this bit field from being writeable (bit field becomes Read Only).
R/WO	Write Once bit(s). Once written, bits with this attribute become Read Only. These bits can only be cleared by a Reset.
W	Write Only. Whose bits may be written, but will always-return zeros when read. They are used for write side effects. Any data written to these registers cannot be retrieved.





## 4.2 Configuration Process and Registers

### 4.2.1 Platform Configuration Structure

The DMI physically connects the MCH and the Intel ICH9; thus, from a configuration standpoint, the DMI is logically PCI bus 0. As a result, all devices internal to the MCH and the ICH appear to be on PCI bus 0.

**Note:** The ICH9 internal LAN controller does not appear on bus 0 – it appears on the external PCI bus and this number is configurable.

The system’s primary PCI expansion bus is physically attached to the ICH and from a configuration perspective, appears to be a hierarchical PCI bus behind a PCI-to-PCI bridge; therefore, it has a programmable PCI Bus number. The PCI Express interface appears to system software to be a real PCI bus behind a PCI-to-PCI bridge that is a device resident on PCI bus 0.

**Note:** A physical PCI bus 0 does not exist; DMI and the internal devices in the MCH and ICH logically constitute PCI Bus 0 to configuration software (see [Figure 8](#)).

**Figure 8. Conceptual Platform PCI Configuration Diagram**

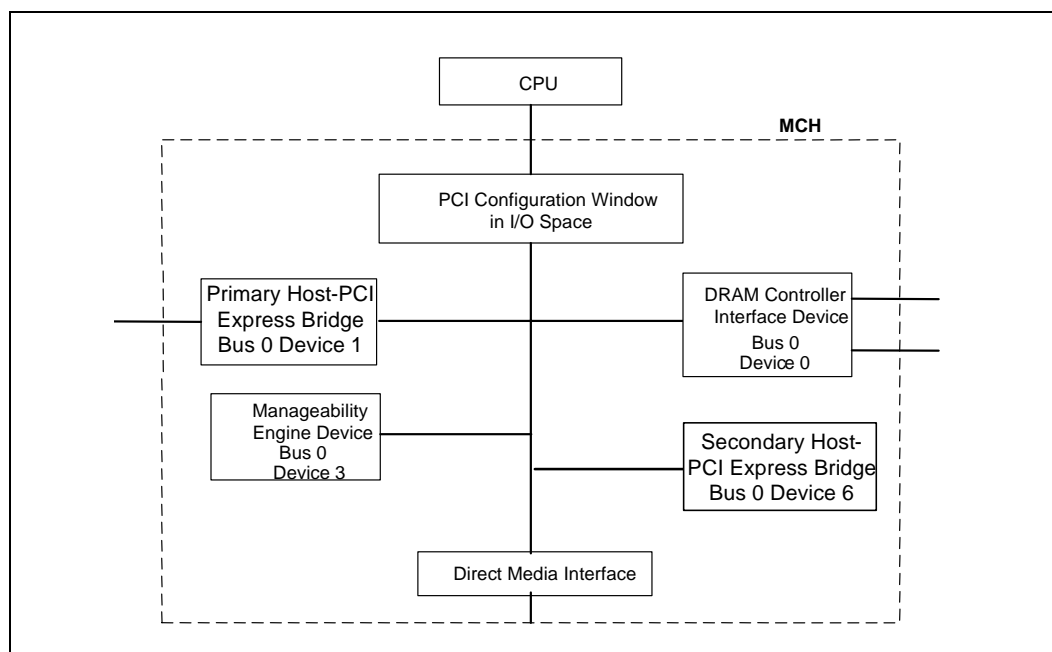



The MCH contains four PCI devices within a single physical component. The configuration registers for the four devices are mapped as devices residing on PCI bus 0.

- **Device 0: Host Bridge/DRAM Controller.** Logically this appears as a PCI device residing on PCI bus 0. Device 0 contains the standard PCI header registers, PCI Express base address register, DRAM control (including thermal/throttling control), and configuration for the DMI and other MCH specific registers.
- **Device 1: Primary Host-PCI Express Bridge.** Logically this appears as a “virtual” PCI-to-PCI bridge residing on PCI bus 0 and is compliant with *PCI Express Specification* Rev 1.0. Device 1 contains the standard PCI-to-PCI bridge registers and the standard PCI Express/PCI configuration registers (including the PCI Express memory address mapping). It also contains Isochronous and Virtual Channel controls in the PCI Express extended configuration space.
- **Device 3: Manageability Engine Device.** Logically, this appears as a PCI device residing on PCI bus 0. Physically, device 3.
- **Device 6: Secondary Host-PCI Express Bridge (Intel 3210 MCH only).** Logically this appears as a “virtual” PCI-to-PCI bridge residing on PCI bus 0 and is compliant with *PCI Express Specification* Rev 1.0. Device 6 contains the standard PCI-to-PCI bridge registers and the standard PCI Express/PCI configuration registers (including the PCI Express memory address mapping). It also contains Isochronous and Virtual Channel controls in the PCI Express extended configuration space.

## 4.3 Configuration Mechanisms

The processor is the originator of configuration cycles so the FSB is the only interface in the platform where these mechanisms are used. The MCH translates transactions received through both configuration mechanisms to the same format.

### 4.3.1 Standard PCI Configuration Mechanism

The following is the mechanism for translating processor I/O bus cycles to configuration cycles.

The PCI specification defines a slot based “configuration space” that allows each device to contain up to 8 functions with each function containing up to 256 8-bit configuration registers. The PCI specification defines two bus cycles to access the PCI configuration space: Configuration Read and Configuration Write. Memory and I/O spaces are supported directly by the processor. Configuration space is supported by a mapping mechanism implemented within the MCH.

The configuration access mechanism makes use of the CONFIG\_ADDRESS Register (at I/O address 0CF8h though 0CFBh) and CONFIG\_DATA Register (at I/O address 0CFCh though 0CFFh). To reference a configuration register a DW I/O write cycle is used to place a value into CONFIG\_ADDRESS that specifies the PCI bus, the device on that bus, the function within the device and a specific configuration register of the device function being accessed. CONFIG\_ADDRESS[31] must be 1 to enable a configuration cycle. CONFIG\_DATA then becomes a window into the four bytes of configuration space specified by the contents of CONFIG\_ADDRESS. Any read or write to CONFIG\_DATA will result in the MCH translating the CONFIG\_ADDRESS into the appropriate configuration cycle.



The MCH is responsible for translating and routing the processor's I/O accesses to the CONFIG\_ADDRESS and CONFIG\_DATA registers to internal MCH configuration registers, DMI or PCI Express.

### 4.3.2 PCI Express Enhanced Configuration Mechanism

PCI Express extends the configuration space to 4096 bytes per device/function as compared to 256 bytes allowed by PCI Specification Revision 2.3. PCI Express configuration space is divided into a PCI 2.3 compatible region, which consists of the first 256B of a logical device's configuration space and a PCI Express extended region, which consists of the remaining configuration space.

The PCI compatible region can be accessed using either the Standard PCI Configuration Mechanism or using the PCI Express Enhanced Configuration Mechanism described in this section. The extended configuration registers may only be accessed using the PCI Express Enhanced Configuration Mechanism. To maintain compatibility with PCI configuration addressing mechanisms, system software must access the extended configuration space using 32-bit operations (32-bit aligned) only. These 32-bit operations include byte enables allowing only appropriate bytes within the DWord to be accessed. Locked transactions to the PCI Express memory mapped configuration address space are not supported. All changes made using either access mechanism are equivalent.

The PCI Express Enhanced Configuration Mechanism utilizes a flat memory-mapped address space to access device configuration registers. This address space is reported by the system firmware to the operating system. There is a register, PCIEXBAR, that defines the base address for the block of addresses below 4 GB for the configuration space associated with busses, devices and functions that are potentially a part of the PCI Express root complex hierarchy. In the PCIEXBAR register there exists controls to limit the size of this reserved memory mapped space. 256 MB is the amount of address space required to reserve space for every bus, device, and function that could possibly exist. Options for 128 MB and 64 MB exist in order to free up those addresses for other uses. In these cases the number of busses and all of their associated devices and functions are limited to 128 or 64 busses respectively.

The PCI Express Configuration Transaction Header includes an additional 4 bits (ExtendedRegisterAddress[3:0]) between the Function Number and Register Address fields to provide indexing into the 4 KB of configuration space allocated to each potential device. For PCI Compatible Configuration Requests, the Extended Register Address field must be all zeros.

Figure 9. Memory Map to PCI Express Device Configuration Space

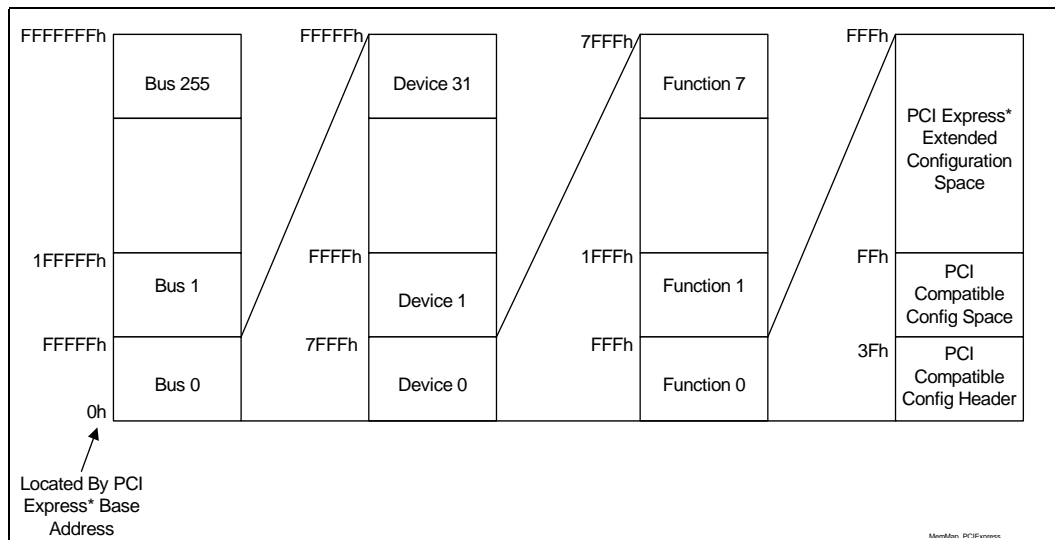

As with PCI devices, each device is selected based on decoded address information that is provided as a part of the address portion of Configuration Request packets. A PCI Express device will decode all address information fields (bus, device, function and extended address numbers) to provide access to the correct register.

To access this space (steps 1, 2, 3 are done only once by BIOS),

1. Use the PCI compatible configuration mechanism to enable the PCI Express enhanced configuration mechanism by writing 1 to bit 0 of the PCIEXBAR register.
2. Use the PCI compatible configuration mechanism to write an appropriate PCI Express base address into the PCIEXBAR register.
3. Calculate the host address of the register you wish to set using (PCI Express base + (bus number \* 1 MB) + (device number \* 32KB) + (function number \* 4 KB) + (1 B \* offset within the function) = host address).
4. Use a memory write or memory read cycle to the calculated host address to write or read that register.

## 4.4 Routing Configuration Accesses

The MCH supports two PCI related interfaces: DMI and PCI Express. The MCH is responsible for routing PCI and PCI Express configuration cycles to the appropriate device that is an integrated part of the MCH or to one of these two interfaces. Configuration cycles to the ICH internal devices and Primary PCI (including downstream devices) are routed to the ICH via DMI. Configuration cycles to the PCI Express PCI compatibility configuration space are routed to the PCI Express port device or associated link.



Figure 10. MCH Configuration Cycle Flow Chart

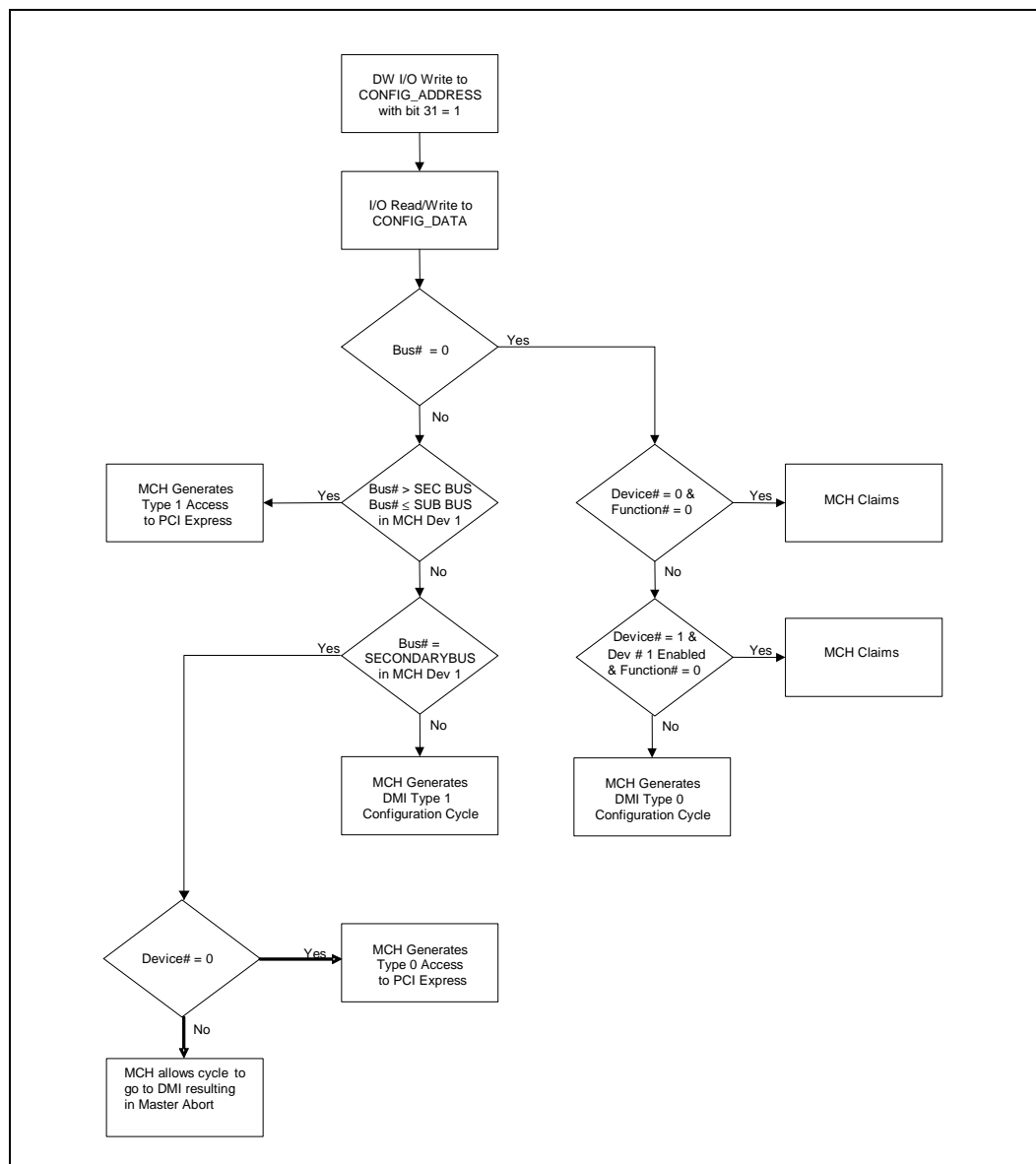

### 4.4.1 Internal Device Configuration Accesses

The MCH decodes the Bus Number (bits 23: 16) and the Device Number fields of the CONFIG\_ADDRESS register. If the Bus Number field of CONFIG\_ADDRESS is 0 the configuration cycle is targeting a PCI Bus #0 device.

If the targeted PCI Bus 0 device exists in the MCH and is not disabled, the configuration cycle is claimed by the appropriate device.



## 4.4.2 Bridge Related Configuration Accesses

Configuration accesses on PCI Express or DMI are PCI Express Configuration TLPs (Transaction Layer Packets):

- Bus Number [7:0] is Header Byte 8 [7:0]
- Device Number [4:0] is Header Byte 9 [7:3]
- Function Number [2:0] is Header Byte 9 [2:0]

And special fields for this type of TLP:

- Extended Register Number [3:0] is Header Byte 10 [3:0]
- Register Number [5:0] is Header Byte 11 [7:2]

See the PCI Express specification for more information on both the PCI 2.3 compatible and PCI Express Enhanced Configuration Mechanism and transaction rules.

### 4.4.2.1 PCI Express Configuration Accesses

When the Bus Number of a type 1 Standard PCI Configuration cycle or PCI Express Enhanced Configuration access matches the Device 1 Secondary Bus Number a PCI Express Type 0 Configuration TLP is generated on the PCI Express link targeting the device directly on the opposite side of the link. This should be Device 0 on the bus number assigned to the PCI Express link (likely Bus 1).

The device on other side of link must be Device 0. The MCH will Master Abort any Type 0 Configuration access to a non-zero Device number. If there is to be more than one device on that side of the link there must be a bridge implemented in the downstream device.

When the Bus Number of a type 1 Standard PCI Configuration cycle or PCI Express Enhanced Configuration access is within the claimed range (between the upper bound of the bridge device's Subordinate Bus Number register and the lower bound of the bridge device's Secondary Bus Number register) but does not match the Device 1 Secondary Bus Number, a PCI Express Type 1 Configuration TLP is generated on the secondary side of the PCI Express link.

PCI Express Configuration Writes:

- Internally the host interface unit will translate writes to PCI Express extended configuration space to configuration writes on the backbone.
- Writes to extended space are posted on the FSB, but non-posted on the PCI Express or DMI (i.e., translated to config writes)

### 4.4.2.2 DMI Configuration Accesses

Accesses to disabled MCH internal devices, bus numbers not claimed by the Host-PCI Express bridge, or PCI Bus #0 devices not part of the MCH will subtractively decode to the ICH and consequently be forwarded over the DMI via a PCI Express configuration TLP.

If the Bus Number is zero, the MCH will generate a Type 0 Configuration Cycle TLP on DMI. If the Bus Number is non-zero, and falls outside the range claimed by the Host-PCI Express bridge, the MCH will generate a Type 1 Configuration Cycle TLP on DMI.

The ICH routes configurations accesses in a manner similar to the MCH. The ICH decodes the configuration TLP and generates a corresponding configuration access. Accesses targeting a device on PCI Bus #0 may be claimed by an internal device. The ICH compares the non-zero Bus Number with the Secondary Bus Number and



Subordinate Bus Number registers of its PCI-to-PCI bridges to determine if the configuration access is meant for Primary PCI, or some other downstream PCI bus or PCI Express link.

Configuration accesses that are forwarded to the ICH9, but remain unclaimed by any device or bridge will result in a master abort.

## 4.5 I/O Mapped Registers

The MCH contains two registers that reside in the processor I/O address space –the Configuration Address (CONFIG\_ADDRESS) Register and the Configuration Data (CONFIG\_DATA) Register. The Configuration Address Register enables/disables the configuration space and determines what portion of configuration space is visible through the Configuration Data window.

### 4.5.1 CONFIG\_ADDRESS—Configuration Address Register

I/O Address: 0CF8h Accessed as a DW  
 Default Value: 00000000h  
 Access: R/W  
 Size: 32 bits

CONFIG\_ADDRESS is a 32-bit register that can be accessed only as a DW. A Byte or Word reference will "pass through" the Configuration Address Register and DMI onto the Primary PCI bus as an I/O cycle. The CONFIG\_ADDRESS register contains the Bus Number, Device Number, Function Number, and Register Number for which a subsequent configuration access is intended.

Bit	Access & Default	Description
31	R/W 0b	<b>Configuration Enable (CFGE):</b> 0 = Disable 1 = Enable.
30:24		<b>Reserved</b>
23:16	R/W 00h	<b>Bus Number:</b> If the Bus Number is programmed to 00h the target of the Configuration Cycle is a PCI Bus 0 agent. If this is the case and the MCH is not the target (i.e., the device number is $\geq 2$ ), then a DMI Type 0 Configuration Cycle is generated. If the Bus Number is non-zero and does not fall within the ranges enumerated by device 1's Secondary Bus Number or Subordinate Bus Number Register, then a DMI Type 1 Configuration Cycle is generated. If the Bus Number is non-zero and matches the value programmed into the Secondary Bus Number Register of device 1, a Type 0 PCI configuration cycle will be generated on PCI Express. If the Bus Number is non-zero, greater than the value in the Secondary Bus Number register of device 1 and less than or equal to the value programmed into the Subordinate Bus Number Register of device 1 a Type 1 PCI configuration cycle will be generated on PCI Express. This field is mapped to byte 8 [7:0] of the request header format during PCI Express Configuration cycles and A[23:16] during the DMI Type 1 configuration cycles.



Bit	Access & Default	Description
15:11	R/W 00h	<b>Device Number:</b> This field selects one agent on the PCI bus selected by the Bus Number. When the Bus Number field is "00" the MCH decodes the Device Number field. The MCH is always Device Number 0 for the Host bridge entity, Device Number 1 for the Host-PCI Express entity. Therefore, when the Bus Number =0 and the Device Number equals 0, 1, or 2 the internal MCH devices are selected. This field is mapped to byte 6 [7:3] of the request header format during PCI Express Configuration cycles and A [15:11] during the DMI configuration cycles.
10:8	R/W 000b	<b>Function Number:</b> This field allows the configuration registers of a particular function in a multi-function device to be accessed. The MCH ignores configuration cycles to its internal devices if the function number is not equal to 0 or 1. This field is mapped to byte 6 [2:0] of the request header format during PCI Express Configuration cycles and A[10:8] during the DMI configuration cycles.
7:2	R/W 00h	<b>Register Number:</b> This field selects one register within a particular Bus, Device, and Function as specified by the other fields in the Configuration Address Register. This field is mapped to byte 7 [7:2] of the request header format during PCI Express Configuration cycles and A[7:2] during the DMI Configuration cycles.
1:0		Reserved

#### 4.5.2 CONFIG\_DATA—Configuration Data Register

I/O Address: 0CFCh  
 Default Value: 00000000h  
 Access: R/W  
 Size: 32 bits

CONFIG\_DATA is a 32-bit read/write window into configuration space. The portion of configuration space that is referenced by CONFIG\_DATA is determined by the contents of CONFIG\_ADDRESS.

Bit	Access & Default	Description
31:0	R/W 0000 0000 h	<b>Configuration Data Window (CDW):</b> If bit 31 of CONFIG_ADDRESS is 1, any I/O access to the CONFIG_DATA register will produce a configuration transaction using the contents of CONFIG_ADDRESS to determine the bus, device, function, and offset of the register to be accessed.

§





## 5 DRAM Controller Registers (D0:F0)

The DRAM Controller registers are in Device 0 (D0), Function 0 (F0).

**Warning:** Address locations that are not listed are considered Intel Reserved registers locations. Reads to Reserved registers may return non-zero values. Writes to reserved locations may cause system failures.

All registers that are defined in the PCI 2.3 specification, but are not necessary or implemented in this component are simply not included in this document. The reserved/unimplemented space in the PCI configuration header space is not documented as such in this summary.

**Table 8. DRAM Controller Register Address Map**

Address Offset	Register Symbol	Register Name	Default Value	Access
0–1h	VID	Vendor Identification	8086h	RO
2–3h	DID	Device Identification	29F0h	RO
4–5h	PCICMD	PCI Command	0006h	RO, RW
6–7h	PCISTS	PCI Status	0090h	RO, RWC
8h	RID	Revision Identification	see register description	RO
9–Bh	CC	Class Code	060000h	RO
Dh	MLT	Master Latency Timer	00h	RO
Eh	HDR	Header Type	00h	RO
2C–2Dh	SVID	Subsystem Vendor Identification	0000h	RWO
2E–2Fh	SID	Subsystem Identification	0000h	RWO
34h	CAPPTR	Capabilities Pointer	E0h	RO
40–47h	PXPEPBAR	PCI Express Egress Port Base Address	0000000000 000000h	RO, RW/L
48–4Fh	MCHBAR	MCH Memory Mapped Register Range Base	0000000000 000000h	RO, RW/L
54–57h	DEVEN	Device Enable	000023DBh	RO, RW/L
60–67h	PCIEXBAR	PCI Express Register Range Base Address	00000000E0 000000h	RO, RW/L, RW/L/K
68–6Fh	DMIBAR	Root Complex Register Range Base Address	0000000000 000000h	RO, RW/L
90h	PAM0	Programmable Attribute Map 0	00h	RO, RW/L
91h	PAM1	Programmable Attribute Map 1	00h	RO, RW/L
92h	PAM2	Programmable Attribute Map 2	00h	RO, RW/L
93h	PAM3	Programmable Attribute Map 3	00h	RO, RW/L
94h	PAM4	Programmable Attribute Map 4	00h	RO, RW/L



**Table 8. DRAM Controller Register Address Map**

Address Offset	Register Symbol	Register Name	Default Value	Access
95h	PAM5	Programmable Attribute Map 5	00h	RO, RW/L
96h	PAM6	Programmable Attribute Map 6	00h	RO, RW/L
97h	LAC	Legacy Access Control	00h	RW, RW/L, RO
98–99h	REMAPBASE	Remap Base Address Register	03FFh	RO, RW/L
9A–9Bh	REMAPLIMIT	Remap Limit Address Register	0000h	RO, RW/L
9Dh	SMRAM	System Management RAM Control	02h	RO, RW/L, RW, RW/L/K
9Eh	ESMRAMC	Extended System Management RAM Control	38h	RW/L, RWC, RO
A0–A1h	TOM	Top of Memory	0001h	RO, RW/L
A2–A3h	TOUUD	Top of Upper Usable Dram	0000h	RW/L
A4–A7h	BSM	Base of Stolen Memory	00000000h	RW/L, RO
AC–AFh	TSEGMB	TSEG Memory Base	00000000h	RO, RW/L
B0–B1h	TOLUD	Top of Low Usable DRAM	0010h	RW/L, RO
C8–C9h	ERRSTS	Error Status	0000h	RWC/S, RO
CA–CBh	ERRCMD	Error Command	0000h	RW, RO
CC–CDh	SMICMD	SMI Command	0000h	RO, RW
DC–DFh	SKPD	Scratchpad Data	00000000h	RW
E0–EBh	CAPID0	Capability Identifier	00000001C1 064000010C 0009h	RO



## 5.1 Configuration Register Details

### 5.1.1 VID—Vendor Identification

B/D/F/Type: 0/0/0/PCI  
 Address Offset: 0–1h  
 Default Value: 8086h  
 Access: RO  
 Size: 16 bits

This register combined with the Device Identification register uniquely identifies any PCI device.

Bit	Access	Default Value	Description
15:0	RO	8086h	<b>Vendor Identification Number (VID):</b> PCI standard identification for Intel.

### 5.1.2 DID—Device Identification

B/D/F/Type: 0/0/0/PCI  
 Address Offset: 2–3h  
 Default Value: 29F0h  
 Access: RO  
 Size: 16 bits

This register combined with the Vendor Identification register uniquely identifies any PCI device.

Bit	Access	Default Value	Description
15:0	RO	29F0h	<b>Device Identification Number (DID):</b> This field identifier assigned to the MCH core/primary PCI device.



### 5.1.3 PCICMD—PCI Command

B/D/F/Type: 0/0/0/PCI  
 Address Offset: 4–5h  
 Default Value: 0006h  
 Access: RO, RW  
 Size: 16 bits

Since MCH Device 0 does not physically reside on PCI\_A many of the bits are not implemented.

Bit	Access	Default Value	Description
15:9	RO	00h	Reserved
8	RW	0b	<p><b>SERR Enable (SERRE):</b> This bit is a global enable bit for Device 0 (and Device 6 for the 3210 MCH) SERR messaging. The MCH does not have an SERR signal. The MCH communicates the SERR condition by sending an SERR message over DMI to the ICH.</p> <p>1 = The MCH is enabled to generate SERR messages over DMI for specific Device 0 error conditions that are individually enabled in the ERRCMD and DMIUEMSK registers. The error status is reported in the ERRSTS, PCISTS, and DMIUEST registers.</p> <p>0 = The SERR message is not generated by the MCH for Device 0.</p> <p>Note that this bit only controls SERR messaging for the Device 0. Device 1 has its own SERRE bits to control error reporting for error conditions occurring in that device. The control bits are used in a logical OR manner to enable the SERR DMI message mechanism.</p>
7	RO	0b	<p><b>Address/Data Stepping Enable (ADSTEP):</b> Address/data stepping is not implemented in the MCH, and this bit is hardwired to 0. Writes to this bit position have no effect.</p>
6	RW	0b	<p><b>Parity Error Enable (PERRE):</b> Controls whether or not the Master Data Parity Error bit in the PCI Status register can be set.</p> <p>0 = Master Data Parity Error bit in PCI Status register can NOT be set.</p> <p>1 = Master Data Parity Error bit in PCI Status register CAN be set.</p>
5	RO	0b	Reserved
4	RO	0b	<p><b>Memory Write and Invalidate Enable (MWIE):</b> The MCH will never issue memory write and invalidate commands. This bit is therefore hardwired to 0. Writes to this bit position will have no effect.</p>
3	RO	0b	Reserved
2	RO	1b	<p><b>Bus Master Enable (BME):</b> The MCH is always enabled as a master on the backbone. This bit is hardwired to a "1". Writes to this bit position have no effect.</p>
1	RO	1b	<p><b>Memory Access Enable (MAE):</b> The MCH always allows access to main memory. This bit is not implemented and is hardwired to 1. Writes to this bit position have no effect.</p>
0	RO	0b	<p><b>I/O Access Enable (IOAE):</b> This bit is not implemented in the MCH and is hardwired to a 0. Writes to this bit position have no effect.</p>



### 5.1.4 PCISTS—PCI Status

B/D/F/Type: 0/0/0/PCI  
 Address Offset: 6–7h  
 Default Value: 0090h  
 Access: RO, RWC  
 Size: 16 bits

This status register reports the occurrence of error events on Device 0's PCI interface. Since the MCH Device 0 does not physically reside on PCI\_A many of the bits are not implemented.

Bit	Access	Default Value	Description
15	RWC	0b	<b>Detected Parity Error (DPE):</b> This bit is set when this Device receives a Poisoned TLP.
14	RWC	0b	<b>Signaled System Error (SSE):</b> This bit is set to 1 when the MCH Device 0 generates an SERR message over DMI for any enabled Device 0 error condition. Device 0 error conditions are enabled in the PCICMD, ERRCMD, and DMIUEMSK registers. Device 0 error flags are read/reset from the PCISTS, ERRSTS, or DMIUEST registers. Software clears this bit by writing a 1 to it.
13	RWC	0b	<b>Received Master Abort Status (RMAS):</b> This bit is set when the MCH generates a DMI request that receives an Unsupported Request completion packet. Software clears this bit by writing a 1 to it.
12	RWC	0b	<b>Received Target Abort Status (RTAS):</b> This bit is set when the MCH generates a DMI request that receives a Completer Abort completion packet. Software clears this bit by writing a 1 to it.
11	RO	0b	<b>Signaled Target Abort Status (STAS):</b> The MCH will not generate a Target Abort DMI completion packet or Special Cycle. This bit is not implemented in the MCH and is hardwired to a 0. Writes to this bit position have no effect.
10:9	RO	00b	<b>DEVSEL Timing (DEVT):</b> These bits are hardwired to "00". Writes to these bit positions have no affect. Device 0 does not physically connect to PCI_A. These bits are set to "00" (fast decode) so that optimum DEVSEL timing for PCI_A is not limited by the MCH.
8	RWC	0b	<b>Master Data Parity Error Detected (DPD):</b> This bit is set when DMI received a Poisoned completion from ICH. This bit can only be set when the Parity Error Enable bit in the PCI Command register is set.
7	RO	1b	<b>Fast Back-to-Back (FB2B):</b> This bit is hardwired to 1. Writes to these bit positions have no effect. Device 0 does not physically connect to PCI_A. This bit is set to 1 (indicating fast back-to-back capability) so that the optimum setting for PCI_A is not limited by the MCH.
6	RO	0b	Reserved
5	RO	0b	<b>66 MHz Capable:</b> Does not apply to PCI Express. Hardwired to 0.
4	RO	1b	<b>Capability List (CLIST):</b> This bit is hardwired to 1 to indicate to the configuration software that this device/function implements a list of new capabilities. A list of new capabilities is accessed via register CAPPTR at configuration address offset 34h. Register CAPPTR contains an offset pointing to the start address within configuration space of this device where the Capability Identification register resides.
3:0	RO	0000b	Reserved



### 5.1.5 RID—Revision Identification

B/D/F/Type: 0/0/0/PCI  
 Address Offset: 8h  
 Default Value: See table below  
 Access: RO  
 Size: 8 bits

This register contains the revision number of the MCH Device 0. These bits are read only and writes to this register have no effect.

Bit	Access	Default Value	Description
7:0	RO	See description	<b>Revision Identification Number (RID):</b> This is an 8-bit value that indicates the revision identification number for the MCH Device 0. Refer to the <i>Intel® 3200 and 3210 Chipset Specification Update</i> for the value of this register.

### 5.1.6 CC—Class Code

B/D/F/Type: 0/0/0/PCI  
 Address Offset: 9–Bh  
 Default Value: 060000h  
 Access: RO  
 Size: 24 bits

This register identifies the basic function of the device, a more specific sub-class, and a register-specific programming interface.

Bit	Access	Default Value	Description
23:16	RO	06h	<b>Base Class Code (BCC):</b> This is an 8-bit value that indicates the base class code for the MCH. This code has the value 06h, indicating a Bridge device.
15:8	RO	00h	<b>Sub-Class Code (SUBCC):</b> This is an 8-bit value that indicates the category of Bridge into which the MCH falls. The code is 00h indicating a Host Bridge.
7:0	RO	00h	<b>Programming Interface (PI):</b> This is an 8-bit value that indicates the programming interface of this device. This value does not specify a particular register set layout and provides no practical use for this device.

### 5.1.7 MLT—Master Latency Timer

B/D/F/Type: 0/0/0/PCI  
 Address Offset: Dh  
 Default Value: 00h  
 Access: RO  
 Size: 8 bits

Device 0 in the MCH is not a PCI master. Therefore this register is not implemented.

Bit	Access	Default Value	Description
7:0	RO	00h	Reserved



### 5.1.8 HDR—Header Type

B/D/F/Type: 0/0/0/PCI  
 Address Offset: Eh  
 Default Value: 00h  
 Access: RO  
 Size: 8 bits

This register identifies the header layout of the configuration space. No physical register exists at this location.

Bit	Access	Default Value	Description
7:0	RO	00h	<b>PCI Header (HDR):</b> This field always returns 0 to indicate that the MCH is a single function device with standard header layout. Reads and writes to this location have no effect.

### 5.1.9 SVID—Subsystem Vendor Identification

B/D/F/Type: 0/0/0/PCI  
 Address Offset: 2C–2Dh  
 Default Value: 0000h  
 Access: RWO  
 Size: 16 bits

This value is used to identify the vendor of the subsystem.

Bit	Access	Default Value	Description
15:0	RWO	0000h	<b>Subsystem Vendor ID (SUBVID):</b> This field should be programmed during boot-up to indicate the vendor of the system board. After it has been written once, it becomes read only.

### 5.1.10 SID—Subsystem Identification

B/D/F/Type: 0/0/0/PCI  
 Address Offset: 2E–2Fh  
 Default Value: 0000h  
 Access: RWO  
 Size: 16 bits

This value is used to identify a particular subsystem.

Bit	Access	Default Value	Description
15:0	RWO	0000h	<b>Subsystem ID (SUBID):</b> This field should be programmed during BIOS initialization. After it has been written once, it becomes read only.



### 5.1.11 CAPPTR—Capabilities Pointer

B/D/F/Type: 0/0/0/PCI  
 Address Offset: 34h  
 Default Value: E0h  
 Access: RO  
 Size: 8 bits

The CAPPTR provides the offset that is the pointer to the location of the first device capability in the capability list.

Bit	Access	Default Value	Description
7:0	RO	E0h	<b>Capabilities Pointer (CAPPTR):</b> Pointer to the offset of the first capability ID register block. In this case the first capability is the product-specific Capability Identifier (CAPID0).

### 5.1.12 PXPEPBAR—PCI Express\* Egress Port Base Address

B/D/F/Type: 0/0/0/PCI  
 Address Offset: 40–47h  
 Default Value: 0000000000000000h  
 Access: RO, RW/L  
 Size: 64 bits

This is the base address for the PCI Express Egress Port MMIO Configuration space. There is no physical memory within this 4 KB window that can be addressed. The 4 KB reserved by this register does not alias to any PCI 2.3 compliant memory mapped space. On reset, the EGRESS port MMIO configuration space is disabled and must be enabled by writing a 1 to PXPEPBAREN [Dev 0, offset 40h, bit 0]

All the bits in this register are locked in Intel® TXT mode.

Bit	Access	Default Value	Description
63:36	RO	0000000h	Reserved
35:12	RW/L	000000h	<b>PCI Express Egress Port MMIO Base Address (PXPEPBAR):</b> This field corresponds to bits 35 to 12 of the base address PCI Express Egress Port MMIO configuration space. BIOS will program this register resulting in a base address for a 4 KB block of contiguous memory address space. This register ensures that a naturally aligned 4KB space is allocated within the first 64 GB of addressable memory space. System Software uses this base address to program the MCH MMIO register set. All the bits in this register are locked in Intel TXT mode.
11:1	RO	000h	Reserved
0	RW/L	0b	<b>PXPEPBAR Enable (PXPEPBAREN):</b> 0 = PXPEPBAR is disabled and does not claim any memory 1 = PXPEPBAR memory mapped accesses are claimed and decoded appropriately This register is locked by Intel TXT.





### 5.1.13 MCHBAR—MCH Memory Mapped Register Range Base

B/D/F/Type: 0/0/0/PCI  
 Address Offset: 48–4Fh  
 Default Value: 0000000000000000h  
 Access: RO, RW/L  
 Size: 64 bits

This is the base address for the MCH Memory Mapped Configuration space. There is no physical memory within this 16KB window that can be addressed. The 16 KB reserved by this register does not alias to any PCI 2.3 compliant memory mapped space. On reset, the MCH MMIO Memory Mapped Configuration space is disabled and must be enabled by writing a 1 to MCHBAREN [Dev 0, offset48h, bit 0]

All the bits in this register are locked in Intel TXT mode.

The register space contains memory control, initialization, timing, and buffer strength registers; clocking registers; and power and thermal management registers. The 16 KB space reserved by the MCHBAR register is not accessible during Intel TXT mode of operation or if the ME security lock is asserted (MESMLCK.ME\_SM\_lock at PCI device 0, function 0, offset F4h) except for the following offset ranges.

02B8h to 02BFh: Channel 0 Throttle Counter Status Registers

06B8h to 06BFh: Channel 1 Throttle Counter Status Registers

0CD0h to 0CFFh: Thermal Sensor Control Registers

3000h to 3FFFh: Unlocked registers for future expansion

Bit	Access	Default Value	Description
63:36	RO	0000000h	Reserved
35:14	RW/L	000000h	<b>MCH Memory Mapped Base Address (MCHBAR):</b> This field corresponds to bits 35:14 of the base address MCH Memory Mapped configuration space. BIOS will program this register resulting in a base address for a 16 KB block of contiguous memory address space. This register ensures that a naturally aligned 16 KB space is allocated within the first 64 GB of addressable memory space. System Software uses this base address to program the MCH Memory Mapped register set. All the bits in this register are locked in Intel TXT mode.
13:1	RO	0000h	Reserved
0	RW/L	0b	<b>MCHBAR Enable (MCHBAREN):</b> 0 = MCHBAR is disabled and does not claim any memory 1 = MCHBAR memory mapped accesses are claimed and decoded appropriately This register is locked by Intel TXT.



### 5.1.14 DEVEN—Device Enable

B/D/F/Type: 0/0/0/PCI  
 Address Offset: 54–57h  
 Default Value: 000023DBh  
 Access: RO, RW/L  
 Size: 32 bits

Allows for enabling/disabling of PCI devices and functions that are within the MCH. The table below the bit definitions describes the behavior of all combinations of transactions to devices controlled by this register. All the bits in this register are Intel TXT Lockable.

Bit	Access	Default Value	Description
31:14	RO	00000h	Reserved
13	RW/L	1b	<p><b>PE1 Enable (D6EN):</b>            0 = Bus 0, Device 6 is disabled and hidden.            1 = Bus 1, Device 6 is enabled and visible.</p> <p><b>NOTE:</b> This bit description only applies to the 3210 MCH in dual x8 mode. For the 3200 MCH, this bit is reserved.</p>
12:11	RO	00b	Reserved
9	RW/L	1b	<p><b>EP Function 3 (D3F3EN):</b>            0 = Bus 0, Device 3, Function 3 is disabled and hidden            1 = Bus 0, Device 3, Function 3 is enabled and visible            If Device 3 Function 0 is disabled and hidden, then Device 3 Function 3 is also disabled and hidden independent of the state of this bit.            If this MCH does not have ME capability (CAPID0[57] = 1 or CAPID0[56] = 1), then Device 3, Function 3 is disabled and hidden independent of the state of this bit.</p>
8	RW/L	1b	<p><b>EP Function 2 (D3F2EN):</b>            0 = Bus 0, Device 3, Function 2 is disabled and hidden            1 = Bus 0, Device 3, Function 2 is enabled and visible            If Device 3 Function 0 is disabled and hidden, then Device 3 Function 2 is also disabled and hidden independent of the state of this bit.            If this MCH does not have ME capability (CAPID0[57] = 1 or CAPID0[56] = 1), then Device 3, Function 2 is disabled and hidden independent of the state of this bit.</p>
7	RW/L	1b	<p><b>EP Function 1 (D3F1EN):</b>            0 = Bus 0, Device 3, Function 1 is disabled and hidden            1 = Bus 0, Device 3, Function 1 is enabled and visible.            If Device 3 Function 0 is disabled and hidden, then Device 3 Function 1 is also disabled and hidden independent of the state of this bit.            If this MCH does not have ME capability (CAPID0[57] = 1), then Device 3, Function 1 is disabled and hidden independent of the state of this bit.</p>
6	RW/L	1b	<p><b>EP Function 0 (D3F0EN):</b>            0 = Bus 0, Device 3, Function 0 is disabled and hidden            1 = Bus 0, Device 3, Function 0 is enabled and visible.            If this MCH does not have ME capability (CAPID0[57] = 1), then Device 3, Function 0 is disabled and hidden independent of the state of this bit.</p>



Bit	Access	Default Value	Description
5:2	RO	0s	Reserved
1	RW/L	1b	<b>PCI Express Port (D1EN):</b> 0 = Bus 0, Device 1, Function 0 is disabled and hidden. Bus 0, Device 1, Function 0 is enabled and visible.
0	RO	1b	<b>Host Bridge (D0EN):</b> Bus 0, Device 0, Function 0 may not be disabled and is therefore hardwired to 1.

### 5.1.15 PCIEXBAR—PCI Express\* Register Range Base Address

B/D/F/Type: 0/0/0/PCI  
 Address Offset: 60–67h  
 Default Value: 00000000E0000000h  
 Access: RO, RW/L, RW/L/K  
 Size: 64 bits

This is the base address for the PCI Express configuration space. This window of addresses contains the 4 KB of configuration space for each PCI Express device that can potentially be part of the PCI Express Hierarchy associated with the MCH. There is not actual physical memory within this window of up to 256 MB that can be addressed. The actual length is determined by a field in this register. Each PCI Express Hierarchy requires a PCI Express BASE register. The MCH supports one PCI Express hierarchy. The region reserved by this register does not alias to any PCI 2.3 compliant memory mapped space.

On reset, this register is disabled and must be enabled by writing a 1 to the enable field in this register. This base address shall be assigned on a boundary consistent with the number of buses (defined by the Length field in this register), above TOLUD and still within 64 bit addressable memory space. All other bits not decoded are read only 0. The PCI Express Base Address cannot be less than the maximum address written to the Top of physical memory register (TOLUD). Software must guarantee that these ranges do not overlap with known ranges located above TOLUD. Software must ensure that the sum of Length of enhanced configuration region + TOLUD + (other known ranges reserved above TOLUD) is not greater than the 64-bit addressable limit of 64 GB. In general system implementation and number of PCI/PCI express/PCI-X buses supported in the hierarchy will dictate the length of the region.

All the Bits in this register are locked in Intel TXT mode.



Bit	Access	Default Value	Description
63:36	RO	0000000h	Reserved
35:28	RW/L	0Eh	<p><b>PCI Express Base Address (PCIEXBAR):</b> This field corresponds to bits [35:28] of the base address for PCI Express enhanced configuration space. BIOS will program this register resulting in a base address for a contiguous memory address space; size is defined by bits [2:1] of this register.</p> <p>This Base address shall be assigned on a boundary consistent with the number of buses (defined by the Length field in this register) above TOLUD and still within 64-bit addressable memory space. The address bits decoded depend on the length of the region defined by this register.</p> <p>This register is locked by Intel TXT.</p> <p>The address used to access the PCI Express configuration space for a specific device can be determined as follows:</p> <p>PCI Express Base Address + Bus Number * 1MB + Device Number * 32KB + Function Number * 4KB</p> <p>The address used to access the PCI Express configuration space for Device 1 in this component would be PCI Express Base Address + 0 * 1MB + 1 * 32KB + 0 * 4KB = PCI Express Base Address + 32KB. Remember that this address is the beginning of the 4KB space that contains both the PCI compatible configuration space and the PCI Express extended configuration space.</p> <p>All the Bits in this register are locked in Intel TXT mode.</p>
27	RW/L	0b	<p><b>128MB Base Address Mask (128ADMSK):</b> This bit is either part of the PCI Express Base Address (R/W) or part of the Address Mask (RO, read 0b), depending on the value of bits [2:1] in this register.</p>
26	RW/L	0b	<p><b>64MB Base Address Mask (64ADMSK):</b> This bit is either part of the PCI Express Base Address (R/W) or part of the Address Mask (RO, read 0b), depending on the value of bits [2:1] in this register.</p>
25:3	RO	000000h	Reserved
2:1	RW/L/K	00b	<p><b>Length (LENGTH):</b> This Field describes the length of this region. Enhanced Configuration Space Region/Buses Decoded</p> <p>00 = 256 MB (buses 0-255). Bits [31:28] are decoded in the PCI Express Base Address Field</p> <p>01 = 128 MB (Buses 0–127). Bits [31:27] are decoded in the PCI Express Base Address Field.</p> <p>10 = 64 MB (Buses 0–63). Bits [31:26] are decoded in the PCI Express Base Address Field.</p> <p>11 = Reserved</p> <p>This register is locked by Intel TXT.</p>
0	RW/L	0b	<p><b>PCIEXBAR Enable (PCIEXBAREN):</b></p> <p>0 = The PCIEXBAR register is disabled. Memory read and write transactions proceed as if there were no PCIEXBAR register. PCIEXBAR bits [35:26] are R/W with no functionality behind them.</p> <p>1 = The PCIEXBAR register is enabled. Memory read and write transactions whose address bits [35:26] match PCIEXBAR will be translated to configuration reads and writes within the MCH. These Translated cycles are routed as shown in the table above.</p> <p>This register is locked by Intel TXT.</p>



### 5.1.16 DMIBAR—Root Complex Register Range Base Address

B/D/F/Type: 0/0/0/PCI  
 Address Offset: 68–6Fh  
 Default Value: 0000000000000000h  
 Access: RO, RW/L  
 Size: 64 bits

This is the base address for the Root Complex configuration space. This window of addresses contains the Root Complex Register set for the PCI Express Hierarchy associated with the MCH. There is no physical memory within this 4 KB window that can be addressed. The 4 KB reserved by this register does not alias to any PCI 2.3 compliant memory mapped space. On reset, the Root Complex configuration space is disabled and must be enabled by writing a 1 to DMIBAREN [Dev 0, offset 68h, bit 0]. All the Bits in this register are locked in Intel TXT mode.

Bit	Access	Default Value	Description
63:36	RO	0000000h	Reserved
35:12	RW/L	000000h	<b>DMI Base Address (DMIBAR):</b> This field corresponds to bits 35:12 of the base address DMI configuration space. BIOS will program this register resulting in a base address for a 4 KB block of contiguous memory address space. This register ensures that a naturally aligned 4KB space is allocated within the first 64 GB of addressable memory space. System Software uses this base address to program the DMI register set. All the Bits in this register are locked in Intel TXT mode.
11:1	RO	000h	Reserved
0	RW/L	0b	<b>DMIBAR Enable (DMIBAREN):</b> 0 = DMIBAR is disabled and does not claim any memory 1 = DMIBAR memory mapped accesses are claimed and decoded appropriately This register is locked by Intel TXT.



### 5.1.17 PAM0—Programmable Attribute Map 0

B/D/F/Type: 0/0/0/PCI  
 Address Offset: 90h  
 Default Value: 00h  
 Access: RO, RW/L  
 Size: 8 bits

This register controls the read, write, and shadowing attributes of the BIOS area from 0F0000h–0FFFFFFh. The MCH allows programmable memory attributes on 13 Legacy memory segments of various sizes in the 768 KB to 1 MB address range. Seven Programmable Attribute Map (PAM) Registers are used to support these features. Cacheability of these areas is controlled via the MTRR registers in the processor. Two bits are used to specify memory attributes for each memory segment. These bits apply to both host accesses and PCI initiator accesses to the PAM areas. These attributes are:

- RE - Read Enable. When RE = 1, the processor read accesses to the corresponding memory segment are claimed by the MCH and directed to main memory. Conversely, when RE = 0, the host read accesses are directed to PCI\_A.
- WE - Write Enable. When WE = 1, the host write accesses to the corresponding memory segment are claimed by the MCH and directed to main memory. Conversely, when WE = 0, the host write accesses are directed to PCI\_A.

The RE and WE attributes permit a memory segment to be Read Only, Write Only, Read/Write, or disabled. For example, if a memory segment has RE = 1 and WE = 0, the segment is Read Only. Each PAM Register controls two regions, typically 16 KB in size.

Note that the MCH may hang if a PCI Express Link Attach or DMI originated access to Read Disabled or Write Disabled PAM segments occur (due to a possible IWB to non-DRAM).

For these reasons the following critical restriction is placed on the programming of the PAM regions: At the time that a DMI or PCI Express Link Attach accesses to the PAM region may occur, the targeted PAM segment must be programmed to be both readable and writeable.

Bit	Access	Default Value	Description
7:6	RO	00b	Reserved
5:4	RW/L	00b	<b>0F0000–0FFFFFF Attribute (HIENABLE):</b> This field controls the steering of read and write cycles that address the BIOS area from 0F0000h to 0FFFFFFh. 00 = DRAM Disabled: All accesses are directed to DMI. 01 = Read Only: All reads are sent to DRAM. All writes are forwarded to DMI. 10 = Write Only: All writes are sent to DRAM. Reads are serviced by DMI. 11 = Normal DRAM Operation: All reads and writes are serviced by DRAM. This register is locked by Intel TXT.
3:0	RO	0h	Reserved



### 5.1.18 PAM1—Programmable Attribute Map 1

B/D/F/Type: 0/0/0/PCI  
 Address Offset: 91h  
 Default Value: 00h  
 Access: RO, RW/L  
 Size: 8 bits

This register controls the read, write, and shadowing attributes of the BIOS areas from 0C0000h – 0C7FFFh.

Bit	Access	Default Value	Description
7:6	RO	00b	Reserved
5:4	RW/L	00b	<p><b>0C4000h–0C7FFFh Attribute (HIENABLE):</b> This field controls the steering of read and write cycles that address the BIOS area from 0C4000h to 0C7FFFh.</p> <p>00 = DRAM Disabled: Accesses are directed to DMI.</p> <p>01 = Read Only: All reads are serviced by DRAM. All writes are forwarded to DMI.</p> <p>10 = Write Only: All writes are sent to DRAM. Reads are serviced by DMI.</p> <p>11 = Normal DRAM Operation: All reads and writes are serviced by DRAM.</p> <p>This register is locked by Intel TXT.</p>
3:2	RO	00b	Reserved
1:0	RW/L	00b	<p><b>0C0000h–0C3FFFh Attribute (LOENABLE):</b> This field controls the steering of read and write cycles that address the BIOS area from 0C0000h to 0C3FFFh.</p> <p>00 = DRAM Disabled: Accesses are directed to DMI.</p> <p>01 = Read Only: All reads are serviced by DRAM. All writes are forwarded to DMI.</p> <p>10 = Write Only: All writes are sent to DRAM. Reads are serviced by DMI.</p> <p>11 = Normal DRAM Operation: All reads and writes are serviced by DRAM.</p> <p>This register is locked by Intel TXT.</p>



### 5.1.19 PAM2—Programmable Attribute Map 2

B/D/F/Type: 0/0/0/PCI  
 Address Offset: 92h  
 Default Value: 00h  
 Access: RO, RW/L  
 Size: 8 bits

This register controls the read, write, and shadowing attributes of the BIOS areas from 0C8000h– 0CFFFFh.

Bit	Access	Default Value	Description
7:6	RO	00b	Reserved
5:4	RW/L	00b	<b>0CC000h–0CFFFFh Attribute (HIENABLE):</b> 00 = DRAM Disabled: Accesses are directed to DMI. 01 = Read Only: All reads are serviced by DRAM. All writes are forwarded to DMI. 10 = Write Only: All writes are sent to DRAM. Reads are serviced by DMI. 11 = Normal DRAM Operation: All reads and writes are serviced by DRAM. This register is locked by Intel TXT.
3:2	RO	00b	Reserved
1:0	RW/L	00b	<b>0C8000h–0CBFFFh Attribute (LOENABLE):</b> This field controls the steering of read and write cycles that address the BIOS area from 0C8000h to 0CBFFFh. 00 = DRAM Disabled: Accesses are directed to DMI. 01 = Read Only: All reads are serviced by DRAM. All writes are forwarded to DMI. 10 = Write Only: All writes are sent to DRAM. Reads are serviced by DMI. 11 = Normal DRAM Operation: All reads and writes are serviced by DRAM. This register is locked by Intel TXT.





### 5.1.20 PAM3—Programmable Attribute Map 3

B/D/F/Type: 0/0/0/PCI  
 Address Offset: 93h  
 Default Value: 00h  
 Access: RO, RW/L  
 Size: 8 bits

This register controls the read, write, and shadowing attributes of the BIOS areas from 0D0000h – 0D7FFFh.

Bit	Access	Default Value	Description
7:6	RO	00b	Reserved
5:4	RW/L	00b	<p><b>0D4000h–0D7FFFh Attribute (HIENABLE):</b> This field controls the steering of read and write cycles that address the BIOS area from 0D4000h to 0D7FFFh.</p> <p>00 = DRAM Disabled: Accesses are directed to DMI.</p> <p>01 = Read Only: All reads are serviced by DRAM. All writes are forwarded to DMI.</p> <p>10 = Write Only: All writes are sent to DRAM. Reads are serviced by DMI.</p> <p>11 = Normal DRAM Operation: All reads and writes are serviced by DRAM.</p> <p>This register is locked by Intel TXT.</p>
3:2	RO	00b	Reserved
1:0	RW/L	00b	<p><b>0D0000h–0D3FFFh Attribute (LOENABLE):</b> This field controls the steering of read and write cycles that address the BIOS area from 0D0000h to 0D3FFFh.</p> <p>00 = DRAM Disabled: Accesses are directed to DMI.</p> <p>01 = Read Only: All reads are serviced by DRAM. All writes are forwarded to DMI.</p> <p>10 = Write Only: All writes are sent to DRAM. Reads are serviced by DMI.</p> <p>11 = Normal DRAM Operation: All reads and writes are serviced by DRAM.</p> <p>This register is locked by Intel TXT.</p>



### 5.1.21 PAM4—Programmable Attribute Map 4

B/D/F/Type: 0/0/0/PCI  
 Address Offset: 94h  
 Default Value: 00h  
 Access: RO, RW/L  
 Size: 8 bits

This register controls the read, write, and shadowing attributes of the BIOS areas from 0D8000h – 0DFFFFh.

Bit	Access	Default Value	Description
7:6	RO	00b	Reserved
5:4	RW/L	00b	<p><b>0DC000h–0DFFFFh Attribute (HIENABLE):</b> This field controls the steering of read and write cycles that address the BIOS area from 0DC000h to 0DFFFFh.</p> <p>00 = DRAM Disabled: Accesses are directed to DMI.</p> <p>01 = Read Only: All reads are serviced by DRAM. All writes are forwarded to DMI.</p> <p>10 = Write Only: All writes are sent to DRAM. Reads are serviced by DMI.</p> <p>11 = Normal DRAM Operation: All reads and writes are serviced by DRAM.</p> <p>This register is locked by Intel TXT.</p>
3:2	RO	00b	Reserved
1:0	RW/L	00b	<p><b>0D8000h–0DBFFFh Attribute (LOENABLE):</b> This field controls the steering of read and write cycles that address the BIOS area from 0D8000h to 0DBFFFh.</p> <p>00 = DRAM Disabled: Accesses are directed to DMI.</p> <p>01 = Read Only: All reads are serviced by DRAM. All writes are forwarded to DMI.</p> <p>10 = Write Only: All writes are sent to DRAM. Reads are serviced by DMI.</p> <p>11 = Normal DRAM Operation: All reads and writes are serviced by DRAM.</p> <p>This register is locked by Intel TXT.</p>



### 5.1.22 PAM5—Programmable Attribute Map 5

B/D/F/Type: 0/0/0/PCI  
 Address Offset: 95h  
 Default Value: 00h  
 Access: RO, RW/L  
 Size: 8 bits

This register controls the read, write, and shadowing attributes of the BIOS areas from 0E0000h – 0E7FFFh.

Bit	Access	Default Value	Description
7:6	RO	00b	Reserved
5:4	RW/L	00b	<p><b>0E4000h–0E7FFFh Attribute (HIENABLE):</b> This field controls the steering of read and write cycles that address the BIOS area from 0E4000 to 0E7FFF.</p> <p>00 = DRAM Disabled: Accesses are directed to DMI.</p> <p>01 = Read Only: All reads are serviced by DRAM. All writes are forwarded to DMI.</p> <p>10 = Write Only: All writes are sent to DRAM. Reads are serviced by DMI.</p> <p>11 = Normal DRAM Operation: All reads and writes are serviced by DRAM.</p> <p>This register is locked by Intel TXT.</p>
3:2	RO	00b	Reserved
1:0	RW/L	00b	<p><b>0E0000h–0E3FFFh Attribute (LOENABLE):</b> This field controls the steering of read and write cycles that address the BIOS area from 0E0000 to 0E3FFF.</p> <p>00 = DRAM Disabled: Accesses are directed to DMI.</p> <p>01 = Read Only: All reads are serviced by DRAM. All writes are forwarded to DMI.</p> <p>10 = Write Only: All writes are sent to DRAM. Reads are serviced by DMI.</p> <p>11 = Normal DRAM Operation: All reads and writes are serviced by DRAM.</p> <p>This register is locked by Intel TXT.</p>



### 5.1.23 PAM6—Programmable Attribute Map 6

B/D/F/Type: 0/0/0/PCI  
 Address Offset: 96h  
 Default Value: 00h  
 Access: RO, RW/L  
 Size: 8 bits

This register controls the read, write, and shadowing attributes of the BIOS areas from 0E8000h–0EFFFFh.

Bit	Access	Default Value	Description
7:6	RO	00b	Reserved
5:4	RW/L	00b	<b>0EC000h–0EFFFFh Attribute (HIENABLE):</b> This field controls the steering of read and write cycles that address the BIOS area from 0E4000h to 0E7FFFh. 00 = DRAM Disabled: Accesses are directed to DMI. 01 = Read Only: All reads are serviced by DRAM. All writes are forwarded to DMI. 10 = Write Only: All writes are sent to DRAM. Reads are serviced by DMI. 11 = Normal DRAM Operation: All reads and writes are serviced by DRAM. This register is locked by Intel TXT.
3:2	RO	00b	Reserved
1:0	RW/L	00b	<b>0E8000h–0EBFFFh Attribute (LOENABLE):</b> This field controls the steering of read and write cycles that address the BIOS area from 0E0000h to 0E3FFFh. 00 = DRAM Disabled: Accesses are directed to DMI. 01 = Read Only: All reads are serviced by DRAM. All writes are forwarded to DMI. 10 = Write Only: All writes are sent to DRAM. Reads are serviced by DMI. 11 = Normal DRAM Operation: All reads and writes are serviced by DRAM. This register is locked by Intel TXT.

### 5.1.24 LAC—Legacy Access Control

B/D/F/Type: 0/0/0/PCI  
 Address Offset: 97h  
 Default Value: 00h  
 Access: RW/L, RO  
 Size: 8 bits

This 8-bit register controls a fixed DRAM hole from 15–16 MB.

Bit	Access	Default Value	Description
7	RW/L	0b	<b>Hole Enable (HEN):</b> This field enables a memory hole in DRAM space. The DRAM that lies "behind" this space is not remapped. 0 = No memory hole. 1 = Memory hole from 15 MB to 16 MB. This bit is Intel TXT lockable.
6:0	RO	0s	Reserved



### 5.1.25 REMAPBASE—Remap Base Address Register

B/D/F/Type: 0/0/0/PCI  
 Address Offset: 98–99h  
 Default Value: 03FFh  
 Access: RO, RW/L  
 Size: 16 bits

Bit	Access	Default Value	Description
15:10	RO	000000b	Reserved
9:0	RW/L	3FFh	<p><b>Remap Base Address [35:26] (REMAPBASE):</b> The value in this register defines the lower boundary of the Remap window. The Remap window is inclusive of this address. In the decoder A[25:0] of the Remap Base Address are assumed to be 0s. Thus the bottom of the defined memory range will be aligned to a 64MB boundary.</p> <p>When the value in this register is greater than the value programmed into the Remap Limit register, the Remap window is disabled.</p> <p>These bits are Intel TXT lockable or ME stolen Memory lockable.</p>

### 5.1.26 REMAPLIMIT—Remap Limit Address Register

B/D/F/Type: 0/0/0/PCI  
 Address Offset: 9A–9Bh  
 Default Value: 0000h  
 Access: RO, RW/L  
 Size: 16 bits

Bit	Access	Default Value	Description
15:10	RO	000000b	Reserved
9:0	RW/L	000h	<p><b>Remap Limit Address [35:26] (REMAPLMT):</b> The value in this register defines the upper boundary of the Remap window. The Remap window is inclusive of this address. In the decoder A[25:0] of the remap limit address are assumed to be Fs. Thus the top of the defined range will be one less than a 64 MB boundary.</p> <p>When the value in this register is less than the value programmed into the Remap Base register, the Remap window is disabled.</p> <p>These Bits are Intel TXT lockable or ME stolen Memory lockable.</p>



### 5.1.27 SMRAM—System Management RAM Control

B/D/F/Type: 0/0/0/PCI  
 Address Offset: 9Dh  
 Default Value: 02h  
 Access: RO, RW/L, RW, RW/L/K  
 Size: 8 bits

The SMRAMC register controls how accesses to Compatible and Extended SMRAM spaces are treated. The Open, Close, and Lock bits function only when G\_SMFRAME bit is set to a 1. Also, the OPEN bit must be reset before the LOCK bit is set.

Bit	Access	Default Value	Description
7	RO	0b	Reserved
6	RW/L	0b	<b>SMM Space Open (D_OPEN):</b> When D_OPEN=1 and D_LCK=0, the SMM space DRAM is made visible even when SMM decode is not active. This is intended to help BIOS initialize SMM space. Software should ensure that D_OPEN=1 and D_CLS=1 are not set at the same time.
5	RW	0b	<b>SMM Space Closed (D_CLS):</b> When D_CLS = 1 SMM space DRAM is not accessible to data references, even if SMM decode is active. Code references may still access SMM space DRAM. This will allow SMM software to reference through SMM space to update the display. Software should ensure that D_OPEN=1 and D_CLS=1 are not set at the same time.
4	RW/L/K	0b	<b>SMM Space Locked (D_LCK):</b> When D_LCK is set to 1 then D_OPEN is reset to 0 and D_LCK, D_OPEN, C_BASE_SEG, H_SMFRAME_EN, TSEG_SZ and TSEG_EN become read only. D_LCK can be set to 1 via a normal configuration space write but can only be cleared by a Full Reset. The combination of D_LCK and D_OPEN provide convenience with security. The BIOS can use the D_OPEN function to initialize SMM space and then use D_LCK to "lock down" SMM space in the future so that no application software (or BIOS itself) can violate the integrity of SMM space, even if the program has knowledge of the D_OPEN function.
3	RW/L	0b	<b>Global SMRAM Enable (G_SMFRAME):</b> If set to a 1, then Compatible SMRAM functions are enabled, providing 128 KB of DRAM accessible at the A0000h address while in SMM (ADSB with SMM decode). To enable Extended SMRAM function this bit has to be set to 1. Refer to the section on SMM for more details. Once D_LCK is set, this bit becomes read only.
2:0	RO	010b	<b>Compatible SMM Space Base Segment (C_BASE_SEG):</b> This field indicates the location of SMM space. SMM DRAM is not remapped. It is simply made visible if the conditions are right to access SMM space, otherwise the access is forwarded to DMI. Since the MCH supports only the SMM space between A0000 and BFFFF, this field is hardwired to 010b.



### 5.1.28 ESMRAMC—Extended System Management RAM Control

B/D/F/Type: 0/0/0/PCI  
 Address Offset: 9Eh  
 Default Value: 38h  
 Access: RW/L, RWC, RO  
 Size: 8 bits

The Extended SMRAM register controls the configuration of Extended SMRAM space. The Extended SMRAM (E\_SMRAM) memory provides a write-back cacheable SMRAM memory space that is above 1 MB.

Bit	Access	Default Value	Description
7	RW/L	0b	<b>Enable High SMRAM (H_SMRAME):</b> This bit controls the SMM memory space location (i.e., above 1 MB or below 1 MB) When G_SMRAME is 1 and H_SMRAME is set to 1, the high SMRAM memory space is enabled. SMRAM accesses within the range 0FEDA0000h to 0FEDBFFFFh are remapped to DRAM addresses within the range 000A0000h to 000BFFFFh. Once D_LCK has been set, this bit becomes read only.
6	RWC	0b	<b>Invalid SMRAM Access (E_SMERR):</b> This bit is set when processor has accessed the defined memory ranges in Extended SMRAM (High Memory and T-segment) while not in SMM space and with the D-OPEN bit = 0. It is software's responsibility to clear this bit. The software must write a 1 to this bit to clear it.
5	RO	1b	<b>SMRAM Cacheable (SM_CACHE):</b> This bit is forced to 1 by the MCH.
4	RO	1b	<b>L1 Cache Enable for SMRAM (SM_L1):</b> This bit is forced to 1 by the MCH.
3	RO	1b	<b>L2 Cache Enable for SMRAM (SM_L2):</b> This bit is forced to 1 by the MCH.
2:1	RW/L	00b	<b>TSEG Size (TSEG_SZ):</b> Selects the size of the TSEG memory block if enabled. Memory from the top of DRAM space is partitioned away so that it may only be accessed by the processor interface and only then when the SMM bit is set in the request packet. Non-SMM accesses to this memory region are sent to DMI when the TSEG memory block is enabled. 00 = 1 MB TSEG. (TOLUD – Stolen Memory Size – 1M) to (TOLUD – Stolen Memory Size). 01 = 2 MB TSEG (TOLUD – Stolen Memory Size – 2M) to (TOLUD – Stolen Memory Size). 10 = 8 MB TSEG (TOLUD – Stolen Memory Size – 8M) to (TOLUD – Stolen Memory Size). 11 = Reserved. Once D_LCK has been set, these bits become read only.
0	RW/L	0b	<b>TSEG Enable (T_EN):</b> This bit is for enabling of SMRAM memory for Extended SMRAM space only. When G_SMRAME = 1 and TSEG_EN = 1, the TSEG is enabled to appear in the appropriate physical address space. Note that once D_LCK is set, this bit becomes read only.



### 5.1.29 TOM—Top of Memory

B/D/F/Type: 0/0/0/PCI  
Address Offset: A0–A1h  
Default Value: 0001h  
Access: RO, RW/L  
Size: 16 bits

This Register contains the size of physical memory. BIOS determines the memory size reported to the OS using this Register.

Bit	Access	Default Value	Description
15:10	RO	00h	Reserved
9:0	RW/L	001h	<b>Top of Memory (TOM):</b> This register reflects the total amount of populated physical memory. This is NOT necessarily the highest main memory address (holes may exist in main memory address map due to addresses allocated for memory mapped IO). These bits correspond to address bits 35:26 (64MB granularity). Bits 25:0 are assumed to be 0. All the bits in this register are locked in Intel TXT mode.

### 5.1.30 TOUUD—Top of Upper Usable Dram

B/D/F/Type: 0/0/0/PCI  
Address Offset: A2–A3h  
Default Value: 0000h  
Access: RW/L  
Size: 16 bits

This 16 bit register defines the Top of Upper Usable DRAM.

Configuration software must set this value to TOM minus all EP stolen memory if reclaim is disabled. If reclaim is enabled, this value must be set to reclaim limit + 1byte 64 MB aligned since reclaim limit is 64 MB aligned. Address bits 19:0 are assumed to be 000\_0000h for the purposes of address comparison. The Host interface positively decodes an address towards DRAM if the incoming address is less than the value programmed in this register and greater than or equal to 4 GB.

These bits are Intel TXT lockable.

Bit	Access	Default Value	Description
15:0	RW/L	0000h	<b>TOUUD (TOUUD):</b> This register contains bits 35:20 of an address one byte above the maximum DRAM memory above 4 GB that is usable by the operating system. Configuration software must set this value to TOM minus all EP stolen memory if reclaim is disabled. If reclaim is enabled, this value must be set to reclaim limit 64 MB aligned since reclaim limit + 1byte is 64 MB aligned. Address bits 19:0 are assumed to be 000_0000h for the purposes of address comparison. The Host interface positively decodes an address towards DRAM if the incoming address is less than the value programmed in this register and greater than 4 GB. All the Bits in this register are locked in Intel TXT mode.





### 5.1.31 BSM—Base of Stolen Memory

B/D/F/Type: 0/0/0/PCI  
 Address Offset: A4–A7h  
 Default Value: 00000000h  
 Access: RW/L, RO  
 Size: 32 bits

This register contains the base address of stolen DRAM memory. BIOS determines the base of stolen memory by subtracting the stolen memory size (PCI Device 0 offset 52 bits [6:4]) from TOLUD (PCI Device 0 offset B0 bits [15:04]).

Note: This register is locked and becomes Read Only when the D\_LCK bit in the SMRAM register is set.

Bit	Access	Default Value	Description
31:20	RW/L	000h	<b>Base of Stolen Memory (BSM):</b> This register contains bits 31 to 20 of the base address of stolen DRAM memory. BIOS determines the base of stolen memory by subtracting the stolen memory size (PCI Device 0, offset 52h, bits 6:4) from TOLUD (PCI Device 0, offset B0h, bits 15:4). <b>NOTE:</b> This register is locked and becomes Read Only when the D_LCK bit in the SMRAM register is set.
19:0	RO	00000h	Reserved

### 5.1.32 TSEGMB—TSEG Memory Base

B/D/F/Type: 0/0/0/PCI  
 Address Offset: AC–AFh  
 Default Value: 00000000h  
 Access: RO, RW/L  
 Size: 32 bits

This register contains the base address of TSEG DRAM memory. BIOS determines the base of TSEG memory by subtracting the TSEG size (PCI Device 0 offset 9E bits [2:1]) from stolen base (PCI Device 0 offset A4 bits [31:20]).

Once D\_LCK has been set, these bits becomes read only.

Bit	Access	Default Value	Description
31:20	RW/L	000h	<b>TSEG Memory base (TSEGMB):</b> This register contains bits [31:20] of the base address of TSEG DRAM memory. BIOS determines the base of TSEG memory by subtracting the TSEG size (PCI Device 0 offset 9E bits [2:1]) from stolen base (PCI Device 0 offset A8 bits [31:20]). Once D_LCK has been set, these bits becomes read only.
19:0	RO	00000h	Reserved



### 5.1.33 TOLUD—Top of Low Usable DRAM

B/D/F/Type: 0/0/0/PCI  
 Address Offset: B0–B1h  
 Default Value: 0010h  
 Access: RW/L, RO  
 Size: 16 bits

This 16 bit register defines the Top of Low Usable DRAM. TSEG, and Stolen Memory are within the DRAM space defined. From the top, MCH optionally claims 1, 2 MB of DRAM for Stolen Memory and 1, 2, or 8 MB of DRAM for TSEG if enabled.

**Programming Example:**

C1DRB3 is set to 4 GB

TSEG is enabled and TSEG size is set to 1 MB

Stolen Memory Size set to 2 MB

BIOS knows the OS requires 1 GB of PCI space.

BIOS also knows the range from FEC0\_0000h to FFFF\_FFFFh is not usable by the system. This 20 MB range at the very top of addressable memory space is lost to APIC and Intel TXT.

According to the above equation, TOLUD is originally calculated to: 4 GB = 1\_0000\_0000h

The system memory requirements are: 4GB (max addressable space) – 1GB (PCI space) – 35 MB (lost memory) = 3 GB – 35 MB (minimum granularity) = ECBO\_0000h

Since ECBO\_0000h (PCI and other system requirements) is less than 1\_0000\_0000h, TOLUD should be programmed to ECBh.

These bits are Intel TXT lockable.

Bit	Access	Default Value	Description
15:4	RW/L	001h	<p><b>Top of Low Usable DRAM (TOLUD):</b> This register contains bits [31:20] of an address one byte above the maximum DRAM memory below 4GB that is usable by the operating system. Address bits [31:20] programmed to 01h implies a minimum memory size of 1 MB. Configuration software must set this value to the smaller of the following 2 choices: maximum amount memory in the system minus ME stolen memory plus one byte or the minimum address allocated for PCI memory. Address bits [19:0] are assumed to be 0_0000h for the purposes of address comparison. The Host interface positively decodes an address towards DRAM if the incoming address is less than the value programmed in this register.</p> <p>Note that the Top of Low Usable DRAM is the lowest address above both Stolen memory and TSEG. BIOS determines the base of Stolen Memory by subtracting the Stolen Memory Size from TOLUD and further decrements by TSEG size to determine base of TSEG. All the Bits in this register are locked in Intel TXT mode.</p> <p>This register must be 64 MB aligned when reclaim is enabled.</p>
3:0	RO	0000b	Reserved



### 5.1.34 ERRSTS—Error Status

B/D/F/Type: 0/0/0/PCI  
 Address Offset: C8–C9h  
 Default Value: 0000h  
 Access: RWC/S, RO  
 Size: 16 bits

This register is used to report various error conditions via the SERR DMI messaging mechanism. An SERR DMI message is generated on a zero to one transition of any of these flags (if enabled by the ERRCMD and PCICMD registers).

These bits are set regardless of whether or not the SERR is enabled and generated. After the error processing is complete, the error logging mechanism can be unlocked by clearing the appropriate status bit by software writing a 1 to it.

Bit	Access	Default Value	Description
15	RO	0b	Reserved
14	RWC/S	0b	<b>Isochronous TBWRR Run Behind FIFO Full (ITCV):</b> If set, this bit indicates a VC1 TBWRR is running behind, resulting in the slot timer to stop until the request is able to complete. If this bit is already set, then a interrupt message will not be sent on a new error event.
13	RWC/S	0b	<b>Isochronous TBWRR Run behind FIFO Put (ITSTV):</b> If set, this bit indicates a VC1 TBWRR request was put into the run behind. This will likely result in a resulting in a contract violation due to the MCH egress port taking too long to service the isochronous request. If this bit is already set, then a interrupt message will not be sent on a new error event.
12	RO	0b	Reserved
11	RWC/S	0b	<b>MCH Thermal Sensor Event for SMI/SCI/SERR (GTSE):</b> This bit indicates that a MCH Thermal Sensor trip has occurred and an SMI, SCI or SERR has been generated. The status bit is set only if a message is sent based on Thermal event enables in Error command, SMI command and SCI command registers. A trip point can generate one of SMI, SCI, or SERR interrupts (two or more per event is illegal). Multiple trip points can generate the same interrupt, if software chooses this mode, subsequent trips may be lost. If this bit is already set, then an interrupt message will not be sent on a new thermal sensor event.
10	RO	0b	Reserved
9	RWC/S	0b	<b>LOCK to non-DRAM Memory Flag (LCKF):</b> When this bit is set to 1, the MCH has detected a lock operation to memory space that did not map into DRAM.
8	RO	0b	Reserved
7	RWC/S	0b	<b>DRAM Throttle Flag (DTF):</b> 1 = Indicates that a DRAM Throttling condition occurred. 0 = Software has cleared this flag since the most recent throttling event.
6:2	RO	00h	Reserved



Bit	Access	Default Value	Description
1	RWC/S	0b	<b>Multiple-bit DRAM ECC Error Flag (DMERR):</b> If this bit is set to 1, a memory read data transfer had an uncorrectable multiple-bit error. When this bit is set, the address, channel number, and device number that caused the error are logged in the register. Once this bit is set, the fields are locked until the processor clears this bit by writing a 1. Software uses bits [1:0] to detect whether the logged error address is for Single or Multiple-bit error. This bit is reset on PWROK.
0	RWC/S	0b	<b>Single-bit DRAM ECC Error Flag (DSERR):</b> If this bit is set to 1, a memory read data transfer had a single-bit correctable error and the corrected data was sent for the access. When this bit is set the address and device number that caused the error are logged in the DEAP register. Once this bit is set the DEAP, DERRSYN, and DERRDST fields are locked to further single bit error updates until the processor clears this bit by writing a 1. A multiple bit error that occurs after this bit is set will overwrite the DEAP and DERRSYN fields with the multiple-bit error signature and the DMERR bit will also be set. A single bit error that occurs after a multi-bit error will set this bit but will not overwrite the other fields. This bit is reset on PWROK.



### 5.1.35 ERRCMD—Error Command

B/D/F/Type: 0/0/0/PCI  
 Address Offset: CA–CBh  
 Default Value: 0000h  
 Access: RW, RO  
 Size: 16 bits

This register controls the MCH responses to various system errors. Since the MCH does not have an SERRB signal, SERR messages are passed from the MCH to the ICH over DMI.

When a bit in this register is set, a SERR message will be generated on DMI whenever the corresponding flag is set in the ERRSTS register. The actual generation of the SERR message is globally enabled for Device 0 via the PCI Command register.

Bit	Access	Default Value	Description
15:12	RO	0h	Reserved
11	RW	0b	<b>SERR on MCH Thermal Sensor Event (TSESERR):</b> 1 = The MCH generates a DMI SERR special cycle when bit [11] of the ERRSTS is set. The SERR must not be enabled at the same time as the SMI for the same thermal sensor event. 0 = Reporting of this condition via SERR messaging is disabled.
10	RO	0b	Reserved
9	RW	0b	<b>SERR on LOCK to non-DRAM Memory (LCKERR):</b> 1 = The MCH will generate a DMI SERR special cycle whenever a processor lock cycle is detected that does not hit DRAM. 0 = Reporting of this condition via SERR messaging is disabled.
8:2	RO	0s	Reserved
1	RW	0b	<b>SERR Multiple-Bit DRAM ECC Error (DMERR):</b> 1 = The MCH generates an SERR message over DMI when it detects a multiple-bit error reported by the DRAM controller. 0 = Reporting of this condition via SERR messaging is disabled. For systems not supporting ECC this bit must be disabled.
0	RW	0b	<b>SERR on Single-bit ECC Error (DSERR):</b> 1 = The MCH generates an SERR special cycle over DMI when the DRAM controller detects a single bit error. 0 = Reporting of this condition via SERR messaging is disabled. For systems that do not support ECC this bit must be disabled.



### 5.1.36 SMICMD—SMI Command

B/D/F/Type: 0/0/0/PCI  
 Address Offset: CC–CDh  
 Default Value: 0000h  
 Access: RO, RW  
 Size: 16 bits

This register enables various errors to generate an SMI DMI special cycle. When an error flag is set in the ERRSTS register, it can generate an SERR, SMI, or SCI DMI special cycle when enabled in the ERRCMD, SMICMD, or SCICMD registers, respectively. Note that one and only one message type can be enabled.

Bit	Access	Default Value	Description
15:12	RO	0h	Reserved
11	RW	0b	<b>SMI on MCH Thermal Sensor Trip (TSTSMI):</b> 1 = A SMI DMI special cycle is generated by MCH when the thermal sensor trip requires an SMI. A thermal sensor trip point cannot generate more than one special cycle. 0 = Reporting of this condition via SMI messaging is disabled.
10:2	RO	000h	Reserved
1	RW	0b	<b>SMI on Multiple-Bit DRAM ECC Error (DMESMI):</b> 1 = The MCH generates an SMI DMI message when it detects a multiple-bit error reported by the DRAM controller. 0 = Reporting of this condition via SMI messaging is disabled. For systems not supporting ECC this bit must be disabled.
0	RW	0b	<b>SMI on Single-bit ECC Error (DSESMI):</b> 1 = The MCH generates an SMI DMI special cycle when the DRAM controller detects a single bit error. 0 = Reporting of this condition via SMI messaging is disabled. For systems that do not support ECC this bit must be disabled.

### 5.1.37 SKPD—Scratchpad Data

B/D/F/Type: 0/0/0/PCI  
 Address Offset: DC–DFh  
 Default Value: 00000000h  
 Access: RW  
 Size: 32 bits

This register holds 32 writable bits with no functionality behind them. It is for the convenience of BIOS drivers.

Bit	Access	Default Value	Description
31:0	RW	00000000h	<b>Scratchpad Data (SKPD):</b> 1 DWord of data storage.



### 5.1.38 CAPIDO—Capability Identifier

B/D/F/Type: 0/0/0/PCI  
 Address Offset: E0–EBh  
 Default Value: 00000001C1064000010C0009h  
 Access: RO  
 Size: 96 bits  
 BIOS Optimal Default 0h

This register provides control of bits in this register are only required for customer visible component differentiation.

Bit	Access	Default Value	Description
95:78	RO	0s	Reserved
77	RO	0b	<b>Dual Channel Disable (DCD):</b> Disables dual-channel operation 0 = Dual channel operation allowed 1 = Only single channel operation allowed - Only channel 0 will operate, channel 1 will be turned off and tristated to save power. This setting hardwires the rank population field for channel 1 to zero. (MCHBAR offset 660h, bits 20:23).
76	RO	0b	<b>2 DIMMS per Channel Disable (2DPCD):</b> Allows Dual-Channel operation but only supports 1 DIMM per channel. 0 = 2 DIMMs per channel Enabled 1 = 2 DIMMs per channel disabled. This setting hardwires bits 2 and 3 of the rank population field for each channel to zero. (MCHBAR offset 260h, bits 22:23 for channel 0 and MCHBAR offset 660h, bits 22:23 for channel 1).
75	RO	0b	<b>Chipset Intel TXT disable (LTDIS):</b> Chipset Intel TXT disable
74:75	RO	00b	Reserved
72	RO	0b	<b>Agent Presence Disable (APD):</b>
71	RO	0b	<b>Circuit Breaker Disable (CBD):</b>
70	RO	0b	<b>Multiprocessor Disable (MD):</b> 0 = MCH capable of Multiple Processors 1 = MCH capable of uni-processor only.
69	RO	0b	<b>FAN Speed Control Disable (FSCD):</b>
68	RO	0b	<b>EastFork Disable (EFD):</b>
67:65	RO	000b	Reserved
64:62	RO	111b	Reserved
61:58	RO	0000b	Reserved
57	RO	0b	<b>ME Disable (MED):</b> 0 = ME feature is enabled 1 = ME feature is disabled
56	RO	1b	Reserved
55:51	RO	0s	Reserved
50:49	RO	11b	Reserved
48	RO	0b	<b>VT-d Disable (VTDD):</b> 0 = Enable VT-d 1 = Disable VT-d
47	RO	0b	Reserved



Bit	Access	Default Value	Description
46	RO	1b	Reserved
45	RO	0b	<b>Primary PCI Express Port x16 Disable (PEX16D):</b> 0 = Capable of x16 PCI Express Port. 1 = Not Capable of x16 PCI Express port; instead PCI Express is limited to x8 and below. This causes PCI Express port to enable and train logical lanes [7:0] only. Logical lanes [15:8] are powered down, and the Max Link Width field of the Link Capability register reports x8 instead of x16. (In the case of x8 lane reversal, lanes [15:8] are active and lanes [7:0] are powered down.)
44	RO	0b	<b>Primary PCI Express Port Disable (PEPD):</b> 0 = There is a PCI Express Port on this MCH. Device 1 and associated memory spaces are accessible. 1 = There is no PCI Express Port on this MCH. Device 1 and associated memory and I/O spaces are disabled by hardwiring the D1EN field bit 1 of the Device Enable register (DEVEN Dev 0 Offset 54h). In addition, Next_Pointer = 00h, and IO cannot decode to the PCI Express interface. From a Physical Layer perspective, all 16 lanes are powered down and the link does not attempt to train.
43	RO	0b	<b>Secondary PCI Express Port X16 Disable (PE2X16D):</b> 0 = Capable of x16 PCI Express1 Port. 1 = Not Capable of x16 PCI Express1 port; instead PCI Express1 is limited to x8 and below. This causes PCI Express1 port to enable and train logical lanes [7:0] only. Logical lanes [15:8] are powered down, and the Max Link Width field of the Link Capability register reports x8 instead of x16. (In the case of x8 lane reversal, lanes [15:8] are active and lanes [7:0] are powered down.)
42	RO	0b	<b>Secondary PCI Express Port Disable (PE2PD):</b> 0 = There is a secondary PCI Express Port on this MCH. Device 6 and associated memory spaces are accessible. 1 = There is no secondary PCI Express Port on this MCH. Device 6 and associated memory and IO spaces are disabled by hardwiring the D6EN field bit [13] of the Device Enable register (DEVEN Dev 0 Offset 54h). All 16 lanes are powered down and the link does not attempt to train. In addition, Next_Pointer = 00h, and IO cannot decode to the PCI Express interface. From a Physical Layer perspective, all 16 lanes are powered down and the link does not attempt to train.
41	RO	0b	Reserved
40	RO	0b	<b>ECC Disable (ECCDIS):</b> 0 = ECC capable 1 = Not ECC capable. Hardwires ECC enable field, bit 7, of the CWB Control Registers (MCHBAR Offset 243h and 643h) to "0".
39	RO	0b	Reserved
38	RO	0b	<b>Reserved</b>
37:35	RO	000b	Reserved
34	RO	0b	<b>Reserved</b>
33:32	RO	00b	Reserved





Bit	Access	Default Value	Description
31:30	RO	00b	<b>DDR Frequency Capability (DDRFC):</b> This field controls which values may be written to the Memory Frequency Select field [6:4] of the Clocking Configuration registers (MCHBAR Offset C00h). Any attempt to write an unsupported value will be ignored. 10 = MCH capable of up to DDR2 800 11 = MCH capable of up to DDR2 667
29:28	RO	00b	<b>FSB Frequency Capability (FSBFC):</b> This field controls which values are allowed in the FSB Frequency Select Field [2:0] of the Clocking Configuration Register. These values are determined by the BSEL[2:0] frequency straps. Any unsupported strap values will render the MCH System Memory Interface inoperable. 00 = MCH capable of "All" Memory Frequencies 01 = MCH capable of up to FSB 1333 10 = MCH capable of up to FSB 1067 11 = MCH capable of up to FSB 800
27:24	RO	1h	<b>CAPID Version (CAPIDV):</b> This field has the value 0001b to identify the first revision of the CAPID register definition.
23:16	RO	0Ch	<b>CAPID Length (CAPIDL):</b> This field has the value 0Ch to indicate the structure length (12 bytes).
15:8	RO	00h	<b>Next Capability Pointer (NCP):</b> This field is hardwired to 00h indicating the end of the capabilities linked list.
7:0	RO	09h	<b>Capability Identifier (CAP_ID):</b> This field has the value 1001b to identify the CAP_ID assigned by the PCI SIG for vendor dependent capability pointers.



## 5.2 MCHBAR

Table 9. MCHBAR Register Address Map

Address Offset	Register Symbol	Register Name	Default Value	Access
111h	CHDECMISC	Channel Decode Misc	00h	RW/L
200–201h	C0DRB0	Channel 0 DRAM Rank Boundary Address 0	0000h	RO, RW/L
202–203h	C0DRB1	Channel 0 DRAM Rank Boundary Address 1	0000h	RW/L, RO
204–205h	C0DRB2	Channel 0 DRAM Rank Boundary Address 2	0000h	RW/L, RO
206–207h	C0DRB3	Channel 0 DRAM Rank Boundary Address 3	0000h	RO, RW/L
208–209h	C0DRA01	Channel 0 DRAM Rank 0,1 Attribute	0000h	RW/L
20A	C0DRA23	Channel 0 DRAM Rank 2,3 Attribute	0000h	RW/L
250–251h	C0CYCTRPCHG	Channel 0 CYCTRK PCHG	0000h	RO, RW
252–255h	C0CYCTRKACT	Channel 0 CYCTRK ACT	00000000h	RW, RO
256–257h	C0CYCTRKWR	Channel 0 CYCTRK WR	0000h	RW
258–25Ah	C0CYCTRKRD	Channel 0 CYCTRK READ	000000h	RO, RW
25B–25Ch	C0CYCTRKREFR	Channel 0 CYCTRK REFR	0000h	RO, RW
260–263h	COCKECTRL	Channel 0 CKE Control	00000800h	RW, RW/L, RO
269–26Eh	COREFRCTRL	Channel 0 DRAM Refresh Control	02183000C30h	RW, RO
280–287h	COECCERRLOG	Channel 0 ECC Error Log	0000000000000000h	RO/P, RO
29C–29Fh	COODTCTRL	Channel 0 ODT Control	00000000h	RO, RW
600–601h	C1DRB0	Channel 1 DRAM Rank Boundary Address 0	0000h	RW/L, RO
602–603h	C1DRB1	Channel 1 DRAM Rank Boundary Address 1	0000h	RO, RW/L
604–605h	C1DRB2	Channel 1 DRAM Rank Boundary Address 2	0000h	RW/L, RO
606–607h	C1DRB3	Channel 1 DRAM Rank Boundary Address 3	0000h	RW/L, RO
608–609h	C1DRA01	Channel 1 DRAM Rank 0,1 Attributes	0000h	RW/L
60A–60Bh	C1DRA23	Channel 1 DRAM Rank 2,3 Attributes	0000h	RW/L
650–651h	C1CYCTRPCHG	Channel 1 CYCTRK PCHG	0000h	RW, RO
652–655h	C1CYCTRKACT	Channel 1 CYCTRK ACT	00000000h	RO, RW
656–657h	C1CYCTRKWR	Channel 1 CYCTRK WR	0000h	RW



Table 9. MCHBAR Register Address Map

Address Offset	Register Symbol	Register Name	Default Value	Access
658–65Ah	C1CYCTRKR	Channel 1 CYCTRK READ	000000h	RW, RO
660–663h	C1CKECTRL	Channel 1 CKE Control	00000800h	RO, RW/L, RW
669–66Eh	C1REFRCTRL	Channel 1 DRAM Refresh Control	021830000C30h	RW, RO
680–687h	C1ECCERRLOG	Channel 1 ECC Error Log	0000000000000000h	RO/P, RO
69C–69Fh	C1ODTCTRL	Channel 1 ODT Control	00000000h	RO, RW
A00–A01h	EPC0DRB0	EP Channel 0 DRAM Rank Boundary Address 0	0000h	RW, RO
A02–A03h	EPC0DRB1	EP Channel 0 DRAM Rank Boundary Address 1	0000h	RW, RO
A04–A05h	EPC0DRB2	EP Channel 0 DRAM Rank Boundary Address 2	0000h	RW, RO
A06–A07h	EPC0DRB3	EP Channel 0 DRAM Rank Boundary Address 3	0000h	RW, RO
A08–A09h	EPC0DRA01	EP Channel 0 DRAM Rank 0,1 Attribute	0000h	RW
A0A–A0Bh	EPC0DRA23	EP Channel 0 DRAM Rank 2,3 Attribute	0000h	RW
A19–A1Ah	EPDCYCTRKWRTPRE	EPD CYCTRK WRT PRE	0000h	RW, RO
A1C–A1Fh	EPDCYCTRKWRTACT	EPD CYCTRK WRT ACT	00000000h	RO, RW
A20–A21h	EPDCYCTRKWRTWR	EPD CYCTRK WRT WR	0000h	RW, RO
A22–A23h	EPDCYCTRKWRTREF	EPD CYCTRK WRT REF	0000h	RO, RW
A24–A26h	EPDCYCTRKWRTRD	EPD CYCTRK WRT READ	000000h	RW
A28–A2Ch	EPDCKECONFIGREG	EPD CKE related configuration registers	00E0000000h	RW
A30–A33h	EPDREFCONFIG	EP DRAM Refresh Configuration	40000C30h	RW, RO
CD8h	TSC1	Thermal Sensor Control 1	00h	RW/L, RW, RS/WC
CD9h	TSC2	Thermal Sensor Control 2	00h	RO, RW/L
CDAh	TSS	Thermal Sensor Status	00h	RO
CDC–CDFh	TSTTP	Thermal Sensor Temperature Trip Point	00000000h	RO, RW, RW/L
CE2h	TCO	Thermal Calibration Offset	00h	RW/L/K, RW/L
CE4h	THERM1	Thermal Hardware Protection	00h	RW/L, RO, RW/L/K
CEA–CEBh	TIS	Thermal Interrupt Status	0000h	RO, RWC
CF1–CF1h	TSMICMD	Thermal SMI Command	00h	RO, RW
F14–F17h	PMSTS	Power Management Status	00000000h	RWC/S, RO



### 5.2.1 CHDECMI SC—Channel Decode Misc

B/D/F/Type: 0/0/0/MCHBAR  
Address Offset: 111h  
Default Value: 00h  
Access: RW/L  
Size: 8 bits

This register provides miscellaneous CHDEC/MAGEN configuration bits.

Bit	Access	Default Value	Description
7	RW/L	0b	Reserved
6:5	RW/L	00b	<b>Enhanced Mode Select (ENHMODESEL):</b> 00 = Swap Enabled for Bank Selects and Rank Selects 01 = XOR Enabled for Bank Selects and Rank Selects 10 = Swap Enabled for Bank Selects only 11 = XOR Enabled for Bank Select only This register is locked by ME stolen Memory lock.
4	RW/L	0b	<b>Channel 2 Enhanced Mode (CH2_ENHMODE):</b>
3	RW/L	0b	<b>Channel 1 Enhanced Mode (CH1_ENHMODE):</b>
2	RW/L	0b	<b>Channel 0 Enhanced Mode (CH0_ENHMODE):</b>
1	RW/L	0b	Reserved
0	RW/L	0b	<b>EP Present (EPPRSNT):</b> This bit indicates whether EP UMA is present in the system or not. This register is locked by ME stolen Memory lock.



## 5.2.2 CODRBO—Channel 0 DRAM Rank Boundary Address 0

B/D/F/Type: 0/0/0/MCHBAR  
 Address Offset: 200–201h  
 Default Value: 0000h  
 Access: RO, RW/L  
 Size: 16 bits

The DRAM Rank Boundary Registers define the upper boundary address of each DRAM rank with a granularity of 64MB. Each rank has its own single-word DRB register. These registers are used to determine which chip select will be active for a given address. Channel and rank map:

ch0 rank0:	200h
ch0 rank1:	202h
ch0 rank2:	204h
ch0 rank3:	206h
ch1 rank0:	600h
ch1 rank1:	602h
ch1 rank2:	604h
ch1 rank3:	606h

### Programming guide:

#### Non-stacked mode:

If Channel 0 is empty, all of the CODRBs are programmed with 00h.

**CODRBO** = Total memory in ch0 rank0 (in 64MB increments)

**CODRB1** = Total memory in ch0 rank0 + ch0 rank1 (in 64MB increments)

and so on.

If Channel 1 is empty, all of the C1DRBs are programmed with 00h.

**C1DRBO** = Total memory in ch1 rank0 (in 64MB increments)

**C1DRB1** = Total memory in ch1 rank0 + ch1 rank1 (in 64MB increments)

and so on.

#### Stacked mode:

CODRBs:

Similar to Non-stacked mode.

C1DRB0, C1DRB1 and C1DRB2:

They are also programmed similar to non-stacked mode. Only exception is, the DRBs corresponding to the topmost populated rank and the (unpopulated) higher ranks in Channel 1 must be programmed with the value of the total Channel 1 population plus the value of total Channel 0 population (CODRB3).

Example: If only ranks 0 and 1 are populated in Ch1 in stacked mode, then

C1DRB0 = Total memory in ch1 rank0 (in 64MB increments)



C1DRB1 = C0DRB3 + Total memory in ch1 rank0 + ch1 rank1 (in 64MB increments)  
(rank 1 is the topmost populated rank)

C1DRB2 = C1DRB1

C1DRB3 = C1DRB1

C1DRB3:

C1DRB3 = C0DRB3 + Total memory in Channel 1.

Bit	Access	Default Value	Description
15:10	RO	000000b	Reserved
9:0	RW/L	000h	<p><b>Channel 0 Dram Rank Boundary Address 0 (C0DRBA0):</b> This register defines the DRAM rank boundary for rank0 of Channel 0 (64 MB granularity)</p> <p>=R0</p> <p>R0 = Total rank0 memory size/64MB</p> <p>R1 = Total rank1 memory size/64MB</p> <p>R2 = Total rank2 memory size/64MB</p> <p>R3 = Total rank3 memory size/64MB</p> <p>This register is locked by ME stolen Memory lock.</p>

### 5.2.3 C0DRB1—Channel 0 DRAM Rank Boundary Address 1

B/D/F/Type: 0/0/0/MCHBAR  
 Address Offset: 202–203h  
 Default Value: 0000h  
 Access: RW/L, RO  
 Size: 16 bits

See C0DRB0 register.

Bit	Access	Default Value	Description
15:10	RO	000000b	Reserved
9:0	RW/L	000h	<p><b>Channel 0 Dram Rank Boundary Address 1 (C0DRBA1):</b> This field defines the DRAM rank boundary for rank1 of Channel 0 (64 MB granularity)</p> <p>=(R1 + R0)</p> <p>R0 = Total rank0 memory size/64MB</p> <p>R1 = Total rank1 memory size/64MB</p> <p>R2 = Total rank2 memory size/64MB</p> <p>R3 = Total rank3 memory size/64MB</p> <p>This register is locked by ME stolen Memory lock.</p>



### 5.2.4 CODRB2—Channel 0 DRAM Rank Boundary Address 2

B/D/F/Type: 0/0/0/MCHBAR  
 Address Offset: 204–205h  
 Default Value: 0000h  
 Access: RW/L, RO  
 Size: 16 bits

See CODRB0 register.

Bit	Access	Default Value	Description
15:10	RO	000000b	Reserved
9:0	RW/L	000h	<p><b>Channel 0 DRAM Rank Boundary Address 2 (CODRBA2):</b> This register defines the DRAM rank boundary for rank2 of Channel 0 (64 MB granularity) <math>= (R2 + R1 + R0)</math></p> <p>R0 = Total rank0 memory size/64MB                      R1 = Total rank1 memory size/64MB                      R2 = Total rank2 memory size/64MB                      R3 = Total rank3 memory size/64MB</p> <p>This register is locked by ME stolen Memory lock.</p>

### 5.2.5 CODRB3—Channel 0 DRAM Rank Boundary Address 3

B/D/F/Type: 0/0/0/MCHBAR  
 Address Offset: 206–207h  
 Default Value: 0000h  
 Access: RO, RW/L  
 Size: 16 bits

See CODRB0 register.

Bit	Access	Default Value	Description
15:10	RO	000000b	Reserved
9:0	RW/L	000h	<p><b>Channel 0 DRAM Rank Boundary Address 3 (CODRBA3):</b> This register defines the DRAM rank boundary for rank3 of Channel 0 (64 MB granularity) <math>= (R3 + R2 + R1 + R0)</math></p> <p>R0 = Total rank0 memory size/64MB                      R1 = Total rank1 memory size/64MB                      R2 = Total rank2 memory size/64MB                      R3 = Total rank3 memory size/64MB</p> <p>This register is locked by ME stolen Memory lock.</p>



### 5.2.6 CODRA01—Channel 0 DRAM Rank 0,1 Attribute

B/D/F/Type: 0/0/0/MCHBAR  
 Address Offset: 208–209h  
 Default Value: 0000h  
 Access: RW/L  
 Size: 16 bits

The DRAM Rank Attribute Registers define the page sizes/number of banks to be used when accessing different ranks. These registers should be left with their default value (all zeros) for any rank that is unpopulated, as determined by the corresponding CxDRB registers. Each byte of information in the CxDRA registers describes the page size of a pair of ranks. Channel and rank map:

Ch0 Rank0, 1: 208h–209h  
 Ch0 Rank2, 3: 20Ah–20Bh  
 Ch1 Rank0, 1: 608h–609h  
 Ch1 Rank2, 3: 60Ah–60Bh

DRA[6:0] = "00" means cfg0, DRA[6:0] = "01" means cfg1.... DRA[6:0] = "09" means cfg9 and so on.

DRA[7] indicates whether it's an 8 bank config or not. DRA[7] = 0 means 4 bank, DRA[7] = 1 means 8 bank.

**Table 10. DRAM Rank Attribute Register Programming**

Config	Tech	DDRx	Depth	Width	Row	Col	Bank	Row Size	Page Size
0	256Mb	2	32M	8	13	10	2	256 MB	8k
1	256Mb	2	16M	16	13	9	2	128 MB	4k
2	512Mb	2	64M	8	14	10	2	512 MB	8k
3	512Mb	2	32M	16	13	10	2	256 MB	8k
4	512Mb	3	64M	8	13	10	3	512 MB	8k
5	512Mb	3	32M	16	12	10	3	256 MB	8k
6	1 Gb	2,3	128M	8	14	10	3	1 GB	8k
7	1 Gb	2,3	64M	16	13	10	3	512 MB	8k

Bit	Access	Default Value	Description
15:8	RW/L	00h	<b>Channel 0 DRAM Rank-1 Attributes (CODRA1):</b> This register defines DRAM pagesize/number-of-banks for rank1 for given channel. See table in register description for programming. This register is locked by ME stolen Memory lock.
7:0	RW/L	00h	<b>Channel 0 DRAM Rank-0 Attributes (CODRA0):</b> This register defines DRAM page size/number-of-banks for rank0 for given channel. See table in register description for programming. This register is locked by ME stolen Memory lock.





### 5.2.7 CODRA23—Channel 0 DRAM Rank 2,3 Attribute

B/D/F/Type: 0/0/0/MCHBAR  
 Address Offset: 20A–20Bh  
 Default Value: 0000h  
 Access: RW/L  
 Size: 16 bits

See CODRA01 register.

Bit	Access	Default Value	Description
15:8	RW/L	00h	<b>Channel 0 DRAM Rank-3 Attributes (CODRA3):</b> This register defines DRAM pagesize/number-of-banks for rank3 for given channel. See table in register description for programming. This register is locked by ME stolen Memory lock.
7:0	RW/L	00h	<b>Channel 0 DRAM Rank-2 Attributes (CODRA2):</b> This register defines DRAM pagesize/number-of-banks for rank2 for given channel. See table in register description for programming. This register is locked by ME stolen Memory lock.

### 5.2.8 COCYTRKPCHG—Channel 0 CYCTRK PCHG

B/D/F/Type: 0/0/0/MCHBAR  
 Address Offset: 250–251h  
 Default Value: 0000h  
 Access: RO, RW  
 Size: 16 bits

This is the Channel 0 CYCTRK Precharge registers.

Bit	Access	Default Value	Description
15:11	RO	00000b	Reserved
10:6	RW	00000b	<b>Write To PRE Delayed (C0sd_cr_wr_pchg):</b> This field indicates the minimum allowed spacing (in DRAM clocks) between the WRITE and PRE commands to the same rank-bank. This field corresponds to $t_{WR}$ in the DDR Specification.
5:2	RW	0000b	<b>READ To PRE Delayed (C0sd_cr_rd_pchg):</b> This field indicates the minimum allowed spacing (in DRAM clocks) between the READ and PRE commands to the same rank-bank
1:0	RW	00b	<b>PRE To PRE Delayed (C0sd_cr_pchg_pchg):</b> This field indicates the minimum allowed spacing (in DRAM clocks) between two PRE commands to the same rank.



### 5.2.9 COCYCTRKACT—Channel 0 CYCTRK ACT

B/D/F/Type: 0/0/0/MCHBAR  
 Address Offset: 252–255h  
 Default Value: 00000000h  
 Access: RW, RO  
 Size: 32 bits

Channel 0 CYCTRK Activate registers.

Bit	Access	Default Value	Description
31:28	RO	0h	Reserved
27:22	RW	000000b	<b>ACT Window Count (C0sd_cr_act_windowcnt):</b> This field indicates the window duration (in DRAM clocks) during which the controller counts the # of activate commands which are launched to a particular rank. If the number of activate commands launched within this window is greater than 4, then a check is implemented to block launch of further activates to this rank for the rest of the duration of this window.
21	RW	0b	<b>Max ACT Check Disable (C0sd_cr_maxact_dischk):</b> This field enables the check which ensures that there are no more than four activates to a particular rank in a given window.
20:17	RW	0000b	<b>ACT to ACT Delayed (C0sd_cr_act_act[]):</b> This field indicates the minimum allowed spacing (in DRAM clocks) between two ACT commands to the same rank. This field corresponds to $t_{RRD}$ in the DDR Specification.
16:13	RW	0000b	<b>PRE to ACT Delayed (C0sd_cr_pre_act):</b> This field indicates the minimum allowed spacing (in DRAM clocks) between the PRE and ACT commands to the same rank-bank: 12:9R/W0000bPRE-ALL to ACT Delayed. (C0sd_cr_preall_act): This field indicates the minimum allowed spacing (in DRAM clocks) between the PRE-ALL and ACT commands to the same rank. This field corresponds to $t_{RP}$ in the DDR Specification.
12:9	RW	0h	<b>ALLPRE to ACT Delay (C0sd0_cr_preall_act):</b> From the launch of a prechargeall command wait for these many # of memory clocks before launching a activate command. This field corresponds to $t_{PALL\_RP}$ in the DDR Specification.
8:0	RW	0000000 00b	<b>REF to ACT Delayed (C0sd_cr_rfsh_act):</b> This field indicates the minimum allowed spacing (in DRAM clocks) between REF and ACT commands to the same rank. This field corresponds to $t_{RFC}$ in the DDR Specification.



### 5.2.10 COCYCTRKWR—Channel 0 CYCTRK WR

B/D/F/Type: 0/0/0/MCHBAR  
 Address Offset: 256–257h  
 Default Value: 0000h  
 Access: RW  
 Size: 16 bits

Channel 0 CYCTRK WR registers.

Bit	Access	Default Value	Description
15:12	RW	0h	<b>ACT To Write Delay (C0sd_cr_act_wr):</b> This field indicates the minimum allowed spacing (in DRAM clocks) between the ACT and WRITE commands to the same rank-bank. This field corresponds to $t_{RCD\_wr}$ in the DDR Specification.
11:8	RW	0h	<b>Same Rank Write To Write Delayed (C0sd_cr_wrsr_wr):</b> This field indicates the minimum allowed spacing (in DRAM clocks) between two WRITE commands to the same rank.
7:4	RW	0h	<b>Different Rank Write to Write Delay (C0sd_cr_wrd_r_wr):</b> This field register indicates the minimum allowed spacing (in DRAM clocks) between two WRITE commands to different ranks. This field corresponds to $t_{WR\_WR}$ in the DDR Specification.
3:0	RW	0h	<b>READ To WRITE Delay (C0sd_cr_rd_wr):</b> This field indicates the minimum allowed spacing (in DRAM clocks) between the READ and WRITE commands. This field corresponds to $t_{RD\_WR}$ .



### 5.2.11 COCYCTRKR—Channel 0 CYCTRK READ

B/D/F/Type: 0/0/0/MCHBAR  
 Address Offset: 258–25Ah  
 Default Value: 000000h  
 Access: RO, RW  
 Size: 24 bits

Channel 0 CYCTRK RD registers.

Bit	Access	Default Value	Description
23:21	RO	000b	Reserved
20:17	RW	0h	<b>Min ACT To READ Delayed (C0sd_cr_act_rd):</b> This field indicates the minimum allowed spacing (in DRAM clocks) between the ACT and READ commands to the same rank-bank. This field corresponds to $t_{RCD\_rd}$ in the DDR specification.
16:12	RW	00000b	<b>Same Rank Write To READ Delayed (C0sd_cr_wrsr_rd):</b> This field indicates the minimum allowed spacing (in DRAM clocks) between the WRITE and READ commands to the same rank. This field corresponds to $t_{WTR}$ in the DDR specification.
11:8	RW	0000b	<b>Different Ranks Write To READ Delayed (C0sd_cr_wrdr_rd):</b> This field indicates the minimum allowed spacing (in DRAM clocks) between the WRITE and READ commands to different ranks. This field corresponds to $t_{WR\_RD}$ in the DDR specification.
7:4	RW	0000b	<b>Same Rank Read To Read Delayed (C0sd_cr_rdsr_rd):</b> This field indicates the minimum allowed spacing (in DRAM clocks) between two READ commands to the same rank.
3:0	RW	0000b	<b>Different Ranks Read To Read Delayed (C0sd_cr_rddr_rd):</b> This field indicates the minimum allowed spacing (in DRAM clocks) between two READ commands to different ranks. This field corresponds to $t_{RD\_RD}$ .

### 5.2.12 COCYCTRKREFR—Channel 0 CYCTRK REFR

B/D/F/Type: 0/0/0/MCHBAR  
 Address Offset: 25B–25Ch  
 Default Value: 0000h  
 Access: RO, RW  
 Size: 16 bits

Channel 0 CYCTRK Refresh registers.

Bit	Access	Default Value	Description
15:13	RO	000b	Reserved
12:9	RW	0000b	<b>Same Rank PALL to REF Delayed (C0sd_cr_pchgall_rfsh):</b> This field indicates the minimum allowed spacing (in DRAM clocks) between the PRE-ALL and REF commands to the same rank.
8:0	RW	00000000b	<b>Same Rank REF to REF Delayed (C0sd_cr_rfsh_rfsh):</b> This field indicates the minimum allowed spacing (in DRAM clocks) between two REF commands to same ranks.



### 5.2.13 COCKECTRL—Channel 0 CKE Control

B/D/F/Type: 0/0/0/MCHBAR  
 Address Offset: 260–263h  
 Default Value: 00000800h  
 Access: RW, RW/L, RO  
 Size: 32 bits

This register provides CKE controls for Channel 0.

Bit	Access	Default Value	Description
31:28	RO	0000b	Reserved
27	RW	0b	<b>Start the Self-Refresh Exit Sequence (sd0_cr_srcstart):</b> This field indicates the request to start the self-refresh exit sequence
26:24	RW	000b	<b>CKE Pulse Width Requirement in High Phase (sd0_cr_cke_pw_hi_safe):</b> This field indicates CKE pulse width requirement in high phase. This field corresponds to $t_{CKE}$ (high) in the DDR specification.
23	RW/L	0b	<b>Rank 3 Population (sd0_cr_rankpop3):</b> 1 = Rank 3 populated 0 = Rank 3 not populated This register is locked by ME stolen Memory lock.
22	RW/L	0b	<b>Rank 2 Population (sd0_cr_rankpop2):</b> 1 = Rank 2 populated 0 = Rank 2 not populated This register is locked by ME stolen Memory lock.
21	RW/L	0b	<b>Rank 1 Population (sd0_cr_rankpop1):</b> 1 = Rank 1 populated 0 = Rank 1 not populated This register is locked by ME stolen Memory lock.
20	RW/L	0b	<b>Rank 0 Population (sd0_cr_rankpop0):</b> 1 = Rank 0 populated 0 = Rank 0 not populated This register is locked by ME stolen Memory lock.
19:17	RW	000b	<b>CKE Pulse Width Requirement in Low Phase (sd0_cr_cke_pw_lh_safe):</b> This configuration register indicates CKE pulse width requirement in low phase. This field corresponds to $t_{CKE}$ (low) in the DDR specification.
16	RW	0b	<b>Enable CKE Toggle for PDN Entry/Exit (sd0_cr_pdn_enable):</b> This bit indicates that the toggling of CKEs (for PDN entry/exit) is enabled.
15:14	RO	00b	Reserved
13:10	RW	0010b	<b>Minimum Powerdown exit to Non-Read command spacing (sd0_cr_txp):</b> This field indicates the minimum number of clocks to wait following assertion of CKE before issuing a non-read command. 1010–1111 = Reserved. 0010–1001 = 2–9clocks. 0000–0001 = Reserved.
9:1	RW	00000000b	<b>Self Refresh Exit Count (sd0_cr_slfrsh_exit_cnt):</b> This field indicates the Self refresh exit count. (Program to 255). This field corresponds to $t_{XSNR}/t_{XSRD}$ in the DDR Specification.
0	RW	0b	<b>Indicates only 1 DIMM Populated (sd0_cr_singledimmpop):</b> This field indicates the that only 1 DIMM is populated.



### 5.2.14 COREFRCTRL—Channel 0 DRAM Refresh Control

B/D/F/Type: 0/0/0/MCHBAR  
 Address Offset: 269–26Eh  
 Default Value: 021830000C30h  
 Access: RW, RO  
 Size: 48 bits

This register provides the settings to configure the DRAM refresh controller.

Bit	Access	Default Value	Description
47:42	RO	00h	Reserved
41:37	RW	10000b	<b>Direct Rcomp Quiet Window (DIRQUIET):</b> This configuration setting indicates the amount of refresh_tick events to wait before the service of rcomp request in non-default mode of independent rank refresh.
36:32	RW	11000b	<b>Indirect Rcomp Quiet Window (INDIRQUIET):</b> This configuration setting indicates the amount of refresh_tick events to wait before the service of rcomp request in non-default mode of independent rank refresh.
31:27	RW	00110b	<b>Rcomp Wait (RCOMPWAIT):</b> This configuration setting indicates the amount of refresh_tick events to wait before the service of rcomp request in non-default mode of independent rank refresh.
26	RW	0b	Reserved
25	RW	0b	<b>Refresh Counter Enable (REFCNTEN):</b> This bit is used to enable the refresh counter to count during times that DRAM is not in self-refresh, but refreshes are not enabled. Such a condition may occur due to need to reprogram DIMMs following DRAM controller switch. This bit has no effect when Refresh is enabled (i.e. there is no mode where Refresh is enabled but the counter does not run) So, in conjunction with bit [23] REFEN, the modes are: <b>[REFEN:REFCNTEN] Description</b> [0:0]           Normal refresh disable [0:1]           Refresh disabled, but counter is accumulating refreshes. [1:X]           Normal refresh enable
24	RW	0b	<b>All Rank Refresh (ALLRKREF):</b> This configuration bit enables (by default) that all the ranks are refreshed in a staggered/atomic fashion. If set, the ranks are refreshed in an independent fashion.
23	RW	0b	<b>Refresh Enable (REFEN):</b> Refresh is enabled. 0 = Disabled 1 = Enabled
22	RW	0b	<b>DDR Initialization Done (INITDONE):</b> Indicates that DDR initialization is complete.
21:20	RW	00b	Reserved
19:18	RW	00b	<b>DRAM Refresh Panic Watermark (REFPANICWMM):</b> When the refresh count exceeds this level, a refresh request is launched to the scheduler and the dref_panic flag is set. 00 = 5 01 = 6 10 = 7 11 = 8



Bit	Access	Default Value	Description
17:16	RW	00b	<p><b>DRAM Refresh High Watermark (REFHIGHWM):</b> When the refresh count exceeds this level, a refresh request is launched to the scheduler and the dref_high flag is set.</p> <p>00 = 3                      01 = 4                      10 = 5                      11 = 6</p>
15:14	RW	00b	<p><b>DRAM Refresh Low Watermark (REFLOWWM):</b> When the refresh count exceeds this level, a refresh request is launched to the scheduler and the dref_low flag is set.</p> <p>00 = 1                      01 = 2                      10 = 3                      11 = 4</p>
13:0	RW	00110000 110000b	<p><b>Refresh Counter Time Out Value (REFTIMEOUT):</b> Program this field with a value that will provide 7.8 us at the memory clock frequency.</p> <p>At various mclk frequencies, this results in the following values:</p> <p>400 Mhz -&gt; C30 hex (Default Value)                      533 Mhz -&gt; 104B hex                      666 Mhz -&gt; 1450 hex</p>



### 5.2.15 COECCERRLOG—Channel 0 ECC Error Log

B/D/F/Type: 0/0/0/MCHBAR  
 Address Offset: 280–287h  
 Default Value: 0000000000000000h  
 Access: RO/P, RO  
 Size: 64 bits

This register is used to store the error status information in ECC enabled configurations, along with the error syndrome and the rank/bank/row/column address information of the address block of main memory of which an error (single bit or multi-bit error) has occurred. Note that the address fields represent the address of the first single or the first multiple bit error occurrence after the error flag bits in the ERRSTS register have been cleared by software. A multiple bit error will overwrite a single bit error. Once the error flag bits are set as a result of an error, this bit field is locked and doesn't change as a result of a new error until the error flag is cleared by software. Same is the case with error syndrome field, but the following priority needs to be followed if more than one error occurs on one or more of the 4 QWs. MERR on QW0 MERR on QW1 MERR on QW2 MERR on QW3 CERR on QW0 CERR on QW1 CERR on QW2 CERR on QW3

Bit	Access	Default Value	Description
63:48	RO/P	0000h	<b>Error Column Address (ERRCOL):</b> Row address of the address block of main memory of which an error (single bit or multi-bit error) has occurred.
47:32	RO/P	0000h	<b>Error Row Address (ERRROW):</b> Row address of the address block of main memory of which an error (single bit or multi-bit error) has occurred.
31:29	RO/P	000b	<b>Error Bank Address (ERRBANK):</b> Rank address of the address block of main memory of which an error (single bit or multi-bit error) has occurred.
28:27	RO/P	00b	<b>Error Rank Address (ERRRANK):</b> Rank address of the address block of main memory of which an error (single bit or multi-bit error) has occurred. 00 = rank 0 (DIMM0) 01 = rank 1 (DIMM0) 10 = rank 2 (DIMM1) 11 = rank 3 (DIMM1)
26:24	RO	0h	Reserved
23:16	RO/P	00h	<b>Error Syndrome (ERRSYND):</b> Syndrome that describes the set of bits associated with the first failing quadword.
15:2	RO	0h	Reserved
1	RO/P	0b	<b>Multiple Bit Error Status (MERRSTS):</b> This bit is set when an uncorrectable multiple-bit error occurs on a memory read data transfer. When this bit is set, the address that caused the error and the error syndrome are also logged and they are locked until this bit is cleared. This bit is cleared when it receives an indication that the processor has cleared the corresponding bit in the ERRSTS register.
0	RO/P	0b	<b>Correctable Error Status (CERRSTS):</b> This bit is set when a correctable single-bit error occurs on a memory read data transfer. When this bit is set, the address that caused the error and the error syndrome are also logged and they are locked to further single bit errors, until this bit is cleared. But, a multiple bit error that occurs after this bit is set will over-write the address/error syndrome info. This bit is cleared when it receives an indication that the processor has cleared the corresponding bit in the ERRSTS register.





### 5.2.16 COODTCTRL—Channel 0 ODT Control

B/D/F/Type: 0/0/0/MCHBAR  
 Address Offset: 29C–29Fh  
 Default Value: 00000000h  
 Access: RO, RW  
 Size: 32 bits

This register provides ODT controls.

Bit	Access	Default Value	Description
31:12	RO	00000h	Reserved
11:8	RW	0h	<b>DRAM ODT for Read Commands (sd0_cr_odt_duration_rd)</b> : Specifies the duration in MDCLKs to assert DRAM ODT for Read Commands. The Async value should be used when the Dynamic Powerdown bit is set. Else use the Sync value.
7:4	RW	0h	<b>DRAM ODT for Write Commands (sd0_cr_odt_duration_wr)</b> : Specifies the duration in MDCLKs to assert DRAM ODT for Write Commands. The Async value should be used when the Dynamic Powerdown bit is set. Else use the Sync value.
3:0	RW	0h	<b>MCH ODT for Read Commands (sd0_cr_mchodt_duration)</b> : Specifies the duration in MDCLKs to assert MCH ODT for Read Commands

### 5.2.17 C1DRB0—Channel 1 DRAM Rank Boundary Address 0

B/D/F/Type: 0/0/0/MCHBAR  
 Address Offset: 600–601h  
 Default Value: 0000h  
 Access: RW/L, RO  
 Size: 16 bits

The operation of this register is detailed in the description for the C0DRB0 register.

Bit	Access	Default Value	Description
15:10	RO	000000b	Reserved
9:0	RW/L	000h	<b>Channel 1 DRAM Rank Boundary Address 0 (C1DRBA0)</b> : See C0DRB0 register. In stacked mode, if this is the topmost populated rank in Channel 1, program this value to be cumulative of Ch0 DRB3. This register is locked by ME stolen Memory lock.



### 5.2.18 C1DRB1—Channel 1 DRAM Rank Boundary Address 1

B/D/F/Type: 0/0/0/MCHBAR  
Address Offset: 602–603h  
Default Value: 0000h  
Access: RO, RW/L  
Size: 16 bits

The operation of this register is detailed in the description for the C0DRB0 register.

Bit	Access	Default Value	Description
15:10	RO	000000b	Reserved
9:0	RW/L	000h	<b>Channel 1 DRAM Rank Boundary Address 1 (C1DRBA1):</b> See C0DRB1 register. In stacked mode, if this is the topmost populated rank in Channel 1, program this value to be cumulative of Ch0 DRB3. This register is locked by ME stolen Memory lock.

### 5.2.19 C1DRB2—Channel 1 DRAM Rank Boundary Address 2

B/D/F/Type: 0/0/0/MCHBAR  
Address Offset: 604–605h  
Default Value: 0000h  
Access: RW/L, RO  
Size: 16 bits

The operation of this register is detailed in the description for C0DRB0 register.

Bit	Access	Default Value	Description
15:10	RO	000000b	Reserved
9:0	RW/L	000h	<b>Channel 1 DRAM Rank Boundary Address 2 (C1DRBA2):</b> See C0DRB2 register. In stacked mode, if this is the topmost populated rank in Channel 1, program this value to be cumulative of Ch0 DRB3. This register is locked by ME stolen Memory lock.



### 5.2.20 C1DRB3—Channel 1 DRAM Rank Boundary Address 3

B/D/F/Type: 0/0/0/MCHBAR  
 Address Offset: 606–607h  
 Default Value: 0000h  
 Access: RW/L, RO  
 Size: 16 bits

The operation of this register is detailed in the description for C0DRB0 register.

Bit	Access	Default Value	Description
15:10	RO	000000b	Reserved
9:0	RW/L	000h	<b>Channel 1 DRAM Rank Boundary Address 3 (C1DRBA3):</b> See C0DRB3 register. In stacked mode, this will be cumulative of Ch0 DRB3. This register is locked by ME stolen Memory lock.

### 5.2.21 C1DRA01—Channel 1 DRAM Rank 0,1 Attributes

B/D/F/Type: 0/0/0/MCHBAR  
 Address Offset: 608–609h  
 Default Value: 0000h  
 Access: RW/L  
 Size: 16 bits

The operation of this register is detailed in the description for C0DRA01 register.

Bit	Access	Default Value	Description
15:8	RW/L	00h	<b>Channel 1 DRAM Rank-1 Attributes (C1DRA1):</b> See C0DRA1 register. This register is locked by ME stolen Memory lock.
7:0	RW/L	00h	<b>Channel 1 DRAM Rank-0 Attributes (C1DRA0):</b> See C0DRA0 register. This register is locked by ME stolen Memory lock.

### 5.2.22 C1DRA23—Channel 1 DRAM Rank 2,3 Attributes

B/D/F/Type: 0/0/0/MCHBAR  
 Address Offset: 60A–60Bh  
 Default Value: 0000h  
 Access: RW/L  
 Size: 16 bits

The operation of this register is detailed in the description for C0DRA01 register.

Bit	Access	Default Value	Description
15:8	RW/L	00h	<b>Channel 1 DRAM Rank-3 Attributes (C1DRA3):</b> See C0DRA3 register. This register is locked by ME stolen Memory lock.
7:0	RW/L	00h	<b>Channel 1 DRAM Rank-2 Attributes (C1DRA2):</b> See C0DRA2 register. This register is locked by ME stolen Memory lock.



### 5.2.23 C1CYCTRPCHG—Channel 1 CYCTRK PCHG

B/D/F/Type: 0/0/0/MCHBAR  
Address Offset: 650–651h  
Default Value: 0000h  
Access: RW, RO  
Size: 16 bits

Channel 1 CYCTRK Precharge registers.

Bit	Access	Default Value	Description
15:11	RO	00000b	Reserved
10:6	RW	00000b	<b>Write To PRE Delayed (C1sd_cr_wr_pchg)</b> : This field indicates the minimum allowed spacing (in DRAM clocks) between the WRITE and PRE commands to the same rank-bank. This field corresponds to $t_{WR}$ in the DDR Specification.
5:2	RW	0000b	<b>READ To PRE Delayed (C1sd_cr_rd_pchg)</b> : This field indicates the minimum allowed spacing (in DRAM clocks) between the READ and PRE commands to the same rank-bank
1:0	RW	00b	<b>PRE To PRE Delayed (C1sd_cr_pchg_pchg)</b> : This field indicates the minimum allowed spacing (in DRAM clocks) between two PRE commands to the same rank.



### 5.2.24 C1CYCTRKACT—Channel 1 CYCTRK ACT

B/D/F/Type: 0/0/0/MCHBAR  
 Address Offset: 652–655h  
 Default Value: 00000000h  
 Access: RO, RW  
 Size: 32 bits

Channel 1 CYCTRK ACT registers.

Bit	Access	Default Value	Description
31:28	RO	0h	Reserved
27:22	RW	000000b	<b>ACT Window Count (C1sd_cr_act_windowcnt)</b> : This field indicates the window duration (in DRAM clocks) during which the controller counts the # of activate commands which are launched to a particular rank. If the number of activate commands launched within this window is greater than 4, then a check is implemented to block launch of further activates to this rank for the rest of the duration of this window.
21	RW	0b	<b>Max ACT Check Disable (C1sd_cr_maxact_dischk)</b> : This field enables the check which ensures that there are no more than four activates to a particular rank in a given window.
20:17	RW	0000b	<b>ACT to ACT Delayed (C1sd_cr_act_actl)</b> : This field indicates the minimum allowed spacing (in DRAM clocks) between two ACT commands to the same rank. Corresponds to $t_{RRD}$ in the DDR Specification.
16:13	RW	0000b	<b>PRE to ACT Delayed (C1sd_cr_pre_act)</b> : This field indicates the minimum allowed spacing (in DRAM clocks) between the PRE and ACT commands to the same rank-bank: 12:9R/W0000bPRE-ALL to ACT Delayed (C1sd_cr_preall_act): This field indicates the minimum allowed spacing (in DRAM clocks) between the PRE-ALL and ACT commands to the same rank. This field corresponds to $t_{RP}$ in the DDR Specification.
12:9	RW	0h	<b>ALLPRE to ACT Delay (C1sd_cr_preall_act)</b> : From the launch of a prechargeall command wait for these many # of mclks before launching a activate command. This field corresponds to $t_{PALL\_RP}$
8:0	RW	00000000b	<b>REF to ACT Delayed (C1sd_cr_rfsh_act)</b> : This field indicates the minimum allowed spacing (in DRAM clocks) between REF and ACT commands to the same rank. This field corresponds to $t_{RFC}$ in the DDR Specification.



### 5.2.25 C1CYCTRKWR—Channel 1 CYCTRK WR

B/D/F/Type: 0/0/0/MCHBAR  
 Address Offset: 656–657h  
 Default Value: 0000h  
 Access: RW  
 Size: 16 bits

Channel 1 CYCTRK WR registers.

Bit	Access	Default Value	Description
15:12	RW	0h	<b>ACT To Write Delay (C1sd_cr_act_wr):</b> This field indicates the minimum allowed spacing (in DRAM clocks) between the ACT and WRITE commands to the same rank-bank. This field corresponds to $t_{RCD\_wr}$ in the DDR Specification.
11:8	RW	0h	<b>Same Rank Write To Write Delayed (C1sd_cr_wrsr_wr):</b> This field register indicates the minimum allowed spacing (in DRAM clocks) between two WRITE commands to the same rank.
7:4	RW	0h	<b>Different Rank Write to Write Delay (C1sd_cr_wrd_r_wr):</b> This field indicates the minimum allowed spacing (in DRAM clocks) between two WRITE commands to different ranks. This field corresponds to $t_{WR\_WR}$ in the DDR Specification.
3:0	RW	0h	<b>READ To WRTE Delay (C1sd_cr_rd_wr):</b> This field indicates the minimum allowed spacing (in DRAM clocks) between the READ and WRITE commands. This field corresponds to $t_{RD\_WR}$ .

### 5.2.26 C1CYCTRKRD—Channel 1 CYCTRK READ

B/D/F/Type: 0/0/0/MCHBAR  
 Address Offset: 658–65Ah  
 Default Value: 000000h  
 Access: RW, RO  
 Size: 24 bits

Channel 1 CYCTRK READ registers.

Bit	Access	Default Value	Description
23:21	RO	0h	Reserved
20:17	RW	0h	<b>Min ACT To READ Delayed (C1sd_cr_act_rd):</b> This field indicates the minimum allowed spacing (in DRAM clocks) between the ACT and READ commands to the same rank-bank. This field Corresponds to $t_{RCD\_rd}$ in the DDR Specification
16:12	RW	00000b	<b>Same Rank Write To READ Delayed (C1sd_cr_wrsr_rd):</b> This field indicates the minimum allowed spacing (in DRAM clocks) between the WRITE and READ commands to the same rank. This field corresponds to $t_{WTR}$ in the DDR Specification.
11:8	RW	0000b	<b>Different Ranks Write To READ Delayed (C1sd_cr_wrd_r_rd):</b> This field indicates the minimum allowed spacing (in DRAM clocks) between the WRITE and READ commands to different ranks. This field corresponds to $t_{WR\_RD}$ in the DDR Specification.
7:4	RW	0000b	<b>Same Rank Read To Read Delayed (C1sd_cr_rdsr_rd):</b> This field indicates the minimum allowed spacing (in DRAM clocks) between two READ commands to the same rank.
3:0	RW	0000b	<b>Different Ranks Read To Read Delayed (C1sd_cr_rddr_rd):</b> This field indicates the minimum allowed spacing (in DRAM clocks) between two READ commands to different ranks. This field corresponds to $t_{RD\_RD}$ .



### 5.2.27 C1CKECTRL—Channel 1 CKE Control

B/D/F/Type: 0/0/0/MCHBAR  
 Address Offset: 660–663h  
 Default Value: 00000800h  
 Access: RO, RW/L, RW  
 Size: 32 bits

Channel 1 CKE Control registers.

Bit	Access	Default Value	Description
31:28	RO	0h	Reserved
27	RW	0b	<b>Start the Self-Refresh Exit Sequence (sd1_cr_srcstart):</b> This bit indicates the request to start the self-refresh exit sequence
26:24	RW	000b	<b>CKE Pulse Width Requirement in High Phase (sd1_cr_cke_pw_hi_safe):</b> This bit indicates CKE pulse width requirement in high phase. This field corresponds to $t_{CKE}$ (high) in the DDR Specification.
23	RW/L	0b	<b>Rank 3 Population (sd1_cr_rankpop3):</b> 1 = Rank 3 populated 0 = Rank 3 not populated This register is locked by ME stolen Memory lock.
22	RW/L	0b	<b>Rank 2 Population (sd1_cr_rankpop2):</b> 1 = Rank 2 populated 0 = Rank 2 not populated This register is locked by ME stolen Memory lock.
21	RW/L	0b	<b>Rank 1 Population (sd1_cr_rankpop1):</b> 1 = Rank 1 populated 0 = Rank 1 not populated This register is locked by ME stolen Memory lock.
20	RW/L	0b	<b>Rank 0 Population (sd1_cr_rankpop0):</b> 1 = Rank 0 populated 0 = Rank 0 not populated This register is locked by ME stolen Memory lock.
19:17	RW	000b	<b>CKE Pulse Width Requirement in Low Phase (sd1_cr_cke_pw_lh_safe):</b> This field indicates CKE pulse width requirement in low phase. This field corresponds to $t_{CKE}$ (low) in the DDR Specification.
16	RW	0b	<b>Enable CKE Toggle for PDN Entry/Exit (sd1_cr_pdn_enable):</b> This bit indicates that the toggling of CKEs (for PDN entry/exit) is enabled.
15:14	RO	00b	Reserved
13:10	RW	0010b	<b>Minimum Powerdown Exit to Non-Read Command Spacing (sd1_cr_txp):</b> This field indicates the minimum number of clocks to wait following assertion of CKE before issuing a non-read command. 1010–1111 = Reserved. 0010–1001 = 2–9 clocks 0000–0001 = Reserved.
9:1	RW	00000000b	<b>Self Refresh Exit Count (sd1_cr_slfrfsh_exit_cnt):</b> This configuration register indicates the Self refresh exit count. (Program to 255) Corresponds to $t_{XSNR}/t_{XSRD}$ in the DDR Specification.
0	RW	0b	<b>Indicates Only 1 DIMM Populated (sd1_cr_singledimmpop):</b> This field indicates the that only 1 DIMM is populated.



### 5.2.28 C1REFRCTRL—Channel 1 DRAM Refresh Control

B/D/F/Type: 0/0/0/MCHBAR  
 Address Offset: 669–66Eh  
 Default Value: 021830000C30h  
 Access: RW, RO  
 Size: 48 bits

This register provides the settings to configure the DRAM refresh controller.

Bit	Access	Default Value	Description
47:42	RO	00h	Reserved
41:37	RW	10000b	<b>Direct Rcomp Quiet Window (DIRQUIET):</b> This configuration setting indicates the amount of refresh_tick events to wait before the service of rcomp request in non-default mode of independent rank refresh.
36:32	RW	11000b	<b>Indirect Rcomp Quiet Window (INDIRQUIET):</b> This configuration setting indicates the amount of refresh_tick events to wait before the service of rcomp request in non-default mode of independent rank refresh.
31:27	RW	00110b	<b>Rcomp Wait (RCOMPWAIT):</b> This configuration setting indicates the amount of refresh_tick events to wait before the service of rcomp request in non-default mode of independent rank refresh.
26	RO	0b	Reserved
25	RW	0b	<b>Refresh Counter Enable (REFCNTEN):</b> This bit is used to enable the refresh counter to count during times that DRAM is not in self-refresh, but refreshes are not enabled. Such a condition may occur due to need to reprogram DIMMs following DRAM controller switch. This bit has no effect when Refresh is enabled (i.e. there is no mode where Refresh is enabled but the counter does not run) So, in conjunction with bit 23 REFEN, the modes are: <b>[REFEN:REFCNTEN]Description</b> [0:0]           Normal refresh disable [0:1]           Refresh disabled, but counter is accumulating refreshes. [1:X]           Normal refresh enable
24	RW	0b	<b>All Rank Refresh (ALLRKREF):</b> This configuration bit enables (by default) that all the ranks are refreshed in a staggered/atomic fashion. If set, the ranks are refreshed in an independent fashion.
23	RW	0b	<b>Refresh Enable (REFEN):</b> Refresh is enabled. 0 = Disabled 1 = Enabled
22	RW	0b	<b>DDR Initialization Done (INITDONE):</b> Indicates that DDR initialization is complete.
21:20	RO	00b	Reserved
19:18	RW	00b	<b>DRAM Refresh Panic Watermark (REFPANICWWM):</b> When the refresh count exceeds this level, a refresh request is launched to the scheduler and the dref_panic flag is set. 00 = 5 01 = 6 10 = 7 11 = 8





Bit	Access	Default Value	Description
17:16	RW	00b	<b>DRAM Refresh High Watermark (REFHIGHWM):</b> When the refresh count exceeds this level, a refresh request is launched to the scheduler and the dref_high flag is set. 00 = 3 01 = 4 10 = 5 11 = 6
15:14	RW	00b	<b>DRAM Refresh Low Watermark (REFLOWWM):</b> When the refresh count exceeds this level, a refresh request is launched to the scheduler and the dref_low flag is set. 00 = 1 01 = 2 10 = 3 11 = 4
13:0	RW	0011000 0110000 b	<b>Refresh Counter Time Out Value (REFTIMEOUT):</b> Program this field with a value that will provide 7.8 us at mclk frequency. At various memory clock frequencies, this results in the following values: 400 Mhz -> C30 hex (Default Value) 533 Mhz -> 104B hex 666 Mhz -> 1450 hex

### 5.2.29 C1ECCERRLOG—Channel 1 ECC Error Log

B/D/F/Type: 0/0/0/MCHBAR  
 Address Offset: 680–687h  
 Default Value: 0000000000000000h  
 Access: RO/P, RO  
 Size: 64 bits

This register is used to store the error status information in ECC enabled configurations, along with the error syndrome and the rank/bank/row/column address information of the address block of main memory of which an error (single bit or multi-bit error) has occurred. Note that the address fields represent the address of the first single or the first multiple bit error occurrence after the error flag bits in the ERRSTS register have been cleared by software. A multiple bit error will overwrite a single bit error. Once the error flag bits are set as a result of an error, this bit field is locked and does not change as a result of a new error until the error flag is cleared by software. Same is the case with error syndrome field, but the following priority needs to be followed if more than one error occurs on one or more of the 4 QWs. MERR on QW0, MERR on QW1, MERR on QW2, MERR on QW3, CERR on QW0, CERR on QW1, CERR on QW2, CERR on QW3.

Bit	Access	Default Value	Description
63:48	RO/P	0000h	<b>Error Column Address (ERRCOL):</b> Row address of the address block of main memory of which an error (single bit or multi-bit error) has occurred.
47:32	RO/P	0000h	<b>Error Row Address (ERRROW):</b> Row address of the address block of main memory of which an error (single bit or multi-bit error) has occurred.
31:29	RO/P	000b	<b>Error Bank Address (ERRBANK):</b> Rank address of the address block of main memory of which an error (single bit or multi-bit error) has occurred.



Bit	Access	Default Value	Description
28:27	RO/P	00b	<b>Error Rank Address (ERRRANK):</b> Rank address of the address block of main memory of which an error (single bit or multi-bit error) has occurred. 00 = rank 0 (DIMM0) 01 = rank 1 (DIMM0) 10 = rank 2 (DIMM1) 11 = rank 3 (DIMM1)
26:24	RO	0h	Reserved
23:16	RO/P	00h	<b>Error Syndrome (ERRSYND):</b> Syndrome that describes the set of bits associated with the first failing quadword.
15:2	RO	0h	Reserved
1	RO/P	0b	<b>Multiple Bit Error Status (MERRSTS):</b> This bit is set when an uncorrectable multiple-bit error occurs on a memory read data transfer. When this bit is set, the address that caused the error and the error syndrome are also logged and they are locked until this bit is cleared. This bit is cleared when it receives an indication that the processor has cleared the corresponding bit in the ERRSTS register.
0	RO/P	0b	<b>Correctable Error Status (CERRSTS):</b> This bit is set when a correctable single-bit error occurs on a memory read data transfer. When this bit is set, the address that caused the error and the error syndrome are also logged and they are locked to further single bit errors, until this bit is cleared. But, a multiple bit error that occurs after this bit is set will over-write the address/error syndrome info. This bit is cleared when it receives an indication that the processor has cleared the corresponding bit in the ERRSTS register.

### 5.2.30 C1ODTCTRL—Channel 1 ODT Control

B/D/F/Type: 0/0/0/MCHBAR  
 Address Offset: 69C–69Fh  
 Default Value: 00000000h  
 Access: RO, RW  
 Size: 32 bits

This register provides ODT controls.

Bit	Access	Default Value	Description
31:12	RO	00000h	Reserved
11:8	RW	0h	<b>DRAM ODT for Read Commands (sd1_cr_odt_duration_rd):</b> Specifies the duration in MDCLKs to assert DRAM ODT for Read Commands. The Async value should be used when the Dynamic Powerdown bit is set. Else use the Sync value.
7:4	RW	0h	<b>DRAM ODT for Write Commands (sd1_cr_odt_duration_wr):</b> Specifies the duration in MDCLKs to assert DRAM ODT for Write Commands. The Async value should be used when the Dynamic Powerdown bit is set. Else use the Sync value.
3:0	RW	0h	<b>MCH ODT for Read Commands (sd1_cr_mchodt_duration):</b> Specifies the duration in MDCLKs to assert MCH ODT for Read Commands



### 5.2.31 EPCODRB0—EP Channel 0 DRAM Rank Boundary Address 0

B/D/F/Type: 0/0/0/MCHBAR  
 Address Offset: A00–A01h  
 Default Value: 0000h  
 Access: RW, RO  
 Size: 16 bits

Bit	Access	Default Value	Description
15:10	RO	000000b	Reserved
9:0	RW	000h	<b>Channel 0 Dram Rank Boundary Address 0 (CODRBA0):</b>

### 5.2.32 EPCODRB1—EP Channel 0 DRAM Rank Boundary Address 1

B/D/F/Type: 0/0/0/MCHBAR  
 Address Offset: A02–A03h  
 Default Value: 0000h  
 Access: RW, RO  
 Size: 16 bits

See CODRBA0 register.

Bit	Access	Default Value	Description
15:10	RO	000000b	Reserved
9:0	RW	000h	<b>Channel 0 Dram Rank Boundary Address 1 (CODRBA1):</b>

### 5.2.33 EPCODRB2—EP Channel 0 DRAM Rank Boundary Address 2

B/D/F/Type: 0/0/0/MCHBAR  
 Address Offset: A04–A05h  
 Default Value: 0000h  
 Access: RW, RO  
 Size: 16 bits

See CODRBA0 register.

Bit	Access	Default Value	Description
15:10	RO	000000b	Reserved
9:0	RW	000h	<b>Channel 0 DRAM Rank Boundary Address 2 (CODRBA2):</b>



### 5.2.34 EPCODRB3—EP Channel 0 DRAM Rank Boundary Address 3

B/D/F/Type: 0/0/0/MCHBAR  
 Address Offset: A06–A07h  
 Default Value: 0000h  
 Access: RW, RO  
 Size: 16 bits

See C0DRB0 register.

Bit	Access	Default Value	Description
15:10	RO	000000b	Reserved
9:0	RW	000h	<b>Channel 0 DRAM Rank Boundary Address 3 (C0DRBA3):</b>

### 5.2.35 EPCODRA01—EP Channel 0 DRAM Rank 0,1 Attribute

B/D/F/Type: 0/0/0/MCHBAR  
 Address Offset: A08–A09h  
 Default Value: 0000h  
 Access: RW  
 Size: 16 bits

The DRAM Rank Attribute Registers define the page sizes/number of banks to be used when accessing different ranks. These registers should be left with their default value (all zeros) for any rank that is unpopulated, as determined by the corresponding CxDRB registers. Each byte of information in the CxDRA registers describes the page size of a pair of ranks. Channel and rank map:

- Ch0 Rank0, 1: 108h–109h
- Ch0 Rank2, 3: 10Ah–10Bh
- Ch1 Rank0, 1: 188h–189h
- Ch1 Rank2, 3: 18Ah–18Bh

Bit	Access	Default Value	Description
15:8	RW	00h	<b>Channel 0 DRAM Rank-1 Attributes (C0DRA1):</b> This register defines DRAM pagesize/number-of-banks for rank1 for given channel.
7:0	RW	00h	<b>Channel 0 DRAM Rank-0 Attributes (C0DRA0):</b> This register defines DRAM pagesize/number-of-banks for rank0 for given channel.



### 5.2.36 EPCODRA23—EP Channel 0 DRAM Rank 2,3 Attribute

B/D/F/Type: 0/0/0/MCHBAR  
 Address Offset: A0A–A0Bh  
 Default Value: 0000h  
 Access: RW  
 Size: 16 bits

See CODRA01 register.

Bit	Access	Default Value	Description
15:8	RW	00h	<b>Channel 0 DRAM Rank-3 Attributes (CODRA3):</b> This register defines DRAM pagesize/number-of-banks for rank3 for given channel.
7:0	RW	00h	<b>Channel 0 DRAM Rank-2 Attributes (CODRA2):</b> This register defines DRAM pagesize/number-of-banks for rank2 for given channel.

### 5.2.37 EPDCYTRKWRTPRE—EPD CYTRK WRT PRE

B/D/F/Type: 0/0/0/MCHBAR  
 Address Offset: A19–A1Ah  
 Default Value: 0000h  
 Access: RW, RO  
 Size: 16 bits

EPD CYTRK WRT PRE Status registers.

Bit	Access	Default Value	Description
15:11	RW	00000b	<b>ACT To PRE Delayed (C0sd_cr_act_pchg):</b> This field indicates the minimum allowed spacing (in DRAM clocks) between the ACT and PRE commands to the same rank-bank
10:6	RW	00000b	<b>Write To PRE Delayed (C0sd_cr_wr_pchg):</b> This field indicates the minimum allowed spacing (in DRAM clocks) between the WRITE and PRE commands to the same rank-bank
5:2	RW	0000b	<b>READ To PRE Delayed (C0sd_cr_rd_pchg):</b> This field indicates the minimum allowed spacing (in DRAM clocks) between the READ and PRE commands to the same rank-bank
1:0	RO	00b	Reserved



### 5.2.38 EPDCYCTRKWRTACT—EPD CYCTRK WRT ACT

B/D/F/Type: 0/0/0/MCHBAR  
 Address Offset: A1C–A1Fh  
 Default Value: 00000000h  
 Access: RO, RW  
 Size: 32 bits

EPD CYCTRK WRT ACT Status registers.

Bit	Access	Default Value	Description
31:21	RO	000h	Reserved
20:17	RW	0000b	<b>ACT to ACT Delayed (C0sd_cr_act_act[])</b> : This configuration register indicates the minimum allowed spacing (in DRAM clocks) between two ACT commands to the same rank.
16:13	RW	0000b	<b>PRE to ACT Delayed (C0sd_cr_pre_act)</b> : This field indicates the minimum allowed spacing (in DRAM clocks) between the PRE and ACT commands to the same rank-bank: 12:9R/W0000bPRE-ALL to ACT Delayed (C0sd_cr_preall_act): This configuration register indicates the minimum allowed spacing (in DRAM clocks) between the PRE-ALL and ACT commands to the same rank.
12:9	RO	0h	Reserved
8:0	RW	00000000b	<b>REF to ACT Delayed (C0sd_cr_rfsh_act)</b> : This configuration register indicates the minimum allowed spacing (in DRAM clocks) between REF and ACT commands to the same rank.

### 5.2.39 EPDCYCTRKWRTWR—EPD CYCTRK WRT WR

B/D/F/Type: 0/0/0/MCHBAR  
 Address Offset: A20–A21h  
 Default Value: 0000h  
 Access: RW, RO  
 Size: 16 bits

EPD CYCTRK WRT WR Status registers.

Bit	Access	Default Value	Description
15:12	RW	0h	<b>ACT To Write Delay (C0sd_cr_act_wr)</b> : This field indicates the minimum allowed spacing (in DRAM clocks) between the ACT and WRITE commands to the same rank-bank
11:8	RW	0h	<b>Same Rank Write To Write Delayed (C0sd_cr_wrsr_wr)</b> : This field indicates the minimum allowed spacing (in DRAM clocks) between two WRITE commands to the same rank.
7:4	RO	0h	Reserved
3:0	RW	0h	<b>Same Rank WRITE to READ Delay (C0sd_cr_rd_wr)</b> : This field indicates the minimum allowed spacing (in DRAM clocks) between the WRITE and READ commands to the same rank.



### 5.2.40 EPDCYCTRKWRTREF—EPD CYCTRK WRT REF

B/D/F/Type: 0/0/0/MCHBAR  
 Address Offset: A22–A23h  
 Default Value: 0000h  
 Access: RO, RW  
 Size: 16 bits  
 BIOS Optimal Default 0h

EPD CYCTRK WRT ACT Status registers.

Bit	Access	Default Value	Description
15:9	RO	0s	Reserved
8:0	RW	00000000b	<b>Different Rank REF to REF Delayed (C0sd_cr_rfsh_rfsh):</b> This configuration register indicates the minimum allowed spacing (in DRAM clocks) between two REF commands to different ranks.

### 5.2.41 EPDCYCTRKWRTRD—EPD CYCTRK WRT READ

B/D/F/Type: 0/0/0/MCHBAR  
 Address Offset: A24–A26h  
 Default Value: 000000h  
 Access: RW  
 Size: 24 bits  
 BIOS Optimal Default 000h

EPD CYCTRK WRT RD Status registers.

Bit	Access	Default Value	Description
23:23	RO	0h	Reserved
22:20	RW	000b	<b>EPDunit DQS Slave DLL Enable to Read Safe (EPDSDL2RD):</b> Configuration setting for Read command safe from the point of enabling the slave DLLs.
19:18	RO	0h	Reserved
17:14	RW	0h	<b>Min ACT To READ Delayed (C0sd_cr_act_rd):</b> This field indicates the minimum allowed spacing (in DRAM clocks) between the ACT and READ commands to the same rank-bank
13:9	RW	00000b	<b>Same Rank READ to WRITE Delayed (C0sd_cr_wrsr_rd):</b> This field indicates the minimum allowed spacing (in DRAM clocks) between the READ and WRITE commands.
8:6	RO	0h	Reserved
5:3	RW	000b	<b>Same Rank Read To Read Delayed (C0sd_cr_rdsr_rd):</b> This field indicates the minimum allowed spacing (in DRAM clocks) between two READ commands to the same rank.
2:0	RO	0h	Reserved



### 5.2.42 EPDCKECONFIGREG—EPD CKE Related Configuration

B/D/F/Type: 0/0/0/MCHBAR  
 Address Offset: A28–A2Ch  
 Default Value: 00E000000h  
 Access: RW  
 Size: 40 bits  
 BIOS Optimal Default 0h

CKE related configuration registers For EPD.

Bit	Access	Default Value	Description
39:35	RW	00000b	<b>EPDunit TXPDLL Count (EPDTPDLL)</b> : Specifies the delay from precharge power down exit to a command that requires the DRAM DLL to be operational. The commands are read/write.
34:32	RW	000b	<b>EPDunit TXP Count (EPDCKETXP)</b> : Specifies the timing requirement for Active power down exit or fast exit pre-charge power down exit to any command or slow exit pre-charge power down to Non-DLL (rd/wr/odt) command.
31:29	RW	111b	<b>Mode Select (sd0_cr_sms)</b> : Mode Select register: This configuration setting indicates the mode in which the controller is operating in. 111 = Indicates normal mode of operation, else special mode of operation.
28:27	RW	00b	<b>EPDunit EMRS Command Select. (EPDEMRSEL)</b> : EMRS mode to select BANK address. 01 = EMRS 10 = EMRS2 11 = EMRS3
26:24	RW	000b	<b>CKE Pulse Width Requirement in High Phase (sd0_cr_cke_pw_hi_safe)</b> : This field indicates CKE pulse width requirement in high phase.
23:20	RW	0h	<b>One-Hot Active Rank Population (ep_scr_actrank)</b> : This field indicates the active rank in a one hot manner
19:17	RW	000b	<b>CKE Pulse Width Requirement in Low Phase (sd0_cr_cke_pw_lh_safe)</b> : This field indicates CKE pulse width requirement in low phase.
16:15	RO	0h	Reserved
14	RW	0b	<b>EPDunit MPR Mode (EPDMPR)</b> : MPR Read Mode 1 = MPR mode 0 = Normal mode In MPR mode, only read cycles must be issued by Firmware. Page Results are ignored by DCS and just issues the read chip select.
13	RW	0b	<b>EPDunit Power Down enable for ODT Rank (EPDOAPDEN)</b> : Configuration to enable the ODT ranks to dynamically enter power down. 1 = Enable active power down. 0 = Disable active power down.
12	RW	0b	<b>EPDunit Power Down enable for Active Rank (EPDAAPDEN)</b> : Configuration to enable the active rank to dynamically enter power down. 1 = Enable active power down. 0 = Disable active power down.
11:10	RO	0h	Reserved
9:1	RW	0000000 00b	<b>Self Refresh Exit Count (sd0_cr_slfrfsh_exit_cnt)</b> : This field indicates the Self refresh exit count. (Program to 255)





Bit	Access	Default Value	Description
0	RW	0b	<b>Indicates Only 1 Rank Enabled (sd0_cr_singledimmpop):</b> This field indicates the that only 1 rank is enabled. This bit needs to be set if there is one active rank and no odt ranks, or if there is one active rank and one ODT rank and they are the same rank.

### 5.2.43 EPDREFCONFIG—EP DRAM Refresh Configuration

B/D/F/Type: 0/0/0/MCHBAR  
 Address Offset: A30–A33h  
 Default Value: 40000C30h  
 Access: RW, RO  
 Size: 32 bits

This register provides the settings to configure the EPD refresh controller.

Bit	Access	Default Value	Description
31	RO	0b	Reserved
30:29	RW	10b	<b>EPDunit refresh count addition for self refresh exit. (EPDREF4SR):</b> Configuration indicating the number of additional refreshes that needs to be added to the refresh request count after exiting self refresh. Typical value is to add 2 refreshes. 00 = Add 0 Refreshes 01 = Add 1 Refreshes 10 = Add 2 Refreshes 11 = Add 3 Refreshes
28	RW	0b	<b>Refresh Counter Enable (REFCNTEN):</b> This bit is used to enable the refresh counter to count during times that DRAM is not in self-refresh, but refreshes are not enabled. Such a condition may occur due to need to reprogram DIMMs following DRAM controller switch. This bit has no effect when Refresh is enabled (i.e., there is no mode where Refresh is enabled but the counter does not run) So, in conjunction with bit [23] REFEN, the modes are: <b>[REFEN:REFCNTEN] Description</b> [0:0] Normal refresh disable [0:1] Refresh disabled, but counter is accumulating refreshes. [1:X] Normal refresh enable
27	RW	0b	<b>Refresh Enable (REFEN):</b> Refresh is enabled. 0 = Disabled 1 = Enabled
26	RW	0b	<b>DDR Initialization Done (INITDONE):</b> Indicates that DDR initialization is complete.
25:22	RW	0000b	<b>DRAM Refresh Hysteresis (REFHYSTERISIS):</b> Hysteresis level - Useful for dref_high watermark cases. The dref_high flag is set when the dref_high watermark level is exceeded, and is cleared when the refresh count is less than the hysteresis level. This bit should be set to a value less than the high watermark level. 0000 = 0 0001 = 1 ..... 1000 = 8



Bit	Access	Default Value	Description
21:18	RW	0000b	<p><b>DRAM Refresh High Watermark (REFHIGHWM):</b> When the refresh count exceeds this level, a refresh request is launched to the scheduler and the dref_high flag is set.</p> <p>0000 = 0            0001 = 1            .....            1000 = 8</p>
17:14	RW	0000b	<p><b>DRAM Refresh Low Watermark (REFLOWWM):</b> When the refresh count exceeds this level, a refresh request is launched to the scheduler and the dref_low flag is set.</p> <p>0000 = 0            0001 = 1            .....            1000 = 8</p>
13:0	RW	00110000 110000b	<p><b>Refresh Counter Time Out Value (REFTIMEOUT):</b> Program this field with a value that will provide 7.8 us at mclk frequency.</p> <p>At various mclk frequencies, this results in the following values:            400 Mhz -&gt; C30 hex (Default Value)            533 Mhz -&gt; 104B hex            666 Mhz -&gt; 1450 hex</p>



### 5.2.44 TSC1—Thermal Sensor Control 1

B/D/F/Type: 0/0/0/MCHBAR  
 Address Offset: CD8h  
 Default Value: 00h  
 Access: RW/L, RW, RS/WC  
 Size: 8 bits

This register controls the operation of the thermal sensor.

Bits 7:1 of this register are reset to their defaults by MPWROK.

Bit 0 is reset to its default by PLTRST#.

Bit	Access	Default Value	Description
7	RW/L	0b	<b>Thermal Sensor Enable (TSE):</b> This bit enables power to the thermal sensor. Lockable via TCO bit [7]. 0 = Disabled 1 = Enabled
6	RW	0b	<b>Analog Hysteresis Control (AHC):</b> This bit enables the analog hysteresis control to the thermal sensor. When enabled, about 1 degree of hysteresis is applied. This bit should normally be off in thermometer mode since the thermometer mode of the thermal sensor defeats the usefulness of analog hysteresis. 0 = Hysteresis disabled 1 = Analog hysteresis enabled.
5:2	RW	0000b	<b>Digital Hysteresis Amount (DHA):</b> This bit determines whether no offset, 1 LSB, 2... 15 is used for hysteresis for the trip points. 0000 = Digital hysteresis disabled, no offset added to trip temperature 0001 = Offset is 1 LSB added to each trip temperature when tripped ... 0110 = ~3.0 °C (Recommended setting) ... 1110 = Added to each trip temperature when tripped 1111 = Added to each trip temperature when tripped
1	RW/L	0b	<b>Thermal Sensor Comparator Select (TSCS):</b> This bit multiplexes between the two analog comparator outputs. Normally Catastrophic is used. Lockable via TCO bit [7]. 0 = Catastrophic 1 = Hot



Bit	Access	Default Value	Description
0	RS/WC	0b	<p><b>In Use (IU):</b> Software semaphore bit.</p> <p>After a full MCH RESET, a read to this bit returns a 0.</p> <p>After the first read, subsequent reads will return a 1.</p> <p>A write of a 1 to this bit will reset the next read value to 0.</p> <p>Writing a 0 to this bit has no effect.</p> <p>Software can poll this bit until it reads a 0, and will then own the usage of the thermal sensor.</p> <p>This bit has no other effect on the hardware, and is only used as a semaphore among various independent software threads that may need to use the thermal sensor.</p> <p>Software that reads this register but does not intend to claim exclusive access of the thermal sensor must write a one to this bit if it reads a 0, in order to allow other software threads to claim it.</p> <p>See also THERM3 bit 7 and IUB, which are independent additional semaphore bits.</p>

### 5.2.45 TSC2—Thermal Sensor Control 2

B/D/F/Type: 0/0/0/MCHBAR  
Address Offset: CD9h  
Default Value: 00h  
Access: RO, RW/L  
Size: 8 bits

This register controls the operation of the thermal sensor.

All bits in this register are reset to their defaults by MPWROK.

Bit	Access	Default Value	Description
7:4	RO	0h	Reserved



Bit	Access	Default Value	Description
3:0	RW/L	0h	<p><b>Thermometer Mode Enable and Rate (TE):</b> If analog thermal sensor mode is not enabled by setting these bits to 0000b, these bits enable the thermometer mode functions and set the Thermometer controller rate.</p> <p>When the Thermometer mode is disabled and TSC1[TSE] =enabled, the analog sensor mode should be fully functional. In the analog sensor mode, the Catastrophic trip is functional, and the Hot trip is functional at the offset below the catastrophic programmed into TSC2[CHO]. The other trip points are not functional in this mode.</p> <p>When Thermometer mode is enabled, all the trip points (Catastrophic, Hot, Aux0) will all operate using the programmed trip points and Thermometer mode rate.</p> <p>Note: When disabling the Thermometer mode while thermometer running, the Thermometer mode controller will finish the current cycle.</p> <p>Note: During boot, all other thermometer mode registers (except lock bits) should be programmed appropriately before enabling the Thermometer Mode. Clocks are memory clocks.</p> <p>Note: Since prior MCHs counted the thermometer rate in terms of host clocks rather than memory clocks, the clock count for each setting listed below has been doubled from what is was on those MCHs. This should make the actual thermometer rate approximately equivalent across products.</p> <p>Lockable via TCO bit 7.</p> <p>0000 = Thermometer mode disabled (i.e, analog sensor mode)                      0001 = enabled, 512 clock mode                      0010 = enabled, 1024 clock mode (normal Thermometer mode operation),                      provides ~3.85 us settling time @ 266 MHz                      provides ~3.08 us settling time @ 333 MHz                      provides ~2.56 us settling time @ 400 MHz                      0011 = enabled, 1536 clock mode                      0100 = enabled, 2048 clock mode                      0101 = enabled, 3072 clock mode                      0110 = enabled, 4096 clock mode                      0111 = enabled, 6144 clock mode                      provides ~23.1 us settling time @ 266 MHz                      provides ~18.5 us settling time @ 333 MHz                      provides ~15.4 us settling time @ 400 MHz                      all other permutations reserved                      1111 = enabled, 4 clock mode (for testing digital logic)</p>



## 5.2.46 TSS—Thermal Sensor Status

B/D/F/Type: 0/0/0/MCHBAR  
Address Offset: CDAh  
Default Value: 00h  
Access: RO  
Size: 8 bits

This read only register provides trip point and other status of the thermal sensor.

All bits in this register are reset to their defaults by MPWROK.

Bit	Access	Default Value	Description
7	RO	0b	<b>Catastrophic Trip Indicator (CTI):</b> A 1 indicates that the internal thermal sensor temperature is above the catastrophic setting.
6	RO	0b	<b>Hot Trip Indicator (HTI):</b> A 1 indicates that the internal thermal sensor temperature is above the Hot setting.
5	RO	0b	<b>Aux0 Trip Indicator (AOTI):</b> A 1 indicates that the internal thermal sensor temperature is above the Aux0 setting.
4	RO	0b	<b>Thermometer Mode Output Valid (TOV):</b> A 1 indicates the Thermometer mode is able to converge to a temperature and that the TR register is reporting a reasonable estimate of the thermal sensor temperature. A 0 indicates the Thermometer mode is off, or that temperature is out of range, or that the TR register is being looked at before a temperature conversion has had time to complete.
3:2	RO	00b	Reserved
1	RO	0b	<b>Direct Catastrophic Comparator Read (DCCR):</b> This bit reads the output of the Catastrophic comparator directly, without latching via the Thermometer mode circuit. Used for testing.
0	RO	0b	<b>Direct Hot Comparator Read (DHCR):</b> This bit reads the output of the Hot comparator directly, without latching via the Thermometer mode circuit. Used for testing.



### 5.2.47 TSTTP—Thermal Sensor Temperature Trip Point

B/D/F/Type: 0/0/0/MCHBAR  
 Address Offset: CDC–CDFh  
 Default Value: 00000000h  
 Access: RO, RW, RW/L  
 Size: 32 bits

This register provides the following:

- Sets the target values for the trip points in thermometer mode. See also TST[Direct DAC Connect Test Enable].
- Reports the relative thermal sensor temperature.

All bits in this register are reset to their defaults by MPWROK.

Bit	Access	Default Value	Description
31:24	RO	00h	<b>Relative Temperature (RELT):</b> In Thermometer mode, the RELT field of this register report the relative temperature of the thermal sensor. Provides a two's complement value of the thermal sensor relative to the Hot Trip Point. Temperature above the Hot Trip Point will be positive. TR and HTPS can both vary between 0 and 255. But RELT will be clipped between ±127 to keep it an 8 bit number. See also TSS[Thermometer mode Output Valid] In the Analog mode, the RELT field reports HTPS value.
23:16	RW	00h	<b>Aux0 Trip point setting (A0TPS):</b> Sets the target for the Aux0 trip point.
15:8	RW/L	00h	<b>Hot Trip Point Setting (HTPS):</b> Sets the target value for the Hot trip point. Lockable via TCO bit 7.
7:0	RW/L	00h	<b>Catastrophic Trip Point Setting (CTPS):</b> Sets the target for the Catastrophic trip point. See also TST[Direct DAC Connect Test Enable]. Lockable via TCO bit 7.



### 5.2.48 TCO—Thermal Calibration Offset

B/D/F/Type: 0/0/0/MCHBAR  
 Address Offset: CE2h  
 Default Value: 00h  
 Access: RW/L/K, RW/L  
 Size: 8 bits

Bit 7: reset to it's default by PLTRST#

Bits 6:0 reset to their defaults by MPWROK

Bit	Access	Default Value	Description
7	RW/L/K	0b	<b>Lock Bit for Catastrophic (LBC):</b> This bit, when written to a 1, locks the Catastrophic programming interface, including bits [7:0] of this register and bits [15:0] of TSTTP, bits [1],[7] of TSC 1, bits [3:0] of TSC 2, bits [4:0] of TSC 3, and bits [0],[7] of TST. This bit may only be set to a 0 by a hardware reset (PLTRST#). Writing a 0 to this bit has no effect.
6:0	RW/L	00h	<b>Calibration Offset (CO):</b> This field contains the current calibration offset for the Thermal Sensor DAC inputs. The calibration offset is a twos complement signed number which is added to the temperature counter value to help generate the final value going to the thermal sensor DAC. This field is Read/Write and can be modified by Software unless locked by setting bit [7] of this register. The fuses cannot be programmed via this register. Once this register has been overwritten by software, the values of the TCO fuses can be read using the Therm3 register. <b>Note for TCO operation:</b> While this is a seven-bit field, the 7th bit is sign extended to 9 bits for TCO operation. The range of 00h to 3fh corresponds to 0 0000 0000 to 0 0011 1111. The range of 41h to 7Fh corresponds to 1 1100 001 (i.e, negative 3Fh) to 1 1111 1111 (i.e, negative 1), respectively.





## 5.2.49 THERM1—Thermal Hardware Protection

B/D/F/Type: 0/0/0/MCHBAR  
 Address Offset: CE4h  
 Default Value: 00h  
 Access: RW/L, RO, RW/L/K  
 Size: 8 bits

All bits in this register are reset to their defaults by PLTRST#.

Bit	Access	Default Value	Description
7:4	RO	0b	Reserved
3	RW/L	0b	<b>Halt on Catastrophic (HOC):</b> 0 = Continue to toggle clocks when the catastrophic sensor trips. 1 = All clocks are disabled when the catastrophic sensor trips. A system reset is required to bring the system out of a halt from the thermal sensor.
2:1	RO	00b	Reserved
0	RW/L/K	0b	<b>Hardware Throttling Lock Bit (HTL):</b> This bit locks bits [7:0] of this register. The register bits are unlocked. 1 = The register bits are locked. It may only be set to a 0 by a hardware reset. Writing a 0 to this bit has no effect.

## 5.2.50 TIS—Thermal Interrupt Status

B/D/F/Type: 0/0/0/MCHBAR  
 Address Offset: CEA–CEBh  
 Default Value: 0000h  
 Access: RO, RWC  
 Size: 16 bits

This register is used to report which specific error condition resulted in the Device 0 Function 0 ERRSTS[Thermal Sensor event for SMI/SCI/SERR] or memory mapped IIR Thermal Event. SW can examine the current state of the thermal zones by examining the TSS. Software can distinguish internal or external Trip Event by examining EXTSCS.

Software must write a 1 to clear the status bits in this register.

Following scenario is possible. An interrupt is initiated on a rising temperature trip, the appropriate DMI cycles are generated, and eventually the software services the interrupt and sees a rising temperature trip as the cause in the status bits for the interrupts. Assume that the software then goes and clears the local interrupt status bit in the TIS register for that trip event. It is possible at this point that a falling temperature trip event occurs before the software has had the time to clear the global interrupts status bit. But since software has already looked at the status register before this event happened, software may not clear the local status flag for this event. Therefore, after the global interrupt is cleared by sw, sw must look at the instantaneous status in the TSS register.

All bits in this register are reset to their defaults by PLTRST#.



Bit	Access	Default Value	Description
15:10	RO	00h	Reserved
9	RWC	0b	<b>Was Catastrophic Thermal Sensor Interrupt Event (WCTSIE):</b> 1 = Indicates that a Catastrophic Thermal Sensor trip based on a higher to lower temperature transition thru the trip point. 0 = No trip for this event
8	RWC	0b	<b>Was Hot Thermal Sensor Interrupt Event (WHTSIE):</b> 1 = Indicates that a Hot Thermal Sensor trip based on a higher to lower temperature transition thru the trip point. 0 = No trip for this event
7	RWC	0b	<b>Was Aux0 Thermal Sensor Interrupt Event (WAOTSIE):</b> 1 = Indicates that an Aux0 Thermal Sensor trip based on a higher to lower temperature transition thru the trip point. 0 = No trip for this event Software must write a 1 to clear this status bit.
6:5	RO	00b	Reserved
4	RWC	0b	<b>Catastrophic Thermal Sensor Interrupt Event (CTSIE):</b> 1 = Indicates that a Catastrophic Thermal Sensor trip event occurred based on a lower to higher temperature transition thru the trip point. 0 = No trip for this event Software must write a 1 to clear this status bit.
3	RWC	0b	<b>Hot Thermal Sensor Interrupt Event (HTSIE):</b> 1 = Indicates that a Hot Thermal Sensor trip event occurred based on a lower to higher temperature transition thru the trip point. 0 = No trip for this event Software must write a 1 to clear this status bit.
2	RWC	0b	<b>Aux0 Thermal Sensor Interrupt Event (AOTSIE):</b> 1 = Indicates that an Aux0 Thermal Sensor trip event occurred based on a lower to higher temperature transition thru the trip point. 0 = No trip for this event Software must write a 1 to clear this status bit.
1:0	RO	00b	Reserved



### 5.2.51 TSMICMD—Thermal SMI Command

B/D/F/Type: 0/0/0/MCHBAR  
 Address Offset: CF1h  
 Default Value: 00h  
 Access: RO, RW  
 Size: 8 bits

This register selects specific errors to generate a SMI DMI special cycle, as enabled by the Device 0 SMI Error Command Register [SMI on MCH Thermal Sensor Trip]. The SMI must not be enabled at the same time as the SERR/SCI for the thermal sensor event.

All bits in this register are reset to their defaults by PLTRST#.

Bit	Access	Default Value	Description
7:3	RO	00h	Reserved
2	RW	0b	<b>SMI on MCH Catastrophic Thermal Sensor Trip (SMGCTST):</b> 1 = Does not mask the generation of an SMI DMI special cycle on a catastrophic thermal sensor trip. 0 = Disable reporting of this condition via SMI messaging.
1	RW	0b	<b>SMI on MCH Hot Thermal Sensor Trip (SMGHTST):</b> 1 = Does not mask the generation of an SMI DMI special cycle on a Hot thermal sensor trip. 0 = Disable reporting of this condition via SMI messaging.
0	RW	0b	<b>SMI on MCH Aux Thermal Sensor Trip (SMGATST):</b> 1 = Does not mask the generation of an SMI DMI special cycle on an Auxiliary thermal sensor trip. 0 = Disable reporting of this condition via SMI messaging.



### 5.2.52 PMSTS—Power Management Status

B/D/F/Type: 0/0/0/MCHBAR  
 Address Offset: F14–F17h  
 Default Value: 00000000h  
 Access: RWC/S, RO  
 Size: 32 bits

This register is Reset by PWROK only.

Bit	Access	Default Value	Description
31:9	RO	000000h	Reserved
8	RWC/S	0b	<p><b>Warm Reset Occurred (WRO):</b> Set by the PMunit whenever a Warm Reset is received, and cleared by PWROK=0.            0 = No Warm Reset occurred.            1 = Warm Reset occurred.</p> <p><b>BIOS Requirement:</b> BIOS can check and clear this bit whenever executing POST code. This way BIOS knows that if the bit is set, then the PMSTS bits [1:0] must also be set, and if not BIOS needs to power-cycle the platform.</p>
7:2	RO	00h	Reserved
1	RWC/S	0b	<p><b>Channel 1 in Self-Refresh (C1SR):</b> Set by power management hardware after Channel 1 is placed in self refresh as a result of a Power State or a Reset Warn sequence.            Cleared by Power management hardware before starting Channel 1 self refresh exit sequence initiated by a power management exit.            Cleared by the BIOS by writing a "1" in a warm reset (Reset# asserted while PWROK is asserted) exit sequence.            0 = Channel 1 not guaranteed to be in Self-Refresh.            1 = Channel 1 in Self-Refresh.</p>
0	RWC/S	0b	<p><b>Channel 0 in Self-Refresh (COSR):</b>            Set by power management hardware after Channel 0 is placed in self refresh as a result of a Power State or a Reset Warn sequence.            Cleared by Power management hardware before starting Channel 0 self refresh exit sequence initiated by a power management exit.            Cleared by the BIOS by writing a "1" in a warm reset (Reset# asserted while PWROK is asserted) exit sequence.            0 = Channel 0 not guaranteed to be in Self-Refresh.            1 = Channel 0 in Self-Refresh.</p>



## 5.3 EPBAR

Table 11. EPBAR Address Map

Address Offset	Register Symbol	Register Name	Default Value	Access
44–47h	EPESD	EP Element Self Description	00000201h	RO, RWO
50–53h	EPL1D	EP Link Entry 1 Description	01000000h	RO, RWO
58–5Fh	EPL1A	EP Link Entry 1 Address	0000000000000000h	RO, RWO
60–63h	EPL2D	EP Link Entry 2 Description	02000002h	RO, RWO
68–6Fh	EPL2A	EP Link Entry 2 Address	0000000000000800h	RO
60–63h	EPL3D	EP Link Entry 3 Description	03000002h	RO, RWO
68–6Fh	EPL3A	EP Link Entry 3 Address	0000000000000800h	RO

### 5.3.1 EPESD—EP Element Self Description

B/D/F/Type: 0/0/0/PXPEPBAR  
 Address Offset: 44–47h  
 Default Value: 00000201h  
 Access: RO, RWO  
 Size: 32 bits

This register provides information about the root complex element containing this Link Declaration Capability.

Bit	Access	Default Value	Description
31:24	RO	00h	<b>Port Number (PN):</b> This field specifies the port number associated with this element with respect to the component that contains this element. Value of 00h indicates to configuration software that this is the default egress port.
23:16	RWO	00h	<b>Component ID (CID):</b> Identifies the physical component that contains this Root Complex Element. <b>BIOS Requirement:</b> Must be initialized according to guidelines in the <i>PCI Express* Isochronous/Virtual Channel Support Hardware Programming Specification (HPS)</i> .
15:8	RO	03h	<b>Number of Link Entries (NLE):</b> Indicates the number of link entries following the Element Self Description. This field reports 3 (two each for PCI Express and one for DMI). Note: For the 3200 MCH, the field reports 2 link entries (one each for PCI Express and DMI).
7:4	RO	0h	Reserved
3:0	RO	1h	<b>Element Type (ET):</b> Indicates the type of the Root Complex Element. Value of 1h represents a port to system memory.



### 5.3.2 EPLE1D—EP Link Entry 1 Description

B/D/F/Type: 0/0/0/PXPEPBAR  
 Address Offset: 50–53h  
 Default Value: 01000000h  
 Access: RO, RWO  
 Size: 32 bits

This register provides the first part of a Link Entry which declares an internal link to another Root Complex Element.

Bit	Access	Default Value	Description
31:24	RO	01h	<b>Target Port Number (TPN):</b> Specifies the port number associated with the element targeted by this link entry (DMI). The target port number is with respect to the component that contains this element as specified by the target component ID.
23:16	RWO	00h	<b>Target Component ID (TCID):</b> Identifies the physical or logical component that is targeted by this link entry. <b>BIOS Requirement:</b> Must be initialized according to guidelines in the <i>PCI Express* Isochronous/Virtual Channel Support Hardware Programming Specification (HPS)</i> .
15:2	RO	0000h	Reserved
1	RO	0b	<b>Link Type (LTYP):</b> Indicates that the link points to memory-mapped space (for RCRB). The link address specifies the 64-bit base address of the target RCRB.
0	RWO	0b	<b>Link Valid (LV):</b> 0 = Link Entry is not valid and will be ignored. 1 = Link Entry specifies a valid link.

### 5.3.3 EPLE1A—EP Link Entry 1 Address

B/D/F/Type: 0/0/0/PXPEPBAR  
 Address Offset: 58–5Fh  
 Default Value: 0000000000000000h  
 Access: RO, RWO  
 Size: 64 bits

This register provides the second part of a Link Entry which declares an internal link to another Root Complex Element.

Bit	Access	Default Value	Description
63:36	RO	0000000h	Reserved
35:12	RWO	000000h	<b>Link Address (LA):</b> Memory mapped base address of the RCRB that is the target element (DMI) for this link entry.
11:0	RO	000h	Reserved



### 5.3.4 EPLE2D—EP Link Entry 2 Description

B/D/F/Type: 0/0/0/PXPEPBAR  
 Address Offset: 60–63h  
 Default Value: 02000002h  
 Access: RO, RWO  
 Size: 32 bits

This register provides the first part of a Link Entry which declares an internal link to another Root Complex Element.

Bit	Access	Default Value	Description
31:24	RO	02h	<b>Target Port Number (TPN):</b> Specifies the port number associated with the element targeted by this link entry (PCI Express). The target port number is with respect to the component that contains this element as specified by the target component ID.
23:16	RWO	00h	<b>Target Component ID (TCID):</b> Identifies the physical or logical component that is targeted by this link entry. A value of 0 is reserved. Component IDs start at 1. This value is a mirror of the value in the Component ID field of all elements in this component. <b>BIOS Requirement:</b> Must be initialized according to guidelines in the <i>PCI Express* Isochronous/Virtual Channel Support Hardware Programming Specification (HPS)</i> .
15:2	RO	0000h	Reserved
1	RO	1b	<b>Link Type (LTYP):</b> Indicates that the link points to configuration space of the integrated device which controls the root port for PCI Express. The link address specifies the configuration address (segment, bus, device, function) of the target root port.
0	RWO	0b	<b>Link Valid (LV):</b> 0 = Link Entry is not valid and will be ignored. 1 = Link Entry specifies a valid link.

### 5.3.5 EPLE2A—EP Link Entry 2 Address

B/D/F/Type: 0/0/0/PXPEPBAR  
 Address Offset: 68–6Fh  
 Default Value: 00000000000008000h  
 Access: RO  
 Size: 64 bits

This register provides the second part of a Link Entry which declares an internal link to another Root Complex Element.

Bit	Access	Default Value	Description
63:28	RO	00000000h	Reserved
27:20	RO	00h	<b>Bus Number (BUSN):</b>
19:15	RO	00001b	<b>Device Number (DEVN):</b> Target for this link is PCI Express port (Device1).
14:12	RO	000b	<b>Function Number (FUNN):</b>
11:0	RO	000h	Reserved



### 5.3.6 EPLE3D—EP Link Entry 3 Description

B/D/F/Type: 0/0/0/PXPEPBAR  
Address Offset: 70–73h  
Default Value: 03000002h  
Access: RO, RWO  
Size: 32 bits

This register provides the first part of a Link Entry which declares an internal link to another Root Complex Element.

Bit	Access	Default Value	Description
31:24	RO	03h	<b>Target Port Number (TPN):</b> Specifies the port number associated with the element targeted by this link entry (PCI Express). The target port number is with respect to the component that contains this element as specified by the target component ID.
23:16	RWO	00h	<b>Target Component ID (TCID):</b> Identifies the physical or logical component that is targeted by this link entry. A value of 0 is reserved. Component IDs start at 1. This value is a mirror of the value in the Component ID field of all elements in this component. <b>BIOS Requirement:</b> Must be initialized according to guidelines in the <i>PCI Express* Isochronous/Virtual Channel Support Hardware Programming Specification (HPS)</i> .
15:2	RO	0000h	Reserved
1	RO	1b	<b>Link Type (LTYP):</b> Indicates that the link points to configuration space of the integrated device which controls the root port for PCI Express. The link address specifies the configuration address (segment, bus, device, function) of the target root port.
0	RWO	0b	<b>Link Valid (LV):</b> 0 = Link Entry is not valid and will be ignored. 1 = Link Entry specifies a valid link.





### 5.3.7 EPLE3A—EP Link Entry 3 Address

B/D/F/Type: 0/0/0/PXPEPBAR  
 Address Offset: 78–7Fh  
 Default Value: 0000000000008000h  
 Access: RO  
 Size: 64 bits

This register provides the second part of a Link Entry which declares an internal link to another Root Complex Element.

Bit	Access	Default Value	Description
63:28	RO	00000000h	Reserved
27:20	RO	00h	<b>Bus Number (BUSN):</b>
19:15	RO	00001b	<b>Device Number (DEVN):</b> Target for this link is PCI Express port (Device6).
14:12	RO	000b	<b>Function Number (FUNN):</b>
11:0	RO	000h	Reserved

§ §





## 6 Host-Primary PCI Express\* Bridge Registers (D1:F0)

Device 1 contains the controls associated with the PCI Express root port that is the intended attach point for external devices. In addition, it also functions as the virtual PCI-to-PCI bridge. The table below provides an address map of the D1:F0 registers listed by address offset in ascending order. This chapter provides a detailed bit description of the registers.

**Warning:** When reading the PCI Express "conceptual" registers such as this, you may not get a valid value unless the register value is stable.

The *PCI Express\* Specification* defines two types of reserved bits:

Reserved and Preserved:

- Reserved for future RW implementations; software must preserve value read for writes to bits.
- Reserved and Zero: Reserved for future R/WC/S implementations; software must use 0 for writes to bits.

Unless explicitly documented as Reserved and Zero, all bits marked as reserved are part of the Reserved and Preserved type, which have historically been the typical definition for Reserved.

**Note:** Most (if not all) control bits in this device cannot be modified unless the link is down. Software is required to first disable the link, then program the registers, and then re-enable the link (which will cause a full-retrain with the new settings).

**Table 12.** Host-PCI Express Bridge Register Address Map (D1:F0) (Sheet 1 of 3)

Address Offset	Register Symbol	Register Name	Default Value	Access
0–1h	VID1	Vendor Identification	8086h	RO
2–3h	DID1	Device Identification	29F1h	RO
4–5h	PCICMD1	PCI Command	0000h	RO, RW
6–7h	PCISTS1	PCI Status	0010h	RO, RWC
8h	RID1	Revision Identification	see register description	RO
9–Bh	CC1	Class Code	060400h	RO
Ch	CL1	Cache Line Size	00h	RW
Eh	HDR1	Header Type	01h	RO
18h	PBUSN1	Primary Bus Number	00h	RO
19h	SBUSN1	Secondary Bus Number	00h	RW
1Ah	SUBUSN1	Subordinate Bus Number	00h	RW
1Ch	IOBASE1	I/O Base Address	F0h	RO, RW
1Dh	IOLIMIT1	I/O Limit Address	00h	RW, RO
1E–1Fh	SSTS1	Secondary Status	0000h	RO, RWC



Table 12. Host-PCI Express Bridge Register Address Map (D1:F0) (Sheet 2 of 3)

Address Offset	Register Symbol	Register Name	Default Value	Access
20–21h	MBASE1	Memory Base Address	FFF0h	RW, RO
22–23h	MLIMIT1	Memory Limit Address	0000h	RW, RO
24–25h	PMBASE1	Prefetchable Memory Base Address	FFF1h	RW, RO
26–27h	PMLIMIT1	Prefetchable Memory Limit Address	0001h	RO, RW
28–2Bh	PMBASEU1	Prefetchable Memory Base Address Upper	00000000h	RW
2C–2Fh	PMLIMITU1	Prefetchable Memory Limit Address Upper	00000000h	RW
34h	CAPPTR1	Capabilities Pointer	88h	RO
3Ch	INTRLINE1	Interrupt Line	00h	RW
3Dh	INTRPIN1	Interrupt Pin	01h	RO
3E–3Fh	BCTRL1	Bridge Control	0000h	RO, RW
80–83h	PM_CAPID1	Power Management Capabilities	C8039001h	RO
84–87h	PM_CS1	Power Management Control/Status	00000008h	RO, RW, RW/P
88–8Bh	SS_CAPID	Subsystem ID and Vendor ID Capabilities	0000800Dh	RO
8C–8Fh	SS	Subsystem ID and Subsystem Vendor ID	00008086h	RWO
90–91h	MSI_CAPID	Message Signaled Interrupts Capability ID	A005h	RO
92–93h	MC	Message Control	0000h	RW, RO
94–97h	MA	Message Address	00000000h	RO, RW
98–99h	MD	Message Data	0000h	RW
A0–A1h	PE_CAPL	PCI Express Capability List	0010h	RO
A2–A3h	PE_CAP	PCI Express Capabilities	0142h	RO, RWO
A4–A7h	DCAP	Device Capabilities	00008000h	RO
A8–A9h	DCTL	Device Control	0000h	RW, RO
AA–ABh	DSTS	Device Status	0000h	RO, RWC
AC–AFh	LCAP	Link Capabilities	020214D01h	RO, RWO
B0–B1h	LCTL	Link Control	0000h	RO, RW, RW/SC
B2–B3h	LSTS	Link Status	1000h	RWC, RO
B4–B7h	SLOTCAP	Slot Capabilities	00040000h	RWO, RO
B8–B9h	SLOTCTL	Slot Control	0000h	RO, RW
BA–BBh	SLOTSTS	Slot Status	0000h	RO, RWC
BC–BDh	RCTL	Root Control	0000h	RO, RW
C0–C3h	RSTS	Root Status	00000000h	RO, RWC
EC–EFh	PELC	PCI Express Legacy Control	00000000h	RO, RW
100–103h	VCECH	Virtual Channel Enhanced Capability Header	14010002h	RO
104–107h	PVCCAP1	Port VC Capability Register 1	00000000h	RO



Table 12. Host-PCI Express Bridge Register Address Map (D1:F0) (Sheet 3 of 3)

Address Offset	Register Symbol	Register Name	Default Value	Access
108–10Bh	PVCCAP2	Port VC Capability Register 2	00000000h	RO
10C–10Dh	PVCCTL	Port VC Control	0000h	RO, RW
110–113h	VC0RCAP	VC0 Resource Capability	00000001h	RO
114–117h	VC0RCTL	VC0 Resource Control	800000FFh	RO, RW
11A–11Bh	VC0RSTS	VC0 Resource Status	0002h	RO
140–143h	RCLDECH	Root Complex Link Declaration Enhanced	00010005h	RO
144–147h	ESD	Element Self Description	02000100h	RO, RWO
150–153h	LE1D	Link Entry 1 Description	00000000h	RO, RWO
158–15Fh	LE1A	Link Entry 1 Address	00000000 0000000h	RO, RWO
218–21Fh	PESSTS	PCI Express Sequence Status	00000000 0000FFFh	RO

## 6.1 VID1—Vendor Identification

B/D/F/Type: 0/1/0/PCI  
 Address Offset: 0–1h  
 Default Value: 8086h  
 Access: RO  
 Size: 16 bits

This register combined with the Device Identification register uniquely identify any PCI device.

Bit	Access	Default Value	Description
15:0	RO	8086h	<b>Vendor Identification (VID1):</b> PCI standard identification for Intel.



## 6.2 DID1—Device Identification

B/D/F/Type: 0/1/0/PCI  
Address Offset: 2–3h  
Default Value: 29F1h  
Access: RO  
Size: 16 bits

This register combined with the Vendor Identification register uniquely identifies any PCI device.

Bit	Access	Default Value	Description
15:8	RO	29h	<b>Device Identification Number (DID1(UB)):</b> Identifier assigned to the MCH device 1 (virtual PCI-to-PCI bridge, PCI Express port).
7:4	RO	Fh	<b>Device Identification Number (DID1(HW)):</b> Identifier assigned to the MCH device 1 (virtual PCI-to-PCI bridge, PCI Express port).
3:0	RO	1h	<b>Device Identification Number (DID1(LB)):</b> Identifier assigned to the MCH device 1 (virtual PCI-to-PCI bridge, PCI Express port).

## 6.3 PCICMD1—PCI Command

B/D/F/Type: 0/1/0/PCI  
Address Offset: 4–5h  
Default Value: 0000h  
Access: RO, RW  
Size: 16 bits

Bit	Access	Default Value	Description
15:11	RO	00h	Reserved
10	RW	0b	<b>INTA Assertion Disable (INTAAD):</b> 0 = This device is permitted to generate INTA interrupt messages. 1 = This device is prevented from generating interrupt messages. Any INTA emulation interrupts already asserted must be de-asserted when this bit is set.  Only affects interrupts generated by the device (PCI INTA from a PME event) controlled by this command register. It does not affect upstream MSIs, upstream PCI INTA-INTD assert and de-assert messages.
9	RO	0b	<b>Fast Back-to-Back Enable (FB2B):</b> Not Applicable or Implemented. Hardwired to 0.



Bit	Access	Default Value	Description
8	RW	0b	<p><b>SERR# Message Enable (SERRE1):</b> Controls Device 1 SERR# messaging. The MCH communicates the SERR# condition by sending an SERR message to the ICH. This bit, when set, enables reporting of non-fatal and fatal errors detected by the device to the Root Complex. Note that errors are reported if enabled either through this bit or through the PCI-Express specific bits in the Device Control Register.</p> <p>0 = The SERR message is generated by the MCH for Device 1 only under conditions enabled individually through the Device Control Register.            1 = The MCH is enabled to generate SERR messages which will be sent to the ICH for specific Device 1 error conditions generated/detected on the primary side of the virtual PCI to PCI bridge (not those received by the secondary side). The status of SERRs generated is reported in the PCISTS1 register.</p>
7	RO	0b	Reserved
6	RW	0b	<p><b>Parity Error Response Enable (PERRE):</b> Controls whether or not the Master Data Parity Error bit in the PCI Status register can be set.</p> <p>0 = Master Data Parity Error bit in PCI Status register can NOT be set.            1 = Master Data Parity Error bit in PCI Status register CAN be set.</p>
5:3	RO	0b	Reserved
2	RW	0b	<p><b>Bus Master Enable (BME):</b> Controls the ability of the PCI Express port to forward Memory and IO Read/Write Requests in the upstream direction.</p> <p>0 = This device is prevented from making memory or IO requests to its primary bus. Note that according to PCI Specification, as MSI interrupt messages are in-band memory writes, disabling the bus master enable bit prevents this device from generating MSI interrupt messages or passing them from its secondary bus to its primary bus. Upstream memory writes/reads, IO writes/reads, peer writes/reads, and MSIs will all be treated as illegal cycles. Writes are forwarded to memory address C0000h with byte enables de-asserted. Reads will be forwarded to memory address C0000h and will return Unsupported Request status (or Master abort) in its completion packet.</p> <p>1 = This device is allowed to issue requests to its primary bus. Completions for previously issued memory read requests on the primary bus will be issued when the data is available.</p> <p>This bit does not affect forwarding of Completions from the primary interface to the secondary interface.</p>
1	RW	0b	<p><b>Memory Access Enable (MAE):</b></p> <p>0 = All of device 1's memory space is disabled.            1 = Enable the Memory and Pre-fetchable memory address ranges defined in the MBASE1, MLIMIT1, PMBASE1, and PMLIMIT1 registers.</p>
0	RW	0b	<p><b>I/O Access Enable (IOAE):</b></p> <p>0 = All of device 1's I/O space is disabled.            1 = Enable the I/O address range defined in the IOBASE1, and IOLIMIT1 registers.</p>



## 6.4 PCISTS1—PCI Status

B/D/F/Type: 0/1/0/PCI  
 Address Offset: 6–7h  
 Default Value: 0010h  
 Access: RO, RWC  
 Size: 16 bits

This register reports the occurrence of error conditions associated with primary side of the "virtual" Host-PCI Express bridge embedded within the MCH.

Bit	Access	Default Value	Description
15	RO	0b	<b>Detected Parity Error (DPE):</b> Not Applicable or Implemented. Hardwired to 0. Parity (generating poisoned Transaction Layer Packets) is not supported on the primary side of this device.
14	RWC	0b	<b>Signaled System Error (SSE):</b> This bit is set when this Device sends an SERR due to detecting an ERR_FATAL or ERR_NONFATAL condition and the SERR Enable bit in the Command register is 1. Both received (if enabled by BCTRL1[1]) and internally detected error messages do not affect this field.
13	RO	0b	<b>Received Master Abort Status (RMAS):</b> Not Applicable or Implemented. Hardwired to 0. The concept of a master abort does not exist on primary side of this device.
12	RO	0b	<b>Received Target Abort Status (RTAS):</b> Not Applicable or Implemented. Hardwired to 0. The concept of a target abort does not exist on primary side of this device.
11	RO	0b	<b>Signaled Target Abort Status (STAS):</b> Not Applicable or Implemented. Hardwired to 0. The concept of a target abort does not exist on primary side of this device.
10:9	RO	00b	<b>DEVSELB Timing (DEVT):</b> This device is not the subtractively decoded device on bus 0. This bit field is therefore hardwired to 00 to indicate that the device uses the fastest possible decode.
8	RO	0b	<b>Master Data Parity Error (PMDPE):</b> Because the primary side of the PCI Express's virtual peer-to-peer bridge is integrated with the MCH functionality, there is no scenario where this bit will get set. Because hardware will never set this bit, it is impossible for software to have an opportunity to clear this bit or otherwise test that it is implemented. The PCI specification defines it as a R/WC, but for our implementation an RO definition behaves the same way and will meet all Microsoft testing requirements. This bit can only be set when the Parity Error Enable bit in the PCI Command register is set.
7	RO	0b	<b>Fast Back-to-Back (FB2B):</b> Not Applicable or Implemented. Hardwired to 0.
6	RO	0b	Reserved
5	RO	0b	<b>66/60MHz capability (CAP66):</b> Not Applicable or Implemented. Hardwired to 0.
4	RO	1b	<b>Capabilities List (CAPL):</b> Indicates that a capabilities list is present. Hardwired to 1.
3	RO	0b	<b>INTA Status (INTAS):</b> Indicates that an interrupt message is pending internally to the device. Only PME sources feed into this status bit (not PCI INTA-INTD assert and de-assert messages). The INTA Assertion Disable bit, PCICMD1[10], has no effect on this bit.
2:0	RO	000b	Reserved





## 6.5 RID1—Revision Identification

B/D/F/Type: 0/1/0/PCI  
 Address Offset: 8h  
 Default Value: see table below  
 Access: RO  
 Size: 8 bits

This register contains the revision number of the MCH device 1. These bits are read only and writes to this register have no effect.

Bit	Access	Default Value	Description
7:0	RO	see description	<b>Revision Identification Number (RID1):</b> This is an 8-bit value that indicates the revision identification number for the MCH Device 0. Refer to the <i>Intel® 3200 and 3210 Chipset Specification Update</i> for the value of this register.

## 6.6 CC1—Class Code

B/D/F/Type: 0/1/0/PCI  
 Address Offset: 9–Bh  
 Default Value: 060400h  
 Access: RO  
 Size: 24 bits

This register identifies the basic function of the device, a more specific sub-class, and a register-specific programming interface.

Bit	Access	Default Value	Description
23:16	RO	06h	<b>Base Class Code (BCC):</b> Indicates the base class code for this device. This code has the value 06h, indicating a Bridge device.
15:8	RO	04h	<b>Sub-Class Code (SUBCC):</b> Indicates the sub-class code for this device. The code is 04h indicating a PCI to PCI Bridge.
7:0	RO	00h	<b>Programming Interface (PI):</b> Indicates the programming interface of this device. This value does not specify a particular register set layout and provides no practical use for this device.



## 6.7 CL1—Cache Line Size

B/D/F/Type: 0/1/0/PCI  
Address Offset: Ch  
Default Value: 00h  
Access: RW  
Size: 8 bits

Bit	Access	Default Value	Description
7:0	RW	00h	<b>Cache Line Size (Scratch pad):</b> Implemented by PCI Express devices as a read-write field for legacy compatibility purposes but has no impact on any PCI Express device functionality.

## 6.8 HDR1—Header Type

B/D/F/Type: 0/1/0/PCI  
Address Offset: Eh  
Default Value: 01h  
Access: RO  
Size: 8 bits

This register identifies the header layout of the configuration space. No physical register exists at this location.

Bit	Access	Default Value	Description
7:0	RO	01h	<b>Header Type Register (HDR):</b> Returns 01h to indicate that this is a single function device with bridge header layout.

## 6.9 PBUSN1—Primary Bus Number

B/D/F/Type: 0/1/0/PCI  
Address Offset: 18h  
Default Value: 00h  
Access: RO  
Size: 8 bits

This register identifies that this "virtual" Host-PCI Express bridge is connected to PCI bus 0.

Bit	Access	Default Value	Description
7:0	RO	00h	<b>Primary Bus Number (BUSN):</b> Configuration software typically programs this field with the number of the bus on the primary side of the bridge. Since device 1 is an internal device and its primary bus is always 0, these bits are read only and are hardwired to 0.



## 6.10 SBUSN1—Secondary Bus Number

B/D/F/Type: 0/1/0/PCI  
 Address Offset: 19h  
 Default Value: 00h  
 Access: RW  
 Size: 8 bits

This register identifies the bus number assigned to the second bus side of the "virtual" bridge. This number is programmed by the PCI configuration software to allow mapping of configuration cycles to PCI Express.

Bit	Access	Default Value	Description
7:0	RW	00h	<b>Secondary Bus Number (BUSN):</b> This field is programmed by configuration software with the bus number assigned to PCI Express.

## 6.11 SUBUSN1—Subordinate Bus Number

B/D/F/Type: 0/1/0/PCI  
 Address Offset: 1Ah  
 Default Value: 00h  
 Access: RW  
 Size: 8 bits

This register identifies the subordinate bus (if any) that resides at the level below PCI Express. This number is programmed by the PCI configuration software to allow mapping of configuration cycles to PCI Express.

Bit	Access	Default Value	Description
7:0	RW	00h	<b>Subordinate Bus Number (BUSN):</b> This register is programmed by configuration software with the number of the highest subordinate bus that lies behind the device 1 bridge. When only a single PCI device resides on the PCI Express segment, this register will contain the same value as the SBUSN1 register.



## 6.12 IOBASE1—I/O Base Address

B/D/F/Type: 0/1/0/PCI  
Address Offset: 1Ch  
Default Value: F0h  
Access: RO, RW  
Size: 8 bits

This register controls the processor to PCI Express I/O access routing based on the following formula:

$$\text{IO\_BASE} \leq \text{address} \leq \text{IO\_LIMIT}$$

Only upper 4 bits are programmable. For the purpose of address decode address bits A[11:0] are treated as 0. Thus the bottom of the defined I/O address range will be aligned to a 4 KB boundary.

Bit	Access	Default Value	Description
7:4	RW	Fh	<b>I/O Address Base (IOBASE):</b> Corresponds to A[15:12] of the I/O addresses passed by bridge 1 to PCI Express.
3:0	RO	0h	Reserved

## 6.13 IOLIMIT1—I/O Limit Address

B/D/F/Type: 0/1/0/PCI  
Address Offset: 1Dh  
Default Value: 00h  
Access: RW, RO  
Size: 8 bits

This register controls the processor to PCI Express I/O access routing based on the following formula:

$$\text{IO\_BASE} \leq \text{address} \leq \text{IO\_LIMIT}$$

Only upper 4 bits are programmable. For the purpose of address decode, address bits A[11:0] are assumed to be FFFh. Thus, the top of the defined I/O address range will be at the top of a 4 KB aligned address block.

Bit	Access	Default Value	Description
7:4	RW	0h	<b>I/O Address Limit (IOLIMIT):</b> Corresponds to A[15:12] of the I/O address limit of device #1. Devices between this upper limit and IOBASE1 will be passed to the PCI Express hierarchy associated with this device.
3:0	RO	0h	Reserved



## 6.14 SSTS1—Secondary Status

B/D/F/Type: 0/1/0/PCI  
 Address Offset: 1E–1Fh  
 Default Value: 0000h  
 Access: RO, RWC  
 Size: 16 bits

SSTS1 is a 16-bit status register that reports the occurrence of error conditions associated with secondary side of the "virtual" PCI-PCI bridge embedded within MCH.

Bit	Access	Default Value	Description
15	RWC	0b	<b>Detected Parity Error (DPE):</b> This bit is set by the Secondary Side for a Type 1 Configuration Space header device whenever it receives a Poisoned Transaction Layer Packet, regardless of the state of the Parity Error Response Enable bit in the Bridge Control Register.
14	RWC	0b	<b>Received System Error (RSE):</b> This bit is set when the Secondary Side for a Type 1 configuration space header device receives an ERR_FATAL or ERR_NONFATAL.
13	RWC	0b	<b>Received Master Abort (RMA):</b> This bit is set when the Secondary Side for Type 1 Configuration Space Header Device (for requests initiated by the Type 1 Header Device itself) receives a Completion with Unsupported Request Completion Status.
12	RWC	0b	<b>Received Target Abort (RTA):</b> This bit is set when the Secondary Side for Type 1 Configuration Space Header Device (for requests initiated by the Type 1 Header Device itself) receives a Completion with Completer Abort Completion Status.
11	RO	0b	<b>Signaled Target Abort (STA):</b> Not Applicable or Implemented. Hardwired to 0. The MCH does not generate Target Aborts (the MCH will never complete a request using the Completer Abort Completion status).
10:9	RO	00b	<b>DEVSELB Timing (DEVT):</b> Not Applicable or Implemented. Hardwired to 0.
8	RWC	0b	<b>Master Data Parity Error (SMDPE):</b> When set indicates that the MCH received across the link (upstream) a Read Data Completion Poisoned Transaction Layer Packet (EP=1). This bit can only be set when the Parity Error Enable bit in the Bridge Control register is set.
7	RO	0b	<b>Fast Back-to-Back (FB2B):</b> Not Applicable or Implemented. Hardwired to 0.
6	RO	0b	Reserved
5	RO	0b	<b>66/60 MHz capability (CAP66):</b> Not Applicable or Implemented. Hardwired to 0.
4:0	RO	00h	Reserved



## 6.15 MBASE1—Memory Base Address

B/D/F/Type: 0/1/0/PCI  
Address Offset: 20–21h  
Default Value: FFF0h  
Access: RW, RO  
Size: 16 bits

This register controls the processor to PCI Express non-prefetchable memory access routing based on the following formula:

$$\text{MEMORY\_BASE} \leq \text{address} \leq \text{MEMORY\_LIMIT}$$

The upper 12 bits of the register are read/write and correspond to the upper 12 address bits A[31:20] of the 32 bit address. The bottom 4 bits of this register are read-only and return zeroes when read. This register must be initialized by the configuration software. For the purpose of address decode, address bits A[19:0] are assumed to be 0. Thus, the bottom of the defined memory address range will be aligned to a 1 MB boundary.

Bit	Access	Default Value	Description
15:4	RW	FFFh	<b>Memory Address Base (MBASE):</b> This field corresponds to A[31:20] of the lower limit of the memory range that will be passed to PCI Express.
3:0	RO	0h	Reserved



## 6.16 MLIMIT1—Memory Limit Address

B/D/F/Type: 0/1/0/PCI  
 Address Offset: 22–23h  
 Default Value: 0000h  
 Access: RW, RO  
 Size: 16 bits

This register controls the processor to PCI Express non-prefetchable memory access routing based on the following formula:

$$\text{MEMORY\_BASE} \leq \text{address} \leq \text{MEMORY\_LIMIT}$$

The upper 12 bits of the register are read/write and correspond to the upper 12 address bits A[31:20] of the 32 bit address. The bottom 4 bits of this register are read-only and return zeroes when read. This register must be initialized by the configuration software. For the purpose of address decode address bits A[19:0] are assumed to be FFFFh. Thus, the top of the defined memory address range will be at the top of a 1 MB aligned memory block.

**Note:** Memory range covered by MBASE and MLIMIT registers are used to map non-prefetchable PCI Express address ranges (typically where control/status memory-mapped I/O data structures of the controller will reside) and PMBASE and PMLIMIT are used to map prefetchable address ranges (typically device local memory). This segregation allows application of USWC space attribute to be performed in a true plug-and-play manner to the prefetchable address range for improved processor- PCI Express memory access performance.

**Note:** Configuration software is responsible for programming all address range registers (prefetchable, non-prefetchable) with the values that provide exclusive address ranges (i.e., prevent overlap with each other and/or with the ranges covered with the main memory). There is no provision in the MCH hardware to enforce prevention of overlap and operations of the system in the case of overlap are not ensured.

Bit	Access	Default Value	Description
15:4	RW	000h	<b>Memory Address Limit (MLIMIT):</b> This field corresponds to A[31:20] of the upper limit of the address range passed to PCI Express.
3:0	RO	0h	Reserved



## 6.17 PMBASE1—Prefetchable Memory Base Address

B/D/F/Type: 0/1/0/PCI  
Address Offset: 24–25h  
Default Value: FFF1h  
Access: RW, RO  
Size: 16 bits

This register in conjunction with the corresponding Upper Base Address register controls the processor to PCI Express prefetchable memory access routing based on the following formula:

$$\text{PREFETCHABLE\_MEMORY\_BASE} \leq \text{address} \leq \text{PREFETCHABLE\_MEMORY\_LIMIT}$$

The upper 12 bits of this register are read/write and correspond to address bits A[31:20] of the 40-bit address. The lower 8 bits of the Upper Base Address register are read/write and correspond to address bits A[39:32] of the 40-bit address. This register must be initialized by the configuration software. For the purpose of address decode, address bits A[19:0] are assumed to be 0. Thus, the bottom of the defined memory address range will be aligned to a 1MB boundary.

Bit	Access	Default Value	Description
15:4	RW	FFFh	<b>Prefetchable Memory Base Address (MBASE):</b> This field corresponds to A[31:20] of the lower limit of the memory range that will be passed to PCI Express.
3:0	RO	1h	<b>64-bit Address Support:</b> This field indicates that the upper 32 bits of the prefetchable memory region base address are contained in the Prefetchable Memory base Upper Address register at 28h.





## 6.18 PMLIMIT1—Prefetchable Memory Limit Address

B/D/F/Type: 0/1/0/PCI  
 Address Offset: 26–27h  
 Default Value: 0001h  
 Access: RO, RW  
 Size: 16 bits

This register in conjunction with the corresponding Upper Limit Address register controls the processor to PCI Express prefetchable memory access routing based on the following formula:

$$\text{PREFETCHABLE\_MEMORY\_BASE} \leq \text{address} \leq \text{PREFETCHABLE\_MEMORY\_LIMIT}$$

The upper 12 bits of this register are read/write and correspond to address bits A[31:20] of the 40-bit address. The lower 8 bits of the Upper Limit Address register are read/write and correspond to address bits A[39:32] of the 40-bit address. This register must be initialized by the configuration software. For the purpose of address decode, address bits A[19:0] are assumed to be FFFFh. Thus, the top of the defined memory address range will be at the top of a 1 MB aligned memory block. Note that prefetchable memory range is supported to allow segregation by the configuration software between the memory ranges that must be defined as UC and the ones that can be designated as a USWC (i.e., prefetchable) from the processor perspective.

Bit	Access	Default Value	Description
15:4	RW	000h	<b>Prefetchable Memory Address Limit (PMLIMIT):</b> This field corresponds to A[31:20] of the upper limit of the address range passed to PCI Express.
3:0	RO	1h	<b>64-bit Address Support:</b> This field indicates that the upper 32 bits of the prefetchable memory region limit address are contained in the Prefetchable Memory Base Limit Address register at 2Ch



## 6.19 PMBASEU1—Prefetchable Memory Base Address Upper

B/D/F/Type: 0/1/0/PCI  
Address Offset: 28–2Bh  
Default Value: 00000000h  
Access: RW  
Size: 32 bits

The functionality associated with this register is present in the PCI Express design implementation.

This register in conjunction with the corresponding Upper Base Address register controls the processor to PCI Express prefetchable memory access routing based on the following formula:

$$\text{PREFETCHABLE\_MEMORY\_BASE} \leq \text{address} \leq \text{PREFETCHABLE\_MEMORY\_LIMIT}$$

The upper 12 bits of this register are read/write and correspond to address bits A[31:20] of the 40-bit address. The lower 8 bits of the Upper Base Address register are read/write and correspond to address bits A[39:32] of the 40-bit address. This register must be initialized by the configuration software. For the purpose of address decode, address bits A[19:0] are assumed to be 0. Thus, the bottom of the defined memory address range will be aligned to a 1MB boundary.

Bit	Access	Default Value	Description
31:0	RW	00000000h	<b>Prefetchable Memory Base Address (MBASEU)</b> : Corresponds to A[63:32] of the lower limit of the prefetchable memory range that will be passed to PCI Express.



## 6.20 PMLIMITU1—Prefetchable Memory Limit Address Upper

B/D/F/Type: 0/1/0/PCI  
 Address Offset: 2C–2Fh  
 Default Value: 00000000h  
 Access: RW  
 Size: 32 bits

The functionality associated with this register is present in the PCI Express design implementation.

This register in conjunction with the corresponding Upper Limit Address register controls the processor to PCI Express prefetchable memory access routing based on the following formula:

$$\text{PREFETCHABLE\_MEMORY\_BASE} \leq \text{address} \leq \text{PREFETCHABLE\_MEMORY\_LIMIT}$$

The upper 12 bits of this register are read/write and correspond to address bits A[31:20] of the 40-bit address. The lower 8 bits of the Upper Limit Address register are read/write and correspond to address bits A[39:32] of the 40-bit address. This register must be initialized by the configuration software. For the purpose of address decode address bits A[19:0] are assumed to be FFFFh. Thus, the top of the defined memory address range will be at the top of a 1MB aligned memory block.

Note that prefetchable memory range is supported to allow segregation by the configuration software between the memory ranges that must be defined as UC and the ones that can be designated as a USWC (i.e. prefetchable) from the processor perspective.

Bit	Access	Default Value	Description
31:0	RW	00000000h	<b>Prefetchable Memory Address Limit (MLIMITU)</b> : This field corresponds to A[63:32] of the upper limit of the prefetchable Memory range that will be passed to PCI Express.

## 6.21 CAPPTR1—Capabilities Pointer

B/D/F/Type: 0/1/0/PCI  
 Address Offset: 34h  
 Default Value: 88h  
 Access: RO  
 Size: 8 bits

The capabilities pointer provides the address offset to the location of the first entry in this device's linked list of capabilities.

Bit	Access	Default Value	Description
7:0	RO	88h	<b>First Capability (CAPPTR1)</b> : The first capability in the list is the Subsystem ID and Subsystem Vendor ID Capability.



## 6.22 INTRLINE1—Interrupt Line

B/D/F/Type: 0/1/0/PCI  
 Address Offset: 3Ch  
 Default Value: 00h  
 Access: RW  
 Size: 8 bits

This register contains interrupt line routing information. The device itself does not use this value, rather it is used by device drivers and operating systems to determine priority and vector information.

Bit	Access	Default Value	Description
7:0	RW	00h	<b>Interrupt Connection (INTCON):</b> This field is used to communicate interrupt line routing information.

## 6.23 INTRPIN1—Interrupt Pin

B/D/F/Type: 0/1/0/PCI  
 Address Offset: 3Dh  
 Default Value: 01h  
 Access: RO  
 Size: 8 bits

This register specifies which interrupt pin this device uses.

Bit	Access	Default Value	Description
7:0	RO	01h	<b>Interrupt Pin (INTPIN):</b> As a single function device, the PCI Express device specifies INTA as its interrupt pin. 01h=INTA.

## 6.24 BCTRL1—Bridge Control

B/D/F/Type: 0/1/0/PCI  
 Address Offset: 3E–3Fh  
 Default Value: 0000h  
 Access: RO, RW  
 Size: 16 bits

This register provides extensions to the PCICMD1 register that are specific to PCI-PCI bridges. The BCTRL provides additional control for the secondary interface as well as some bits that affect the overall behavior of the "virtual" Host-PCI Express bridge embedded within MCH.

Bit	Access	Default Value	Description
15:12	RO	0h	Reserved
11	RO	0b	<b>Discard Timer SERR# Enable (DTSERRE):</b> Not Applicable or Implemented. Hardwired to 0.
10	RO	0b	<b>Discard Timer Status (DTSTS):</b> Not Applicable or Implemented. Hardwired to 0.



Bit	Access	Default Value	Description
9	RO	0b	<b>Secondary Discard Timer (SDT):</b> Not Applicable or Implemented. Hardwired to 0.
8	RO	0b	<b>Primary Discard Timer (PDT):</b> Not Applicable or Implemented. Hardwired to 0.
7	RO	0b	<b>Fast Back-to-Back Enable (FB2BEN):</b> Not Applicable or Implemented. Hardwired to 0.
6	RW	0b	<b>Secondary Bus Reset (SRESET):</b> Setting this bit triggers a hot reset on the corresponding PCI Express Port. This will force the LTSSM to transition to the Hot Reset state (via Recovery) from L0, L0s, or L1 states.
5	RO	0b	<b>Master Abort Mode (MAMODE):</b> Does not apply to PCI Express. Hardwired to 0.
4	RW	0b	<b>VGA 16-bit Decode (VGA16D):</b> Enables the PCI-to-PCI bridge to provide 16-bit decoding of VGA I/O address precluding the decoding of alias addresses every 1 KB. This bit only has meaning if bit 3 (VGA Enable) of this register is also set to 1, enabling VGA I/O decoding and forwarding by the bridge. 0 = Execute 10-bit address decodes on VGA I/O accesses. 1 = Execute 16-bit address decodes on VGA I/O accesses.
3	RW	0b	<b>VGA Enable (VGAEN):</b> Controls the routing of processor initiated transactions targeting VGA compatible I/O and memory address ranges. See the VGAEN/MDAP table in device 0, offset 97h[0].
2	RW	0b	<b>ISA Enable (ISAEN):</b> Needed to exclude legacy resource decode to route ISA resources to legacy decode path. Modifies the response by the MCH to an I/O access issued by the processor that target ISA I/O addresses. This applies only to I/O addresses that are enabled by the IOBASE and IOLIMIT registers. 0 = All addresses defined by the IOBASE and IOLIMIT for processor I/O transactions will be mapped to PCI Express. 1 = MCH will not forward to PCI Express any I/O transactions addressing the last 768 bytes in each 1KB block even if the addresses are within the range defined by the IOBASE and IOLIMIT registers.
1	RW	0b	<b>SERR Enable (SERREN):</b> 0 = No forwarding of error messages from secondary side to primary side that could result in an SERR. 1 = ERR_COR, ERR_NONFATAL, and ERR_FATAL messages result in SERR message when individually enabled by the Root Control register.
0	RW	0b	<b>Parity Error Response Enable (PEREN):</b> Controls whether or not the Master Data Parity Error bit in the Secondary Status register is set when the MCH receives across the link (upstream) a Read Data Completion Poisoned Transaction Layer Packet. 0 = Master Data Parity Error bit in Secondary Status register can NOT be set. 1 = Master Data Parity Error bit in Secondary Status register CAN be set.



## 6.25 PM\_CAPID1—Power Management Capabilities

B/D/F/Type: 0/1/0/PCI  
Address Offset: 80–83h  
Default Value: C8039001h  
Access: RO  
Size: 32 bits

Bit	Access	Default Value	Description
31:27	RO	19h	<b>PME Support (PMES):</b> This field indicates the power states in which this device may indicate PME wake via PCI Express messaging. D0, D3hot & D3cold. This device is not required to do anything to support D3hot & D3cold, it simply must report that those states are supported. Refer to the PCI Power Management 1.1 specification for encoding explanation and other power management details.
26	RO	0b	<b>D2 Power State Support (D2PSS):</b> Hardwired to 0 to indicate that the D2 power management state is NOT supported.
25	RO	0b	<b>D1 Power State Support (D1PSS):</b> Hardwired to 0 to indicate that the D1 power management state is NOT supported.
24:22	RO	000b	<b>Auxiliary Current (AUXC):</b> Hardwired to 0 to indicate that there are no 3.3Vaux auxiliary current requirements.
21	RO	0b	<b>Device Specific Initialization (DSI):</b> Hardwired to 0 to indicate that special initialization of this device is NOT required before generic class device driver is to use it.
20	RO	0b	<b>Auxiliary Power Source (APS):</b> Hardwired to 0.
19	RO	0b	<b>PME Clock (PMECLK):</b> Hardwired to 0 to indicate this device does NOT support PMEB generation.
18:16	RO	011b	<b>PCI PM CAP Version (PCIPMCV):</b> A value of 011b indicates that this function complies with revision 1.2 of the PCI Power Management Interface Specification.
15:8	RO	90h	<b>Pointer to Next Capability (PNC):</b> This contains a pointer to the next item in the capabilities list. If MSICH (CAPL[0] @ 7Fh) is 0, then the next item in the capabilities list is the Message Signaled Interrupts (MSI) capability at 90h.
7:0	RO	01h	<b>Capability ID (CID):</b> Value of 01h identifies this linked list item (capability structure) as being for PCI Power Management registers.



## 6.26 PM\_CS1—Power Management Control/Status

B/D/F/Type: 0/1/0/PCI  
 Address Offset: 84–87h  
 Default Value: 00000008h  
 Access: RO, RW, RW/P  
 Size: 32 bits

Bit	Access	Default Value	Description
31:16	RO	0000h	Reserved
15	RO	0b	<b>PME Status (PMESTS)</b> : This bit indicates that this device does not support PMEB generation from D3cold.
14:13	RO	00b	<b>Data Scale (DSCALE)</b> : This field indicates that this device does not support the power management data register.
12:9	RO	0h	<b>Data Select (DSEL)</b> : This field indicates that this device does not support the power management data register.
8	RW/P	0b	<b>PME Enable (PMEE)</b> : This bit indicates that this device does not generate PMEB assertion from any D-state. 0 = PMEB generation not possible from any D State 1 = PMEB generation enabled from any D State The setting of this bit has no effect on hardware. See PM_CAP[15:11]
7:2	RO	0000b	Reserved
1:0	RW	00b	<b>Power State (PS)</b> : This field indicates the current power state of this device and can be used to set the device into a new power state. If software attempts to write an unsupported state to this field, write operation must complete normally on the bus, but the data is discarded and no state change occurs. 00 = D0 11 = D3 Support of D3cold does not require any special action. While in the D3hot state, this device can only act as the target of PCI configuration transactions (for power management control). This device also cannot generate interrupts or respond to MMR cycles in the D3 state. The device must return to the D0 state in order to be fully-functional. When the Power State is other than D0, the bridge will Master Abort (i.e. not claim) any downstream cycles (with exception of type 0 configuration cycles). Consequently, these unclaimed cycles will go down DMI and come back up as Unsupported Requests, which the MCH logs as Master Aborts in Device 0 PCISTS[13] There is no additional hardware functionality required to support these Power States.



## 6.27 SS\_CAPID—Subsystem ID and Vendor ID Capabilities

B/D/F/Type: 0/1/0/PCI  
Address Offset: 88–8Bh  
Default Value: 0000800Dh  
Access: RO  
Size: 32 bits

This capability is used to uniquely identify the subsystem where the PCI device resides. Because this device is an integrated part of the system and not an add-in device, it is anticipated that this capability will never be used. However, it is necessary because Microsoft will test for its presence.

Bit	Access	Default Value	Description
31:16	RO	0000h	Reserved
15:8	RO	80h	<b>Pointer to Next Capability (PNC):</b> This field contains a pointer to the next item in the capabilities list which is the PCI Power Management capability.
7:0	RO	0Dh	<b>Capability ID (CID):</b> Value of 0Dh identifies this linked list item (capability structure) as being for SSID/SSVID registers in a PCI-to-PCI Bridge.

## 6.28 SS—Subsystem ID and Subsystem Vendor ID

B/D/F/Type: 0/1/0/PCI  
Address Offset: 8C–8Fh  
Default Value: 00008086h  
Access: RWO  
Size: 32 bits

System BIOS can be used as the mechanism for loading the SSID/SVID values. These values must be preserved through power management transitions and a hardware reset.

Bit	Access	Default Value	Description
31:16	RWO	0000h	<b>Subsystem ID (SSID):</b> Identifies the particular subsystem and is assigned by the vendor.
15:0	RWO	8086h	<b>Subsystem Vendor ID (SSVID):</b> Identifies the manufacturer of the subsystem and is the same as the vendor ID which is assigned by the PCI Special Interest Group.





## 6.29 MSI\_CAPID—Message Signaled Interrupts Capability ID

B/D/F/Type: 0/1/0/PCI  
 Address Offset: 90–91h  
 Default Value: A005h  
 Access: RO  
 Size: 16 bits

When a device supports MSI, it can generate an interrupt request to the processor by writing a predefined data item (a message) to a predefined memory address.

Bit	Access	Default Value	Description
15:8	RO	A0h	<b>Pointer to Next Capability (PNC)</b> : This contains a pointer to the next item in the capabilities list which is the PCI Express capability.
7:0	RO	05h	<b>Capability ID (CID)</b> : Value of 05h identifies this linked list item (capability structure) as being for MSI registers.

## 6.30 MC—Message Control

B/D/F/Type: 0/1/0/PCI  
 Address Offset: 92–93h  
 Default Value: 0000h  
 Access: RW, RO  
 Size: 16 bits

System software can modify bits in this register, but the device is prohibited from doing so.

If the device writes the same message multiple times, only one of those messages is ensured to be serviced. If all of them must be serviced, the device must not generate the same message again until the driver services the earlier one.

Bit	Access	Default Value	Description
15:8	RO	00h	Reserved
7	RO	0b	<b>64-bit Address Capable (64AC)</b> : Hardwired to 0 to indicate that the function does not implement the upper 32 bits of the Message Address register and is incapable of generating a 64-bit memory address.
6:4	RW	000b	<b>Multiple Message Enable (MME)</b> : System software programs this field to indicate the actual number of messages allocated to this device. This number will be equal to or less than the number actually requested. The encoding is the same as for the MMC field below.
3:1	RO	000b	<b>Multiple Message Capable (MMC)</b> : System software reads this field to determine the number of messages being requested by this device. The value of 000b equates to 1 message requested. 000 = 1 message requested All other encodings are reserved.
0	RW	0b	<b>MSI Enable (MSIEN)</b> : Controls the ability of this device to generate MSIs. 0 = OMSI will not be generated. 1 = MSI will be generated when we receive PME messages. INTA will not be generated and INTA Status (PCISTS1[3]) will not be set.



### 6.31 MA—Message Address

B/D/F/Type: 0/1/0/PCI  
Address Offset: 94–97h  
Default Value: 00000000h  
Access: RO, RW  
Size: 32 bits

Bit	Access	Default Value	Description
31:2	RW	00000000h	<b>Message Address (MA):</b> Used by system software to assign an MSI address to the device. The device handles an MSI by writing the padded contents of the MD register to this address.
1:0	RO	00b	<b>Force DWord Align (FDWA):</b> Hardwired to 0 so that addresses assigned by system software are always aligned on a dword address boundary.

### 6.32 MD—Message Data

B/D/F/Type: 0/1/0/PCI  
Address Offset: 98–99h  
Default Value: 0000h  
Access: RW  
Size: 16 bits

Bit	Access	Default Value	Description
15:0	RW	0000h	<b>Message Data (MD):</b> Base message data pattern assigned by system software and used to handle an MSI from the device. When the device must generate an interrupt request, it writes a 32-bit value to the memory address specified in the MA register. The upper 16-bits are always set to 0. The lower 16-bits are supplied by this register.

### 6.33 PE\_CAPL—PCI Express\* Capability List

B/D/F/Type: 0/1/0/PCI  
Address Offset: A0–A1h  
Default Value: 0010h  
Access: RO  
Size: 16 bits

This register enumerates the PCI Express capability structure.

Bit	Access	Default Value	Description
15:8	RO	00h	<b>Pointer to Next Capability (PNC):</b> This value terminates the capabilities list. The Virtual Channel capability and any other PCI Express specific capabilities that are reported via this mechanism are in a separate capabilities list located entirely within PCI Express Extended Configuration Space.
7:0	RO	10h	<b>Capability ID (CID):</b> Identifies this linked list item (capability structure) as being for PCI Express registers.



## 6.34 PE\_CAP—PCI Express\* Capabilities

B/D/F/Type: 0/1/0/PCI  
 Address Offset: A2–A3h  
 Default Value: 0142h  
 Access: RO, RWO  
 Size: 16 bits

This register indicates PCI Express device capabilities.

Bit	Access	Default Value	Description
15:14	RO	00b	Reserved
13:9	RO	00h	<b>Interrupt Message Number (IMN)</b> : Not Applicable or Implemented. Hardwired to 0.
8	RWO	1b	<b>Slot Implemented (SI)</b> : 0 = The PCI Express Link associated with this port is connected to an integrated component or is disabled. 1 = The PCI Express Link associated with this port is connected to a slot.
7:4	RO	4h	<b>Device/Port Type (DPT)</b> : Hardwired to 4h to indicate root port of PCI Express Root Complex.
3:0	RO	2h	<b>PCI Express Capability Version (PCI ECV)</b> : Hardwired to 2h to indicate compliance to the PCI Express Capabilities Register Expansion ECN.

## 6.35 DCAP—Device Capabilities

B/D/F/Type: 0/1/0/PCI  
 Address Offset: A4–A7h  
 Default Value: 0008000h  
 Access: RO  
 Size: 32 bits

This register indicates PCI Express device capabilities.

Bit	Access	Default Value	Description
31:16	RO	0000h	Reserved
15	RO	1b	<b>Role Based Error Reporting (RBER)</b> : Role Based Error Reporting (RBER): Indicates that this device implements the functionality defined in the Error Reporting ECN as required by the PCI Express 1.1 spec.
14:6	RO	000h	Reserved
5	RO	0b	<b>Extended Tag Field Supported (ETFS)</b> : Hardwired to indicate support for 5-bit Tags as a Requestor.
4:3	RO	00b	<b>Phantom Functions Supported (PFS)</b> : Not Applicable or Implemented. Hardwired to 0.
2:0	RO	000b	<b>Max Payload Size (MPS)</b> : Hardwired to indicate 128B max supported payload for Transaction Layer Packets (TLP).



## 6.36 DCTL—Device Control

B/D/F/Type: 0/1/0/PCI  
 Address Offset: A8–A9h  
 Default Value: 0000h  
 Access: RW, RO  
 Size: 16 bits

This register provides control for PCI Express device specific capabilities.

The error reporting enable bits are in reference to errors detected by this device, not error messages received across the link. The reporting of error messages (ERR\_CORR, ERR\_NONFATAL, ERR\_FATAL) received by Root Port is controlled exclusively by Root Port Command Register.

Bit	Access	Default Value	Description
15:8	RO	0h	Reserved
7:5	RW	000b	<b>Max Payload Size (MPS):</b> 000 = 128B max supported payload for Transaction Layer Packets (TLP). As a receiver, the Device must handle TLPs as large as the set value; as transmitter, the Device must not generate TLPs exceeding the set value. All other encodings are reserved. Hardware will actually ignore this field. It is writeable only to support compliance testing.
4	RO	0b	Reserved.
3	RW	0b	<b>Unsupported Request Reporting Enable (URRE):</b> When set, this bit allows signaling ERR_NONFATAL, ERR_FATAL, or ERR_CORR to the Root Control register when detecting an unmasked Unsupported Request (UR). An ERR_CORR is signaled when an unmasked Advisory Non-Fatal UR is received. An ERR_FATAL or ERR_NONFATAL is sent to the Root Control register when an uncorrectable non-Advisory UR is received with the severity bit set in the Uncorrectable Error Severity register.
2	RW	0b	<b>Fatal Error Reporting Enable (FERE):</b> When set, this bit enables signaling of ERR_FATAL to the Root Control register due to internally detected errors or error messages received across the link. Other bits also control the full scope of related error reporting.
1	RW	0b	<b>Non-Fatal Error Reporting Enable (NERE):</b> When set, this bit enables signaling of ERR_NONFATAL to the Root Control register due to internally detected errors or error messages received across the link. Other bits also control the full scope of related error reporting.
0	RW	0b	<b>Correctable Error Reporting Enable (CERE):</b> When set, this bit enables signaling of ERR_CORR to the Root Control register due to internally detected errors or error messages received across the link. Other bits also control the full scope of related error reporting.



## 6.37 DSTS—Device Status

B/D/F/Type: 0/1/0/PCI  
 Address Offset: AA–ABh  
 Default Value: 0000h  
 Access: RO, RWC  
 Size: 16 bits

This register provides the reflects status corresponding to controls in the Device Control register. The error reporting bits are in reference to errors detected by this device, not errors messages received across the link.

Bit	Access	Default Value	Description
15:6	RO	000h	Reserved
5	RO	0b	<b>Transactions Pending (TP):</b> 0 = All pending transactions (including completions for any outstanding non-posted requests on any used virtual channel) have been completed. 1 = Indicates that the device has transaction(s) pending (including completions for any outstanding non-posted requests for all used Traffic Classes).
4	RO	0b	Reserved
3	RWC	0b	<b>Unsupported Request Detected (URD):</b> When set, this bit indicates that the Device received an Unsupported Request. Errors are logged in this register regardless of whether error reporting is enabled or not in the Device Control Register. Additionally, the Non-Fatal Error Detected bit or the Fatal Error Detected bit is set according to the setting of the Unsupported Request Error Severity bit. In production systems setting the Fatal Error Detected bit is not an option as support for AER will not be reported.
2	RWC	0b	<b>Fatal Error Detected (FED):</b> When set, this bit indicates that fatal error(s) were detected. Errors are logged in this register regardless of whether error reporting is enabled or not in the Device Control register. When Advanced Error Handling is enabled, errors are logged in this register regardless of the settings of the uncorrectable error mask register.
1	RWC	0b	<b>Non-Fatal Error Detected (NFED):</b> When set, this bit indicates that non-fatal error(s) were detected. Errors are logged in this register regardless of whether error reporting is enabled or not in the Device Control register. When Advanced Error Handling is enabled, errors are logged in this register regardless of the settings of the uncorrectable error mask register.
0	RWC	0b	<b>Correctable Error Detected (CED):</b> When set, this bit indicates that correctable error(s) were detected. Errors are logged in this register regardless of whether error reporting is enabled or not in the Device Control register. When Advanced Error Handling is enabled, errors are logged in this register regardless of the settings of the correctable error mask register.



## 6.38 LCAP—Link Capabilities

B/D/F/Type: 0/1/0/PCI  
 Address Offset: AC–AFh  
 Default Value: 02214D01h  
 Access: RO, RWO  
 Size: 32 bits

This register indicates PCI Express device specific capabilities.

Bit	Access	Default Value	Description
31:24	RO	02h	<b>Port Number (PN):</b> This field indicates the PCI Express port number for the given PCI Express link. Matches the value in Element Self Description[31:24].
23:22	RO	000b	Reserved
21	RO	1b	<b>Link Bandwidth Notification Capability:</b> A value of 1b indicates support for the Link Bandwidth Notification status and interrupt mechanisms. This capability is required for all Root Ports and Switch downstream ports supporting Links wider than x1 and/or multiple Link speeds.  This field is not applicable and is reserved for Endpoint devices, PCI Express to PCI/PCI-X bridges, and Upstream Ports of Switches.  Devices that do not implement the Link Bandwidth Notification capability must hardwire this bit to 0b.
20	RO	0b	<b>Data Link Layer Link Active Reporting Capable (DLLARC):</b> For a Downstream Port, this bit must be set to 1b if the component supports the optional capability of reporting the DL_Active state of the Data Link Control and Management State Machine.  For Upstream Ports and components that do not support this optional capability, this bit must be hardwired to 0b.
19	RO	0b	<b>Surprise Down Error Reporting Capable (SDERC):</b> For a Downstream Port, this bit must be set to 1b if the component supports the optional capability of detecting and reporting a Surprise Down error condition.  For Upstream Ports and components that do not support this optional capability, this bit must be hardwired to 0b.
18	RO	0b	<b>Clock Power Management (CPM):</b> A value of 1b in this bit indicates that the component tolerates the removal of any reference clock(s) when the link is in the L1 and L2/3 Ready link states. A value of 0b indicates the component does not have this capability and that reference clock(s) must not be removed in these link states.  This capability is applicable only in form factors that support "clock request" (CLKREQ#) capability.  For a multi-function device, each function indicates its capability independently. Power Management configuration software must only permit reference clock removal if all functions of the multifunction device indicate a 1b in this bit.
17:15	RWO	010b	<b>L1 Exit Latency (L1ELAT):</b> Indicates the length of time this Port requires to complete the transition from L1 to L0. The value 010 b indicates the range of 2 us to less than 4 us.  Both bytes of this register that contain a portion of this field must be written simultaneously in order to prevent an intermediate (and undesired) value from ever existing.



Bit	Access	Default Value	Description
14:12	RO	100b	<p><b>LOs Exit Latency (LOSELAT):</b> Indicates the length of time this Port requires to complete the transition from LOs to LO.</p> <p>000 = Less than 64 ns                      001 = 64 ns to less than 128 ns                      010 = 128 ns to less than 256 ns                      011 = 256 ns to less than 512 ns                      100 = 512 ns to less than 1 us                      101 = 1 us to less than 2 us                      110 = 2 us – 4 us                      111 = More than 4 us</p> <p>The actual value of this field depends on the common Clock Configuration bit (LCTL[6])</p>
11:10	RWO	11b	<p><b>Active State Link PM Support (ASLPMS):</b> The MCH supports ASPM LOs and L1.</p>
9:4	RO	10h	<p><b>Max Link Width (MLW):</b> This field indicates the maximum number of lanes supported for this link.</p> <p>08h = x8                      10h = x16</p> <p>For the 3210 MCH with dual 8-lane (x8) configuration, the value of 10h is reserved. The supported maximum lane size is 8-lanes (x8) for this link.</p> <p>For the 3200 MCH, the value of 10h is reserved. The supported maximum lane size is 8-lanes (x8) for this link.</p>
3:0	RWO	1h	<p><b>Max Link Speed (MLS):</b> Supported Link Speed - This field indicates the supported Link speed(s) of the associated Port.</p> <p>0001b = 2.5GT/s Link speed supported</p> <p>All other encodings are reserved.</p>



## 6.39 LCTL—Link Control

B/D/F/Type: 0/1/0/PCI  
 Address Offset: B0–B1h  
 Default Value: 0000h  
 Access: RO, RW, RW/SC  
 Size: 16 bits

This register allows control of PCI Express link.

Bit	Access	Default Value	Description
15:12	RO	0000b	Reserved
11	RW	0b	<p><b>Link Autonomous Bandwidth Interrupt Enable:</b> When set, this bit enables the generation of an interrupt to indicate that the Link Autonomous Bandwidth Status bit has been set.</p> <p>This bit is not applicable and is reserved for Endpoint devices, PCI Express to PCI/PCI-X bridges, and Upstream Ports of Switches.</p> <p>Devices that do not implement the Link Bandwidth Notification capability must hardwire this bit to 0b.</p>
10	RW	0b	<p><b>Link Bandwidth Management Interrupt Enable:</b> When set, this bit enables the generation of an interrupt to indicate that the Link Bandwidth Management Status bit has been set.</p> <p>This bit is not applicable and is reserved for Endpoint devices, PCI Express to PCI/PCI-X bridges, and Upstream Ports of Switches.</p>
9	RO	0b	<p><b>Hardware Autonomous Width Disable:</b> When set, this bit disables hardware from changing the Link width for reasons other than attempting to correct unreliable Link operation by reducing Link width.</p> <p>Devices that do not implement the ability autonomously to change Link width are permitted to hardwire this bit to 0b.</p> <p>The MCH does not support autonomous width change. So, this bit is "RO".</p>
8	RO	0b	<p><b>Enable Clock Power Management (ECPM):</b> Applicable only for form factors that support a "Clock Request" (CLKREQ#) mechanism, this enable functions as follows:</p> <p>0 = Clock power management is disabled and device must hold CLKREQ# signal low</p> <p>1 = When this bit is set to 1 the device is permitted to use CLKREQ# signal to power manage link clock according to protocol defined in appropriate form factor specification.</p> <p>Default value of this field is 0b.</p> <p>Components that do not support Clock Power Management (as indicated by a 0b value in the Clock Power Management bit of the Link Capabilities Register) must hardwire this bit to 0b.</p>
7	RW	0b	<p><b>Extended Synch (ES):</b></p> <p>0 = Standard Fast Training Sequence (FTS).</p> <p>1 = Forces the transmission of additional ordered sets when exiting the L0s state and when in the Recovery state.</p> <p>This mode provides external devices (e.g., logic analyzers) monitoring the Link time to achieve bit and symbol lock before the link enters L0 and resumes communication.</p> <p>This is a test mode only and may cause other undesired side effects such as buffer overflows or underruns.</p>





Bit	Access	Default Value	Description
6	RW	0b	<p><b>Common Clock Configuration (CCC):</b>            0 = Indicates that this component and the component at the opposite end of this Link are operating with asynchronous reference clock.            1 = Indicates that this component and the component at the opposite end of this Link are operating with a distributed common reference clock.            The state of this bit affects the L0s Exit Latency reported in LCAP[14:12] and the N_FTS value advertised during link training.</p>
5	RW/SC	0b	<p><b>Retrain Link (RL):</b>            0 = Normal operation.            1 = Full Link retraining is initiated by directing the Physical Layer LTSSM from L0, L0s, or L1 states to the Recovery state.            This bit always returns 0 when read.            This bit is cleared automatically (no need to write a 0).            It is permitted to write 1b to this bit while simultaneously writing modified values to other fields in this register. If the LTSSM is not already in Recovery or Configuration, the resulting Link training must use the modified values. If the LTSSM is already in Recovery or Configuration, the modified values are not required to affect the Link training that's already in progress.</p>
4	RW	0b	<p><b>Link Disable (LD):</b>            0 = Normal operation.            1 = Link is disabled. Forces the LTSSM to transition to the Disabled state (via Recovery) from L0, L0s, or L1 states. Link retraining happens automatically on 0 to 1 transition, just like when coming out of reset.            Writes to this bit are immediately reflected in the value read from the bit, regardless of actual Link state.</p>
3	RO	0b	<b>Read Completion Boundary (RCB):</b> Hardwired to 0 to indicate 64 byte.
2	RO	0b	Reserved
1:0	RW	00b	<p><b>Active State PM (ASPM):</b> Controls the level of active state power management supported on the given link.            00 = Disabled            01 = L0s Entry Supported            10 = Reserved            11 = L0s and L1 Entry Supported</p>



## 6.40 LSTS—Link Status

B/D/F/Type: 0/1/0/PCI  
 Address Offset: B2–B3h  
 Default Value: 1000h  
 Access: RWC, RO  
 Size: 16 bits

This register indicates PCI Express link status.

Bit	Access	Default Value	Description
15	RWC	0b	<b>Link Autonomous Bandwidth Status (LABWS):</b> This bit is set to 1b by hardware to indicate that hardware has autonomously changed link speed or width, without the port transitioning through DL_Down status, for reasons other than to attempt to correct unreliable link operation. This bit must be set if the Physical Layer reports a speed or width change was initiated by the downstream component that was indicated as an autonomous change.
14	RWC	0b	<b>Link Bandwidth Management Status (LBWMS):</b> This bit is set to 1b by hardware to indicate that either of the following has occurred without the port transitioning through DL_Down status: A link retraining initiated by a write of 1b to the Retrain Link bit has completed.  <b>NOTE:</b> This bit is Set following any write of 1b to the Retrain Link bit, including when the Link is in the process of retraining for some other reason. Hardware has autonomously changed link speed or width to attempt to correct unreliable link operation, either through an LTSSM timeout or a higher level process This bit must be set if the Physical Layer reports a speed or width change was initiated by the downstream component that was not indicated as an autonomous change.
13	RO	0b	<b>Data Link Layer Link Active (Optional) (DLLLLA):</b> This bit indicates the status of the Data Link Control and Management State Machine. It returns a 1b to indicate the DL_Active state, 0b otherwise. This bit must be implemented if the corresponding Data Link Layer Active Capability bit is implemented. Otherwise, this bit must be hardwired to 0b.
12	RO	1b	<b>Slot Clock Configuration (SCC):</b> 0 = The device uses an independent clock irrespective of the presence of a reference on the connector. 1 = The device uses the same physical reference clock that the platform provides on the connector.
11	RO	0b	<b>Link Training (LTRN):</b> Indicates that the Physical Layer LTSSM is in the Configuration or Recovery state, or that 1b was written to the Retrain Link bit but Link training has not yet begun. Hardware clears this bit when the LTSSM exits the Configuration/Recovery state once Link training is complete.
10	RO	0b	<b>Undefined:</b> The value read from this bit is undefined. In previous versions of this specification, this bit was used to indicate a Link Training Error. System software must ignore the value read from this bit. System software is permitted to write any value to this bit.



Bit	Access	Default Value	Description
9:4	RO	00h	<b>Negotiated Link Width (NLW):</b> Indicates negotiated link width. This field is valid only when the link is in the L0, L0s, or L1 states (after link width negotiation is successfully completed). 01h = x1 10h = x16 All other encodings are reserved.
3:0	RO	0h	<b>Current Link Speed (CLS):</b> This field indicates the negotiated Link speed of the given PCI Express Link. 0001b = 2.5 GT/s PCI Express Link All other encodings are reserved. The value in this field is undefined when the Link is not up.

## 6.41 SLOTCAP—Slot Capabilities

B/D/F/Type: 0/1/0/PCI  
 Address Offset: B4–B7h  
 Default Value: 00040000h  
 Access: RWO, RO  
 Size: 32 bits

PCI Express Slot related registers.

Bit	Access	Default Value	Description
31:19	RWO	0000h	<b>Physical Slot Number (PSN):</b> Indicates the physical slot number attached to this Port.
18	RO	1b	Reserved
17	RO	0b	<b>Electromechanical Interlock Present (EIP):</b> When set to 1b, this bit indicates that an Electromechanical Interlock is implemented on the chassis for this slot.
16:15	RWO	00b	<b>Slot Power Limit Scale (SPLS):</b> Specifies the scale used for the Slot Power Limit Value. 00 = 1.0x 01 = 0.1x 10 = 0.01x 11 = 0.001x If this field is written, the link sends a Set_Slot_Power_Limit message.
14:7	RWO	00h	<b>Slot Power Limit Value (SPLV):</b> In combination with the Slot Power Limit Scale value, specifies the upper limit on power supplied by slot. Power limit (in Watts) is calculated by multiplying the value in this field by the value in the Slot Power Limit Scale field. If this field is written, the link sends a Set_Slot_Power_Limit message.
6:5	RO	00b	Reserved
4	RO	0b	<b>Power Indicator Present (PIP):</b> When set to 1b, this bit indicates that a Power Indicator is electrically controlled by the chassis for this slot.
3	RO	0b	<b>Attention Indicator Present (AIP):</b> When set to 1b, this bit indicates that an Attention Indicator is electrically controlled by the chassis.



Bit	Access	Default Value	Description
2	RO	0b	<b>MRL Sensor Present (MSP):</b> When set to 1b, this bit indicates that an MRL Sensor is implemented on the chassis for this slot.
1	RO	0b	<b>Power Controller Present (PCP):</b> When set to 1b, this bit indicates that a software programmable Power Controller is implemented for this slot/adaptor (depending on form factor).
0	RO	0b	<b>Attention Button Present (ABP):</b> When set to 1b, this bit indicates that an Attention Button for this slot is electrically controlled by the chassis.

## 6.42 SLOTCTL—Slot Control

B/D/F/Type: 0/1/0/PCI  
 Address Offset: B8–B9h  
 Default Value: 0000h  
 Access: RO, RW  
 Size: 16 bits

PCI Express Slot related registers.

Bit	Access	Default Value	Description
15:13	RO	000b	Reserved
12	RO	0b	<b>Data Link Layer State Changed Enable (DLLSCE):</b> If the Data Link Layer Link Active capability is implemented, when set to 1b, this field enables software notification when Data Link Layer Link Active field is changed. If the Data Link Layer Link Active capability is not implemented, this bit is permitted to be read-only with a value of 0b.
11	RO	0b	<b>Electromechanical Interlock Control (EIC):</b> If an Electromechanical Interlock is implemented, a write of 1b to this field causes the state of the interlock to toggle. A write of 0b to this field has no effect. A read to this register always returns a 0.
10	RO	0b	<b>Power Controller Control (PCC):</b> If a Power Controller is implemented, this field when written sets the power state of the slot per the defined encodings. Reads of this field must reflect the value from the latest write, unless software issues a write without waiting for the previous command to complete in which case the read value is undefined. Depending on the form factor, the power is turned on/off either to the slot or within the adaptor. Note that in some cases the power controller may autonomously remove slot power or not respond to a power-up request based on a detected fault condition, independent of the Power Controller Control setting. The defined encodings are: 0 = Power On 1 = Power Off If the Power Controller Implemented field in the Slot Capabilities register is set to 0b, then writes to this field have no effect and the read value of this field is undefined.



Bit	Access	Default Value	Description
9:8	RO	00b	<p><b>Power Indicator Control (PIC):</b> If a Power Indicator is implemented, writes to this field set the Power Indicator to the written state. Reads of this field must reflect the value from the latest write, unless software issues a write without waiting for the previous command to complete in which case the read value is undefined.</p> <p>00 = Reserved                      01 = On                      10 = Blink                      11 = Off</p> <p>If the Power Indicator Present bit in the Slot Capabilities register is 0b, this field is permitted to be read-only with a value of 00b.</p>
7:6	RO	00b	<p><b>Attention Indicator Control (AIC):</b> If an Attention Indicator is implemented, writes to this field set the Attention Indicator to the written state.</p> <p>Reads of this field must reflect the value from the latest write, unless software issues a write without waiting for the previous command to complete in which case the read value is undefined. If the indicator is electrically controlled by chassis, the indicator is controlled directly by the downstream port through implementation specific mechanisms.</p> <p>00 = Reserved                      01 = On                      10 = Blink                      11 = Off</p> <p>If the Attention Indicator Present bit in the Slot Capabilities register is 0b, this field is permitted to be read only with a value of 00b.</p>
5:4	RO	00b	Reserved
3	RW	0b	<p><b>Presence Detect Changed Enable (PDCE):</b> When set to 1b, this bit enables software notification on a presence detect changed event.</p>
2	RO	0b	<p><b>MRL Sensor Changed Enable (MSCE):</b> When set to 1b, this bit enables software notification on a MRL sensor changed event.</p> <p>Default value of this field is 0b. If the MRL Sensor Present field in the Slot Capabilities register is set to 0b, this bit is permitted to be read-only with a value of 0b.</p>
1	RO	0b	<p><b>Power Fault Detected Enable (PFDE):</b> When set to 1b, this bit enables software notification on a power fault event.</p> <p>Default value of this field is 0b. If Power Fault detection is not supported, this bit is permitted to be read-only with a value of 0b</p>
0	RO	0b	<p><b>Button Pressed Enable (ABPE):</b> When set to 1b, this bit enables software notification on an attention button pressed event.</p>



## 6.43 SLOTSTS—Slot Status

B/D/F/Type: 0/1/0/PCI  
 Address Offset: BA–BBh  
 Default Value: 0000h  
 Access: RO, RWC  
 Size: 16 bits

PCI Express Slot related registers.

Bit	Access	Default Value	Description
15:7	RO	0000000b	Reserved
6	RO	0b	<p><b>Presence Detect State (PDS):</b> This bit indicates the presence of an adapter in the slot, reflected by the logical "OR" of the Physical Layer in-band presence detect mechanism and, if present, any out-of-band presence detect mechanism defined for the slot's corresponding form factor. Note that the in-band presence detect mechanism requires that power be applied to an adapter for its presence to be detected.</p> <p>0 = Slot Empty            1 = Card Present in Slot</p> <p>This register must be implemented on all Downstream Ports that implement slots. For Downstream Ports not connected to slots (where the Slot Implemented bit of the PCI Express Capabilities Register is 0b), this bit must return 1b.</p>
5:4	RO	00b	Reserved
3	RWC	0b	<p><b>Detect Changed (PDC):</b> This bit is set when the value reported in Presence Detect State is changed.</p>
2	RO	0b	<p><b>MRL Sensor Changed (MSC):</b> If an MRL sensor is implemented, this bit is set when a MRL Sensor state change is detected. If an MRL sensor is not implemented, this bit must not be set.</p>
1	RO	0b	<p><b>Power Fault Detected (PFD):</b> If a Power Controller that supports power fault detection is implemented, this bit is set when the Power Controller detects a power fault at this slot. Note that, depending on hardware capability, it is possible that a power fault can be detected at any time, independent of the Power Controller Control setting or the occupancy of the slot. If power fault detection is not supported, this bit must not be set.</p>
0	RO	0b	<p><b>Attention Button Pressed (ABP):</b> If an Attention Button is implemented, this bit is set when the attention button is pressed. If an Attention Button is not supported, this bit must not be set.</p>



## 6.44 RCTL—Root Control

B/D/F/Type: 0/1/0/PCI  
 Address Offset: BC–BDh  
 Default Value: 0000h  
 Access: RO, RW  
 Size: 16 bits

This register allows control of PCI Express Root Complex specific parameters. The system error control bits in this register determine if corresponding SERRs are generated when our device detects an error (reported in this device's Device Status register) or when an error message is received across the link. Reporting of SERR as controlled by these bits takes precedence over the SERR Enable in the PCI Command Register.

Bit	Access	Default Value	Description
15:4	RO	000h	Reserved
3	RW	0b	<b>PME Interrupt Enable (PMEIE):</b> 0 = No interrupts are generated as a result of receiving PME messages. 1 = Enables interrupt generation upon receipt of a PME message as reflected in the PME Status bit of the Root Status Register. A PME interrupt is also generated if the PME Status bit of the Root Status Register is set when this bit is set from a cleared state.
2	RW	0b	<b>System Error on Fatal Error Enable (SEFEE):</b> Controls the Root Complex's response to fatal errors. 0 = No SERR generated on receipt of fatal error. 1 = Indicates that an SERR should be generated if a fatal error is reported by any of the devices in the hierarchy associated with this Root Port, or by the Root Port itself.
1	RW	0b	<b>System Error on Non-Fatal Uncorrectable Error Enable (SENFUEE):</b> Controls the Root Complex's response to non-fatal errors. 0 = No SERR generated on receipt of non-fatal error. 1 = Indicates that an SERR should be generated if a non-fatal error is reported by any of the devices in the hierarchy associated with this Root Port, or by the Root Port itself.
0	RW	0b	<b>System Error on Correctable Error Enable (SECEE):</b> Controls the Root Complex's response to correctable errors. 0 = No SERR generated on receipt of correctable error. 1 = Indicates that an SERR should be generated if a correctable error is reported by any of the devices in the hierarchy associated with this Root Port, or by the Root Port itself.



## 6.45 RSTS—Root Status

B/D/F/Type: 0/1/0/PCI  
 Address Offset: C0–C3h  
 Default Value: 00000000h  
 Access: RO, RWC  
 Size: 32 bits

This register provides information about PCI Express Root Complex specific parameters.

Bit	Access	Default Value	Description
31:18	RO	0000h	Reserved
17	RO	0b	<b>PME Pending (PMEP)</b> : Indicates that another PME is pending when the PME Status bit is set. When the PME Status bit is cleared by software; the PME is delivered by hardware by setting the PME Status bit again and updating the Requestor ID appropriately. The PME pending bit is cleared by hardware if no more PMEs are pending.
16	RWC	0b	<b>PME Status (PMES)</b> : Indicates that PME was asserted by the requestor ID indicated in the PME Requestor ID field. Subsequent PMEs are kept pending until the status register is cleared by writing a 1 to this field.
15:0	RO	0000h	<b>PME Requestor ID (PMERID)</b> : Indicates the PCI requestor ID of the last PME requestor.

## 6.46 PELC—PCI Express Legacy Control

B/D/F/Type: 0/1/0/PCI  
 Address Offset: EC–EFh  
 Default Value: 00000000h  
 Access: RO, RW  
 Size: 32 bits

This register controls functionality that is needed by Legacy (non-PCI Express aware) OSs during run time.

Bit	Access	Default Value	Description
31:3	RO	00000000h	Reserved
2	RW	0b	<b>PME GPE Enable (PMEGPE)</b> : 0 = Do not generate GPE PME message when PME is received. 1 = Generate a GPE PME message when PME is received (Assert_PMEGPE and Deassert_PMEGPE messages on DMI). This enables the MCH to support PMEs on the PCI Express port under legacy OSs.
1	RO	0b	Reserved
0	RW	0b	<b>General Message GPE Enable (GENGPE)</b> : 0 = Do not forward received GPE assert/de-assert messages. 1 = Forward received GPE assert/de-assert messages. These general GPE message can be received via the PCI Express port from an external Intel device and will be subsequently forwarded to the ICH (via Assert_GPE and Deassert_GPE messages on DMI).





## 6.47 VCECH—Virtual Channel Enhanced Capability Header

B/D/F/Type: 0/1/0/MMR  
 Address Offset: 100–103h  
 Default Value: 14010002h  
 Access: RO  
 Size: 32 bits

This register indicates PCI Express device Virtual Channel capabilities. Extended capability structures for PCI Express devices are located in PCI Express extended configuration space and have different field definitions than standard PCI capability structures.

Bit	Access	Default Value	Description
31:20	RO	140h	<b>Pointer to Next Capability (PNC)</b> : The Link Declaration Capability is the next in the PCI Express extended capabilities list.
19:16	RO	1h	<b>PCI Express Virtual Channel Capability Version (PCIEVCCV)</b> : Hardwired to 1 to indicate compliances with the 1.1 version of the PCI Express specification.
15:0	RO	0002h	<b>Extended Capability ID (ECID)</b> : Value of 0002 h identifies this linked list item (capability structure) as being for PCI Express Virtual Channel registers.

## 6.48 PVCCAP1—Port VC Capability Register 1

B/D/F/Type: 0/1/0/MMR  
 Address Offset: 104–107h  
 Default Value: 00000000h  
 Access: RO  
 Size: 32 bits

This register describes the configuration of PCI Express Virtual Channels associated with this port.

Bit	Access	Default Value	Description
31:7	RO	00000h	Reserved
6:4	RO	000b	<b>Low Priority Extended VC Count (LPEVCC)</b> : Indicates the number of (extended) Virtual Channels in addition to the default VC belonging to the low-priority VC (LPVC) group that has the lowest priority with respect to other VC resources in a strict-priority VC Arbitration. The value of 0 in this field implies strict VC arbitration.
3	RO	0b	Reserved
2:0	RO	000b	<b>Extended VC Count (EVCC)</b> : Indicates the number of (extended) Virtual Channels in addition to the default VC supported by the device.



## 6.49 PVCCAP2—Port VC Capability Register 2

B/D/F/Type: 0/1/0/MMR  
Address Offset: 108–10Bh  
Default Value: 00000000h  
Access: RO  
Size: 32 bits

This register describes the configuration of PCI Express Virtual Channels associated with this port.

Bit	Access	Default Value	Description
31:24	RO	00h	<b>VC Arbitration Table Offset (VCATO):</b> Indicates the location of the VC Arbitration Table. This field contains the zero-based offset of the table in DQWords (16 bytes) from the base address of the Virtual Channel Capability Structure. A value of 0 indicates that the table is not present (due to fixed VC priority).
23:0	RO	0000h	Reserved

## 6.50 PVCCTL—Port VC Control

B/D/F/Type: 0/1/0/MMR  
Address Offset: 10C–10Dh  
Default Value: 0000h  
Access: RO, RW  
Size: 16 bits

Bit	Access	Default Value	Description
15:4	RO	000h	Reserved
3:1	RW	000b	<b>VC Arbitration Select (VCAS):</b> This field will be programmed by software to the only possible value as indicated in the VC Arbitration Capability field. Since there is no other VC supported than the default, this field is reserved.
0	RO	0b	Reserved



## 6.51 VCORCAP—VCO Resource Capability

B/D/F/Type: 0/1/0/MMR  
 Address Offset: 110–113h  
 Default Value: 0000001h  
 Access: RO  
 Size: 32 bits

Bit	Access	Default Value	Description
31:16	RO	0000h	Reserved
15	RO	0b	<b>Reject Snoop Transactions (RSNPT):</b> 0 = Transactions with or without the No Snoop bit set within the Transaction Layer Packet header are allowed on this VC. 1 = When Set, any transaction for which the No Snoop attribute is applicable but is not Set within the TLP Header will be rejected as an Unsupported Request.
14:8	RO	0000h	Reserved
7:0	RO	01h	<b>Port Arbitration Capability:</b> Indicates types of Port Arbitration supported by the VC resource. This field is valid for all Switch Ports, Root Ports that support peer-to-peer traffic, and RCRBs, but not for PCI Express Endpoint devices or Root Ports that do not support peer to peer traffic. Each bit location within this field corresponds to a Port Arbitration Capability defined below. When more than one bit in this field is Set, it indicates that the VC resource can be configured to provide different arbitration services. Software selects among these capabilities by writing to the Port Arbitration Select field (see below). Defined bit positions are: Bit[0] = Default = 01b; Non-configurable hardware-fixed arbitration scheme, e.g., Round Robin (RR) Bit[1] = Weighted Round Robin (WRR) arbitration with 32 phases Bit[2] = WRR arbitration with 64 phases Bit[3] = WRR arbitration with 128 phases Bit[4] = Time-based WRR with 128 phases Bit[5] = WRR arbitration with 256 phases Bits[6:7] = Reserved MCH default indicates "Non-configurable hardware-fixed arbitration scheme".



## 6.52 VCORCTL—VCO Resource Control

B/D/F/Type: 0/1/0/MMR  
Address Offset: 114–117h  
Default Value: 800000FFh  
Access: RO, RW  
Size: 32 bits

This register controls the resources associated with PCI Express Virtual Channel 0.

Bit	Access	Default Value	Description
31	RO	1b	<b>VCO Enable (VCOE):</b> For VCO, this is hardwired to 1 and read only as VCO can never be disabled.
30:27	RO	0h	Reserved
26:24	RO	000b	<b>VCO ID (VCOID):</b> Assigns a VC ID to the VC resource. For VCO, this is hardwired to 0 and read only.
23:20	RO	0000h	Reserved
19:17	RW	000b	<b>Port Arbitration Select:</b> This field configures the VC resource to provide a particular Port Arbitration service. This field is valid for RCRBs, Root Ports that support peer to peer traffic, and Switch Ports, but not for PCI Express Endpoint devices or Root Ports that do not support peer to peer traffic. The permissible value of this field is a number corresponding to one of the asserted bits in the Port Arbitration Capability field of the VC resource.
16:8	RO	00h	Reserved
7:1	RW	7Fh	<b>TC/VCO Map (TCVCOM):</b> Indicates the TCs (Traffic Classes) that are mapped to the VC resource. Bit locations within this field correspond to TC values. For example, when bit 7 is set in this field, TC7 is mapped to this VC resource. When more than one bit in this field is set, it indicates that multiple TCs are mapped to the VC resource. In order to remove one or more TCs from the TC/VC Map of an enabled VC, software must ensure that no new or outstanding transactions with the TC labels are targeted at the given Link.
0	RO	1b	<b>TC0/VCO Map (TCOVCOM):</b> Traffic Class 0 is always routed to VCO.



## 6.53 VCORSTS—VCO Resource Status

B/D/F/Type: 0/1/0/MMR  
 Address Offset: 11A–11Bh  
 Default Value: 0002h  
 Access: RO  
 Size: 16 bits

This register reports the Virtual Channel specific status.

Bit	Access	Default Value	Description
15:2	RO	0000h	Reserved
1	RO	1b	<b>VCO Negotiation Pending (VCONP):</b> 0 = The VC negotiation is complete. 1 = The VC resource is still in the process of negotiation (initialization or disabling).  This bit indicates the status of the process of Flow Control initialization. It is set by default on Reset, as well as whenever the corresponding Virtual Channel is Disabled or the Link is in the DL_Down state. It is cleared when the link successfully exits the FC_INIT2 state.  Before using a Virtual Channel, software must check whether the VC Negotiation Pending fields for that Virtual Channel are cleared in both Components on a Link.
0	RO	0b	Reserved

## 6.54 RCLDECH—Root Complex Link Declaration Enhanced

B/D/F/Type: 0/1/0/MMR  
 Address Offset: 140–143h  
 Default Value: 00010005h  
 Access: RO  
 Size: 32 bits

This capability declares links from this element (PCI Express) to other elements of the root complex component to which it belongs. See PCI Express specification for link/topology declaration requirements.

Bit	Access	Default Value	Description
31:20	RO	000h	<b>Pointer to Next Capability (PNC):</b> This is the last capability in the PCI Express extended capabilities list.
19:16	RO	1h	<b>Link Declaration Capability Version (LDCV):</b> Hardwired to 1 to indicate compliances with the 1.1 version of the PCI Express specification.
15:0	RO	0005h	<b>Extended Capability ID (ECID):</b> Value of 0005h identifies this linked list item (capability structure) as being for PCI Express Link Declaration Capability.



## 6.55 ESD—Element Self Description

B/D/F/Type: 0/1/0/MMR  
 Address Offset: 144–147h  
 Default Value: 02000100h  
 Access: RO, RWO  
 Size: 32 bits

This register provides information about the root complex element containing this Link Declaration Capability.

Bit	Access	Default Value	Description
31:24	RO	02h	<b>Port Number (PN)</b> : Specifies the port number associated with this element with respect to the component that contains this element. This port number value is utilized by the egress port of the component to provide arbitration to this Root Complex Element.
23:16	RWO	00h	<b>Component ID (CID)</b> : Identifies the physical component that contains this Root Complex Element.
15:8	RO	01h	<b>Number of Link Entries (NLE)</b> : Indicates the number of link entries following the Element Self Description. This field reports 1 (to Egress port only as we don't report any peer-to-peer capabilities in our topology).
7:4	RO	0h	Reserved
3:0	RO	0h	<b>Element Type (ET)</b> : Indicates Configuration Space Element.

## 6.56 LE1D—Link Entry 1 Description

B/D/F/Type: 0/1/0/MMR  
 Address Offset: 150–153h  
 Default Value: 00000000h  
 Access: RO, RWO  
 Size: 32 bits

This register provides the first part of a Link Entry which declares an internal link to another Root Complex Element.

Bit	Access	Default Value	Description
31:24	RO	00h	<b>Target Port Number (TPN)</b> : Specifies the port number associated with the element targeted by this link entry (Egress Port). The target port number is with respect to the component that contains this element as specified by the target component ID.
23:16	RWO	00h	<b>Target Component ID (TCID)</b> : Identifies the physical or logical component that is targeted by this link entry.
15:2	RO	0000h	Reserved
1	RO	0b	<b>Link Type (LTYP)</b> : Indicates that the link points to memory-mapped space (for RCRB). The link address specifies the 64-bit base address of the target RCRB.
0	RWO	0b	<b>Link Valid (LV)</b> : 0 = Link Entry is not valid and will be ignored. 1 = Link Entry specifies a valid link.



## 6.57 LE1A—Link Entry 1 Address

B/D/F/Type: 0/1/0/MMR  
 Address Offset: 158-15Fh  
 Default Value: 0000000000000000h  
 Access: RO, RWO  
 Size: 64 bits

This register provides the second part of a Link Entry which declares an internal link to another Root Complex Element.

Bit	Access	Default Value	Description
63:32	RO	0000000h	Reserved
31:12	RWO	00000h	<b>Link Address (LA)</b> : Memory mapped base address of the RCRB that is the target element (Egress Port) for this link entry.
11:0	RO	000h	Reserved

## 6.58 PESSTS—PCI Express\* Sequence Status

B/D/F/Type: 0/1/0/MMR  
 Address Offset: 218–21Fh  
 Default Value: 0000000000000FFFh  
 Access: RO  
 Size: 64 bits

PCI Express status reporting that is required by the PCI Express specification.

Bit	Access	Default Value	Description
63:60	RO	0h	Reserved
59:48	RO	000h	<b>Next Transmit Sequence Number (NTSN)</b> : Value of the NXT_TRANS_SEQ counter. This counter represents the transmit Sequence number to be applied to the next Transaction Layer Packet to be transmitted onto the Link for the first time.
47:44	RO	0h	Reserved
43:32	RO	000h	<b>Next Packet Sequence Number (NPSN)</b> : Packet sequence number to be applied to the next Transaction Layer Packet to be transmitted or re-transmitted onto the Link.
31:28	RO	0h	Reserved
27:16	RO	000h	<b>Next Receive Sequence Number (NRSN)</b> : This is the sequence number associated with the Transaction Layer Packet that is expected to be received next.
15:12	RO	0h	Reserved
11:0	RO	FFFh	<b>Last Acknowledged Sequence Number (LASN)</b> : This is the sequence number associated with the last acknowledged Transaction Layer Packet.



§ §





# 7 Intel Manageability Engine Subsystem PCI (D3:F0,F3)

This chapter provides the registers for Device 3 (D3), Functions 0 (F0) and 3 (F3).

## 7.1 HECI Function in ME Subsystem (D3:F0)

Device 3 contains registers for the Intel Manageability Engine. The table below lists the PCI configuration registers in order of ascending offset address.

**Note:** The following sections describe Device 3 configuration registers only.

**Table 13. HECI Function in ME Subsystem (D3:F0) Register Address Map**

Address Offset	Symbol	Register Name	Default Value	Access
0–3h	ID	Identifiers	29F48086h	RO
4–5h	CMD	Command	0000h	RO, RW
6–7h	STS	Device Status	0010h	RO
8h	RID	Revision ID	See register description	RO
9–Bh	CC	Class Code	0C8001h	RO
Ch	CLS	Cache Line Size	00h	RO
Dh	MLT	Master Latency Timer	00h	RO
Eh	HTYPE	Header Type	80h	RO
10–17h	HECI_MBAR	HECI MMIO Base Address	00000000000004h	RO, RW
2C–2Fh	SS	Sub System Identifiers	00000000h	RWO
34h	CAP	Capabilities Pointer	50h	RO
3C–3Dh	INTR	Interrupt Information	0100h	RO, RW
3Eh	MGNT	Minimum Grant	00h	RO
3Fh	MLAT	Maximum Latency	00h	RO
40–43h	HFS	Host Firmware Status	00000000h	RO
50–51h	PID	PCI Power Management Capability ID	8C01h	RO
52–53h	PC	PCI Power Management Capabilities	C803h	RO
54–55h	PMCS	PCI Power Management Control And Status	0008h	RWC, RO, RW
8C–8Dh	MID	Message Signaled Interrupt Identifiers	0005h	RO
8E–8Fh	MC	Message Signaled Interrupt Message Control	0080h	RO, RW
90–93h	MA	Message Signaled Interrupt Message Address	00000000h	RW, RO
94–97h	MUA	Message Signaled Interrupt Upper Address (Optional)	00000000h	RW
98–99h	MD	Message Signaled Interrupt Message Data	0000h	RW
A0h	HIDM	HECI Interrupt Delivery Mode	00h	RW



### 7.1.1 ID—Identifiers

B/D/F/Type: 0/3/0/PCI  
 Address Offset: 0–3h  
 Default Value: 29F48086h  
 Access: RO  
 Size: 32 bits

Bit	Access	Default Value	Description
31:16	RO	29F4h	<b>Device ID (DID): Device ID (DID):</b> This field indicates what device number assigned by Intel.
15:0	RO	8086h	<b>Vendor ID (VID): Vendor ID (VID):</b> This field indicates Intel is the vendor, assigned by the PCI SIG.

### 7.1.2 CMD—Command

B/D/F/Type: 0/3/0/PCI  
 Address Offset: 4–5h  
 Default Value: 0000h  
 Access: RO, RW  
 Size: 16 bits

Bit	Access	Default Value	Description
15:11	RO	00000b	Reserved
10	RW	0b	<b>Interrupt Disable (ID):</b> Disables this device from generating PCI line based interrupts. This bit does not have any effect on MSI operation.
9:3	RO	00h	Reserved
2	RW	0b	<b>Bus Master Enable (BME):</b> Controls the HECI host controller's ability to act as a system memory master for data transfers. When this bit is cleared, HECI bus master activity stops and any active DMA engines return to an idle condition. This bit is made visible to firmware through the H_PCI_CSR register, and changes to this bit may be configured by the H_PCI_CSR register to generate an ME MSI. 0 = HECI is blocked from generating MSI to the host processor. Note that this bit does not block HECI accesses to ME-UMA, i.e. writes or reads to the host and ME circular buffers through the read window and write window registers still cause ME backbone transactions to ME-UMA.
1	RW	0b	<b>Memory Space Enable (MSE):</b> Controls access to the HECI host controller's memory mapped register space.
0	RO	0b	Reserved



### 7.1.3 STS—Device Status

B/D/F/Type: 0/3/0/PCI  
 Address Offset: 6–7h  
 Default Value: 0010h  
 Access: RO  
 Size: 16 bits

Bit	Access	Default Value	Description
15:5	RO	0h	Reserved
4	RO	1b	<b>Capabilities List (CL)</b> : Indicates the presence of a capabilities list, hardwired to 1.
3	RO	0b	<b>Interrupt Status (IS)</b> : Indicates the interrupt status of the device 1 = Asserted
2:0	RO	000b	Reserved

### 7.1.4 RID—Revision ID

B/D/F/Type: 0/3/0/PCI  
 Address Offset: 8h  
 Default Value: see table below  
 Access: RO  
 Size: 8 bits

Bit	Access	Default Value	Description
7:0	RO	See Description	<b>Revision ID (RID)</b> : This field indicates stepping of the HECI host controller. Refer to the <i>Intel® 3200 and 3210 Chipset Specification Update</i> for the value of this register.

### 7.1.5 CC—Class Code

B/D/F/Type: 0/3/0/PCI  
 Address Offset: 9–Bh  
 Default Value: 0C8001h  
 Access: RO  
 Size: 24 bits

Bit	Access	Default Value	Description
23:16	RO	0ch	<b>Base Class Code (BCC)</b> : Indicates the base class code of the HECI host controller device.
15:8	RO	80h	<b>Sub Class Code (SCC)</b> : Indicates the sub class code of the HECI host controller device.
7:0	RO	01h	<b>Programming Interface (PI)</b> : Indicates the programming interface of the HECI host controller device.



### 7.1.6 CLS—Cache Line Size

B/D/F/Type: 0/3/0/PCI  
Address Offset: Ch  
Default Value: 00h  
Access: RO  
Size: 8 bits

Bit	Access	Default Value	Description
7:0	RO	00h	<b>Cache Line Size (CLS):</b> Not implemented, hardwired to 0.

### 7.1.7 MLT—Master Latency Timer

B/D/F/Type: 0/3/0/PCI  
Address Offset: Dh  
Default Value: 00h  
Access: RO  
Size: 8 bits

Bit	Access	Default Value	Description
7:0	RO	00h	<b>Master Latency Timer (MLT):</b> Not implemented, hardwired to 0.

### 7.1.8 HTYPE—Header Type

B/D/F/Type: 0/3/0/PCI  
Address Offset: Eh  
Default Value: 80h  
Access: RO  
Size: 8 bits

Bit	Access	Default Value	Description
7	RO	1b	<b>Multi-Function Device (MFD):</b> Indicates the HECI host controller is part of a multi-function device.
6:0	RO	0000000b	<b>Header Layout (HL):</b> Indicates that the HECI host controller uses a target device layout.



### 7.1.9 HECI\_MBAR—HECI MMIO Base Address

B/D/F/Type: 0/3/0/PCI  
 Address Offset: 10–17h  
 Default Value: 0000000000000004h  
 Access: RO, RW  
 Size: 64 bits

Bit	Access	Default Value	Description
63:4	RW	00000000 00000000 0h	<b>Base Address (BA)</b> : Base address of register memory space.
3	RO	0b	<b>Prefetchable (PF)</b> : Indicates that this range is not pre-fetchable
2:1	RO	10b	<b>Type (TP)</b> : Indicates that this range can be mapped anywhere in 64-bit address space.
0	RO	0b	<b>Resource Type Indicator (RTE)</b> : Indicates a request for register memory space.

### 7.1.10 SS—Sub System Identifiers

B/D/F/Type: 0/3/0/PCI  
 Address Offset: 2C–2Fh  
 Default Value: 00000000h  
 Access: RWO  
 Size: 32 bits

Bit	Access	Default Value	Description
31:16	RWO	0000h	<b>Subsystem ID (SSID)</b> : Indicates the sub-system identifier. This field should be programmed by BIOS during boot-up. Once written, this register becomes Read Only. This field can only be cleared by PLTRST#.
15:0	RWO	0000h	<b>Subsystem Vendor ID (SSVID)</b> : Indicates the sub-system vendor identifier. This field should be programmed by BIOS during boot-up. Once written, this register becomes Read Only. This field can only be cleared by PLTRST#.



### 7.1.11 CAP—Capabilities Pointer

B/D/F/Type: 0/3/0/PCI  
Address Offset: 34h  
Default Value: 50h  
Access: RO  
Size: 8 bits

Bit	Access	Default Value	Description
7:0	RO	50h	<b>Capability Pointer (CP):</b> Indicates the first capability pointer offset. It points to the PCI power management capability offset.

### 7.1.12 INTR—Interrupt Information

B/D/F/Type: 0/3/0/PCI  
Address Offset: 3C–3Dh  
Default Value: 0100h  
Access: RO, RW  
Size: 16 bits

Bit	Access	Default Value	Description
15:8	RO	01h	<b>Interrupt Pin (IPIN):</b> This field indicates the interrupt pin the HECI host controller uses. The value of 01h selects INTA# interrupt pin. Note: As HECI is an internal device in the MCH, the INTA# pin is implemented as an INTA# message to the ICH.
7:0	RW	00h	<b>Interrupt Line (ILINE):</b> Software written value to indicate which interrupt line (vector) the interrupt is connected to. No hardware action is taken on this register.

### 7.1.13 MGNT—Minimum Grant

B/D/F/Type: 0/3/0/PCI  
Address Offset: 3Eh  
Default Value: 00h  
Access: RO  
Size: 8 bits

Bit	Access	Default Value	Description
7:0	RO	00h	<b>Grant (GNT):</b> Not implemented, hardwired to 0.



### 7.1.14 MLAT—Maximum Latency

B/D/F/Type: 0/3/0/PCI  
 Address Offset: 3Fh  
 Default Value: 00h  
 Access: RO  
 Size: 8 bits

Bit	Access	Default Value	Description
7:0	RO	00h	<b>Latency (LAT)</b> : Not implemented, hardwired to 0.

### 7.1.15 HFS—Host Firmware Status

B/D/F/Type: 0/3/0/PCI  
 Address Offset: 40–43h  
 Default Value: 00000000h  
 Access: RO  
 Size: 32 bits

Bit	Access	Default Value	Description
31:0	RO	00000000h	<b>Firmware Status Host Access (FS_HA)</b> : Indicates current status of the firmware for the HECI controller. This field is the host's read only access to the FS field in the ME Firmware Status AUX register.

### 7.1.16 PID—PCI Power Management Capability ID

B/D/F/Type: 0/3/0/PCI  
 Address Offset: 50–51h  
 Default Value: 8C01h  
 Access: RO  
 Size: 16 bits

Bit	Access	Default Value	Description
15:8	RO	8Ch	<b>Next Capability (NEXT)</b> : Indicates the location of the next capability item in the list. This is the Message Signaled Interrupts capability.
7:0	RO	01h	<b>Cap ID (CID)</b> : Indicates that this pointer is a PCI power management.



### 7.1.17 PC—PCI Power Management Capabilities

B/D/F/Type: 0/3/0/PCI  
 Address Offset: 52–53h  
 Default Value: C803h  
 Access: RO  
 Size: 16 bits

Bit	Access	Default Value	Description
15:11	RO	11001b	<b>PME_Support (PSUP)</b> : Indicates the states that can generate PME#. HECI can assert PME# from any D-state except D1 or D2 which are not supported by HECI.
10	RO	0b	<b>D2_Support (D2S)</b> : The D2 state is not supported for the HECI host controller.
9	RO	0b	<b>D1_Support (D1S)</b> : The D1 state is not supported for the HECI host controller.
8:6	RO	000b	<b>Aux_Current (AUXC)</b> : Reports the maximum Suspend well current required when in the D3COLD state.
5	RO	0b	<b>Device Specific Initialization (DSI)</b> : Indicates whether device-specific initialization is required.
4	RO	0b	Reserved
3	RO	0b	<b>PME Clock (PMEC)</b> : Indicates that PCI clock is not required to generate PME#.
2:0	RO	011b	<b>Version (VS)</b> : Indicates support for Revision 1.2 of the PCI Power Management Specification.

### 7.1.18 PMCS—PCI Power Management Control And Status

B/D/F/Type: 0/3/0/PCI  
 Address Offset: 54–55h  
 Default Value: 0008h  
 Access: RWC, RO, RW  
 Size: 16 bits

Bit	Access	Default Value	Description
15	RWC	0b	<b>PME Status (PMES)</b> : The PME Status bit in HECI space can be set to '1' by ME FW performing a write into AUX register to set PMES. This bit is cleared by host processor writing a '1' to it. ME can not clear this bit. Host processor writes with value '0' have no effect on this bit. This bit is reset to '0' by MRST#
14:9	RO	000000b	Reserved
8	RW	0b	<b>PME Enable (PMEE)</b> : This bit is read/write, under control of host SW. It does not directly have an effect on PME events. However, this bit is shadowed into AUX space so ME FW can monitor it. The ME FW is responsible for ensuring that FW does not cause the PME-S bit to transition to '1' while the PMEE bit is '0', indicating that host SW had disabled PME. This bit is reset to '0' by MRST#
7:4	RO	0000b	Reserved



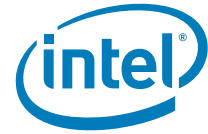

Bit	Access	Default Value	Description
3	RO	1b	<b>No_Soft_Reset (NSR)</b> : This bit indicates that when the HECI host controller is transitioning from D3hot to D0 due to power state command, it does not perform an internal reset.
2	RO	0b	Reserved
1:0	RW	00b	<b>Power State (PS)</b> : This field is used both to determine the current power state of the HECI host controller and to set a new power state. The values are: 00 = D0 state 11 = D3HOT state The D1 and D2 states are not supported for this HECI host controller. When in the D3HOT state, the HBA's configuration space is available, but the register memory spaces are not. Additionally, interrupts are blocked.

### 7.1.19 MID—Message Signaled Interrupt Identifiers

B/D/F/Type: 0/3/0/PCI  
 Address Offset: 8C–8Dh  
 Default Value: 0005h  
 Access: RO  
 Size: 16 bits

Bit	Access	Default Value	Description
15:8	RO	00h	<b>Next Pointer (NEXT)</b> : Indicates the next item in the list. This can be other capability pointers (such as PCI-X or PCI-Express) or it can be the last item in the list.
7:0	RO	05h	<b>Capability ID (CID)</b> : Capabilities ID indicates MSI.

### 7.1.20 MC—Message Signaled Interrupt Message Control

B/D/F/Type: 0/3/0/PCI  
 Address Offset: 8E–8Fh  
 Default Value: 0080h  
 Access: RO, RW  
 Size: 16 bits

Bit	Access	Default Value	Description
15:8	RO	00h	Reserved
7	RO	1b	<b>64 Bit Address Capable (C64)</b> : Specifies whether capable of generating 64-bit messages.
6:4	RO	000b	<b>Multiple Message Enable (MME)</b> : Not implemented, hardwired to 0.
3:1	RO	000b	<b>Multiple Message Capable (MMC)</b> : Not implemented, hardwired to 0.
0	RW	0b	<b>MSI Enable (MSIE)</b> : If set, MSI is enabled and traditional interrupt pins are not used to generate interrupts.



### 7.1.21 MA—Message Signaled Interrupt Message Address

B/D/F/Type: 0/3/0/PCI  
Address Offset: 90–93h  
Default Value: 00000000h  
Access: RW, RO  
Size: 32 bits

Bit	Access	Default Value	Description
31:2	RW	00000000h	<b>Address (ADDR):</b> Lower 32 bits of the system specified message address, always DW aligned.
1:0	RO	00b	Reserved

### 7.1.22 MUA—Message Signaled Interrupt Upper Address (Optional)

B/D/F/Type: 0/3/0/PCI  
Address Offset: 94–97h  
Default Value: 00000000h  
Access: RW  
Size: 32 bits

Bit	Access	Default Value	Description
31:0	RW	00000000h	<b>Upper Address (UADDR):</b> Upper 32 bits of the system specified message address. This register is optional and only implemented if MC.C64=1.

### 7.1.23 MD—Message Signaled Interrupt Message Data

B/D/F/Type: 0/3/0/PCI  
Address Offset: 98–99h  
Default Value: 0000h  
Access: RW  
Size: 16 bits

Bit	Access	Default Value	Description
15:0	RW	0000h	<b>Data (Data):</b> This 16-bit field is programmed by system software if MSI is enabled. Its content is driven onto the FSB during the data phase of the MSI memory write transaction.



### 7.1.24 HIDM—HECI Interrupt Delivery Mode

B/D/F/Type: 0/3/0/PCI  
 Address Offset: A0h  
 Default Value: 00h  
 Access: RW  
 Size: 8 bits  
 BIOS Optimal Default 00h

This register is used to select interrupt delivery mechanism for HECI to Host processor interrupts.

Bit	Access	Default Value	Description
7:2	RO	0h	Reserved
1:0	RW	00b	<b>HECI Interrupt Delivery Mode (HIDM):</b> These bits control what type of interrupt the HECI will send when ME FW writes to set the M_IG bit in AUX space. They are interpreted as follows: 00 = Generate Legacy or MSI interrupt 01 = Generate SCI 10 = Generate SMI



## 7.2 KT IO/ Memory Mapped Device Specific Registers [D3:F3]

Table 14. KT IO/Memory Mapped Register Address Map

Address Offset	Register Symbol	Register Name	Default Value	Access
0h	KTRxBR	KT Receive Buffer	00h	RO/V
0h	KTTHR	KT Transmit Holding	00h	WO
0h	KTDLLR	KT Divisor Latch LSB	00h	RW/V
1h	KTIER	KT Interrupt Enable	00h	RW/V, RO/V
1h	KTDLMR	KT Divisor Latch MSB	00h	RW/V
2h	KTIIR	KT Interrupt Identification	01h	RO
2h	KTFCR	KT FIFO Control	00h	WO
3h	KTLCR	KT Line Control	03h	RW
4h	KTMCR	KT Modem Control	00h	RO, RW
5h	KTLR	KT Line Status	00h	RO, RO/CR
6h	KTMSR	KT Modem Status	00h	RO, RO/CR
7h	KTSCR	KT Scratch	00h	RW

### 7.2.1 KTRxBR—KT Receive Buffer

B/D/F/Type: 0/3/3/KT MM/IO  
 Address Offset: 0h  
 Default Value: 00h  
 Access: RO/V  
 Size: 8 bits

This implements the KT Receiver Data register. Host access to this address, depends on the state of the DLAB bit {KTLCR[7]}. It must be 0 to access the KTRxBR.

**RxBR:**

Host reads this register when FW provides it the receive data in non-FIFO mode. In FIFO mode, host reads to this register translate into a read from ME memory (RBR FIFO).

**Note:** Reset: Host System Reset or D3->D0 transition.

Bit	Access	Default Value	Description
7:0	RO/V	00h	<b>Receiver Buffer Register (RBR):</b> Implements the Data register of the Serial Interface. If the Host does a read, it reads from the Receive Data Buffer.



## 7.2.2 KTTTHR—KT Transmit Holding

B/D/F/Type: 0/3/3/KT MM/IO  
 Address Offset: 0h  
 Default Value: 00h  
 Access: WO  
 Size: 8 bits

This implements the KT Transmit Data register. Host access to this address, depends on the state of the DLAB bit {KTLCR[7]}. It must be 0 to access the KTTTHR.

### THR:

When host wants to transmit data in the non-FIFO mode, it writes to this register. In FIFO mode, writes by host to this address cause the data byte to be written by hardware to ME memory (THR FIFO).

**Note:** Reset: Host System Reset or D3->D0 transition.

Bit	Access	Default Value	Description
7:0	WO	00h	<b>Transmit Holding Register (THR):</b> Implements the Transmit Data register of the Serial Interface. If Host does a write, it writes to the Transmit Holding Register.

## 7.2.3 KTDLLR—KT Divisor Latch LSB

B/D/F/Type: 0/3/3/KT MM/IO  
 Address Offset: 0h  
 Default Value: 00h  
 Access: RW/V  
 Size: 8 bits

This register implements the KT DLL register. Host can Read/Write to this register only when the DLAB bit (KTLCR[7]) is 1. When this bit is 0, Host accesses the KTTTHR or the KTRBR depending on Read or Write.

This is the standard Serial Port Divisor Latch register. This register is only for software compatibility and does not affect performance of the hardware.

**Note:** Reset: Host System Reset or D3->D0 transition.

Bit	Access	Default Value	Description
7:0	RW/V	00h	<b>Divisor Latch LSB (DLL):</b> Implements the DLL register of the Serial Interface.



## 7.2.4 KTIER—KT Interrupt Enable

B/D/F/Type: 0/3/3/KT MM/IO  
 Address Offset: 1h  
 Default Value: 00h  
 Access: RW/V, RO/V  
 Size: 8 bits

This implements the KT Interrupt Enable register. Host access to this address, depends on the state of the DLAB bit {KTLCR[7]}. It must be "0" to access this register. The bits enable specific events to interrupt the Host. See bit specific definition.

**Note:** Reset: Host System Reset or D3 -> D0 transition.

Bit	Access	Default Value	Description
7:4	RO/V	0h	Reserved
3	RW/V	0b	<b>MSR (IER2):</b> When set, this bit enables bits in Modem Status register to cause an interrupt to host
2	RW/V	0b	<b>LSR (IER1):</b> When set, this bit enables bits in Receiver Line Status Register to cause an Interrupt to Host
1	RW/V	0b	<b>THR (IER1):</b> When set, this bit enables interrupt to be sent to Host when the transmit Holding register is empty
0	RW/V	0b	<b>DR (IER0):</b> When set, Received Data Ready (or Receive FIFO Timeout) interrupts are enabled to be sent to Host.

## 7.2.5 KTDLMR—KT Divisor Latch MSB

B/D/F/Type: 0/3/3/KT MM/IO  
 Address Offset: 1h  
 Default Value: 00h  
 Access: RW/V  
 Size: 8 bits

Host can Read/Write to this register only when the DLAB bit (KTLCR[7]) is 1. When this bit is 0, Host accesses the KTIER.

This is the standard Serial interface's Divisor Latch register's MSB. This register is only for software compatibility and does not affect performance of the hardware.

**Note:** Reset: Host System Reset or D3->D0 transition.

Bit	Access	Default Value	Description
7:0	RW/V	00h	<b>Divisor Latch MSB (DLM):</b> Implements the Divisor Latch MSB register of the Serial Interface.



## 7.2.6 KTIIR—KT Interrupt Identification

B/D/F/Type: 0/3/3/KT MM/IO  
 Address Offset: 2h  
 Default Value: 01h  
 Access: RO  
 Size: 8 bits

The KT IIR register prioritizes the interrupts from the function into 4 levels and records them in the IIR\_STAT field of the register. When Host accesses the IIR, hardware freezes all interrupts and provides the priority to the Host. Hardware continues to monitor the interrupts but does not change its current indication until the Host read is over. Table in the Host Interrupt Generation section shows the contents.

**Note:** Reset: See specific Bit descriptions

Bit	Access	Default Value	Description
7	RO	0b	<b>FIFO Enable (FIEN1):</b> This bit is connected by hardware to bit 0 in the FCR register. Reset: Host System Reset or D3->D0 transition
6	RO	0b	<b>FIFO Enable (FIEN0):</b> This bit is connected by hardware to bit 0 in the FCR register. Reset: Host System Reset or D3->D0 transition
5:4	RO	00b	Reserved
3:1	RO	000b	<b>IIR STATUS (IIRSTS):</b> These bits are asserted by the hardware according to the source of the interrupt and the priority level. Refer to the section on Host Interrupt Generation for a table of values. Reset: ME system Reset
0	RO	1b	<b>Interrupt Status (INTSTS):</b> When "0" indicates pending interrupt to Host When "1" indicates no pending interrupt to Host. Reset: Host system Reset or D3->D0 transition



### 7.2.7 KTFPCR—KT FIFO Control

B/D/F/Type: 0/3/3/KT MM/IO  
Address Offset: 2h  
Default Value: 00h  
Access: WO  
Size: 8 bits

When Host writes to this address, it writes to the KTFPCR. The FIFO control Register of the serial interface is used to enable the FIFO's, set the receiver FIFO trigger level and clear FIFO's under the direction of the Host.

When Host reads from this address, it reads the KTIIR.

**Note:** Reset: Host System Reset or D3->D0 transition.

Bit	Access	Default Value	Description
7:6	WO	00b	<b>Receiver Trigger Level (RTL):</b> Trigger level in bytes for the RCV FIFO. Once the trigger level number of bytes is reached, an interrupt is sent to the Host. 00 = 01 01 = 04 10 = 08 11 = 14
5:4	WO	00b	Reserved
3	WO	0b	<b>RDY Mode (RDYM):</b> This bit has no affect on hardware performance.
2	WO	0b	<b>XMT FIFO Clear (XFIC):</b> When the Host writes one to this bit, the hardware will clear the XMT FIFO. This bit is self-cleared by hardware.
1	WO	0b	<b>RCV FIFO Clear (RFIC):</b> When the Host writes one to this bit the hardware will clear the RCV FIFO. This bit is self-cleared by hardware.
0	WO	0b	<b>FIFO Enable (FIE):</b> When set, this bit indicates that the KT interface is working in FIFO mode. When this bit value is changed, the RCV and XMT FIFO are cleared by hardware.





## 7.2.8 KTLCR—KT Line Control

B/D/F/Type: 0/3/3/KT MM/IO  
 Address Offset: 3h  
 Default Value: 03h  
 Access: RW  
 Size: 8 bits

The line control register specifies the format of the asynchronous data communications exchange and sets the DLAB bit. Most bits in this register have no affect on hardware and are only used by the FW.

**Note:** Reset: Host System Reset or D3->D0 transition.

Bit	Access	Default Value	Description
7	RW	0b	<b>Divisor Latch Address Bit (DLAB):</b> This bit is set when the Host wants to read/write the Divisor Latch LSB and MSB Registers. This bit is cleared when the Host wants to access the Receive Buffer Register or the Transmit Holding Register or the Interrupt Enable Register.
6	RW	0b	<b>Break Control (BC):</b> This bit has no affect on hardware.
5:4	RW	00b	<b>Parity Bit Mode (PBM):</b> This bit has no affect on hardware.
3	RW	0b	<b>Parity Enable (PE):</b> This bit has no affect on hardware.
2	RW	0b	<b>Stop Bit Select (SBS):</b> This bit has no affect on hardware.
1:0	RW	11b	<b>Word Select Byte (WSB):</b> This bit has no affect on hardware.



### 7.2.9 KTMCR—KT Modem Control

B/D/F/Type: 0/3/3/KT MM/IO  
Address Offset: 4h  
Default Value: 00h  
Access: RO, RW  
Size: 8 bits

The Modem Control Register controls the interface with the modem. Since the FW emulates the modem, the Host communicates to the FW via this register. Register has impact on hardware when the Loopback mode is on.

**Note:** Reset: Host system Reset or D3->D0 transition.

Bit	Access	Default Value	Description
7:5	RO	000b	Reserved
4	RW	0b	<b>Loop Back Mode (LBM):</b> When set by Host, this bit indicates that the serial port is in loop Back mode. This means that the data that is transmitted by the host should be received. Helps in debug of the interface.
3	RW	0b	<b>Output 2 (OUT2):</b> This bit has no affect on hardware in normal mode. In loop back mode the value of this bit is written by hardware to Modem Status Register bit 7.
2	RW	0b	<b>Output 1 (OUT1):</b> This bit has no affect on hardware in normal mode. In loop back mode the value of this bit is written by hardware to Modem Status Register bit 6.
1	RW	0b	<b>Request to Send Out (RTSO):</b> This bit has no affect on hardware in normal mode. In loopback mode, the value of this bit is written by hardware to Modem Status Register bit 4.
0	RW	0b	<b>Data Terminal Ready Out (DRT0):</b> This bit has no affect on hardware in normal mode. In loopback mode, the value in this bit is written by hardware to Modem Status Register Bit 5.



## 7.2.10 KTLR—KT Line Status

B/D/F/Type: 0/3/3/KT MM/IO  
 Address Offset: 5h  
 Default Value: 00h  
 Access: RO, RO/CR  
 Size: 8 bits

This register provides status information of the data transfer to the Host. Error indication, etc., are provided by the hardware(HW)/firmware(FW) to the host via this register.

**Note:** Reset: Host system reset or D3->D0 transition.

Bit	Access	Default Value	Description
7	RO	0b	<b>RX FIFO Error (RXFER):</b> This bit is cleared in non FIFO mode. Bit is connected to the BI bit in FIFO mode.
6	RO	0b	<b>Transmit Shift Register Empty (TEMT):</b> This bit is connected by hardware to bit 5 (THRE) of this register
5	RO	0b	<b>Transmit Holding Register Empty (THRE):</b> The bit is always set when the mode (FIFO/Non-FIFO) is changed by the Host. This bit is active only when the THR operation is enabled by the FW. This bit has acts differently in the different modes: <ul style="list-style-type: none"> <li>• <b>Non FIFO Mode:</b> This bit is cleared by hardware when the Host writes to the THR registers and set by hardware when the FW reads the THR register.</li> <li>• <b>FIFO Mode:</b> This bit is set by hardware when the THR FIFO is empty, and cleared by hardware when the THR FIFO is not empty.</li> </ul> This bit is reset on Host system reset or D3->D0 transition.
4	RO/CR	0b	<b>Break Interrupt (BI):</b> This bit is cleared by hardware when the LSR register is being read by the Host. This bit is set by hardware in two cases: <ul style="list-style-type: none"> <li>• <b>FIFO Mode:</b> The FW sets the BI bit by setting the SBI bit in the KTRIVR register (See KT AUX registers)</li> <li>• <b>Non FIFO Mode:</b> the FW sets the BI bit by setting the BIA bit in the KTRxBR register (see KT AUX registers)</li> </ul>
3:2	RO	00b	Reserved
1	RO/CR	0b	<b>Overrun Error (OE):</b> This bit is cleared by hardware when the LSR register is being read by the Host. The FW typically sets this bit, but it is cleared by hardware when the host reads the LSR.
0	RO	0b	<b>Data Ready (DR):</b> <ul style="list-style-type: none"> <li>• <b>Non-FIFO Mode:</b> This bit is set when the FW writes to the RBR register and cleared by hardware when the RBR register is being Read by the Host.</li> <li>• <b>FIFO Mode:</b> This bit is set by hardware when the RBR FIFO is not empty and cleared by hardware when the RBR FIFO is empty.</li> </ul> This bit is reset on Host System Reset or D3->D0 transition



### 7.2.11 KTMSR—KT Modem Status

B/D/F/Type: 0/3/3/KT MM/IO  
Address Offset: 6h  
Default Value: 00h  
Access: RO, RO/CR  
Size: 8 bits

The functionality of the Modem is emulated by the FW. This register provides the status of the current state of the control lines from the modem.

**Note:** Reset: Host system Reset or D3->D0 transition.

Bit	Access	Default Value	Description
7	RO	0b	<b>Data Carrier Detect (DCD):</b> In Loop Back mode this bit is connected by hardware to the value of MCR bit 3
6	RO	0b	<b>Ring Indicator (RI):</b> In Loop Back mode this bit is connected by hardware to the value of MCR bit 2.
5	RO	0b	<b>Data Set Ready (DSR):</b> In Loop Back mode this bit is connected by hardware to the value of MCR bit 0.
4	RO	0b	<b>Clear To Send (CTS):</b> In Loop Back mode this bit is connected by hardware to the value of MCR bit 1.
3	RO/CR	0b	<b>Delta Data Carrier Detect (DDCD):</b> This bit is set when bit 7 is changed. This bit is cleared by hardware when the MSR register is being read by the HOST driver.
2	RO/CR	0b	<b>Trailing Edge of Read Detector (TERI):</b> This bit is set when bit 6 is changed from 1 to 0. This bit is cleared by hardware when the MSR register is being read by the Host driver.
1	RO/CR	0b	<b>Delta Data Set Ready (DDSR):</b> This bit is set when bit 5 is changed. This bit is cleared by hardware when the MSR register is being read by the Host driver.
0	RO/CR	0b	<b>Delta Clear To Send (DCTS):</b> This bit is set when bit 4 is changed. This bit is cleared by hardware when the MSR register is being read by the Host driver.

### 7.2.12 KTSCR—KT Scratch

B/D/F/Type: 0/3/3/KT MM/IO  
Address Offset: 7h  
Default Value: 00h  
Access: RW  
Size: 8 bits

This register has no affect on hardware. This is for the programmer to hold data temporarily.

**Note:** Reset: Host system reset or D3->D0 transition

Bit	Access	Default Value	Description
7:0	RW	00h	<b>Scratch Register Data (SCRD):</b>





## 8 Host-Secondary PCI Express\* Bridge Registers (D6:F0) (Intel® 3210 MCH only)

**Note:** The Device 6 register descriptions provided in this chapter applies only to the 3210 MCH in dual x8 mode.

Device 6 contains the controls associated with the PCI Express root port that is the intended attach point for external devices. In addition, it also functions as the virtual PCI-to-PCI bridge. The table below provides an address map of the D1:F0 registers listed by address offset in ascending order. This chapter provides a detailed bit description of the registers.

**Warning:** When reading the PCI Express "conceptual" registers such as this, you may not get a valid value unless the register value is stable.

The *PCI Express\* Specification* defines two types of reserved bits:

Reserved and Preserved:

- Reserved for future RW implementations; software must preserve value read for writes to bits.
- Reserved and Zero: Reserved for future R/WC/S implementations; software must use 0 for writes to bits.

Unless explicitly documented as Reserved and Zero, all bits marked as reserved are part of the Reserved and Preserved type, which have historically been the typical definition for Reserved.

**Note:** Most (if not all) control bits in this device cannot be modified unless the link is down. Software is required to first disable the link, then program the registers, and then re-enable the link (which will cause a full-retrain with the new settings).

**Table 15. Host-Secondary PCI Express\* Bridge Register Address Map (D6:F0) (Sheet 1 of 3)**

Address Offset	Register Symbol	Register Name	Default Value	Access
0–1h	VID1	Vendor Identification	8086h	RO
2–3h	DID1	Device Identification	29F9h	RO
4–5h	PCICMD1	PCI Command	0000h	RO, RW
6–7h	PCISTS1	PCI Status	0010h	RO, RWC
8h	RID1	Revision Identification	See register description	RO
9–Bh	CC1	Class Code	060400h	RO
Ch	CL1	Cache Line Size	00h	RW
Eh	HDR1	Header Type	01h	RO
18h	PBUSN1	Primary Bus Number	00h	RO
19h	SBUSN1	Secondary Bus Number	00h	RW



**Table 15. Host-Secondary PCI Express\* Bridge Register Address Map (D6:F0) (Sheet 2 of 3)**

Address Offset	Register Symbol	Register Name	Default Value	Access
1Ah	SUBUSN1	Subordinate Bus Number	00h	RW
1Ch	IOBASE1	I/O Base Address	F0h	RO, RW
1Dh	IOLIMIT1	I/O Limit Address	00h	RW, RO
1E–1Fh	SSTS1	Secondary Status	0000h	RO, RWC
20–21h	MBASE1	Memory Base Address	FFF0h	RW, RO
22–23h	MLIMIT1	Memory Limit Address	0000h	RW, RO
24–25h	PMBASE1	Prefetchable Memory Base Address	FFF1h	RW, RO
26–27h	PMLIMIT1	Prefetchable Memory Limit Address	0001h	RO, RW
28–2Bh	PMBASEU1	Prefetchable Memory Base Address Upper	00000000h	RW
2C–2Fh	PMLIMITU1	Prefetchable Memory Limit Address Upper	00000000h	RW
34h	CAPPTR1	Capabilities Pointer	88h	RO
3Ch	INTRLINE1	Interrupt Line	00h	RW
3Dh	INTRPIN1	Interrupt Pin	01h	RO
3E–3Fh	BCTRL1	Bridge Control	0000h	RO, RW
80–83h	PM_CAPID1	Power Management Capabilities	C8039001h	RO
84–87h	PM_CS1	Power Management Control/Status	00000008h	RO, RW, RW/P
88–8Bh	SS_CAPID	Subsystem ID and Vendor ID Capabilities	0000800Dh	RO
8C–8Fh	SS	Subsystem ID and Subsystem Vendor ID	00008086h	RWO
90–91h	MSI_CAPID	Message Signaled Interrupts Capability ID	A005h	RO
92–93h	MC	Message Control	0000h	RW, RO
94–97h	MA	Message Address	00000000h	RO, RW
98–99h	MD	Message Data	0000h	RW
A0–A1h	PE_CAPL	PCI Express Capability List	0010h	RO
A2–A3h	PE_CAP	PCI Express Capabilities	0142h	RO, RWO
A4–A7h	DCAP	Device Capabilities	00008000h	RO
A8–A9h	DCTL	Device Control	0000h	RW, RO
AA–ABh	DSTS	Device Status	0000h	RO, RWC
AC–AFh	LCAP	Link Capabilities	03214D01h	RO, RWO
B0–B1h	LCTL	Link Control	0000h	RO, RW, RW/SC
B2–hB3	LSTS	Link Status	1000h	RWC, RO
B4–B7h	SLOTCAP	Slot Capabilities	00040000h	RWO, RO
B8–B9h	SLOTCTL	Slot Control	0000h	RO, RW
BA–BBh	SLOTSTS	Slot Status	0000h	RO, RWC
BC–BDh	RCTL	Root Control	0000h	RO, RW
C0–C3h	RSTS	Root Status	00000000h	RO, RWC



**Table 15. Host-Secondary PCI Express\* Bridge Register Address Map (D6:F0) (Sheet 3 of 3)**

Address Offset	Register Symbol	Register Name	Default Value	Access
EC–EFh	PELC	PCI Express Legacy Control	00000000h	RO, RW
100–103h	VCECH	Virtual Channel Enhanced Capability Header	14010002h	RO
104–107h	PVCCAP1	Port VC Capability Register 1	00000000h	RO
108–10Bh	PVCCAP2	Port VC Capability Register 2	00000000h	RO
10C–10Dh	PVCCTL	Port VC Control	0000h	RO, RW
110–113h	VCORCAP	VCO Resource Capability	00000000h	RO
114–117h	VCORCTL	VCO Resource Control	800000FFh	RO, RW
11A–11Bh	VCORSTS	VCO Resource Status	0002h	RO
140–143h	RCLDECH	Root Complex Link Declaration Enhanced	00010005h	RO
144–147h	ESD	Element Self Description	03000100h	RO, RWO
150–153h	LE1D	Link Entry 1 Description	00000000h	RO, RWO
158–15Fh	LE1A	Link Entry 1 Address	0000000000 000000h	RO, RWO

## 8.1 VID1—Vendor Identification

B/D/F/Type: 0/6/0/PCI  
 Address Offset: 0–1h  
 Default Value: 8086h  
 Access: RO  
 Size: 16 bits

This register combined with the Device Identification register uniquely identify any PCI device.

Bit	Access	Default Value	Description
15:0	RO	8086h	<b>Vendor Identification (VID1):</b> PCI standard identification for Intel.



## 8.2 DID1—Device Identification

B/D/F/Type: 0/6/0/PCI  
Address Offset: 2–3h  
Default Value: 29F9h  
Access: RO  
Size: 16 bits

This register combined with the Vendor Identification register uniquely identifies any PCI device.

Bit	Access	Default Value	Description
15:8	RO	29h	<b>Device Identification Number (DID1(UB)):</b> Identifier assigned to the MCH device #6 (virtual PCI-to-PCI bridge, PCI Express port).
7:4	RO	Fh	<b>Device Identification Number (DID1(HW)):</b> Identifier assigned to the MCH device #6 (virtual PCI-to-PCI bridge, PCI Express port).
3:0	RO	9h	<b>Device Identification Number (DID1(LB)):</b> Identifier assigned to the MCH device #6 (virtual PCI-to-PCI bridge, PCI Express port).

## 8.3 PCICMD1—PCI Command

B/D/F/Type: 0/6/0/PCI  
Address Offset: 4–5h  
Default Value: 0000h  
Access: RO, RW  
Size: 16 bits

Bit	Access	Default Value	Description
15:11	RO	00h	Reserved
10	RW	0b	<b>INTA Assertion Disable (INTAAD):</b> 0 = This device is permitted to generate INTA interrupt messages. 1 = This device is prevented from generating interrupt messages. Any INTA emulation interrupts already asserted must be de-asserted when this bit is set.  This bit only affects interrupts generated by the device (PCI INTA from a PME event) controlled by this command register. It does not affect upstream MSIs, upstream PCI INTA-INTD assert and deassert messages.
9	RO	0b	<b>Fast Back-to-Back Enable (FB2B):</b> Not Applicable or Implemented. Hardwired to 0.



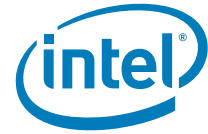

Bit	Access	Default Value	Description
8	RW	0b	<p><b>SERR# Message Enable (SERRE1):</b> This bit controls Device 6 SERR# messaging. The MCH communicates the SERR# condition by sending a SERR message to the ICH. This bit, when set, enables reporting of non-fatal and fatal errors detected by the device to the Root Complex. Note that errors are reported if enabled either through this bit or through the PCI-Express specific bits in the Device Control Register.</p> <p>0 = The SERR message is generated by the MCH for Device 6 only under conditions enabled individually through the Device Control Register.</p> <p>1 = The MCH is enabled to generate SERR messages which will be sent to the ICH for specific Device 6 error conditions generated/detected on the primary side of the virtual PCI to PCI bridge (not those received by the secondary side). The status of SERRs generated is reported in the PCISTS1 register.</p>
7	RO	0b	Reserved
6	RW	0b	<p><b>Parity Error Response Enable (PERRE):</b> Controls whether or not the Master Data Parity Error bit in the PCI Status register can be set.</p> <p>0 = Master Data Parity Error bit in PCI Status register can NOT be set.</p> <p>1 = Master Data Parity Error bit in PCI Status register CAN be set.</p>
5:3	RO	0b	Reserved
2	RW	0b	<p><b>Bus Master Enable (BME):</b> Controls the ability of the PCI Express port to forward Memory and I/O Read/Write Requests in the upstream direction.</p> <p>0 = This device is prevented from making memory or IO requests to its primary bus. Note that according to PCI Specification, as MSI interrupt messages are in-band memory writes, disabling the bus master enable bit prevents this device from generating MSI interrupt messages or passing them from its secondary bus to its primary bus. Upstream memory writes/reads, IO writes/reads, peer writes/reads, and MSIs will all be treated as illegal cycles. Writes are forwarded to memory address C0000h with byte enables de-asserted. Reads will be forwarded to memory address C0000h and will return Unsupported Request status (or Master abort) in its completion packet.</p> <p>1 = This device is allowed to issue requests to its primary bus. Completions for previously issued memory read requests on the primary bus will be issued when the data is available.</p> <p>This bit does not affect forwarding of Completions from the primary interface to the secondary interface.</p>
1	RW	0b	<p><b>Memory Access Enable (MAE):</b></p> <p>0 = All of device #6's memory space is disabled.</p> <p>1 = Enable the Memory and Pre-fetchable memory address ranges defined in the MBASE1, MLIMIT1, PMBASE1, and PMLIMIT1 registers.</p>
0	RW	0b	<p><b>IO Access Enable (IOAE):</b></p> <p>0 = All of device #6's I/O space is disabled.</p> <p>1 = Enable the I/O address range defined in the IOBASE1, and IOLIMIT1 registers.</p>



## 8.4 PCISTS1—PCI Status

B/D/F/Type: 0/6/0/PCI  
 Address Offset: 6–7h  
 Default Value: 0010h  
 Access: RO, RWC  
 Size: 16 bits

This register reports the occurrence of error conditions associated with primary side of the "virtual" Host-PCI Express bridge embedded within the MCH.

Bit	Access	Default Value	Description
15	RO	0b	<b>Detected Parity Error (DPE):</b> Not Applicable or Implemented. Hardwired to 0. Parity (generating poisoned Transaction Layer Packets) is not supported on the primary side of this device.
14	RWC	0b	<b>Signaled System Error (SSE):</b> This bit is set when this Device sends a SERR due to detecting an ERR_FATAL or ERR_NONFATAL condition and the SERR Enable bit in the Command register is 1. Both received (if enabled by BCTRL1[1]) and internally detected error messages do not affect this field).
13	RO	0b	<b>Received Master Abort Status (RMAS):</b> Not Applicable or Implemented. Hardwired to 0. The concept of a master abort does not exist on primary side of this device.
12	RO	0b	<b>Received Target Abort Status (RTAS):</b> Not Applicable or Implemented. Hardwired to 0. The concept of a target abort does not exist on primary side of this device.
11	RO	0b	<b>Signaled Target Abort Status (STAS):</b> Not Applicable or Implemented. Hardwired to 0. The concept of a target abort does not exist on primary side of this device.
10:9	RO	00b	<b>DEVSELB Timing (DEVT):</b> This device is not the subtractively decoded device on bus 0. This bit field is therefore hardwired to 00 to indicate that the device uses the fastest possible decode.
8	RO	0b	<b>Master Data Parity Error (PMDPE):</b> Because the primary side of the PCI Express's virtual peer-to-peer bridge is integrated with the MCH functionality, there is no scenario where this bit will get set. Because hardware will never set this bit, it is impossible for software to have an opportunity to clear this bit or otherwise test that it is implemented. The PCI specification defines it as a R/WC, but for our implementation an RO definition behaves the same way and will meet all Microsoft testing requirements. This bit can only be set when the Parity Error Enable bit in the PCI Command register is set.
7	RO	0b	<b>Fast Back-to-Back (FB2B):</b> Not Applicable or Implemented. Hardwired to 0.
6	RO	0b	Reserved
5	RO	0b	<b>66/60MHz capability (CAP66):</b> Not Applicable or Implemented. Hardwired to 0.
4	RO	1b	<b>Capabilities List (CAPL):</b> Indicates that a capabilities list is present. Hardwired to 1.
3	RO	0b	<b>INTA Status (INTAS):</b> Indicates that an interrupt message is pending internally to the device. Only PME sources feed into this status bit (not PCI INTA-INTD assert and deassert messages). The INTA Assertion Disable bit, PCICMD1[10], has no effect on this bit.
2:0	RO	000b	Reserved



## 8.5 RID1—Revision Identification

B/D/F/Type: 0/6/0/PCI  
 Address Offset: 8h  
 Default Value: see table below  
 Access: RO  
 Size: 8 bits

This register contains the revision number of the MCH device 6. These bits are read only and writes to this register have no effect.

Bit	Access	Default Value	Description
7:0	RO	see description	<b>Revision Identification Number (RID1):</b> This is an 8-bit value that indicates the revision identification number for the MCH Device 0. Refer to the <i>Intel® 3200 and 3210 Chipset Specification Update</i> for the value of this register.

## 8.6 CC1—Class Code

B/D/F/Type: 0/6/0/PCI  
 Address Offset: 9–Bh  
 Default Value: 060400h  
 Access: RO  
 Size: 24 bits

This register identifies the basic function of the device, a more specific sub-class, and a register-specific programming interface.

Bit	Access	Default Value	Description
23:16	RO	06h	<b>Base Class Code (BCC):</b> Indicates the base class code for this device. This code has the value 06h, indicating a Bridge device.
15:8	RO	04h	<b>Sub-Class Code (SUBCC):</b> Indicates the sub-class code for this device. The code is 04h indicating a PCI to PCI Bridge.
7:0	RO	00h	<b>Programming Interface (PI):</b> Indicates the programming interface of this device. This value does not specify a particular register set layout and provides no practical use for this device.



## 8.7 CL1—Cache Line Size

B/D/F/Type: 0/6/0/PCI  
Address Offset: Ch  
Default Value: 00h  
Access: RW  
Size: 8 bits

Bit	Access	Default Value	Description
7:0	RW	00h	<b>Cache Line Size (Scratch pad):</b> Implemented by PCI Express devices as a read-write field for legacy compatibility purposes but has no impact on any PCI Express device functionality.

## 8.8 HDR1—Header Type

B/D/F/Type: 0/6/0/PCI  
Address Offset: Eh  
Default Value: 01h  
Access: RO  
Size: 8 bits

This register identifies the header layout of the configuration space. No physical register exists at this location.

Bit	Access	Default Value	Description
7:0	RO	01h	<b>Header Type Register (HDR):</b> Returns 01h to indicate that this is a single function device with bridge header layout.

## 8.9 PBUSN1—Primary Bus Number

B/D/F/Type: 0/6/0/PCI  
Address Offset: 18h  
Default Value: 00h  
Access: RO  
Size: 8 bits

This register identifies that this "virtual" Host-PCI Express bridge is connected to PCI bus #0.

Bit	Access	Default Value	Description
7:0	RO	00h	<b>Primary Bus Number (BUSN):</b> Configuration software typically programs this field with the number of the bus on the primary side of the bridge. Since device #6 is an internal device and its primary bus is always 0, these bits are read only and are hardwired to 0.



## 8.10 SBUSN1—Secondary Bus Number

B/D/F/Type: 0/6/0/PCI  
 Address Offset: 19h  
 Default Value: 00h  
 Access: RW  
 Size: 8 bits

This register identifies the bus number assigned to the second bus side of the "virtual" bridge. This number is programmed by the PCI configuration software to allow mapping of configuration cycles to PCI Express.

Bit	Access	Default Value	Description
7:0	RW	00h	<b>Secondary Bus Number (BUSN):</b> This field is programmed by configuration software with the bus number assigned to PCI Express.

## 8.11 SUBUSN1—Subordinate Bus Number

B/D/F/Type: 0/6/0/PCI  
 Address Offset: 1Ah  
 Default Value: 00h  
 Access: RW  
 Size: 8 bits

This register identifies the subordinate bus (if any) that resides at the level below PCI Express. This number is programmed by the PCI configuration software to allow mapping of configuration cycles to PCI Express.

Bit	Access	Default Value	Description
7:0	RW	00h	<b>Subordinate Bus Number (BUSN):</b> This register is programmed by configuration software with the number of the highest subordinate bus that lies behind the device #6 bridge. When only a single PCI device resides on the PCI Express segment, this register will contain the same value as the SBUSN1 register.



## 8.12 IOBASE1—I/O Base Address

B/D/F/Type: 0/6/0/PCI  
Address Offset: 1Ch  
Default Value: F0h  
Access: RO, RW  
Size: 8 bits

This register controls the processor to PCI Express I/O access routing based on the following formula:

$$IO\_BASE \leq \text{address} \leq IO\_LIMIT$$

Only upper 4 bits are programmable. For the purpose of address decode address bits A[11:0] are treated as 0. Thus the bottom of the defined I/O address range will be aligned to a 4 KB boundary.

Bit	Access	Default Value	Description
7:4	RW	Fh	<b>I/O Address Base (IOBASE):</b> This field corresponds to A[15:12] of the I/O addresses passed by bridge 1 to PCI Express.
3:0	RO	0h	Reserved

## 8.13 IOLIMIT1—I/O Limit Address

B/D/F/Type: 0/6/0/PCI  
Address Offset: 1Dh  
Default Value: 00h  
Access: RW, RO  
Size: 8 bits

This register controls the processor to PCI Express I/O access routing based on the following formula:

$$IO\_BASE \leq \text{address} \leq IO\_LIMIT$$

Only upper 4 bits are programmable. For the purpose of address decode address bits A[11:0] are assumed to be FFFh. Thus, the top of the defined I/O address range will be at the top of a 4 KB aligned address block.

Bit	Access	Default Value	Description
7:4	RW	0h	<b>I/O Address Limit (IOLIMIT):</b> Corresponds to A[15:12] of the I/O address limit of device #6. Devices between this upper limit and IOBASE1 will be passed to the PCI Express hierarchy associated with this device.
3:0	RO	0h	Reserved



## 8.14 SSTS1—Secondary Status

B/D/F/Type: 0/6/0/PCI  
 Address Offset: 1E–1Fh  
 Default Value: 0000h  
 Access: RO, RWC  
 Size: 16 bits

SSTS1 is a 16-bit status register that reports the occurrence of error conditions associated with secondary side of the "virtual" PCI-PCI bridge embedded within MCH.

Bit	Access	Default Value	Description
15	RWC	0b	<b>Detected Parity Error (DPE):</b> This bit is set by the Secondary Side for a Type 1 Configuration Space header device whenever it receives a Poisoned Transaction Layer Packet, regardless of the state of the Parity Error Response Enable bit in the Bridge Control Register.
14	RWC	0b	<b>Received System Error (RSE):</b> This bit is set when the Secondary Side for a Type 1 configuration space header device receives an ERR_FATAL or ERR_NONFATAL.
13	RWC	0b	<b>Received Master Abort (RMA):</b> This bit is set when the Secondary Side for Type 1 Configuration Space Header Device (for requests initiated by the Type 1 Header Device itself) receives a Completion with Unsupported Request Completion Status.
12	RWC	0b	<b>Received Target Abort (RTA):</b> This bit is set when the Secondary Side for Type 1 Configuration Space Header Device (for requests initiated by the Type 1 Header Device itself) receives a Completion with Completer Abort Completion Status.
11	RO	0b	<b>Signaled Target Abort (STA):</b> Not Applicable or Implemented. Hardwired to 0. The MCH does not generate Target Aborts (the MCH will never complete a request using the Completer Abort Completion status).
10:9	RO	00b	<b>DEVSELB Timing (DEVT):</b> Not Applicable or Implemented. Hardwired to 0.
8	RWC	0b	<b>Master Data Parity Error (SMDPE):</b> When set, indicates that the MCH received across the link (upstream) a Read Data Completion Poisoned Transaction Layer Packet (EP=1). This bit can only be set when the Parity Error Enable bit in the Bridge Control register is set.
7	RO	0b	<b>Fast Back-to-Back (FB2B):</b> Not Applicable or Implemented. Hardwired to 0.
6	RO	0b	Reserved
5	RO	0b	<b>66/60 MHz capability (CAP66):</b> Not Applicable or Implemented. Hardwired to 0.
4:0	RO	00h	Reserved



## 8.15 MBASE1—Memory Base Address

B/D/F/Type: 0/6/0/PCI  
Address Offset: 20–21h  
Default Value: FFF0h  
Access: RW, RO  
Size: 16 bits

This register controls the processor to PCI Express non-prefetchable memory access routing based on the following formula:

$$\text{MEMORY\_BASE} \leq \text{address} \leq \text{MEMORY\_LIMIT}$$

The upper 12 bits of the register are read/write and correspond to the upper 12 address bits A[31:20] of the 32 bit address. The bottom 4 bits of this register are read-only and return zeroes when read. This register must be initialized by the configuration software. For the purpose of address decode address bits A[19:0] are assumed to be 0. Thus, the bottom of the defined memory address range will be aligned to a 1 MB boundary.

Bit	Access	Default Value	Description
15:4	RW	FFFh	<b>Memory Address Base (MBASE):</b> Corresponds to A[31:20] of the lower limit of the memory range that will be passed to PCI Express.
3:0	RO	0h	Reserved





## 8.16 MLIMIT1—Memory Limit Address

B/D/F/Type: 0/6/0/PCI  
 Address Offset: 22–23h  
 Default Value: 0000h  
 Access: RW, RO  
 Size: 16 bits

This register controls the processor to PCI Express non-prefetchable memory access routing based on the following formula:

$$\text{MEMORY\_BASE} \leq \text{address} \leq \text{MEMORY\_LIMIT}$$

The upper 12 bits of the register are read/write and correspond to the upper 12 address bits A[31:20] of the 32 bit address. The bottom 4 bits of this register are read-only and return zeroes when read. This register must be initialized by the configuration software. For the purpose of address decode, address bits A[19:0] are assumed to be FFFFh. Thus, the top of the defined memory address range will be at the top of a 1 MB aligned memory block.

**Note:** Memory range covered by MBASE and MLIMIT registers are used to map non-prefetchable PCI Express address ranges (typically where control/status memory-mapped I/O data structures of the controller will reside) and PMBASE and PMLIMIT are used to map prefetchable address ranges (typically device local memory). This segregation allows application of USWC space attribute to be performed in a true plug-and-play manner to the prefetchable address range for improved processor- PCI Express memory access performance.

**Note:** Configuration software is responsible for programming all address range registers (prefetchable, non-prefetchable) with the values that provide exclusive address ranges (i.e., prevent overlap with each other and/or with the ranges covered with the main memory). There is no provision in the MCH hardware to enforce prevention of overlap and operations of the system in the case of overlap are not ensured.

Bit	Access	Default Value	Description
15:4	RW	000h	<b>Memory Address Limit (MLIMIT):</b> Corresponds to A[31:20] of the upper limit of the address range passed to PCI Express.
3:0	RO	0h	Reserved



## 8.17 PMBASE1—Prefetchable Memory Base Address Upper

B/D/F/Type: 0/6/0/PCI  
Address Offset: 24–25h  
Default Value: FFF1h  
Access: RW, RO  
Size: 16 bits

This register in conjunction with the corresponding Upper Base Address register controls the processor to PCI Express prefetchable memory access routing based on the following formula:

$$\text{PREFETCHABLE\_MEMORY\_BASE} \leq \text{address} \leq \text{PREFETCHABLE\_MEMORY\_LIMIT}$$

The upper 12 bits of this register are read/write and correspond to address bits A[31:20] of the 40-bit address. The lower 8 bits of the Upper Base Address register are read/write and correspond to address bits A[39:32] of the 40-bit address. This register must be initialized by the configuration software. For the purpose of address decode, address bits A[19:0] are assumed to be 0. Thus, the bottom of the defined memory address range will be aligned to a 1 MB boundary.

Bit	Access	Default Value	Description
15:4	RW	FFFh	<b>Prefetchable Memory Base Address (MBASE):</b> Corresponds to A[31:20] of the lower limit of the memory range that will be passed to PCI Express.
3:0	RO	1h	<b>64-bit Address Support:</b> Indicates that the upper 32 bits of the prefetchable memory region base address are contained in the Prefetchable Memory base Upper Address register at 28h.



## 8.18 PMLIMIT1—Prefetchable Memory Limit Address

B/D/F/Type: 0/6/0/PCI  
 Address Offset: 26–27h  
 Default Value: 0001h  
 Access: RO, RW  
 Size: 16 bits

This register in conjunction with the corresponding Upper Limit Address register controls the processor to PCI Express prefetchable memory access routing based on the following formula:

$$\text{PREFETCHABLE\_MEMORY\_BASE} \leq \text{address} \leq \text{PREFETCHABLE\_MEMORY\_LIMIT}$$

The upper 12 bits of this register are read/write and correspond to address bits A[31:20] of the 40-bit address. The lower 8 bits of the Upper Limit Address register are read/write and correspond to address bits A[39:32] of the 40-bit address. This register must be initialized by the configuration software. For the purpose of address decode, address bits A[19:0] are assumed to be FFFFh. Thus, the top of the defined memory address range will be at the top of a 1 MB aligned memory block. Note that prefetchable memory range is supported to allow segregation by the configuration software between the memory ranges that must be defined as UC and the ones that can be designated as a USWC (i.e., prefetchable) from the processor perspective.

Bit	Access	Default Value	Description
15:4	RW	000h	<b>Prefetchable Memory Address Limit (PMLIMIT)</b> : Corresponds to A[31:20] of the upper limit of the address range passed to PCI Express.
3:0	RO	1h	<b>64-bit Address Support</b> : Indicates that the upper 32 bits of the prefetchable memory region limit address are contained in the Prefetchable Memory Base Limit Address register at 2Ch



## 8.19 PMBASEU1—Prefetchable Memory Base Address Upper

B/D/F/Type: 0/6/0/PCI  
Address Offset: 28–2Bh  
Default Value: 00000000h  
Access: RW  
Size: 32 bits

The functionality associated with this register is present in the PCI Express design implementation.

This register in conjunction with the corresponding Upper Base Address register controls the processor to PCI Express prefetchable memory access routing based on the following formula:

$$\text{PREFETCHABLE\_MEMORY\_BASE} \leq \text{address} \leq \text{PREFETCHABLE\_MEMORY\_LIMIT}$$

The upper 12 bits of this register are read/write and correspond to address bits A[31:20] of the 40-bit address. The lower 8 bits of the Upper Base Address register are read/write and correspond to address bits A[39:32] of the 40-bit address. This register must be initialized by the configuration software. For the purpose of address decode, address bits A[19:0] are assumed to be 0. Thus, the bottom of the defined memory address range will be aligned to a 1 MB boundary.

Bit	Access	Default Value	Description
31:0	RW	00000000h	<b>Prefetchable Memory Base Address (MBASEU)</b> : Corresponds to A[63:32] of the lower limit of the prefetchable memory range that will be passed to PCI Express.



## 8.20 PMLIMITU1—Prefetchable Memory Limit Address Upper

B/D/F/Type: 0/6/0/PCI  
 Address Offset: 2C–2Fh  
 Default Value: 00000000h  
 Access: RW  
 Size: 32 bits

The functionality associated with this register is present in the PCI Express design implementation.

This register in conjunction with the corresponding Upper Limit Address register controls the processor to PCI Express prefetchable memory access routing based on the following formula:

$$\text{PREFETCHABLE\_MEMORY\_BASE} \leq \text{address} \leq \text{PREFETCHABLE\_MEMORY\_LIMIT}$$

The upper 12 bits of this register are read/write and correspond to address bits A[31:20] of the 40-bit address. The lower 8 bits of the Upper Limit Address register are read/write and correspond to address bits A[39:32] of the 40-bit address. This register must be initialized by the configuration software. For the purpose of address decode, address bits A[19:0] are assumed to be FFFFh. Thus, the top of the defined memory address range will be at the top of a 1MB aligned memory block.

Note that prefetchable memory range is supported to allow segregation by the configuration software between the memory ranges that must be defined as UC and the ones that can be designated as a USWC (i.e., prefetchable) from the processor perspective.

Bit	Access	Default Value	Description
31:0	RW	00000000h	<b>Prefetchable Memory Address Limit (MLIMITU):</b> This field corresponds to A[63:32] of the upper limit of the prefetchable Memory range that will be passed to PCI Express.



## 8.21 CAPPTR1—Capabilities Pointer

B/D/F/Type: 0/6/0/PCI  
Address Offset: 34h  
Default Value: 88h  
Access: RO  
Size: 8 bits

The capabilities pointer provides the address offset to the location of the first entry in this device's linked list of capabilities.

Bit	Access	Default Value	Description
7:0	RO	88h	<b>First Capability (CAPPTR1):</b> The first capability in the list is the Subsystem ID and Subsystem Vendor ID Capability.

## 8.22 INTRLINE1—Interrupt Line

B/D/F/Type: 0/6/0/PCI  
Address Offset: 3Ch  
Default Value: 00h  
Access: RW  
Size: 8 bits

This register contains interrupt line routing information. The device itself does not use this value, rather it is used by device drivers and operating systems to determine priority and vector information.

Bit	Access	Default Value	Description
7:0	RW	00h	<b>Interrupt Connection (INTCON):</b> Used to communicate interrupt line routing information.

## 8.23 INTRPIN1—Interrupt Pin

B/D/F/Type: 0/6/0/PCI  
Address Offset: 3Dh  
Default Value: 01h  
Access: RO  
Size: 8 bits

This register specifies which interrupt pin this device uses.

Bit	Access	Default Value	Description
7:0	RO	01h	<b>Interrupt Pin (INTRPIN):</b> As a single function device, the PCI Express device specifies INTA as its interrupt pin. 01h=INTA.

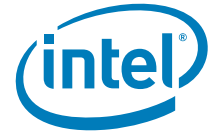

## 8.24 BCTRL1—Bridge Control

B/D/F/Type: 0/6/0/PCI  
 Address Offset: 3E–3Fh  
 Default Value: 0000h  
 Access: RO, RW  
 Size: 16 bits

This register provides extensions to the PCICMD1 register that are specific to PCI-PCI bridges. The BCTRL provides additional control for the secondary interface as well as some bits that affect the overall behavior of the "virtual" Host-PCI Express bridge embedded within MCH.

Bit	Access	Default Value	Description
15:12	RO	0h	Reserved
11	RO	0b	<b>Discard Timer SERR# Enable (DTSERRE)</b> : Not Applicable or Implemented. Hardwired to 0.
10	RO	0b	<b>Discard Timer Status (DTSTS)</b> : Not Applicable or Implemented. Hardwired to 0.
9	RO	0b	<b>Secondary Discard Timer (SDT)</b> : Not Applicable or Implemented. Hardwired to 0.
8	RO	0b	<b>Primary Discard Timer (PDT)</b> : Not Applicable or Implemented. Hardwired to 0.
7	RO	0b	<b>Fast Back-to-Back Enable (FB2BEN)</b> : Not Applicable or Implemented. Hardwired to 0.
6	RW	0b	<b>Secondary Bus Reset (SRESET)</b> : Setting this bit triggers a hot reset on the corresponding PCI Express Port. This will force the LTSSM to transition to the Hot Reset state (via Recovery) from L0, L0s, or L1 states.
5	RO	0b	<b>Master Abort Mode (MAMODE)</b> : Does not apply to PCI Express. Hardwired to 0.
4	RW	0b	<b>VGA 16-bit Decode (VGA16D)</b> : Enables the PCI-to-PCI bridge to provide 16-bit decoding of VGA I/O address precluding the decoding of alias addresses every 1 KB. This bit only has meaning if bit 3 (VGA Enable) of this register is also set to 1, enabling VGA I/O decoding and forwarding by the bridge. 0 = Execute 10-bit address decodes on VGA I/O accesses. 1 = Execute 16-bit address decodes on VGA I/O accesses.
3	RW	0b	<b>VGA Enable (VGAEN)</b> : Controls the routing of processor initiated transactions targeting VGA compatible I/O and memory address ranges. See the VGAEN/MDAP table in device 0, offset 97h[0].
2	RW	0b	<b>ISA Enable (ISAEN)</b> : Needed to exclude legacy resource decode to route ISA resources to legacy decode path. Modifies the response by the MCH to an I/O access issued by the processor that target ISA I/O addresses. This applies only to I/O addresses that are enabled by the IOBASE and IOLIMIT registers. 0 = All addresses defined by the IOBASE and IOLIMIT for processor I/O transactions will be mapped to PCI Express. 1 = MCH will not forward any I/O transactions addressing the last 768 bytes in each 1 KB block even if the addresses are within the range defined by the IOBASE and IOLIMIT registers.



Bit	Access	Default Value	Description
1	RW	0b	<b>SERR Enable (SERREN):</b> 0 = No forwarding of error messages from secondary side to primary side that could result in an SERR. 1 = ERR_COR, ERR_NONFATAL, and ERR_FATAL messages result in SERR message when individually enabled by the Root Control register.
0	RW	0b	<b>Parity Error Response Enable (PEREN):</b> Controls whether or not the Master Data Parity Error bit in the Secondary Status register is set when the MCH receives across the link (upstream) a Read Data Completion Poisoned Transaction Layer Packet. 0 = Master Data Parity Error bit in Secondary Status register can NOT be set. 1 = Master Data Parity Error bit in Secondary Status register CAN be set.

## 8.25 PM\_CAPID1—Power Management Capabilities

B/D/F/Type: 0/6/0/PCI  
 Address Offset: 80–83h  
 Default Value: C8039001h  
 Access: RO  
 Size: 32 bits

Bit	Access	Default Value	Description
31:27	RO	19h	<b>PME Support (PMES):</b> This field indicates the power states in which this device may indicate PME wake via PCI Express messaging. D0, D3hot & D3cold. This device is not required to do anything to support D3hot and D3cold, it simply must report that those states are supported. Refer to the PCI Power Management 1.1 specification for encoding explanation and other power management details.
26	RO	0b	<b>D2 Power State Support (D2PSS):</b> Hardwired to 0 to indicate that the D2 power management state is NOT supported.
25	RO	0b	<b>D1 Power State Support (D1PSS):</b> Hardwired to 0 to indicate that the D1 power management state is NOT supported.
24:22	RO	000b	<b>Auxiliary Current (AUXC):</b> Hardwired to 0 to indicate that there are no 3.3Vaux auxiliary current requirements.
21	RO	0b	<b>Device Specific Initialization (DSI):</b> Hardwired to 0 to indicate that special initialization of this device is NOT required before generic class device driver is to use it.
20	RO	0b	<b>Auxiliary Power Source (APS):</b> Hardwired to 0.
19	RO	0b	<b>PME Clock (PMECLK):</b> Hardwired to 0 to indicate this device does NOT support PMEB generation.
18:16	RO	011b	<b>PCI PM CAP Version (PCIPMCV):</b> A value of 011b indicates that this function complies with revision 1.2 of the PCI Power Management Interface Specification.
15:8	RO	90h	<b>Pointer to Next Capability (PNC):</b> This contains a pointer to the next item in the capabilities list. If MSICH (CAPL[0] @ 7Fh) is 0, then the next item in the capabilities list is the Message Signaled Interrupts (MSI) capability at 90h.
7:0	RO	01h	<b>Capability ID (CID):</b> Value of 01h identifies this linked list item (capability structure) as being for PCI Power Management registers.



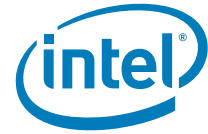

## 8.26 PM\_CS1—Power Management Control/Status

B/D/F/Type: 0/6/0/PCI  
 Address Offset: 84–87h  
 Default Value: 00000008h  
 Access: RO, RW, RW/P  
 Size: 32 bits

Bit	Access	Default Value	Description
31:16	RO	0000h	Reserved
15	RO	0b	<b>PME Status (PMESTS)</b> : Indicates that this device does not support PMEB generation from D3cold.
14:13	RO	00b	<b>Data Scale (DSCALE)</b> : Indicates that this device does not support the power management data register.
12:9	RO	0h	<b>Data Select (DSEL)</b> : Indicates that this device does not support the power management data register.
8	RW/P	0b	<b>PME Enable (PMEE)</b> : Indicates that this device does not generate PMEB assertion from any D-state. 0 = PMEB generation not possible from any D State 1 = PMEB generation enabled from any D State The setting of this bit has no effect on hardware. See PM_CAP[15:11]
7:2	RO	0000b	Reserved
1:0	RW	00b	<b>Power State (PS)</b> : Indicates the current power state of this device and can be used to set the device into a new power state. If software attempts to write an unsupported state to this field, write operation must complete normally on the bus, but the data is discarded and no state change occurs. 00 = D0 01 = D1 (Not supported in this device.) 10 = D2 (Not supported in this device.) 11 = D3 Support of D3cold does not require any special action. While in the D3hot state, this device can only act as the target of PCI configuration transactions (for power management control). This device also cannot generate interrupts or respond to MMR cycles in the D3 state. The device must return to the D0 state in order to be fully-functional. When the Power State is other than D0, the bridge will Master Abort (i.e. not claim) any downstream cycles (with exception of type 0 config cycles). Consequently, these unclaimed cycles will go down DMI and come back up as Unsupported Requests, which the MCH logs as Master Aborts in Device 0 PCISTS[13] There is no additional hardware functionality required to support these Power States.



## 8.27 SS\_CAPID—Subsystem ID and Vendor ID Capabilities

B/D/F/Type: 0/6/0/PCI  
Address Offset: 88–8Bh  
Default Value: 0000800Dh  
Access: RO  
Size: 32 bits

This capability is used to uniquely identify the subsystem where the PCI device resides. Because this device is an integrated part of the system and not an add-in device, it is anticipated that this capability will never be used. However, it is necessary because Microsoft will test for its presence.

Bit	Access	Default Value	Description
31:16	RO	0000h	Reserved
15:8	RO	80h	<b>Pointer to Next Capability (PNC):</b> This contains a pointer to the next item in the capabilities list which is the PCI Power Management capability.
7:0	RO	0Dh	<b>Capability ID (CID):</b> Value of 0Dh identifies this linked list item (capability structure) as being for SSID/SSVID registers in a PCI-to-PCI Bridge.

## 8.28 SS—Subsystem ID and Subsystem Vendor ID

B/D/F/Type: 0/6/0/PCI  
Address Offset: 8C–8Fh  
Default Value: 00008086h  
Access: RWO  
Size: 32 bits

System BIOS can be used as the mechanism for loading the SSID/SVID values. These values must be preserved through power management transitions and a hardware reset.

Bit	Access	Default Value	Description
31:16	RWO	0000h	<b>Subsystem ID (SSID):</b> Identifies the particular subsystem and is assigned by the vendor.
15:0	RWO	8086h	<b>Subsystem Vendor ID (SSVID):</b> Identifies the manufacturer of the subsystem and is the same as the vendor ID which is assigned by the PCI Special Interest Group.



## 8.29 MSI\_CAPID—Message Signaled Interrupts Capability ID

B/D/F/Type: 0/6/0/PCI  
 Address Offset: 90–91h  
 Default Value: A005h  
 Access: RO  
 Size: 16 bits

When a device supports MSI it can generate an interrupt request to the processor by writing a predefined data item (a message) to a predefined memory address.

Bit	Access	Default Value	Description
15:8	RO	A0h	<b>Pointer to Next Capability (PNC):</b> This contains a pointer to the next item in the capabilities list which is the PCI Express capability.
7:0	RO	05h	<b>Capability ID (CID):</b> Value of 05h identifies this linked list item (capability structure) as being for MSI registers.

## 8.30 MC—Message Control

B/D/F/Type: 0/6/0/PCI  
 Address Offset: 92–93h  
 Default Value: 0000h  
 Access: RW, RO  
 Size: 16 bits

System software can modify bits in this register, but the device is prohibited from doing so.

If the device writes the same message multiple times, only one of those messages is guaranteed to be serviced. If all of them must be serviced, the device must not generate the same message again until the driver services the earlier one.

Bit	Access	Default Value	Description
15:8	RO	00h	Reserved
7	RO	0b	<b>64-bit Address Capable (64AC):</b> Hardwired to 0 to indicate that the function does not implement the upper 32 bits of the Message Address register and is incapable of generating a 64-bit memory address.
6:4	RW	000b	<b>Multiple Message Enable (MME):</b> System software programs this field to indicate the actual number of messages allocated to this device. This number will be equal to or less than the number actually requested. The encoding is the same as for the MMC field below.
3:1	RO	000b	<b>Multiple Message Capable (MMC):</b> System software reads this field to determine the number of messages being requested by this device. The value of 000b equates to 1 message requested. 000 = 1 message requested All other encodings are reserved.
0	RW	0b	<b>MSI Enable (MSIEN):</b> Controls the ability of this device to generate MSIs. 0 = MSI will not be generated. 1 = MSI will be generated when we receive PME messages. INTA will not be generated and INTA Status (PCISTS1[3]) will not be set.



### 8.31 MA—Message Address

B/D/F/Type: 0/6/0/PCI  
 Address Offset: 94–97h  
 Default Value: 00000000h  
 Access: RO, RW  
 Size: 32 bits

Bit	Access	Default Value	Description
31:2	RW	00000000h	<b>Message Address (MA)</b> : Used by system software to assign an MSI address to the device. The device handles an MSI by writing the padded contents of the MD register to this address.
1:0	RO	00b	<b>Force DWord Align (FDWA)</b> : Hardwired to 0 so that addresses assigned by system software are always aligned on a DWord address boundary.

### 8.32 MD—Message Data

B/D/F/Type: 0/6/0/PCI  
 Address Offset: 98–99h  
 Default Value: 0000h  
 Access: RW  
 Size: 16 bits

Bit	Access	Default Value	Description
15:0	RW	0000h	<b>Message Data (MD)</b> : Base message data pattern assigned by system software and used to handle an MSI from the device. When the device must generate an interrupt request, it writes a 32-bit value to the memory address specified in the MA register. The upper 16-bits are always set to 0. The lower 16-bits are supplied by this register.

### 8.33 PE\_CAPL—PCI Express\* Capability List

B/D/F/Type: 0/6/0/PCI  
 Address Offset: A0–A1h  
 Default Value: 0010h  
 Access: RO  
 Size: 16 bits

This register enumerates the PCI Express capability structure.

Bit	Access	Default Value	Description
15:8	RO	00h	<b>Pointer to Next Capability (PNC)</b> : This value terminates the capabilities list. The Virtual Channel capability and any other PCI Express specific capabilities that are reported via this mechanism are in a separate capabilities list located entirely within PCI Express Extended Configuration Space.
7:0	RO	10h	<b>Capability ID (CID)</b> : Identifies this linked list item (capability structure) as being for PCI Express registers.



## 8.34 PE\_CAP—PCI Express\* Capabilities

B/D/F/Type: 0/6/0/PCI  
 Address Offset: A2–A3h  
 Default Value: 0142h  
 Access: RO, RWO  
 Size: 16 bits

This register indicates PCI Express device capabilities.

Bit	Access	Default Value	Description
15:14	RO	00b	Reserved
13:9	RO	00h	<b>Interrupt Message Number (IMN)</b> : Not Applicable or Implemented. Hardwired to 0.
8	RWO	1b	<b>Slot Implemented (SI)</b> : 0 = The PCI Express Link associated with this port is connected to an integrated component or is disabled. 1 = The PCI Express Link associated with this port is connected to a slot.
7:4	RO	4h	<b>Device/Port Type (DPT)</b> : Hardwired to 4h to indicate root port of PCI Express Root Complex.
3:0	RO	2h	<b>PCI Express Capability Version (PCI ECV)</b> : Hardwired to 2h to indicate compliance to the PCI Express Capabilities Register Expansion ECN.

## 8.35 DCAP—Device Capabilities

B/D/F/Type: 0/6/0/PCI  
 Address Offset: A4–A7h  
 Default Value: 00008000h  
 Access: RO  
 Size: 32 bits

This register indicates PCI Express device capabilities.

Bit	Access	Default Value	Description
31:16	RO	0000h	Reserved
15	RO	1b	<b>Role Based Error Reporting (RBER)</b> : This bit indicates that this device implements the functionality defined in the Error Reporting ECN as required by the PCI Express 1.1 specification.
14:6	RO	000h	Reserved
5	RO	0b	<b>Extended Tag Field Supported (ETFS)</b> : Hardwired to indicate support for 5-bit Tags as a Requestor.
4:3	RO	00b	<b>Phantom Functions Supported (PFS)</b> : Not Applicable or Implemented. Hardwired to 0.
2:0	RO	000b	<b>Max Payload Size (MPS)</b> : Hardwired to indicate 128B max supported payload for Transaction Layer Packets (TLP).



## 8.36 DCTL—Device Control

B/D/F/Type: 0/6/0/PCI  
 Address Offset: A8–A9h  
 Default Value: 0000h  
 Access: RW, RO  
 Size: 16 bits

This register provides control for PCI Express device specific capabilities.

The error reporting enable bits are in reference to errors detected by this device, not error messages received across the link. The reporting of error messages (ERR\_CORR, ERR\_NONFATAL, ERR\_FATAL) received by Root Port is controlled exclusively by Root Port Command Register.

Bit	Access	Default Value	Description
15:8	RO	0h	Reserved
7:5	RW	000b	<b>Max Payload Size (MPS):</b> 000 = 128B max supported payload for Transaction Layer Packets (TLP). As a receiver, the Device must handle TLPs as large as the set value; as transmitter, the Device must not generate TLPs exceeding the set value. All other encodings are reserved. Hardware will actually ignore this field. It is writeable only to support compliance testing.
4	RO	0b	Reserved
3	RW	0b	<b>Unsupported Request Reporting Enable (URRE):</b> When set, this bit allows signaling ERR_NONFATAL, ERR_FATAL, or ERR_CORR to the Root Control register when detecting an unmasked Unsupported Request (UR). An ERR_CORR is signaled when an unmasked Advisory Non-Fatal UR is received. An ERR_FATAL or ERR_NONFATAL is sent to the Root Control register when an uncorrectable non-Advisory UR is received with the severity bit set in the Uncorrectable Error Severity register.
2	RW	0b	<b>Fatal Error Reporting Enable (FERE):</b> When set, this bit enables signaling of ERR_FATAL to the Root Control register due to internally detected errors or error messages received across the link. Other bits also control the full scope of related error reporting.
1	RW	0b	<b>Non-Fatal Error Reporting Enable (NERE):</b> When set, this bit enables signaling of ERR_NONFATAL to the Root Control register due to internally detected errors or error messages received across the link. Other bits also control the full scope of related error reporting.
0	RW	0b	<b>Correctable Error Reporting Enable (CERE):</b> When set, this bit enables signaling of ERR_CORR to the Root Control register due to internally detected errors or error messages received across the link. Other bits also control the full scope of related error reporting.

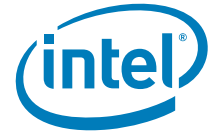

## 8.37 DSTS—Device Status

B/D/F/Type: 0/6/0/PCI  
 Address Offset: AA–ABh  
 Default Value: 0000h  
 Access: RO, RWC  
 Size: 16 bits

This register reflects status corresponding to controls in the Device Control register. The error reporting bits are in reference to errors detected by this device, not errors messages received across the link.

Bit	Access	Default Value	Description
15:6	RO	000h	Reserved
5	RO	0b	<b>Transactions Pending (TP):</b> 0 = All pending transactions (including completions for any outstanding non-posted requests on any used virtual channel) have been completed. 1 = Indicates that the device has transaction(s) pending (including completions for any outstanding non-posted requests for all used Traffic Classes).
4	RO	0b	Reserved
3	RWC	0b	<b>Unsupported Request Detected (URD):</b> When set, this bit indicates that the Device received an Unsupported Request. Errors are logged in this register regardless of whether error reporting is enabled or not in the Device Control Register. Additionally, the Non-Fatal Error Detected bit or the Fatal Error Detected bit is set according to the setting of the Unsupported Request Error Severity bit. In production systems setting the Fatal Error Detected bit is not an option as support for AER will not be reported.
2	RWC	0b	<b>Fatal Error Detected (FED):</b> When set, this bit indicates that fatal error(s) were detected. Errors are logged in this register regardless of whether error reporting is enabled or not in the Device Control register. When Advanced Error Handling is enabled, errors are logged in this register regardless of the settings of the uncorrectable error mask register.
1	RWC	0b	<b>Non-Fatal Error Detected (NFED):</b> When set, this bit indicates that non-fatal error(s) were detected. Errors are logged in this register regardless of whether error reporting is enabled or not in the Device Control register. When Advanced Error Handling is enabled, errors are logged in this register regardless of the settings of the uncorrectable error mask register.
0	RWC	0b	<b>Correctable Error Detected (CED):</b> When set, this bit indicates that correctable error(s) were detected. Errors are logged in this register regardless of whether error reporting is enabled or not in the Device Control register. When Advanced Error Handling is enabled, errors are logged in this register regardless of the settings of the correctable error mask register.



## 8.38 LCAP—Link Capabilities

B/D/F/Type: 0/6/0/PCI  
 Address Offset: AC–AFh  
 Default Value: 03214D01h  
 Access: RO, RWO  
 Size: 32 bits

This register indicates PCI Express device specific capabilities.

Bit	Access	Default Value	Description
31:24	RO	03h	<b>Port Number (PN):</b> This field indicates the PCI Express port number for the given PCI Express link. Matches the value in Element Self Description[31:24].
23:22	RO	000b	Reserved
21	RO	1b	<b>Link Bandwidth Notification Capability:</b> A value of 1b indicates support for the Link Bandwidth Notification status and interrupt mechanisms. This capability is required for all Root Ports and Switch downstream ports supporting Links wider than x1 and/or multiple Link speeds.  This field is not applicable and is reserved for Endpoint devices, PCI Express to PCI/PCI-X bridges, and Upstream Ports of Switches.  Devices that do not implement the Link Bandwidth Notification capability must hardwire this bit to 0b.
20	RO	0b	<b>Data Link Layer Link Active Reporting Capable (DLLARC):</b> For a Downstream Port, this bit must be set to 1b if the component supports the optional capability of reporting the DL_Active state of the Data Link Control and Management State Machine.  For Upstream Ports and components that do not support this optional capability, this bit must be hardwired to 0b.
19	RO	0b	<b>Surprise Down Error Reporting Capable (SDERC):</b> For a Downstream Port, this bit must be set to 1b if the component supports the optional capability of detecting and reporting a Surprise Down error condition.  For Upstream Ports and components that do not support this optional capability, this bit must be hardwired to 0b.
18	RO	0b	<b>Clock Power Management (CPM):</b> A value of 1b in this bit indicates that the component tolerates the removal of any reference clock(s) when the link is in the L1 and L2/3 Ready link states. A value of 0b indicates the component does not have this capability and that reference clock(s) must not be removed in these link states.  This capability is applicable only in form factors that support "clock request" (CLKREQ#) capability.  For a multi-function device, each function indicates its capability independently. Power Management configuration software must only permit reference clock removal if all functions of the multifunction device indicate a 1b in this bit.
17:15	RWO	010b	<b>L1 Exit Latency (L1ELAT):</b> Indicates the length of time this Port requires to complete the transition from L1 to L0. The value 010 b indicates the range of 2 us to less than 4 us.  Both bytes of this register that contain a portion of this field must be written simultaneously in order to prevent an intermediate (and undesired) value from ever existing.





Bit	Access	Default Value	Description
14:12	RO	100b	<p><b>LOs Exit Latency (LOSELAT):</b> Indicates the length of time this Port requires to complete the transition from LOs to LO.</p> <p>000 = Less than 64 ns                      001 = 64ns to less than 128ns                      010 = 128ns to less than 256 ns                      011 = 256ns to less than 512ns                      100 = 512ns to less than 1us                      101 = 1 us to less than 2 us                      110 = 2 us – 4 us                      111 = More than 4 us</p>
11:10	RWO	11b	<p><b>Active State Link PM Support (ASLPMS):</b> The MCH supports ASPM LOs and L1.</p>
9:4	RO	10h	<p><b>Max Link Width (MLW):</b> Indicates the maximum number of lanes supported for this link.</p> <p>08h = x8                      10h = x16</p> <p>For the 3210 MCH with dual 8-lane (x8) configuration, the value of 10h is reserved. The supported maximum lane size is 8-lanes (x8) for this link.                      For the 3200 MCH, the value of 10h is reserved. The supported maximum lane size is 8-lanes (x8) for this link.</p>
3:0	RO	1h	<p><b>Max Link Speed (MLS):</b> Supported Link Speed - This field indicates the supported Link speed(s) of the associated Port.</p> <p>0001b = 2.5GT/s Link speed supported                      All other encodings are reserved.</p>



## 8.39 LCTL—Link Control

B/D/F/Type: 0/6/0/PCI  
 Address Offset: B0–B1h  
 Default Value: 0000h  
 Access: RO, RW, RW/SC  
 Size: 16 bits

This register allows control of PCI Express link.

Bit	Access	Default Value	Description
15:12	RO	0000000b	Reserved
11	RW	0b	<p><b>Link Autonomous Bandwidth Interrupt Enable:</b> When Set, this bit enables the generation of an interrupt to indicate that the Link Autonomous Bandwidth Status bit has been set.</p> <p>This bit is not applicable and is reserved for Endpoint devices, PCI Express to PCI/PCI-X bridges, and Upstream Ports of Switches.</p> <p>Devices that do not implement the Link Bandwidth Notification capability must hardwire this bit to 0b.</p>
10	RW	0b	<p><b>Link Bandwidth Management Interrupt Enable:</b> When Set, this bit enables the generation of an interrupt to indicate that the Link Bandwidth Management Status bit has been set.</p> <p>This bit is not applicable and is reserved for Endpoint devices, PCI Express to PCI/PCI-X bridges, and Upstream Ports of Switches.</p>
9	RO	0b	<p><b>Hardware Autonomous Width Disable:</b> When Set, this bit disables hardware from changing the Link width for reasons other than attempting to correct unreliable Link operation by reducing Link width.</p> <p>Devices that do not implement the ability autonomously to change Link width are permitted to hardwire this bit to 0b.</p> <p>The MCH does not support autonomous width change. So, this bit is "RO".</p>
8	RO	0b	<p><b>Enable Clock Power Management (ECPM):</b> Applicable only for form factors that support a "Clock Request" (CLKREQ#) mechanism, this enable functions as follows:</p> <p>0 = Clock power management is disabled and device must hold CLKREQ# signal low</p> <p>1 = The device is permitted to use CLKREQ# signal to power manage link clock according to protocol defined in appropriate form factor specification.</p> <p>Default value of this field is 0b.</p> <p>Components that do not support Clock Power Management (as indicated by a 0b value in the Clock Power Management bit of the Link Capabilities Register) must hardwire this bit to 0b.</p>
7	RW	0b	<p><b>Extended Synch (ES):</b></p> <p>0 = Standard Fast Training Sequence (FTS).</p> <p>1 = Forces the transmission of additional ordered sets when exiting the L0s state and when in the Recovery state.</p> <p>This mode provides external devices (e.g., logic analyzers) monitoring the Link time to achieve bit and symbol lock before the link enters L0 and resumes communication.</p> <p>This is a test mode only and may cause other undesired side effects such as buffer overflows or underruns.</p>



Bit	Access	Default Value	Description
6	RW	0b	<p><b>Common Clock Configuration (CCC):</b>            0 = Indicates that this component and the component at the opposite end of this Link are operating with asynchronous reference clock.            1 = Indicates that this component and the component at the opposite end of this Link are operating with a distributed common reference clock.            The state of this bit affects the L0s Exit Latency reported in LCAP[14:12] and the N_FTS value advertised during link training.</p>
5	RW/SC	0b	<p><b>Retrain Link (RL):</b>            0 = Normal operation.            1 = Full Link retraining is initiated by directing the Physical Layer LTSSM from L0, L0s, or L1 states to the Recovery state.            This bit always returns 0 when read.            This bit is cleared automatically (no need to write a 0).            It is permitted to write 1b to this bit while simultaneously writing modified values to other fields in this register. If the LTSSM is not already in Recovery or Configuration, the resulting Link training must use the modified values. If the LTSSM is already in Recovery or Configuration, the modified values are not required to affect the Link training that's already in progress.</p>
4	RW	0b	<p><b>Link Disable (LD):</b>            0 = Normal operation.            1 = Link is disabled. Forces the LTSSM to transition to the Disabled state (via Recovery) from L0, L0s, or L1 states. Link retraining happens automatically on 0 to 1 transition, just like when coming out of reset.            Writes to this bit are immediately reflected in the value read from the bit, regardless of actual Link state.</p>
3	RO	0b	<b>Read Completion Boundary (RCB):</b> Hardwired to 0 to indicate 64 byte.
2	RW	0b	Reserved
1:0	RW	00b	<p><b>Active State PM (ASPM):</b> Controls the level of active state power management supported on the given link.            00 = Disabled            01 = L0s Entry Supported            10 = Reserved            11 = L0s and L1 Entry Supported</p>



## 8.40 LSTS—Link Status

B/D/F/Type: 0/6/0/PCI  
 Address Offset: B2–B3h  
 Default Value: 1000h  
 Access: RWC, RO  
 Size: 16 bits

This register indicates PCI Express link status.

Bit	Access	Default Value	Description
15	RWC	0b	<b>Link Autonomous Bandwidth Status (LABWS):</b> This bit is set to 1b by hardware to indicate that hardware has autonomously changed link speed or width, without the port transitioning through DL_Down status, for reasons other than to attempt to correct unreliable link operation. This bit must be set if the Physical Layer reports a speed or width change was initiated by the downstream component that was indicated as an autonomous change.
14	RWC	0b	<b>Link Bandwidth Management Status (LBWMS):</b> This bit is set to 1b by hardware to indicate that either of the following has occurred without the port transitioning through DL_Down status: A link retraining initiated by a write of 1b to the Retrain Link bit has completed. <b>NOTE:</b> This bit is Set following any write of 1b to the Retrain Link bit, including when the Link is in the process of retraining for some other reason. Hardware has autonomously changed link speed or width to attempt to correct unreliable link operation, either through an LTSSM timeout or a higher level process This bit must be set if the Physical Layer reports a speed or width change was initiated by the downstream component that was not indicated as an autonomous change.
13	RO	0b	<b>Data Link Layer Link Active (Optional) (DLLLA):</b> This bit indicates the status of the Data Link Control and Management State Machine. It returns a 1b to indicate the DL_Active state, 0b otherwise. This bit must be implemented if the corresponding Data Link Layer Active Capability bit is implemented. Otherwise, this bit must be hardwired to 0b.
12	RO	1b	<b>Slot Clock Configuration (SCC):</b> 0 = The device uses an independent clock irrespective of the presence of a reference on the connector. 1 = The device uses the same physical reference clock that the platform provides on the connector.
11	RO	0b	<b>Link Training (LTRN):</b> This bit indicates that the Physical Layer LTSSM is in the Configuration or Recovery state, or that 1b was written to the Retrain Link bit but Link training has not yet begun. Hardware clears this bit when the LTSSM exits the Configuration/Recovery state once Link training is complete.
10	RO	0b	<b>Undefined:</b> The value read from this bit is undefined. In previous versions of this specification, this bit was used to indicate a Link Training Error. System software must ignore the value read from this bit. System software is permitted to write any value to this bit.



Bit	Access	Default Value	Description
9:4	RO	00h	<b>Negotiated Link Width (NLW):</b> Indicates negotiated link width. This field is valid only when the link is in the L0, L0s, or L1 states (after link width negotiation is successfully completed). 01h = x1 10h = x16 All other encodings are reserved.
3:0	RO	0h	<b>Current Link Speed (CLS):</b> This field indicates the negotiated Link speed of the given PCI Express Link. Defined encodings are: 0001b = 2.5 GT/s PCI Express Link All other encodings are reserved. The value in this field is undefined when the Link is not up.

## 8.41 SLOTCAP—Slot Capabilities

B/D/F/Type: 0/6/0/PCI  
 Address Offset: B4–B7h  
 Default Value: 00040000h  
 Access: RWO, RO  
 Size: 32 bits

PCI Express Slot related registers.

Bit	Access	Default Value	Description
31:19	RWO	0000h	<b>Physical Slot Number (PSN):</b> Indicates the physical slot number attached to this Port.
18	RO	1b	Reserved
17	RO	0b	<b>Electromechanical Interlock Present (EIP):</b> When set to 1b, this bit indicates that an Electromechanical Interlock is implemented on the chassis for this slot.
16:15	RWO	00b	<b>Slot Power Limit Scale (SPLS):</b> Specifies the scale used for the Slot Power Limit Value. 00 = 1.0x 01 = 0.1x 10 = 0.01x 11 = 0.001x If this field is written, the link sends a Set_Slot_Power_Limit message.
14:7	RWO	00h	<b>Slot Power Limit Value (SPLV):</b> In combination with the Slot Power Limit Scale value, specifies the upper limit on power supplied by slot. Power limit (in Watts) is calculated by multiplying the value in this field by the value in the Slot Power Limit Scale field. If this field is written, the link sends a Set_Slot_Power_Limit message.
6:5	RO	00b	Reserved
4	RO	0b	<b>Power Indicator Present (PIP):</b> When set to 1b, this bit indicates that a Power Indicator is electrically controlled by the chassis for this slot.



Bit	Access	Default Value	Description
3	RO	0b	<b>Attention Indicator Present (AIP):</b> When set to 1b, this bit indicates that an Attention Indicator is electrically controlled by the chassis.
2	RO	0b	<b>MRL Sensor Present (MSP):</b> When set to 1b, this bit indicates that an MRL Sensor is implemented on the chassis for this slot.
1	RO	0b	<b>Power Controller Present (PCP):</b> When set to 1b, this bit indicates that a software programmable Power Controller is implemented for this slot/adaptor (depending on form factor).
0	RO	0b	<b>Attention Button Present (ABP):</b> When set to 1b, this bit indicates that an Attention Button for this slot is electrically controlled by the chassis.

## 8.42 SLOTCTL—Slot Control

B/D/F/Type: 0/6/0/PCI  
 Address Offset: B8–B9h  
 Default Value: 0000h  
 Access: RO, RW  
 Size: 16 bits

PCI Express Slot related registers.

Bit	Access	Default Value	Description
15:13	RO	000b	Reserved
12	RO	0b	<b>Data Link Layer State Changed Enable (DLLSCE):</b> If the Data Link Layer Link Active capability is implemented, when set to 1b, this field enables software notification when Data Link Layer Link Active field is changed. If the Data Link Layer Link Active capability is not implemented, this bit is permitted to be read-only with a value of 0b.
11	RO	0b	<b>Electromechanical Interlock Control (EIC):</b> If an Electromechanical Interlock is implemented, a write of 1b to this field causes the state of the interlock to toggle. A write of 0b to this field has no effect. A read to this register always returns a 0.
10	RO	0b	<b>Power Controller Control (PCC):</b> If a Power Controller is implemented, this field when written sets the power state of the slot per the defined encodings. Reads of this field must reflect the value from the latest write, unless software issues a write without waiting for the previous command to complete in which case the read value is undefined. Depending on the form factor, the power is turned on/off either to the slot or within the adaptor. Note that in some cases the power controller may autonomously remove slot power or not respond to a power-up request based on a detected fault condition, independent of the Power Controller Control setting. 0 = Power On 1 = Power Off If the Power Controller Implemented field in the Slot Capabilities register is set to 0b, then writes to this field have no effect and the read value of this field is undefined.

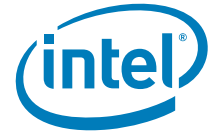

Bit	Access	Default Value	Description
9:8	RO	00b	<p><b>Power Indicator Control (PIC):</b> If a Power Indicator is implemented, writes to this field set the Power Indicator to the written state. Reads of this field must reflect the value from the latest write, unless software issues a write without waiting for the previous command to complete in which case the read value is undefined.</p> <p>00 = Reserved 01 = On 10 = Blink 11 = Off</p> <p>If the Power Indicator Present bit in the Slot Capabilities register is 0b, this field is permitted to be read-only with a value of 00b.</p>
7:6	RO	00b	<p><b>Attention Indicator Control (AIC):</b> If an Attention Indicator is implemented, writes to this field set the Attention Indicator to the written state.</p> <p>Reads of this field must reflect the value from the latest write, unless software issues a write without waiting for the previous command to complete in which case the read value is undefined. If the indicator is electrically controlled by chassis, the indicator is controlled directly by the downstream port through implementation specific mechanisms.</p> <p>00 = Reserved 01 = On 10 = Blink 11 = Off</p> <p>If the Attention Indicator Present bit in the Slot Capabilities register is 0b, this field is permitted to be read only with a value of 00b.</p>
5:4	RO	00b	Reserved
3	RW	0b	<p><b>Presence Detect Changed Enable (PDCE):</b> When set to 1b, this bit enables software notification on a presence detect changed event.</p>
2	RO	0b	<p><b>MRL Sensor Changed Enable (MSCE):</b> When set to 1b, this bit enables software notification on a MRL sensor changed event.</p> <p>Default value of this field is 0b. If the MRL Sensor Present field in the Slot Capabilities register is set to 0b, this bit is permitted to be read-only with a value of 0b.</p>
1	RO	0b	<p><b>Power Fault Detected Enable (PFDE):</b> When set to 1b, this bit enables software notification on a power fault event.</p> <p>Default value of this field is 0b. If Power Fault detection is not supported, this bit is permitted to be read-only with a value of 0b</p>
0	RO	0b	<p><b>Button Pressed Enable (ABPE):</b> When set to 1b, this bit enables software notification on an attention button pressed event.</p>



## 8.43 SLOTSTS—Slot Status

B/D/F/Type: 0/6/0/PCI  
 Address Offset: BA–BBh  
 Default Value: 0000h  
 Access: RO, RWC  
 Size: 16 bits

PCI Express Slot related registers.

Bit	Access	Default Value	Description
15:7	RO	0000000b	Reserved
6	RO	0b	<p><b>Presence Detect State (PDS):</b> This bit indicates the presence of an adapter in the slot, reflected by the logical "OR" of the Physical Layer in-band presence detect mechanism and, if present, any out-of-band presence detect mechanism defined for the slot's corresponding form factor. Note that the in-band presence detect mechanism requires that power be applied to an adapter for its presence to be detected.</p> <p>0 = Slot Empty            1 = Card Present in Slot</p> <p>This register must be implemented on all Downstream Ports that implement slots. For Downstream Ports not connected to slots (where the Slot Implemented bit of the PCI Express Capabilities Register is 0b), this bit must return 1b.</p>
5:4	RO	00b	Reserved
3	RWC	0b	<p><b>Detect Changed (PDC):</b> This bit is set when the value reported in Presence Detect State is changed.</p>
2	RO	0b	<p><b>MRL Sensor Changed (MSC):</b> If an MRL sensor is implemented, this bit is set when a MRL Sensor state change is detected. If an MRL sensor is not implemented, this bit must not be set.</p>
1	RO	0b	<p><b>Power Fault Detected (PFD):</b> If a Power Controller that supports power fault detection is implemented, this bit is set when the Power Controller detects a power fault at this slot. Note that, depending on hardware capability, it is possible that a power fault can be detected at any time, independent of the Power Controller Control setting or the occupancy of the slot. If power fault detection is not supported, this bit must not be set.</p>
0	RO	0b	<p><b>Attention Button Pressed (ABP):</b> If an Attention Button is implemented, this bit is set when the attention button is pressed. If an Attention Button is not supported, this bit must not be set.</p>





## 8.44 RCTL—Root Control

B/D/F/Type: 0/6/0/PCI  
 Address Offset: BC–BDh  
 Default Value: 0000h  
 Access: RO, RW  
 Size: 16 bits

This register allows control of PCI Express Root Complex specific parameters. The system error control bits in this register determine if corresponding SERRs are generated when our device detects an error (reported in this device's Device Status register) or when an error message is received across the link. Reporting of SERR as controlled by these bits takes precedence over the SERR Enable in the PCI Command Register.

Bit	Access	Default Value	Description
15:4	RO	000h	Reserved
3	RW	0b	<b>PME Interrupt Enable (PMEIE):</b> 0 = No interrupts are generated as a result of receiving PME messages. 1 = Enables interrupt generation upon receipt of a PME message as reflected in the PME Status bit of the Root Status Register. A PME interrupt is also generated if the PME Status bit of the Root Status Register is set when this bit is set from a cleared state.
2	RW	0b	<b>System Error on Fatal Error Enable (SEFEE):</b> Controls the Root Complex's response to fatal errors. 0 = No SERR generated on receipt of fatal error. 1 = Indicates that an SERR should be generated if a fatal error is reported by any of the devices in the hierarchy associated with this Root Port, or by the Root Port itself.
1	RW	0b	<b>System Error on Non-Fatal Uncorrectable Error Enable (SENFUEE):</b> Controls the Root Complex's response to non-fatal errors. 0 = No SERR generated on receipt of non-fatal error. 1 = Indicates that an SERR should be generated if a non-fatal error is reported by any of the devices in the hierarchy associated with this Root Port, or by the Root Port itself.
0	RW	0b	<b>System Error on Correctable Error Enable (SECEE):</b> Controls the Root Complex's response to correctable errors. 0 = No SERR generated on receipt of correctable error. 1 = Indicates that an SERR should be generated if a correctable error is reported by any of the devices in the hierarchy associated with this Root Port, or by the Root Port itself.



## 8.45 RSTS—Root Status

B/D/F/Type: 0/6/0/PCI  
 Address Offset: C0–C3h  
 Default Value: 00000000h  
 Access: RO, RWC  
 Size: 32 bits

This register provides information about PCI Express Root Complex specific parameters.

Bit	Access	Default Value	Description
31:18	RO	0000h	Reserved
17	RO	0b	<b>PME Pending (PMEP)</b> : Indicates that another PME is pending when the PME Status bit is set. When the PME Status bit is cleared by software; the PME is delivered by hardware by setting the PME Status bit again and updating the Requestor ID appropriately. The PME pending bit is cleared by hardware if no more PMEs are pending.
16	RWC	0b	<b>PME Status (PMES)</b> : Indicates that PME was asserted by the requestor ID indicated in the PME Requestor ID field. Subsequent PMEs are kept pending until the status register is cleared by writing a 1 to this field.
15:0	RO	0000h	<b>PME Requestor ID (PMERID)</b> : Indicates the PCI requestor ID of the last PME requestor.

## 8.46 PELC—PCI Express Legacy Control

B/D/F/Type: 0/6/0/PCI  
 Address Offset: EC–EFh  
 Default Value: 00000000h  
 Access: RO, RW  
 Size: 32 bits

This register controls functionality that is needed by Legacy (non-PCI Express aware) OSs during run time.

Bit	Access	Default Value	Description
31:3	RO	00000000h	Reserved
2	RW	0b	<b>PME GPE Enable (PMEGPE)</b> : 0 = Do not generate GPE PME message when PME is received. 1 = Generate a GPE PME message when PME is received (Assert_PMEGPE and Deassert_PMEGPE messages on DMI). This enables the MCH to support PMEs on the PCI Express port under legacy OSs.
1	RO	0b	Reserved
0	RW	0b	<b>General Message GPE Enable (GENGPE)</b> : 0 = Do not forward received GPE assert/deassert messages. 1 = Forward received GPE assert/deassert messages. These general GPE message can be received via the PCI Express port from an external Intel device and will be subsequently forwarded to the ICH (via Assert_GPE and Deassert_GPE messages on DMI).



## 8.47 VCECH—Virtual Channel Enhanced Capability Header

B/D/F/Type: 0/6/0/MMR  
 Address Offset: 100–103h  
 Default Value: 14010002h  
 Access: RO  
 Size: 32 bits

This register indicates PCI Express device Virtual Channel capabilities. Extended capability structures for PCI Express devices are located in PCI Express extended configuration space and have different field definitions than standard PCI capability structures.

Bit	Access	Default Value	Description
31:20	RO	140h	<b>Pointer to Next Capability (PNC):</b> The Link Declaration Capability is the next in the PCI Express extended capabilities list.
19:16	RO	1h	<b>PCI Express Virtual Channel Capability Version (PCIEVCCV):</b> Hardwired to 1 to indicate compliances with the 1.1 version of the PCI Express specification.
15:0	RO	0002h	<b>Extended Capability ID (ECID):</b> Value of 0002h identifies this linked list item (capability structure) as being for PCI Express Virtual Channel registers.

## 8.48 PVCCAP1—Port VC Capability Register 1

B/D/F/Type: 0/6/0/MMR  
 Address Offset: 104–107h  
 Default Value: 00000000h  
 Access: RO  
 Size: 32 bits

This register describes the configuration of PCI Express Virtual Channels associated with this port.

Bit	Access	Default Value	Description
31:7	RO	00000h	Reserved
6:4	RO	000b	<b>Low Priority Extended VC Count (LPEVCC):</b> This field indicates the number of (extended) Virtual Channels in addition to the default VC belonging to the low-priority VC (LPVC) group that has the lowest priority with respect to other VC resources in a strict-priority VC Arbitration. The value of 0 in this field implies strict VC arbitration.
3	RO	0b	Reserved
2:0	RO	000b	<b>Extended VC Count (EVCC):</b> This field indicates the number of (extended) Virtual Channels in addition to the default VC supported by the device.



## 8.49 PVCCAP2—Port VC Capability Register 2

B/D/F/Type: 0/6/0/MMR  
Address Offset: 108–10Bh  
Default Value: 00000000h  
Access: RO  
Size: 32 bits

This register describes the configuration of PCI Express Virtual Channels associated with this port.

Bit	Access	Default Value	Description
31:24	RO	00h	<b>VC Arbitration Table Offset (VCATO):</b> This field indicates the location of the VC Arbitration Table. This field contains the zero-based offset of the table in DQWORDS (16 bytes) from the base address of the Virtual Channel Capability Structure. A value of 0 indicates that the table is not present (due to fixed VC priority).
23:0	RO	0000h	Reserved

## 8.50 PVCCTL—Port VC Control

B/D/F/Type: 0/6/0/MMR  
Address Offset: 10C–10Dh  
Default Value: 0000h  
Access: RO, RW  
Size: 16 bits

Bit	Access	Default Value	Description
15:4	RO	000h	Reserved
3:1	RW	000b	<b>VC Arbitration Select (VCAS):</b> This field will be programmed by software to the only possible value as indicated in the VC Arbitration Capability field. Since there is no other VC supported than the default, this field is reserved.
0	RO	0b	Reserved



## 8.51 VCORCAP—VCO Resource Capability

B/D/F/Type: 0/6/0/MMR  
 Address Offset: 110–113h  
 Default Value: 0000001h  
 Access: RO  
 Size: 32 bits

Bit	Access	Default Value	Description
31:16	RO	0000h	Reserved
15	RO	0b	<b>Reject Snoop Transactions (RSNPT):</b> 0 = Transactions with or without the No Snoop bit set within the Transaction Layer Packet header are allowed on this VC. 1 = When Set, any transaction for which the No Snoop attribute is applicable but is not Set within the TLP Header will be rejected as an Unsupported Request.
14:8	RO	0000h	Reserved
7:0	RO	01h	<b>Port Arbitration Capability:</b> Indicates types of Port Arbitration supported by the VC resource. This field is valid for all Switch Ports, Root Ports that support peer-to-peer traffic, and RCRBs, but not for PCI Express Endpoint devices or Root Ports that do not support peer to peer traffic. Each bit location within this field corresponds to a Port Arbitration Capability defined below. When more than one bit in this field is Set, it indicates that the VC resource can be configured to provide different arbitration services. Software selects among these capabilities by writing to the Port Arbitration Select field (see below). Bit[0] = Default = 01b; Non-configurable hardware-fixed arbitration scheme, e.g., Round Robin (RR) Bit[1] = Weighted Round Robin (WRR) arbitration with 32 phases Bit[2] = WRR arbitration with 64 phases Bit[3] = WRR arbitration with 128 phases Bit[4] = Time-based WRR with 128 phases Bit[5] = WRR arbitration with 256 phases Bits[6:7] = Reserved MCH default indicates "Non-configurable hardware-fixed arbitration scheme".



## 8.52 VCORCTL—VCO Resource Control

B/D/F/Type: 0/6/0/MMR  
Address Offset: 114–117h  
Default Value: 800000FFh  
Access: RO, RW  
Size: 32 bits

This register controls the resources associated with PCI Express Virtual Channel 0.

Bit	Access	Default Value	Description
31	RO	1b	<b>VCO Enable (VCOE):</b> For VCO, this is hardwired to 1 and read only as VCO can never be disabled.
30:27	RO	0h	Reserved
26:24	RO	000b	<b>VCO ID (VCOID):</b> This field assigns a VC ID to the VC resource. For VCO this is hardwired to 0 and read only.
23:20	RO	0000h	Reserved
19:17	RW	000b	<b>Port Arbitration Select:</b> This field configures the VC resource to provide a particular Port Arbitration service. This field is valid for RCRBs, Root Ports that support peer to peer traffic, and Switch Ports, but not for PCI Express Endpoint devices or Root Ports that do not support peer to peer traffic. The permissible value of this field is a number corresponding to one of the asserted bits in the Port Arbitration Capability field of the VC resource.
16:8	RO	00h	Reserved
7:1	RW	7Fh	<b>TC/VCO Map (TCVCOM):</b> This field indicates the TCs (Traffic Classes) that are mapped to the VC resource. Bit locations within this field correspond to TC values. For example, when bit 7 is set in this field, TC7 is mapped to this VC resource. When more than one bit in this field is set, it indicates that multiple TCs are mapped to the VC resource. To remove one or more TCs from the TC/VCO Map of an enabled VC, software must ensure that no new or outstanding transactions with the TC labels are targeted at the given Link.
0	RO	1b	<b>TC0/VCO Map (TCOVCOM):</b> Traffic Class 0 is always routed to VCO.



## 8.53 VCORSTS—VCO Resource Status

B/D/F/Type: 0/6/0/MMR  
 Address Offset: 11A–11Bh  
 Default Value: 0002h  
 Access: RO  
 Size: 16 bits

This register reports the Virtual Channel specific status.

Bit	Access	Default Value	Description
15:2	RO	0000h	Reserved
1	RO	1b	<b>VCO Negotiation Pending (VCONP):</b> 0 = The VC negotiation is complete. 1 = The VC resource is still in the process of negotiation (initialization or disabling).  This bit indicates the status of the process of Flow Control initialization. It is set by default on Reset, as well as whenever the corresponding Virtual Channel is Disabled or the Link is in the DL_Down state. It is cleared when the link successfully exits the FC_INIT2 state.  Before using a Virtual Channel, software must check whether the VC Negotiation Pending fields for that Virtual Channel are cleared in both Components on a Link.
0	RO	0b	Reserved

## 8.54 RCLDECH—Root Complex Link Declaration Enhanced

B/D/F/Type: 0/6/0/MMR  
 Address Offset: 140–143h  
 Default Value: 00010005h  
 Access: RO  
 Size: 32 bits

This capability declares links from this element (PCI Express) to other elements of the root complex component to which it belongs. See PCI Express specification for link/topology declaration requirements.

Bit	Access	Default Value	Description
31:20	RO	000h	<b>Pointer to Next Capability (PNC):</b> This is the last capability in the PCI Express extended capabilities list.
19:16	RO	1h	<b>Link Declaration Capability Version (LDCV):</b> Hardwired to 1 to indicate compliances with the 1.1 version of the PCI Express specification.
15:0	RO	0005h	<b>Extended Capability ID (ECID):</b> Value of 0005h identifies this linked list item (capability structure) as being for PCI Express Link Declaration Capability.



## 8.55 ESD—Element Self Description

B/D/F/Type: 0/6/0/MMR  
Address Offset: 144–147h  
Default Value: 03000100h  
Access: RO, RWO  
Size: 32 bits

This register provides information about the root complex element containing this Link Declaration Capability.

Bit	Access	Default Value	Description
31:24	RO	03h	<b>Port Number (PN):</b> This field specifies the port number associated with this element with respect to the component that contains this element. This port number value is used by the egress port of the component to provide arbitration to this Root Complex Element.
23:16	RWO	00h	<b>Component ID (CID):</b> This field indicates the physical component that contains this Root Complex Element.
15:8	RO	01h	<b>Number of Link Entries (NLE):</b> This field indicates the number of link entries following the Element Self Description. This field reports 1 (to Egress port only as we don't report any peer-to-peer capabilities in our topology).
7:4	RO	0h	Reserved
3:0	RO	0h	<b>Element Type (ET):</b> This field indicates Configuration Space Element.





## 8.56 LE1D—Link Entry 1 Description

B/D/F/Type: 0/6/0/MMR  
 Address Offset: 150–153h  
 Default Value: 00000000h  
 Access: RO, RWO  
 Size: 32 bits

This register provides the first part of a Link Entry that declares an internal link to another Root Complex Element.

Bit	Access	Default Value	Description
31:24	RO	00h	<b>Target Port Number (TPN):</b> This field specifies the port number associated with the element targeted by this link entry (Egress Port). The target port number is with respect to the component that contains this element as specified by the target component ID.
23:16	RWO	00h	<b>Target Component ID (TCID):</b> This field identifies the physical or logical component that is targeted by this link entry.
15:2	RO	0000h	Reserved
1	RO	0b	<b>Link Type (LTYP):</b> This bit indicates that the link points to memory-mapped space (for RCRB). The link address specifies the 64-bit base address of the target RCRB.
0	RWO	0b	<b>Link Valid (LV):</b> 0 = Link Entry is not valid and will be ignored. 1 = Link Entry specifies a valid link.

## 8.57 LE1A—Link Entry 1 Address

B/D/F/Type: 0/6/0/MMR  
 Address Offset: 158–15Fh  
 Default Value: 0000000000000000h  
 Access: RO, RWO  
 Size: 64 bits

This register provides the second part of a Link Entry that declares an internal link to another Root Complex Element.

Bit	Access	Default Value	Description
63:32	RO	00000000h	Reserved
31:12	RWO	00000h	<b>Link Address (LA):</b> This field provides the memory mapped base address of the RCRB that is the target element (Egress Port) for this link entry.
11:0	RO	000h	Reserved

§ §



*Host-Secondary PCI Express\* Bridge Registers (D6:F0) (Intel® 3210 MCH only)*



## 9 Direct Media Interface (DMI) RCRB

This Root Complex Register Block (RCRB) controls the MCH-ICH9 serial interconnect. The base address of this space is programmed in DMIBAR in D0:F0 configuration space. [Table 16](#) provides an address map of the DMI registers listed by address offset in ascending order.

**Note:** IMPORTANT: All RCRB register space needs to remain organized as shown here.

**Table 16. Direct Media Interface Register Address Map**

Address Offset	Register Symbol	Register Name	Default Value	Access
0–3h	DMIVCECH	DMI Virtual Channel Enhanced Capability	04010002h	RO
4–7h	DMIPVCCAP1	DMI Port VC Capability Register 1	00000001h	RWO, RO
C–Dh	DMIPVCCTL	DMI Port VC Control	0000h	RO, RW
10–13h	DMIVCORCAP	DMI VC0 Resource Capability	00000001h	RO
14–17h	DMIVCORCTL0	DMI VC0 Resource Control	800000FFh	RO, RW
1A–1Bh	DMIVCORSTS	DMI VC0 Resource Status	0002h	RO
1C–1Fh	DMIVC1RCAP	DMI VC1 Resource Capability	00008001h	RO
20–23h	DMIVC1RCTL1	DMI VC1 Resource Control	01000000h	RW, RO
26–27h	DMIVC1RSTS	DMI VC1 Resource Status	0002h	RO
84–87h	DMILCAP	DMI Link Capabilities	00012C41h	RO, RWO
88–89h	DMILCTL	DMI Link Control	0000h	RW, RO
8A–8Bh	DMILSTS	DMI Link Status	0001h	RO



## 9.1 DMI VCECH—DMI Virtual Channel Enhanced Capability

B/D/F/Type: 0/0/0/DMIBAR  
 Address Offset: 0–3h  
 Default Value: 04010002h  
 Access: RO  
 Size: 32 bits

This register indicates DMI Virtual Channel capabilities.

Bit	Access	Default Value	Description
31:20	RO	040h	<b>Pointer to Next Capability (PNC)</b> : This field contains the offset to the next PCI Express capability structure in the linked list of capabilities (Link Declaration Capability).
19:16	RO	1h	<b>PCI Express Virtual Channel Capability Version (PCI EVCCV)</b> : Hardwired to 1 to indicate compliances with the 1.1 version of the PCI Express specification. Note: This version does not change for 2.0 compliance.
15:0	RO	0002h	<b>Extended Capability ID (ECID)</b> : Value of 0002 h identifies this linked list item (capability structure) as being for PCI Express Virtual Channel registers.

## 9.2 DMIPVCCAP1—DMI Port VC Capability Register 1

B/D/F/Type: 0/0/0/DMIBAR  
 Address Offset: 4–7h  
 Default Value: 00000001h  
 Access: RWO, RO  
 Size: 32 bits

This register describes the configuration of PCI Express Virtual Channels associated with this port.

Bit	Access	Default Value	Description
31:7	RO	0000000h	Reserved
6:4	RO	000b	<b>Low Priority Extended VC Count (LPEVCC)</b> : Indicates the number of (extended) Virtual Channels in addition to the default VC belonging to the low-priority VC (LPVC) group that has the lowest priority with respect to other VC resources in a strict-priority VC Arbitration. The value of 0 in this field implies strict VC arbitration.
3	RO	0b	Reserved
2:0	RWO	001b	<b>Extended VC Count (EVCC)</b> : Indicates the number of (extended) Virtual Channels in addition to the default VC supported by the device. The Private Virtual Channel is not included in this count.



### 9.3 DMIPVCCTL—DMI Port VC Control

B/D/F/Type: 0/0/0/DMIBAR  
 Address Offset: C–Dh  
 Default Value: 0000h  
 Access: RO, RW  
 Size: 16 bits

Bit	Access	Default Value	Description
15:4	RO	000h	Reserved
3:1	RW	000b	<b>VC Arbitration Select (VCAS):</b> This field will be programmed by software to the only possible value as indicated in the VC Arbitration Capability field. See the PCI express specification for more details
0	RO	0b	Reserved

### 9.4 DMIVCORCAP—DMI VCO Resource Capability

B/D/F/Type: 0/0/0/DMIBAR  
 Address Offset: 10–13h  
 Default Value: 00000001h  
 Access: RO  
 Size: 32 bits

Bit	Access	Default Value	Description
31:16	RO	0s	Reserved
15	RO	0b	<b>Reject Snoop Transactions (REJSNPT):</b> 0 = Transactions with or without the No Snoop bit set within the TLP header are allowed on this VC. 1 = When Set, any transaction for which the No Snoop attribute is applicable but is not Set within the TLP Header will be rejected as an Unsupported Request.
14:8	RO	00h	Reserved
7:0	RO	01h	<b>Port Arbitration Capability (PAC):</b> Having only bit 0 set indicates that the only supported arbitration scheme for this VC is non-configurable hardware-fixed.



## 9.5 DMI VCORCTLO—DMI VCO Resource Control

B/D/F/Type: 0/0/0/DMIBAR  
Address Offset: 14–17h  
Default Value: 800000FFh  
Access: RO, RW  
Size: 32 bits

This register controls the resources associated with PCI Express Virtual Channel 0.

Bit	Access	Default Value	Description
31	RO	1b	<b>Virtual Channel 0 Enable (VCOE):</b> For VCO this is hardwired to 1 and read only as VCO can never be disabled.
30:27	RO	0h	Reserved
26:24	RO	000b	<b>Virtual Channel 0 ID (VCOID):</b> Assigns a VC ID to the VC resource. For VCO this is hardwired to 0 and read only.
23:20	RO	0h	Reserved
19:17	RW	000b	<b>Port Arbitration Select (PAS):</b> This field configures the VC resource to provide a particular Port Arbitration service. Valid value for this field is a number corresponding to one of the asserted bits in the Port Arbitration Capability field of the VC resource. Because only bit 0 of that field is asserted. This field will always be programmed to 1.
16:8	RO	000h	Reserved
7:1	RW	7Fh	<b>Traffic Class / Virtual Channel 0 Map (TCVCOM):</b> This field indicates the TCs (Traffic Classes) that are mapped to the VC resource. Bit locations within this field correspond to TC values. For example, when bit 7 is set in this field, TC7 is mapped to this VC resource. When more than one bit in this field is set, it indicates that multiple TCs are mapped to the VC resource. In order to remove one or more TCs from the TC/VC Map of an enabled VC, software must ensure that no new or outstanding transactions with the TC labels are targeted at the given Link.
0	RO	1b	<b>Traffic Class 0 / Virtual Channel 0 Map (TCOVCOM):</b> Traffic Class 0 is always routed to VCO.



## 9.6 DMI VCORSTS—DMI VCO Resource Status

B/D/F/Type: 0/0/0/DMIBAR  
 Address Offset: 1A–1Bh  
 Default Value: 0002h  
 Access: RO  
 Size: 16 bits

This register reports the Virtual Channel specific status.

Bit	Access	Default Value	Description
15:2	RO	0000h	Reserved
1	RO	1b	<p><b>Virtual Channel 0 Negotiation Pending (VCONP):</b>            0 = The VC negotiation is complete.            1 = The VC resource is still in the process of negotiation (initialization or disabling).</p> <p>This bit indicates the status of the process of Flow Control initialization. It is set by default on Reset, as well as whenever the corresponding Virtual Channel is Disabled or the Link is in the DL_Down state.            It is cleared when the link successfully exits the FC_INIT2 state.</p> <p><b>BIOS Requirement:</b> Before using a Virtual Channel, software must check whether the VC Negotiation Pending fields for that Virtual Channel are cleared in both Components on a Link.</p>
0	RO	0b	Reserved

## 9.7 DMI VC1RCAP—DMI VC1 Resource Capability

B/D/F/Type: 0/0/0/DMIBAR  
 Address Offset: 1C–1Fh  
 Default Value: 00008001h  
 Access: RO  
 Size: 32 bits

Bit	Access	Default Value	Description
31:16	RO	00h	Reserved
15	RO	1b	<p><b>Reject Snoop Transactions (REJSNPT):</b>            0 = Transactions with or without the No Snoop bit set within the TLP header are allowed on this VC.            1 = When Set, any transaction for which the No Snoop attribute is applicable but is not Set within the TLP Header will be rejected as an Unsupported Request.</p>
14:8	RO	00h	Reserved
7:0	RO	01h	<p><b>Port Arbitration Capability (PAC):</b> Having only bit 0 set indicates that the only supported arbitration scheme for this VC is non-configurable hardware-fixed.</p>



## 9.8 DMIVC1RCTL1—DMI VC1 Resource Control

B/D/F/Type: 0/0/0/DMIBAR  
Address Offset: 20–23h  
Default Value: 01000000h  
Access: RW, RO  
Size: 32 bits

This register controls the resources associated with PCI Express Virtual Channel 1.

Bit	Access	Default Value	Description
31	RW	0b	<b>Virtual Channel 1 Enable (VC1E):</b> 0 = Virtual Channel is disabled. 1 = Virtual Channel is enabled.
30:27	RO	0h	Reserved
26:24	RW	001b	<b>Virtual Channel 1 ID (VC1ID):</b> This field assigns a VC ID to the VC resource. Assigned value must be non-zero. This field can not be modified when the VC is already enabled.
23:20	RO	0h	Reserved
19:17	RW	000b	<b>Port Arbitration Select (PAS):</b> This field configures the VC resource to provide a particular Port Arbitration service. Valid value for this field is a number corresponding to one of the asserted bits in the Port Arbitration Capability field of the VC resource.
16:8	RO	000h	Reserved
7:1	RW	00h	<b>Traffic Class / Virtual Channel 1 Map (TCVC1M):</b> This field indicates the TCs (Traffic Classes) that are mapped to the VC resource. Bit locations within this field correspond to TC values. For example, when bit 7 is set in this field, TC7 is mapped to this VC resource. When more than one bit in this field is set, it indicates that multiple TCs are mapped to the VC resource. To remove one or more TCs from the TC/VC Map of an enabled VC, software must ensure that no new or outstanding transactions with the TC labels are targeted at the given Link.
0	RO	0b	<b>Traffic Class 0 / Virtual Channel 1 Map (TC0VC1M):</b> Traffic Class 0 is always routed to VC0.





## 9.9 DMIVC1RSTS—DMI VC1 Resource Status

B/D/F/Type: 0/0/0/DMIBAR  
 Address Offset: 26–27h  
 Default Value: 0002h  
 Access: RO  
 Size: 16 bits

This register reports the Virtual Channel specific status.

Bit	Access	Default Value	Description
15:2	RO	0000h	Reserved
1	RO	1b	<b>Virtual Channel 1 Negotiation Pending (VC1NP):</b> 0 = The VC negotiation is complete. 1 = The VC resource is still in the process of negotiation (initialization or disabling).
0	RO	0b	Reserved

## 9.10 DMILCAP—DMI Link Capabilities

B/D/F/Type: 0/0/0/DMIBAR  
 Address Offset: 84–87h  
 Default Value: 00012C41h  
 Access: RO, RWO  
 Size: 32 bits

This register indicates DMI specific capabilities.

Bit	Access	Default Value	Description
31:18	RO	0000h	Reserved
17:15	RWO	010b	<b>L1 Exit Latency (L1SELAT):</b> This field indicates the length of time this Port requires to complete the transition from L1 to L0. 010 = 2 $\mu$ s to less than 4 $\mu$ s All other encodings are reserved.
14:12	RWO	010b	<b>LOs Exit Latency (LOSELAT):</b> This field indicates the length of time this Port requires to complete the transition from LOs to L0. 010 = 128 ns to less than 256 ns All other encodings are reserved.
11:10	RO	11b	<b>Active State Link PM Support (ASLPMS):</b> L0s & L1 entry supported.
9:4	RO	04h	<b>Max Link Width (MLW):</b> This field indicates the maximum number of lanes supported for this link. 04h = x4 All other encodings are reserved.
3:0	RO	1h	<b>Max Link Speed (MLS):</b> Hardwired to indicate 2.5 Gb/s.



## 9.11 DMILCTL—DMI Link Control

B/D/F/Type: 0/0/0/DMIBAR  
 Address Offset: 88–89h  
 Default Value: 0000h  
 Access: RW, RO  
 Size: 16 bits

This register allows control of DMI.

Bit	Access	Default Value	Description
15:8	RO	00h	Reserved
7	RW	0b	<b>Extended Synch (EXTSYNC):</b> 0 = Standard Fast Training Sequence (FTS). 1 = Forces the transmission of additional ordered sets when exiting the L0s state and when in the Recovery state.
6:3	RO	0h	Reserved
2	RW	0b	<b>Far-End Digital Loopback (FEDLB):</b>
1:0	RW	00b	<b>Active State Power Management Support (ASPMS):</b> This field controls the level of active state power management supported on the given link. 00 = Disabled 01 = L0s Entry Supported 10 = Reserved 11 = L0s and L1 Entry Supported

## 9.12 DMILSTS—DMI Link Status

B/D/F/Type: 0/0/0/DMIBAR  
 Address Offset: 8A–8Bh  
 Default Value: 0001h  
 Access: RO  
 Size: 16 bits

This register indicates DMI status.

Bit	Access	Default Value	Description
15:4	RO	0s	Reserved
3:0	RO	1h	<b>Negotiated Speed (NSPD):</b> This field indicates negotiated link speed. 1h = 2.5 Gb/s All other encodings are reserved.





# 10 Functional Description

## 10.1 Host Interface

The MCH supports Dual-Core Intel® Xeon® Processor 3000 Series and Quad-Core Intel® Xeon® Processor 3200 Series processors. The cache line size is 64 bytes. Source synchronous transfer is used for the address and data signals. The address signals are double pumped and a new address can be generated every other bus clock. At 200/267/333MHz bus clock the address signals run at 667MT/s. The data is quad pumped and an entire 64B cache line can be transferred in two bus clocks. At 200/266/333MHz bus clock, the data signals run at 800/1066/1333MT/s for a maximum bandwidth of 6.4/8.5/10.6GB/s.

### 10.1.1 FSB IOQ Depth

The Scalable Bus supports up to 12 simultaneous outstanding transactions.

### 10.1.2 FSB OOQ Depth

The MCH supports only one outstanding deferred transaction on the FSB.

### 10.1.3 FSB GTL+ Termination

The MCH integrates GTL+ termination resistors on die.

### 10.1.4 FSB Dynamic Bus Inversion

The MCH supports Dynamic Bus Inversion (DBI) when driving and when receiving data from the processor. DBI limits the number of data signals that are driven to a low voltage on each quad pumped data phase. This decreases the worst-case power consumption of the MCH. HDINV[3:0]# indicate if the corresponding 16 bits of data are inverted on the bus for each quad pumped data phase:

HDINV#[3:0]	Data Bits
HDINV0#	HD[15:0]#
HDINV1#	HD[31:16]#
HDINV2#	HD[47:32]#
HDINV3#	HD[63:48]#

When the processor or the MCH drives data, each 16-bit segment is analyzed. If more than 8 of the 16 signals would normally be driven low on the bus, the corresponding HDINV# signal will be asserted, and the data will be inverted prior to being driven on the bus. When the processor or the MCH receives data, it monitors HDINV#[3:0] to determine if the corresponding data segment should be inverted.



Table 17. Host Interface 4X, 2X, and 1X Signal Groups

Signals	Associated Clock or Strobe	Signal Group
ADS#, BNR#, BPRI#, DEFER#, DBSY#, DRDY#, HIT#, HITM#, LOCK#, RS[2:0]#, TRDY#, RESET, BR0#	BCLK	1X
HA[16:3]#, REQ[4:0]#	ADSTB[0]#	2X
HA[35:17]#	ADSTB[1]#	
D[15:0]#, DBI0#	DSTBP0#, DSTBN0#	4X
D[31:16]#, DBI1#	DSTBP1#, DSTBN1#	
D[47:32]#, DBI2#	DSTBP2#, DSTBN2#	
D[63:48]#, DBI3#	DSTBP3#, DSTBN3#	

### 10.1.5 APIC Cluster Mode Support

APIC Cluster mode support is required for backwards compatibility with existing software, including various operating systems.

The MCH supports three types of interrupt re-direction:

- Physical
- Flat-Logical
- Clustered-Logical



## 10.2 System Memory Controller

The system memory controller supports DDR2 protocol with two independent 64 bit wide channels each accessing one or two DIMMs. It supports a maximum of two unbuffered ECC or non-ECC DDR2 DIMMs per channel thus allowing up to four device ranks per channel.

### 10.2.1 System Memory Organization Modes

The system memory controller supports two memory organization modes, Single Channel and Dual Channel.

#### 10.2.1.1 Single Channel Mode

In this mode, all memory cycles are directed to a single channel.

Single channel mode is used when either Channel A or Channel B DIMMs are populated in any order, but not both.

#### 10.2.1.2 Dual Channel Modes

##### 10.2.1.2.1 Dual Channel Symmetric Mode

This mode provides maximum performance on real applications. Addresses are ping-ponged between the channels after each cache line (64 byte boundary). If there are two requests, and the second request is to an address on the opposite channel from the first, that request can be sent before data from the first request has returned. If two consecutive cache lines are requested, both may be retrieved simultaneously, since they are guaranteed to be on opposite channels.

Dual channel symmetric mode is used when both Channel A and Channel B DIMMs are populated in any order with the total amount of memory in each channel being the same, but the DRAM device technology and width may vary from one channel to the other.

Table 18 is a sample dual channel symmetric memory configuration showing the rank organization.

**Table 18. Sample System Memory Dual Channel Symmetric Organization Mode**

Rank	Channel 0 Population	Cumulative Top Address in Channel 0	Channel 1 Population	Cumulative Top Address in Channel 1
Rank 3	0 MB	2560 MB	0 MB	2560 MB
Rank 2	256 MB	2560 MB	256 MB	2560 MB
Rank 1	512 MB	2048 MB	512 MB	2048 MB
Rank 0	512 MB	1024 MB	512 MB	1024 MB

##### 10.2.1.2.2 Dual Channel Asymmetric Mode with Intel® Flex Memory Mode Enabled

In this addressing mode the lowest DRAM memory is mapped to dual channel operation and the top most DRAM memory is mapped to single channel operation. In this mode the system can run at one zone of dual channel mode and one zone of single channel mode simultaneously across the whole memory array.

This mode is used when Intel® Flex Memory Mode is enabled and both Channel A and Channel B DIMMs are populated in any order with the total amount of memory in each channel being different.



Table 19 is a sample dual channel asymmetric memory configuration showing the rank organization with Intel® Flex Memory Mode Enabled.

**Table 19. Sample System Memory Dual Channel Asymmetric Organization Mode with Intel® Flex Memory Mode Enabled**

Rank	Channel 0 population	Cumulative top address in Channel 0	Channel 1 population	Cumulative top address in Channel 1
Rank 3	0 MB	2048 MB	0 MB	2304 MB
Rank 2	0 MB	2048 MB	256 MB	2304 MB
Rank 1	512 MB	2048 MB	512 MB	2048 MB
Rank 0	512 MB	1024 MB	512 MB	1024 MB

### 10.2.1.2.3 Dual Channel Asymmetric Mode with Intel® Flex Memory Mode Disabled

In this addressing mode addresses start in channel 0 and stay there until the end of the highest rank in channel 0, and then addresses continue from the bottom of channel 1 to the top.

This mode is used when Intel® Flex Memory Mode is disabled and both Channel A and Channel B DIMMs are populated in any order with the total amount of memory in each channel being different.

Table 20 is a sample dual channel asymmetric memory configuration showing the rank organization with Intel® Flex Memory Mode Disabled:

**Table 20. Sample System Memory Dual Channel Asymmetric Organization Mode with Intel® Flex Memory Mode Disabled**

Rank	Channel 0 population	Cumulative top address in Channel 0	Channel 1 population	Cumulative top address in Channel 1
Rank 3	0 MB	1280 MB	0 MB	2304 MB
Rank 2	256 MB	1280 MB	0 MB	2304 MB
Rank 1	512 MB	1024 MB	512 MB	2304 MB
Rank 0	512 MB	512 MB	512 MB	1792 MB

## 10.2.2 System Memory Technology Supported

The MCH supports the following DDR2 Data Transfer Rates, DIMM Modules, and DRAM Device Technologies:

- DDR2 Data Transfer Rates: 667 (PC2-5300) and 800 (PC2-6400)
- DDR2 DIMM Modules:
  - Raw Card C - Single Sided x16 un-buffered non-ECC
  - Raw Card D - Single Sided x8 un-buffered non-ECC
  - Raw Card E - Double Sided x8 un-buffered non-ECC
  - Raw Card F - Single Sided x8 un-buffered ECC
  - Raw Card G - Double Sided x8 un-buffered ECC
- DDR2 DRAM Device Technology: 512-Mb and 1-Gb



Table 21. Supported DIMM Module Configurations

Memory Type	Raw Card Version	DIMM Capacity	DRAM Device Technology	DRAM Organization	# of DRAM Devices	# of Physical Device Ranks	# of Row/Col Address Bits	# of Banks Inside DRAM	Page Size
DDR2 667 and 800	C	256MB	512Mb	32M X 16	4	1	13/10	4	8K
		512MB	1Gb	64M X 16	4	1	13/10	8	8K
	D	512MB	512Mb	64M X 8	8	1	14/10	4	8K
		1GB	1Gb	128M X 8	8	1	14/10	8	8K
	E	1GB	512Mb	64M X 8	16	2	14/10	4	8K
		2GB	1Gb	128M X 8	16	2	14/10	8	8K
	F	512MB	512Mb	64M X 8	9	1	14/10	4	8K
		1GB	1Gb	128M X 8	9	1	14/10	8	8K
	G	1GB	512Mb	64M X 8	18	2	14/10	4	8K
		2GB	1Gb	128M X 8	18	2	14/10	8	8K

### 10.2.3 Error Checking and Correction

Table 22 is used to calculate the syndrome. Numbers in parentheses indicate the data content of that bit position. For example, bit position 36 holds the data originally in data bit 32.

Table 22. Syndrome Bit Values

Syndrome	Byte
1C	0
A2	1
51	2
E	3
94	4
68	5
43	6
F1	7
C1	8
2A	9
15	10
E0	11
49	12
86	13
34	14
1F	15



Table 22. Syndrome Bit Values

Syndrome	Byte
2C	16
A4	17
52	18
D0	19
98	20
61	21
83	22
2F	23
C2	24
4A	25
25	26
D	27
89	28
16	29
38	30
F2	31
4C	32
A8	33
54	34
F8	35
B	36
91	37
62	38
23	39
C4	40
8A	41
45	42
8F	43
B0	44
19	45
26	46
32	47
8C	48
A1	49
58	50
4F	51
70	52
92	53





Table 22. Syndrome Bit Values

Syndrome	Byte
64	54
13	55
C8	56
1A	57
85	58
F4	59
7	60
29	61
46	62
31	63

Every data bit appears in either exactly 3 or exactly 5 check bit and syndrome bit equations. Every check bit appears in exactly 1 syndrome bit equation. This leads to six cases.

1. If the data comes back exactly as it was written, then the calculated check byte will match the stored check byte, and the syndrome will be all 0s.
2. If exactly one check bit is flipped between the time it is written and the time it is read back, then the syndrome will contain exactly one 1. Since the check byte is not returned to the requesting agent, no action is necessary.
3. If exactly one data bit is flipped between the time it is written and the time it is read back, then the syndrome will contain either exactly three 1s or exactly five 1s. The syndrome can then be decoded as a pointer to the bit that flipped using the same check byte generation table in reverse. If the syndrome contains 1s that match the locations of all three or all five Xs in a given row, then that is the bit which should be flipped before the QWord is returned to the requesting agent.
4. If exactly two bits flipped, there will be a nonzero even number of 1s in the syndrome. It cannot be determined which bits flipped based on that syndrome, but a multi-bit error will be recorded along with the address at which the error occurred. In addition, bits 0 and 31 of each DWord are forced to 0 in the returned data in case this read was a TLB fetch. This ensures that the table entry is invalid, such that additional data corruption can be avoided.
5. If an even number of bits greater than two flipped, there will be an even number of 1s in the syndrome, but that even number could be zero, such that detection of this scenario is not ensured. If the syndrome contains a nonzero number of 1s, it cannot be distinguished from scenario 4 above.
6. It is possible for an odd number of bits greater than one to flip between the time the data is written and the time it is read back. This scenario will always be detected, but the resulting syndrome could appear to be a multi-bit error treated similarly to scenario 4, or it could be misinterpreted as a single bit error indistinguishable from scenario 2. The data cannot be corrected, though if it appears to be a single-bit error, the algorithm will flip the bit that corresponds to the syndrome generated, thus an additional bit may be corrupted.

Fortunately, soft error rates are low enough that it is extremely unlikely that there would be more than one soft error in the same QWord, so scenarios 5 and 6 are very rare.

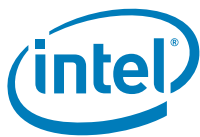

## 10.3 PCI Express\*

See [Section 1.2](#) for a list of PCI Express features, and the PCI Express specification for further details.

This MCH is part of a PCI Express root complex. This means it connects a host processor/memory subsystem to a PCI Express hierarchy. The control registers for this functionality are located in Device 1 and Device 6 configuration space and three Root Complex Register Blocks (RCRBs). The DMI RCRB contains registers for control of the Intel ICH9 attach ports.

### 10.3.1 PCI Express\* Architecture

The PCI Express architecture is specified in layers. Compatibility with the PCI addressing model (a load-store architecture with a flat address space) is maintained to ensure that all existing applications and drivers operate unchanged. The PCI Express configuration uses standard mechanisms as defined in the PCI Plug-and-Play specification. The initial speed of 1.25 GHz (250 MHz internally) results in 2.5 Gb/s each direction, which provides a 250 MB/s communications channel in each direction (500 MB/s total) that is close to twice the data rate of classic PCI per lane. The initial speed of 2.5 GHz results in 5 Gb/s each direction, which provides a 500 MB/s communications channel in each direction (1000 MB/s total).

#### 10.3.1.1 Transaction Layer

The upper layer of the PCI Express architecture is the Transaction Layer. The Transaction Layer's primary responsibility is the assembly and disassembly of Transaction Layer Packets (TLPs). TLPs are used to communicate transactions, such as read and write, as well as certain types of events. The Transaction Layer also manages flow control of TLPs.

#### 10.3.1.2 Data Link Layer

The middle layer in the PCI Express stack, the Data Link Layer, serves as an intermediate stage between the Transaction Layer and the Physical Layer. Responsibilities of Data Link Layer include link management, error detection, and error correction.

#### 10.3.1.3 Physical Layer

The Physical Layer includes all circuitry for interface operation, including driver and input buffers, parallel-to-serial and serial-to-parallel conversion, PLL(s), and impedance matching circuitry.



## 10.4 Thermal Sensor

There are several registers that need to be configured to support the MCH thermal sensor functionality and SMI# generation. Customers must enable the Catastrophic Trip Point as protection for the MCH. If the Catastrophic Trip Point is crossed, then the MCH will instantly turn off all clocks inside the device. Customers may optionally enable the Hot Trip Point to generate SMI#. Customers will be required to then write their own SMI# handler in BIOS that will speed up the MCH (or system) fan to cool the part.

### 10.4.1 PCI Device 0, Function 0

The SMICMD register requires that a bit be set to generate an SMI# when the Hot Trip point is crossed. The ERRSTS register can be inspected for the SMI alert.

Register Name	Register Symbol	Register Start	Register End	Default Value	Access
Error Status	ERRSTS	C8	C9	0000h	RWC/S, RO
SMI Command	SMICMD	CC	CD	0000h	RO, RW

### 10.4.2 MCHBAR Thermal Sensor Registers

The Digital Thermometer Configuration Registers reside in the MCHBAR configuration space.

Register Name	Register Symbol	Register Start	Register End	Default Value	Access
Thermal Sensor Control 1	TSC1	CD8	CD8	00h	RW/L, RW, RS/WC
Thermal Sensor Control 2	TSC2	CD9	CD9	00h	RO, RW/L
Thermal Sensor Status	TSS	CDA	CDA	00h	RO
Thermal Sensor Temperature Trip Point	TSTTP	CDC	CDF	00000000h	RO, RW, RW/L
Thermal Calibration Offset	TCO	CE2	CE2	00h	RW/L/K, RW/L
Hardware Throttle Control	THERM1	CE4	CE4	00h	RW/L, RO, RW/L/K
TCO Fuses	THERM3	CE6	CE6	00h	RO, RS/WC
Thermal Interrupt Status	TIS	CEA	CEB	0000h	RO, RWC
Thermal SMI Command	TSMICMD	CF1	CF1	00h	RO, RW



## 10.5 Power Management

Power Management Feature List:

- ACPI 1.0b support
- ACPI S0, S1, S5, C0, C1, and C2 states
- Enhanced power management state transitions for increasing time processor spends in low power states
- PCI Express Link States: L0, L0s, L2/L3 Ready, L3

## 10.6 Clocking

The MCH has a total of 3 PLLs providing many times that many internal clocks. The PLLs are:

- Host PLL – Generates the main core clocks in the host clock domain. Can also be used to generate memory core clocks. Uses the Host clock (H\_CLKIN) as a reference.
- Memory I/O PLL - Optionally generates low jitter clocks for memory I/O interface, as opposed to from Host PLL. Uses the Host FSB differential clock (HPL\_CLKINP/HPL\_CLKINN) as a reference. Low jitter clock source from memory I/O PLL is required for DDR667 and higher frequencies.
- PCI Express PLL – Generates all PCI Express related clocks, including the Direct Media that connect to the ICH. This PLL uses the 100 MHz clock (EXP\_CLKNP/EXP2\_CLKNP) as a reference.

CK505 is the clocking chip required for the platform.



Figure 11. System Clocking Diagram

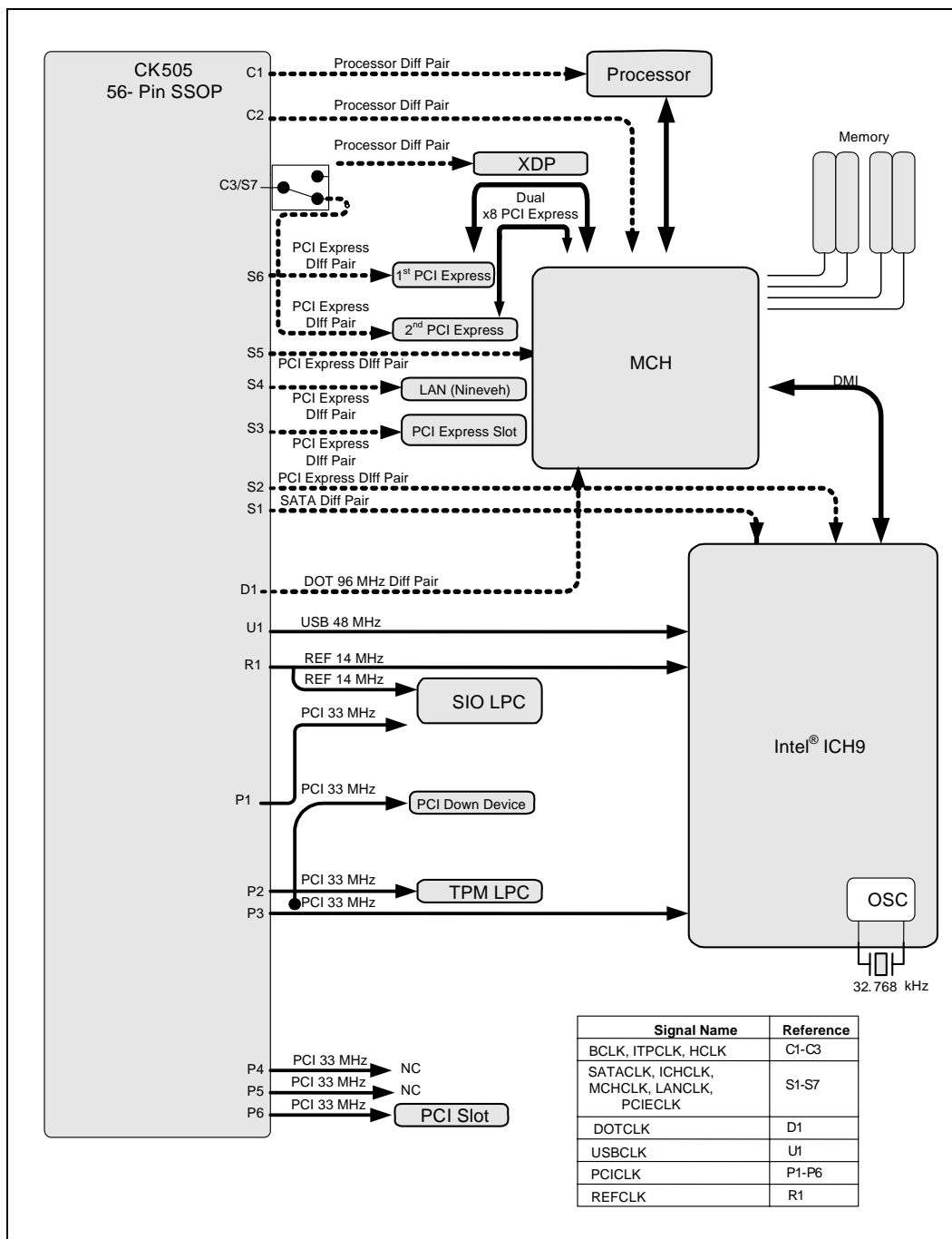

§ §





# 11 Electrical Characteristics

This chapter contains the DC specifications for the MCH.

## 11.1 Absolute Minimum and Maximum Ratings

Table 23 specifies the MCH absolute maximum and minimum ratings. Within functional operation limits, functionality and long-term reliability can be expected.

At conditions outside functional operation condition limits, but within absolute maximum and minimum ratings, neither functionality nor long-term reliability can be expected. If a device is returned to conditions within functional operation limits after having been subjected to conditions outside these limits, but within the absolute maximum and minimum ratings, the device may be functional, but with its lifetime degraded depending on exposure to conditions exceeding the functional operation condition limits.

At conditions exceeding absolute maximum and minimum ratings, neither functionality nor long-term reliability can be expected. Moreover, if a device is subjected to these conditions for any length of time its reliability will be severely degraded or not function when returned to conditions within the functional operating condition limits.

Although the MCH contains protective circuitry to resist damage from static electric discharge, precautions should always be taken to avoid high static voltages or electric fields.

**Table 23. Absolute Minimum and Maximum Ratings**

Symbol	Parameter	Min	Max	Unit	Notes
T <sub>storage</sub>	Storage Temperature	-55	150	°C	1
<b>MCH Core</b>					
VCC	1.25 V Core Supply Voltage with respect to VSS	-0.3	1.375	V	
<b>Host Interface (800/1066/1333 MHz)</b>					
VTT_FSB	System Bus Input Voltage with respect to VSS	-0.3	1.32	V	
VCCA_HPLL	1.25 V Host PLL Analog Supply Voltage with respect to VSS	-0.3	1.375	V	
<b>System Memory Interface (DDR2 667/800 MHz)</b>					
VCC_DDR	1.8 V DDR2 System Memory Supply Voltage with respect to VSS	-0.3	4.0	V	
VCC_CKDDR	1.8 V DDR2 Clock System Memory Supply Voltage with respect to VSS	-0.3	4.0	V	
VCCA_MPLL	1.25 V System Memory PLL Analog Supply Voltage with respect to VSS	-0.3	1.375	V	



Table 23. Absolute Minimum and Maximum Ratings

Symbol	Parameter	Min	Max	Unit	Notes
<b>PCI Express* / DMI Interface</b>					
VCC_EXP	1.25 V PCI Express* and DMI Supply Voltage with respect to VSS	-0.3	1.375	V	
VCCA_EXP	3.3 V PCI Express* Analog Supply Voltage with respect to VSS	-0.3	3.63	V	
VCCAPLL_EXP	1.25 V Primary PCI Express* PLL Analog Supply Voltage with respect to VSS	-0.3	1.375	V	
VCCAPLL_EXP2	1.25 V Secondary PCI Express* PLL Analog Supply Voltage with respect to VSS	-0.3	1.375	V	
<b>Controller Link Interface</b>					
VCC_CL	1.25 V Supply Voltage with respect to VSS	-0.3	1.375	V	
<b>CMOS Interface</b>					
VCC3_3	3.3 V CMOS Supply Voltage with respect to VSS	-0.3	3.63	V	

**NOTE:**

1. Possible damage to the MCH may occur if the MCH temperature exceeds 150 °C. Intel does not ensure functionality for parts that have exceeded temperatures above 150 °C due to specification violation.





## 11.2 Current Consumption

Table 24 shows the current consumption for the MCH in the Advanced Configuration and Power Interface (ACPI) S0 state. Icc max values are determined on a per-interface basis, at the highest frequencies for each interface. Sustained current values or Max current values cannot occur simultaneously on all interfaces. Sustained values are *measured* sustained RMS maximum current consumption and includes leakage estimates. The measurements are made with fast silicon at 96° C Tcase temperature, at the Max voltage listed in Table 26. The Max values are maximum theoretical pre-silicon calculated values. In some cases, the Sustained measured values have exceeded the Max theoretical values.

**Table 24. Current Consumption in S0**

Symbol	Parameter	Signal Names	Sustained	Max	Unit	Notes
I <sub>VCC</sub>	1.25 V Core Supply Current (Discrete Gfx)	VCC	6.06	7.27	A	1,2
I <sub>VCC_DDR2</sub>	DDR2 System Memory Interface (1.8 V) Supply Current	VCC_DDR	2.06	2.57	A	1, 2, 3
I <sub>VCC_CKDDR2</sub>	DDR2 System Memory Clock Interface (1.8 V) Supply Current	VCC_CKDDR	521	581	mA	
I <sub>VCC_EXP</sub>	1.25 V PCI Express* and DMI Supply Current	VCC_EXP	5.12	6.65	A	2
I <sub>VCC_CL</sub>	1.25 V Controller Supply Current	VCC_CL	2.20	2.80	A	2
I <sub>VTT_FSB</sub>	System Bus Supply Current	VTT_FSB	387	580	mA	1
I <sub>VCCA_EXP</sub>	3.3 V PCI Express* and DMI Analog Supply Current	VCCA_EXP	167	175	mA	
I <sub>VCC3_3</sub>	3.3 V CMOS Supply Current	VCC3_3	0.5	16	mA	
I <sub>VCCAPLL_EXP</sub>	1.25 V PCI Express* and DMI PLL Analog Supply Current	VCCAPLL_EXP	48	53	mA	
I <sub>VCCA_HPLL</sub>	1.25 V Host PLL Supply Current	VCCA_HPLL	18	26	mA	
I <sub>VCCA_MPLL</sub>	1.25 V System Memory PLL Analog Supply Current	VCCA_MPLL	97	146	mA	

**NOTES:**

1. Measurements are for current coming through chipset's supply pins.
2. Rail includes DLLs (and FSB sense amps on VCC).
3. Sustained Measurements are combined because one voltage regulator on the platform supplies both rails on the MCH.



## 11.3 Signal Groups

The signal description includes the type of buffer used for the particular signal.

Type	Description
PCI Express*	PCI Express interface signals. These signals are compatible with PCI Express 2.0 Signaling Environment AC Specifications and are AC coupled. The buffers are not 3.3 V tolerant. Differential voltage spec = $( D+ - D- ) * 2 = 1.2V_{max}$ . Single-ended maximum = 1.25 V. Single-ended minimum = 0 V.
DMI	Direct Media Interface signals. These signals are compatible with PCI Express 1.0 Signaling Environment AC Specifications, but are DC coupled. The buffers are not 3.3 V tolerant. Differential voltage spec = $( D+ - D- ) * 2 = 1.2 V_{max}$ . Single-ended maximum = 1.25 V. Single-ended minimum = 0 V.
GTL+	Open Drain GTL+ interface signal. Refer to the GTL+ I/O Specification for complete details.
HCSL	Host Clock Signal Level buffers. Current mode differential pair. Differential typical swing = $( D+ - D- ) * 2 = 1.4 V$ . Single ended input tolerant from -0.35 V to 1.2 V. Typical crossing voltage 0.35 V.
SSTL-1.8	Stub Series Termination Logic. These are 1.8 V output capable buffers. 1.8 V tolerant.
CMOS	CMOS buffers
Analog	Analog reference or output. May be used as a threshold voltage or for buffer compensation.



Table 25. Signal Groups

Signal Type	Signals	Notes
<b>Host Interface Signal Groups</b>		
GTL+ Input/Outputs	FSB_ADSB, FSB_BNRB, FSB_DBSYB, FSB_DINVB_3:0, FSB_DRDYB, FSB_AB_35:3, FSB_ADSTBB_1:0, FSB_DB_63:0, FSB_DSTBPB_3:0, FSB_DSTBNB_3:0, FSB_HITB, FSB_HITMB, FSB_REQB_4:0	
GTL+ Common Clock Outputs	FSB_BPRIB, FSB_BREQOB, FSB_CPURSTB, FSB_DEFERB, FSB_TRDYB, FSB_RSB_2:0	
Analog Host I/F Ref & Comp. Signals	FSB_RCOMP, FSB_SCOMP, FSB_SCOMPB, FSB_SWING, FSB_DVREF, FSB_ACCVREF	
GTL+ Input	FSB_LOCKB, BSEL2:0	
<b>PCI Express* Graphics Interface Signal Groups</b>		
PCI Express* Input	<b>PCI Express* Interface:</b> PEG_RXN_15:0, PEG_RXP_15:0	
PCI Express* Output	<b>PCI Express* Interface:</b> PEG_TXN_15:0, PEG_TXP_15:0	
Analog PCI Express* Compensation Signals	EXP_COMPO, EXP_COMPI	
<b>Direct Media Interface Signal Groups</b>		
DMI Input	DMI_RXP_3:0, DMI_RXN_3:0	
DMI Output	DMI_TXP_3:0, DMI_TXN_3:0	
<b>System Memory Interface Signal Groups</b>		
SSTL-1.8 Input/Output	DDR_A_DQ_63:0, DDR_A_DQS_7:0, DDR_A_DQSB_7:0 DDR_B_DQ_63:0, DDR_B_DQS_7:0, DDR_B_DQSB_7:0 DDR_A_CB_7:0, DDR_A_DQS_8, DDR_A_DQSB_8 DDR_B_CB_7:0, DDR_B_DQS_8, DDR_B_DQSB_8	1
SSTL-1.8 Output	DDR_A_CK_5:0, DDR_A_CKB_5:0, DDR_A_CSB_3:0, DDR_A_CKE_3:0, DDR_A_ODT_3:0, DDR_A_MA_14:0, DDR_A_BS_2:0, DDR_A_RASB, DDR_A_CASB, DDR_A_WEB, DDR_A_DM_7:0 DDR_B_CK_5:0, DDR_B_CKB_5:0, DDR_B_CSB_3:0, DDR_B_CKE_3:0, DDR_B_ODT_3:0, DDR_B_MA_14:0, DDR_B_BS_2:0, DDR_B_RASB, DDR_B_CASB, DDR_B_WEB, DDR_B_DM_7:0	
Reference and Comp. Voltages	DDR_RCOMPXPD, DDR_RCOMPXPU, DDR_RCOMPYPD, DDR_RCOMPYPU, DDR_VREF	
<b>Controller Link Signal Groups</b>		
CMOS I/O OD	CL_DATA, CL_CLK	
CMOS Input	CL_RSTB, CL_PWROK	
Analog Controller Link Reference Voltage	CL_VREF	



Table 25. Signal Groups

Signal Type	Signals	Notes
<b>Clocks</b>		
HCSL	HPL_CLKINP, HPL_CLKINN, EXP_CLKINP, EXP_CLKINN, DPL_REFCLKINN, DPL_REFCLKINP	
<b>Reset, and Miscellaneous Signal Groups</b>		
CMOS Input	EXP_SLR, PWROK, RSTINB	
CMOS Output	ICH_SYNCB	
<b>I/O Buffer Supply Voltages</b>		
System Bus Input Supply Voltage	VTT_FSB	
1.25 V PCI Express* Supply Voltages	VCC_EXP	
3.3 V PCI Express* Analog Supply Voltage	VCCA_EXP	
1.8 V DDR2 Supply Voltage	VCC_DDR	
1.8 V DDR2 Clock Supply Voltage	VCC_CKDDR	
1.25 V MCH Core Supply Voltage	VCC	
1.25 V Controller Supply Voltage	VCC_CL	
3.3 V CMOS Supply Voltage	VCC3_3	
PLL Analog Supply Voltages	VCCA_HPLL, VCCAPLL_EXP, VCCA_MPLL	

**NOTES:**

1. CB\_7:0, DQS[8], and DQSB[8] ECC signals are only for DDR2



## 11.4 Buffer Supply and DC Characteristics

### 11.4.1 I/O Buffer Supply Voltages

The I/O buffer supply voltage is measured at the MCH package pins. The tolerances shown in [Table 26](#) are inclusive of all noise from DC up to 20 MHz. In the lab, the voltage rails should be measured with a bandwidth limited oscilloscope with a roll off of 3 dB/decade above 20 MHz under all operating conditions.

[Table 26](#) indicates which supplies are connected directly to a voltage regulator or to a filtered voltage rail. For voltages that are connected to a filter, they should be measured at the *input* of the filter.

If the recommended platform decoupling guidelines cannot be met, the system designer will have to make tradeoffs between the voltage regulator output DC tolerance and the decoupling performance of the capacitor network to stay within the voltage tolerances listed in [Table 26](#).

**Table 26. I/O Buffer Supply Voltage**

Symbol	Parameter	Min	Nom	Max	Unit	Notes
VCC_DDR	DDR2 I/O Supply Voltage	1.7	1.8	1.9	V	
VCC_CKDDR	DDR2 Clock Supply Voltage	1.7	1.8	1.9	V	1
VCC_EXP	PCI-Express* Supply Voltage	1.188	1.25	1.313	V	
VCCA_EXP	PCI-Express* Analog Supply Voltage	3.135	3.3	3.465	V	1
VTT_FSB	1.2 V System Bus Input Supply Voltage	1.14	1.2	1.26	V	2
	1.1 V System Bus Input Supply Voltage	1.045	1.1	1.155	V	
VCC	MCH Core Supply Voltage	1.188	1.25	1.313	V	
VCC_CL	Controller Supply Voltage	1.188	1.25	1.313	V	
VCC3_3	CMOS Supply Voltage	3.135	3.3	3.465	V	
VCCA_HPLL, VCCAPLL_EXP, VCCA_MPLL	Various PLL Analog Supply Voltages	1.188	1.25	1.313	V	1

**NOTES:**

1. These rails are filtered from other voltage rails on the platform and should be measured at the input of the filter.
2. MCH supports both  $V_{TT} = 1.2$  V nominal and  $V_{TT} = 1.1$  V nominal depending on the identified processor.



### 11.4.2 General DC Characteristics

Platform Reference Voltages at the top of Table 27 are specified at DC only.  $V_{REF}$  measurements should be made with respect to the supply voltage.

Table 27. DC Characteristics

Symbol	Parameter	Min	Nom	Max	Unit	Notes
<b>Reference Voltages</b>						
FSB_DVREF FSB_ACCVREF	Host Data, Address, and Common Clock Signal Reference Voltages	$0.666 \times V_{TT\_FSB} - 2\%$	$0.666 \times V_{TT\_FSB}$	$0.666 \times V_{TT\_FSB} + 2\%$	V	
FSB_SWING	Host Compensation Reference Voltage	$0.25 \times V_{TT\_FSB} - 2\%$	$0.25 \times V_{TT\_FSB}$	$0.25 \times V_{TT\_FSB} + 2\%$	V	
CL_VREF	Controller Link Reference Voltage	$0.270 \times V_{CC\_CL}$	$0.279 \times V_{CC\_CL}$	$0.287 \times V_{CC\_CL}$	V	
DDR_VREF	DDR2 Reference Voltage	$0.49 \times V_{CC\_DDR}$	$0.50 \times V_{CC\_DDR}$	$0.51 \times V_{CC\_DDR}$	V	
<b>Host Interface</b>						
$V_{IL\_H}$	Host GTL+ Input Low Voltage	-0.10	0	$(0.666 \times V_{TT\_FSB}) - 0.1$	V	
$V_{IH\_H}$	Host GTL+ Input High Voltage	$(0.666 \times V_{TT\_FSB}) + 0.1$	$V_{TT\_FSB}$	$V_{TT\_FSB} + 0.1$	V	
$V_{OL\_H}$	Host GTL+ Output Low Voltage	—	—	$(0.25 \times V_{TT\_FSB}) + 0.1$	V	
$V_{OH\_H}$	Host GTL+ Output High Voltage	$V_{TT\_FSB} - 0.1$	—	$V_{TT\_FSB}$	V	
$I_{OL\_H}$	Host GTL+ Output Low Current	—	—	$V_{TT\_FSBmax} * (1 - 0.25) / R_{ttmin}$	mA	$R_{ttmin} = 47.5 \Omega$
$I_{LEAK\_H}$	Host GTL+ Input Leakage Current	—	—	45	$\mu A$	$V_{OL} < V_{pad} < V_{tt\_FSB}$
$C_{PAD}$	Host GTL+ Input Capacitance	2.0	—	2.5	pF	
$C_{PCKG}$	Host GTL+ Input Capacitance (common clock)	0.90	—	2.5	pF	
<b>DDR2 System Memory Interface</b>						
$V_{IL(DC)}$	DDR2 Input Low Voltage	—	—	$DDR\_VREF - 0.125$	V	
$V_{IH(DC)}$	DDR2 Input High Voltage	$DDR\_VREF + 0.125$	—	—	V	
$V_{IL(AC)}$	DDR2 Input Low Voltage	—	—	$DDR\_VREF - 0.20$	V	
$V_{IH(AC)}$	DDR2 Input High Voltage	$DDR\_VREF + 0.20$	—	—	V	
$V_{OL}$	DDR2 Output Low Voltage	—	—	$0.2 * V_{CC\_DDR}$	V	1
$V_{OH}$	DDR2 Output High Voltage	$0.8 * V_{CC\_DDR}$	—	—	V	1
$I_{Leak}$	Input Leakage Current	—	—	$\pm 20$	$\mu A$	4
$I_{Leak}$	Input Leakage Current	—	—	$\pm 550$	$\mu A$	5



Table 27. DC Characteristics

Symbol	Parameter	Min	Nom	Max	Unit	Notes
$C_{I/O}$	DQ/DQS/DQSB DDR2 Input/Output Pin Capacitance	1.0	—	4.0	pF	
<b>1.25V PCI Express* Interface 2.0</b>						
$V_{TX-DIFF\ P-P}$	Differential Peak to Peak Output Voltage	0.800	—	1.2	V	2
$V_{TX\_CM-ACp}$	AC Peak Common Mode Output Voltage	—	—	20	mV	
$Z_{TX-DIFF-DC}$	DC Differential TX Impedance	80	100	120		
$V_{RX-DIFF\ P-P}$	Differential Peak to Peak Input Voltage	0.175	—	1.2	V	3
$V_{RX\_CM-ACp}$	AC Peak Common Mode Input Voltage	—	—	150	mV	
<b>Input Clocks</b>						
$V_{IL}$	Input Low Voltage	-0.150	0	N/A	V	
$V_{IH}$	Input High Voltage	0.660	0.710	0.850	V	
$V_{CROSS(ABS)}$	Absolute Crossing Voltage	0.300	N/A	0.550	V	6,7,8
$V_{CROSS(REL)}$	Range of Crossing Points	N/A	N/A	0.140	V	
$C_{IN}$	Input Capacitance	1	—	3	pF	
<b>CL_DATA, CL_CLK</b>						
$V_{IL}$	Input Low Voltage	—	—	0.277	V	
$V_{IH}$	Input High Voltage	0.427	—	—	V	
$I_{LEAK}$	Input Leakage Current	—	—	±20	μA	
$C_{IN}$	Input Capacitance	—	—	1.5	pF	
$I_{OL}$	Output Low Current (CMOS Outputs)	—	—	1.0	mA	@ $V_{OL\_HI\ max}$
$I_{OH}$	Output High Current (CMOS Outputs)	6.0	—	—	mA	@ $V_{OH\_HI\ min}$
$V_{OL}$	Output Low Voltage (CMOS Outputs)	—	—	0.06	V	
$V_{OH}$	Output High Voltage (CMOS Outputs)	0.6	—	—	V	
<b>PWROK, CL_PWROK, RSTIN#</b>						
$V_{IL}$	Input Low Voltage	—	—	0.3	V	
$V_{IH}$	Input High Voltage	2.7	—	—	V	
$I_{LEAK}$	Input Leakage Current	—	—	±1	mA	
$C_{IN}$	Input Capacitance	—	—	6.0	pF	
<b>CL_RST#</b>						
$V_{IL}$	Input Low Voltage	—	—	0.13	V	
$V_{IH}$	Input High Voltage	1.17	—	—	V	
$I_{LEAK}$	Input Leakage Current	—	—	±20	μA	
$C_{IN}$	Input Capacitance	—	—	5.0	pF	
<b>ICH_SYNCB</b>						
$I_{OL}$	Output Low Current (CMOS Outputs)	—	—	2.0	mA	@ $V_{OL\_HI\ max}$



Table 27. DC Characteristics

Symbol	Parameter	Min	Nom	Max	Unit	Notes
I <sub>OH</sub>	Output High Current (CMOS Outputs)	-2.0	—	—	mA	@V <sub>OH_HI</sub> min
V <sub>OL</sub>	Output Low Voltage (CMOS Outputs)	—	—	0.33	V	
V <sub>OH</sub>	Output High Voltage (CMOS Outputs)	2.97	—	—	V	
<b>EXP_SLR, EXP_EN</b>						
V <sub>IL</sub>	Input Low Voltage	-0.10	0	(0.63 x V <sub>TT</sub> ) – 0.1	V	
V <sub>IH</sub>	Input High Voltage	(0.63 x V <sub>TT</sub> ) + 0.1	V <sub>TT</sub>	V <sub>TT</sub> + 0.1	V	
I <sub>LEAK</sub>	Input Leakage Current	—	—	20	μA	V <sub>OL</sub> < V <sub>pad</sub> < V <sub>tt</sub>
C <sub>IN</sub>	Input Capacitance	2	—	2.5	pF	

**NOTES:**

1. Determined with 2x MCH Buffer Strength Settings into a 50 Ω to 0.5xV<sub>CC\_DDR</sub> test load.
2. Specified at the measurement point into a timing and voltage compliance test load as shown in Transmitter compliance eye diagram of PCI Express\* specification and measured over any 250 consecutive TX UIs.
3. Specified at the measurement point over any 250 consecutive UIs. The test load shown in Receiver compliance eye diagram of PCI Express\* spec should be used as the RX device when taking measurements.
4. Applies to pin to VCC or VSS leakage current for the DDR\_A\_DQ\_63:0 and DDR\_B\_DQ\_63:0 signals.
5. Applies to pin to pin leakage current between DDR\_A\_DQS\_7:0, DDR\_A\_DQSB\_7:0, DDR\_B\_DQS\_7:0, and DDR\_B\_DQSB\_7:0 signals.
6. Crossing voltage defined as instantaneous voltage when rising edge of BCLK0 equals falling edge of BCLK1.
7. V<sub>Havg</sub> is the statistical average of the V<sub>H</sub> measured by the oscilloscope.
8. The crossing point must meet the absolute and relative crossing point specifications simultaneously. Refer to the appropriate processor datasheet for further information.







# 12 *Ballout and Package Information*

---

This chapter provides the ballout and package dimensions for the MCH.

## 12.1 Ballout Information

Figure 12, Figure 13, and Figure 14 provide the MCH ballout as viewed from the top side of the package. Table 28 provides a ballout list arranged alphabetically by signal name. Table 29 provides a ballout list arranged numerically by ball number.

**Note:** Notes for Figure 12, Figure 13, Figure 14, Table 28 and Table 29.

1. Balls that are listed as RSVD are reserved.
2. Some balls marked as reserved (RSVD) are used in XOR testing. See Chapter 13 for details.
3. Balls that are listed as NC are No Connects.
4. PEG2\_RXN\_[15:0], PEG2\_RXP\_[15:0], PEG2\_TXN\_[15:0], PEG2\_TXP\_[15:0], EXP2\_COMPO, and EXP2\_COMPI are NCs on the Intel 3200 MCH.

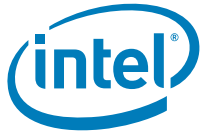

Figure 12. MCH Ballout Diagram (Top View Left – Columns 45–31)

	45	44	43	42	41	40	39	38	37	36	35	34	33	32	31	
BE	TEST0	VCC_CKDDR	VCC_CKDDR			VCC_DDR		VSS		VCC_DDR		VSS		VCC_DDR		BE
BD	NC	VCC_CKDDR	VCC_CKDDR	DDR_A_CSB_1			DDR_A_WE_B		DDR_A_MA_10		RSVD		DDR_B_ODT_0		DDR_B_RAS_B	BD
BC	VCC_CKDDR	VCC_CKDDR	VSS	DDR_RCOM_PYPD		RSVD		VCC_DDR	DDR_A_BS_0	DDR_A_MA_0		VCC_DDR		DDR_B_CSB_2		BC
BB		RSVD	DDR_A_ODT_0	DDR_RCOM_PYPU	DDR_A_CAS_B		DDR_A_CSB_2	DDR_A_RAS		DDR_A_BS_1	DDR_B_CSB_1	DDR_B_ODT_1	DDR_B_ODT_2	DDR_B_CAS_B	DDR_A_MA_1	BB
BA			DDR_A_MA_13	DDR_A_ODT_13	DDR_A_ODT_2	DDR_A_CSB_0			RSVD		DDR_B_CSB_3		DDR_B_MA_13		DDR_B_CSB_0	BA
AY	VCC_DDR		DDR_A_CSB_3		DDR_A_ODT_1	DDR_B_DM_4	DDR_B_DO_32	DDR_B_DO_36		VSS	DDR_B_ODT_3	DDR_B_CKB_5	VSS		DDR_B_WE_B	AY
AW		DDR_A_ODT_3		DDR_A_DO_36		VSS	DDR_B_DO_34	DDR_B_DO_33		DDR_B_DO_37	VSS	DDR_B_CKB_5	DDR_B_CKB_2		VSS	AW
AV	VSS		VSS	DDR_A_DO_32		DDR_B_DO_39	DDR_B_DO_38	DDR_B_DO_38		DDR_B_DO_44	DDR_A_CKB_2	VSS	DDR_B_CKB_2		DDR_A_CK_3	AV
AU		DDR_A_DM_4	DDR_A_DO_33		DDR_A_DO_37											AU
AT	VSS		DDR_A_DO_34	DDR_A_DO_SB_4		DDR_B_DO_35	VSS	DDR_B_DO_34		DDR_A_CKB_5	DDR_A_CK_5	DDR_A_CK_2	DDR_A_CK_0		DDR_A_CKB_3	AT
AR		DDR_A_DO_34		DDR_A_DO_35	DDR_A_DO_38	DDR_A_DO_39	VSS	VSS		DDR_B_DO_40	VSS	DDR_B_DO_45	DDR_A_CKB_0		DDR_B_CK_3	AR
AP	DDR_A_DO_45		VSS	DDR_A_DO_44	DDR_B_DO_SB_5	DDR_B_DO_SB_5	DDR_B_DO_46	VSS		DDR_B_DO_41	DDR_B_DO_42	RSVD	VSS		DDR_B_CKB_3	AP
AN		DDR_A_DM_5		DDR_A_DO_41	DDR_A_DO_40	DDR_A_DO_47	DDR_B_DO_46	VSS		DDR_B_DM_5	DDR_A_CB_1	VSS	DDR_B_DO_43		RSVD	AN
AM	VSS		DDR_A_DO_SB_5	DDR_A_DO_SB_5										RSVD		AM
AL		DDR_A_DO_42		DDR_A_DO_43	DDR_A_DO_47	DDR_A_DO_46	VSS	DDR_A_DO_SB_8		DDR_A_DO_SB_8	VSS	DDR_A_CB_5	DDR_A_CB_0			AL
AK	DDR_B_CB_0		VSS	DDR_B_CB_5		VSS	DDR_A_CB_7	DDR_A_CB_2		VSS	DDR_A_CB_3	DDR_A_CB_6	DDR_A_CB_4	VSS	VCC_CL	AK
AJ		DDR_B_CB_1		DDR_B_CB_4	VSS											AJ
AH	VSS		DDR_B_DO_SB_8	DDR_B_DO_SB_8		VSS	VSS	VSS		DDR_B_DO_53	VSS	DDR_B_DO_48	DDR_B_DO_52	VSS	VCC_CL	AH
AG		DDR_B_CB_7		DDR_B_CB_2	DDR_B_CB_6	DDR_B_CB_3	DDR_B_DO_SB_6	DDR_B_DO_SB_6		VSS	DDR_B_DM_6	VSS	DDR_B_DO_49	RSVD	VCC_CL	AG
AF	DDR_A_DO_53		VSS	DDR_A_DO_52												AF
AE		DDR_A_DM_6		DDR_A_DO_49	DDR_A_DO_48	DDR_B_DO_54	DDR_B_DO_50	DDR_B_DO_51		VSS	DDR_B_DO_60	DDR_B_DO_61	DDR_B_DO_55	VSS	VCC_CL	AE
AD	VSS		DDR_A_DO_SB_6	DDR_A_DO_SB_6		DDR_A_DO_54	DDR_B_DO_56	VSS		DDR_B_DO_57	DDR_B_DM_7	VSS	DDR_B_DO_SB_7	RSVD	VCC_CL	AD
AC	DDR_A_DO_51		VSS	DDR_A_DO_50		DDR_A_DO_60	DDR_A_DO_55	VSS		DDR_B_DO_62	VSS	DDR_B_DO_63	DDR_B_DO_57	VSS	VCC_CL	AC
AB	VSS		DDR_A_DO_57	DDR_A_DO_56		DDR_A_DM_7	DDR_A_DO_61	DDR_B_DO_59		VSS	FSB_AB_34	FSB_AB_29	VSS	DDR_B_DO_58	VCC_CL	AB
AA		DDR_A_DO_SB_7		DDR_A_DO_SB_7	DDR_A_DO_62	FSB_AB_33	VSS	FSB_AB_35		VSS	FSB_AB_32	VSS	FSB_AB_31	VSS	VCC_CL	AA
Y	DDR_A_DO_63		VSS	DDR_A_DO_58												Y
W		FSB_BREQ0_B		DDR_A_DO_59	FSB_RSB_1	FSB_TRDYB	VSS	FSB_AB_22		FSB_AB_30	VSS	FSB_AB_25	FSB_AB_27	RSVD	VSS_W31	W
V	VSS		FSB_AB_28	FSB_HITMB		VSS	FSB_AB_24	FSB_AB_23		VSS	FSB_AB_26	FSB_ADSTB_B_1	VSS	RSVD	VCC_CL	V
U		FSB_ADSB		FSB_BNRB	FSB_DRDYB											U
T	FSB_LOCKB		VSS	FSB_DBSYB		FSB_AB_17	FSB_DEFER_B	FSB_AB_20		FSB_AB_18	VSS	FSB_AB_19	RSVD	VSS	VCC_AUX	T
R		FSB_RSB_0		FSB_HITB	FSB_RSB_2	VSS	FSB_AB_14	VSS		FSB_AB_10	FSB_AB_16	VSS	RSVD			R
P	VSS		FSB_AB_21	FSB_DB_0											VSS	P
N		FSB_DB_2		FSB_DB_4	FSB_DB_1	FSB_AB_9	FSB_AB_11	FSB_AB_13		FSB_AB_8	VSS	FSB_AB_12	FSB_DB_28		FSB_DB_30	N
M	FSB_DB_5		VSS	FSB_DB_3		FSB_ADSTB_B_0	VSS	FSB_AB_4		FSB_AB_5	VSS	VSS	VSS		FSB_DB_31	M
L		FSB_DB_6		FSB_DB_7	FSB_DINVB_0	FSB_AB_7	FSB_REQB_2	VSS		FSB_DB_19	VSS	FSB_DB_27	FSB_DB_29		VSS	L
K	VSS		FSB_DSTBN_B_0	FSB_AB_15		VSS	VSS	FSB_AB_6		FSB_REQB_3	FSB_DB_21	FSB_DB_24	VSS		FSB_DB_33	K
J		FSB_DSTBP_B_0	FSB_DB_8		FSB_DB_10											J
H	FSB_DB_12		VSS	FSB_DB_9		VSS	FSB_REQB_4	FSB_BPRIB		VSS	VSS	FSB_DSTBP_B_1	FSB_DB_25		FSB_DB_34	H
G		FSB_DB_13		FSB_DB_11		FSB_REQB_1	VSS	FSB_DB_20		FSB_DB_22	FSB_DB_23	FSB_DSTBN_B_1	VSS		VSS	G
F	VSS		FSB_AB_3		FSB_DB_14	VSS	FSB_AB_17	FSB_DB_16		VSS	FSB_DB_48	VSS	FSB_DB_26		FSB_DB_32	F
E				FSB_DB_15	FSB_DB_50	FSB_DINVB_1			FSB_DB_61		FSB_DB_63		VTT_FSB		VTT_FSB	E
D		FSB_DB_52	FSB_DB_53	VSS	FSB_DSTBN_B_3		FSB_DB_57	FSB_DB_54		FSB_DB_59	FSB_CPURS_TB	VSS	VTT_FSB	VTT_FSB	VTT_FSB	D
C	VSS	FSB_RECB_0	VSS	FSB_DB_51		FSB_DSTBP_B_3		VSS	FSB_DB_60	FSB_DB_58		VSS		VTT_FSB		C
B	NC	VSS	FSB_DB_18	FSB_DB_55			FSB_DB_56		FSB_DINVB_3		FSB_DB_62		VTT_FSB		VTT_FSB	B
A	TEST3	NC	VSS			VSS		FSB_DB_49		VSS		VSS		VTT_FSB		A

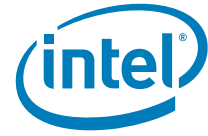

Figure 13. MCH Ballout Diagram (Top View Middle – Columns 30–16)

	30	29	28	27	26	25	24	23	22	21	20	19	18	17	16		
BE	VSS		VCC_DDR		VSS		VCC_DDR	VSS	VCC_DDR		DDR_B_MA_8		VSS		DDR_A_DO_19	BE	
BD		DDR_A_MA_6		DDR_A_MA_11		DDR_A_CKE_0				DDR_B_MA_4		DDR_B_CKE_1		DDR_B_CKE_0		BD	
BC	VCC_DDR		DDR_A_MA_8		VCC_DDR		DDR_A_CKE_1	VCC_DDR	DDR_B_MA_1		VCC_DDR		DDR_B_MA_14		VSS	BC	
BB	DDR_A_MA_2	DDR_A_MA_3	DDR_A_MA_5	DDR_A_MA_12	DDR_A_BS_2	DDR_A_CKE_2	DDR_B_BS_0	RSVD	DDR_B_MA_2	DDR_B_MA_5	DDR_B_MA_6	DDR_B_MA_9	DDR_B_MA_2	DDR_B_CKE_2	DDR_A_DO_18	BB	
BA		DDR_A_MA_4		DDR_A_MA_9		DDR_A_MA_14				DDR_B_MA_3		DDR_B_MA_11		DDR_B_CKE_3		BA	
AY	DDR_B_CK_4		DDR_B_CKB_4	DDR_A_MA_7		DDR_B_DM_3	DDR_A_CKE_1	VCC_DDR	DDR_B_MA_0	DDR_A_DO_25		DDR_B_MA_7	DDR_B_MA_12		DDR_B_DO_16	AY	
AW	DDR_B_CK_0		VSS	VSS		DDR_B_DO_24	DDR_B_MA_10	DDR_B_BS_1	DDR_A_DO_31	VSS		DDR_A_DO_29	VSS		DDR_B_DM_2	AW	
AV	DDR_B_CKB_0		VSS	DDR_B_DO_27		DDR_B_DO_25	VSS	VSS	VSS	DDR_A_DO_SB_3		DDR_A_DO_28	VSS		DDR_B_DO_17	AV	
AU																AU	
AT	VSS		VSS	DDR_B_DO_26		DDR_B_DO_30	VSS	VSS	DDR_A_DO_27	DDR_A_DO_S_3		DDR_B_DO_19	DDR_B_DO_22		VSS	AT	
AR	VSS		DDR_B_CK_1	VSS		DDR_B_DO_S_3	DDR_B_DO_SB_3	VSS	VSS	VSS		VSS	DDR_B_DO_23		DDR_B_DO_21	AR	
AP	VSS		DDR_B_CKB_1	DDR_B_DO_31		VSS	DDR_B_DO_29	VSS	VSS	DDR_A_DM_3		DDR_B_DO_18	VSS		DDR_B_DO_SB_2	AP	
AN	RSVD		DDR_A_CK_1	DDR_A_CK_4		RSVD	DDR_B_DO_28	VSS	DDR_A_DO_26	DDR_A_DO_30		DDR_A_DO_24	DDR_B_DO_S_2		DDR_B_DO_20	AN	
AM	VCC_CL		DDR_A_CKB_1	DDR_A_CKB_4		RSVD	VSS	VCC_CL	VCC_CL	VSS		PWROK	RSTINB		VSS	AM	
AL	VCC_CL		RSVD	VCC_CL		VCC_CL	VCC_CL	VCC_CL	VCC_CL	VCC_CL		VCC_CL	VCC_CL		VCC_CL	AL	
AK																AK	
AJ		VCC_CL	VCC_CL	VCC_CL	VCC_CL	VCC_CL	VCC_CL	VCC_CL	VCC_CL	VCC_CL	VCC_CL	VCC_CL	VCC_CL	VCC_CL	VCC_CL	AJ	
AH		VCC_CL	RSVD	VSS	VCC	VSS	VCC	VSS	VCC	VSS	VCC	VCC	VCC	VCC	VCC	AH	
AG		VCC_CL	RSVD	VCC	VSS	VCC	VSS	VCC	VSS	VCC	VSS	VCC	VCC	VCC	VCC	AG	
AF		VCC_CL	VCC	VSS	VCC	VSS	VCC	VSS	VCC	VSS	VCC	VSS	VCC	VCC	VCC	AF	
AE		VCC_CL	VCC	VCC	VSS	VCC	VSS	VCC	VSS	VCC	VSS	VCC	VCC	VCC	VCC	AE	
AD		VCC_CL	VCC	VSS	VCC	VSS	VCC	VSS	VCC	VSS	VCC	VSS	VCC	VCC	VCC	AD	
AC		VCC_CL	VCC	VCC	VSS	VCC	VSS	VCC	VSS	VCC	VSS	VCC	VCC	VCC	VCC	AC	
AB		VCC_CL	VCC	VSS	VCC	VSS	VCC	VSS	VCC	VSS	VCC	VSS	VCC	VCC	VCC	AB	
AA		VCC_CL	VCC	VCC	VSS	VCC	VSS	VCC	VSS	VCC	VSS	VCC	VCC	VCC	VCC	AA	
Y		VCC_CL	VCC	VSS	VCC	VSS	VCC	VSS	VCC	VSS	VCC	VSS	VCC	VCC	VCC	Y	
W		VCC_CL	VCC	VCC	VSS	VCC	VSS	VCC	VSS	VCC	VSS	VCC	VCC	VCC	VCC	W	
V		VCC_CL	VCC	VSS	VCC	VSS	VCC	VSS	VCC	VSS	VCC	VSS	VCC	VCC	VCC	V	
U		VCCAUX	VCC	VCC	VCC	VCC	VCC	VCC	VCC	VCC	VCC	VCC	VCC	VCC	VCC	U	
T																T	
R		VCCAUX	VCCAUX	VCCAUX		VCCAUX	VCCAUX	VCCAUX	RSVD	VSS		RSVD	VCC		VCC	R	
P		HPL_CLKIN_N		HPL_CLKINP	VSS	VSS	VSS	VSS	VSS	RSVD		RSVD_P19	VSS		ICH_SYNCB	P	
N		FSB_DB_37		FSB_DINVB_2	VSS		FSB_DSTBP_B_2	FSB_DB_42	VSS	VSS	RSVD		VSS	RSVD	VSS	N	
M		FSB_DB_35		VSS	VTT_FSB		FSB_DSTBN_B_2	VSS	VSS	BSEL0	ALLZTEST		RSVD_M19	VSS	RSVD	M	
L		FSB_DB_36		FSB_DB_41	VTT_FSB		FSB_DB_43	FSB_DB_44	VSS	XORTEST	VSS		RSVD	RSVD	VCC3_3_L1_6	L	
K		VSS		FSB_DB_40	VTT_FSB		VTT_FSB	FSB_DB_46	VSS	RSVD	RSVD		EXP_SLR	VSS	RSVD_K16	K	
J																J	
H		FSB_DB_39		VTT_FSB	VTT_FSB		VTT_FSB	FSB_DB_45	VSS	VSS	RSVD		VSS	VSS	RSVD_H16	H	
G		FSB_DB_38		VTT_FSB	VTT_FSB		VTT_FSB	FSB_DB_47	VSS	RSVD	TCEN		RSVD	VSS	VCC3_3_G1_6	G	
F		VTT_FSB		VTT_FSB	VTT_FSB		VTT_FSB	VSS	VSS	VSS_F22	BSEL1		RSVD	BSEL2	VSS	F	
E		VTT_FSB		FSB_DVREF			VCC_E25				VSS		VSS		PEG_TXN_0	E	
D		VTT_FSB	VSS	FSB_SCOMP	FSB_ACCVREF	VCCA_HPL	VCCA_HPL	VSS_D24	VSS	VSS_D22	VSS_D21	VCCA_EXP	EXP_CLKINP	EXP_CLKIN_N	VSS	PEG_TXP_0	D
C		VSS		FSB_SCOMP_B		FSB_RCOMP		VSS_C24	VSS_C23	VSS		VSS		VCC_C18	VCCR_EXP	C	
B		VSS		VCCA_MPL			VCC_B25				VSS_B21		RSVD		VSS_B17	B	
A		VTT_FSB		FSB_SWING			VSS	VSS_A24	VCC3_3	VSS		VCCAPLL_EXP		VSS	PEG_RXP_0	A	
	30	29	28	27	26	25	24	23	22	21	20	19	18	17	16		



Figure 14. MCH Ballout Diagram (Top View Left – Columns 15–1)

	15	14	13	12	11	10	9	8	7	6	5	4	3	2	1	
BE		VSS		DDR_A_DO_11		VSS		DDR_A_DO_3		VSS			VSS	NC	TEST1	BE
BD	DDR_A_DO_22		DDR_A_DO_16		DDR_A_DO_14		DDR_A_DO_8		DDR_A_DO_6			DDR_A_DO_1	DDR_A_DO_4	VSS	NC	BD
BC		DDR_A_DM_2		VSS		DDR_A_DM_1	DDR_A_DO_13	VSS		DDR_A_DO_SB_0		DDR_A_DO_0	VSS	RSVD	VSS	BC
BB	DDR_A_DO_23	DDR_A_DO_17	DDR_A_DO_21	DDR_A_DO_10	DDR_A_DO_15	DDR_A_DO_9		DDR_A_DO_2	DDR_A_DO_7		DDR_A_DM_0	DDR_A_DO_5	VSS_BB3	VSS		BB
BA	DDR_A_DO_SB_2		DDR_A_DO_20		DDR_A_DO_SB_1			DDR_A_DO_12			DDR_A_DO_SB_0	VSS_BA5	VSS_BA4			BA
AY	DDR_A_DO_SB_2		DDR_B_DO_9	DDR_B_DO_8	DDR_A_DO_SB_1	VSS		DDR_B_DM_0	DDR_B_DO_1	DDR_RCOM_PXPD	DDR_RCOM_PXPU		VSS_AY3		VSS_AY1	AY
AW	VSS		DDR_B_DO_13	DDR_B_DO_12	DDR_B_DO_7	DDR_B_DO_5		DDR_B_DO_0	VSS	DDR_B_DO_5			VSS		VSS_AW2	AW
AV	DDR_B_DO_11		VSS	VSS	VSS	VSS		DDR_B_DO_4	DDR_VREF	VSS			VSS	VSS		AV
AU											VCCA_EXP2		VSS	PEG2_TXP_14 (Note 4)		AU
AT	DDR_B_DO_10		DDR_B_DM_1	DDR_B_DO_3	DDR_B_DO_2	DDR_B_DO_SB_0		VSS	DDR_RCOM_PVOL	DDR_RCOM_PVOH			PEG2_TXP_13 (Note 4)	PEG2_TXN_14 (Note 4)	VSS	AT
AR	VSS		DDR_B_DO_SB_1	DDR_B_DO_6	DDR_B_DO_6	VCCAPLL_EXP2		VSS	VSS	VSS	PEG2_TXN_13 (Note 4)	VSS		PEG2_TXP_12 (Note 4)		AR
AP	DDR_B_DO_15		VSS	RSVD	PEG2_RXN_15 (Note 4)	PEG2_RXP_15 (Note 4)		VSS	PEG2_TXP_15 (Note 4)	PEG2_TXN_15 (Note 4)		PEG2_TXP_11 (Note 4)	VSS	VCCR_EXP	PEG2_TXN_12 (Note 4)	AP
AN	DDR_B_DO_14		RSVD	RSVD	RSVD	EXP2_COMP1 (Note 4)		EXP2_COMP0 (Note 4)	VSS	VSS	PEG2_TXN_11 (Note 4)	VSS		PEG2_TXP_10 (Note 4)	PEG2_TXN_10 (Note 4)	AN
AM		RSVD										PEG2_TXP_9 (Note 4)	PEG2_TXN_10 (Note 4)		VSS	AM
AL			CL_PWROK	VSS	PEG2_RXP_13 (Note 4)	PEG2_RXN_13 (Note 4)		VSS	PEG2_RXN_14 (Note 4)	PEG2_RXP_14 (Note 4)	PEG2_TXN_9 (Note 4)	VSS		PEG2_TXP_8 (Note 4)		AL
AK	CL_DATA	CL_CLK	PEG2_RXN_12 (Note 4)	PEG2_RXP_12 (Note 4)	VSS	VSS		VSS	VSS	VSS			PEG2_TXP_7 (Note 4)	VCCR_EXP		AK
AJ											PEG2_TXN_7 (Note 4)	VSS		PEG2_TXP_6 (Note 4)		AJ
AH	VCC_CL	VCC_CL	PEG2_RXN_9 (Note 4)	VSS	PEG2_RXP_10 (Note 4)	PEG2_RXN_10 (Note 4)		VSS	PEG2_RXP_11 (Note 4)	PEG2_RXN_11 (Note 4)		PEG2_TXP_5 (Note 4)	PEG2_TXN_6 (Note 4)		VSS	AH
AG	VCC	CL_VREF	VSS	PEG2_RXP_9 (Note 4)	CL_RSTB	VSS		VSS	VSS	VSS	PEG2_TXN_5 (Note 4)	VSS		PEG2_TXP_4 (Note 4)		AG
AF												PEG2_TXP_3 (Note 4)	VCCR_EXP		PEG2_TXN_4 (Note 4)	AF
AE	VCCR_EXP	EXP2_CLKIN_P	PEG2_RXP_6 (Note 4)	VSS	PEG2_RXN_7 (Note 4)	PEG2_RXP_7 (Note 4)		VSS	PEG2_RXP_8 (Note 4)	PEG2_RXN_8 (Note 4)	PEG2_TXN_3 (Note 4)	VSS		PEG2_TXP_2 (Note 4)		AE
AD	VCCR_EXP	EXP2_CLKIN_N	VSS	PEG2_RXN_6 (Note 4)	VCC_EXP	VCC_EXP		VCC_EXP	VCC_EXP	VSS		PEG2_TXP_1 (Note 4)	PEG2_TXN_2 (Note 4)		VSS	AD
AC	VCCR_EXP	VSS	PEG2_RXP_3 (Note 4)	VSS	PEG2_RXP_4 (Note 4)	PEG2_RXN_4 (Note 4)		VSS	PEG2_RXN_5 (Note 4)	PEG2_RXP_5 (Note 4)		PEG2_TXN_1 (Note 4)	VCCR_EXP		VSS	AC
AB	VCC	VCCR_EXP	VCC_EXT_PLL	PEG2_RXN_3 (Note 4)	VCC_EXP	VCC_EXP		VCC_EXP	VCC_EXP	VCC_EXP		VCC_EXP	PEG2_TXP_0 (Note 4)		PEG2_TXN_0 (Note 4)	AB
AA	VCCR_EXP	VCCR_EXP	PEG2_RXN_0 (Note 4)	VSS	PEG2_RXN_1 (Note 4)	PEG2_RXP_1 (Note 4)		VSS	PEG2_RXN_2 (Note 4)	PEG2_RXP_2 (Note 4)	VCC_EXP	VCC_EXP		VCC_EXP		AA
Y												VCC_EXP	VCC_EXP		VCC_EXP	Y
W	VCCR_EXP	VSS	VSS	PEG2_RXP_0 (Note 4)	VCC_EXP	VCC_EXP		VCC_EXP	VCC_EXP	VSS	VCC_EXP	VCC_EXP		VCC_EXP		W
V	VCCR_EXP	VCCR_EXP	VSS	RSVD	DML_TXN_3	DML_TXP_3		VSS	DML_RXP_3	DML_RXN_3		VCC_EXP	VCC_EXP	VCC_EXP	VCC_EXP	V
U											VCC_EXP	VCC_EXP		VCC_EXP		U
T	VCCR_EXP	VCCR_EXP	VSS	RSVD	VSS	EXP_COMPO		DML_RXN_1	DML_RXP_1	VSS		VCC_EXP	VCC_EXP		DML_TXN_2	T
R			VSS	VSS	VSS	EXP_COMPI		VSS	DML_TXP_0	DML_TXN_0	DML_RXN_2	VSS		DML_TXP_2		R
P		VSS									DML_TXN_2	DML_RXP_2	DML_TXN_1		VSS	P
N	VCC_N15		PEG_RXP_4	RSVD	RSVD	PEG_RXN_1_5		PEG_RXP_1_5	VSS	VSS	DML_RXP_0	VSS		DML_TXP_1		N
M	VSS_M15		PEG_RXN_4	VSS	PEG_RXP_1_2	VSS		PEG_RXN_1_3	PEG_RXP_1_3	VSS		DML_RXN_0	VCCR_EXP		PEG_TXP_1_5	M
L	VSS		PEG_RXP_3	PEG_RXN_6	VSS	PEG_RXN_1_2		VSS	VSS	VSS	PEG_TXP_1_4	VSS		PEG_TXN_1_5		L
K	VSS		PEG_RXN_3	VSS	PEG_RXP_6	VSS		PEG_RXN_1_1	PEG_RXP_1_1	VSS		PEG_TXN_1_4	PEG_RXP_1_4		VSS	K
J											PEG_TXP_1_3		VSS	PEG_RXN_1_4		J
H	RSVD_H15		PEG_RXP_2	PEG_RXP_5	VSS	PEG_RXN_7		VSS	VSS	VSS		PEG_TXN_1_3	VCCR_EXP		PEG_TXP_1_2	H
G	RSVD_G15		PEG_RXN_2	PEG_RXN_5	VSS	PEG_RXP_7		VSS	VSS	PEG_RXN_9		VSS		PEG_TXN_1_2		G
F	VSS		VSS	VSS	VSS	VSS		VSS	PEG_RXP_9	VSS	PEG_TXP_1_1		PEG_TXP_1_0		VSS	F
E	PEG_TXP_1		PEG_TXP_2		PEG_TXN_4		PEG_TXN_6			PEG_RXP_8	VSS	PEG_TXN_1_1				E
D	VSS	PEG_TXN_1	VSS	PEG_TXN_2	VSS	PEG_TXP_4		PEG_TXP_6	VSS		PEG_RXN_8	VSS	PEG_TXN_1_0	PEG_RXP_1_0		D
C		PEG_RXN_1		VCCR_EXP		PEG_TXN_5	VSS	VCCR_EXP		PEG_TXP_8		PEG_TXN_8	VSS	PEG_RXN_1_0	VSS	C
B	PEG_RXN_0		PEG_RXP_1		PEG_TXP_3		PEG_TXP_5		PEG_TXP_7			PEG_TXN_9	PEG_TXP_9	VSS	NC	B
A		VSS		PEG_TXN_3		VSS		PEG_TXN_7		VSS			VSS	TEST2		A



**Table 28. MCH  
Ballout Sorted By Name**

Signal Name	Ball #
ALLZTEST	M21
BSELO	M22
BSEL1	F21
BSEL2	F18
CL_CLK	AK14
CL_DATA	AK15
CL_PWROK	AL13
CL_RSTB	AG11
CL_VREF	AG14
DDR_A_BS_0	BC37
DDR_A_BS_1	BB36
DDR_A_BS_2	BB26
DDR_A_CASB	BB41
DDR_A_CB_0	AL33
DDR_A_CB_1	AN35
DDR_A_CB_2	AK38
DDR_A_CB_3	AK35
DDR_A_CB_4	AK33
DDR_A_CB_5	AL34
DDR_A_CB_6	AK34
DDR_A_CB_7	AK39
DDR_A_CK_0	AT33
DDR_A_CK_1	AN28
DDR_A_CK_2	AT34
DDR_A_CK_3	AV31
DDR_A_CK_4	AN27
DDR_A_CK_5	AT35
DDR_A_CKB_0	AR33
DDR_A_CKB_1	AM28
DDR_A_CKB_2	AV35
DDR_A_CKB_3	AT31
DDR_A_CKB_4	AM27
DDR_A_CKB_5	AT36
DDR_A_CKE_0	BD25
DDR_A_CKE_1	AY24
DDR_A_CKE_2	BB25
DDR_A_CKE_3	BC24
DDR_A_CSB_0	BA40
DDR_A_CSB_1	BD42
DDR_A_CSB_2	BB39
DDR_A_CSB_3	AY43
DDR_A_DM_0	BB5
DDR_A_DM_1	BC10
DDR_A_DM_2	BC14
DDR_A_DM_3	AP21

**Table 28. MCH  
Ballout Sorted By Name**

Signal Name	Ball #
DDR_A_DM_4	AU44
DDR_A_DM_5	AN44
DDR_A_DM_6	AE44
DDR_A_DM_7	AB40
DDR_A_DQ_0	BC4
DDR_A_DQ_1	BD4
DDR_A_DQ_2	BB8
DDR_A_DQ_3	BE8
DDR_A_DQ_4	BD3
DDR_A_DQ_5	BB4
DDR_A_DQ_6	BD7
DDR_A_DQ_7	BB7
DDR_A_DQ_8	BD9
DDR_A_DQ_9	BB10
DDR_A_DQ_10	BB12
DDR_A_DQ_11	BE12
DDR_A_DQ_12	BA9
DDR_A_DQ_13	BC9
DDR_A_DQ_14	BD11
DDR_A_DQ_15	BB11
DDR_A_DQ_16	BD13
DDR_A_DQ_17	BB14
DDR_A_DQ_18	BB16
DDR_A_DQ_19	BE16
DDR_A_DQ_20	BA13
DDR_A_DQ_21	BB13
DDR_A_DQ_22	BD15
DDR_A_DQ_23	BB15
DDR_A_DQ_24	AN19
DDR_A_DQ_25	AY21
DDR_A_DQ_26	AN22
DDR_A_DQ_27	AT22
DDR_A_DQ_28	AV19
DDR_A_DQ_29	AW19
DDR_A_DQ_30	AN21
DDR_A_DQ_31	AW22
DDR_A_DQ_32	AV42
DDR_A_DQ_33	AU43
DDR_A_DQ_34	AR44
DDR_A_DQ_35	AR42
DDR_A_DQ_36	AW42
DDR_A_DQ_37	AU41
DDR_A_DQ_38	AR41
DDR_A_DQ_39	AR40
DDR_A_DQ_40	AN41

**Table 28. MCH  
Ballout Sorted By Name**

Signal Name	Ball #
DDR_A_DQ_41	AN42
DDR_A_DQ_42	AL44
DDR_A_DQ_43	AL42
DDR_A_DQ_44	AP42
DDR_A_DQ_45	AP45
DDR_A_DQ_46	AL40
DDR_A_DQ_47	AL41
DDR_A_DQ_48	AE41
DDR_A_DQ_49	AE42
DDR_A_DQ_50	AC42
DDR_A_DQ_51	AC45
DDR_A_DQ_52	AF42
DDR_A_DQ_53	AF45
DDR_A_DQ_54	AD40
DDR_A_DQ_55	AC39
DDR_A_DQ_56	AB42
DDR_A_DQ_57	AB43
DDR_A_DQ_58	Y42
DDR_A_DQ_59	W42
DDR_A_DQ_60	AC40
DDR_A_DQ_61	AB39
DDR_A_DQ_62	AA41
DDR_A_DQ_63	Y45
DDR_A_DQS_0	BA6
DDR_A_DQS_1	BA11
DDR_A_DQS_2	BA15
DDR_A_DQS_3	AT21
DDR_A_DQS_4	AT43
DDR_A_DQS_5	AM43
DDR_A_DQS_6	AD43
DDR_A_DQS_7	AA42
DDR_A_DQS_8	AL38
DDR_A_DQSB_0	BC6
DDR_A_DQSB_1	AY11
DDR_A_DQSB_2	AY15
DDR_A_DQSB_3	AV21
DDR_A_DQSB_4	AT42
DDR_A_DQSB_5	AM42
DDR_A_DQSB_6	AD42
DDR_A_DQSB_7	AA44
DDR_A_DQSB_8	AL36
DDR_A_MA_0	BC36
DDR_A_MA_1	BB31
DDR_A_MA_2	BB30
DDR_A_MA_3	BB29



**Table 28. MCH Ballout Sorted By Name**

Signal Name	Ball #
DDR_A_MA_4	BA29
DDR_A_MA_5	BB28
DDR_A_MA_6	BD29
DDR_A_MA_7	AY27
DDR_A_MA_8	BC28
DDR_A_MA_9	BA27
DDR_A_MA_10	BD37
DDR_A_MA_11	BD27
DDR_A_MA_12	BB27
DDR_A_MA_13	BA42
DDR_A_MA_14	BA25
DDR_A_ODT_0	BB43
DDR_A_ODT_1	AY41
DDR_A_ODT_2	BA41
DDR_A_ODT_3	AW44
DDR_A_RASB	BB38
DDR_A_WEB	BD39
DDR_B_BS_0	BB24
DDR_B_BS_1	AW23
DDR_B_BS_2	BB18
DDR_B_CASB	BB32
DDR_B_CB_0	AK45
DDR_B_CB_1	AJ44
DDR_B_CB_2	AG42
DDR_B_CB_3	AG40
DDR_B_CB_4	AJ42
DDR_B_CB_5	AK42
DDR_B_CB_6	AG41
DDR_B_CB_7	AG44
DDR_B_CK_0	AW30
DDR_B_CK_1	AR28
DDR_B_CK_2	AV33
DDR_B_CK_3	AR31
DDR_B_CK_4	AY30
DDR_B_CK_5	AW34
DDR_B_CKB_0	AV30
DDR_B_CKB_1	AP28
DDR_B_CKB_2	AW33
DDR_B_CKB_3	AP31
DDR_B_CKB_4	AY28
DDR_B_CKB_5	AY34
DDR_B_CKE_0	BD17
DDR_B_CKE_1	BD19
DDR_B_CKE_2	BB17
DDR_B_CKE_3	BA17

**Table 28. MCH Ballout Sorted By Name**

Signal Name	Ball #
DDR_B_CSB_0	BA31
DDR_B_CSB_1	BB35
DDR_B_CSB_2	BC32
DDR_B_CSB_3	BA35
DDR_B_DM_0	AY8
DDR_B_DM_1	AT13
DDR_B_DM_2	AW16
DDR_B_DM_3	AY25
DDR_B_DM_4	AY40
DDR_B_DM_5	AN36
DDR_B_DM_6	AG35
DDR_B_DM_7	AD35
DDR_B_DQ_0	AW8
DDR_B_DQ_1	AY7
DDR_B_DQ_2	AT11
DDR_B_DQ_3	AT12
DDR_B_DQ_4	AV8
DDR_B_DQ_5	AW6
DDR_B_DQ_6	AR11
DDR_B_DQ_7	AW11
DDR_B_DQ_8	AY12
DDR_B_DQ_9	AY13
DDR_B_DQ_10	AT15
DDR_B_DQ_11	AV15
DDR_B_DQ_12	AW12
DDR_B_DQ_13	AW13
DDR_B_DQ_14	AN15
DDR_B_DQ_15	AP15
DDR_B_DQ_16	AY16
DDR_B_DQ_17	AV16
DDR_B_DQ_18	AP19
DDR_B_DQ_19	AT19
DDR_B_DQ_20	AN16
DDR_B_DQ_21	AR16
DDR_B_DQ_22	AT18
DDR_B_DQ_23	AR18
DDR_B_DQ_24	AW25
DDR_B_DQ_25	AV25
DDR_B_DQ_26	AT27
DDR_B_DQ_27	AV27
DDR_B_DQ_28	AN24
DDR_B_DQ_29	AP24
DDR_B_DQ_30	AT25
DDR_B_DQ_31	AP27
DDR_B_DQ_32	AY39

**Table 28. MCH Ballout Sorted By Name**

Signal Name	Ball #
DDR_B_DQ_33	AW38
DDR_B_DQ_34	AT38
DDR_B_DQ_35	AT40
DDR_B_DQ_36	AY38
DDR_B_DQ_37	AW36
DDR_B_DQ_38	AV39
DDR_B_DQ_39	AV40
DDR_B_DQ_40	AR36
DDR_B_DQ_41	AP36
DDR_B_DQ_42	AP35
DDR_B_DQ_43	AN33
DDR_B_DQ_44	AV36
DDR_B_DQ_45	AR34
DDR_B_DQ_46	AN39
DDR_B_DQ_47	AN40
DDR_B_DQ_48	AH34
DDR_B_DQ_49	AG33
DDR_B_DQ_50	AE39
DDR_B_DQ_51	AE38
DDR_B_DQ_52	AH33
DDR_B_DQ_53	AH36
DDR_B_DQ_54	AE40
DDR_B_DQ_55	AE33
DDR_B_DQ_56	AD39
DDR_B_DQ_57	AD36
DDR_B_DQ_58	AB32
DDR_B_DQ_59	AB38
DDR_B_DQ_60	AE35
DDR_B_DQ_61	AE34
DDR_B_DQ_62	AC36
DDR_B_DQ_63	AC34
DDR_B_DQS_0	AW10
DDR_B_DQS_1	AR13
DDR_B_DQS_2	AN18
DDR_B_DQS_3	AR25
DDR_B_DQS_4	AW39
DDR_B_DQS_5	AP39
DDR_B_DQS_6	AG39
DDR_B_DQS_7	AC33
DDR_B_DQS_8	AH43
DDR_B_DQSB_0	AT10
DDR_B_DQSB_1	AR12
DDR_B_DQSB_2	AP16
DDR_B_DQSB_3	AR24
DDR_B_DQSB_4	AV38



**Table 28. MCH  
Ballout Sorted By Name**

Signal Name	Ball #
DDR_B_DQSB_5	AP40
DDR_B_DQSB_6	AG38
DDR_B_DQSB_7	AD33
DDR_B_DQSB_8	AH42
DDR_B_MA_0	AY22
DDR_B_MA_1	BC22
DDR_B_MA_2	BB22
DDR_B_MA_3	BA21
DDR_B_MA_4	BD21
DDR_B_MA_5	BB21
DDR_B_MA_6	BB20
DDR_B_MA_7	AY19
DDR_B_MA_8	BE20
DDR_B_MA_9	BB19
DDR_B_MA_10	AW24
DDR_B_MA_11	BA19
DDR_B_MA_12	AY18
DDR_B_MA_13	BA33
DDR_B_MA_14	BC18
DDR_B_ODT_0	BD33
DDR_B_ODT_1	BB34
DDR_B_ODT_2	BB33
DDR_B_ODT_3	AY35
DDR_B_RASB	BD31
DDR_B_WEB	AY31
DDR_RCOMPVOH	AT6
DDR_RCOMPVOL	AT7
DDR_RCOMPXPD	AY6
DDR_RCOMPXPU	AY5
DDR_RCOMPYPD	BC42
DDR_RCOMPYPU	BB42
DDR_VREF	AV7
RSVD	BB44
RSVD	BD35
RSVD	BC40
RSVD	BA37
RSVD	AN11
RSVD	BB23
DMI_RXN_0	M4
DMI_RXN_1	T8
DMI_RXN_2	R5
DMI_RXN_3	V6
DMI_RXP_0	N5
DMI_RXP_1	T7
DMI_RXP_2	P4

**Table 28. MCH  
Ballout Sorted By Name**

Signal Name	Ball #
DMI_RXP_3	V7
DMI_TXN_0	R6
DMI_TXN_1	P3
DMI_TXN_2	T1
DMI_TXN_3	V11
DMI_TXP_0	R7
DMI_TXP_1	N2
DMI_TXP_2	R2
DMI_TXP_3	V10
EXP_CLKINN	D18
EXP_CLKINP	D19
EXP_COMPI	R10
EXP_COMPO	T10
EXP_SLR	K19
EXP2_CLKINN	AD14
EXP2_CLKINP	AE14
EXP2_COMPI <sup>(4)</sup>	AN10
EXP2_COMPO <sup>(4)</sup>	AN8
FSB_AB_3	F43
FSB_AB_4	M38
FSB_AB_5	M36
FSB_AB_6	K38
FSB_AB_7	L40
FSB_AB_8	N36
FSB_AB_9	N40
FSB_AB_10	R36
FSB_AB_11	N39
FSB_AB_12	N34
FSB_AB_13	N38
FSB_AB_14	R39
FSB_AB_15	K42
FSB_AB_16	R35
FSB_AB_17	T40
FSB_AB_18	T36
FSB_AB_19	T34
FSB_AB_20	T38
FSB_AB_21	P43
FSB_AB_22	W38
FSB_AB_23	V38
FSB_AB_24	V39
FSB_AB_25	W34
FSB_AB_26	V35
FSB_AB_27	W33
FSB_AB_28	V43
FSB_AB_29	AB34

**Table 28. MCH  
Ballout Sorted By Name**

Signal Name	Ball #
FSB_AB_30	W36
FSB_AB_31	AA33
FSB_AB_32	AA35
FSB_AB_33	AA40
FSB_AB_34	AB35
FSB_AB_35	AA38
FSB_ACCVREF	D27
FSB_ADSB	U44
FSB_ADSTBB_0	M40
FSB_ADSTBB_1	V34
FSB_BNRB	U42
FSB_BPRIB	H38
FSB_BREQOB	W44
FSB_CPURSTB	D35
FSB_DB_0	P42
FSB_DB_1	N41
FSB_DB_2	N44
FSB_DB_3	M42
FSB_DB_4	N42
FSB_DB_5	M45
FSB_DB_6	L44
FSB_DB_7	L42
FSB_DB_8	J43
FSB_DB_9	H42
FSB_DB_10	J41
FSB_DB_11	G42
FSB_DB_12	H45
FSB_DB_13	G44
FSB_DB_14	F41
FSB_DB_15	E42
FSB_DB_16	F38
FSB_DB_17	F39
FSB_DB_18	B43
FSB_DB_19	L36
FSB_DB_20	G38
FSB_DB_21	K35
FSB_DB_22	G36
FSB_DB_23	G35
FSB_DB_24	K34
FSB_DB_25	H33
FSB_DB_26	F33
FSB_DB_27	L34
FSB_DB_28	N33
FSB_DB_29	L33
FSB_DB_30	N31



**Table 28. MCH Ballout Sorted By Name**

Signal Name	Ball #
FSB_DB_31	M31
FSB_DB_32	F31
FSB_DB_33	K31
FSB_DB_34	H31
FSB_DB_35	M30
FSB_DB_36	L30
FSB_DB_37	N30
FSB_DB_38	G30
FSB_DB_39	H30
FSB_DB_40	K28
FSB_DB_41	L28
FSB_DB_42	N24
FSB_DB_43	L25
FSB_DB_44	L24
FSB_DB_45	H24
FSB_DB_46	K24
FSB_DB_47	G24
FSB_DB_48	F35
FSB_DB_49	A38
FSB_DB_50	E41
FSB_DB_51	C42
FSB_DB_52	D44
FSB_DB_53	D43
FSB_DB_54	D38
FSB_DB_55	B42
FSB_DB_56	B39
FSB_DB_57	D39
FSB_DB_58	C36
FSB_DB_59	D36
FSB_DB_60	C37
FSB_DB_61	E37
FSB_DB_62	B35
FSB_DB_63	E35
FSB_DBSYB	T42
FSB_DEFERB	T39
FSB_DINVB_0	L41
FSB_DINVB_1	E40
FSB_DINVB_2	N28
FSB_DINVB_3	B37
FSB_DRDYB	U41
FSB_DSTBNB_0	K43
FSB_DSTBNB_1	G34
FSB_DSTBNB_2	M25
FSB_DSTBNB_3	D41
FSB_DSTBPB_0	J44

**Table 28. MCH Ballout Sorted By Name**

Signal Name	Ball #
FSB_DSTBPB_1	H34
FSB_DSTBPB_2	N25
FSB_DSTBPB_3	C40
FSB_DVREF	E27
FSB_HITB	R42
FSB_HITMB	V42
FSB_LOCKB	T45
FSB_RCOMP	C26
FSB_REQB_0	C44
FSB_REQB_1	G40
FSB_REQB_2	L39
FSB_REQB_3	K36
FSB_REQB_4	H39
FSB_RSB_0	R44
FSB_RSB_1	W41
FSB_RSB_2	R41
FSB_SCOMP	D28
FSB_SCOMPB	C28
FSB_SWING	A28
FSB_TRDYB	W40
HPL_CLKINN	P30
HPL_CLKINP	P28
ICH_SYNCB	P16
RSVD	G19
NC	BE2
NC	BD45
NC	BD1
NC	B45
NC	B1
NC	A44
PEG_RXN_0	B15
PEG_RXN_1	C14
PEG_RXN_2	G13
PEG_RXN_3	K13
PEG_RXN_4	M13
PEG_RXN_5	G12
PEG_RXN_6	L12
PEG_RXN_7	H10
PEG_RXN_8	D5
PEG_RXN_9	G6
PEG_RXN_10	C2
PEG_RXN_11	K8
PEG_RXN_12	L10
PEG_RXN_13	M8
PEG_RXN_14	J2

**Table 28. MCH Ballout Sorted By Name**

Signal Name	Ball #
PEG_RXN_15	N10
PEG_RXP_0	A16
PEG_RXP_1	B13
PEG_RXP_2	H13
PEG_RXP_3	L13
PEG_RXP_4	N13
PEG_RXP_5	H12
PEG_RXP_6	K11
PEG_RXP_7	G10
PEG_RXP_8	E6
PEG_RXP_9	F7
PEG_RXP_10	D2
PEG_RXP_11	K7
PEG_RXP_12	M11
PEG_RXP_13	M7
PEG_RXP_14	K3
PEG_RXP_15	N8
PEG_TXN_0	E17
PEG_TXN_1	D14
PEG_TXN_2	D12
PEG_TXN_3	A12
PEG_TXN_4	E11
PEG_TXN_5	C10
PEG_TXN_6	E9
PEG_TXN_7	A8
PEG_TXN_8	C4
PEG_TXN_9	B4
PEG_TXN_10	D3
PEG_TXN_11	E4
PEG_TXN_12	G2
PEG_TXN_13	H4
PEG_TXN_14	K4
PEG_TXN_15	L2
PEG_TXP_0	D16
PEG_TXP_1	E15
PEG_TXP_2	E13
PEG_TXP_3	B11
PEG_TXP_4	D10
PEG_TXP_5	B9
PEG_TXP_6	D8
PEG_TXP_7	B7
PEG_TXP_8	C6
PEG_TXP_9	B3
PEG_TXP_10	F3
PEG_TXP_11	F5





**Table 28. MCH  
Ballout Sorted By Name**

Signal Name	Ball #
PEG_TXP_12	H1
PEG_TXP_13	J5
PEG_TXP_14	L5
PEG_TXP_15	M1
PEG2_RXN_0 <sup>(4)</sup>	AA13
PEG2_RXN_1 <sup>(4)</sup>	AA11
PEG2_RXN_2 <sup>(4)</sup>	AA7
PEG2_RXN_3 <sup>(4)</sup>	AB12
PEG2_RXN_4 <sup>(4)</sup>	AC10
PEG2_RXN_5 <sup>(4)</sup>	AC7
PEG2_RXN_6 <sup>(4)</sup>	AD12
PEG2_RXN_7 <sup>(4)</sup>	AE11
PEG2_RXN_8 <sup>(4)</sup>	AE6
PEG2_RXN_9 <sup>(4)</sup>	AH13
PEG2_RXN_10 <sup>(4)</sup>	AH10
PEG2_RXN_11 <sup>(4)</sup>	AH6
PEG2_RXN_12 <sup>(4)</sup>	AK13
PEG2_RXN_13 <sup>(4)</sup>	AL10
PEG2_RXN_14 <sup>(4)</sup>	AL7
PEG2_RXN_15 <sup>(4)</sup>	AP11
PEG2_RXP_0 <sup>(4)</sup>	W12
PEG2_RXP_1 <sup>(4)</sup>	AA10
PEG2_RXP_2 <sup>(4)</sup>	AA6
PEG2_RXP_3 <sup>(4)</sup>	AC13
PEG2_RXP_4 <sup>(4)</sup>	AC11
PEG2_RXP_5 <sup>(4)</sup>	AC6
PEG2_RXP_6 <sup>(4)</sup>	AE13
PEG2_RXP_7 <sup>(4)</sup>	AE10
PEG2_RXP_8 <sup>(4)</sup>	AE7
PEG2_RXP_9 <sup>(4)</sup>	AG12
PEG2_RXP_10 <sup>(4)</sup>	AH11
PEG2_RXP_11 <sup>(4)</sup>	AH7
PEG2_RXP_12 <sup>(4)</sup>	AK12
PEG2_RXP_13 <sup>(4)</sup>	AL11
PEG2_RXP_14 <sup>(4)</sup>	AL6
PEG2_RXP_15 <sup>(4)</sup>	AP10
PEG2_TXN_0 <sup>(4)</sup>	AB1
PEG2_TXN_1 <sup>(4)</sup>	AC4
PEG2_TXN_2 <sup>(4)</sup>	AD3
PEG2_TXN_3 <sup>(4)</sup>	AE5
PEG2_TXN_4 <sup>(4)</sup>	AF1
PEG2_TXN_5 <sup>(4)</sup>	AG5
PEG2_TXN_6 <sup>(4)</sup>	AH3
PEG2_TXN_7 <sup>(4)</sup>	AJ5
PEG2_TXN_8 <sup>(4)</sup>	AK1

**Table 28. MCH  
Ballout Sorted By Name**

Signal Name	Ball #
PEG2_TXN_9 <sup>(4)</sup>	AL5
PEG2_TXN_10 <sup>(4)</sup>	AM3
PEG2_TXN_11 <sup>(4)</sup>	AN5
PEG2_TXN_12 <sup>(4)</sup>	AP1
PEG2_TXN_13 <sup>(4)</sup>	AR5
PEG2_TXN_14 <sup>(4)</sup>	AT3
PEG2_TXN_15 <sup>(4)</sup>	AP6
PEG2_TXP_0 <sup>(4)</sup>	AB3
PEG2_TXP_1 <sup>(4)</sup>	AD4
PEG2_TXP_2 <sup>(4)</sup>	AE2
PEG2_TXP_3 <sup>(4)</sup>	AF4
PEG2_TXP_4 <sup>(4)</sup>	AG2
PEG2_TXP_5 <sup>(4)</sup>	AH4
PEG2_TXP_6 <sup>(4)</sup>	AJ2
PEG2_TXP_7 <sup>(4)</sup>	AK4
PEG2_TXP_8 <sup>(4)</sup>	AL2
PEG2_TXP_9 <sup>(4)</sup>	AM4
PEG2_TXP_10 <sup>(4)</sup>	AN2
PEG2_TXP_11 <sup>(4)</sup>	AP4
PEG2_TXP_12 <sup>(4)</sup>	AR2
PEG2_TXP_13 <sup>(4)</sup>	AT4
PEG2_TXP_14 <sup>(4)</sup>	AU2
PEG2_TXP_15 <sup>(4)</sup>	AP7
PWROK	AM19
RSTINB	AM18
RSVD	L18
RSVD	BC2
RSVD	AP34
RSVD	AP12
RSVD	AN31
RSVD	AN30
RSVD	AN25
RSVD	AN13
RSVD	AN12
RSVD	AM32
RSVD	AM25
RSVD	AM14
RSVD	AL28
RSVD	AH28
RSVD	AG32
RSVD	AG28
RSVD	AD32
RSVD	W32
RSVD	V32
RSVD	V12

**Table 28. MCH  
Ballout Sorted By Name**

Signal Name	Ball #
RSVD	T33
RSVD	T12
RSVD	R33
RSVD	R22
RSVD	R19
RSVD	P21
RSVD	N21
RSVD	N18
RSVD	N12
RSVD	N11
RSVD	M16
RSVD	L19
RSVD	K22
RSVD	K21
RSVD	H21
RSVD	G22
RSVD	F19
RSVD	B19
RSVD_G15	G15
RSVD_H15	H15
RSVD_M19	M19
RSVD_P19	P19
TCEN	G21
TEST0	BE45
TEST1	BE1
TEST2	A2
TEST3	A45
VCC	AH26
VCC	AH24
VCC	AH22
VCC	AH20
VCC	AH19
VCC	AH18
VCC	AH17
VCC	AG27
VCC	AG25
VCC	AG23
VCC	AG21
VCC	AG19
VCC	AG18
VCC	AG17
VCC	AG15
VCC	AF28
VCC	AF26
VCC	AF24



**Table 28. MCH Ballout Sorted By Name**

Signal Name	Ball #
VCC	AF22
VCC	AF20
VCC	AF18
VCC	AF17
VCC	AE28
VCC	AE27
VCC	AE25
VCC	AE23
VCC	AE21
VCC	AE19
VCC	AE18
VCC	AE17
VCC	AD28
VCC	AD26
VCC	AD24
VCC	AD22
VCC	AD20
VCC	AD18
VCC	AD17
VCC	AC28
VCC	AC27
VCC	AC25
VCC	AC23
VCC	AC21
VCC	AC19
VCC	AC18
VCC	AC17
VCC	AB28
VCC	AB26
VCC	AB24
VCC	AB22
VCC	AB20
VCC	AB18
VCC	AB17
VCC	AB15
VCC	AA28
VCC	AA27
VCC	AA25
VCC	AA23
VCC	AA21
VCC	AA19
VCC	AA18
VCC	AA17
VCC	Y28
VCC	Y26

**Table 28. MCH Ballout Sorted By Name**

Signal Name	Ball #
VCC	Y24
VCC	Y22
VCC	Y20
VCC	Y18
VCC	Y17
VCC	W28
VCC	W27
VCC	W25
VCC	W23
VCC	W21
VCC	W19
VCC	W18
VCC	W17
VCC	V28
VCC	V26
VCC	V24
VCC	V22
VCC	V20
VCC	V18
VCC	V17
VCC	U28
VCC	U27
VCC	U26
VCC	U25
VCC	U24
VCC	U23
VCC	U22
VCC	U21
VCC	U20
VCC	U19
VCC	U18
VCC	U17
VCC	R18
VCC	R16
VCC_B25	B25
VCC_C18	C18
VCC_CKDDR	BE44
VCC_CKDDR	BE43
VCC_CKDDR	BD44
VCC_CKDDR	BD43
VCC_CKDDR	BC45
VCC_CKDDR	BC44
VCC_CL	V31
VCC_CL	AM30
VCC_CL	AM23

**Table 28. MCH Ballout Sorted By Name**

Signal Name	Ball #
VCC_CL	AM22
VCC_CL	AL30
VCC_CL	AL27
VCC_CL	AL25
VCC_CL	AL24
VCC_CL	AL23
VCC_CL	AL22
VCC_CL	AL21
VCC_CL	AL19
VCC_CL	AL18
VCC_CL	AL16
VCC_CL	AK31
VCC_CL	AJ29
VCC_CL	AJ28
VCC_CL	AJ27
VCC_CL	AJ26
VCC_CL	AJ25
VCC_CL	AJ24
VCC_CL	AJ23
VCC_CL	AJ22
VCC_CL	AJ21
VCC_CL	AJ20
VCC_CL	AJ19
VCC_CL	AJ18
VCC_CL	AJ17
VCC_CL	AH31
VCC_CL	AH29
VCC_CL	AH15
VCC_CL	AH14
VCC_CL	AG31
VCC_CL	AG29
VCC_CL	AF29
VCC_CL	AE31
VCC_CL	AE29
VCC_CL	AD31
VCC_CL	AD29
VCC_CL	AC31
VCC_CL	AC29
VCC_CL	AB31
VCC_CL	AB29
VCC_CL	AA31
VCC_CL	AA29
VCC_CL	Y29
VCC_CL	W29
VCC_CL	V29



**Table 28. MCH  
Ballout Sorted By Name**

Signal Name	Ball #
VCC_DDR	BE40
VCC_DDR	BE36
VCC_DDR	BE32
VCC_DDR	BE28
VCC_DDR	BE24
VCC_DDR	BE22
VCC_DDR	BC38
VCC_DDR	BC34
VCC_DDR	BC30
VCC_DDR	BC26
VCC_DDR	BC23
VCC_DDR	BC20
VCC_DDR	AY45
VCC_DDR	AY23
VCC_E25	E25
VCC_EXP	AD11
VCC_EXP	AD10
VCC_EXP	AD8
VCC_EXP	AD7
VCC_EXP	AB11
VCC_EXP	AB10
VCC_EXP	AB8
VCC_EXP	AB7
VCC_EXP	AB6
VCC_EXP	AB4
VCC_EXP	AA5
VCC_EXP	AA4
VCC_EXP	AA2
VCC_EXP	Y4
VCC_EXP	Y3
VCC_EXP	Y1
VCC_EXP	W11
VCC_EXP	W10
VCC_EXP	W8
VCC_EXP	W7
VCC_EXP	W5
VCC_EXP	W4
VCC_EXP	W2
VCC_EXP	V4
VCC_EXP	V3
VCC_EXP	V1
VCC_EXP	U5
VCC_EXP	U4
VCC_EXP	U2
VCC_EXP	T4

**Table 28. MCH  
Ballout Sorted By Name**

Signal Name	Ball #
VCC_EXP	T3
VCC_EXT_PLL	AB13
VCC_N15	N15
VCC3_3	A23
VCC3_3_G16	G16
VCC3_3_L16	L16
VCCA_EXP	D20
VCCA_EXP2	AU5
VCCA_HPL	D26
VCCA_HPL	D25
VCCA_MPL	B27
VCCAPLL_EXP	A20
VCCAPLL_EXP2	AR10
VCCAUX	U29
VCCAUX	T31
VCCAUX	R30
VCCAUX	R28
VCCAUX	R27
VCCAUX	R25
VCCAUX	R24
VCCAUX	R23
VCCR_EXP	AP3
VCCR_EXP	AK3
VCCR_EXP	AF3
VCCR_EXP	AE15
VCCR_EXP	AD15
VCCR_EXP	AC15
VCCR_EXP	AC3
VCCR_EXP	AB14
VCCR_EXP	AA15
VCCR_EXP	AA14
VCCR_EXP	W15
VCCR_EXP	V15
VCCR_EXP	V14
VCCR_EXP	T15
VCCR_EXP	T14
VCCR_EXP	M3
VCCR_EXP	H3
VCCR_EXP	C16
VCCR_EXP	C12
VCCR_EXP	C8
VSS	B2
VSS	BE38
VSS	BE34
VSS	BE30

**Table 28. MCH  
Ballout Sorted By Name**

Signal Name	Ball #
VSS	BE26
VSS	BE23
VSS	BE18
VSS	BE14
VSS	BE10
VSS	BE6
VSS	BE3
VSS	BD2
VSS	BC43
VSS	BC16
VSS	BC12
VSS	BC8
VSS	BC3
VSS	BC1
VSS	BB2
VSS	AY36
VSS	AY33
VSS	AY10
VSS	AW40
VSS	AW35
VSS	AW31
VSS	AW28
VSS	AW27
VSS	AW21
VSS	AW18
VSS	AW15
VSS	AW7
VSS	AW4
VSS	AV45
VSS	AV43
VSS	AV34
VSS	AV28
VSS	AV24
VSS	AV23
VSS	AV22
VSS	AV18
VSS	AV13
VSS	AV12
VSS	AV11
VSS	AV10
VSS	AV6
VSS	AV4
VSS	AV3
VSS	AV1
VSS	AU3



**Table 28. MCH Ballout Sorted By Name**

Signal Name	Ball #
VSS	AT45
VSS	AT39
VSS	AT30
VSS	AT28
VSS	AT24
VSS	AT23
VSS	AT16
VSS	AT8
VSS	AT1
VSS	AR39
VSS	AR38
VSS	AR35
VSS	AR30
VSS	AR27
VSS	AR23
VSS	AR22
VSS	AR21
VSS	AR19
VSS	AR15
VSS	AR8
VSS	AR7
VSS	AR6
VSS	AR4
VSS	AP43
VSS	AP38
VSS	AP33
VSS	AP30
VSS	AP25
VSS	AP23
VSS	AP22
VSS	AP18
VSS	AP13
VSS	AP8
VSS	AN38
VSS	AN34
VSS	AN23
VSS	AN7
VSS	AN6
VSS	AN4
VSS	AM45
VSS	AM24
VSS	AM21
VSS	AM16
VSS	AM1
VSS	AL39

**Table 28. MCH Ballout Sorted By Name**

Signal Name	Ball #
VSS	AL35
VSS	AL12
VSS	AL8
VSS	AL4
VSS	AK43
VSS	AK40
VSS	AK36
VSS	AK32
VSS	AK11
VSS	AK10
VSS	AK8
VSS	AK7
VSS	AK6
VSS	AJ41
VSS	AJ4
VSS	AH45
VSS	AH40
VSS	AH39
VSS	AH38
VSS	AH35
VSS	AH32
VSS	AH27
VSS	AH25
VSS	AH23
VSS	AH21
VSS	AH12
VSS	AH8
VSS	AH1
VSS	AG36
VSS	AG34
VSS	AG26
VSS	AG24
VSS	AG22
VSS	AG20
VSS	AG13
VSS	AG10
VSS	AG8
VSS	AG7
VSS	AG6
VSS	AG4
VSS	AF43
VSS	AF27
VSS	AF25
VSS	AF23
VSS	AF21

**Table 28. MCH Ballout Sorted By Name**

Signal Name	Ball #
VSS	AF19
VSS	AE36
VSS	AE32
VSS	AE26
VSS	AE24
VSS	AE22
VSS	AE20
VSS	AE12
VSS	AE8
VSS	AE4
VSS	AD45
VSS	AD38
VSS	AD34
VSS	AD27
VSS	AD25
VSS	AD23
VSS	AD21
VSS	AD19
VSS	AD13
VSS	AD6
VSS	AD1
VSS	AC43
VSS	AC38
VSS	AC35
VSS	AC32
VSS	AC26
VSS	AC24
VSS	AC22
VSS	AC20
VSS	AC14
VSS	AC12
VSS	AC8
VSS	AC1
VSS	AB45
VSS	AB36
VSS	AB33
VSS	AB27
VSS	AB25
VSS	AB23
VSS	AB21
VSS	AB19
VSS	AA39
VSS	AA36
VSS	AA34
VSS	AA32



**Table 28. MCH Ballout Sorted By Name**

Signal Name	Ball #
VSS	AA26
VSS	AA24
VSS	AA22
VSS	AA20
VSS	AA12
VSS	AA8
VSS	Y43
VSS	Y27
VSS	Y25
VSS	Y23
VSS	Y21
VSS	Y19
VSS	W39
VSS	W35
VSS	W26
VSS	W24
VSS	W22
VSS	W20
VSS	W14
VSS	W13
VSS	W6
VSS	V45
VSS	V40
VSS	V36
VSS	V33
VSS	V27
VSS	V25
VSS	V23
VSS	V21
VSS	V19
VSS	V13
VSS	V8
VSS	T43
VSS	T35
VSS	T32
VSS	T13
VSS	T11
VSS	T6
VSS	R40
VSS	R38
VSS	R34
VSS	R21
VSS	R13
VSS	R12
VSS	R11

**Table 28. MCH Ballout Sorted By Name**

Signal Name	Ball #
VSS	R8
VSS	R4
VSS	P45
VSS	P32
VSS	P27
VSS	P25
VSS	P24
VSS	P23
VSS	P22
VSS	P18
VSS	P14
VSS	P1
VSS	N35
VSS	N27
VSS	N23
VSS	N22
VSS	N19
VSS	N16
VSS	N7
VSS	N6
VSS	N4
VSS	M43
VSS	M39
VSS	M35
VSS	M34
VSS	M33
VSS	M28
VSS	M24
VSS	M23
VSS	M18
VSS	M12
VSS	M10
VSS	M6
VSS	L38
VSS	L35
VSS	L31
VSS	L23
VSS	L21
VSS	L15
VSS	L11
VSS	L8
VSS	L7
VSS	L6
VSS	L4
VSS	K45

**Table 28. MCH Ballout Sorted By Name**

Signal Name	Ball #
VSS	K40
VSS	K39
VSS	K33
VSS	K30
VSS	K23
VSS	K18
VSS	K15
VSS	K12
VSS	K10
VSS	K6
VSS	K1
VSS	J3
VSS	H43
VSS	H40
VSS	H36
VSS	H35
VSS	H23
VSS	H22
VSS	H19
VSS	H18
VSS	H11
VSS	H8
VSS	H7
VSS	H6
VSS	G39
VSS	G33
VSS	G31
VSS	G23
VSS	G18
VSS	G11
VSS	G8
VSS	G7
VSS	G4
VSS	F45
VSS	F40
VSS	F36
VSS	F34
VSS	F24
VSS	F23
VSS	F16
VSS	F15
VSS	F13
VSS	F12
VSS	F11
VSS	F10



**Table 28. MCH  
Ballout Sorted By Name**

Signal Name	Ball #
VSS	F8
VSS	F6
VSS	F1
VSS	E21
VSS	E19
VSS	E5
VSS	D42
VSS	D34
VSS	D29
VSS	D23
VSS	D17
VSS	D15
VSS	D13
VSS	D11
VSS	D7
VSS	D4
VSS	C45
VSS	C43
VSS	C38
VSS	C34
VSS	C30
VSS	C22
VSS	C20
VSS	C9
VSS	C3
VSS	C1
VSS	B44
VSS	B29
VSS	A43
VSS	A40
VSS	A36
VSS	A34
VSS	A26
VSS	A22
VSS	A18
VSS	A14
VSS	A10
VSS	A6
VSS	A3
VSS_A24	A24
VSS_AW2	AW2
VSS_AY1	AY1
VSS_AY3	AY3
VSS_B17	B17
VSS_B21	B21

**Table 28. MCH  
Ballout Sorted By Name**

Signal Name	Ball #
VSS_BA4	BA4
VSS_BA5	BA5
VSS_BB3	BB3
VSS_C23	C23
VSS_C24	C24
VSS_D21	D21
VSS_D22	D22
VSS_D24	D24
VSS_F22	F22
VSS_H16	H16
VSS_K16	K16
VSS_M15	M15
VSS_W31	W31
VTT_FSB	M27
VTT_FSB	L27
VTT_FSB	K27
VTT_FSB	K25
VTT_FSB	H28
VTT_FSB	H27
VTT_FSB	H25
VTT_FSB	G28
VTT_FSB	G27
VTT_FSB	G25
VTT_FSB	F30
VTT_FSB	F28
VTT_FSB	F27
VTT_FSB	F25
VTT_FSB	E33
VTT_FSB	E31
VTT_FSB	E29
VTT_FSB	D33
VTT_FSB	D32
VTT_FSB	D31
VTT_FSB	D30
VTT_FSB	C32
VTT_FSB	B33
VTT_FSB	B31
VTT_FSB	A32
VTT_FSB	A30
XORTEST	L22

**NOTE:** See list of notes at beginning of chapter.



**Table 29. MCH  
Ballout Sorted By Ball**

Ball #	Signal Name
BE45	TEST0
BE44	VCC_CKDDR
BE43	VCC_CKDDR
BE40	VCC_DDR
BE38	VSS
BE36	VCC_DDR
BE34	VSS
BE32	VCC_DDR
BE30	VSS
BE28	VCC_DDR
BE26	VSS
BE24	VCC_DDR
BE23	VSS
BE22	VCC_DDR
BE20	DDR_B_MA_8
BE18	VSS
BE16	DDR_A_DQ_19
BE14	VSS
BE12	DDR_A_DQ_11
BE10	VSS
BE8	DDR_A_DQ_3
BE6	VSS
BE4	4.75
BE3	VSS
BE2	NC
BE1	TEST1
BD45	NC
BD44	VCC_CKDDR
BD43	VCC_CKDDR
BD42	DDR_A_CSB_1
BD39	DDR_A_WEB
BD37	DDR_A_MA_10
BD35	RSVD
BD33	DDR_B_ODT_0
BD31	DDR_B_RASB
BD29	DDR_A_MA_6
BD27	DDR_A_MA_11
BD25	DDR_A_CKE_0
BD21	DDR_B_MA_4
BD19	DDR_B_CKE_1
BD17	DDR_B_CKE_0
BD15	DDR_A_DQ_22
BD13	DDR_A_DQ_16
BD11	DDR_A_DQ_14
BD9	DDR_A_DQ_8

**Table 29. MCH  
Ballout Sorted By Ball**

Ball #	Signal Name
BD7	DDR_A_DQ_6
BD4	DDR_A_DQ_1
BD3	DDR_A_DQ_4
BD2	VSS
BD1	NC
BC45	VCC_CKDDR
BC44	VCC_CKDDR
BC43	VSS
BC42	DDR_RCOMPYPD
BC40	RSVD
BC38	VCC_DDR
BC37	DDR_A_BS_0
BC36	DDR_A_MA_0
BC34	VCC_DDR
BC32	DDR_B_CSB_2
BC30	VCC_DDR
BC28	DDR_A_MA_8
BC26	VCC_DDR
BC24	DDR_A_CKE_3
BC23	VCC_DDR
BC22	DDR_B_MA_1
BC20	VCC_DDR
BC18	DDR_B_MA_14
BC16	VSS
BC14	DDR_A_DM_2
BC12	VSS
BC10	DDR_A_DM_1
BC9	DDR_A_DQ_13
BC8	VSS
BC6	DDR_A_DQSB_0
BC4	DDR_A_DQ_0
BC3	VSS
BC2	RSVD
BC1	VSS
BB44	RSVD
BB43	DDR_A_ODT_0
BB42	DDR_RCOMPYPU
BB41	DDR_A_CASB
BB39	DDR_A_CSB_2
BB38	DDR_A_RASB
BB36	DDR_A_BS_1
BB35	DDR_B_CSB_1
BB34	DDR_B_ODT_1
BB33	DDR_B_ODT_2
BB32	DDR_B_CASB

**Table 29. MCH  
Ballout Sorted By Ball**

Ball #	Signal Name
BB31	DDR_A_MA_1
BB30	DDR_A_MA_2
BB29	DDR_A_MA_3
BB28	DDR_A_MA_5
BB27	DDR_A_MA_12
BB26	DDR_A_BS_2
BB25	DDR_A_CKE_2
BB24	DDR_B_BS_0
BB23	RSVD
BB22	DDR_B_MA_2
BB21	DDR_B_MA_5
BB20	DDR_B_MA_6
BB19	DDR_B_MA_9
BB18	DDR_B_BS_2
BB17	DDR_B_CKE_2
BB16	DDR_A_DQ_18
BB15	DDR_A_DQ_23
BB14	DDR_A_DQ_17
BB13	DDR_A_DQ_21
BB12	DDR_A_DQ_10
BB11	DDR_A_DQ_15
BB10	DDR_A_DQ_9
BB8	DDR_A_DQ_2
BB7	DDR_A_DQ_7
BB5	DDR_A_DM_0
BB4	DDR_A_DQ_5
BB3	VSS_BB3
BB2	VSS
BA42	DDR_A_MA_13
BA41	DDR_A_ODT_2
BA40	DDR_A_CSB_0
BA37	RSVD
BA35	DDR_B_CSB_3
BA33	DDR_B_MA_13
BA31	DDR_B_CSB_0
BA29	DDR_A_MA_4
BA27	DDR_A_MA_9
BA25	DDR_A_MA_14
BA21	DDR_B_MA_3
BA19	DDR_B_MA_11
BA17	DDR_B_CKE_3
BA15	DDR_A_DQS_2
BA13	DDR_A_DQ_20
BA11	DDR_A_DQS_1
BA9	DDR_A_DQ_12



**Table 29. MCH Ballout Sorted By Ball**

Ball #	Signal Name
BA6	DDR_A_DQS_0
BA5	VSS_BA5
BA4	VSS_BA4
AY45	VCC_DDR
AY43	DDR_A_CSB_3
AY41	DDR_A_ODT_1
AY40	DDR_B_DM_4
AY39	DDR_B_DQ_32
AY38	DDR_B_DQ_36
AY36	VSS
AY35	DDR_B_ODT_3
AY34	DDR_B_CKB_5
AY33	VSS
AY31	DDR_B_WEB
AY30	DDR_B_CK_4
AY28	DDR_B_CKB_4
AY27	DDR_A_MA_7
AY25	DDR_B_DM_3
AY24	DDR_A_CKE_1
AY23	VCC_DDR
AY22	DDR_B_MA_0
AY21	DDR_A_DQ_25
AY19	DDR_B_MA_7
AY18	DDR_B_MA_12
AY16	DDR_B_DQ_16
AY15	DDR_A_DQSB_2
AY13	DDR_B_DQ_9
AY12	DDR_B_DQ_8
AY11	DDR_A_DQSB_1
AY10	VSS
AY8	DDR_B_DM_0
AY7	DDR_B_DQ_1
AY6	DDR_RCOMPXPD
AY5	DDR_RCOMPXPU
AY3	VSS_AY3
AY1	VSS_AY1
AW44	DDR_A_ODT_3
AW42	DDR_A_DQ_36
AW40	VSS
AW39	DDR_B_DQS_4
AW38	DDR_B_DQ_33
AW36	DDR_B_DQ_37
AW35	VSS
AW34	DDR_B_CK_5
AW33	DDR_B_CKB_2

**Table 29. MCH Ballout Sorted By Ball**

Ball #	Signal Name
AW31	VSS
AW30	DDR_B_CK_0
AW28	VSS
AW27	VSS
AW25	DDR_B_DQ_24
AW24	DDR_B_MA_10
AW23	DDR_B_BS_1
AW22	DDR_A_DQ_31
AW21	VSS
AW19	DDR_A_DQ_29
AW18	VSS
AW16	DDR_B_DM_2
AW15	VSS
AW13	DDR_B_DQ_13
AW12	DDR_B_DQ_12
AW11	DDR_B_DQ_7
AW10	DDR_B_DQS_0
AW8	DDR_B_DQ_0
AW7	VSS
AW6	DDR_B_DQ_5
AW4	VSS
AW2	VSS_AW2
AV45	VSS
AV43	VSS
AV42	DDR_A_DQ_32
AV40	DDR_B_DQ_39
AV39	DDR_B_DQ_38
AV38	DDR_B_DQSB_4
AV36	DDR_B_DQ_44
AV35	DDR_A_CKB_2
AV34	VSS
AV33	DDR_B_CK_2
AV31	DDR_A_CK_3
AV30	DDR_B_CKB_0
AV28	VSS
AV27	DDR_B_DQ_27
AV25	DDR_B_DQ_25
AV24	VSS
AV23	VSS
AV22	VSS
AV21	DDR_A_DQSB_3
AV19	DDR_A_DQ_28
AV18	VSS
AV16	DDR_B_DQ_17
AV15	DDR_B_DQ_11

**Table 29. MCH Ballout Sorted By Ball**

Ball #	Signal Name
AV13	VSS
AV12	VSS
AV11	VSS
AV10	VSS
AV8	DDR_B_DQ_4
AV7	DDR_VREF
AV6	VSS
AV4	VSS
AV3	VSS
AV1	VSS
AU44	DDR_A_DM_4
AU43	DDR_A_DQ_33
AU41	DDR_A_DQ_37
AU5	VCCA_EXP2
AU3	VSS
AU2	PEG2_TXP_14 <sup>(4)</sup>
AT45	VSS
AT43	DDR_A_DQS_4
AT42	DDR_A_DQSB_4
AT40	DDR_B_DQ_35
AT39	VSS
AT38	DDR_B_DQ_34
AT36	DDR_A_CKB_5
AT35	DDR_A_CK_5
AT34	DDR_A_CK_2
AT33	DDR_A_CK_0
AT31	DDR_A_CKB_3
AT30	VSS
AT28	VSS
AT27	DDR_B_DQ_26
AT25	DDR_B_DQ_30
AT24	VSS
AT23	VSS
AT22	DDR_A_DQ_27
AT21	DDR_A_DQS_3
AT19	DDR_B_DQ_19
AT18	DDR_B_DQ_22
AT16	VSS
AT15	DDR_B_DQ_10
AT13	DDR_B_DM_1
AT12	DDR_B_DQ_3
AT11	DDR_B_DQ_2
AT10	DDR_B_DQSB_0
AT8	VSS
AT7	DDR_RCOMPVOL





**Table 29. MCH  
Ballout Sorted By Ball**

Ball #	Signal Name
AT6	DDR_RCOMPVOH
AT4	PEG2_TXP_13 <sup>(4)</sup>
AT3	PEG2_TXN_14 <sup>(4)</sup>
AT1	VSS
AR44	DDR_A_DQ_34
AR42	DDR_A_DQ_35
AR41	DDR_A_DQ_38
AR40	DDR_A_DQ_39
AR39	VSS
AR38	VSS
AR36	DDR_B_DQ_40
AR35	VSS
AR34	DDR_B_DQ_45
AR33	DDR_A_CKB_0
AR31	DDR_B_CK_3
AR30	VSS
AR28	DDR_B_CK_1
AR27	VSS
AR25	DDR_B_DQS_3
AR24	DDR_B_DQSB_3
AR23	VSS
AR22	VSS
AR21	VSS
AR19	VSS
AR18	DDR_B_DQ_23
AR16	DDR_B_DQ_21
AR15	VSS
AR13	DDR_B_DQS_1
AR12	DDR_B_DQSB_1
AR11	DDR_B_DQ_6
AR10	VCCAPLL_EXP2
AR8	VSS
AR7	VSS
AR6	VSS
AR5	PEG2_TXN_13 <sup>(4)</sup>
AR4	VSS
AR2	PEG2_TXP_12 <sup>(4)</sup>
AP45	DDR_A_DQ_45
AP43	VSS
AP42	DDR_A_DQ_44
AP40	DDR_B_DQSB_5
AP39	DDR_B_DQS_5
AP38	VSS
AP36	DDR_B_DQ_41
AP35	DDR_B_DQ_42

**Table 29. MCH  
Ballout Sorted By Ball**

Ball #	Signal Name
AP34	RSVD
AP33	VSS
AP31	DDR_B_CKB_3
AP30	VSS
AP28	DDR_B_CKB_1
AP27	DDR_B_DQ_31
AP25	VSS
AP24	DDR_B_DQ_29
AP23	VSS
AP22	VSS
AP21	DDR_A_DM_3
AP19	DDR_B_DQ_18
AP18	VSS
AP16	DDR_B_DQSB_2
AP15	DDR_B_DQ_15
AP13	VSS
AP12	RSVD
AP11	PEG2_RXN_15 <sup>(4)</sup>
AP10	PEG2_RXP_15 <sup>(4)</sup>
AP8	VSS
AP7	PEG2_TXP_15 <sup>(4)</sup>
AP6	PEG2_TXN_15 <sup>(4)</sup>
AP4	PEG2_TXP_11 <sup>(4)</sup>
AP3	VCCR_EXP
AP1	PEG2_TXN_12 <sup>(4)</sup>
AN44	DDR_A_DM_5
AN42	DDR_A_DQ_41
AN41	DDR_A_DQ_40
AN40	DDR_B_DQ_47
AN39	DDR_B_DQ_46
AN38	VSS
AN36	DDR_B_DM_5
AN35	DDR_A_CB_1
AN34	VSS
AN33	DDR_B_DQ_43
AN31	RSVD
AN30	RSVD
AN28	DDR_A_CK_1
AN27	DDR_A_CK_4
AN25	RSVD
AN24	DDR_B_DQ_28
AN23	VSS
AN22	DDR_A_DQ_26
AN21	DDR_A_DQ_30
AN19	DDR_A_DQ_24

**Table 29. MCH  
Ballout Sorted By Ball**

Ball #	Signal Name
AN18	DDR_B_DQS_2
AN16	DDR_B_DQ_20
AN15	DDR_B_DQ_14
AN13	RSVD
AN12	RSVD
AN11	RSVD
AN10	EXP2_COMPI <sup>(4)</sup>
AN8	EXP2_COMPO <sup>(4)</sup>
AN7	VSS
AN6	VSS
AN5	PEG2_TXN_11 <sup>(4)</sup>
AN4	VSS
AN2	PEG2_TXP_10 <sup>(4)</sup>
AM45	VSS
AM43	DDR_A_DQS_5
AM42	DDR_A_DQSB_5
AM32	RSVD
AM30	VCC_CL
AM28	DDR_A_CKB_1
AM27	DDR_A_CKB_4
AM25	RSVD
AM24	VSS
AM23	VCC_CL
AM22	VCC_CL
AM21	VSS
AM19	PWROK
AM18	RSTINB
AM16	VSS
AM14	RSVD
AM4	PEG2_TXP_9 <sup>(4)</sup>
AM3	PEG2_TXN_10 <sup>(4)</sup>
AM1	VSS
AL44	DDR_A_DQ_42
AL42	DDR_A_DQ_43
AL41	DDR_A_DQ_47
AL40	DDR_A_DQ_46
AL39	VSS
AL38	DDR_A_DQS_8
AL36	DDR_A_DQSB_8
AL35	VSS
AL34	DDR_A_CB_5
AL33	DDR_A_CB_0
AL30	VCC_CL
AL28	RSVD
AL27	VCC_CL



**Table 29. MCH Ballout Sorted By Ball**

Ball #	Signal Name
AL25	VCC_CL
AL24	VCC_CL
AL23	VCC_CL
AL22	VCC_CL
AL21	VCC_CL
AL19	VCC_CL
AL18	VCC_CL
AL16	VCC_CL
AL13	CL_PWROK
AL12	VSS
AL11	PEG2_RXP_13 <sup>(4)</sup>
AL10	PEG2_RXN_13 <sup>(4)</sup>
AL8	VSS
AL7	PEG2_RXN_14 <sup>(4)</sup>
AL6	PEG2_RXP_14 <sup>(4)</sup>
AL5	PEG2_TXN_9 <sup>(4)</sup>
AL4	VSS
AL2	PEG2_TXP_8 <sup>(4)</sup>
AK45	DDR_B_CB_0
AK43	VSS
AK42	DDR_B_CB_5
AK40	VSS
AK39	DDR_A_CB_7
AK38	DDR_A_CB_2
AK36	VSS
AK35	DDR_A_CB_3
AK34	DDR_A_CB_6
AK33	DDR_A_CB_4
AK32	VSS
AK31	VCC_CL
AK15	CL_DATA
AK14	CL_CLK
AK13	PEG2_RXN_12 <sup>(4)</sup>
AK12	PEG2_RXP_12 <sup>(4)</sup>
AK11	VSS
AK10	VSS
AK8	VSS
AK7	VSS
AK6	VSS
AK4	PEG2_TXP_7 <sup>(4)</sup>
AK3	VCCR_EXP
AK1	PEG2_TXN_8 <sup>(4)</sup>
AJ44	DDR_B_CB_1
AJ42	DDR_B_CB_4
AJ41	VSS

**Table 29. MCH Ballout Sorted By Ball**

Ball #	Signal Name
AJ29	VCC_CL
AJ28	VCC_CL
AJ27	VCC_CL
AJ26	VCC_CL
AJ25	VCC_CL
AJ24	VCC_CL
AJ23	VCC_CL
AJ22	VCC_CL
AJ21	VCC_CL
AJ20	VCC_CL
AJ19	VCC_CL
AJ18	VCC_CL
AJ17	VCC_CL
AJ5	PEG2_TXN_7 <sup>(4)</sup>
AJ4	VSS
AJ2	PEG2_TXP_6 <sup>(4)</sup>
AH45	VSS
AH43	DDR_B_DQS_8
AH42	DDR_B_DQSB_8
AH40	VSS
AH39	VSS
AH38	VSS
AH36	DDR_B_DQ_53
AH35	VSS
AH34	DDR_B_DQ_48
AH33	DDR_B_DQ_52
AH32	VSS
AH31	VCC_CL
AH29	VCC_CL
AH28	RSVD
AH27	VSS
AH26	VCC
AH25	VSS
AH24	VCC
AH23	VSS
AH22	VCC
AH21	VSS
AH20	VCC
AH19	VCC
AH18	VCC
AH17	VCC
AH15	VCC_CL
AH14	VCC_CL
AH13	PEG2_RXN_9 <sup>(4)</sup>
AH12	VSS

**Table 29. MCH Ballout Sorted By Ball**

Ball #	Signal Name
AH11	PEG2_RXP_10 <sup>(4)</sup>
AH10	PEG2_RXN_10 <sup>(4)</sup>
AH8	VSS
AH7	PEG2_RXP_11 <sup>(4)</sup>
AH6	PEG2_RXN_11 <sup>(4)</sup>
AH4	PEG2_TXP_5 <sup>(4)</sup>
AH3	PEG2_TXN_6 <sup>(4)</sup>
AH1	VSS
AG44	DDR_B_CB_7
AG42	DDR_B_CB_2
AG41	DDR_B_CB_6
AG40	DDR_B_CB_3
AG39	DDR_B_DQS_6
AG38	DDR_B_DQSB_6
AG36	VSS
AG35	DDR_B_DM_6
AG34	VSS
AG33	DDR_B_DQ_49
AG32	RSVD
AG31	VCC_CL
AG29	VCC_CL
AG28	RSVD
AG27	VCC
AG26	VSS
AG25	VCC
AG24	VSS
AG23	VCC
AG22	VSS
AG21	VCC
AG20	VSS
AG19	VCC
AG18	VCC
AG17	VCC
AG15	VCC
AG14	CL_VREF
AG13	VSS
AG12	PEG2_RXP_9 <sup>(4)</sup>
AG11	CL_RSTB
AG10	VSS
AG8	VSS
AG7	VSS
AG6	VSS
AG5	PEG2_TXN_5 <sup>(4)</sup>
AG4	VSS
AG2	PEG2_TXP_4 <sup>(4)</sup>



**Table 29. MCH  
Ballout Sorted By Ball**

Ball #	Signal Name
AF45	DDR_A_DQ_53
AF43	VSS
AF42	DDR_A_DQ_52
AF29	VCC_CL
AF28	VCC
AF27	VSS
AF26	VCC
AF25	VSS
AF24	VCC
AF23	VSS
AF22	VCC
AF21	VSS
AF20	VCC
AF19	VSS
AF18	VCC
AF17	VCC
AF4	PEG2_TXP_3 <sup>(4)</sup>
AF3	VCCR_EXP
AF1	PEG2_TXN_4 <sup>(4)</sup>
AE44	DDR_A_DM_6
AE42	DDR_A_DQ_49
AE41	DDR_A_DQ_48
AE40	DDR_B_DQ_54
AE39	DDR_B_DQ_50
AE38	DDR_B_DQ_51
AE36	VSS
AE35	DDR_B_DQ_60
AE34	DDR_B_DQ_61
AE33	DDR_B_DQ_55
AE32	VSS
AE31	VCC_CL
AE29	VCC_CL
AE28	VCC
AE27	VCC
AE26	VSS
AE25	VCC
AE24	VSS
AE23	VCC
AE22	VSS
AE21	VCC
AE20	VSS
AE19	VCC
AE18	VCC
AE17	VCC
AE15	VCCR_EXP

**Table 29. MCH  
Ballout Sorted By Ball**

Ball #	Signal Name
AE14	EXP2_CLKINP
AE13	PEG2_RXP_6 <sup>(4)</sup>
AE12	VSS
AE11	PEG2_RXN_7 <sup>(4)</sup>
AE10	PEG2_RXP_7 <sup>(4)</sup>
AE8	VSS
AE7	PEG2_RXP_8 <sup>(4)</sup>
AE6	PEG2_RXN_8 <sup>(4)</sup>
AE5	PEG2_TXN_3 <sup>(4)</sup>
AE4	VSS
AE2	PEG2_TXP_2 <sup>(4)</sup>
AD45	VSS
AD43	DDR_A_DQS_6
AD42	DDR_A_DQSB_6
AD40	DDR_A_DQ_54
AD39	DDR_B_DQ_56
AD38	VSS
AD36	DDR_B_DQ_57
AD35	DDR_B_DM_7
AD34	VSS
AD33	DDR_B_DQSB_7
AD32	RSVD
AD31	VCC_CL
AD29	VCC_CL
AD28	VCC
AD27	VSS
AD26	VCC
AD25	VSS
AD24	VCC
AD23	VSS
AD22	VCC
AD21	VSS
AD20	VCC
AD19	VSS
AD18	VCC
AD17	VCC
AD15	VCCR_EXP
AD14	EXP2_CLKINN
AD13	VSS
AD12	PEG2_RXN_6 <sup>(4)</sup>
AD11	VCC_EXP
AD10	VCC_EXP
AD8	VCC_EXP
AD7	VCC_EXP
AD6	VSS

**Table 29. MCH  
Ballout Sorted By Ball**

Ball #	Signal Name
AD4	PEG2_TXP_1 <sup>(4)</sup>
AD3	PEG2_TXN_2 <sup>(4)</sup>
AD1	VSS
AC45	DDR_A_DQ_51
AC43	VSS
AC42	DDR_A_DQ_50
AC40	DDR_A_DQ_60
AC39	DDR_A_DQ_55
AC38	VSS
AC36	DDR_B_DQ_62
AC35	VSS
AC34	DDR_B_DQ_63
AC33	DDR_B_DQS_7
AC32	VSS
AC31	VCC_CL
AC29	VCC_CL
AC28	VCC
AC27	VCC
AC26	VSS
AC25	VCC
AC24	VSS
AC23	VCC
AC22	VSS
AC21	VCC
AC20	VSS
AC19	VCC
AC18	VCC
AC17	VCC
AC15	VCCR_EXP
AC14	VSS
AC13	PEG2_RXP_3 <sup>(4)</sup>
AC12	VSS
AC11	PEG2_RXP_4 <sup>(4)</sup>
AC10	PEG2_RXN_4 <sup>(4)</sup>
AC8	VSS
AC7	PEG2_RXN_5 <sup>(4)</sup>
AC6	PEG2_RXP_5 <sup>(4)</sup>
AC4	PEG2_TXN_1 <sup>(4)</sup>
AC3	VCCR_EXP
AC1	VSS
AB45	VSS
AB43	DDR_A_DQ_57
AB42	DDR_A_DQ_56
AB40	DDR_A_DM_7
AB39	DDR_A_DQ_61



**Table 29. MCH Ballout Sorted By Ball**

Ball #	Signal Name
AB38	DDR_B_DQ_59
AB36	VSS
AB35	FSB_AB_34
AB34	FSB_AB_29
AB33	VSS
AB32	DDR_B_DQ_58
AB31	VCC_CL
AB29	VCC_CL
AB28	VCC
AB27	VSS
AB26	VCC
AB25	VSS
AB24	VCC
AB23	VSS
AB22	VCC
AB21	VSS
AB20	VCC
AB19	VSS
AB18	VCC
AB17	VCC
AB15	VCC
AB14	VCCR_EXP
AB13	VCC_EXT_PLL
AB12	PEG2_RXN_3 <sup>(4)</sup>
AB11	VCC_EXP
AB10	VCC_EXP
AB8	VCC_EXP
AB7	VCC_EXP
AB6	VCC_EXP
AB4	VCC_EXP
AB3	PEG2_TXP_0 <sup>(4)</sup>
AB1	PEG2_TXN_0 <sup>(4)</sup>
AA44	DDR_A_DQSB_7
AA42	DDR_A_DQS_7
AA41	DDR_A_DQ_62
AA40	FSB_AB_33
AA39	VSS
AA38	FSB_AB_35
AA36	VSS
AA35	FSB_AB_32
AA34	VSS
AA33	FSB_AB_31
AA32	VSS
AA31	VCC_CL
AA29	VCC_CL

**Table 29. MCH Ballout Sorted By Ball**

Ball #	Signal Name
AA28	VCC
AA27	VCC
AA26	VSS
AA25	VCC
AA24	VSS
AA23	VCC
AA22	VSS
AA21	VCC
AA20	VSS
AA19	VCC
AA18	VCC
AA17	VCC
AA15	VCCR_EXP
AA14	VCCR_EXP
AA13	PEG2_RXN_0 <sup>(4)</sup>
AA12	VSS
AA11	PEG2_RXN_1 <sup>(4)</sup>
AA10	PEG2_RXP_1 <sup>(4)</sup>
AA8	VSS
AA7	PEG2_RXN_2 <sup>(4)</sup>
AA6	PEG2_RXP_2 <sup>(4)</sup>
AA5	VCC_EXP
AA4	VCC_EXP
AA2	VCC_EXP
Y45	DDR_A_DQ_63
Y43	VSS
Y42	DDR_A_DQ_58
Y29	VCC_CL
Y28	VCC
Y27	VSS
Y26	VCC
Y25	VSS
Y24	VCC
Y23	VSS
Y22	VCC
Y21	VSS
Y20	VCC
Y19	VSS
Y18	VCC
Y17	VCC
Y4	VCC_EXP
Y3	VCC_EXP
Y1	VCC_EXP
W44	FSB_BREQ0B
W42	DDR_A_DQ_59

**Table 29. MCH Ballout Sorted By Ball**

Ball #	Signal Name
W41	FSB_RSB_1
W40	FSB_TRDYB
W39	VSS
W38	FSB_AB_22
W36	FSB_AB_30
W35	VSS
W34	FSB_AB_25
W33	FSB_AB_27
W32	RSVD
W31	VSS_W31
W29	VCC_CL
W28	VCC
W27	VCC
W26	VSS
W25	VCC
W24	VSS
W23	VCC
W22	VSS
W21	VCC
W20	VSS
W19	VCC
W18	VCC
W17	VCC
W15	VCCR_EXP
W14	VSS
W13	VSS
W12	PEG2_RXP_0 <sup>(4)</sup>
W11	VCC_EXP
W10	VCC_EXP
W8	VCC_EXP
W7	VCC_EXP
W6	VSS
W5	VCC_EXP
W4	VCC_EXP
W2	VCC_EXP
V45	VSS
V43	FSB_AB_28
V42	FSB_HITMB
V40	VSS
V39	FSB_AB_24
V38	FSB_AB_23
V36	VSS
V35	FSB_AB_26
V34	FSB_ADSTBB_1
V33	VSS



**Table 29. MCH  
Ballout Sorted By Ball**

Ball #	Signal Name
V32	RSVD
V31	VCC_CL
V29	VCC_CL
V28	VCC
V27	VSS
V26	VCC
V25	VSS
V24	VCC
V23	VSS
V22	VCC
V21	VSS
V20	VCC
V19	VSS
V18	VCC
V17	VCC
V15	VCCR_EXP
V14	VCCR_EXP
V13	VSS
V12	RSVD
V11	DMI_TXN_3
V10	DMI_TXP_3
V8	VSS
V7	DMI_RXP_3
V6	DMI_RXN_3
V4	VCC_EXP
V3	VCC_EXP
V1	VCC_EXP
U44	FSB_ADSB
U42	FSB_BNRB
U41	FSB_DRDYB
U29	VCCAUX
U28	VCC
U27	VCC
U26	VCC
U25	VCC
U24	VCC
U23	VCC
U22	VCC
U21	VCC
U20	VCC
U19	VCC
U18	VCC
U17	VCC
U5	VCC_EXP
U4	VCC_EXP

**Table 29. MCH  
Ballout Sorted By Ball**

Ball #	Signal Name
U2	VCC_EXP
T45	FSB_LOCKB
T43	VSS
T42	FSB_DBSYB
T40	FSB_AB_17
T39	FSB_DEFERB
T38	FSB_AB_20
T36	FSB_AB_18
T35	VSS
T34	FSB_AB_19
T33	RSVD
T32	VSS
T31	VCCAUX
T15	VCCR_EXP
T14	VCCR_EXP
T13	VSS
T12	RSVD
T11	VSS
T10	EXP_COMPO
T8	DMI_RXN_1
T7	DMI_RXP_1
T6	VSS
T4	VCC_EXP
T3	VCC_EXP
T1	DMI_TXN_2
R44	FSB_RSB_0
R42	FSB_HITB
R41	FSB_RSB_2
R40	VSS
R39	FSB_AB_14
R38	VSS
R36	FSB_AB_10
R35	FSB_AB_16
R34	VSS
R33	RSVD
R30	VCCAUX
R28	VCCAUX
R27	VCCAUX
R25	VCCAUX
R24	VCCAUX
R23	VCCAUX
R22	RSVD
R21	VSS
R19	RSVD
R18	VCC

**Table 29. MCH  
Ballout Sorted By Ball**

Ball #	Signal Name
R16	VCC
R13	VSS
R12	VSS
R11	VSS
R10	EXP_COMPI
R8	VSS
R7	DMI_TXP_0
R6	DMI_TXN_0
R5	DMI_RXN_2
R4	VSS
R2	DMI_TXP_2
P45	VSS
P43	FSB_AB_21
P42	FSB_DB_0
P32	VSS
P30	HPL_CLKINN
P28	HPL_CLKINP
P27	VSS
P25	VSS
P24	VSS
P23	VSS
P22	VSS
P21	RSVD
P19	RSVD_P19
P18	VSS
P16	ICH_SYNCB
P14	VSS
P4	DMI_RXP_2
P3	DMI_TXN_1
P1	VSS
N44	FSB_DB_2
N42	FSB_DB_4
N41	FSB_DB_1
N40	FSB_AB_9
N39	FSB_AB_11
N38	FSB_AB_13
N36	FSB_AB_8
N35	VSS
N34	FSB_AB_12
N33	FSB_DB_28
N31	FSB_DB_30
N30	FSB_DB_37
N28	FSB_DINVB_2
N27	VSS
N25	FSB_DSTBPB_2



**Table 29. MCH Ballout Sorted By Ball**

Ball #	Signal Name
N24	FSB_DB_42
N23	VSS
N22	VSS
N21	RSVD
N19	VSS
N18	RSVD
N16	VSS
N15	VCC_N15
N13	PEG_RXP_4
N12	RSVD
N11	RSVD
N10	PEG_RXN_15
N8	PEG_RXP_15
N7	VSS
N6	VSS
N5	DMI_RXP_0
N4	VSS
N2	DMI_TXP_1
M45	FSB_DB_5
M43	VSS
M42	FSB_DB_3
M40	FSB_ADSTBB_0
M39	VSS
M38	FSB_AB_4
M36	FSB_AB_5
M35	VSS
M34	VSS
M33	VSS
M31	FSB_DB_31
M30	FSB_DB_35
M28	VSS
M27	VTT_FSB
M25	FSB_DSTBNB_2
M24	VSS
M23	VSS
M22	BSELO
M21	ALLZTEST
M19	RSVD_M19
M18	VSS
M16	RSVD
M15	VSS_M15
M13	PEG_RXN_4
M12	VSS
M11	PEG_RXP_12
M10	VSS

**Table 29. MCH Ballout Sorted By Ball**

Ball #	Signal Name
M8	PEG_RXN_13
M7	PEG_RXP_13
M6	VSS
M4	DMI_RXN_0
M3	VCCR_EXP
M1	PEG_TXP_15
L44	FSB_DB_6
L42	FSB_DB_7
L41	FSB_DINVB_0
L40	FSB_AB_7
L39	FSB_REQB_2
L38	VSS
L36	FSB_DB_19
L35	VSS
L34	FSB_DB_27
L33	FSB_DB_29
L31	VSS
L30	FSB_DB_36
L28	FSB_DB_41
L27	VTT_FSB
L25	FSB_DB_43
L24	FSB_DB_44
L23	VSS
L22	XORTEST
L21	VSS
L19	RSVD
L18	RSVD
L16	VCC3_3_L16
L15	VSS
L13	PEG_RXP_3
L12	PEG_RXN_6
L11	VSS
L10	PEG_RXN_12
L8	VSS
L7	VSS
L6	VSS
L5	PEG_TXP_14
L4	VSS
L2	PEG_TXN_15
K45	VSS
K43	FSB_DSTBNB_0
K42	FSB_AB_15
K40	VSS
K39	VSS
K38	FSB_AB_6

**Table 29. MCH Ballout Sorted By Ball**

Ball #	Signal Name
K36	FSB_REQB_3
K35	FSB_DB_21
K34	FSB_DB_24
K33	VSS
K31	FSB_DB_33
K30	VSS
K28	FSB_DB_40
K27	VTT_FSB
K25	VTT_FSB
K24	FSB_DB_46
K23	VSS
K22	RSVD
K21	RSVD
K19	EXP_SLR
K18	VSS
K16	VSS_K16
K15	VSS
K13	PEG_RXN_3
K12	VSS
K11	PEG_RXP_6
K10	VSS
K8	PEG_RXN_11
K7	PEG_RXP_11
K6	VSS
K4	PEG_TXN_14
K3	PEG_RXP_14
K1	VSS
J44	FSB_DSTBPB_0
J43	FSB_DB_8
J41	FSB_DB_10
J5	PEG_TXP_13
J3	VSS
J2	PEG_RXN_14
H45	FSB_DB_12
H43	VSS
H42	FSB_DB_9
H40	VSS
H39	FSB_REQB_4
H38	FSB_BPRIB
H36	VSS
H35	VSS
H34	FSB_DSTBPB_1
H33	FSB_DB_25
H31	FSB_DB_34
H30	FSB_DB_39



**Table 29. MCH Ballout Sorted By Ball**

Ball #	Signal Name
H28	VTT_FSB
H27	VTT_FSB
H25	VTT_FSB
H24	FSB_DB_45
H23	VSS
H22	VSS
H21	RSVD
H19	VSS
H18	VSS
H16	VSS_H16
H15	RSVD_H15
H13	PEG_RXP_2
H12	PEG_RXP_5
H11	VSS
H10	PEG_RXN_7
H8	VSS
H7	VSS
H6	VSS
H4	PEG_TXN_13
H3	VCCR_EXP
H1	PEG_TXP_12
G44	FSB_DB_13
G42	FSB_DB_11
G40	FSB_REQB_1
G39	VSS
G38	FSB_DB_20
G36	FSB_DB_22
G35	FSB_DB_23
G34	FSB_DSTBNB_1
G33	VSS
G31	VSS
G30	FSB_DB_38
G28	VTT_FSB
G27	VTT_FSB
G25	VTT_FSB
G24	FSB_DB_47
G23	VSS
G22	RSVD
G21	TCEN
G19	RSVD
G18	VSS
G16	VCC3_3_G16
G15	RSVD_G15
G13	PEG_RXN_2
G12	PEG_RXN_5

**Table 29. MCH Ballout Sorted By Ball**

Ball #	Signal Name
G11	VSS
G10	PEG_RXP_7
G8	VSS
G7	VSS
G6	PEG_RXN_9
G4	VSS
G2	PEG_TXN_12
F45	VSS
F43	FSB_AB_3
F41	FSB_DB_14
F40	VSS
F39	FSB_DB_17
F38	FSB_DB_16
F36	VSS
F35	FSB_DB_48
F34	VSS
F33	FSB_DB_26
F31	FSB_DB_32
F30	VTT_FSB
F28	VTT_FSB
F27	VTT_FSB
F25	VTT_FSB
F24	VSS
F23	VSS
F22	VSS_F22
F21	BSEL1
F19	RSVD
F18	BSEL2
F16	VSS
F15	VSS
F13	VSS
F12	VSS
F11	VSS
F10	VSS
F8	VSS
F7	PEG_RXP_9
F6	VSS
F5	PEG_TXP_11
F3	PEG_TXP_10
F1	VSS
E42	FSB_DB_15
E41	FSB_DB_50
E40	FSB_DINVB_1
E37	FSB_DB_61
E35	FSB_DB_63

**Table 29. MCH Ballout Sorted By Ball**

Ball #	Signal Name
E33	VTT_FSB
E31	VTT_FSB
E29	VTT_FSB
E27	FSB_DVREF
E25	VCC_E25
E21	VSS
E19	VSS
E17	PEG_TXN_0
E15	PEG_TXP_1
E13	PEG_TXP_2
E11	PEG_TXN_4
E9	PEG_TXN_6
E6	PEG_RXP_8
E5	VSS
E4	PEG_TXN_11
D44	FSB_DB_52
D43	FSB_DB_53
D42	VSS
D41	FSB_DSTBNB_3
D39	FSB_DB_57
D38	FSB_DB_54
D36	FSB_DB_59
D35	FSB_CPURSTB
D34	VSS
D33	VTT_FSB
D32	VTT_FSB
D31	VTT_FSB
D30	VTT_FSB
D29	VSS
D28	FSB_SCOMP
D27	FSB_ACCVREF
D26	VCCA_HPL
D25	VCCA_HPL
D24	VSS_D24
D23	VSS
D22	VSS_D22
D21	VSS_D21
D20	VCCA_EXP
D19	EXP_CLKINP
D18	EXP_CLKINN
D17	VSS
D16	PEG_TXP_0
D15	VSS
D14	PEG_TXN_1
D13	VSS



**Table 29. MCH Ballout Sorted By Ball**

Ball #	Signal Name
D12	PEG_TXN_2
D11	VSS
D10	PEG_TXP_4
D8	PEG_TXP_6
D7	VSS
D5	PEG_RXN_8
D4	VSS
D3	PEG_TXN_10
D2	PEG_RXP_10
C45	VSS
C44	FSB_REQB_0
C43	VSS
C42	FSB_DB_51
C40	FSB_DSTBPB_3
C38	VSS
C37	FSB_DB_60
C36	FSB_DB_58
C34	VSS
C32	VTT_FSB
C30	VSS
C28	FSB_SCOMPB
C26	FSB_RCOMP
C24	VSS_C24
C23	VSS_C23
C22	VSS
C20	VSS
C18	VCC_C18
C16	VCCR_EXP
C14	PEG_RXN_1
C12	VCCR_EXP
C10	PEG_TXN_5
C9	VSS
C8	VCCR_EXP
C6	PEG_TXP_8
C4	PEG_TXN_8
C3	VSS
C2	PEG_RXN_10
C1	VSS
B45	NC
B44	VSS
B43	FSB_DB_18
B42	FSB_DB_55
B39	FSB_DB_56
B37	FSB_DINVB_3
B35	FSB_DB_62

**Table 29. MCH Ballout Sorted By Ball**

Ball #	Signal Name
B33	VTT_FSB
B31	VTT_FSB
B29	VSS
B27	VCCA_MPL
B25	VCC_B25
B21	VSS_B21
B19	RSVD
B17	VSS_B17
B15	PEG_RXN_0
B13	PEG_RXP_1
B11	PEG_TXP_3
B9	PEG_TXP_5
B7	PEG_TXP_7
B4	PEG_TXN_9
B3	PEG_TXP_9
B2	VSS
B1	NC
A45	TEST3
A44	NC
A43	VSS
A40	VSS
A38	FSB_DB_49
A36	VSS
A34	VSS
A32	VTT_FSB
A30	VTT_FSB
A28	FSB_SWING
A26	VSS
A24	VSS_A24
A23	VCC3_3
A22	VSS
A20	VCCAPLL_EXP
A18	VSS
A16	PEG_RXP_0
A14	VSS
A12	PEG_TXN_3
A10	VSS
A8	PEG_TXN_7
A6	VSS
A3	VSS
A2	TEST2

**NOTE:** See list of notes at beginning of chapter.



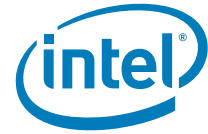

## 12.2 Package Information

The MCH is available in a 40 mm [1.57 in] x 40 mm [1.57 in] Flip Chip Ball Grid Array (FC-BGA) package with an integrated heat spreader (IHS) and 1300 solder balls. Figure 15 shows the package dimensions.

Figure 15. MCH Package Drawing

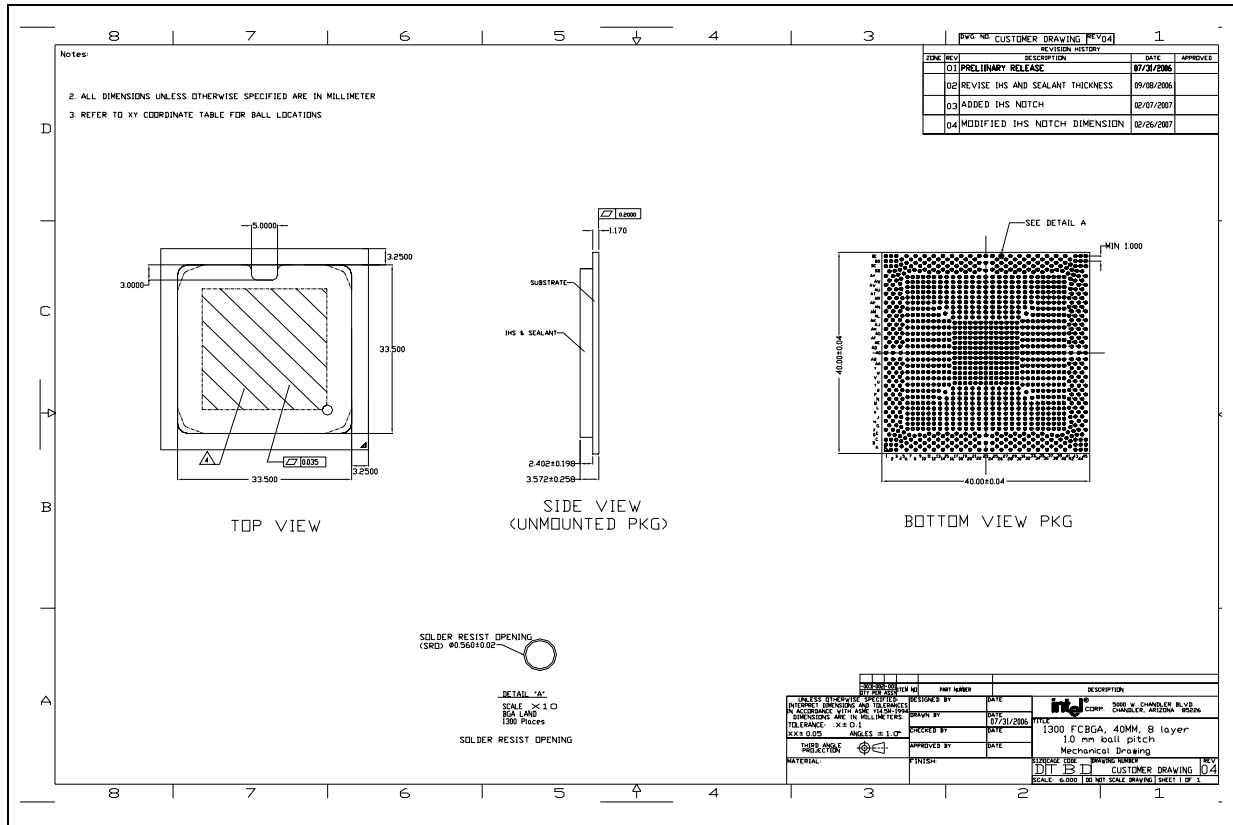

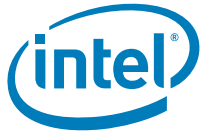



# 13 Testability

In the MCH, testability for Automated Test Equipment (ATE) board level testing has been implemented as an XOR chain. An XOR-tree is a chain of XOR gates each with one input pin connected to it which allows for pad to ball to trace connection testing.

The XOR testing methodology is to boot the part using straps to enter XOR mode (A description of the boot process follows). Once in XOR mode, all of the pins of an XOR chain are driven to logic 1. This action will force the output of that XOR chain to either a 1 if the number of the pins making up the chain is even or a 0 if the number of the pins making up the chain is odd.

Once a valid output is detected on the XOR chain output, a walking 0 pattern is moved from one end of the chain to the other. Every time the walking 0 is applied to a pin on the chain, the output will toggle. If the output does not toggle, there is a disconnect somewhere between die, package, and board and the system can be considered a failure.

## 13.1 XOR Test Mode Initialization

Figure 16. XOR Test Mode Initialization Cycles

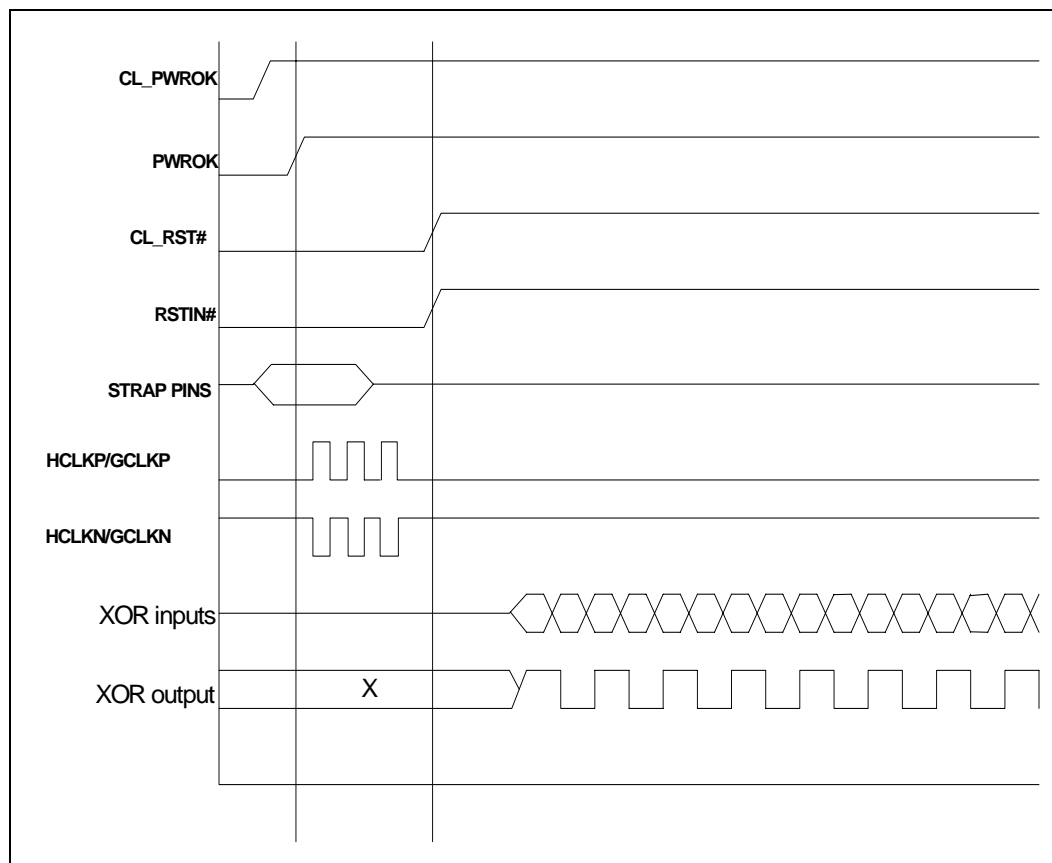



The above figure shows the wave forms to be able to boot the part into XOR mode. The straps that need to be controlled during this boot process are BSEL[2:0], RSVD (Ball L18), EXP\_SLR, and XORTEST.

On the 3200 and 3210 Chipset platforms, all strap values must be driven before PWROK asserts. BSEL0 must be a 1. BSEL[2:1] need to be defined values, but logic value in any order will do. XORTEST must be driven to 0.

Not all of the pins will be used in all implementations. Due to the need to minimize test points and unnecessary routing, the XOR Chain 14 is dynamic depending on the values of EXP\_SLR, and RSVD (Ball L18). See Figure 30 for what parts of XOR Chain 14 become valid XOR inputs depending on the use of EXP\_SLR and RSVD (Ball L18).

## 13.2 XOR Chain Definition

The MCH has 15 XOR chains. The XOR chain outputs are driven out on the following output pins. During fullwidth testing, XOR chain outputs will be visible on both pins.

Table 30. XOR Chain 14 Functionality

RSVD (Ball L18)	EXP_SLR	XOR Chain 14
1	0	EXP_RXP[15:0] EXP_RXN[15:0] EXP_TXP[15:0] EXP_TXN[15:0]
1	1	EXP_RXP[15:0] EXP_RXN[15:0] EXP_TXP[15:0] EXP_TXN[15:0]
0	0	EXP_RXP[15:8] EXP_RXN[15:8] EXP_TXP[15:8] EXP_TXN[15:8]
0	1	EXP_RXP[7:0] EXP_RXN[7:0] EXP_TXP[7:0] EXP_TXN[7:0]
1	0	EXP_RXP[15:0] EXP_RXN[15:0] EXP_TXP[15:0] EXP_TXN[15:0]
1	1	EXP_RXP[15:0] EXP_RXN[15:0] EXP_TXP[15:0] EXP_TXN[15:0]



Table 31. XOR Chain Outputs

XOR Chain	Output Pins	Coordinate Location
xor_out0	ALLZTEST	M21
xor_out1	XORTEST	L22
xor_out2	ICH_SYNCB	P16
xor_out3	RSVD	N18
xor_out4	RSVD	AN12
xor_out5	RSVD	AM14
xor_out6	BSEL1	F21
xor_out7	BSEL2	F18
xor_out8	RSVD	AN13
xor_out9	RSVD	AP12
xor_out10	EXP_SLR	K19
xor_out11	RSVD	L18
xor_out12	BSEL0	M22
xor_out13	RSVD	H21
xor_out14	RSVD	G22

### 13.3 XOR Chains

This section provides the XOR chains.



## 13.4 XOR Chains

Table 32. XOR Chain 0

Pin Count	Ball #	Chain 0
	M21	ALLZTEST
1	B39	FSB_DB_56
2	D44	FSB_DB_52
3	B42	FSB_DB_55
4	D39	FSB_DB_57
5	C42	FSB_DB_51
6	C36	FSB_DB_58
7	A38	FSB_DB_49
8	B35	FSB_DB_62
9	D38	FSB_DB_54
10	E41	FSB_DB_50
11	D43	FSB_DB_53
12	D36	FSB_DB_59
13	E35	FSB_DB_63
14	E37	FSB_DB_61
15	F35	FSB_DB_48
16	C37	FSB_DB_60
17	F33	FSB_DB_26
18	B43	FSB_DB_18
19	F39	FSB_DB_17
20	F38	FSB_DB_16
21	H33	FSB_DB_25
22	G36	FSB_DB_22
23	G38	FSB_DB_20
24	G35	FSB_DB_23
25	L36	FSB_DB_19
26	L33	FSB_DB_29
27	L34	FSB_DB_27
28	N33	FSB_DB_28
29	N31	FSB_DB_30
30	K34	FSB_DB_24
31	M31	FSB_DB_31
32	K35	FSB_DB_21
33	L24	FSB_DB_44

Table 32. XOR Chain 0

Pin Count	Ball #	Chain 0
34	H24	FSB_DB_45
35	G24	FSB_DB_47
36	K28	FSB_DB_40
37	K24	FSB_DB_46
38	F31	FSB_DB_32
39	L30	FSB_DB_36
40	G30	FSB_DB_38
41	N24	FSB_DB_42
42	H31	FSB_DB_34
43	H30	FSB_DB_39
44	L28	FSB_DB_41
45	M30	FSB_DB_35
46	N30	FSB_DB_37
47	K31	FSB_DB_33
48	L25	FSB_DB_43
49	E42	FSB_DB_15
50	F41	FSB_DB_14
51	G42	FSB_DB_11
52	G44	FSB_DB_13
53	H42	FSB_DB_9
54	J43	FSB_DB_8
55	H45	FSB_DB_12
56	L42	FSB_DB_7
57	M45	FSB_DB_5
58	M42	FSB_DB_3
59	L44	FSB_DB_6
60	J41	FSB_DB_10
61	P42	FSB_DB_0
62	N41	FSB_DB_1
63	N42	FSB_DB_4
64	N44	FSB_DB_2



**Table 33. XOR Chain 1**

Pin Count	Ball #	Chain 1
	L22	XORTEST
1	H39	FSB_REQB_4
2	K42	FSB_AB_15
3	G40	FSB_REQB_1
4	K36	FSB_REQB_3
5	F43	FSB_AB_3
6	M36	FSB_AB_5
7	K38	FSB_AB_6
8	M38	FSB_AB_4
9	L40	FSB_AB_7
10	C44	FSB_REQB_0
11	M40	FSB_ADSTBB_0
12	N40	FSB_AB_9
13	L39	FSB_REQB_2
14	N36	FSB_AB_8
15	N39	FSB_AB_11
16	N38	FSB_AB_13
17	R35	FSB_AB_16
18	N34	FSB_AB_12
19	R39	FSB_AB_14
20	R36	FSB_AB_10
21	T34	FSB_AB_19
22	P43	FSB_AB_21
23	T40	FSB_AB_17
24	W34	FSB_AB_25
25	W36	FSB_AB_30
26	T38	FSB_AB_20
27	V35	FSB_AB_26
28	W33	FSB_AB_27
29	W38	FSB_AB_22
30	V34	FSB_ADSTBB_1
31	AA33	FSB_AB_31
32	T36	FSB_AB_18
33	AB35	FSB_AB_34
34	AA35	FSB_AB_32

**Table 33. XOR Chain 1**

Pin Count	Ball #	Chain 1
35	V38	FSB_AB_23
36	AB34	FSB_AB_29
37	V39	FSB_AB_24
38	AA40	FSB_AB_33
39	V43	FSB_AB_28
40	AA38	FSB_AB_35

**Table 34. XOR Chain 2**

Pin Count	Ball #	Chain 2
	P16	ICH_SYNCB
1	G34	FSB_DSTBNB_1
2	H34	FSB_DSTBPB_1
3	W41	FSB_RSB_1
4	R42	FSB_HITB
5	W40	FSB_TRDYB
6	V42	FSB_HITMB
7	M25	FSB_DSTBNB_2
8	N25	FSB_DSTBPB_2
9	K43	FSB_DSTBNB_0
10	J44	FSB_DSTBPB_0
11	T45	FSB_LOCKB
12	U42	FSB_BNRB
13	H38	FSB_BPRIB
14	D35	FSB_CPURSTB

**Table 35. XOR Chain 3**

Pin Count	Ball #	Chain 3
	N18	RSVD
1	D41	FSB_DSTBNB_3
2	C40	FSB_DSTBPB_3
3	B37	FSB_DINVB_3
4	E40	FSB_DINVB_1



**Table 35. XOR Chain 3**

Pin Count	Ball #	Chain 3
5	T39	FSB_DEFERB
6	R44	FSB_RSB_0
7	U41	FSB_DRDYB
8	T42	FSB_DBSYB
9	R41	FSB_RSB_2
10	N28	FSB_DINVB_2
11	L41	FSB_DINVB_0
12	W44	FSB_BREQ0B
13	U44	FSB_ADSB

**Table 36. XOR Chain 4**

Pin Count	Ball #	Chain 4
22	AN28	DDR_A_CK_1
23	AR33	DDR_A_CKB_0
24	AM28	DDR_A_CKB_1
25	BD29	DDR_A_MA_6
26	BB31	DDR_A_MA_1
27	BB28	DDR_A_MA_5
28	BC28	DDR_A_MA_8
29	AY27	DDR_A_MA_7
30	AY24	DDR_A_CKE_0
31	BB25	DDR_A_CKE_1
32	AV21	DDR_A_QOSB_3
33	AP21	DDR_A_DM_3
34	AY15	DDR_A_QOSB_2
35	BC14	DDR_A_DM_2
36	AY11	DDR_A_QOSB_1
37	BC10	DDR_A_DM_1
38	BC6	DDR_A_QOSB_0
39	BB5	DDR_A_DM_0

**Table 36. XOR Chain 4**

Pin Count	Ball #	Chain 4
	AN12	RSVD
1	AK35	DDR_A_CB_3
2	AL33	DDR_A_CB_0
3	AK34	DDR_A_CB_6
4	AK33	DDR_A_CB_4
5	AK39	DDR_A_CB_7
6	AN35	DDR_A_CB_1
7	AL34	DDR_A_CB_5
8	AK38	DDR_A_CB_2
9	AY41	DDR_A_ODT_1
10	BB39	DDR_A_CSB_1
11	BD42	DDR_A_CSB_0
12	BD37	DDR_A_MA_10
13	BB43	DDR_A_ODT_0
14	BC36	DDR_A_MA_0
15	BA27	DDR_A_MA_9
16	BB30	DDR_A_MA_2
17	BB29	DDR_A_MA_3
18	BA29	DDR_A_MA_4
19	AV35	DDR_A_CKB_2
20	AT34	DDR_A_CK_2
21	AT33	DDR_A_CK_0

**Table 37. XOR Chain 5**

Pin Count	Ball #	Chain 5
	AM14	RSVD
1	AA44	DDR_A_QOSB_7
2	AB40	DDR_A_DM_7
3	AD42	DDR_A_QOSB_6
4	AE44	DDR_A_DM_6
5	AL36	DDR_A_QOSB_8
6	AM42	DDR_A_QOSB_5
7	AN44	DDR_A_DM_5
8	AT42	DDR_A_QOSB_4
9	AU44	DDR_A_DM_4
10	BA42	DDR_A_MA_13
11	BB41	DDR_A_CASB
12	BD39	DDR_A_WEB





**Table 37. XOR Chain 5**

Pin Count	Ball #	Chain 5
13	BB36	DDR_A_BS_1
14	BB38	DDR_A_RASB
15	BC37	DDR_A_BS_0
16	BA25	DDR_A_MA_14
17	BD27	DDR_A_MA_11
18	BB26	DDR_A_BS_2
19	BB27	DDR_A_MA_12
20	AK15	CL_DATA
21	AK14	CL_CLK

**Table 38. XOR Chain 6**

Pin Count	Ball #	Chain 6
22	AN41	DDR_A_DQ_40
23	AN42	DDR_A_DQ_41
24	AP42	DDR_A_DQ_44
25	AL41	DDR_A_DQ_47
26	AP45	DDR_A_DQ_45
27	AL42	DDR_A_DQ_43
28	AL44	DDR_A_DQ_42
29	AT43	DDR_A_DQS_4
30	AU43	DDR_A_DQ_33
31	AU41	DDR_A_DQ_37
32	AV42	DDR_A_DQ_32
33	AR41	DDR_A_DQ_38
34	AR40	DDR_A_DQ_39
35	AR44	DDR_A_DQ_34
36	AW42	DDR_A_DQ_36
37	AR42	DDR_A_DQ_35
38	AT21	DDR_A_DQS_3
39	AY21	DDR_A_DQ_25
40	AW19	DDR_A_DQ_29
41	AN21	DDR_A_DQ_30
42	AW22	DDR_A_DQ_31
43	AT22	DDR_A_DQ_27
44	AN22	DDR_A_DQ_26
45	AN19	DDR_A_DQ_24
46	AV19	DDR_A_DQ_28
47	BA15	DDR_A_DQS_2
48	BB16	DDR_A_DQ_18
49	BD15	DDR_A_DQ_22
50	BE16	DDR_A_DQ_19
51	BB14	DDR_A_DQ_17
52	BB15	DDR_A_DQ_23
53	BA13	DDR_A_DQ_20
54	BD13	DDR_A_DQ_16
55	BB13	DDR_A_DQ_21
56	BA11	DDR_A_DQS_1
57	BC9	DDR_A_DQ_13
58	BD11	DDR_A_DQ_14

**Table 38. XOR Chain 6**

Pin Count	Ball #	Chain 6
	F21	BSEL1
1	AA42	DDR_A_DQS_7
2	Y42	DDR_A_DQ_58
3	AA41	DDR_A_DQ_62
4	AB42	DDR_A_DQ_56
5	AB43	DDR_A_DQ_57
6	W42	DDR_A_DQ_59
7	AC40	DDR_A_DQ_60
8	Y45	DDR_A_DQ_63
9	AB39	DDR_A_DQ_61
10	AD43	DDR_A_DQS_6
11	AC42	DDR_A_DQ_50
12	AC39	DDR_A_DQ_55
13	AE41	DDR_A_DQ_48
14	AD40	DDR_A_DQ_54
15	AC45	DDR_A_DQ_51
16	AF42	DDR_A_DQ_52
17	AF45	DDR_A_DQ_53
18	AE42	DDR_A_DQ_49
19	AL38	DDR_A_DQS_8
20	AM43	DDR_A_DQS_5
21	AL40	DDR_A_DQ_46

**Table 38. XOR Chain 6**

Pin Count	Ball #	Chain 6
59	BB11	DDR_A_DQ_15
60	BE12	DDR_A_DQ_11
61	BD9	DDR_A_DQ_8
62	BA9	DDR_A_DQ_12
63	BB12	DDR_A_DQ_10
64	BB10	DDR_A_DQ_9
65	BA6	DDR_A_DQS_0
66	BB7	DDR_A_DQ_7
67	BB8	DDR_A_DQ_2
68	BE8	DDR_A_DQ_3
69	BD7	DDR_A_DQ_6
70	BD4	DDR_A_DQ_1
71	BC4	DDR_A_DQ_0
72	BB4	DDR_A_DQ_5
73	BD3	DDR_A_DQ_4

**Table 39. XOR Chain 7**

Pin Count	Ball #	Chain 7
	F18	BSEL2
1	AW44	DDR_A_ODT_3
2	AY43	DDR_A_CSB_3
3	BA41	DDR_A_ODT_2
4	BB39	DDR_A_CSB_2
5	AV31	DDR_A_CK_3
6	AT31	DDR_A_CKB_3
7	AT36	DDR_A_CKB_5
8	AT35	DDR_A_CK_5
9	AN27	DDR_A_CK_4
10	AM27	DDR_A_CKB_4
11	BC24	DDR_A_CKE_3
12	BB25	DDR_A_CKE_2

**Table 40. XOR Chain 8**

Pin Count	Ball #	Chain 8
	AN13	RSVD
1	AG42	DDR_B_CB_2
2	AG44	DDR_B_CB_7
3	AG41	DDR_B_CB_6
4	AK45	DDR_B_CB_0
5	AJ42	DDR_B_CB_4
6	AG40	DDR_B_CB_3
7	AJ44	DDR_B_CB_1
8	AK42	DDR_B_CB_5
9	BB34	DDR_B_ODT_1
10	BD33	DDR_B_ODT_0
11	BB35	DDR_B_CSB_1
12	BA31	DDR_B_CSB_0
13	AV30	DDR_B_CKB_0
14	AW30	DDR_B_CK_0
15	AW33	DDR_B_CKB_2
16	AR28	DDR_B_CK_1
17	AP28	DDR_B_CKB_1
18	AV33	DDR_B_CK_2
19	BB21	DDR_B_MA_5
20	BB22	DDR_B_MA_2
21	BD21	DDR_B_MA_4
22	BC22	DDR_B_MA_1
23	AW24	DDR_B_MA_10
24	BB20	DDR_B_MA_6
25	BB19	DDR_B_MA_9
26	BE20	DDR_B_MA_8
27	BA21	DDR_B_MA_3
28	AY19	DDR_B_MA_7
29	BD17	DDR_B_CKE_0
30	AY22	DDR_B_MA_0
31	BD19	DDR_B_CKE_1
32	AR24	DDR_B_DQSB_3
33	AY25	DDR_B_DM_3
34	AP16	DDR_B_DQSB_2



**Table 40. XOR Chain 8**

Pin Count	Ball #	Chain 8
35	AW16	DDR_B_DM_2
36	AR12	DDR_B_DQSB_1
37	AT13	DDR_B_DM_1
38	AT10	DDR_B_DQSB_0
39	AY8	DDR_B_DM_0

**Table 41. XOR Chain 9**

Pin Count	Ball #	Chain 9
	AP12	RSVD
1	AD33	DDR_B_DQSB_7
2	AD35	DDR_B_DM_7
3	AG38	DDR_B_DQSB_6
4	AG35	DDR_B_DM_6
5	AH42	DDR_B_DQSB_8
6	AP40	DDR_B_DQSB_5
7	AN36	DDR_B_DM_5
8	AV38	DDR_B_DQSB_4
9	AY40	DDR_B_DM_4
10	BA33	DDR_B_MA_13
11	BD31	DDR_B_RASB
12	BB32	DDR_B_CASB
13	AY31	DDR_B_WEB
14	AY18	DDR_B_MA_12
15	BA19	DDR_B_MA_11
16	BC18	DDR_B_MA_14
17	BB18	DDR_B_BS_2
18	BB24	DDR_B_BS_0
19	AW23	DDR_B_BS_1

**Table 42. XOR Chain 10**

Pin Count	Ball #	Chain 10
	K19	EXP_SLR
1	AC33	DDR_B_DQS_7
2	AC36	DDR_B_DQ_62
3	AB32	DDR_B_DQ_58
4	AB38	DDR_B_DQ_59
5	AE34	DDR_B_DQ_61
6	AD36	DDR_B_DQ_57
7	AE35	DDR_B_DQ_60
8	AD39	DDR_B_DQ_56
9	AC34	DDR_B_DQ_63
10	AG39	DDR_B_DQS_6
11	AE38	DDR_B_DQ_51
12	AE33	DDR_B_DQ_55
13	AE39	DDR_B_DQ_50
14	AH33	DDR_B_DQ_52
15	AH34	DDR_B_DQ_48
16	AH36	DDR_B_DQ_53
17	AG33	DDR_B_DQ_49
18	AE40	DDR_B_DQ_54
19	AH43	DDR_B_DQS_8
20	AP39	DDR_B_DQS_5
21	AP35	DDR_B_DQ_42
22	AN39	DDR_B_DQ_46
23	AP36	DDR_B_DQ_41
24	AV36	DDR_B_DQ_44
25	AR34	DDR_B_DQ_45
26	AN40	DDR_B_DQ_47
27	AR36	DDR_B_DQ_40
28	AN33	DDR_B_DQ_43
29	AW39	DDR_B_DQS_4
30	AV39	DDR_B_DQ_38
31	AT40	DDR_B_DQ_35
32	AT38	DDR_B_DQ_34
33	AV40	DDR_B_DQ_39
34	AY39	DDR_B_DQ_32



**Table 42. XOR Chain 10**

Pin Count	Ball #	Chain 10
35	AW38	DDR_B_DQ_33
36	AW36	DDR_B_DQ_37
37	AY38	DDR_B_DQ_36
38	AR25	DDR_B_DQS_3
39	AV27	DDR_B_DQ_27
40	AP27	DDR_B_DQ_31
41	AT25	DDR_B_DQ_30
42	AT27	DDR_B_DQ_26
43	AW25	DDR_B_DQ_24
44	AP24	DDR_B_DQ_29
45	AN24	DDR_B_DQ_28
46	AV25	DDR_B_DQ_25
47	AN18	DDR_B_DQS_2
48	AT19	DDR_B_DQ_19
49	AP19	DDR_B_DQ_18
50	AN16	DDR_B_DQ_20
51	AT18	DDR_B_DQ_22
52	AR18	DDR_B_DQ_23
53	AV16	DDR_B_DQ_17
54	AR16	DDR_B_DQ_21
55	AY16	DDR_B_DQ_16
56	AR13	DDR_B_DQS_1
57	AV15	DDR_B_DQ_11
58	AT15	DDR_B_DQ_10
59	AW13	DDR_B_DQ_13
60	AN15	DDR_B_DQ_14
61	AY13	DDR_B_DQ_9
62	AW12	DDR_B_DQ_12
63	AP15	DDR_B_DQ_15
64	AY12	DDR_B_DQ_8
65	AW10	DDR_B_DQS_0
66	AW8	DDR_B_DQ_0
67	AT11	DDR_B_DQ_2
68	AW11	DDR_B_DQ_7
69	AY7	DDR_B_DQ_1
70	AW6	DDR_B_DQ_5

**Table 42. XOR Chain 10**

Pin Count	Ball #	Chain 10
71	AR11	DDR_B_DQ_6
72	AT12	DDR_B_DQ_3
73	AV8	DDR_B_DQ_4

**Table 43. XOR Chain 11**

Pin Count	Ball #	Chain 11
	L18	RSVD
1	AY35	DDR_B_ODT_3
2	BA35	DDR_B_CSB_3
3	BB33	DDR_B_ODT_2
4	BC32	DDR_B_CSB_2
5	AY34	DDR_B_CKB_5
6	AW34	DDR_B_CK_5
7	AY28	DDR_B_CKB_4
8	AY30	DDR_B_CK_4
9	AP31	DDR_B_CKB_3
10	AR31	DDR_B_CK_3
11	BA17	DDR_B_CKE_3
12	BB17	DDR_B_CKE_2

**Table 44. XOR Chain 12**

Pin Count	Ball #	Chain 12
	M22	BSELO
1	V10	DMI_TXP_3
2	V11	DMI_TXN_3
3	V7	DMI_RXP_3
4	V6	DMI_RXN_3
5	R2	DMI_TXP_2
6	T1	DMI_TXN_2
7	P4	DMI_RXP_2
8	R5	DMI_RXN_2
9	N2	DMI_TXP_1



**Table 44. XOR Chain 12**

Pin Count	Ball #	Chain 12
10	P3	DMI_TXN_1
11	T7	DMI_RXP_1
12	T8	DMI_RXN_1
13	R7	DMI_TXP_0
14	R6	DMI_TXN_0
15	N5	DMI_RXP_0
16	M4	DMI_RXN_0

**Table 45. XOR Chain 13**

Pin Count	Ball #	Chain 13
24	H13	PEG_RXP_2
25	D14	PEG_TXN_1
26	E15	PEG_TXP_1
27	C14	PEG_RXN_1
28	B13	PEG_RXP_1
29	E17	PEG_TXN_0
30	D16	PEG_TXP_0
31	B15	PEG_RXN_0
32	A16	PEG_RXP_0
33	L2	PEG_TXN_15
34	M1	PEG_TXP_15
35	N10	PEG_RXN_15
36	N8	PEG_RXP_15
37	K4	PEG_TXN_14
38	L5	PEG_TXP_14
39	J2	PEG_RXN_14
40	K3	PEG_RXP_14
41	H4	PEG_TXN_13
42	J5	PEG_TXP_13
43	M8	PEG_RXN_13
44	M7	PEG_RXP_13
45	G2	PEG_TXN_12
46	H1	PEG_TXP_12
47	L10	PEG_RXN_12
48	M11	PEG_RXP_12
49	E4	PEG_TXN_11
50	F5	PEG_TXP_11
51	K8	PEG_RXN_11
52	K7	PEG_RXP_11
53	D3	PEG_TXN_10
54	F3	PEG_TXP_10
55	C2	PEG_RXN_10
56	D2	PEG_RXP_10
57	B4	PEG_TXN_9
58	B3	PEG_TXP_9
59	G6	PEG_RXN_9
60	F7	PEG_RXP_9

**Table 45. XOR Chain 13**

Pin Count	Ball #	Chain 13
	H21	RSVD
1	A8	PEG_TXN_7
2	B7	PEG_TXP_7
3	H10	PEG_RXN_7
4	G10	PEG_RXP_7
5	E9	PEG_TXN_6
6	D8	PEG_TXP_6
7	L12	PEG_RXN_6
8	K11	PEG_RXP_6
9	C10	PEG_TXN_5
10	B9	PEG_TXP_5
11	G12	PEG_RXN_5
12	H12	PEG_RXP_5
13	E11	PEG_TXN_4
14	D10	PEG_TXP_4
15	M13	PEG_RXN_4
16	N13	PEG_RXP_4
17	A12	PEG_TXN_3
18	B11	PEG_TXP_3
19	K13	PEG_RXN_3
20	L13	PEG_RXP_3
21	D12	PEG_TXN_2
22	E13	PEG_TXP_2
23	G13	PEG_RXN_2



**Table 45. XOR Chain 13**

Pin Count	Ball #	Chain 13
61	C4	PEG_TXN_8
62	C6	PEG_TXP_8
63	D5	PEG_RXN_8
64	E6	PEG_RXP_8

**Table 46. XOR Chain 14**

Pin Count	Ball #	Chain 14
30	AB3	PEG2_TXP_0
31	AA13	PEG2_RXN_0
32	W12	PEG2_RXP_0
33	AP6	PEG2_TXN_15
34	AP7	PEG2_TXP_15
35	AP11	PEG2_RXN_15
36	AP10	PEG2_RXP_15
37	AT3	PEG2_TXN_14
38	AU2	PEG2_TXP_14
39	AL7	PEG2_RXN_14
40	AL6	PEG2_RXP_14
41	AR5	PEG2_TXN_13
42	AT4	PEG2_TXP_13
43	AL10	PEG2_RXN_13
44	AL11	PEG2_RXP_13
45	AP1	PEG2_TXN_12
46	AR2	PEG2_TXP_12
47	AK13	PEG2_RXN_12
48	AK12	PEG2_RXP_12
49	AN5	PEG2_TXN_11
50	AP4	PEG2_TXP_11
51	AH6	PEG2_RXN_11
52	AH7	PEG2_RXP_11
53	AM3	PEG2_TXN_10
54	AN2	PEG2_TXP_10
55	AH10	PEG2_RXN_10
56	AH11	PEG2_RXP_10
57	AL5	PEG2_TXN_9
58	AM4	PEG2_TXP_9
59	AH13	PEG2_RXN_9
60	AG12	PEG2_RXP_9
61	AK1	PEG2_TXN_8
62	AL2	PEG2_TXP_8
63	AE6	PEG2_RXN_8
64	AE7	PEG2_RXP_8

**Table 46. XOR Chain 14**

Pin Count	Ball #	Chain 14
	G22	RSVD
1	AJ5	PEG2_TXN_7
2	AK4	PEG2_TXP_7
3	AE11	PEG2_RXN_7
4	AE10	PEG2_RXP_7
5	AH3	PEG2_TXN_6
6	AJ2	PEG2_TXP_6
7	AD12	PEG2_RXN_6
8	AE13	PEG2_RXP_6
9	AG5	PEG2_TXN_5
10	AH4	PEG2_TXP_5
11	AC7	PEG2_RXN_5
12	AC6	PEG2_RXP_5
13	AF1	PEG2_TXN_4
14	AG2	PEG2_TXP_4
15	AC10	PEG2_RXN_4
16	AC11	PEG2_RXP_4
17	AE5	PEG2_TXN_3
18	AF4	PEG2_TXP_3
19	AB12	PEG2_RXN_3
20	AC13	PEG2_RXP_3
21	AD3	PEG2_TXN_2
22	AE2	PEG2_TXP_2
23	AA7	PEG2_RXN_2
24	AA6	PEG2_RXP_2
25	AC4	PEG2_TXN_1
26	AD4	PEG2_TXP_1
27	AA11	PEG2_RXN_1
28	AA10	PEG2_RXP_1
29	AB1	PEG2_TXN_0

§ §